

CPF9IPR

| | |
|---|-----------------|
| Produktkategorie Standherd | 90x60 cm |
| Zahl der Garräume mit Energielabel | 1 |
| Wärmequelle pro Garraum | Strom |
| Heiztechnik der Kochmulde | Induktion |
| Typ Garraum 1 | Umluft/Heißluft |
| Reinigungssystem Garraum | Pyrolyse |
| EAN-Code | 8017709232283 |
| Energieeffizienzklasse Garraum 1 (auf einer Skala von A+++ bis D) | A+ |













Design

| | | | |
|---------------------------------|-----------------|---------------------------|------------------|
| Design | Portofino | Anzahl der Bedienknebel | 7 |
| Farbe | Rot | Farbe des Dekors | Schwarz |
| Design | Integrierbar | Türgriff | Portofino |
| Gerätetür | Mit Rahmen | Material des Türgriffs | Lackiert |
| Spritzleiste | Ja | Glasart | Grau |
| Farbe der Kochmulde | Edelstahl | Stellfüße | Schwarz |
| Bedienoberfläche | Metall lackiert | Gerätesockel | Schwarz |
| Bedienknebel | Portofino | Staufach im Sockelbereich | Push-Pull |
| Farbe/Material der Bedienknebel | Metall | Markenlogo | Edelstahlprägung |
| Display | LCD | Position des Markenlogos | Zierblende |

Programme / Funktionen

| | |
|-------------------------------------|----|
| Anzahl der Garfunktionen, Garraum 1 | 10 |
|-------------------------------------|----|

Art der Garfunktionen, Garraum 1

- | | | |
|--|---|---|
|  Statisch |  Ober-/Unterhitze+Umluft |  Heißluft |
|  Turbo-Heißluft |  ECO |  Großflächengrill |
|  Großflächengrill + Umluft |  Unterhitze |  Unterhitze + Umluft |
|  Drehspieß | | |

Reinigungsfunktion, Garraum 1

- | | |
|---|--|
|  Pyrolyse |  ECO-Pyrolyse |
|---|--|

Automatikprogramme 20

Sonderfunktionen Garraum 1

- | | | |
|---|---|---|
|  Auftauen nach Zeit |  Auftauen nach Gewicht |  Hefestufe |
|  Sabbath | | |

Technische Eigenschaften Kochfeld



Anzahl der Kochzonen 5

- Vorne links - Induktion - 1.40 kW - Booster 2.20 kW - Ø 14.5 cm
- Hinten links - Induktion - 1.85 kW - Booster 3.00 kW - Ø 18.0 cm
- Mitte - Induktion - 2.60 kW - Booster 3.70 kW - Ø 27.0 cm
- Hinten rechts - Induktion - 2.30 kW - Booster 3.70 kW - Ø 21.0 cm
- Vorne rechts - Induktion - 1.40 kW - Booster 2.20 kW - Ø 14.5 cm

| | | | |
|--|----|-----------------------------|----|
| Überhitzungsschutz | Ja | Anzeige der Kochzone | Ja |
| Automatische Anpassung des Topfdurchmessers | Ja | Restwärmeanzeige | Ja |
| Dekor für min. Topfgröße | Ja | | |

Technische Eigenschaften primärer Garraum 1



| | | | |
|--|-------------------------|--|-----------------|
| Anzahl der Garraumbeleuchtungen | 4 | Anzahl der Türverglasungen | 4 |
| Anzahl der Ventilatoren (Umluft/Heißluft) | 3 | Anzahl der Thermo-Türverglasungen | 3 |
| Nutzbare Garraumvolumen | 115 l | Sicherheitsthermostat | Ja |
| Bruttovolumen Garraum | 129 l | Sicherheitsabschaltung der Beheizung bei Türöffnung | Ja |
| Material des Garraums | Ever Clean Emaillierung | Kühlsystem | Querstromlüfter |

| | | | |
|-----------------------------------|-----------------------------------|--------------------------------------|----------------|
| Anzahl der Garebenen | 5 | Türverriegelung bei Pyrolyse | Ja |
| Art der Einschubschienen | Verchromt | Nutzabmessungen des Garraums (HxBxT) | 371x724x418 mm |
| Art der Beleuchtung | Halogen | Temperaturregelung | Elektronisch |
| Leistung der Beleuchtung | 40 W | Leistung der Unterhitze | 1700 W |
| Programmierung der Garzeit | Start Gardauer mit Endabschaltung | Leistung der Oberhitze | 1200 W |
| Garraumbeleuchtung bei Türöffnung | Ja | Leistung des Kleinflächengrills | 1700 W |
| Art der Türöffnung | Klapptür | Leistung des Großflächengrills | 2900 W |
| Abnehmbare Gerätetür | Ja | Leistung der Heißluft | 1850 W |
| Vollglasinnentür | Ja | Art des Grills | Elektrisch |
| Vollglasinnentür herausnehmbar | Ja | Soft-Close Komfort-Schließsystem | Ja |

Optionen primärer Garraum 1

| | | | |
|------------------------------------|----|-----------------|--------|
| Kurzzeitwecker | Ja | Temperatur min. | 50 °C |
| Akustisches Signal bei Garzeitende | Ja | Temperatur max. | 260 °C |

Serienzubehör primärer Garraum 1 und Kochfeld



| | | | |
|---|---|---------------------------------|---|
| Drehspieß | 1 | Backblech/Fettpfanne (H: 40 mm) | 2 |
| Grillrost mit Tiefensperre und Auszugsstopp | 2 | Teleskop-Teilauszug, 1 Ebene | 1 |
| Auflagerost | 1 | | |

Elektrischer Anschluss

| | | | |
|----------------------------------|-----------|-----------------|----------|
| Elektrischer Gesamtanschlusswert | 11400 W | Frequenz | 50/60 Hz |
| Absicherung | 50 A | Prüfkabel | Ja |
| Spannung | 220-240 V | Anschlussleiste | 5-polig |
| Spannung 2 | 380-415 V | | |

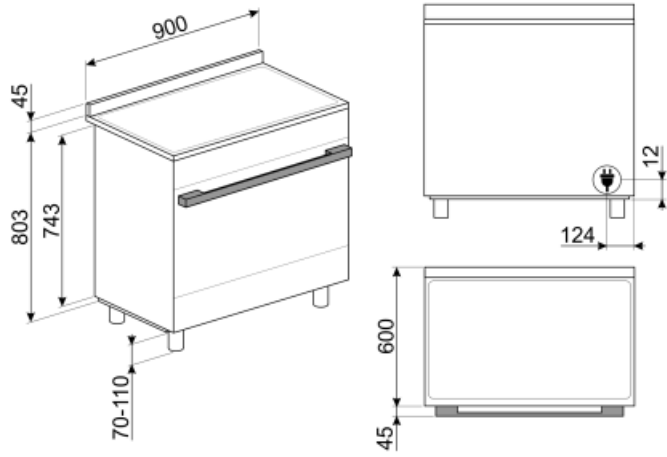

Not included accessories



PAL2

Doppel-Pizzaschieber aus Edelstahl, feste Holzgriffe, kompatibel für: 90 cm Elektro-Backöfen und Pizzastein PPR9.



KITH95CPF9

Height extension kit (950 mm), suitable for Portofino cookers



SFLK1

Child lock



PRTX

Pizzastein aus Schamottstein, glasiert, Ø 35 cm, Mettaleinfassung mit 2 Griffen, kompatibel für: 60 cm emailierte Elektro-Backöfen mit Rundprägung des Backraumbodens.



PPR2

Pizzastein aus Schamottstein, glasiert, LxBxH: 420 x 375 x 18 mm, kompatibel für: emailierte 60 cm Elektro-Backöfen mit und ohne Rundprägung des Backraumbodens.



SCRP

Induction and ceramic hobs and teppanyaki scraper



KITPD

Height extension black feet (950 mm) for cookers



KITC9X9-1

Edelstahlrückwand BxHxT: 896 x 750 x 42 mm, für 90 cm Standherde und Kochzentren, kombinierbar mit allen 90 cm Classici und Portofino Modellen

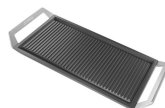

GRIDDLE

Universal-Barbecue-Grillplatte aus Gusseisen, geeignet für alle Gas, Glaskeramik-/Elektro Kochfelder und Induktions-Kochfelder mit Brückenfunktion (Multizone oder Flexi4Zone), LxB: 517x240 mm



GT1T-2

Teleskop-Vollauszug, 1 Ebene, Edelstahl, kompatibel für alle 45-90 cm Backöfen ohne Dampffunktion und 120 cm Kochzentren mit Doppelbacköfen



GTP

Height reduction feet (850 mm)



PPR9

Pizzastein aus Schamottstein, glasiert, L x B x H: 64 x 37,5 x 2,3 cm, kompatibel für: emailierte 90cm Elektro-Backöfen mit ovaler Prägung des Backraumbodens.



KITPBX

Height reduction feet (850 mm)



TPK

Teppanyaki Edelstahl-Grillplatte, Aluminiumkern mit Edelstahlmantelung mit 10 Mal höherer Wärmeleitfähigkeit, geeignet für alle Induktionskochfelder



GT1P-2



PALPZ

Pizzaschieber aus Edelstahl, klappbarer Griff, kompatibel für: 60 cm ElektroBacköfen und Pizzasteine PPR2, PRTX.



KITPAX

High extension feet, stainless steel, (950mm) suitable for Master, Sinfonia and Portofino (90cm) cookers; (900mm) suitable for Concerto cookers with 850mm height

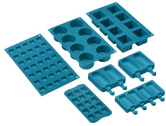

SMOLD











Set aus 7 Silikonformen für Eiscreme, Stieleis, Pralinen, Eiswürfel (Blast-Chiller) und das Vorportionieren von Gerichten. Temperaturbeständig von -60°C bis +230°C (Backöfen)





















GTT

Totally extractable telescopic guides (1 level) Extraction: 433 mm
Material: Stainless steel AISI 430 polished

Symbols glossary (TT)

-  A+: Energy efficiency class A+ helps to save up to 10% energy compared to class A. Maximum performance with minimum consumption is guaranteed.
-  Defrost by time: Manual defrost function. At the end of the set duration, the function stops.
-  Quadruple glazed: Number of glazed doors.
-  Defrost by weight: Automatic defrost function. You choose the type of food to defrost from the available categories (MEAT - FISH - BREAD - DESSERTS) After entering the weight of the food, the oven automatically defines the time required for proper defrosting.
-  Ever Clean Enamel: Ever Clean enamel is applied electrostatically, corner to corner and edge to edge to prevent cracking or cracks over time. It is a particular pyrolytic enamel, resistant to acids which, in addition to being pleasantly bright, promotes greater cleaning of the oven walls, thanks to its lower porosity. It is baked at over 850 ° C and slowly polymerized at a scientifically determined rate to ensure uniform depth and strength Ever Clean enamel creates an impeccable finish both on the inside of the oven and on the trays, making the surfaces of the oven incredibly easy to maintain over time as it reduces the adhesion of fat during cooking
-  Fan assisted base: the mix of fan and lower heating element alone allows to finish cooking foods already cooked on the surface but not internally more quickly. This system is recommended to finish cooking foods that are already well cooked on the surface, but not internally, which therefore require a moderate higher heat. Ideal for any type of food.
-  Fan assisted: Intense and homogeneous traditional cooking, also suitable for complex recipes. The fan is active and the heat comes from below and from above at the same time. Ventilated cooking ensures a faster and more homogeneous result, leaving fragrant foods outside and moister inside. Ideal for baked pasta, biscuits, roasts and cobblers.
-  Static: Traditional cooking suitable for the preparation of one dish at a time. The fan is not active and the heat comes from below and from above at the same time. Static cooking is slower and more delicate, ideal in order to get well cooked and dry dishes even inside. Ideal for cooking all types of roasts, fatty meats, bread, filled cakes.
-  Base: the heat comes only from the bottom of the cavity. The fan is not active. Ideal for sweet and savory pies, cobblers and pizzas. Designed to complete cooking and make food more crunchy This symbol in gas ovens indicates the gas burner.
-  Circulaire: it is the perfect function for cooking all types of dishes in a more delicate way. The heat comes from the back of the oven and is distributed quickly and evenly The fan is active. It is also ideal for cooking on multiple levels without mixing smells and flavors.
- ECO: low energy consumption cooking: this function is particularly suitable for cooking on a single shelf with low energy consumption. It is recommended for all types of food except those that can generate a lot of moisture (for example vegetables). To achieve maximum energy savings and reduce time, it is recommended to put the food in the oven without preheating the cooking compartment

- | | |
|--|--|
|  <p>Grill: Very intense heat coming only from above from a double heating element. The fan is not active. Provides excellent grilling and gratinating results. Used at the end of cooking, it gives a uniform browning to dishes.</p> |  <p>Fan grill: very intense heat coming only from above from a double heating element The fan is active. It allows the optimal grilling of thickest meats. Ideal for large cuts of meat.</p> |
|  <p>Rotisserie: The rotisserie (where installed) works in combination with the grill element to brown foods to perfection.</p> |  <p>Turbo: the heat comes from 3 directions: above, below and from the back of the oven The fan is active. It allows quick cooking, even on several shelves without mixing the aromas. Ideal for large volumes or foods that require intense cooking.</p> |
|  <p>Overheat protection: The safety system that automatically turns off the hob in case of overheating of the control unit.</p> |  <p>Induction: The work of these hobs is based on the principle of electromagnetic induction. The heat is generated directly in the bottom of the pan during its contact with the hob.</p> |
|  <p>All glass inner door: All glass inner door, a single flat surface which is simple to keep clean.</p> |  <p>The inner door glass: can be removed with a few quick movements for cleaning.</p> |
|  <p>Side lights: Two opposing side lights increase visibility inside the oven.</p> |  <p>PYROLYSIS - AUTOMATIC CLEANING FUNCTION: the oven heats up to a temperature approaching 500 ° C and chars grease and food residues into a fine ash that can be easily wiped off with a damp cloth. At such a high temperature, the door locks automatically for safety, while the temperature of the door remains controlled so it is safe to touch User adjustable function based on the level of dirt present in the oven.</p> |
|  <p>Pyrolytic: The Eco pyrolytic cleaning function can be selected when the oven has a lighter build up of dirt. This function has a maximum duration of 1.5 hours.</p> |  <p>Air at 40°C provides the perfect environment for proving yeast type dough mixes. Simply select the function and place dough in the cavity for allotted</p> |
|  <p>Indication of residual heat: After the glass ceramic hob is switched off the residual heat indicator shows which of the heating zones still remains hot. When the temperature drops below 60 ° C, the indicator goes out.</p> |  <p>SABBATH: function that allows to cook food respecting Judaism's day of rest provisions.</p> |
|  <p>The oven cavity has 5 different cooking levels.</p> |  <p>Soft close: all models are equipped with advanced function of smooth closing of the door, which allows the device to close smoothly and quietly.</p> |
|  <p>Telescopic rails: allow you to pull out the dish and check it without having to remove it from the oven entirely.</p> |  <p>Electronic control: Allows you to maintain temperature inside the oven with the precision 2-3 ° C. This enables to cook meals that are very sensitive to temperature changes, such as cakes, souffles, puddings.</p> |
|  <p>The capacity indicates the amount of usable space in the oven cavity in litres.</p> | |