

CMS8451P



Produktkategorie	Kaffeevollautomat
Produkttyp	Automatisch
Produktkategorie	45 cm Kompaktgerät



Design



Farbe	Creme	Verzierung der Komponenten	Messing Antik
Design	Nostalgie	Markenlogo	Siebdruck









Bedienelemente



Display	LCD-Display weiß, schwarzer Hintergrund (2 Zeilen)	Bedienknebel	Nostalgie
Anzahl der Display-Sprachen	13	Farbe/ Ausführung der Bedienknebel	Messing-Antik
Display-Sprachen	IT, GB, FR, NL, SP, PT, SWE, RU, DE, CZ, DK, GR, PL	Anzahl der Tasten	8
Bedienungsart	Bedienknebel/Tasten	Ausführung der Bedientasten	Messing-Design
Anzahl der Bedienknebel	2	Weitere Bedienknebel/Tasten Serie	Cortina - Creme, Messing Antik

Programme / Funktionen

Anzahl der Heißgetränke	4
Funktion 1 Tasse Espresso/Kaffee	
Funktion 2 Tassen Espresso/Kaffee	
Vorheizfunktion	Ja
Automatische Cappuccino-Milchaufschäumung	Ja

Heißwasserfunktion für Tee und Heißgetränke	
Option Kaffeepulver	
Regelbare Kaffeestärke/Kaffeearoma	
Regelbare Wassermengen	
Regelbarer Cappuccino-Milchaufschäumer	
Programmuhr mit Auto-Start, Uhrzeitanzeige	
Automatische Spülfunktion	
Automatische Entkalkungsfunktion	
Regelbare Kaffeetemperaturen	2
Regelbare Mahlgradstufen	Ja
Wasserhärtegrad einstellbar	Ja
Wassermangelanzeige	Ja
Tastensperre/Kindersicherung	Ja

Technische Eigenschaften



Kaffeebohnenfach	Ja	Mahlwerk	Edelstahl-Kegelmahlwerk
Kaffeepulverfach	Ja	Pumpendruck	15 bar
Wasserbehälter herausnehmbar	Ja	Fassungsvermögen Wasserbehälter	1.80 l
Kaffeersatzbehälter herausnehmbar	Ja	Fassungsvermögen Kaffeebohnenfach	220 g
Kaffeeauslauf höhenverstellbar	Ja	Art der Beleuchtung	LED
Heißwasser-/Dampfdüse schwenkbar	Ja	Beleuchtungen	2
Restwasserschale	Ja	Art	Auf Teleskop-Vollauszug mit Soft-Close
Thermo-Milchkaraffe, herausnehmbar	Ja		

Elektrischer Anschluss

Netzstecker	(F;E) Schuko	Spannung	220-240 V
Elektrischer Gesamtanschlusswert	1350 W	Frequenz	50-60 Hz
Absicherung	5.6 A	Länge des Netzkabels	180 cm

Logistik-Informationen

Produktbreite	595 mm	Produkthöhe	455 mm
Produkttiefe	380 mm		

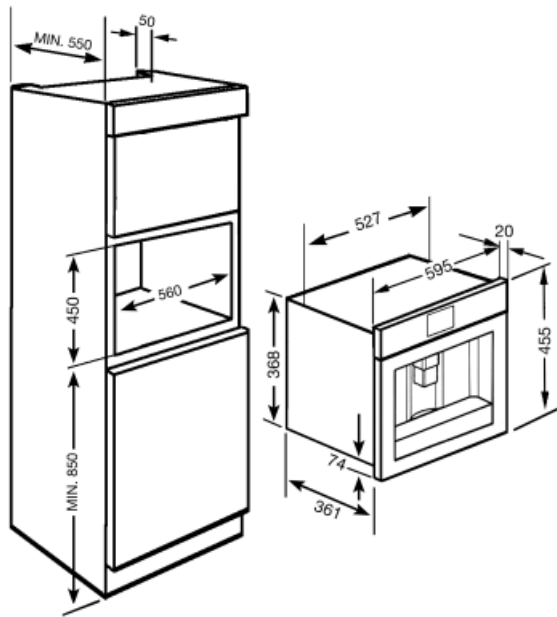

















Not included accessories

KITCABLE90UK

Netzkabel mit IEC-Stecksystem und UK-Netzstecker

Symbols glossary (TT)

 <p>Rinsing: There is an automatic rinsing with hot water when the coffee machine is switched on.</p>	 <p>Automatic switch on: It is possible to program automatic switch on of the machine to make it ready for use by the required time.</p>
 <p>Semiprofessional steamer with a dedicated heating element to manage the steam outlet. Suitable for recipes such as hot chocolate, punch, bombardino, vin brulé.</p>	 <p>Types of coffee: You can prepare the following types of coffee: Ristretto-Corto (small portion) / Normale (medium portion) / Lungo (large portion)</p>
 <p>Types of coffee: You can prepare the following types of coffee: Ristretto-Corto (small portion) / Normale (medium portion) / Lungo (large portion)</p>	 <p>The double coffee function makes possible to prepare two espresso at the same time with just one infusion cycle.</p>
 <p>Coffee beans: You can use coffee beans in the coffee machine with the possibility to adjust the coarseness of grind.</p>	 <p>Descaling function: Is essential to remove excess deposits of limestone in the tank and allow the proper operation of the product. The need to perform this operation is signaled by the product itself.</p>
 <p>LCD display: to optimize performance and simplify the use of the appliance.</p>	 <p>Conical stainless steel coffee grinder.</p>
 <p>Ground coffee: You can use ground coffee or coffee beans in the coffee machine with the possibility to adjust the coarseness of grind.</p>	 <p>Compact appliances with a height of 45 cm - perfect solution to meet the functional requirements of kitchen sets of small height. Available in several types and in different styles.</p>
 <p>Hot water: Coffee machine can make hot water for tea or other hot drinks</p>	 <p>5 levels adjustable coffee intensity. This function makes possible to adjust the quantity of beans grounded in any infusion cycle.</p>
 <p>Side lights: Two opposing side lights increase visibility inside the oven.</p>	 <p>The milk froth is adjustable through the thermal carafe knob.</p>