



 **FR**
DONNEZ
OU
RECYCLEZ

 OU  OU 
ASSOCIATION MAGASIN DÉCHÈTERIE

Adresses sur quefairedemesdechets.fr



LEGO.com/sustainable-packaging



BUILDER



Apple and the Apple logo are trademarks of Apple Inc., registered in the U.S. and other countries and regions. App Store is a service mark of Apple Inc. Google Play and the Google Play logo are trademarks of Google LLC. Tencent and the Tencent logo are trademarks of Tencent Inc.

Q [LEGO.com/devicecheck](https://www.lego.com/devicecheck)

EN Ask parents' permission before going online | **DE** Eltern um Erlaubnis bitten, bevor du online gehst | **FR** Demande l'autorisation d'un parent avant d'aller en ligne | **IT** Chiedi il permesso ai tuoi genitori prima di andare online | **ES** Pídeles permiso a tus papás antes de conectarte a Internet | **PT** pede autorização aos pais antes de acederes online | **JA** オンラインになる前に ほかの方のきょかをもらおう | **ZH** 上网前应先征得父母的同意 | **KO** 온라인 접속 전에 보호자 동의가 필요합니다 | **RU** Спроси разрешения у родителей, прежде чем заходить в интернет | **PL** Poprosz rodziców o zgodę, zanim wejdiesz do Internetu | **CS** Než půjdeš na internet, požádej rodiče o svolení | **SK** Skôr než pôjdeš na internet, vypýtaj si povolenie od rodičov | **HU** Kérj szülői engedélyt, mielőtt online csatlakoznál! | **RO** Cere permisiunea părinților înainte de a te conecta online | **BG** Поискайте разрешение от родител, преди да влезете онлайн | **LV** Pirms došanās tiešsaistē palūdz atļauju vecākiem | **ET** Enne Interneti kasutamist küsi vanematelt luba | **LT** Prieš prisijungdami prie interneto, atsiklauskite tėvų



1

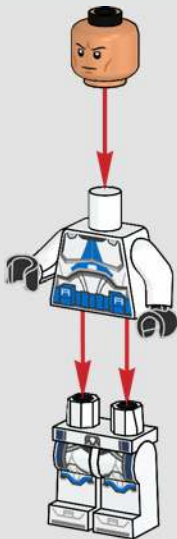

2

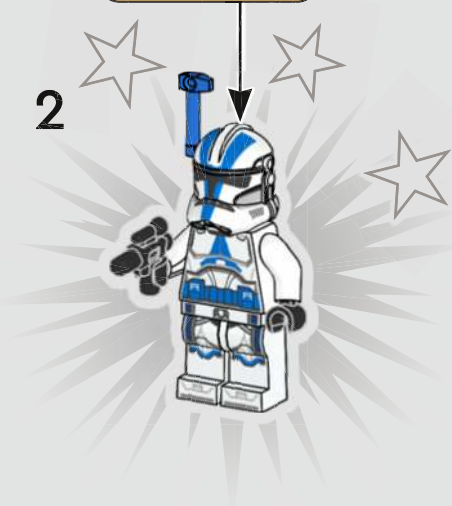
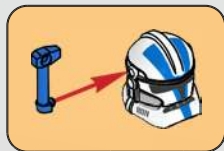

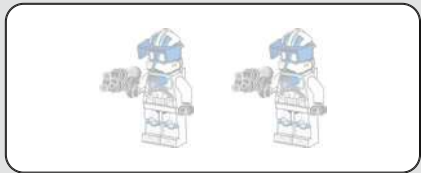

1

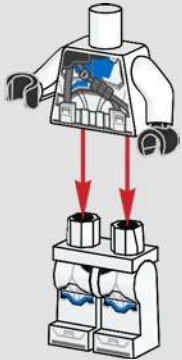

2

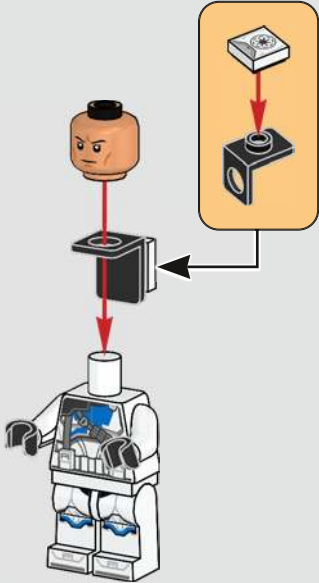

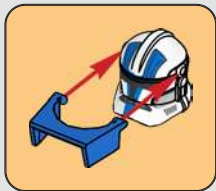

3

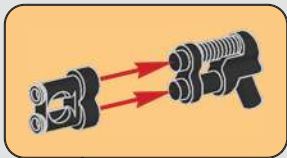
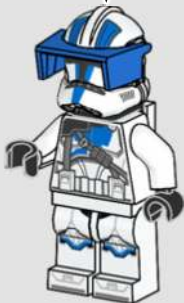

4

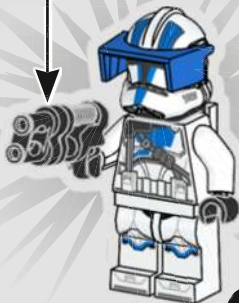

2x

1

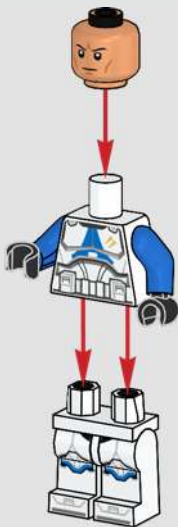

2

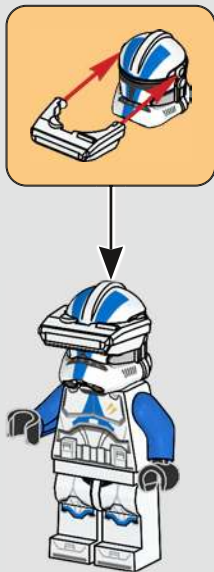

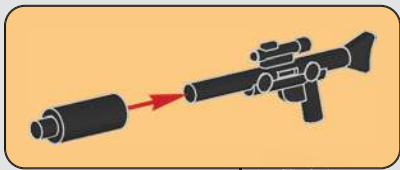

3

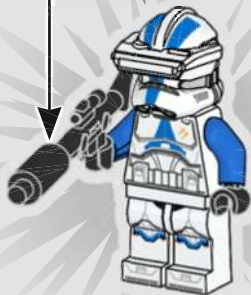



1x

1



10





1x

2

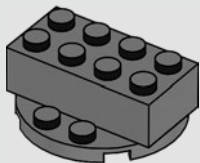



4X

3

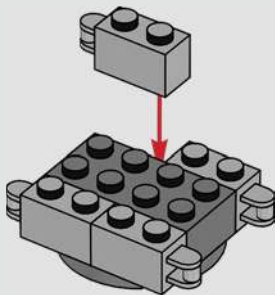



2x

4

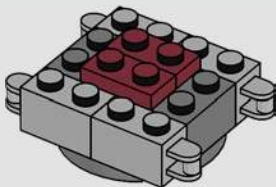



2x

5



2x

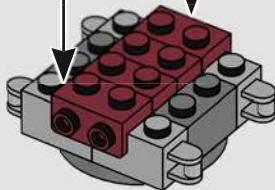



1x

6

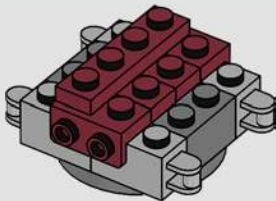



4x

7



4x

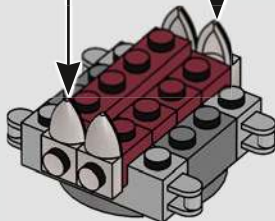



2x

8

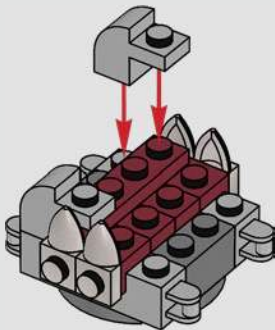



2x

9

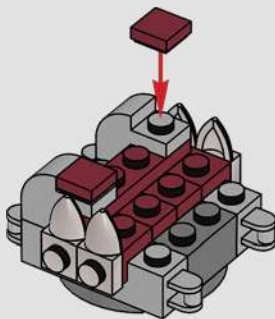

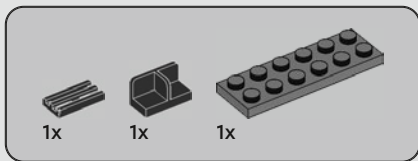

10

1

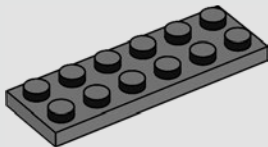

2

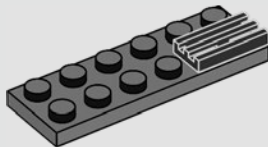

3

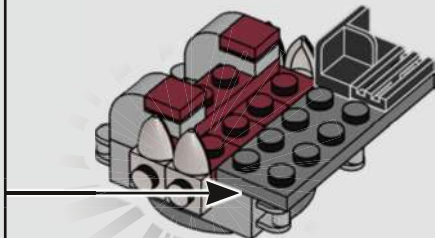
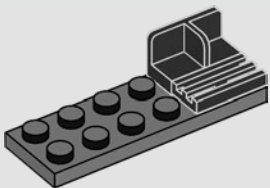

20





1x



1x

11

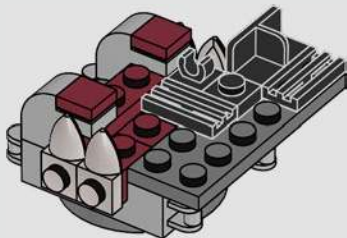



1x



1x

12

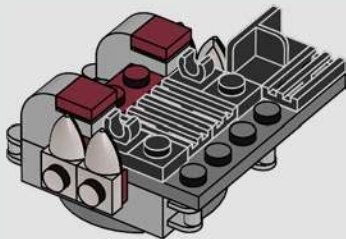



1x

13

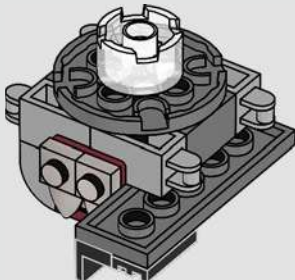



4x



2x



2x



2x



2x

14

1

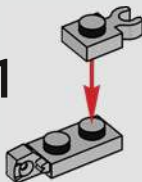

2

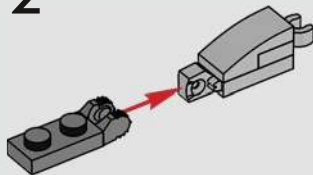

3

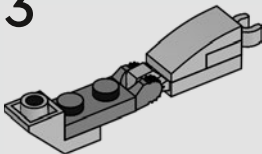

4

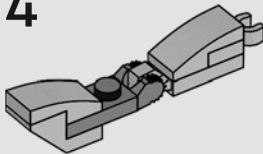

2x

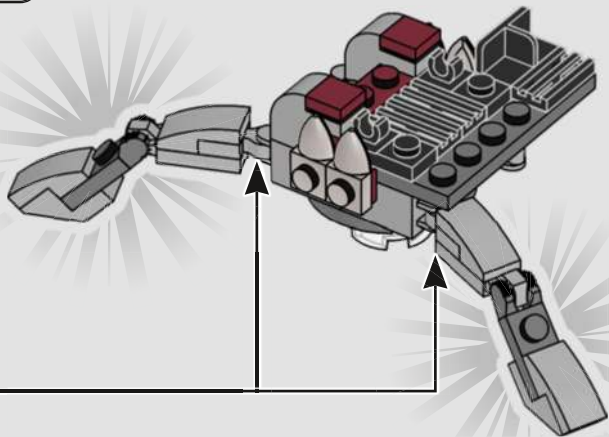

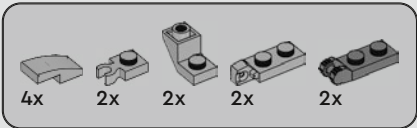

15

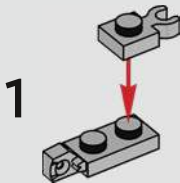

2

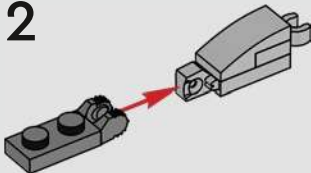

3

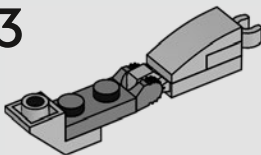

4

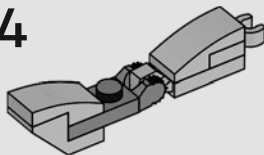

2x



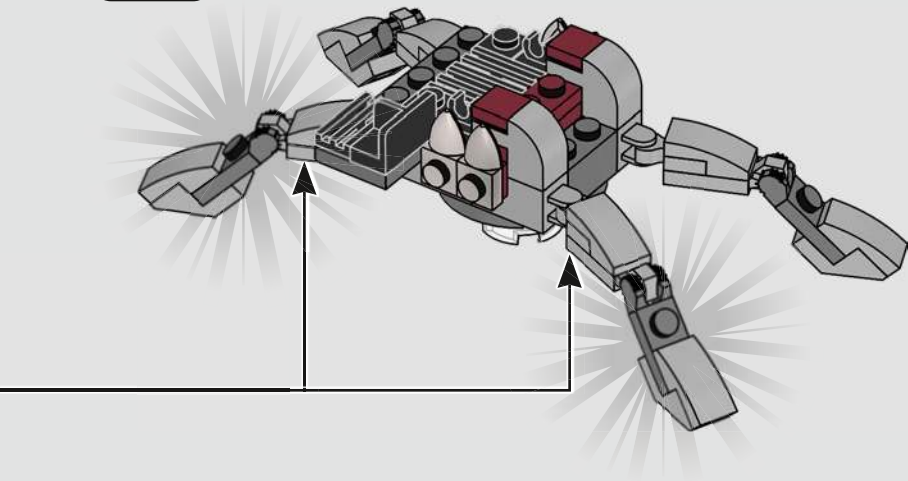



1x

16





1x

17

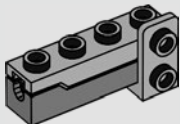



1x



1x

18

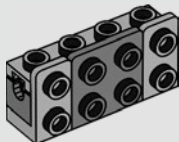



2x

19

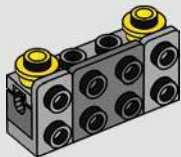



1x

20

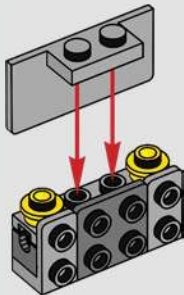



1x



2x

21

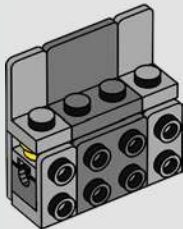



1x



1x

22

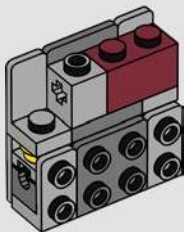



1x

23

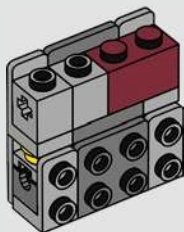



1x

24





1x

25





1x



1x

26

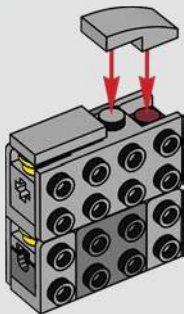



1x



1x

27





1x



1x

28





1x



1x

29

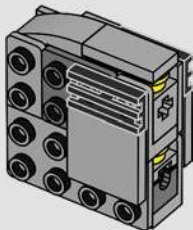



1x



1x

30

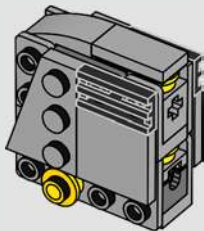



2x

31



2x



32

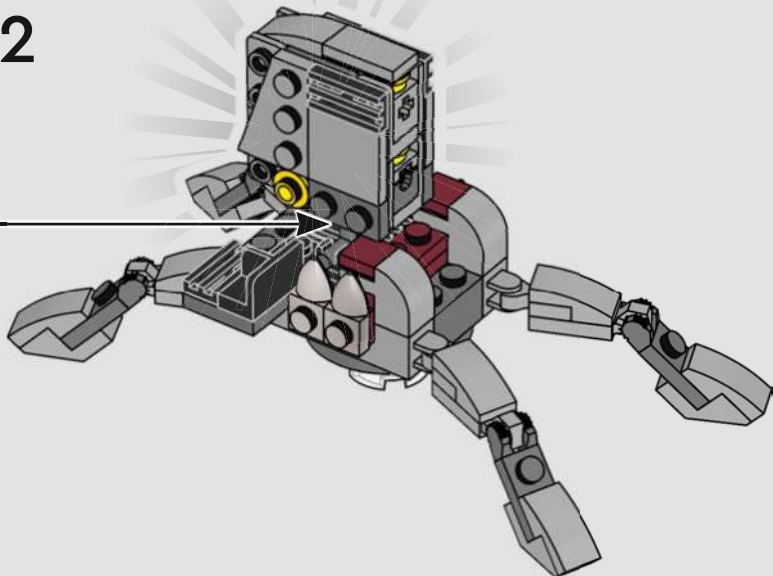



1x



1x

33

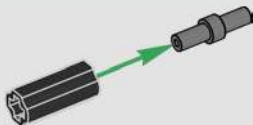

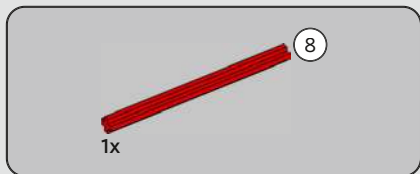

34

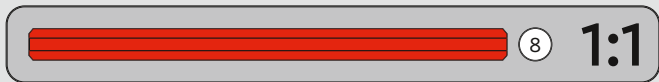
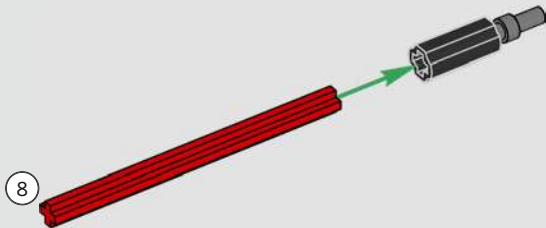



1x



1x

35

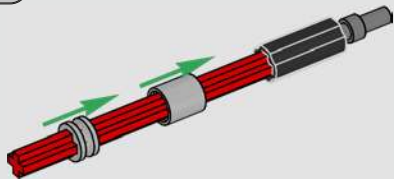

1x



1x

36

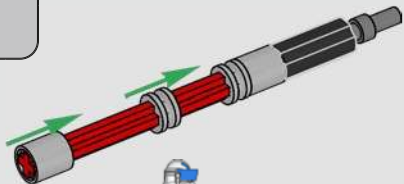



1x



1x

37

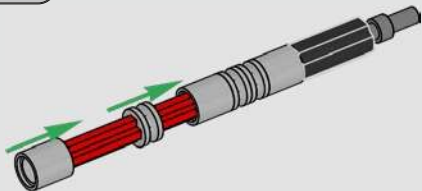

1x

38

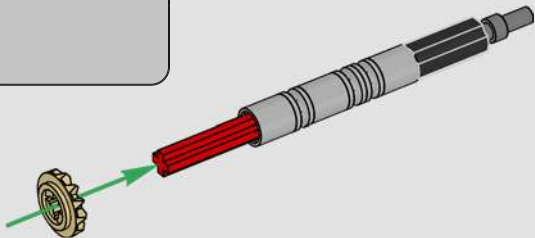

39

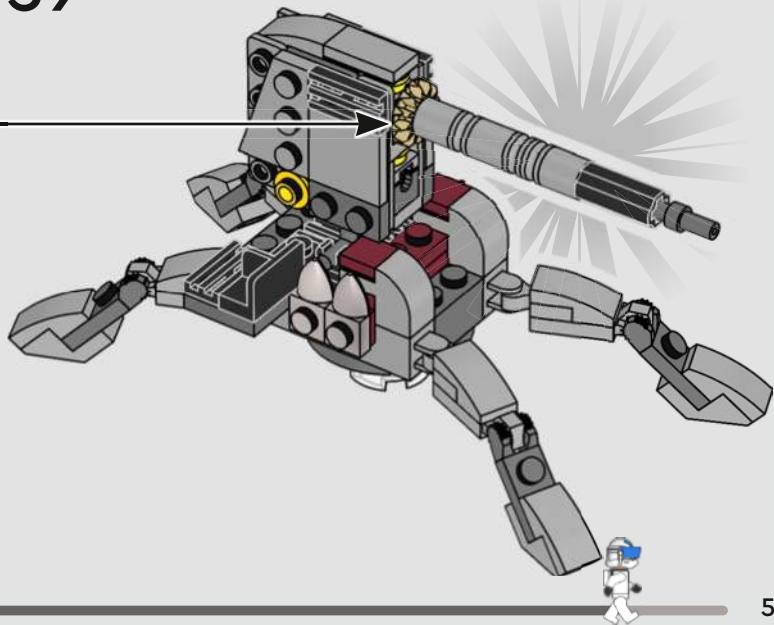



2x

40

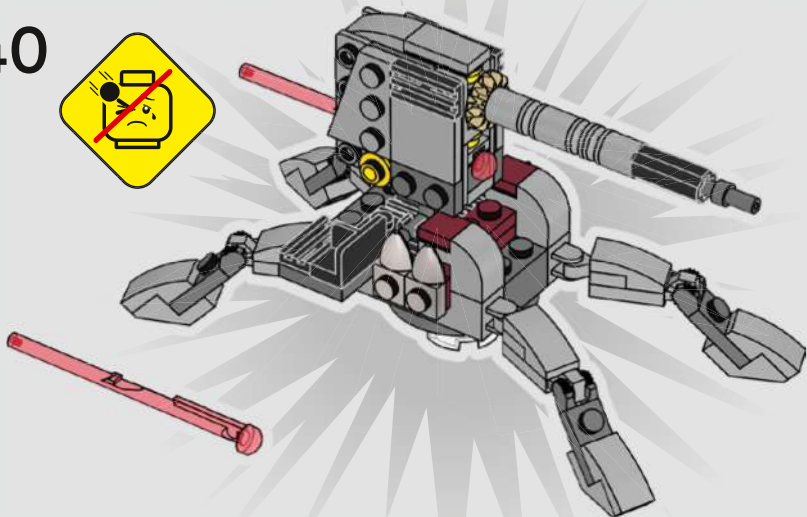

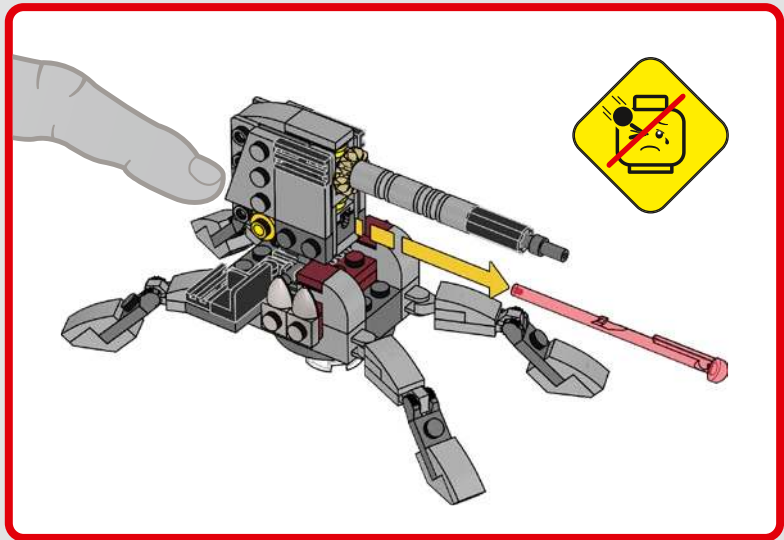

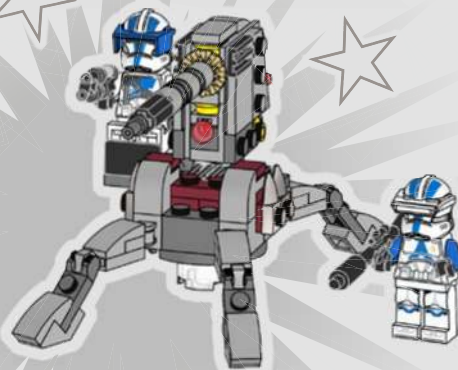



STAR WARS™

75347



75344



75345





Rebuild
the
world™





2x
6405190



1x
6429568



5x
6168644



1x
6290456



1x
6405186



2x
6405188



4x
6308125



2x
6003301



3x
6308127



2x
6380146



5x
241226



1x
6360207



1x
6429571



1x
6420698



2x
6347310



2x
4659662



2x
6429597



1x
4565452



1x
6115086



1x
4498712



2x
6170808



1x
4539061



2x
6285778



4x
6345639



1x
4512363



2x
6264026



9x
6028813



4x
6296894



1x
4539102



4x
6198932



3x
6183784



4x
6266231



2x
4550169



2x
6336539



1x
4211414



2x
6118827



2x
4539097



4x
6407767



2x
4211413



3x
6271165

58



1x
4211791



1x
4528323



1x
6429298



2x
6287550



1x
4211794



2x
6308045



1x
6324200



1x
6130004

8



1x
4211085



4x
6267047



1x
6273152



1x
4211002



1x
6350724



2x
6261355



4x
4625146



LEGO.com/service

YOU COULD

WIN



Scan this QR code or go to
LEGO.COM/PRODUCTFEEDBACK and give us
your short feedback about this LEGO® set
for a chance to win a cool LEGO prize.

Terms and Conditions apply*

DE: Du könntest GEWINNEN. Es gelten die Teilnahmebedingungen* **FR: Tu pourrais GAGNER.** Des conditions s'appliquent* **IT: Potresti VINCERE tu.** Termini e condizioni sono applicabili* **ES: Puedes GANAR.** Aplican términos y condiciones* **PT: Poderá GANHAR.** Aplicam-se termos e condições* **JA: プレゼント付き! 利用規約が適用されます*** **ZH: 轻松获奖. 条款和条件适用*** **KO: 상품의 주인이 되어보세요. 소정의 약관이 적용됩니다*** **RU: Вы можете ВЫИГРАТЬ.** Действуют положения и условия* **PL: Szansa na WYGRANĄ.** Obowiązują warunki korzystania* **CS: Máte šanci VYHRÁT.** Platí všeobecné smluvní podmínky* **SK: Máte šancu VYHRAŤ.** Platia všeobecné zmluvné podmienky* **HU: TE IS NYERHETSZ.** Felhasználási feltételek érvényesek* **RO: Ai putea CÂȘTIGA.** Se aplică termenii și condiții* **BG: Можете да СПЕЧЕЛИТЕ.** Има определени правила и условия* **LV: Tu vari LAIMĒT.** Ir spēkā noteikumi un nosacījumi.* **ET: Sul on võimalus VÕITA.** Kehtivad tingimused* **LT: Jūs galite LAIMĖTI.** Taikomos sąlygos*

*LEGO.com/productfeedback-terms

LEGO and the LEGO logo are trademarks of the LEGO Group. ©2023 The LEGO Group.
© & ™ Lucasfilm Ltd.

6493750