

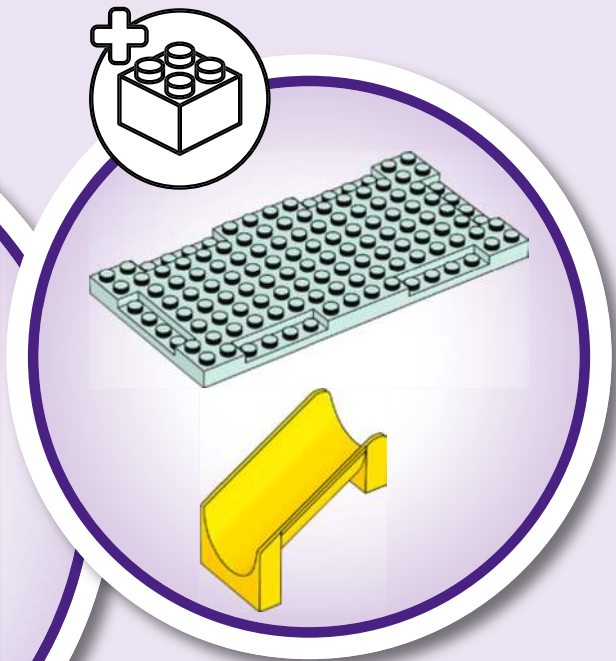

DREAMWORKS
**GABBY'S
DOLLHOUSE**

10788





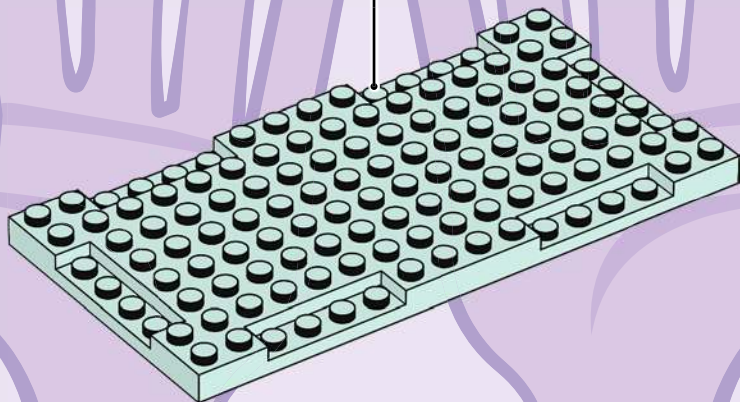
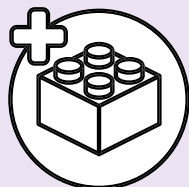

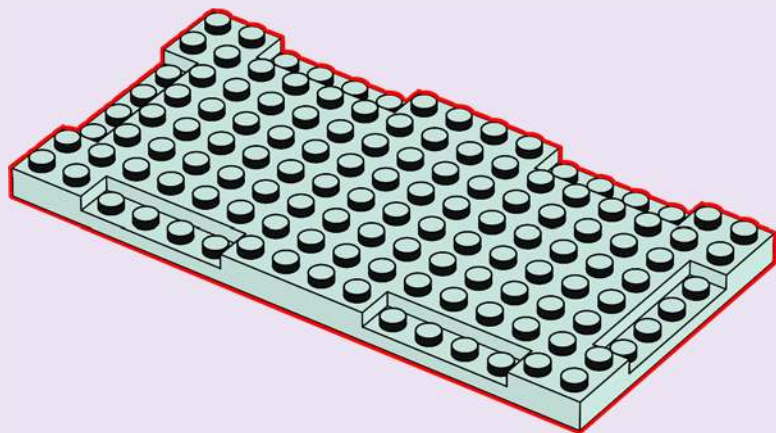

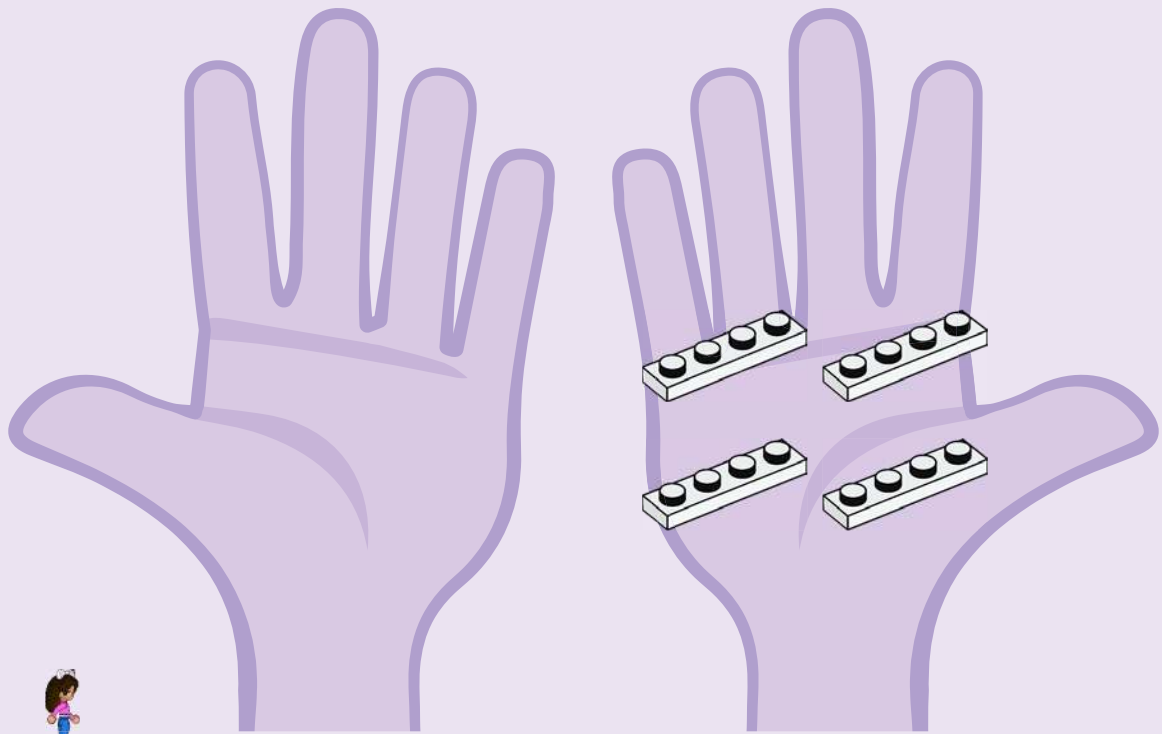

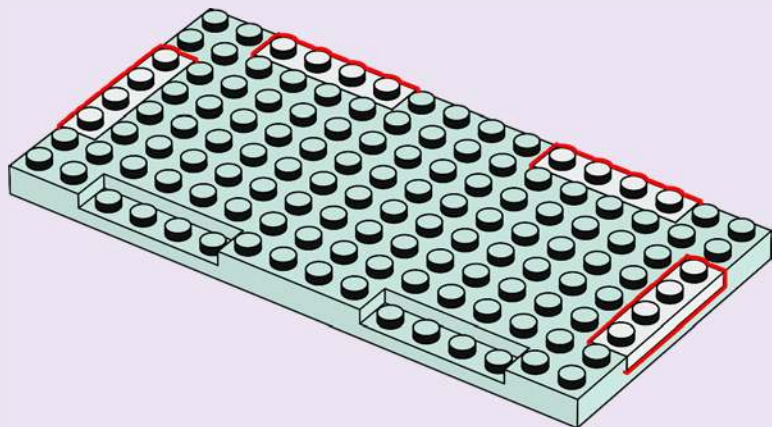

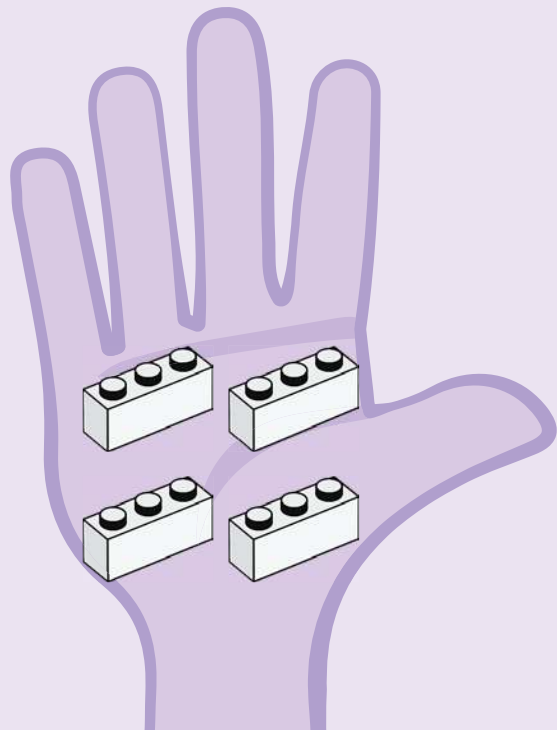
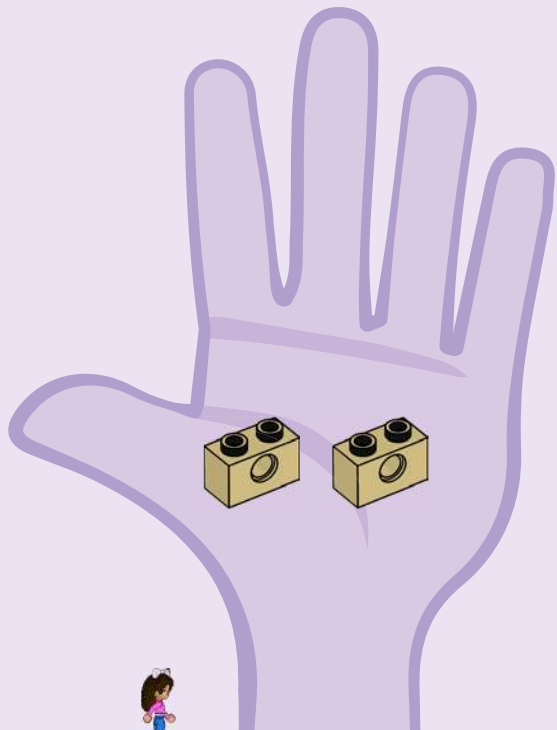

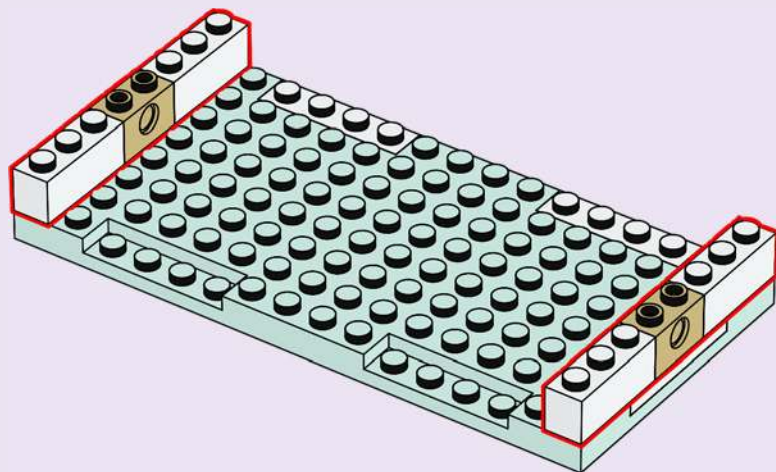

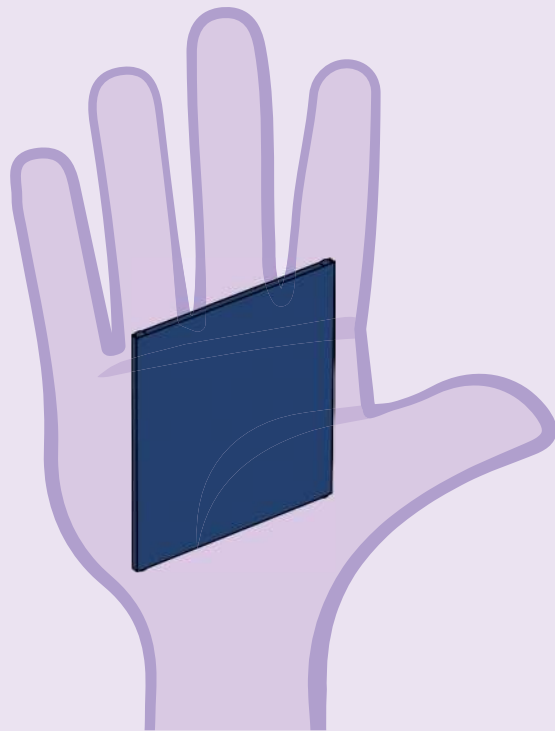
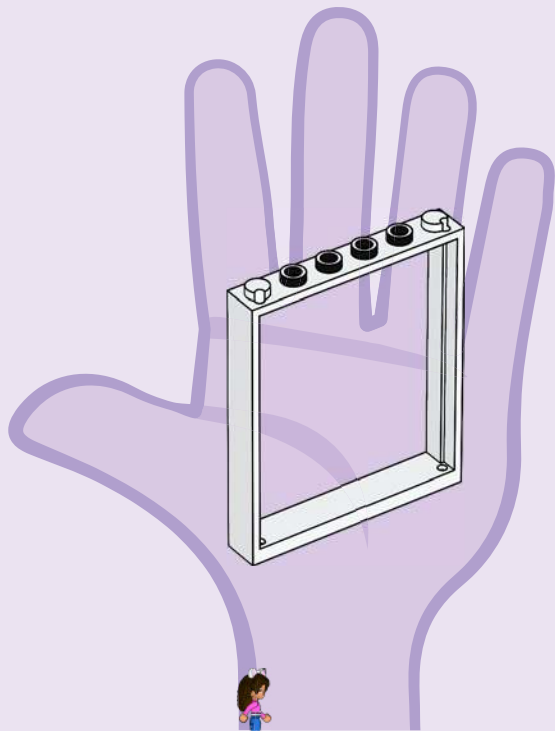

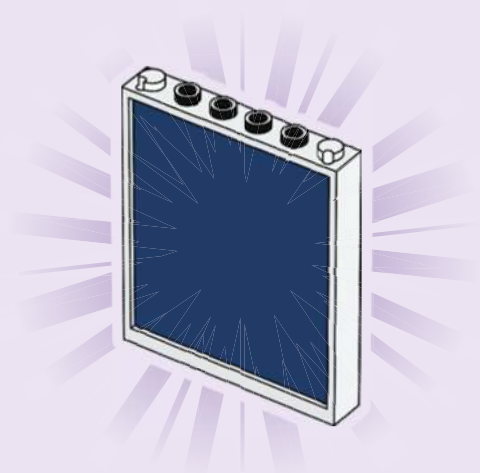
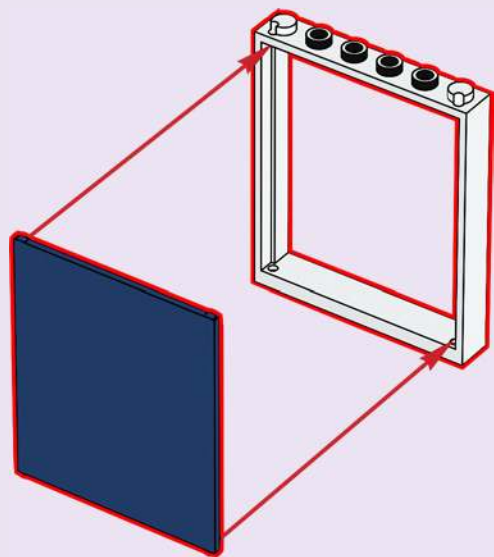

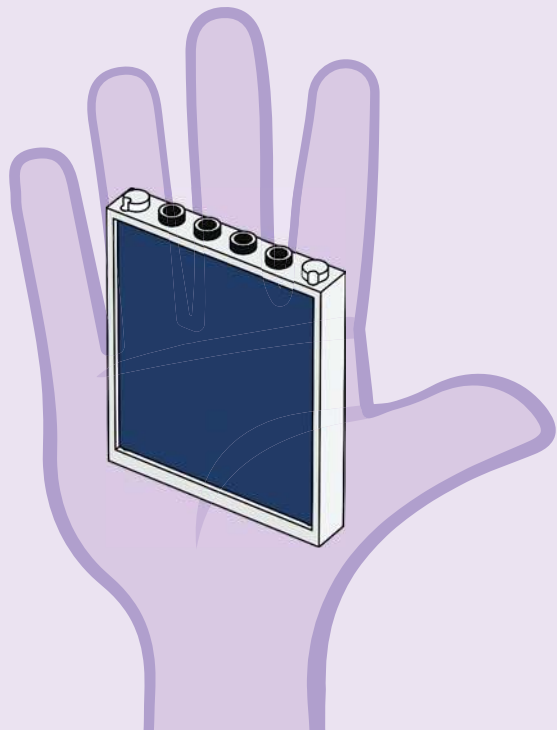

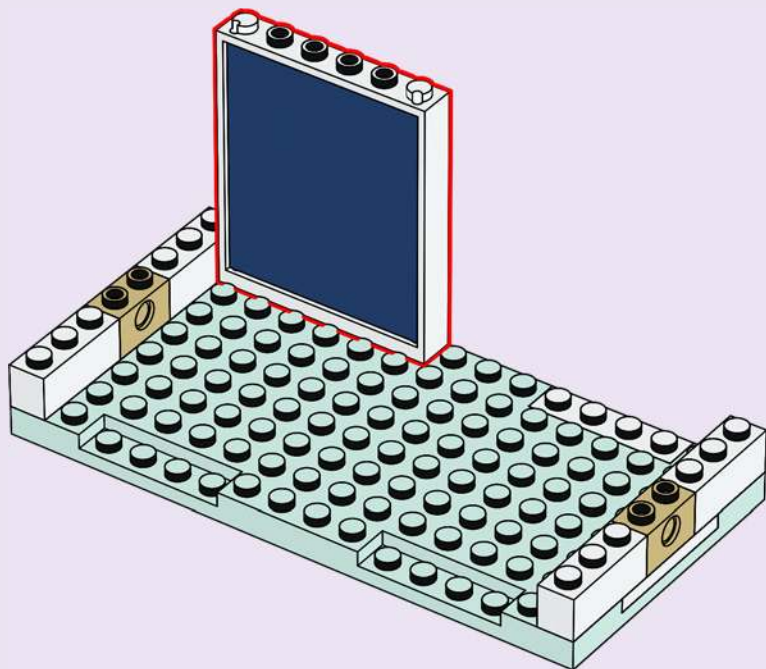

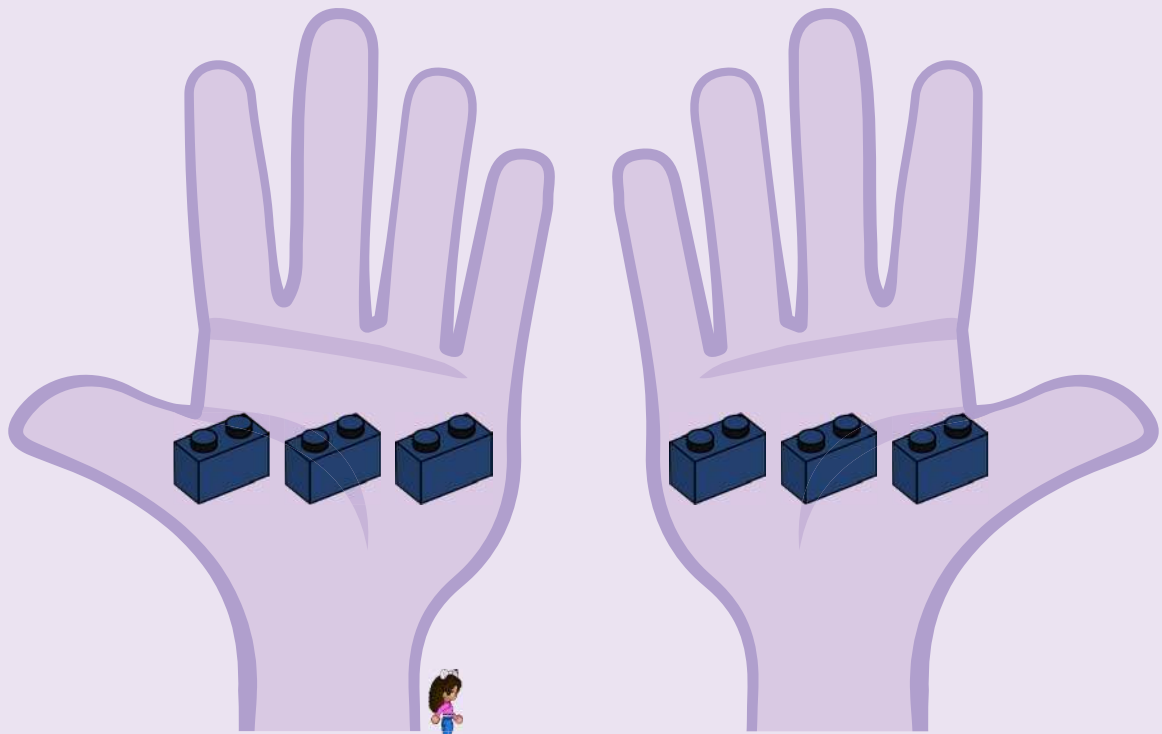

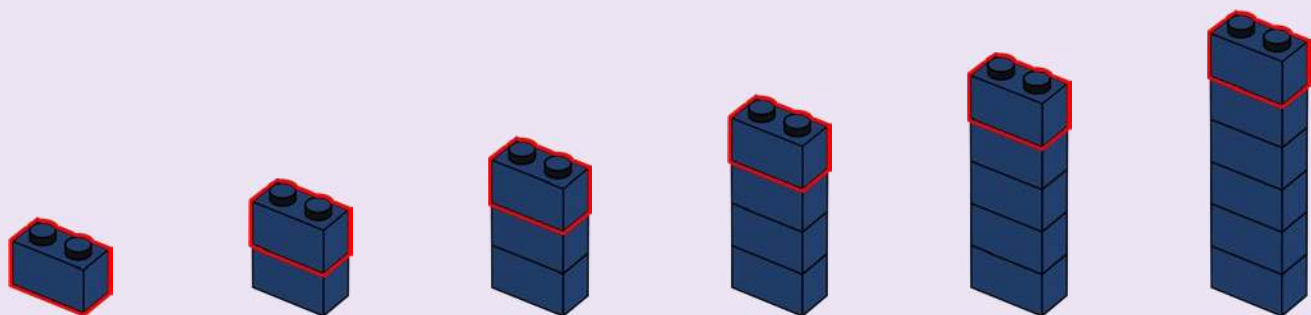

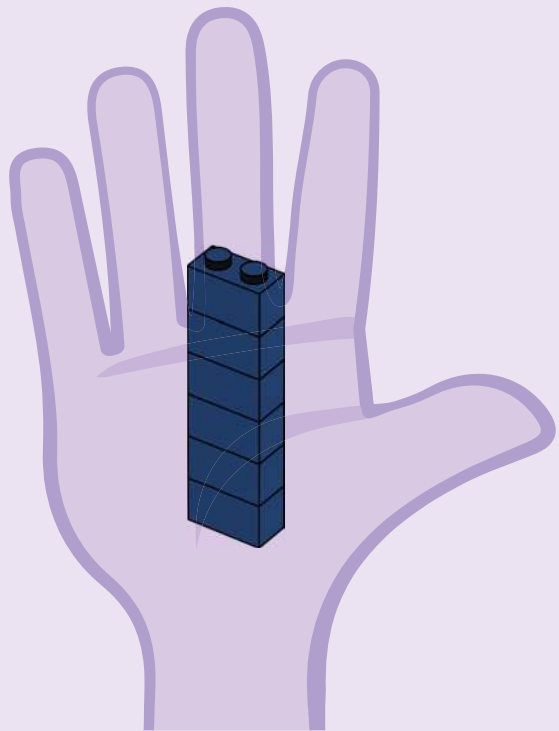

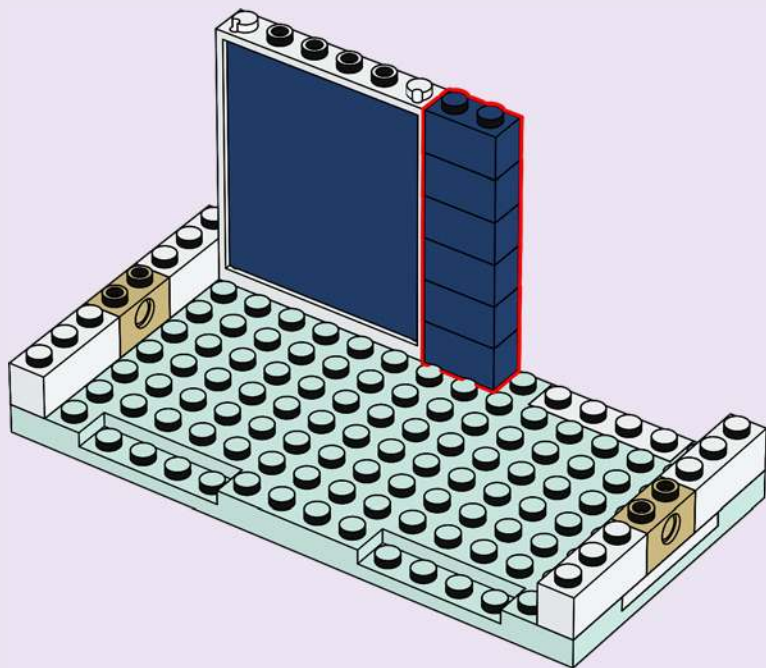

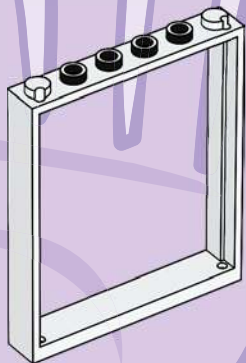

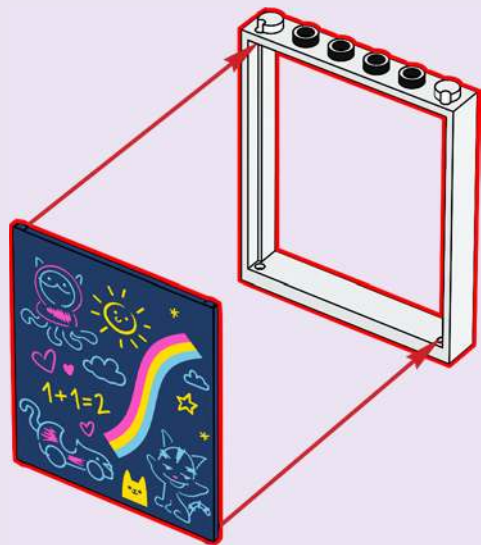



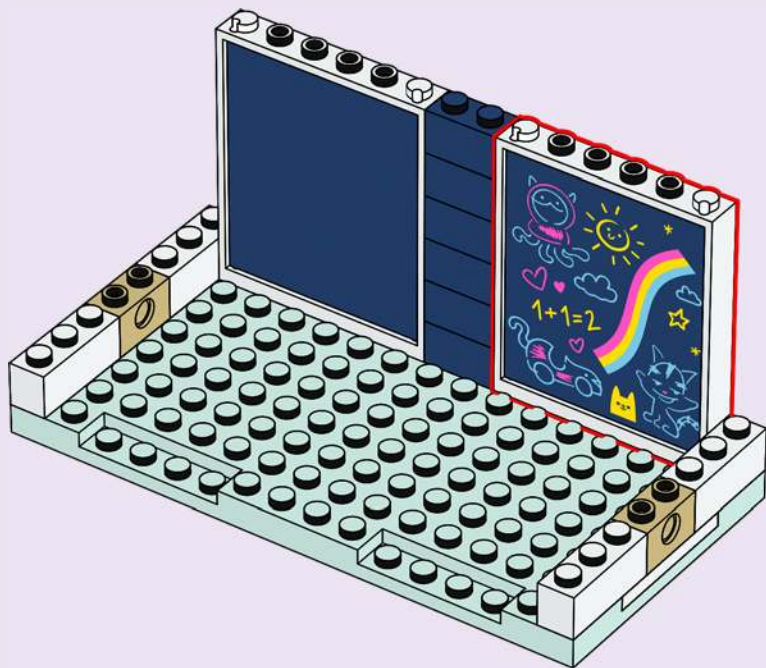

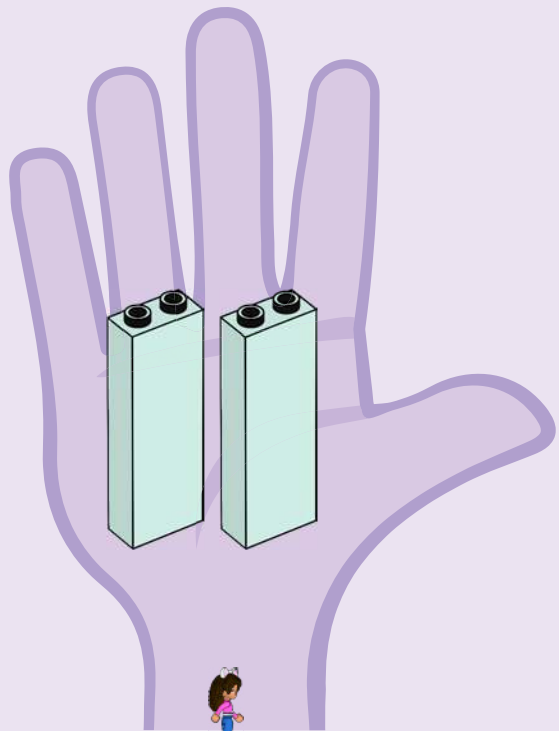

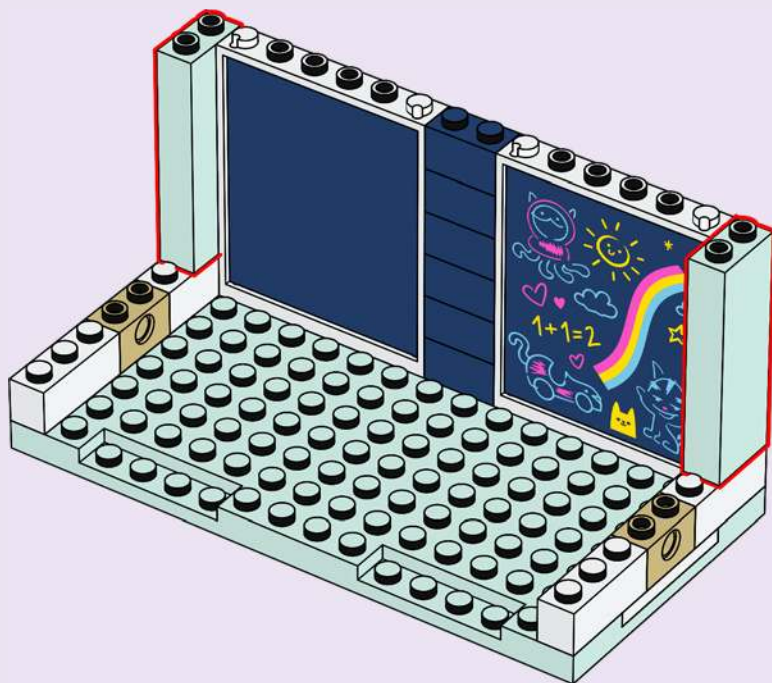

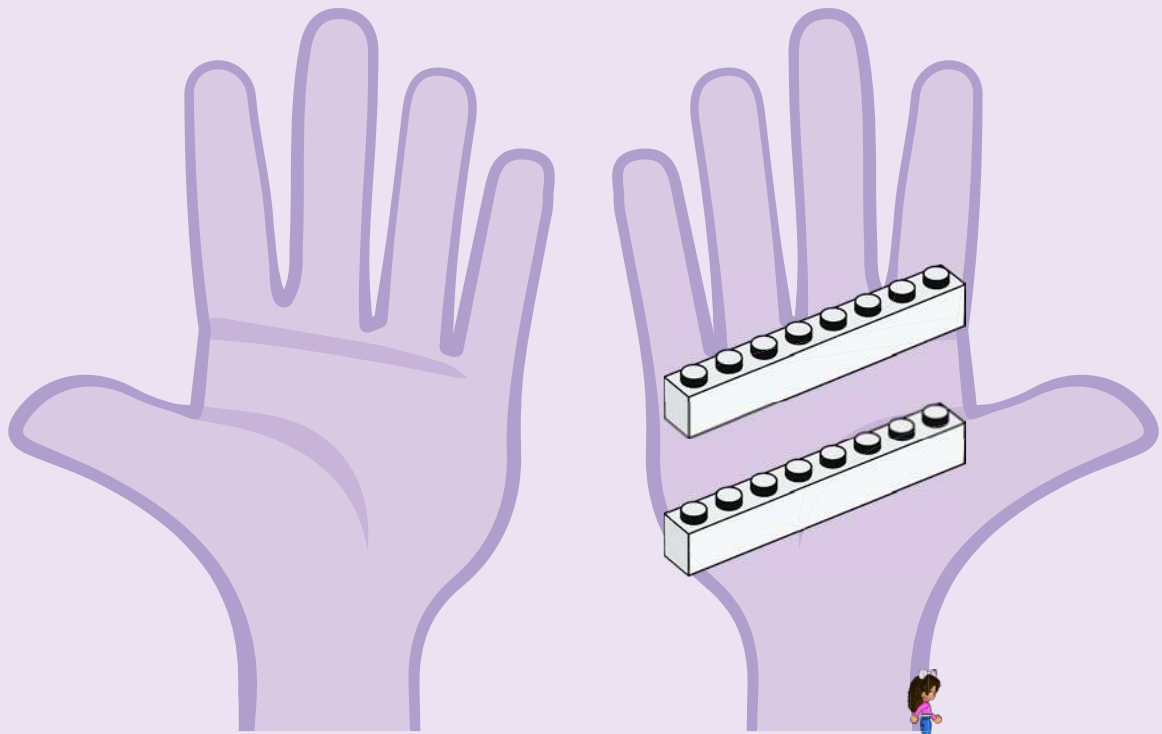

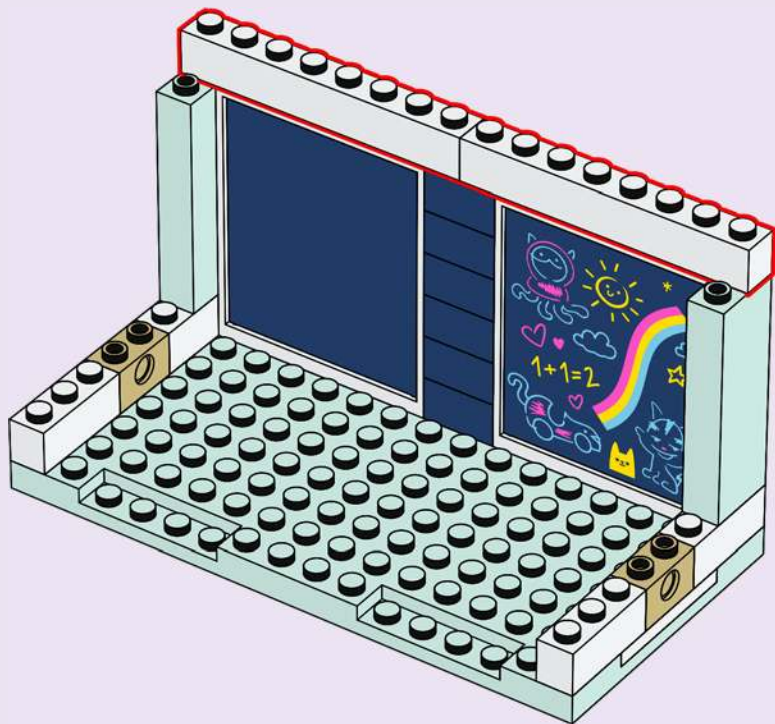

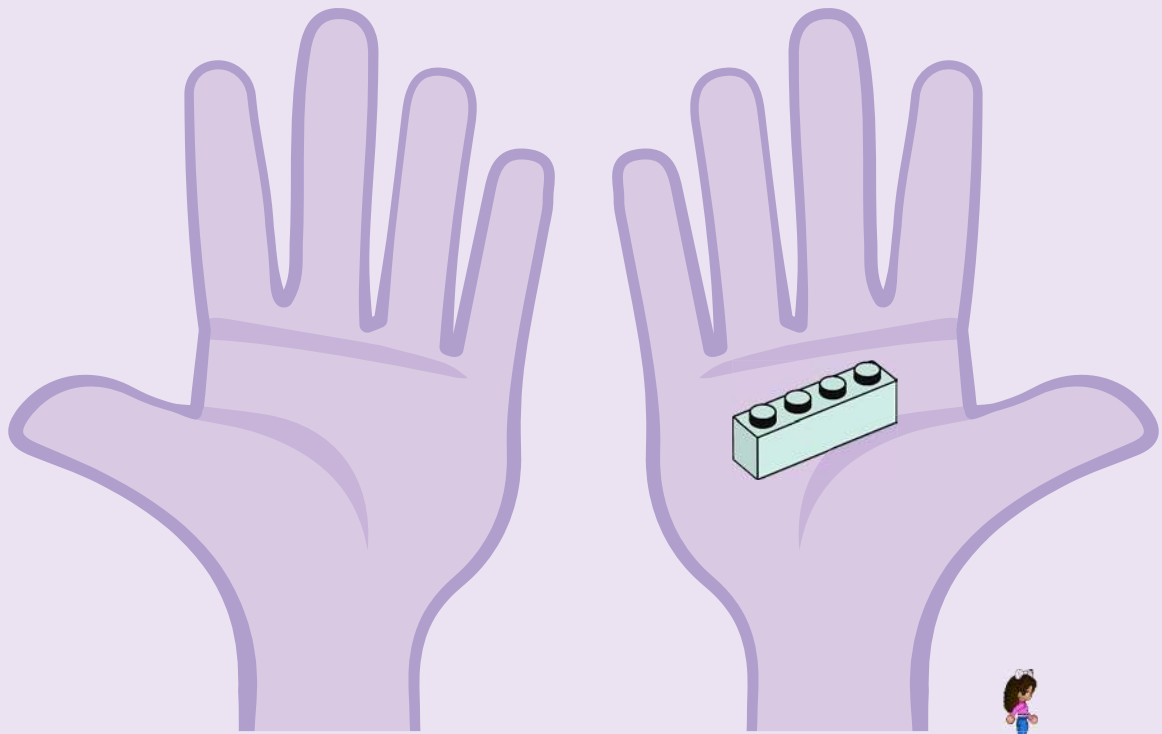

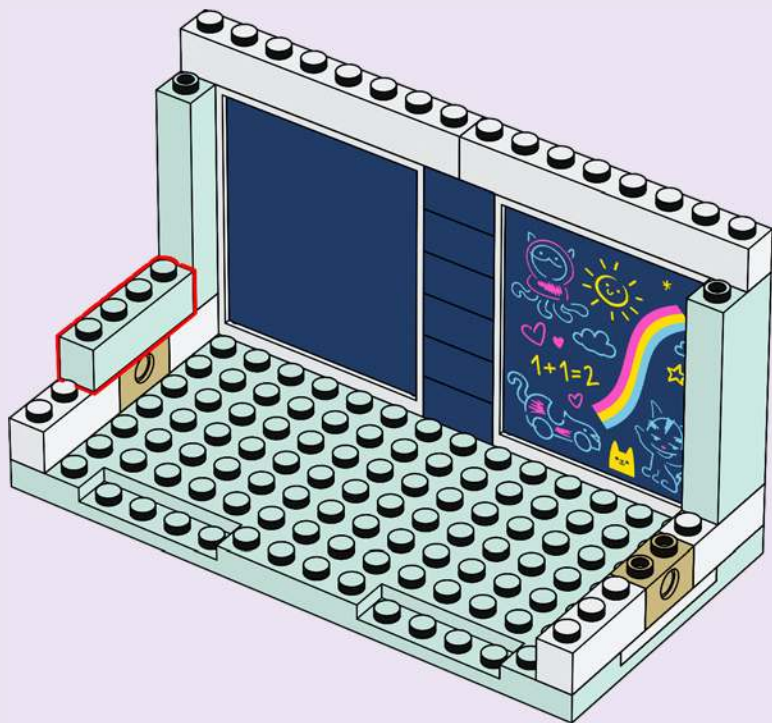

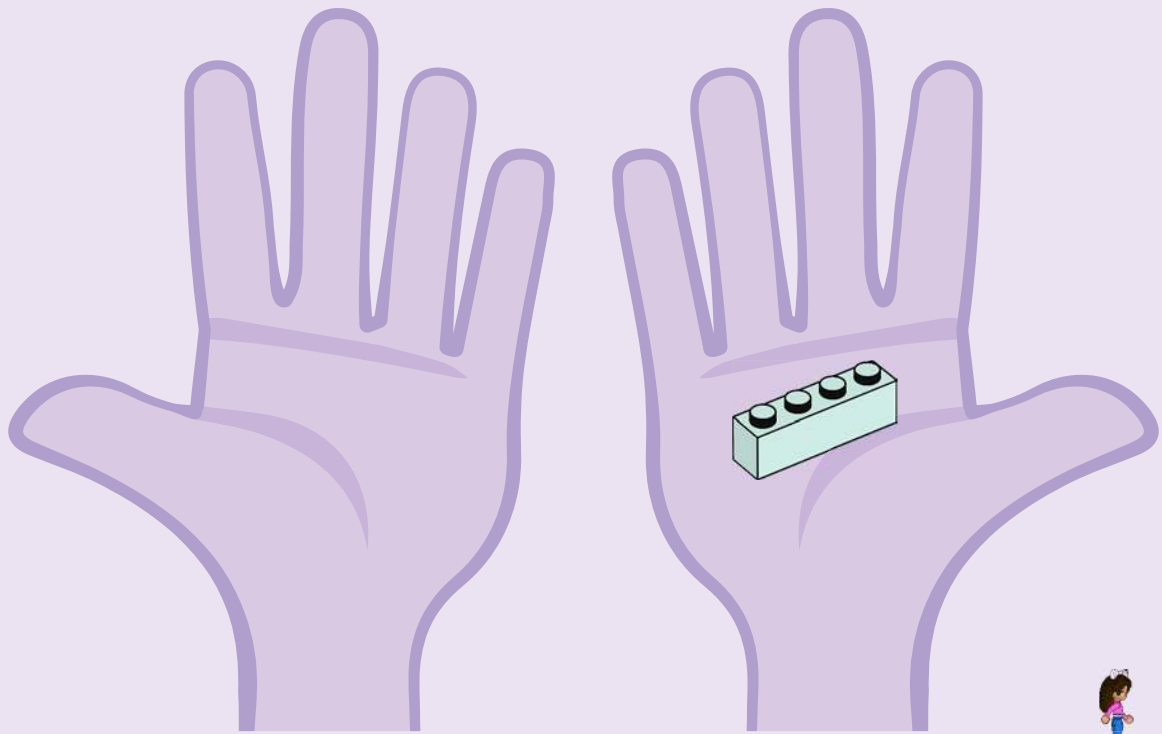

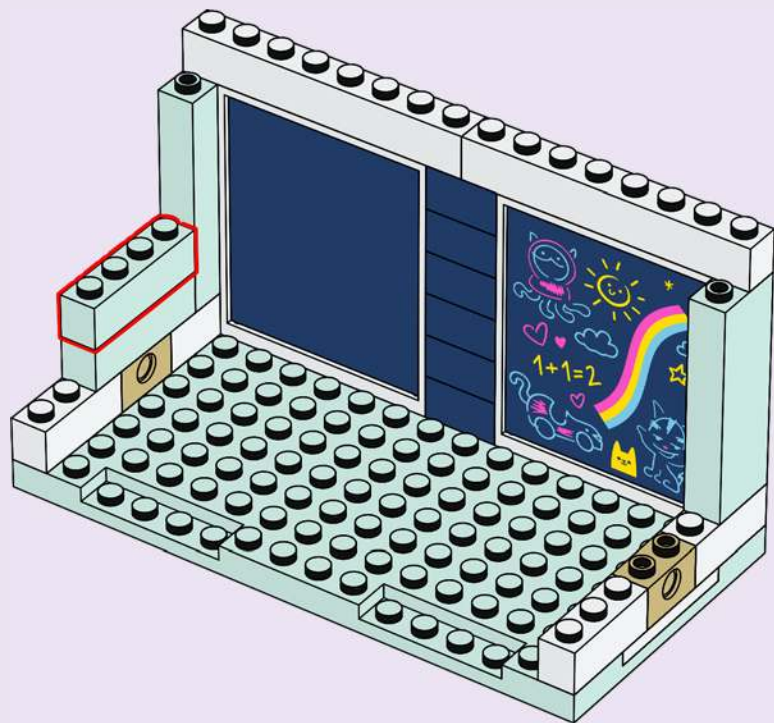

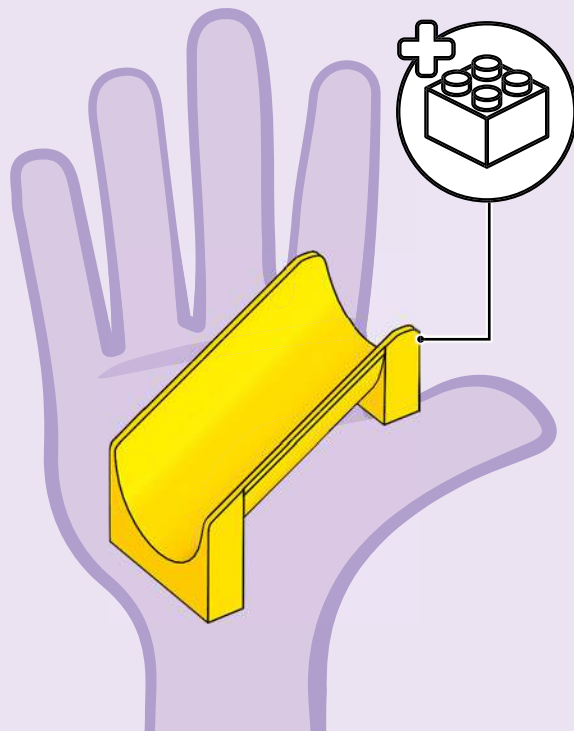

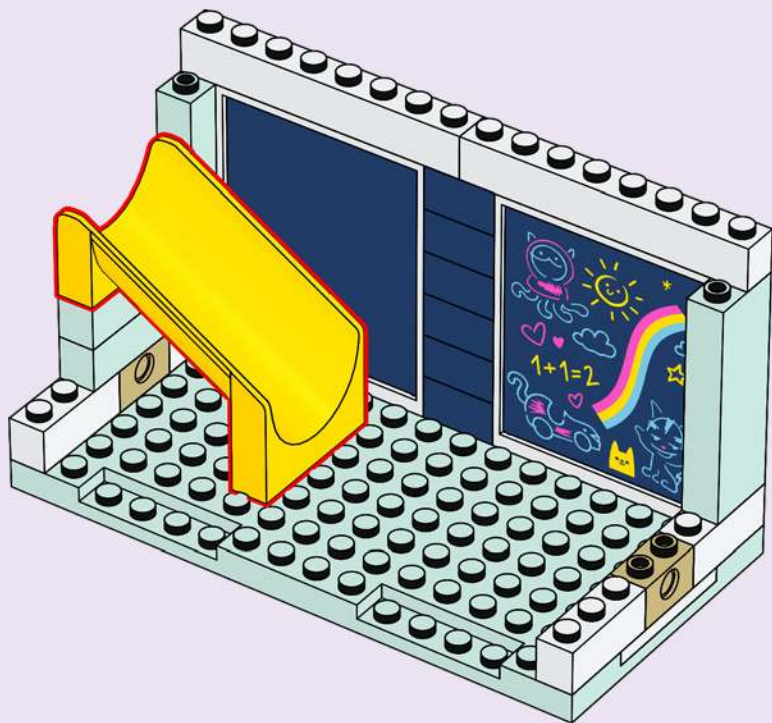

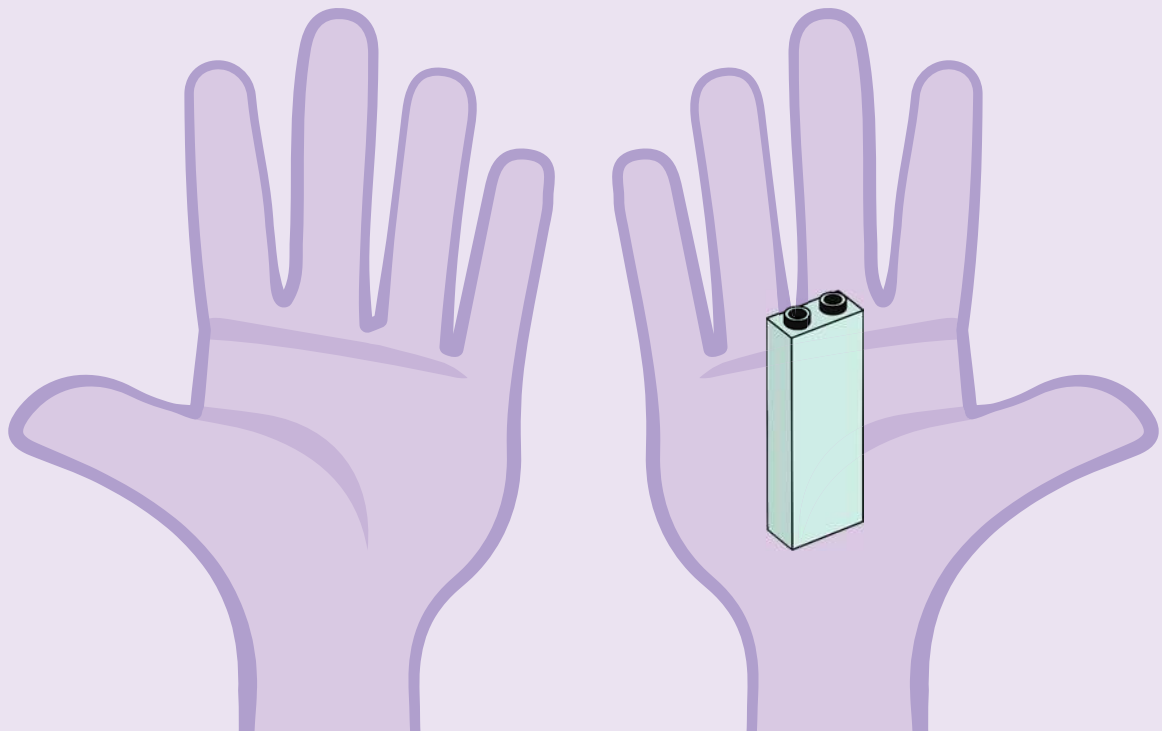

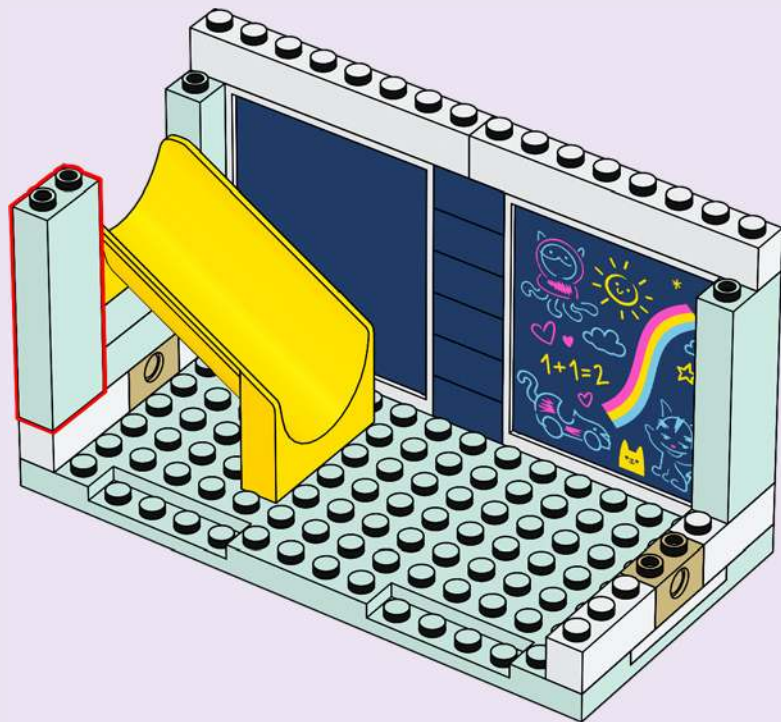

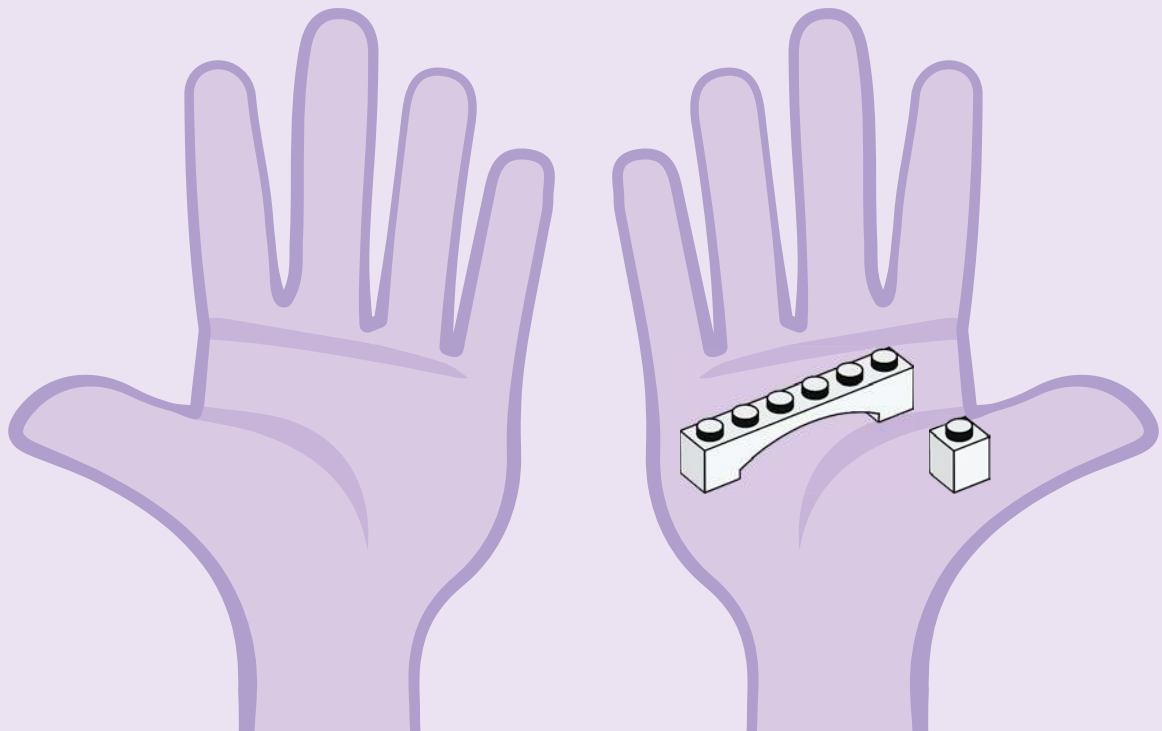

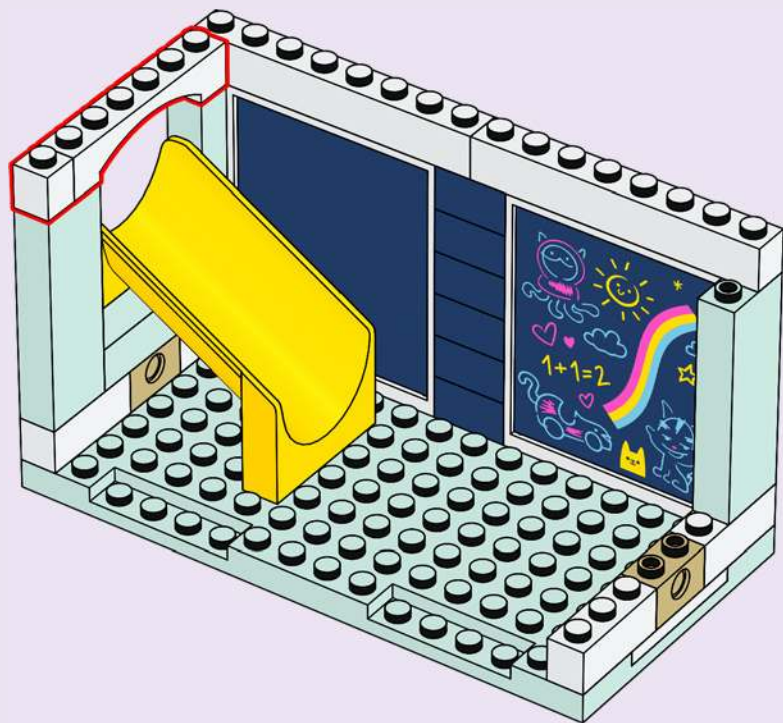

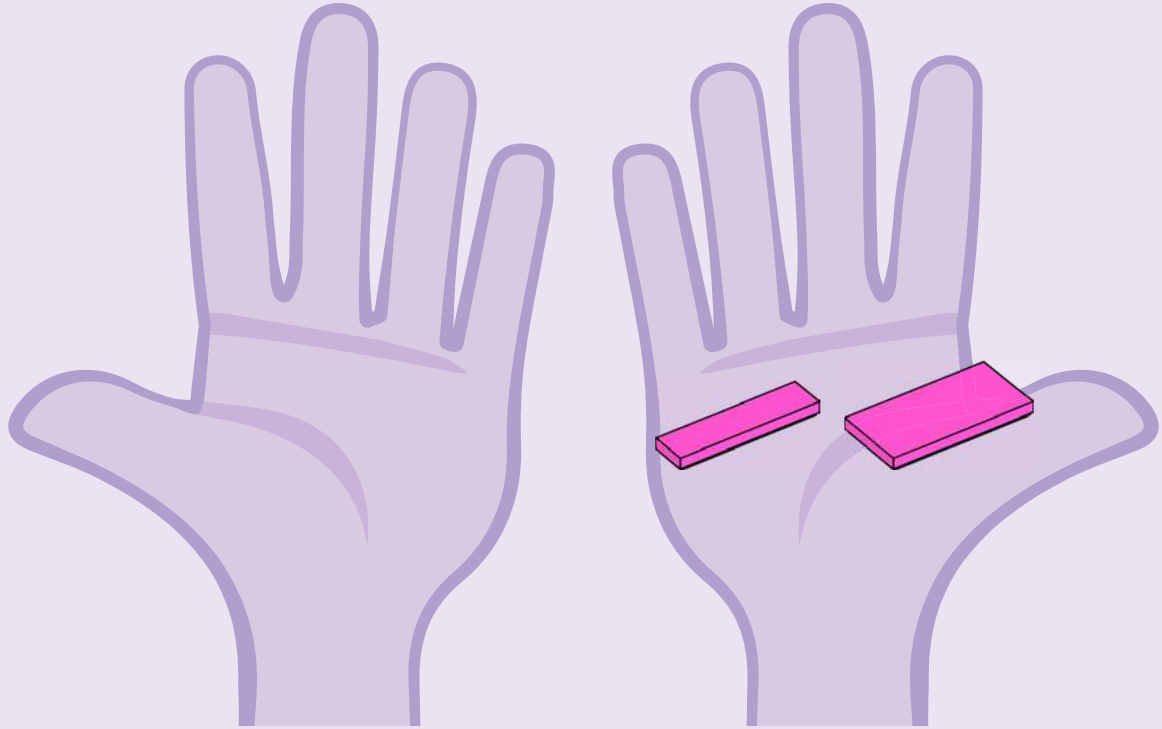

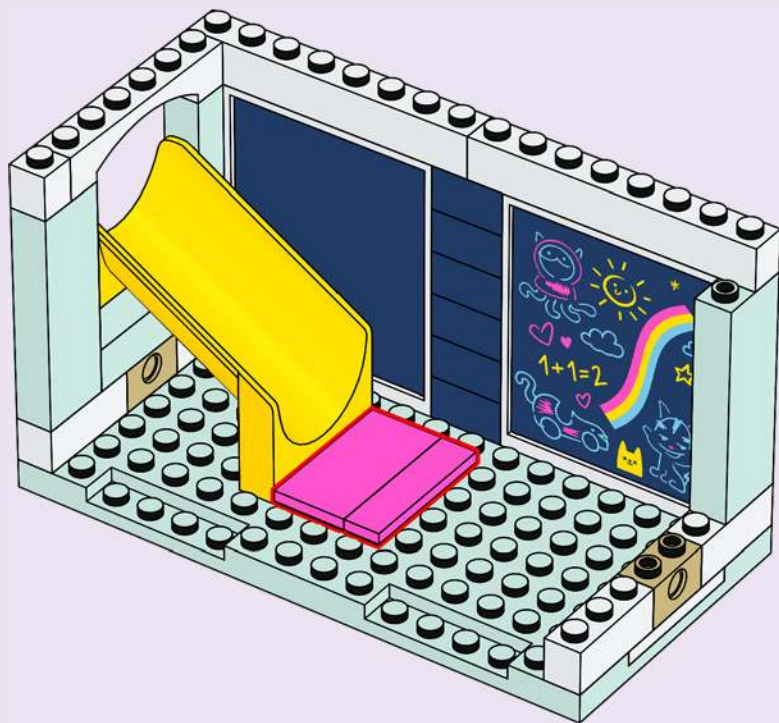

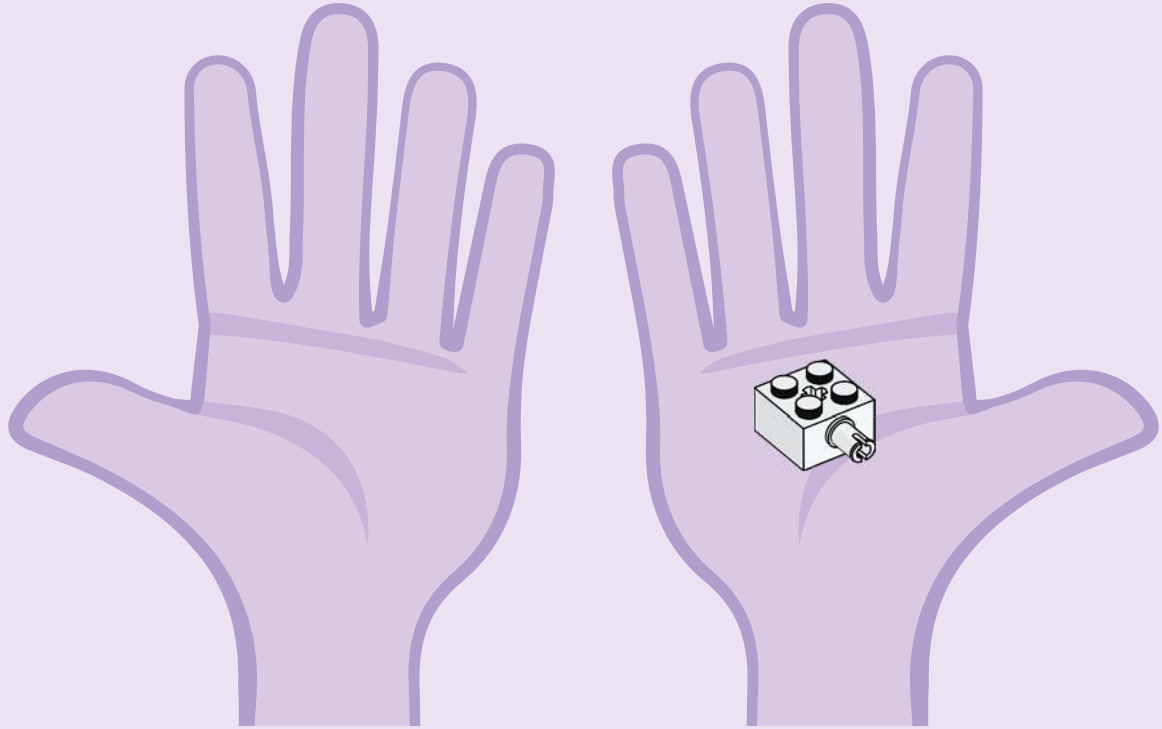

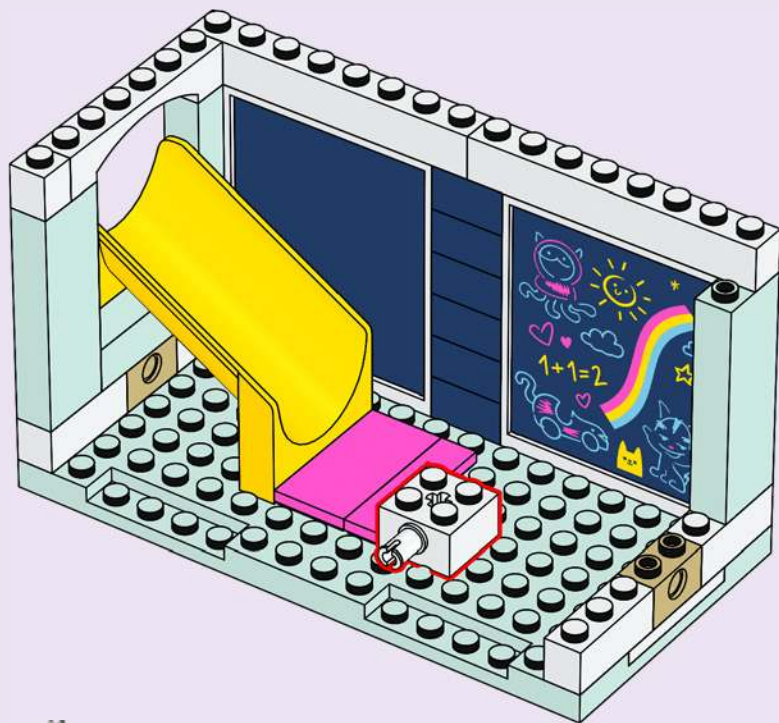

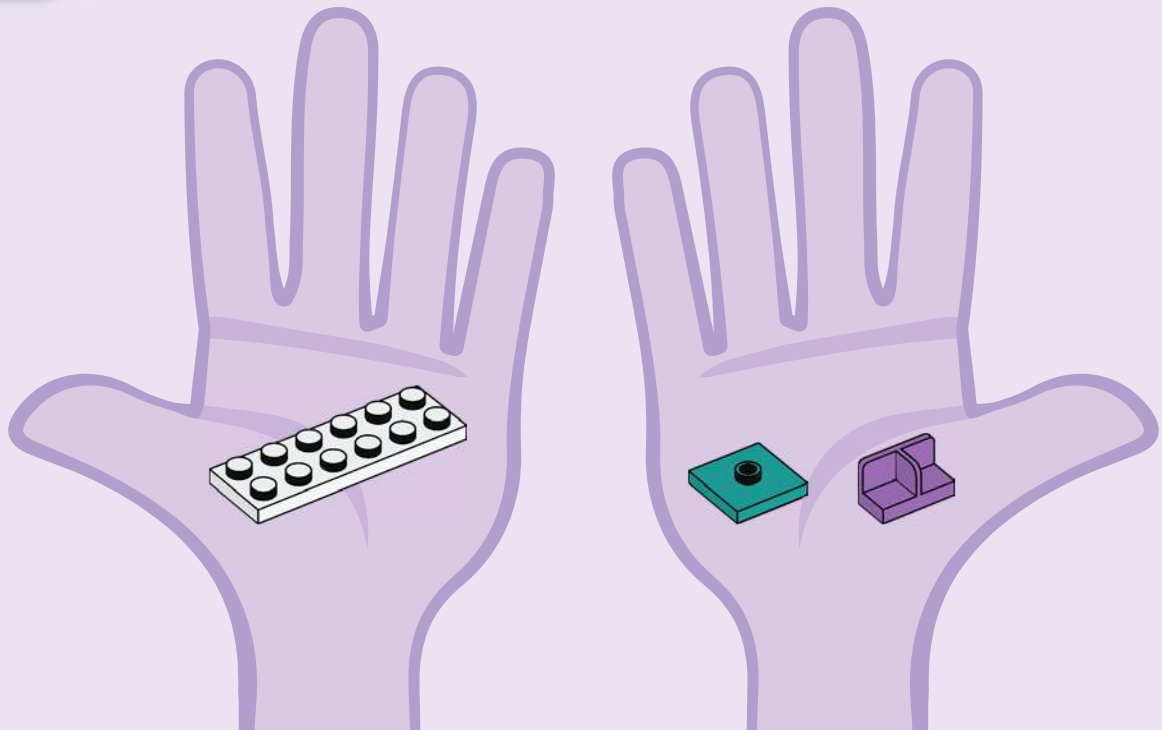

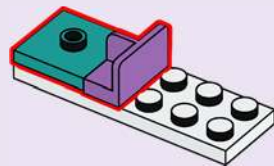

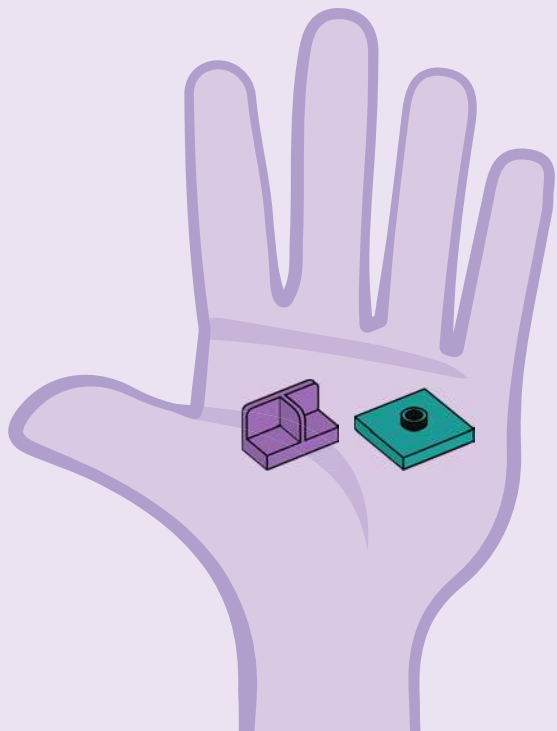

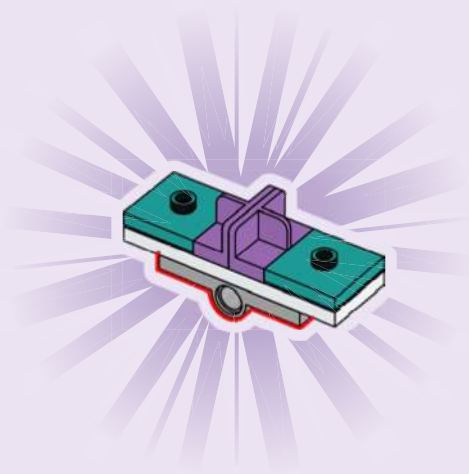
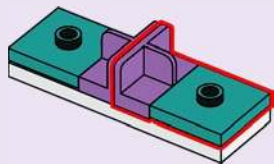

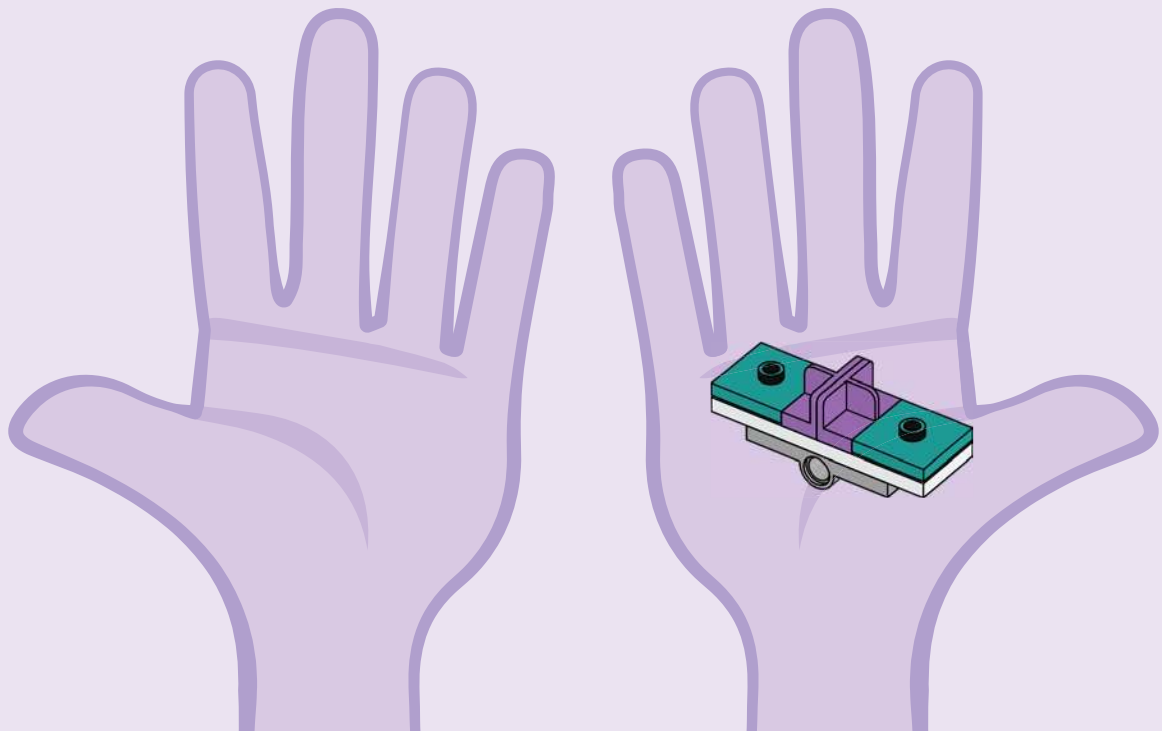

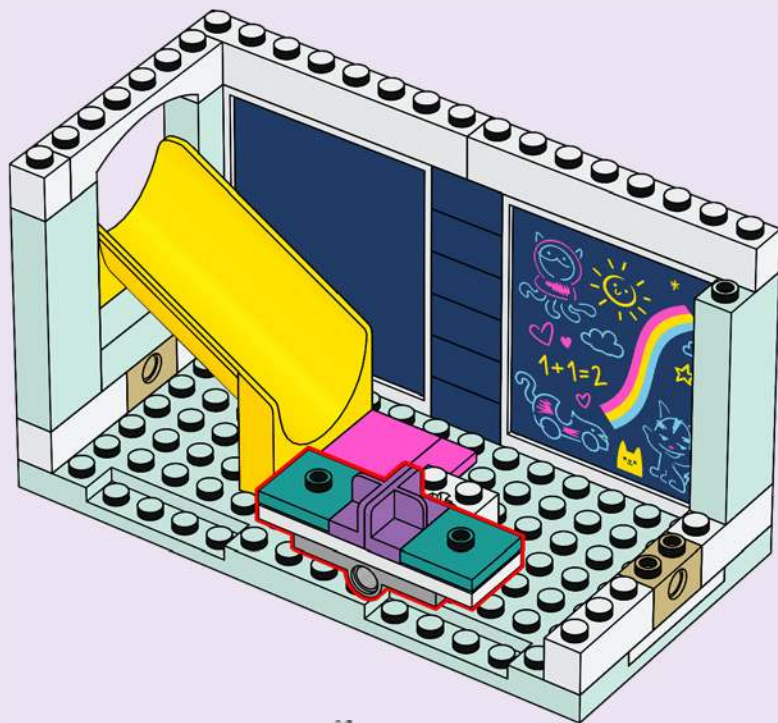

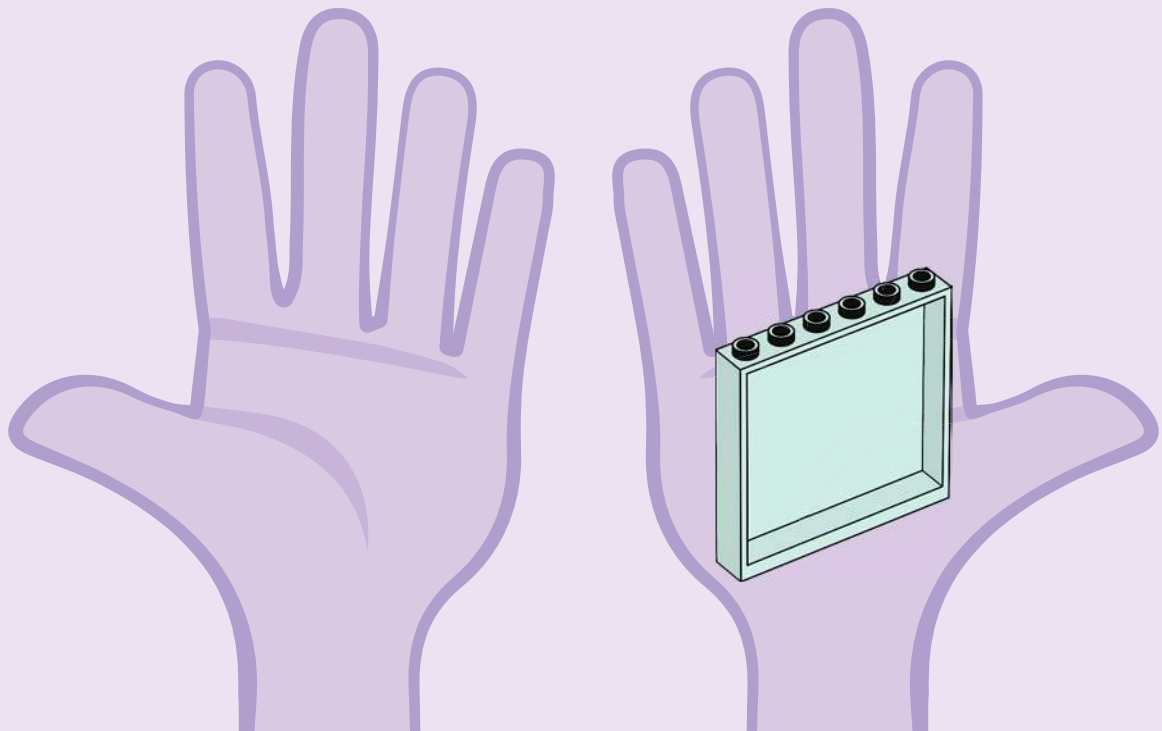

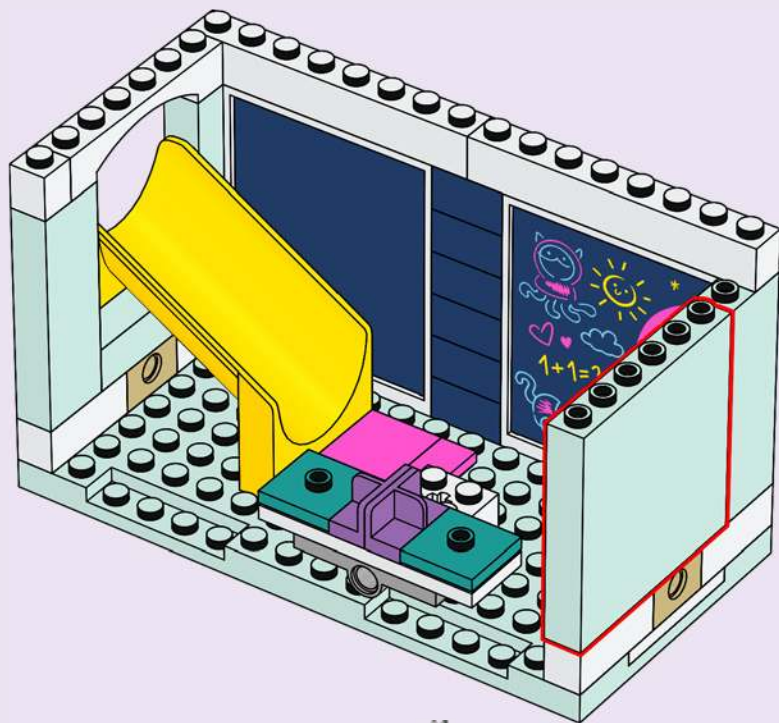

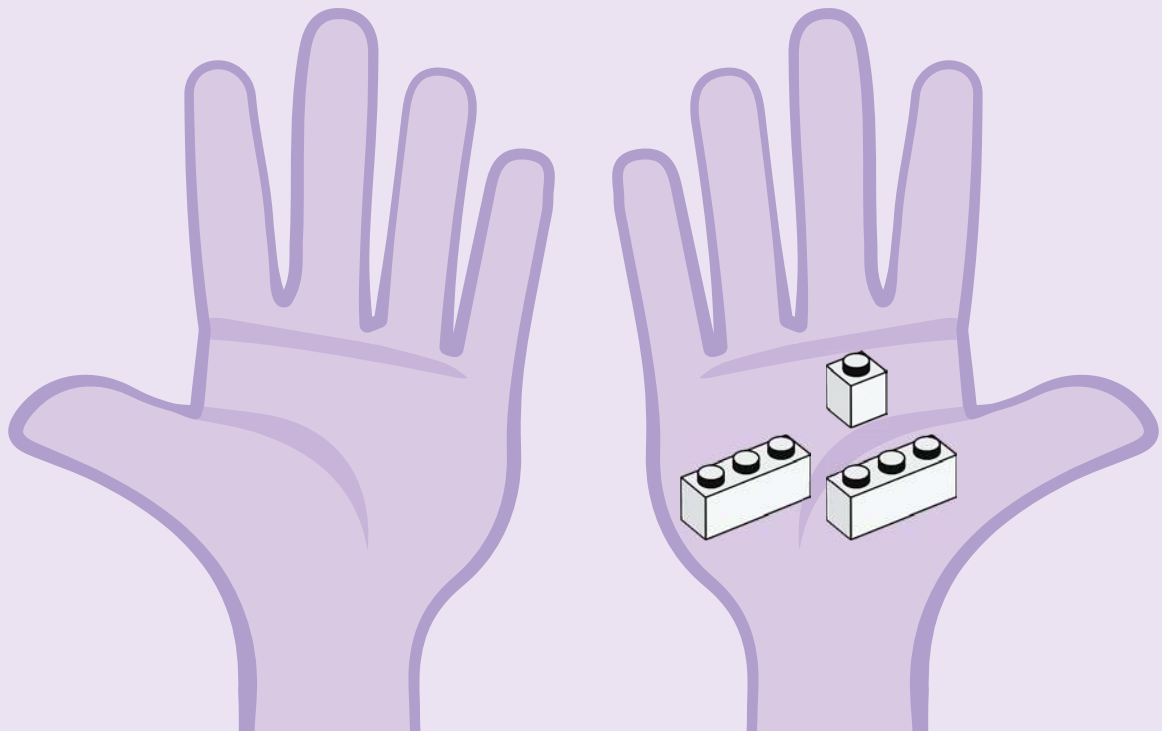

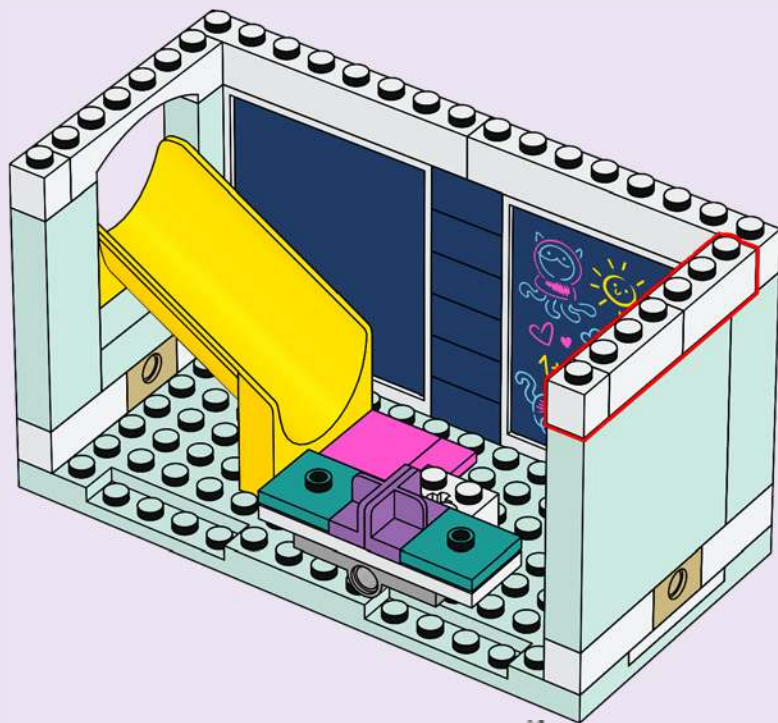

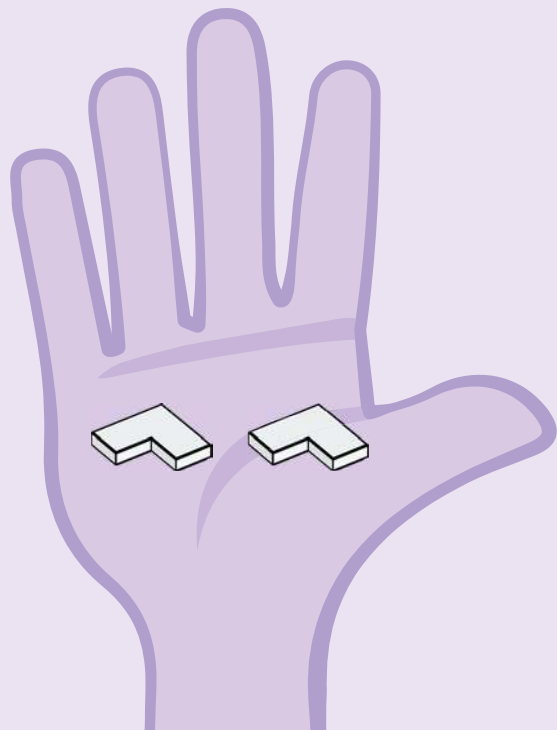
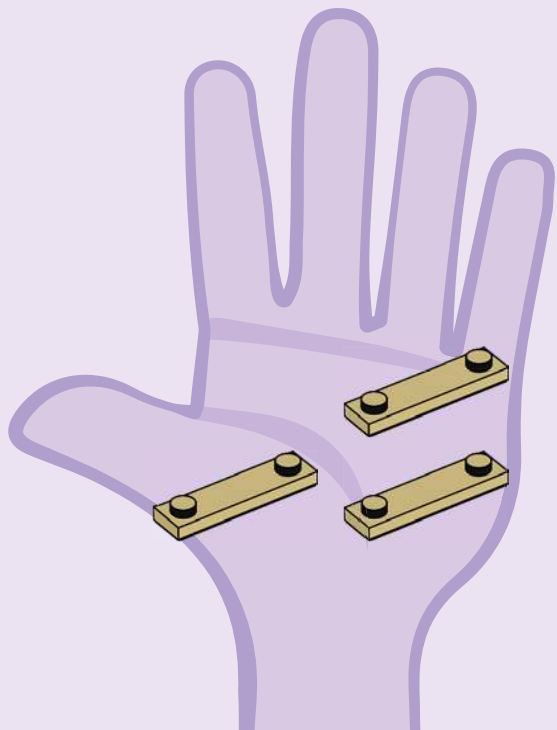

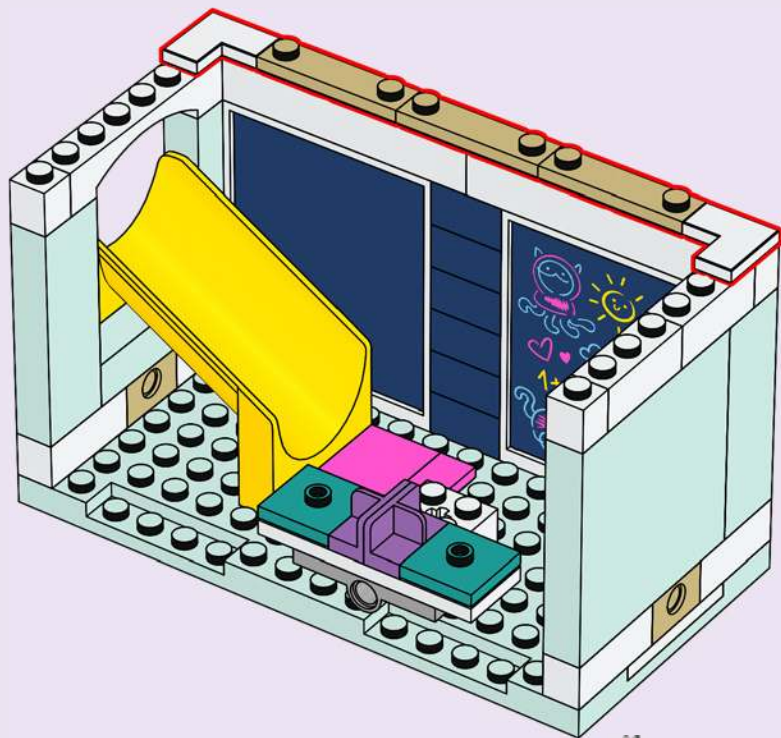

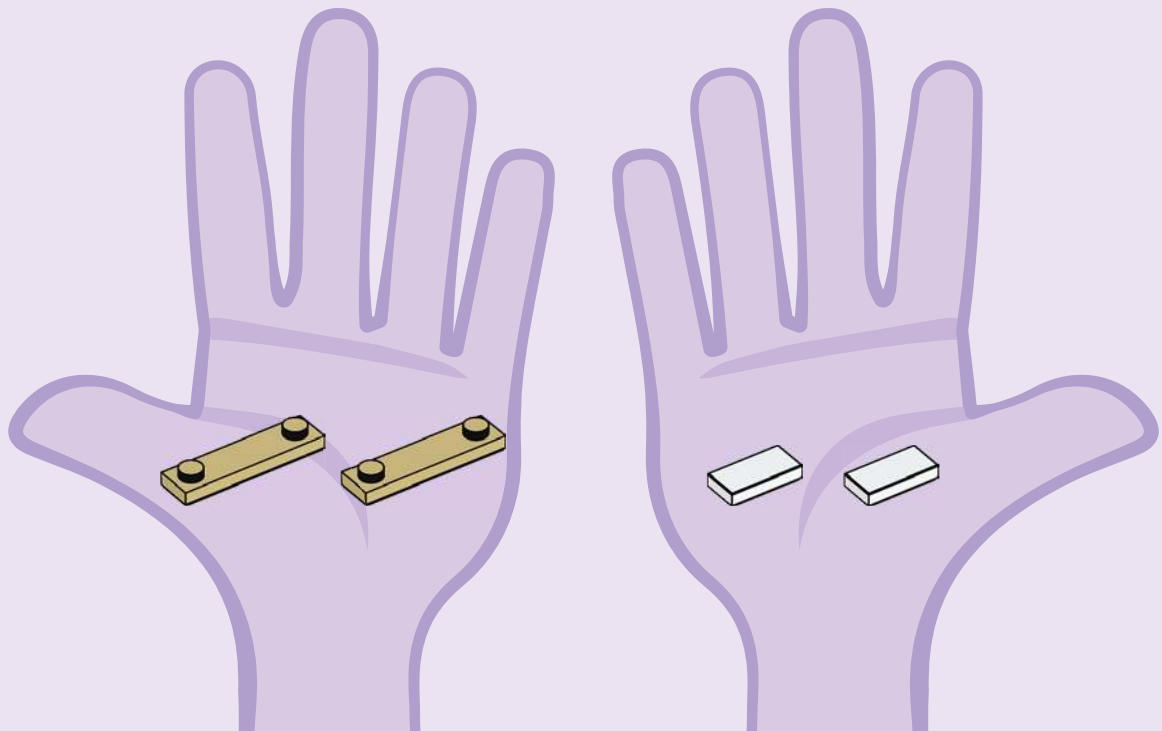

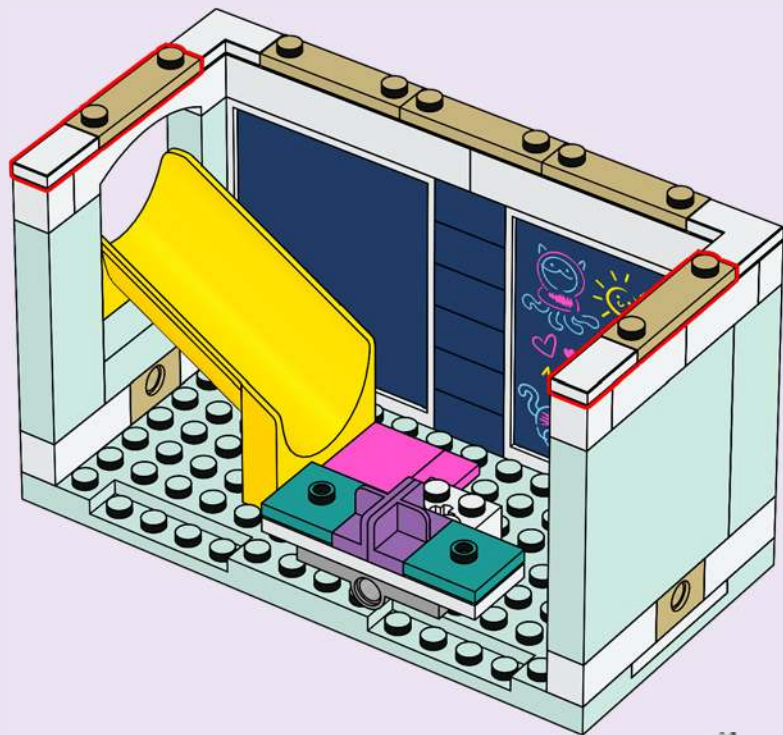

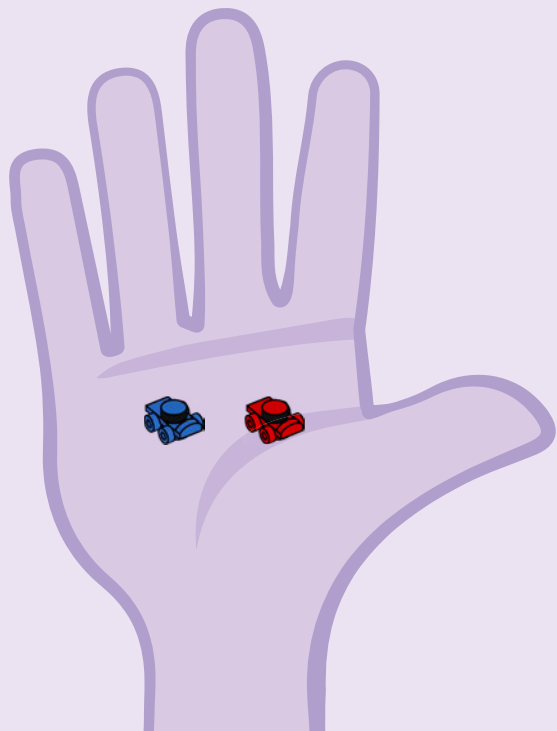
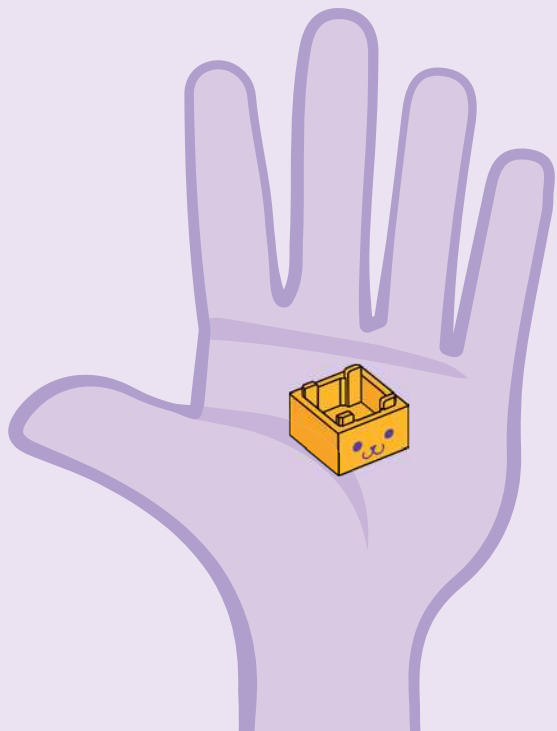

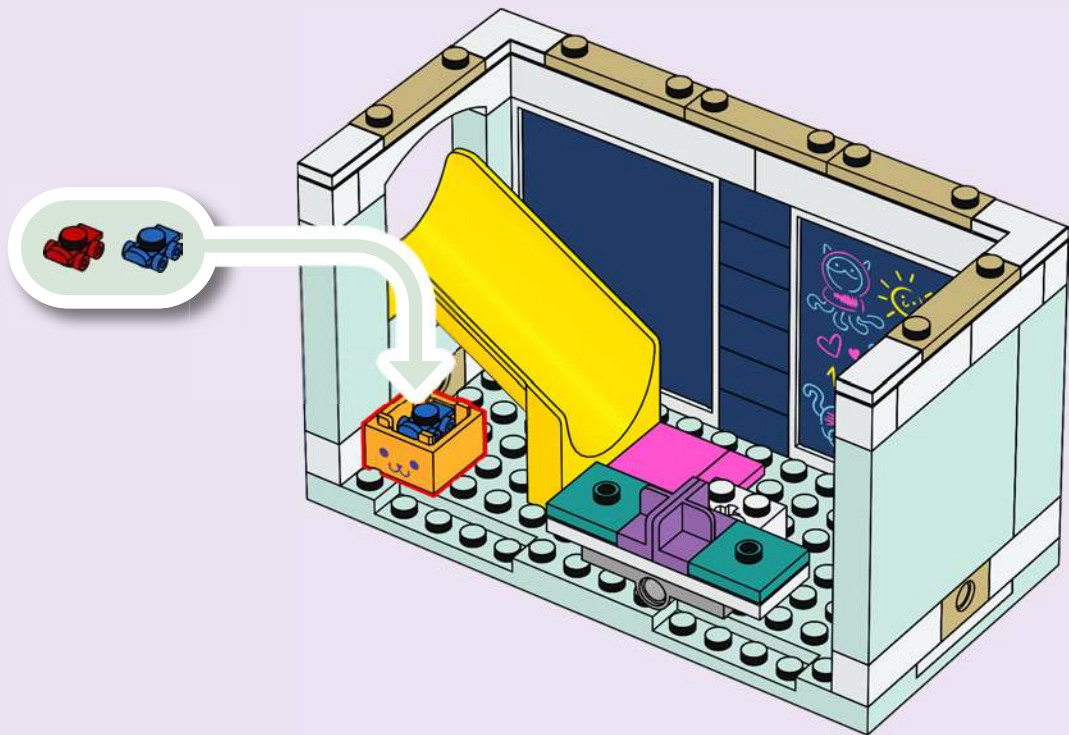











LEGO and the LEGO logo are trademarks of the LEGO Group.
©2023 The LEGO Group. 6473581
DreamWorks Gabby's Dollhouse © DreamWorks Animation LLC.
All rights reserved.

Rebuild
the
world™

