



DREAMWORKS
**GABBY'S
DOLLHOUSE**

10788



2





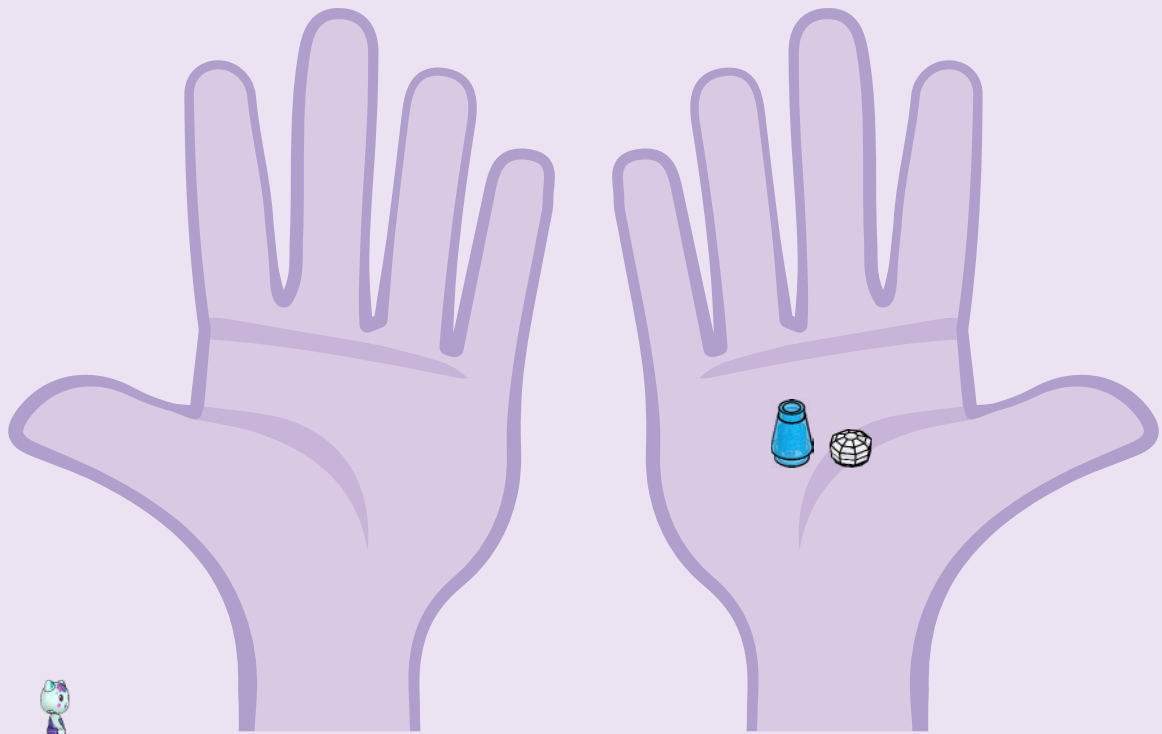



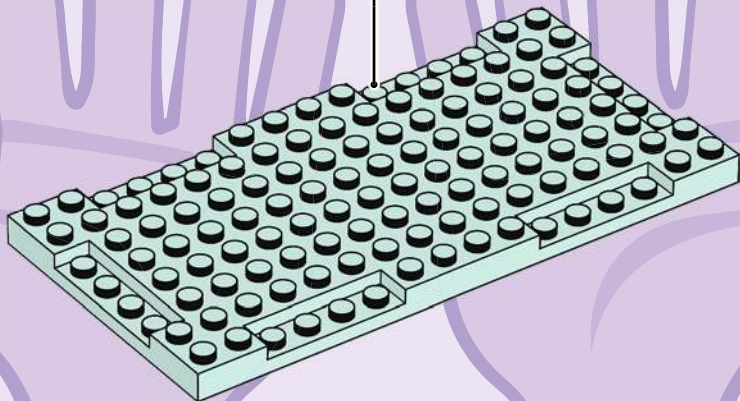
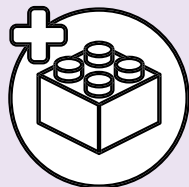

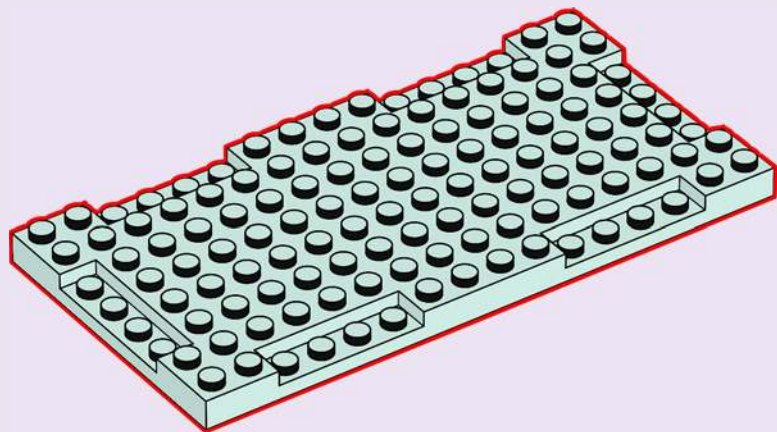

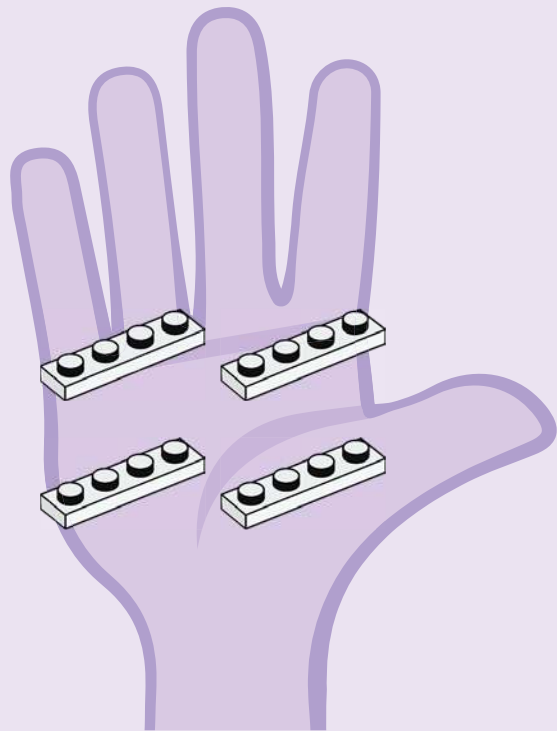

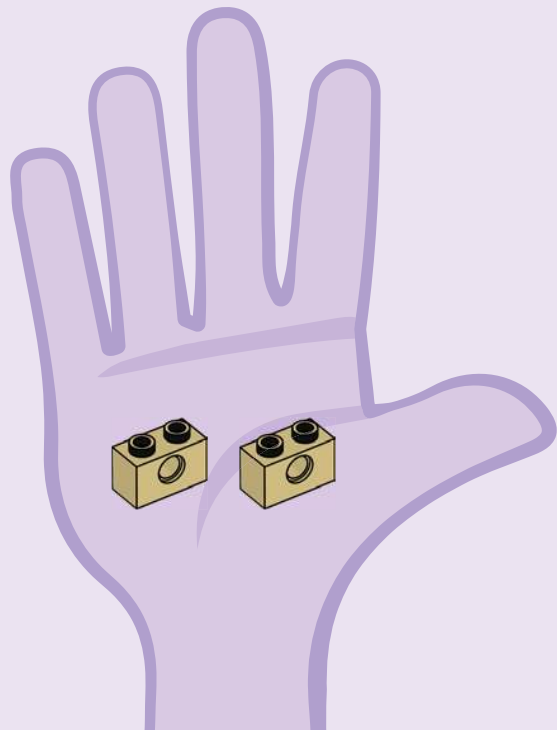
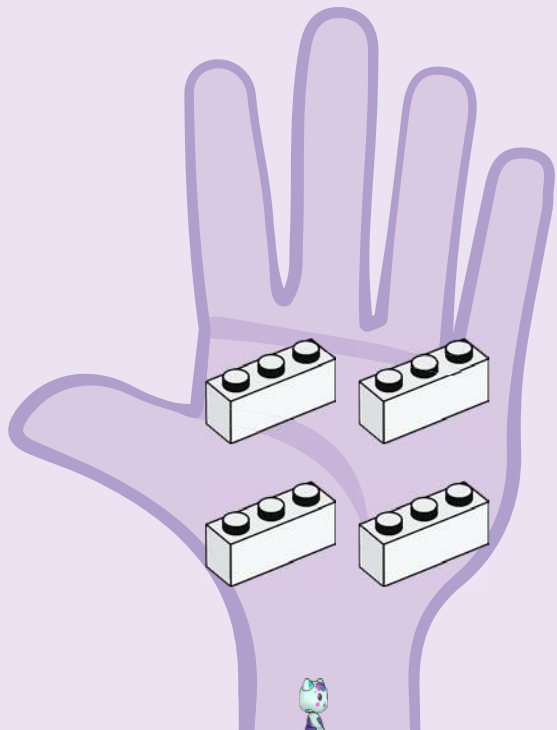

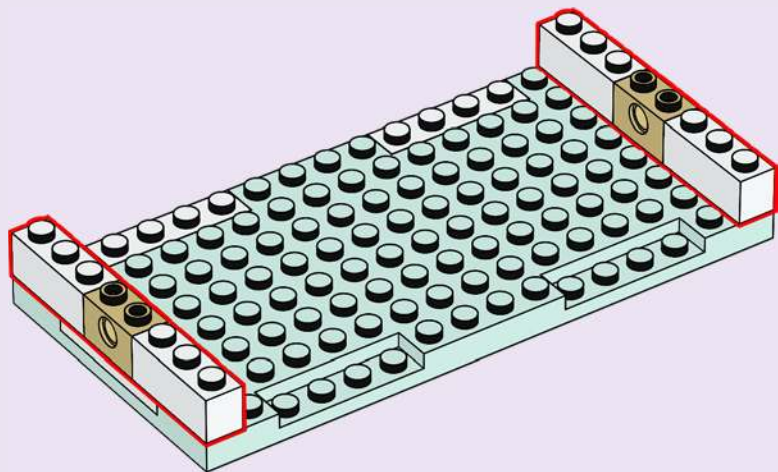

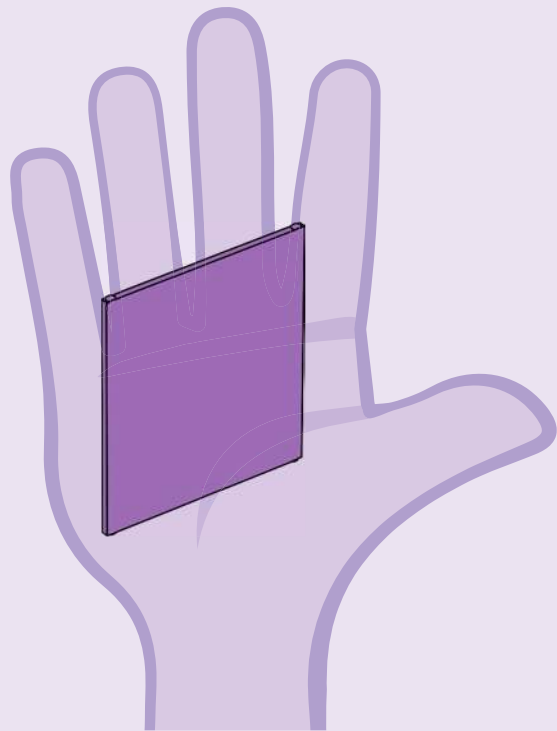
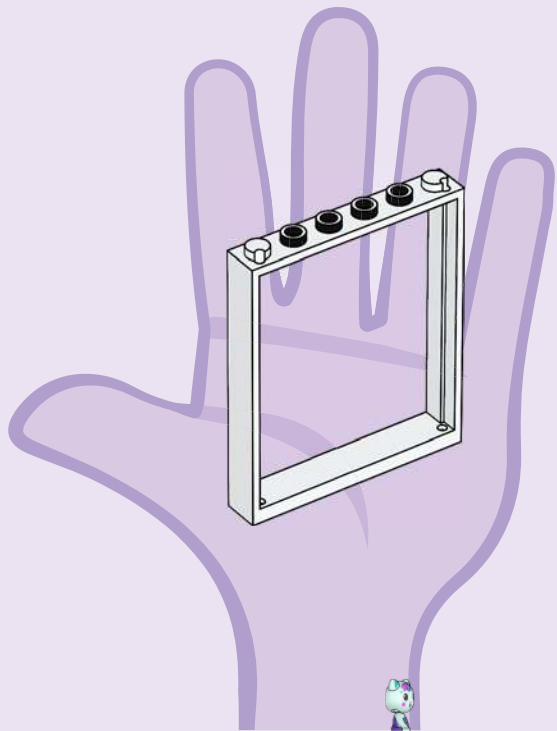

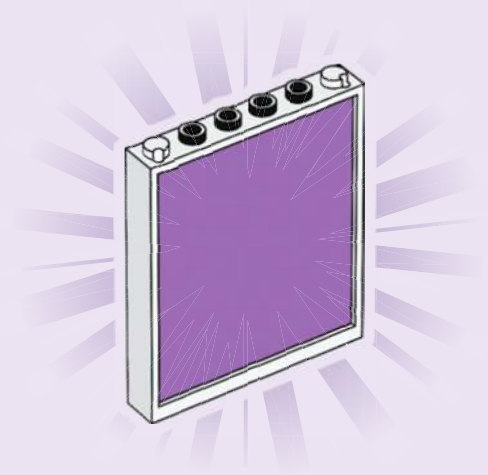
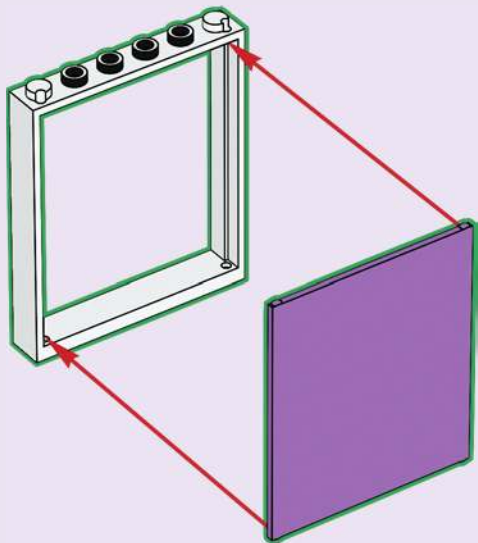

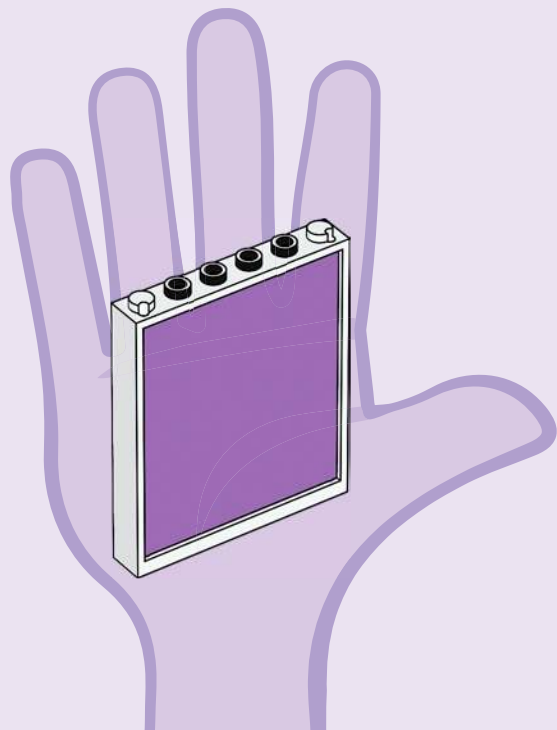

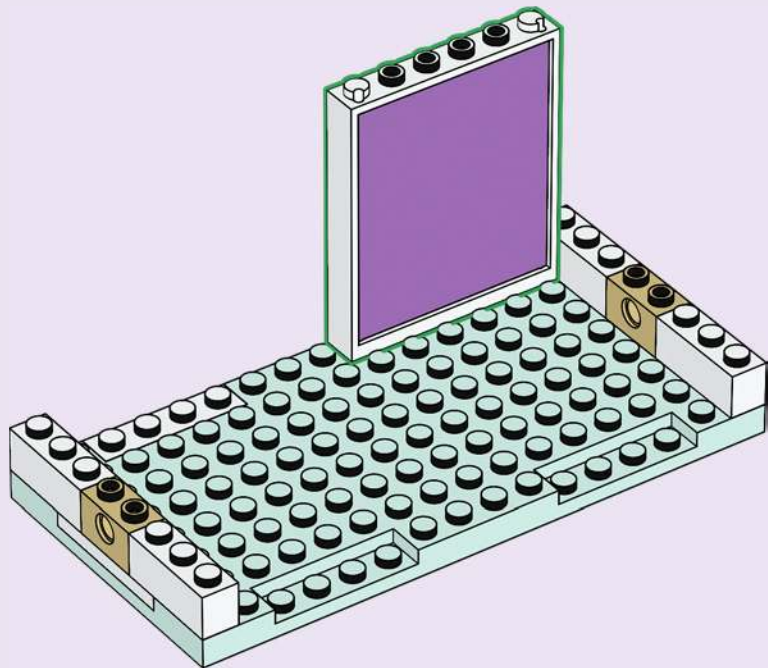

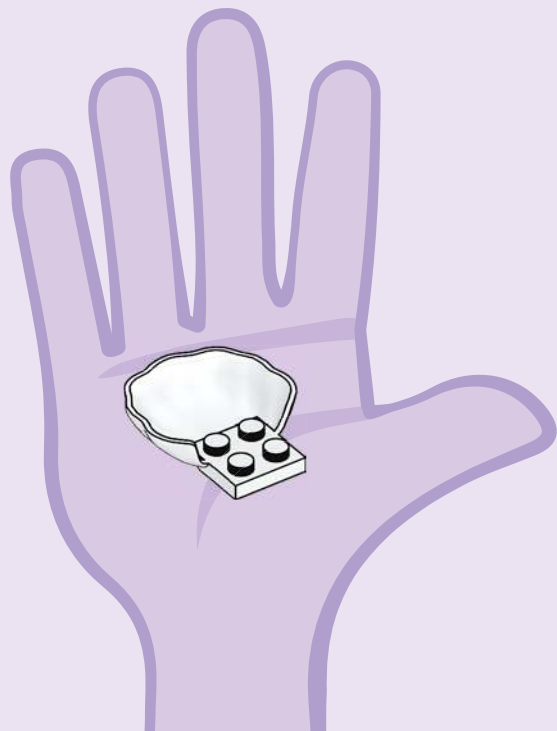
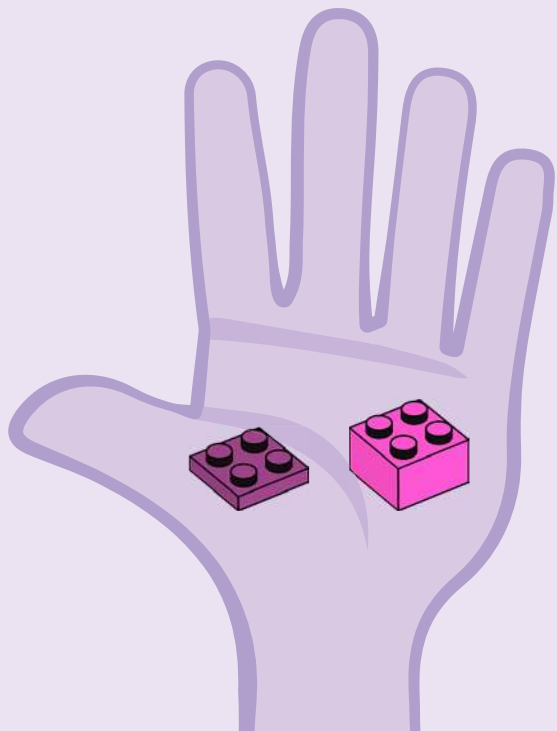

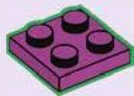

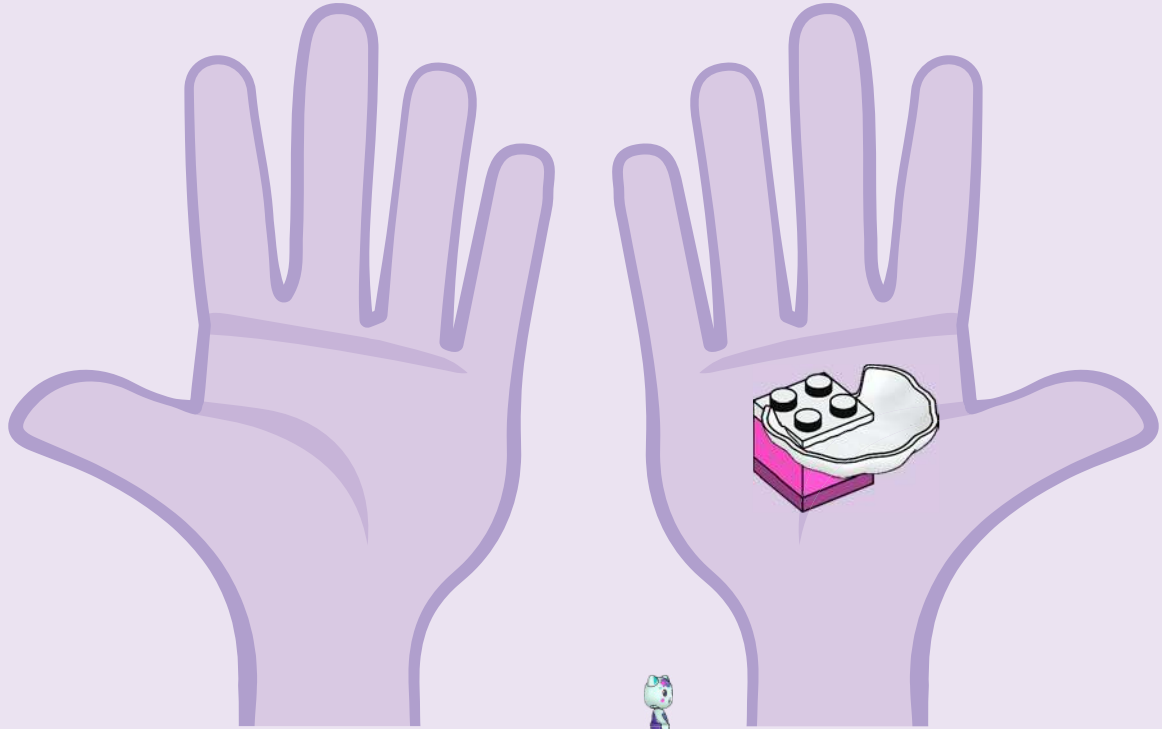

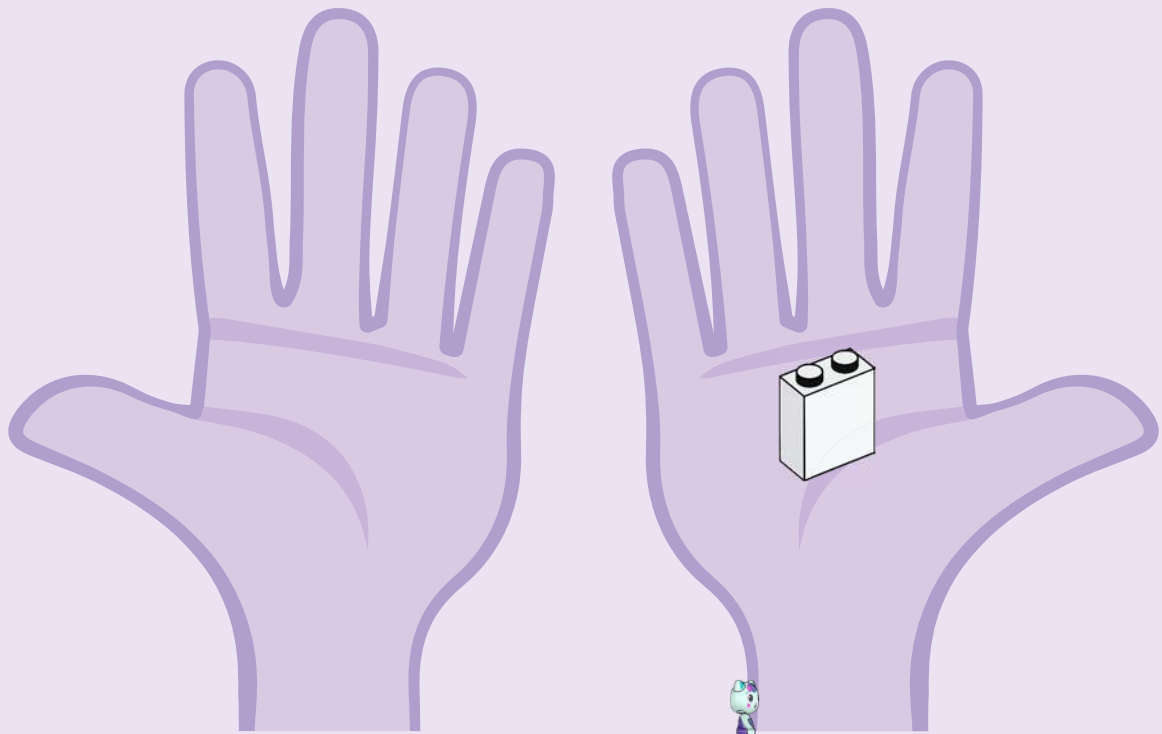

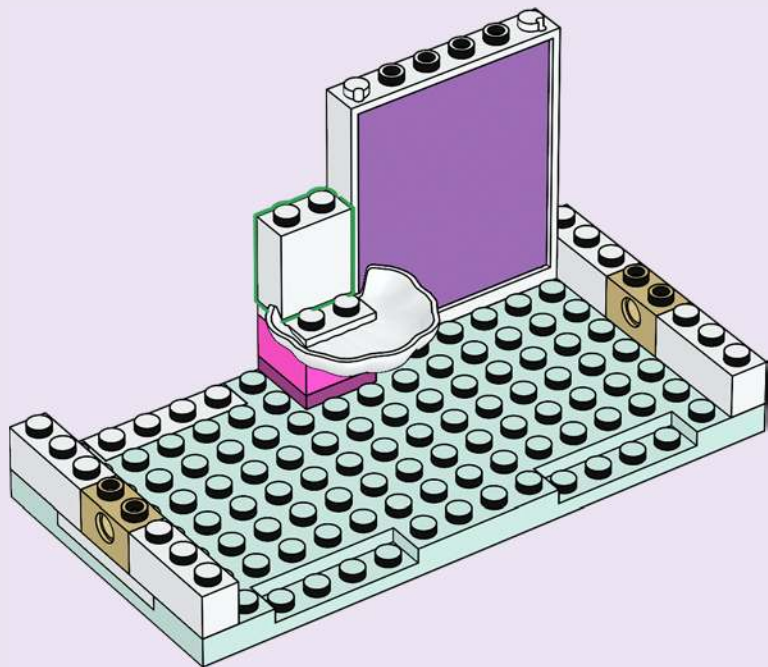

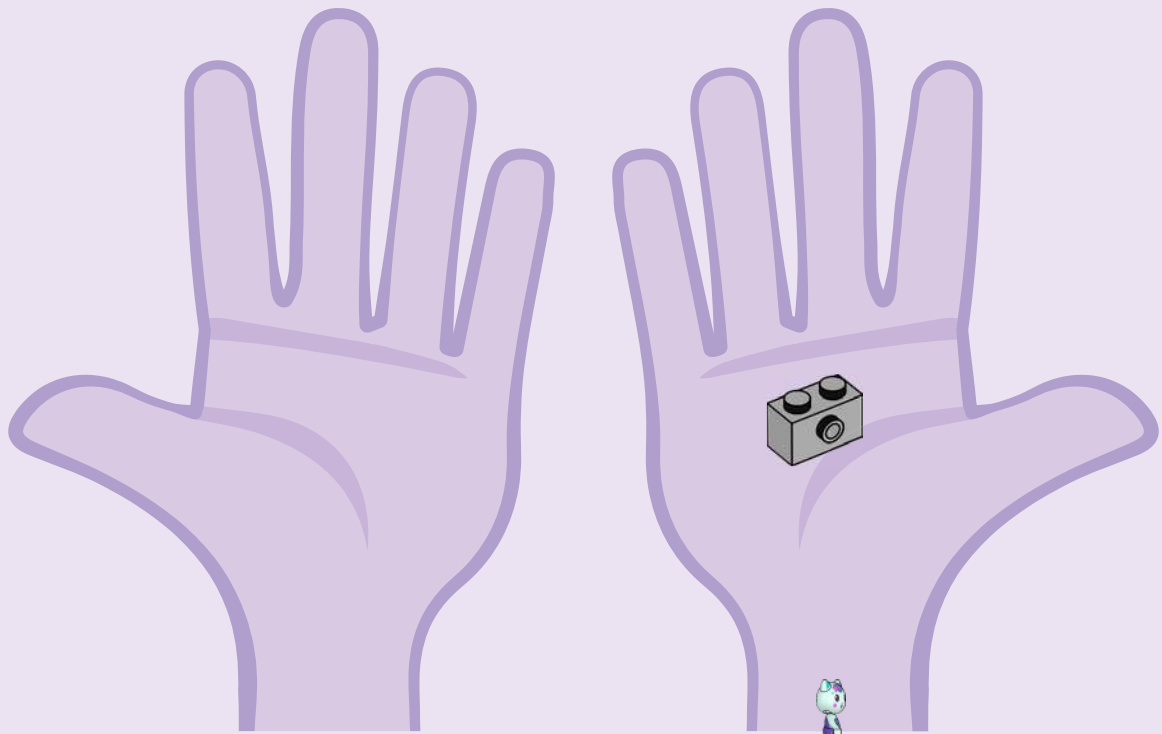

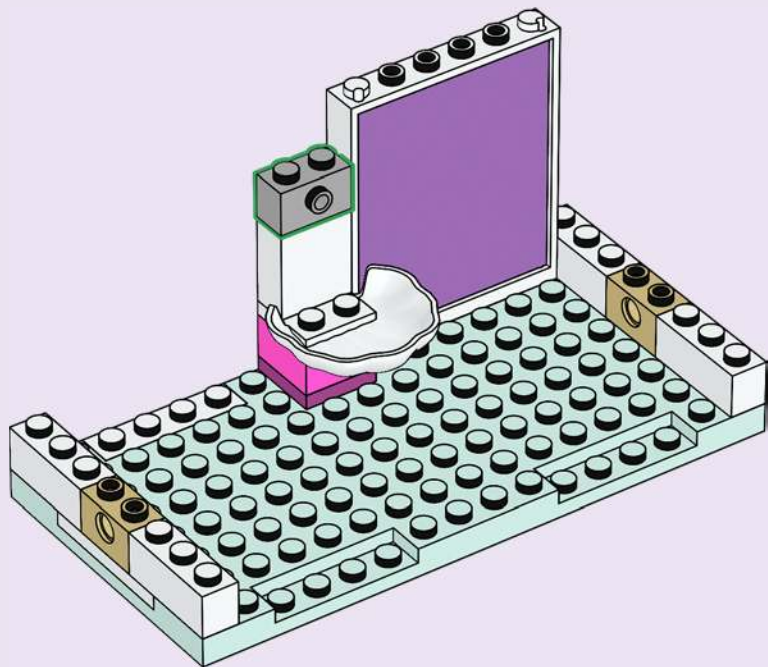

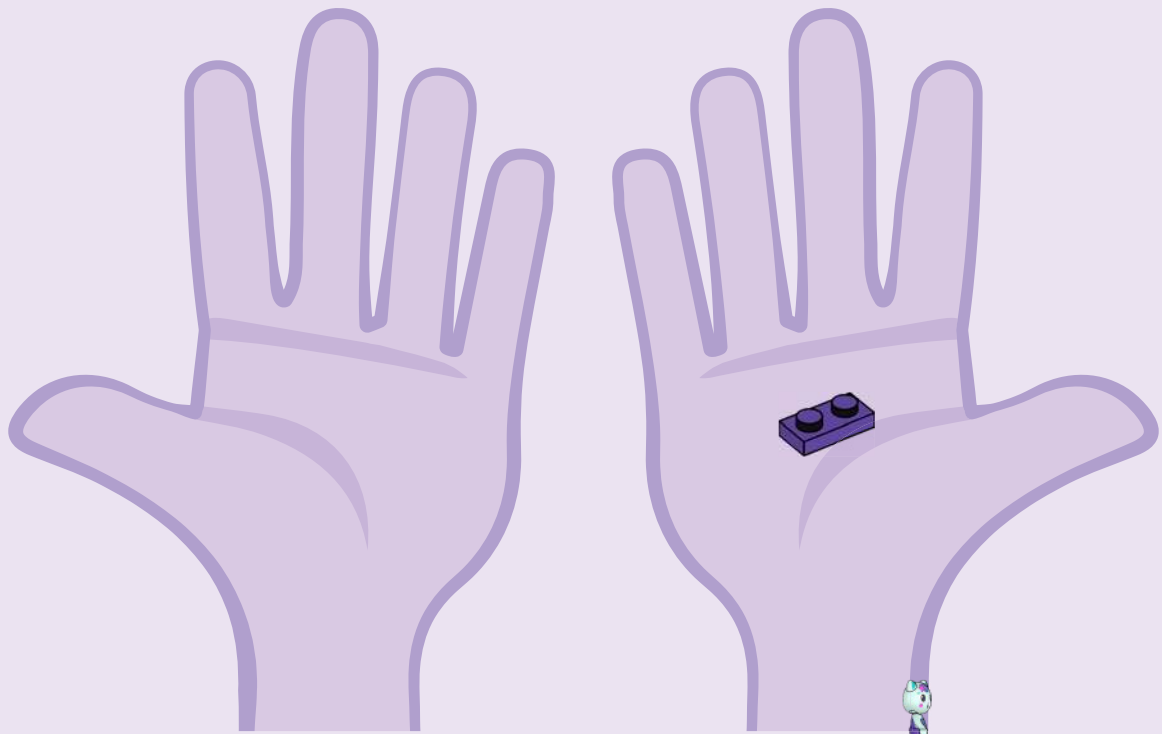

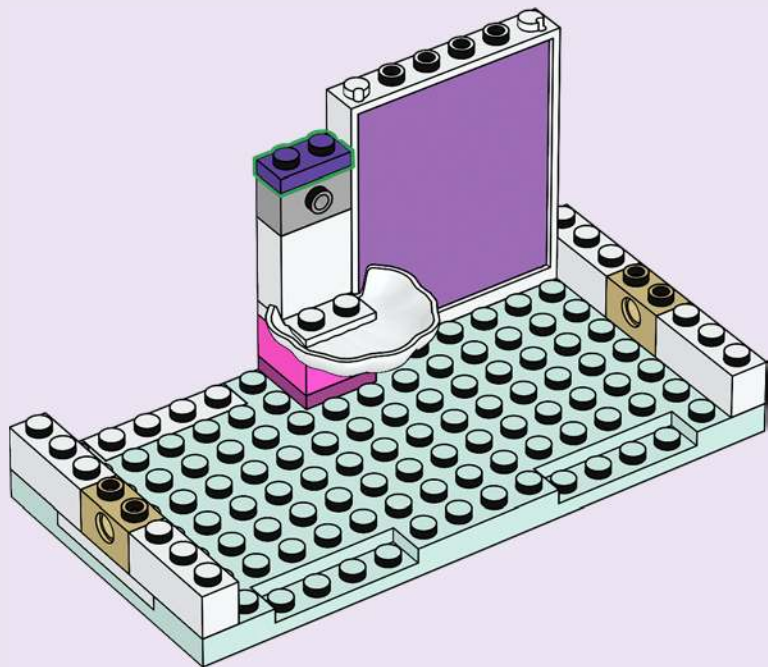

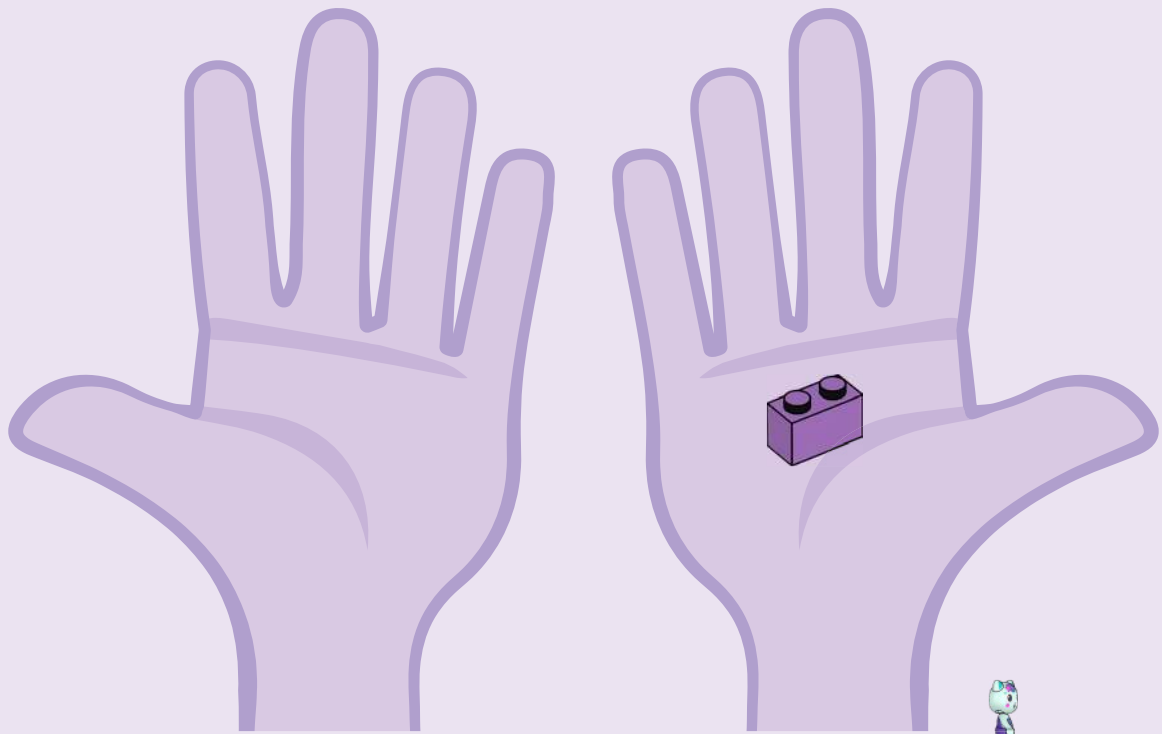

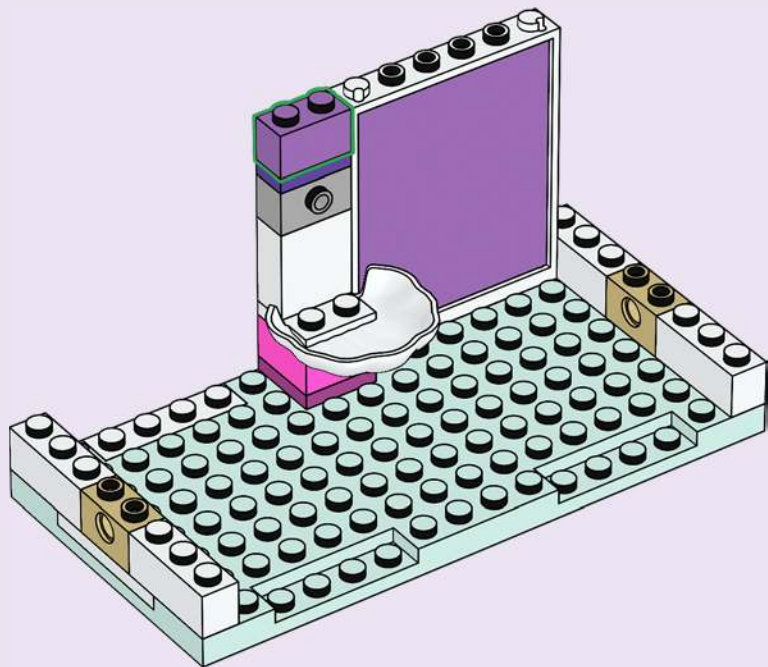

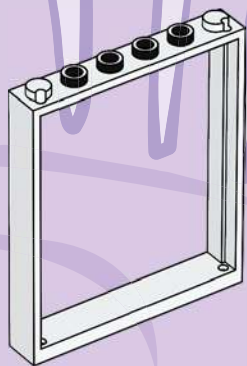

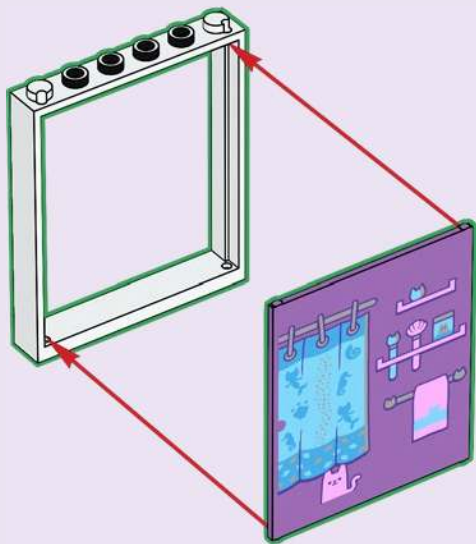

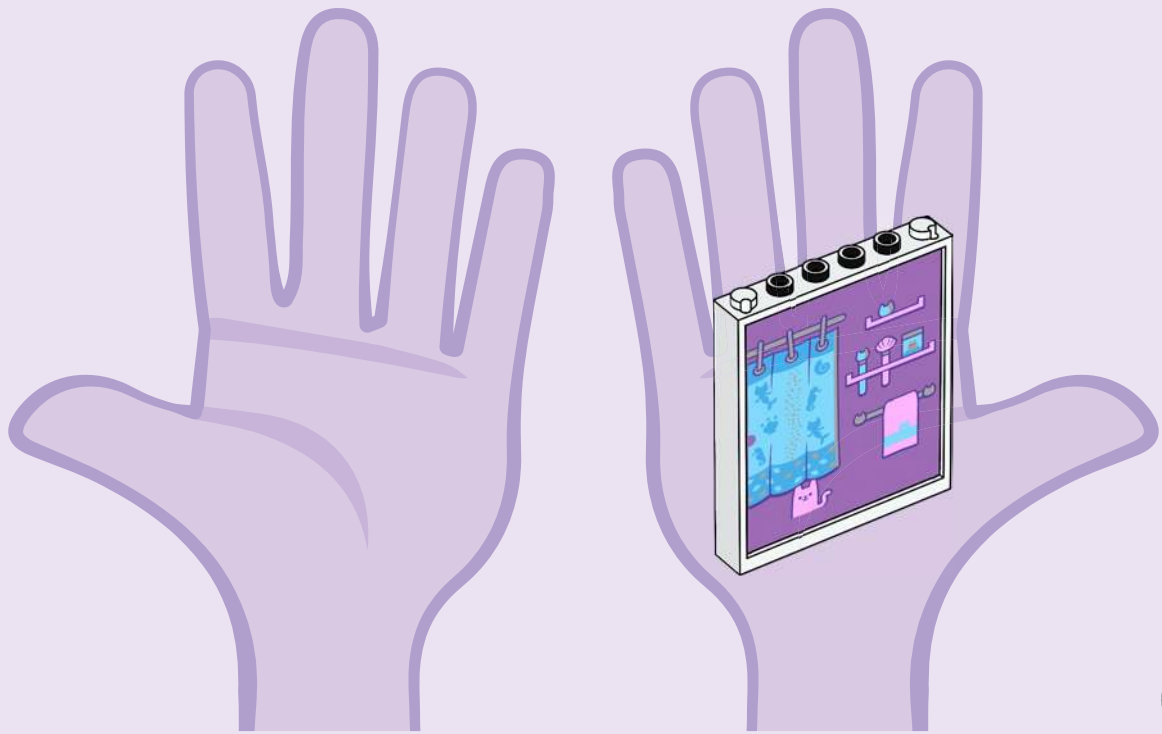

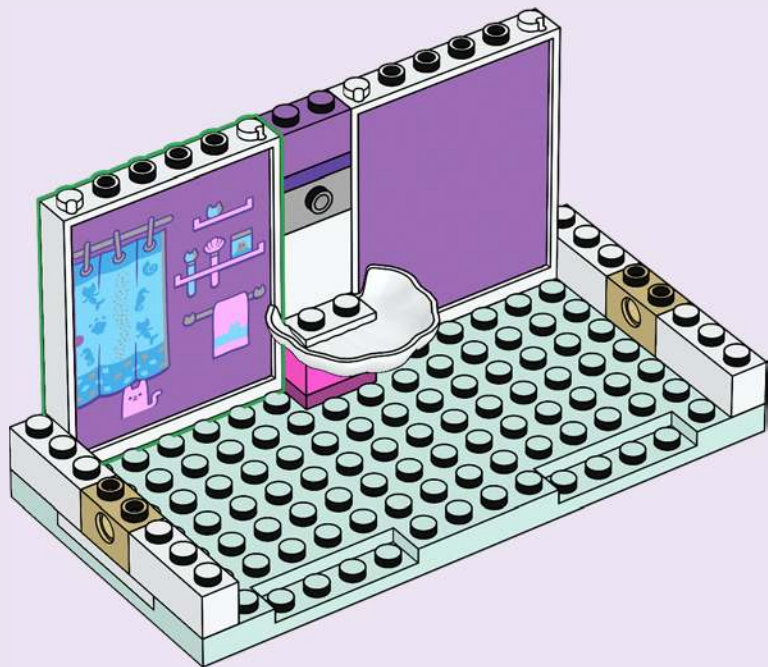

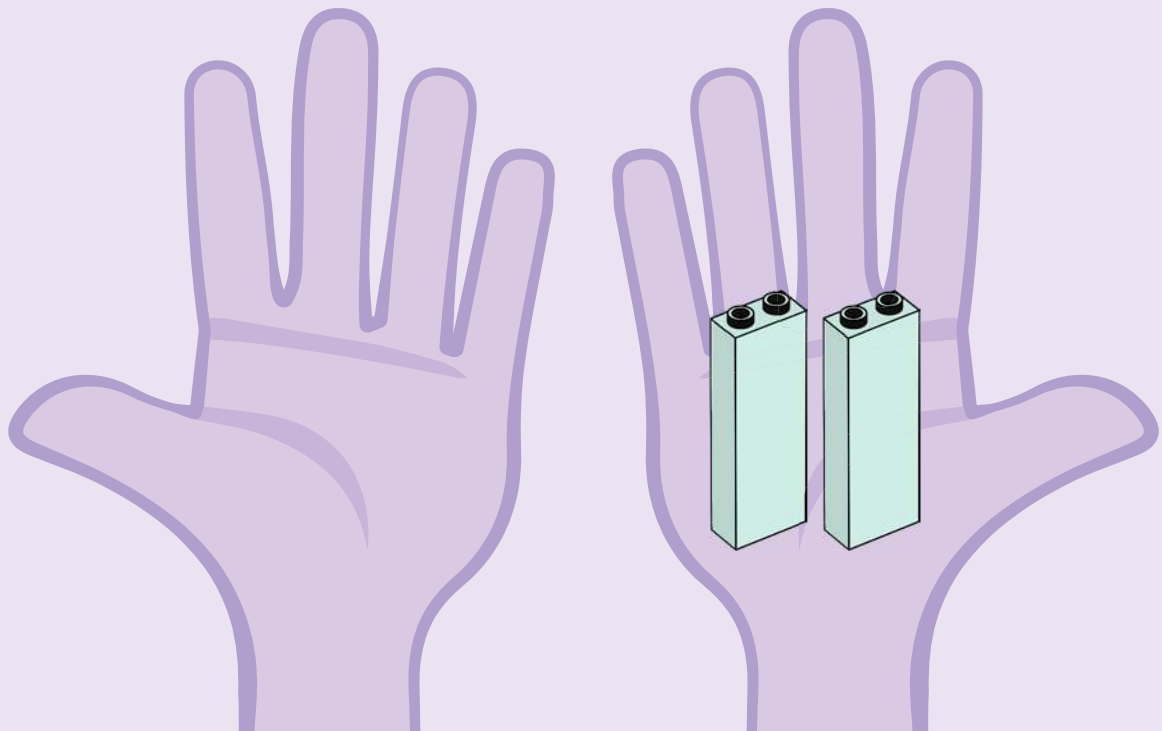

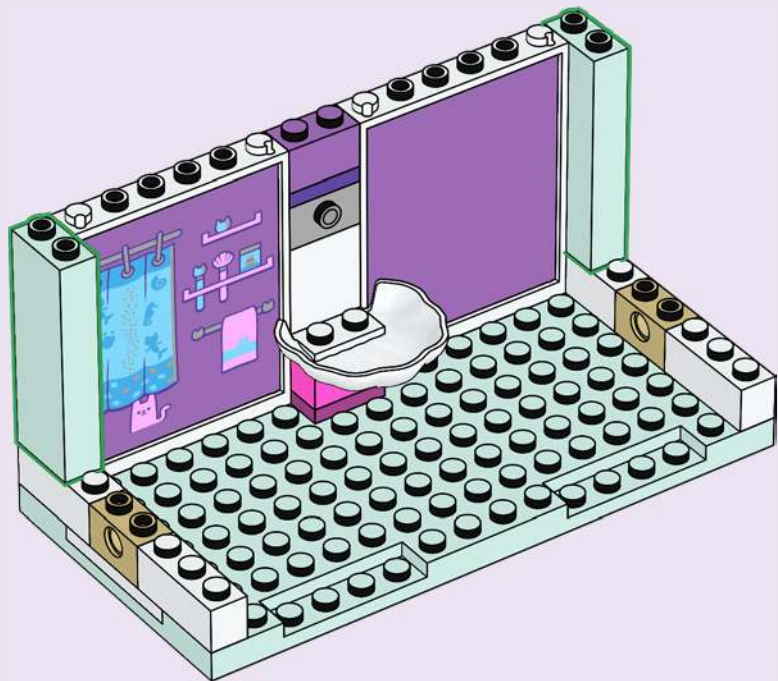

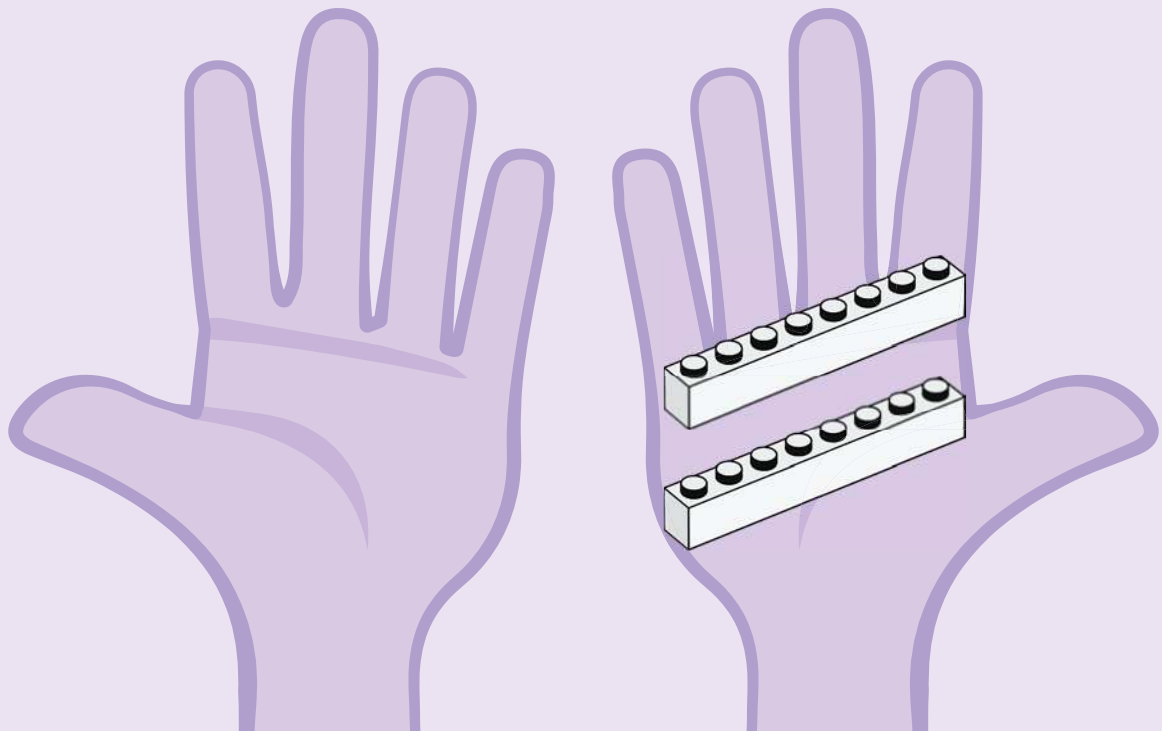

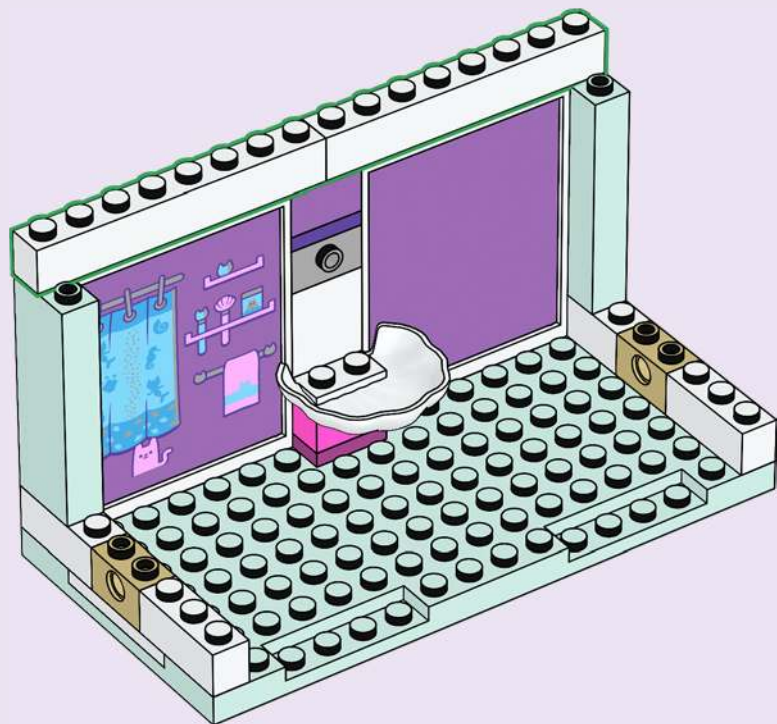

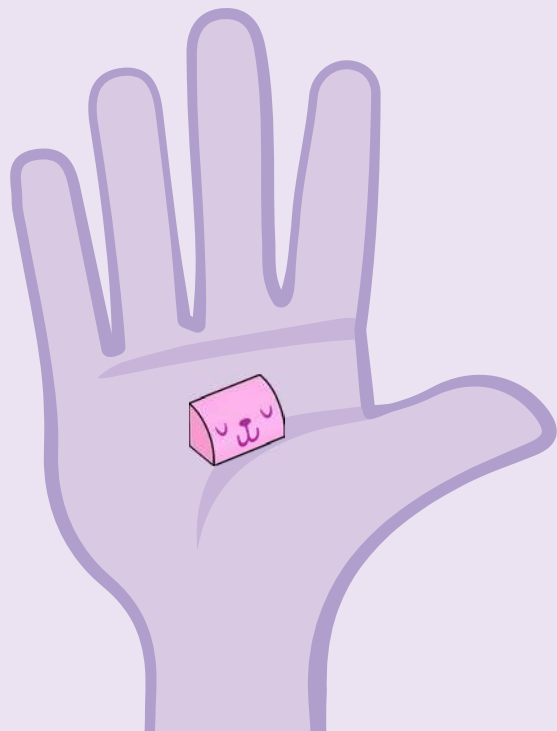
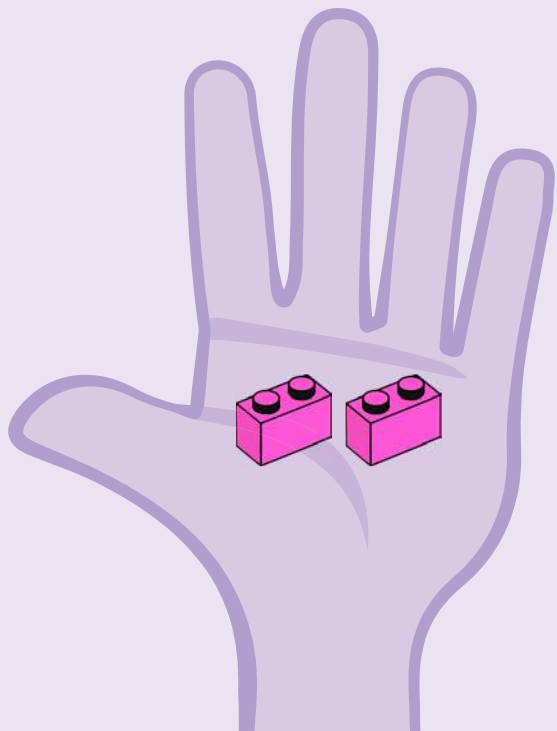

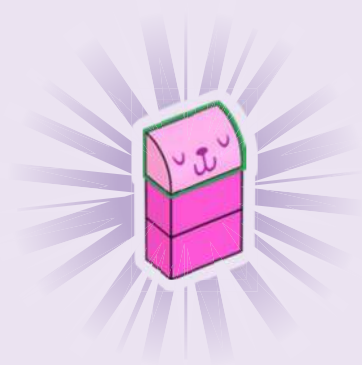

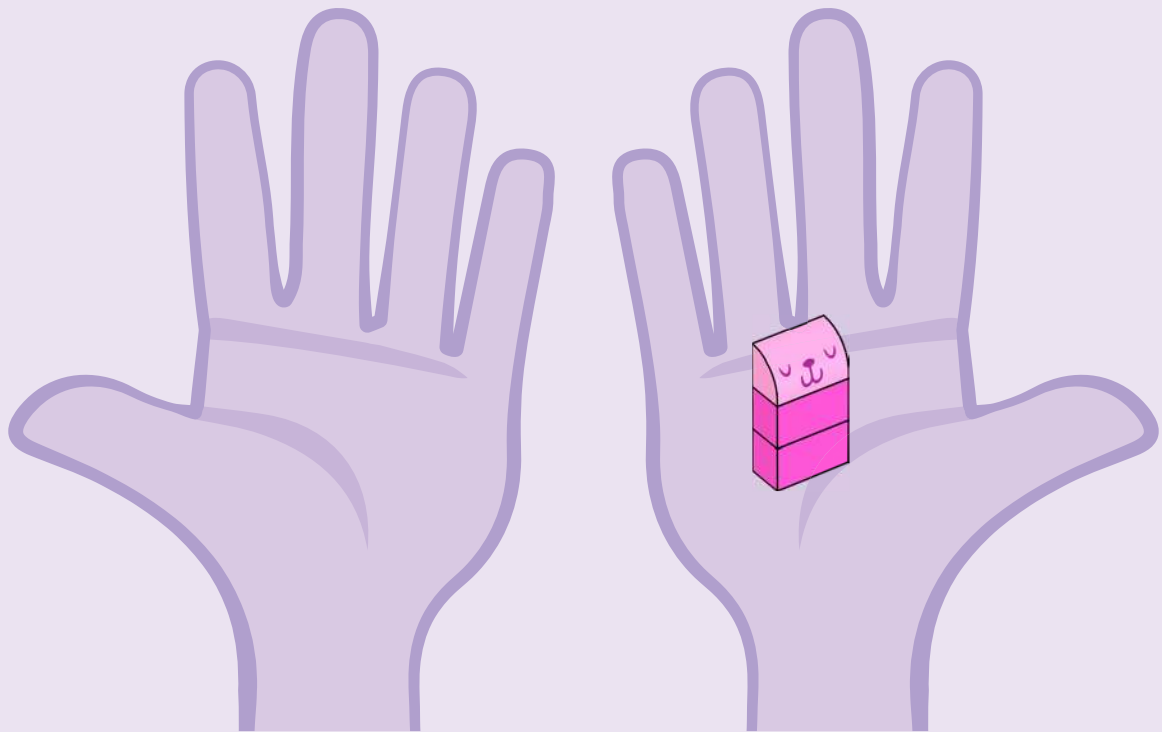

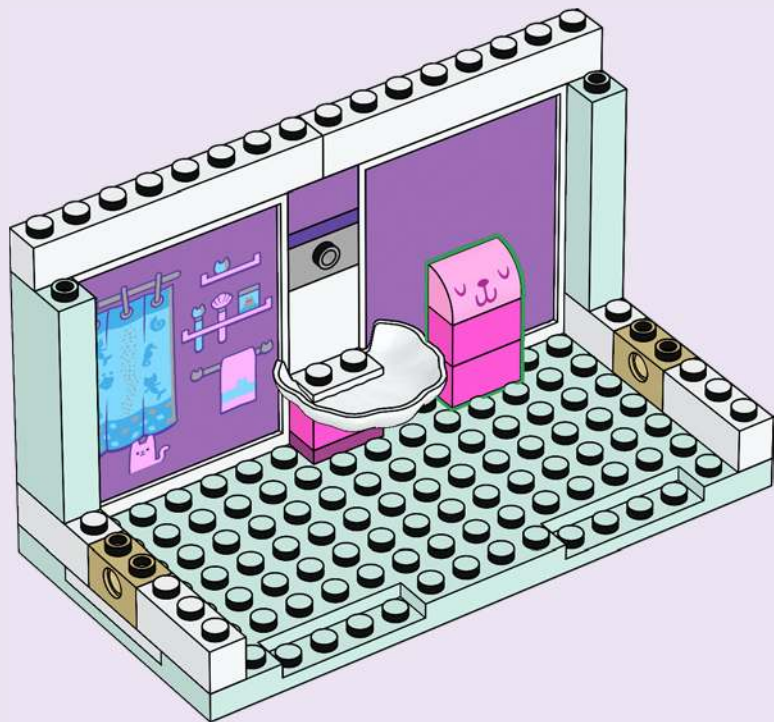

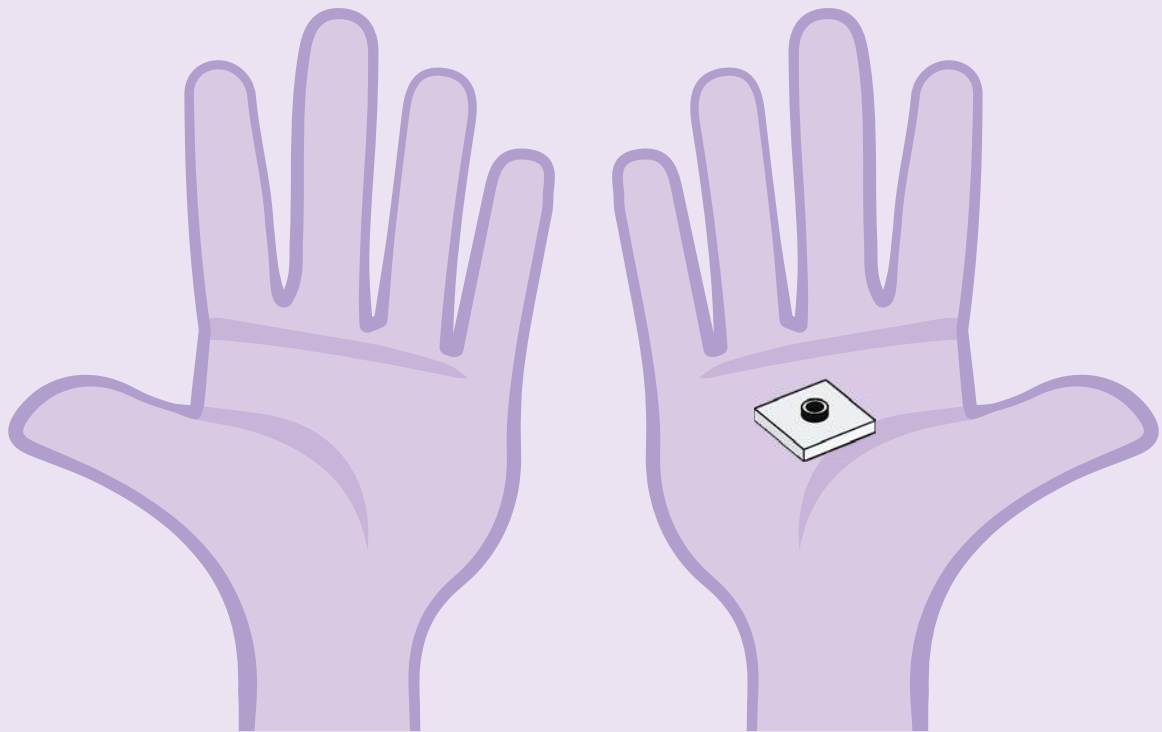

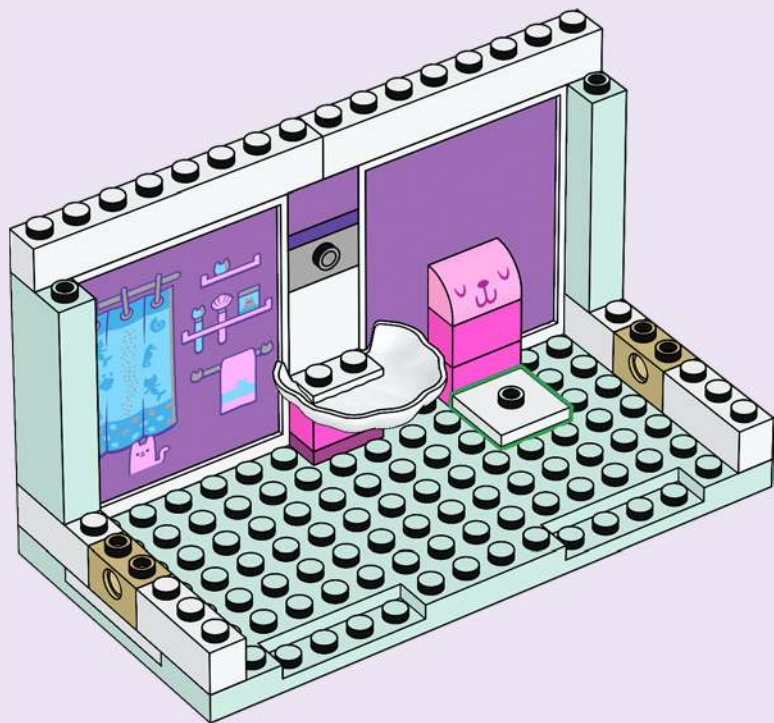

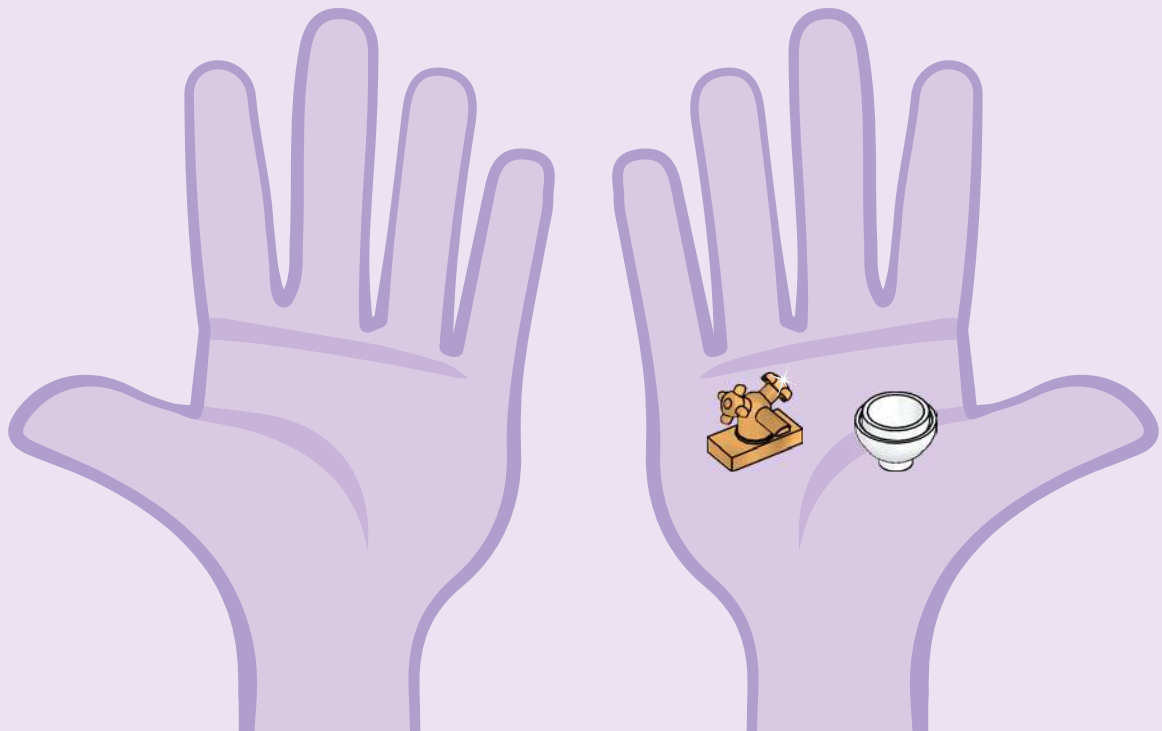



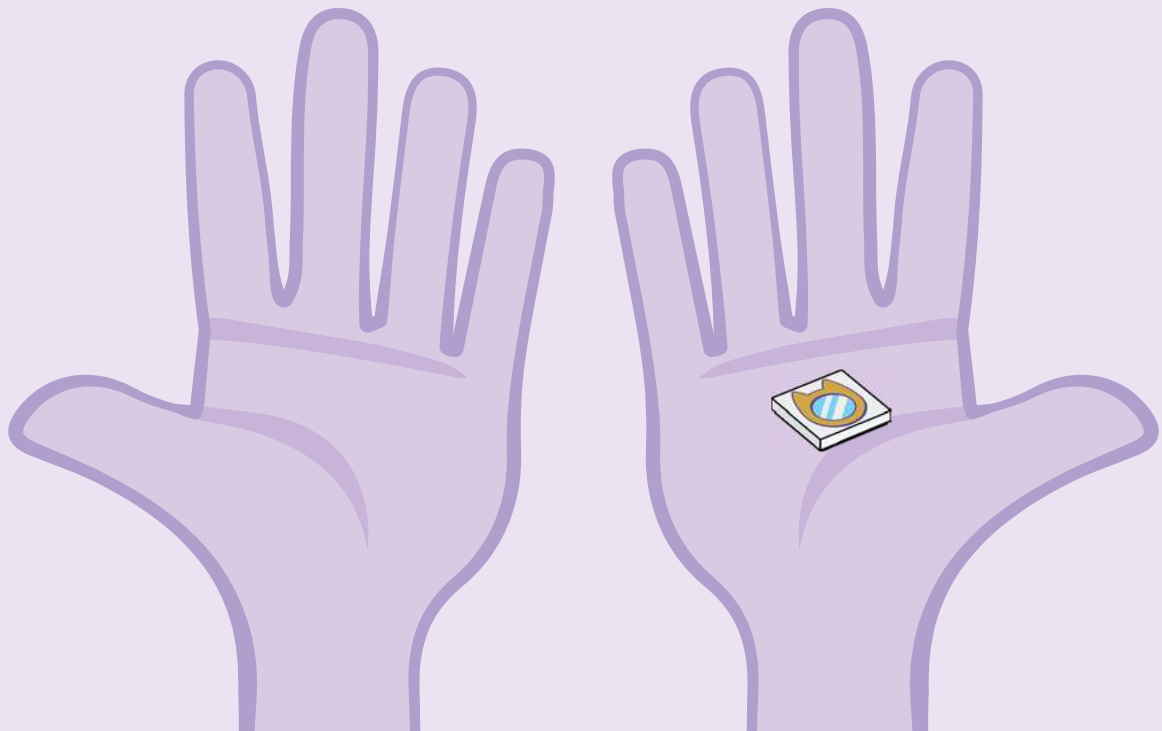



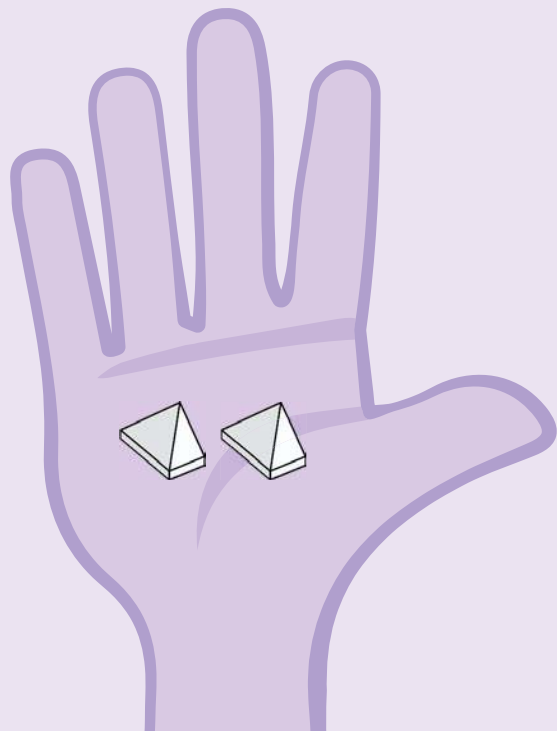
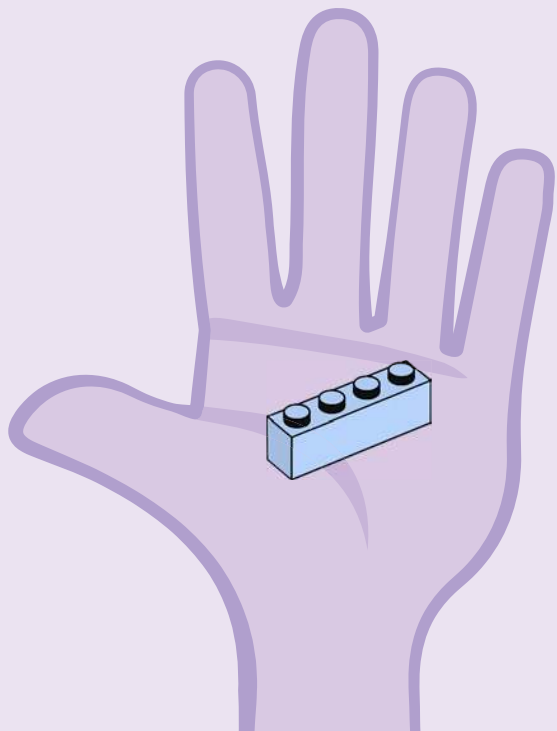

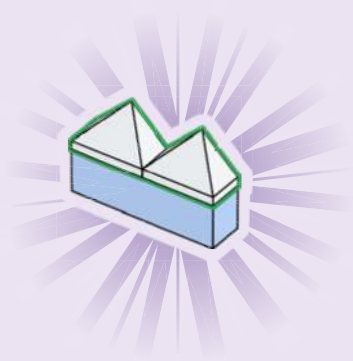
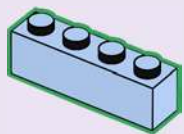

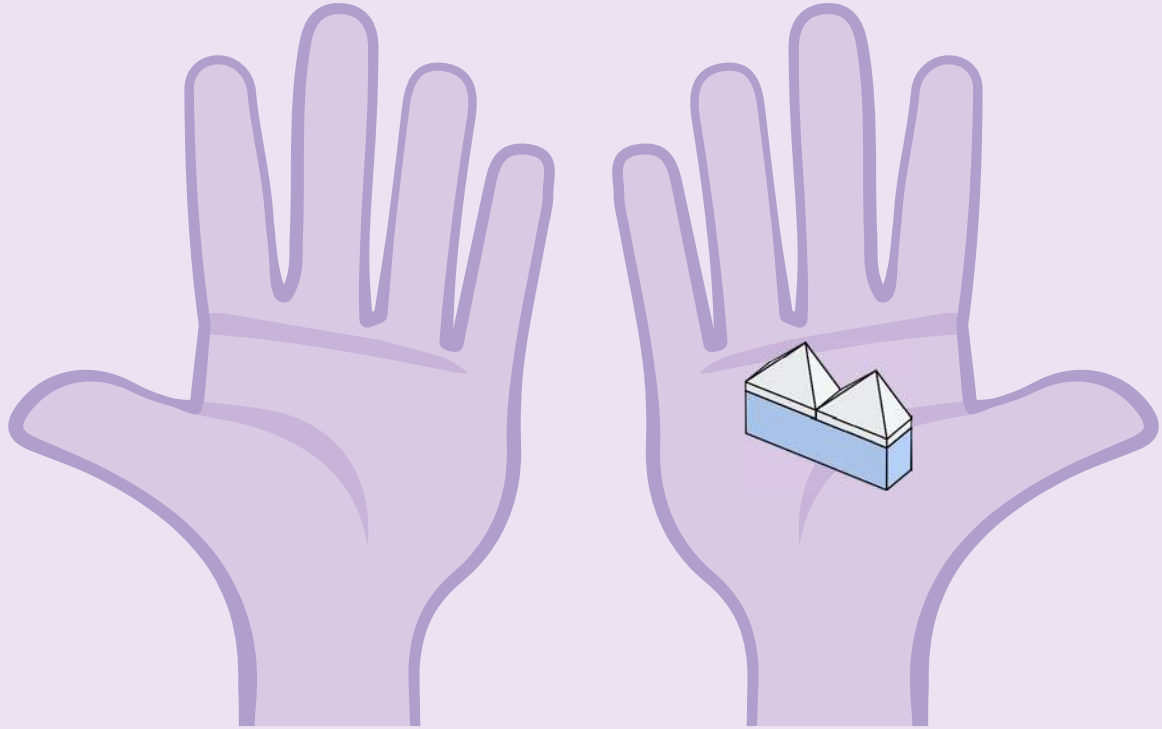



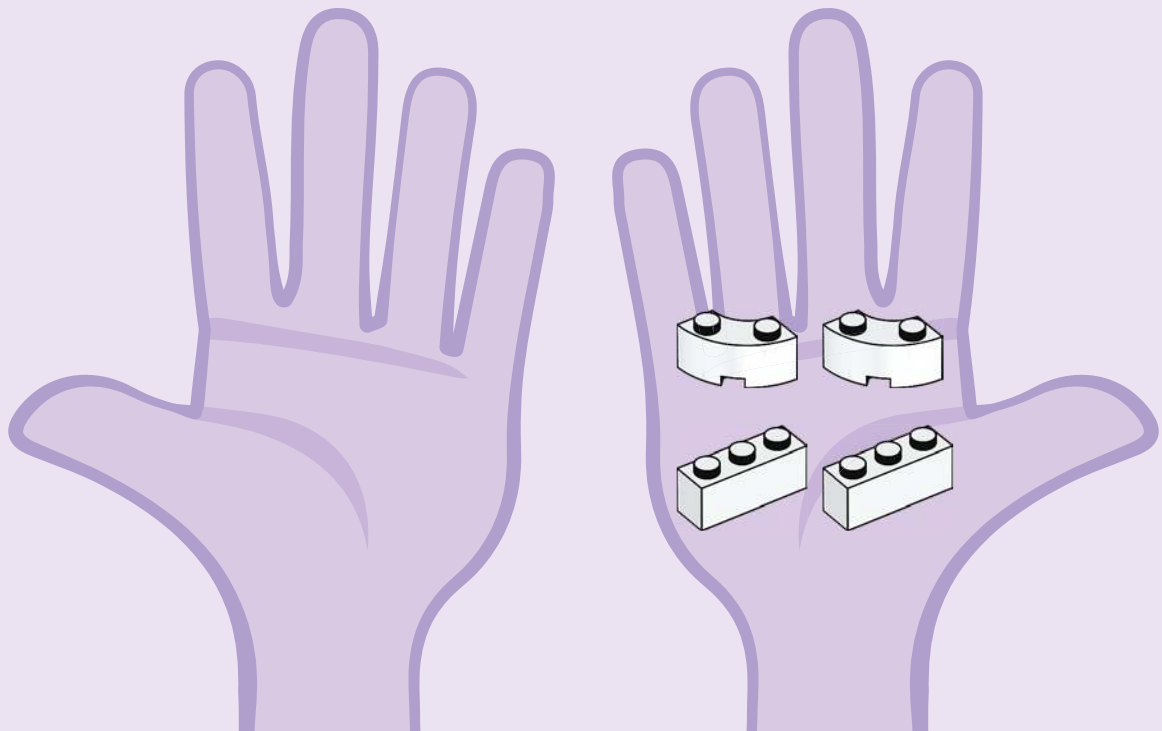



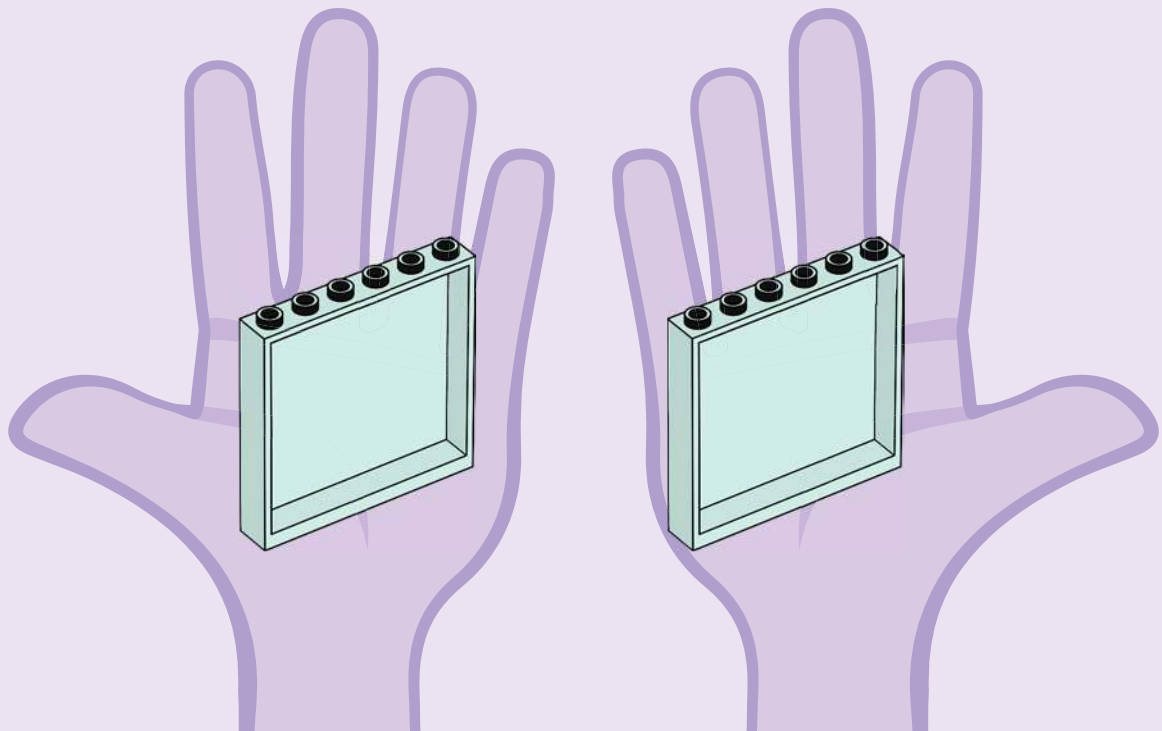



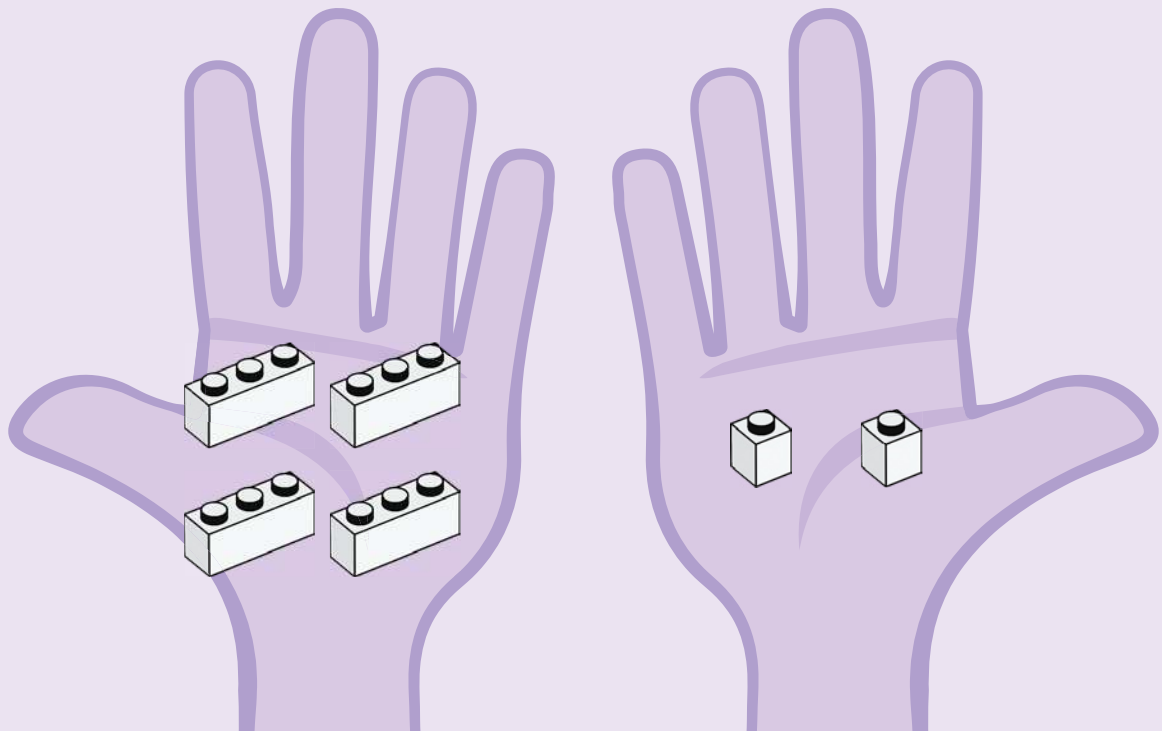



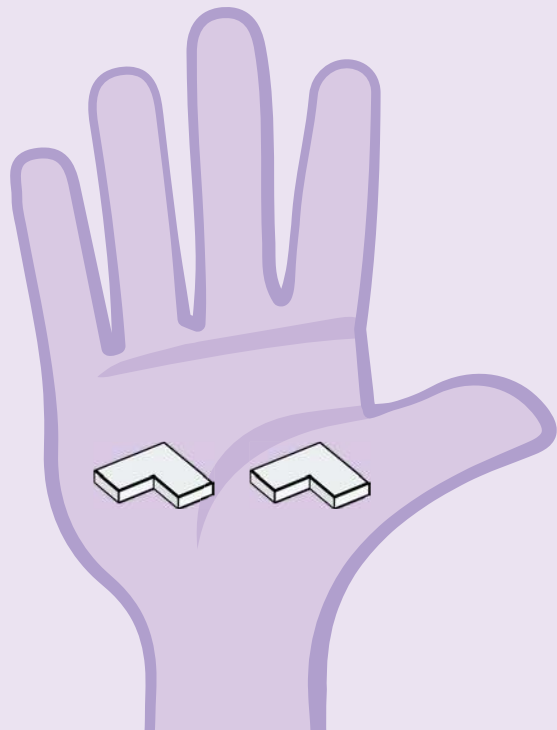
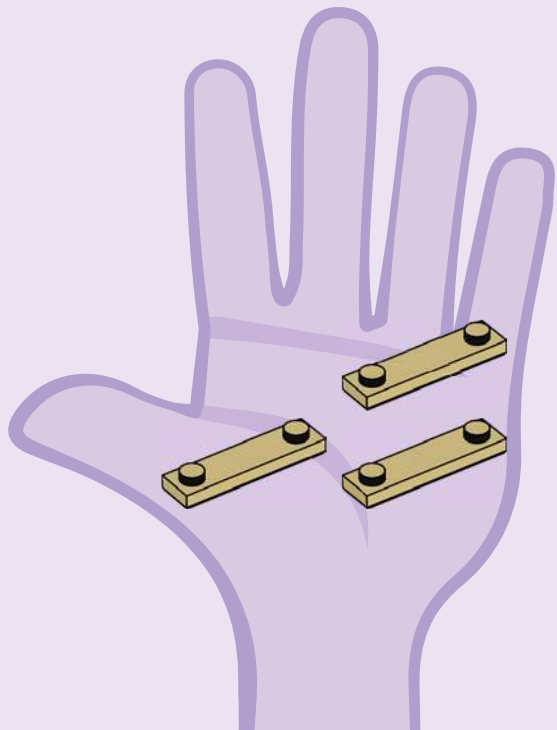



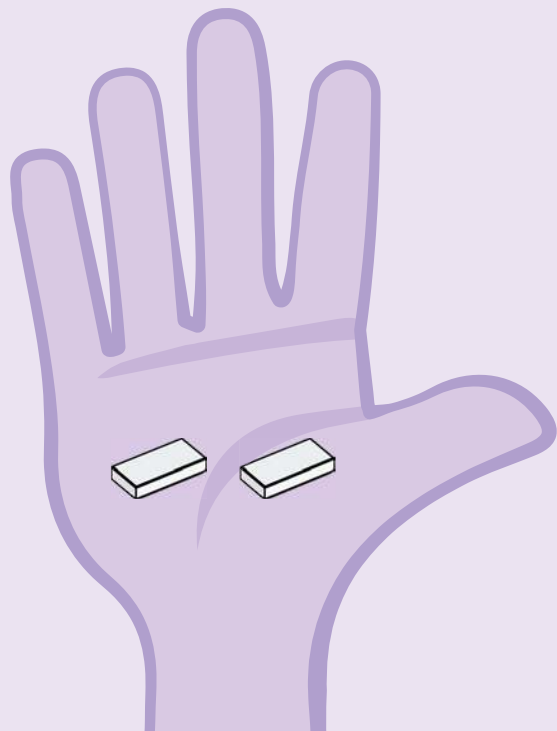
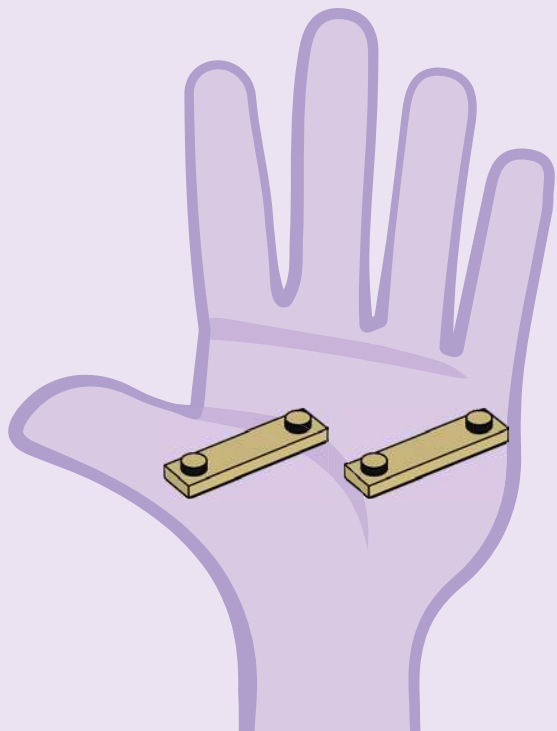













Rebuild
the
world™





DREAMWORKS GABBY'S DOLLHOUSE



10785



10786



10787



10788

4+

DreamWorks Gabby's Dollhouse © DreamWorks Animation LLC.
All rights reserved.





LEGO and the LEGO logo are trademarks of the LEGO Group. ©2023 The LEGO Group. 6473579
DreamWorks Gabby's Dollhouse © DreamWorks Animation LLC. All rights reserved.