







Booklet available in English on  
Heft in deutscher Sprache erhältlich auf  
Livret disponible en français sur  
Libretto disponibile in italiano su  
Folleto en español disponible en  
如需中文版手册, 请访问



  
FR  
**DONNEZ  
OU  
RECYCLEZ**

  
ASSOCIATION  
OU

  
MAGASIN  
OU

  
DÉCHÈTERIE

Adresses sur [quefairedemesdechets.fr](http://quefairedemesdechets.fr)



[LEGO.com/sustainable-packaging](http://LEGO.com/sustainable-packaging)

# LEGO® VIP

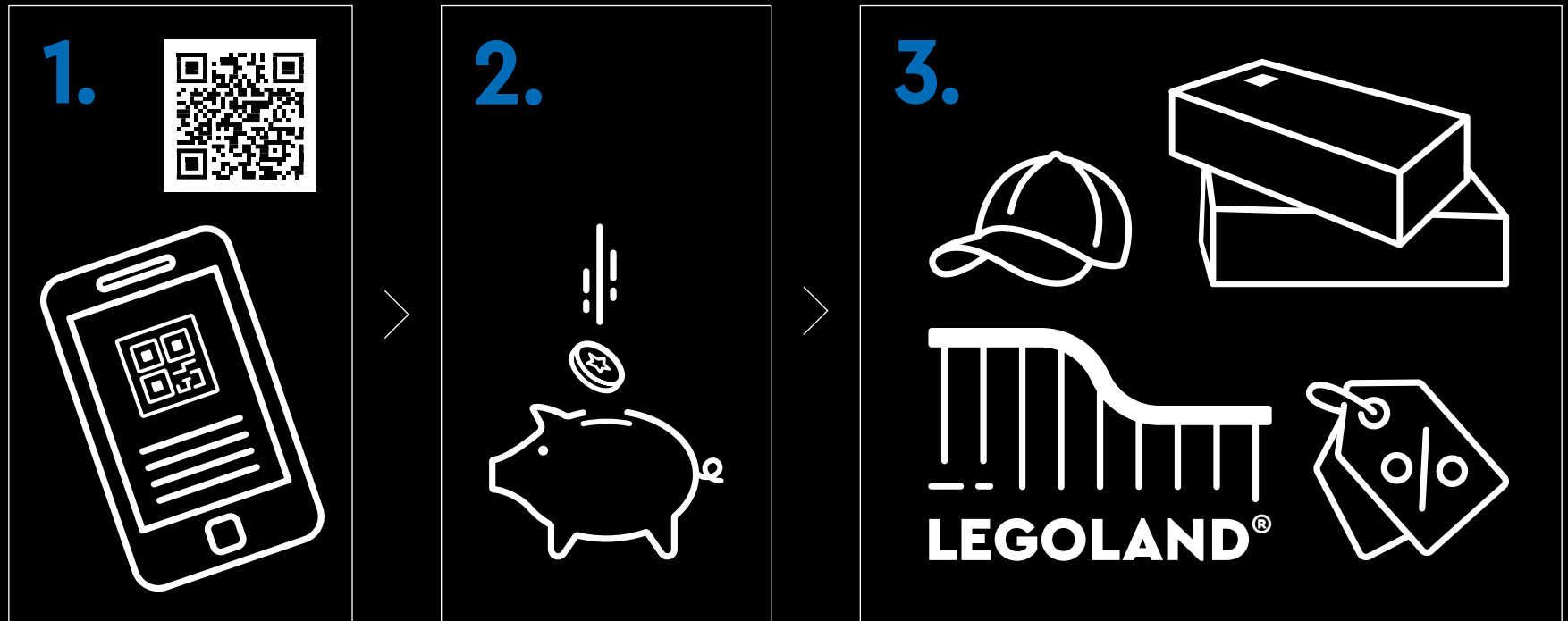

**1.** Sign up **2.** Earn points for purchases **3.** Redeem points for rewards, experiences, discounts & more | **1.** Melde dich an **2.** Sammle Punkte bei jedem Kauf **3.** Löse die Punkte für Belohnungen, Erlebnisse, Rabatte und Ähnliches ein | **1.** Inscrivez-vous **2.** Gagnez des points lors de vos achats **3.** Échangez vos points contre des récompenses, des expériences, des remises et bien plus encore | **1.** Iscriviti **2.** Guadagna punti con i tuoi acquisti **3.** Riscatta punti per premi, esperienze, sconti e altro ancora | **1.** Regístrate **2.** Gana puntos por tus compras **3.** Canjea puntos por recompensas, experiencias, descuentos y mucho más | **1.** Registe-se **2.** Ganhe pontos em compras **3.** Troque os pontos para prémios, experiências, descontos e muito mais | **1.** 注册 **2.** 购物赚积分 **3.** 用积分兑换奖励、体验、折扣等 | **1.** Zarejestruj się **2.** Zdobywaj punkty za zakupy **3.** Wymieniaj punkty na rabaty, przygody i inne nagrody | **1.** Zaregistrujte se **2.** Sbírejte body za nákupy **3.** Vyměňujte body za odměny, zážitky, slevy a spoustu dalšího | **1.** Zaregistrujte se **2.** Získavajte body za nákupy **3.** Uplatnite si body a získajte odmeny, rôzne zážitky, zľavy a ešte viac | **1.** Regisztrálj **2.** Szerezz pontokat minden vásárlással **3.** Váltsd be pontjaidat jutalmakra, élményekre, kedvezményekre és egyebekre | **1.** Înscric-te **2.** Câștigă puncte pentru achiziții **3.** Valorifică puncte pentru recompense, experiențe, reduceri și multe altele | **1.** Регистрируйте се **2.** Получайте точки за покупки **3.** Используйте точки за награды, услуги, отстъпки и т.н. | **1.** Reģistrējies **2.** Pelni punktus par pirkumiem **3.** Izmanto punktus, lai saņemtu balvas, izklaides iespējas, atlaides un daudz ko citu | **1.** Registreeru **2.** Teeni ostude eest punkte **3.** Lunasta punktide eest preemiad, elamused, allahindlused ja muu | **1.** Užsiregistruokite **2.** Pelnykite taškus už pirkinius **3.** Panaudokite taškus atlygiui, funkcijoms, nuolaidoms ir ne tik







# 姫路城

## HIMEJI CASTLE / THE CASTLE OF THE WHITE HERON

🌸 Majestically overlooking the Japanese city of Himeji, the breath-taking Himeji Castle is an architectural gem on UNESCO's World Heritage list. First built as a fortress in 1333, towards the end of an era of civil wars, the castle has undergone several transformations over the centuries. In 1600 a major reconstruction began, resulting in the current structure which has been preserved in its integrity until today, initially by feudal masters and later by the Japanese government. Mazes of intricate pathways once designed to confuse and trap enemies now weave an intriguing journey for visitors. Through wars, earthquakes, fires and times of peace, the Castle of the White Heron stands as a serene monument to Japanese culture. Discover the intricate details of the Main Keep and the history of the castle as you build.

---

**CHRIS MCVEIGH**  
*LEGO® Senior Designer*

## A TRIBUTE TO A REVERED LANDMARK

🍷 '2023 marks the 30<sup>th</sup> anniversary of Himeji Castle's inscription to UNESCO's World Heritage list, and its architecture and history are still like a mystery to decode. We created the Main Keep as a natural focal point and played with proportions and scales to make it stand out. If you have visited the castle you may recognise some of the interiors, and if you haven't seen it in person, we hope it sparks your imagination and curiosity.'



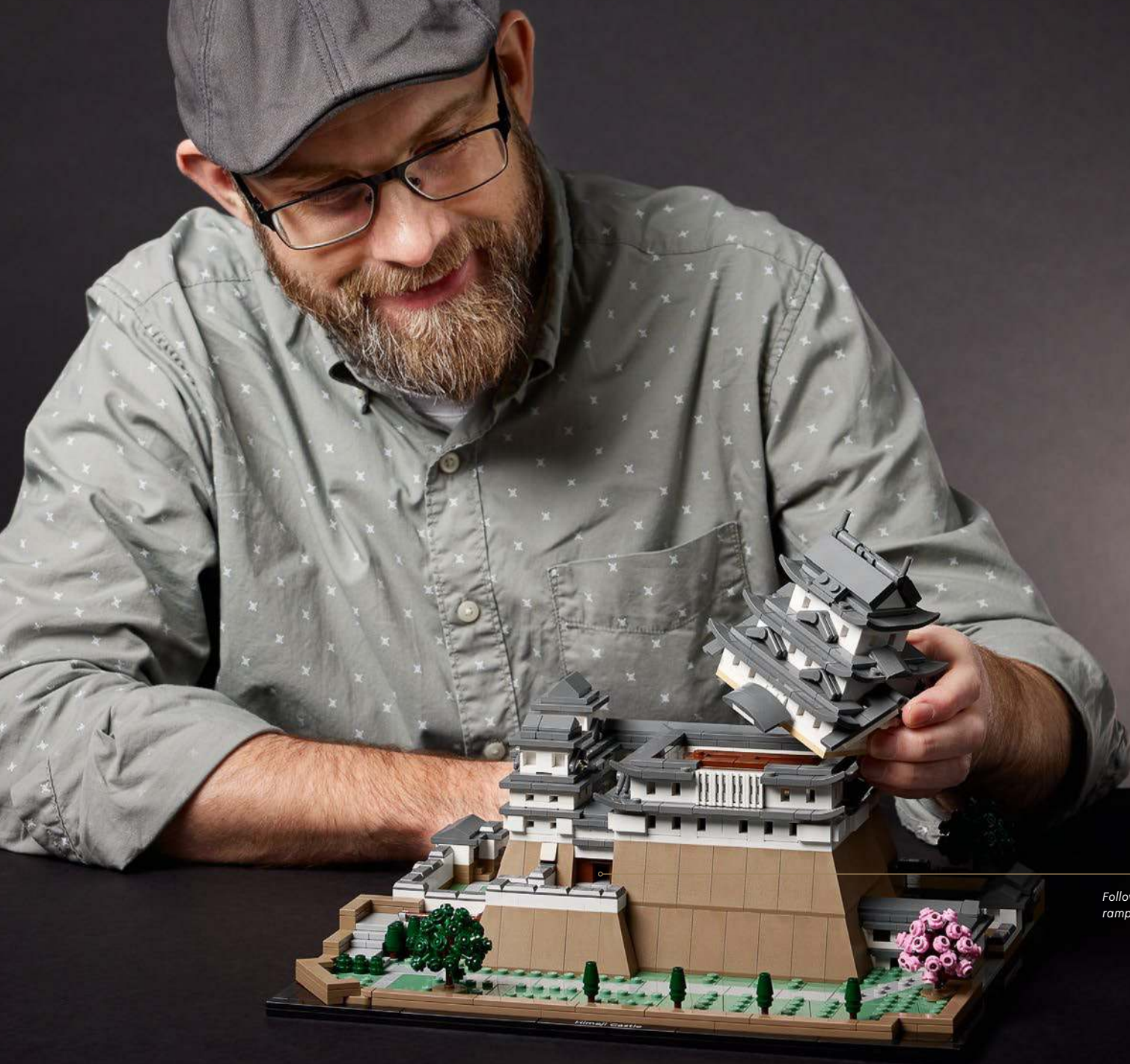

*Follow some of the intricate pathways, ramps and stairways through the castle.*



## AN OPTICAL ILLUSION

🌸 Himeji Castle's roofing method uses interlocking black rectangular and semi-circular tiles. Several layers of white clay line the tiles, giving the roofing a high-contrast, mesh-like appearance up close. However, at a distance, the mesh pattern appears grey. The roof tiles in this set are *Dark Stone Grey* to reflect the aging of the tiles.



*Peek inside after the model is built.*



*Each tower is constructed differently - even their heights.*

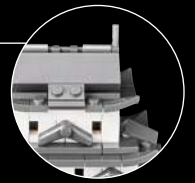

*A mesh of black tiles and white clay makes the roof appear grey from a distance.*



*Each layer or floor in the Main Keep evokes the actual structure of the castle.*



*Irregular angles are predominant throughout the castle and walls.*



*Decorate the cherry trees with pink blossoms or green leaves.*



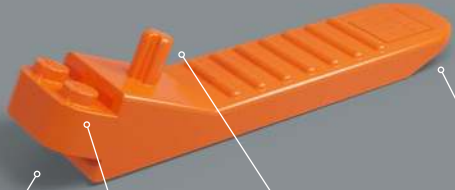

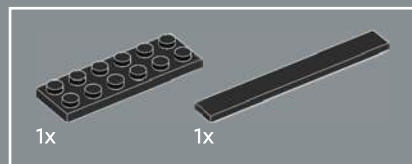

1

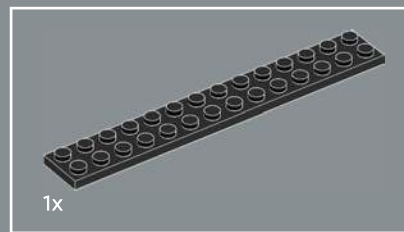
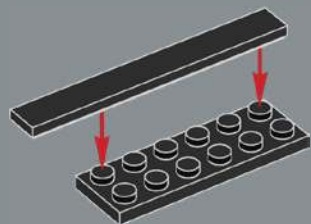

2

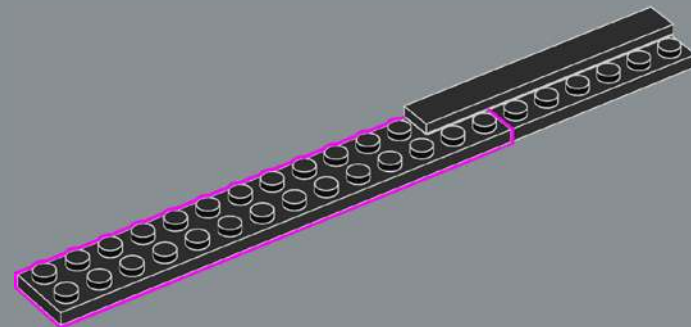

3

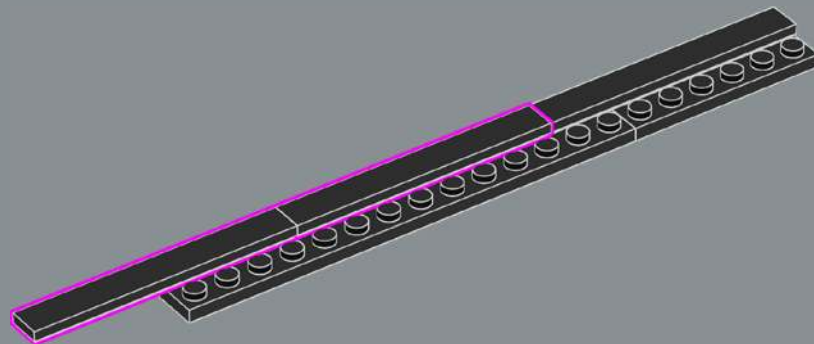

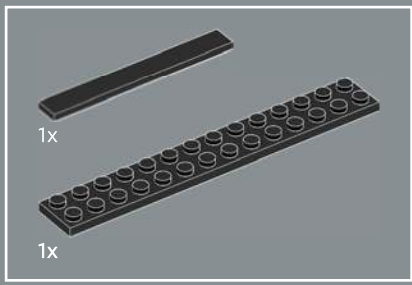

4

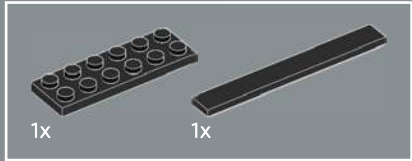
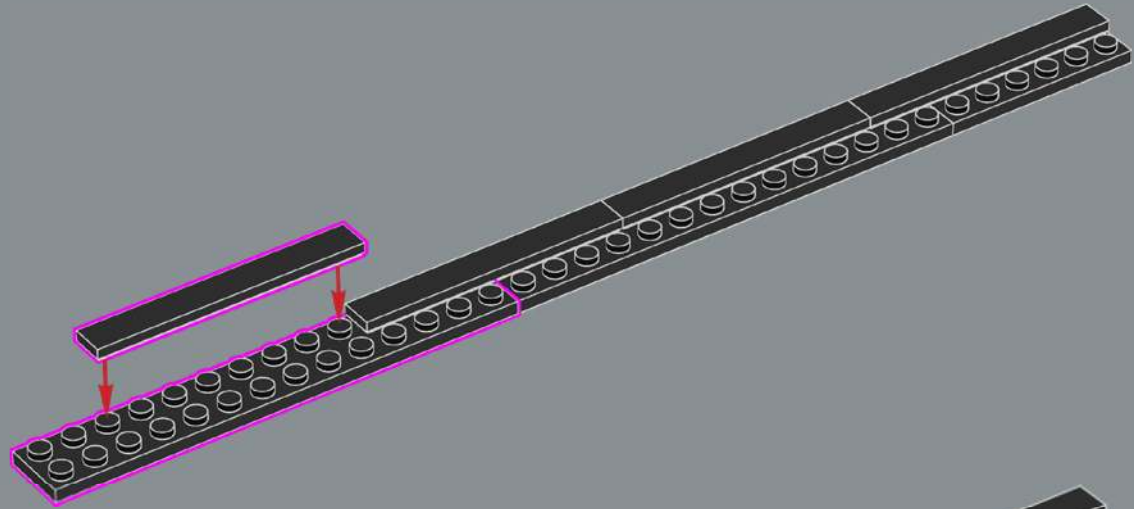

5

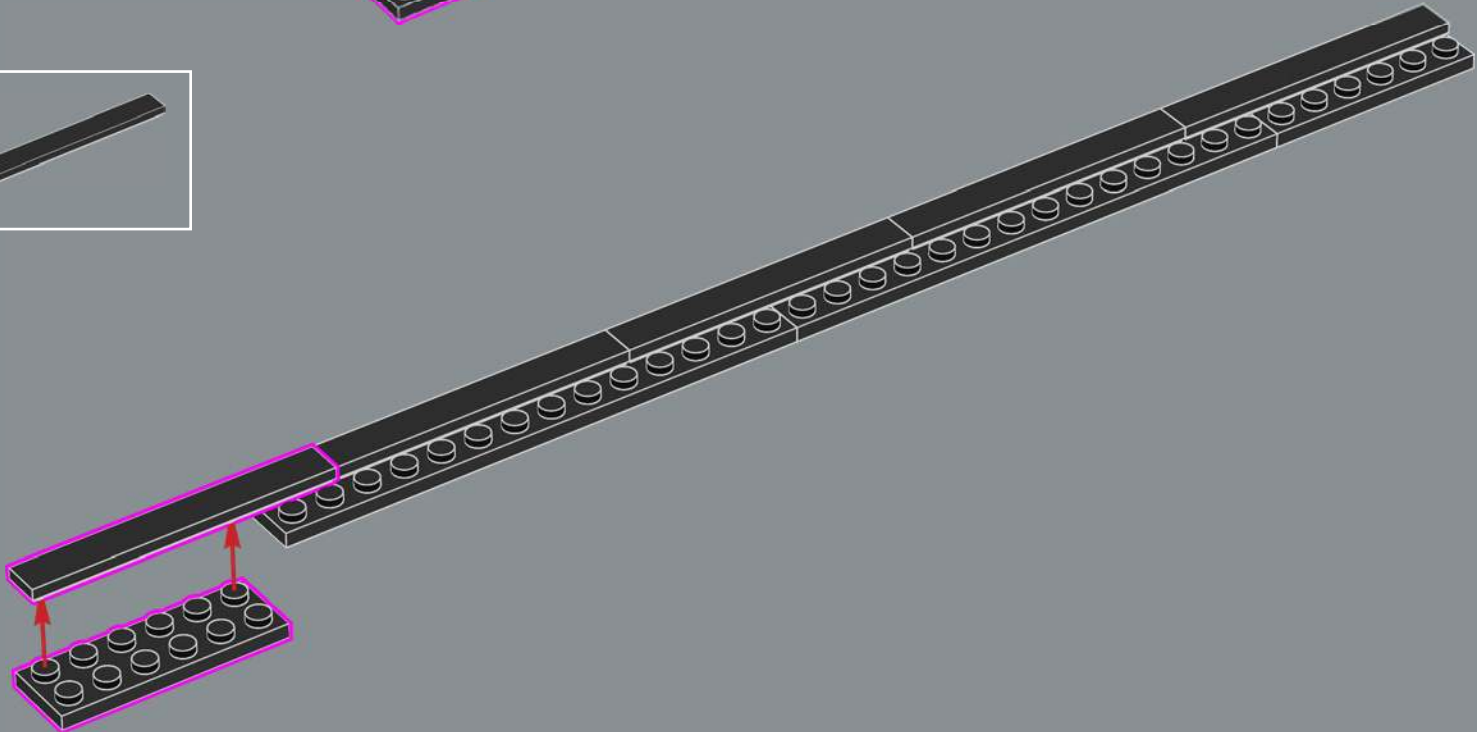

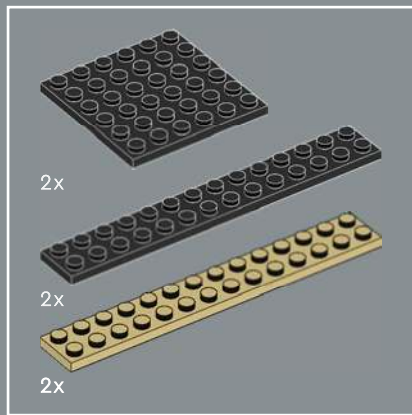

6

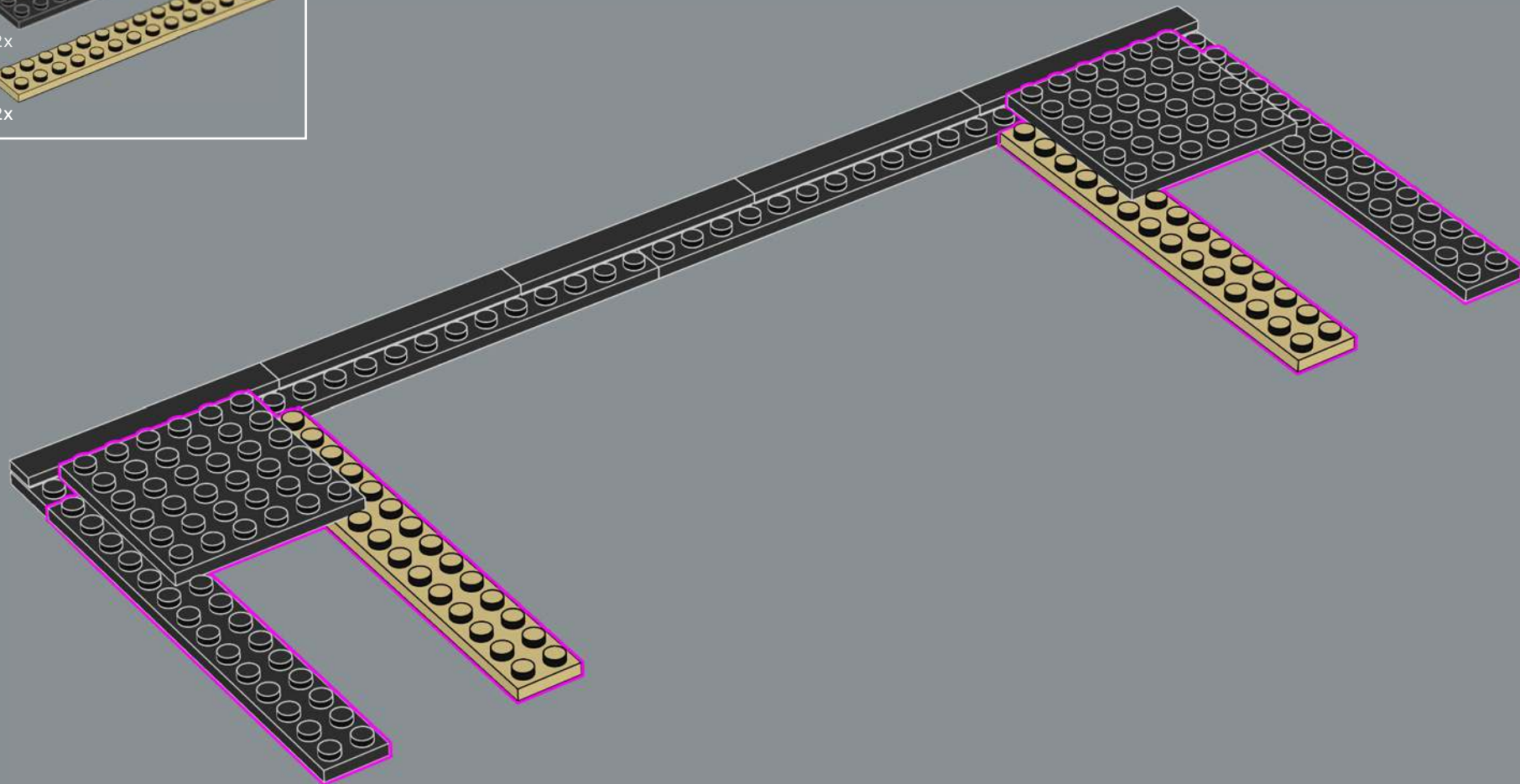

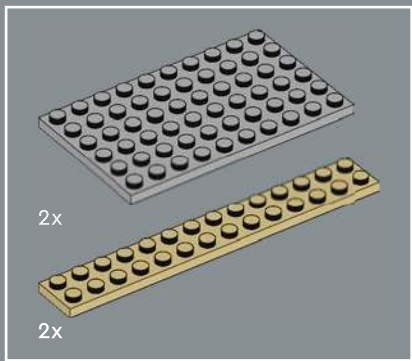

7

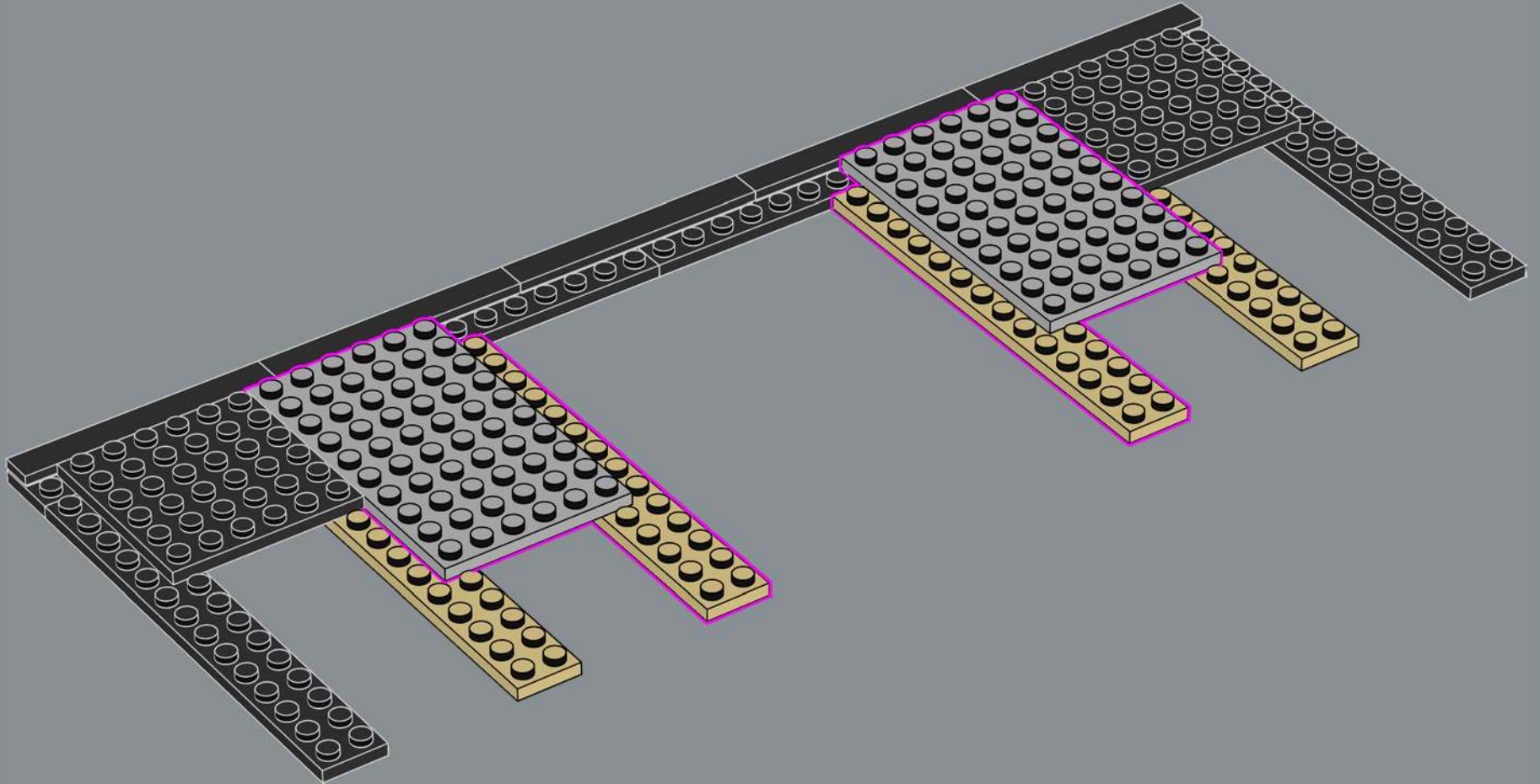

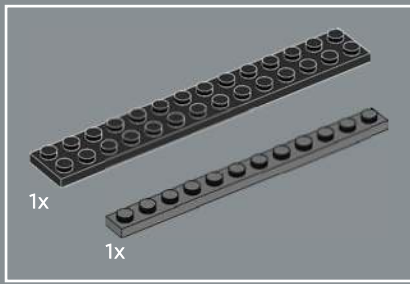

8

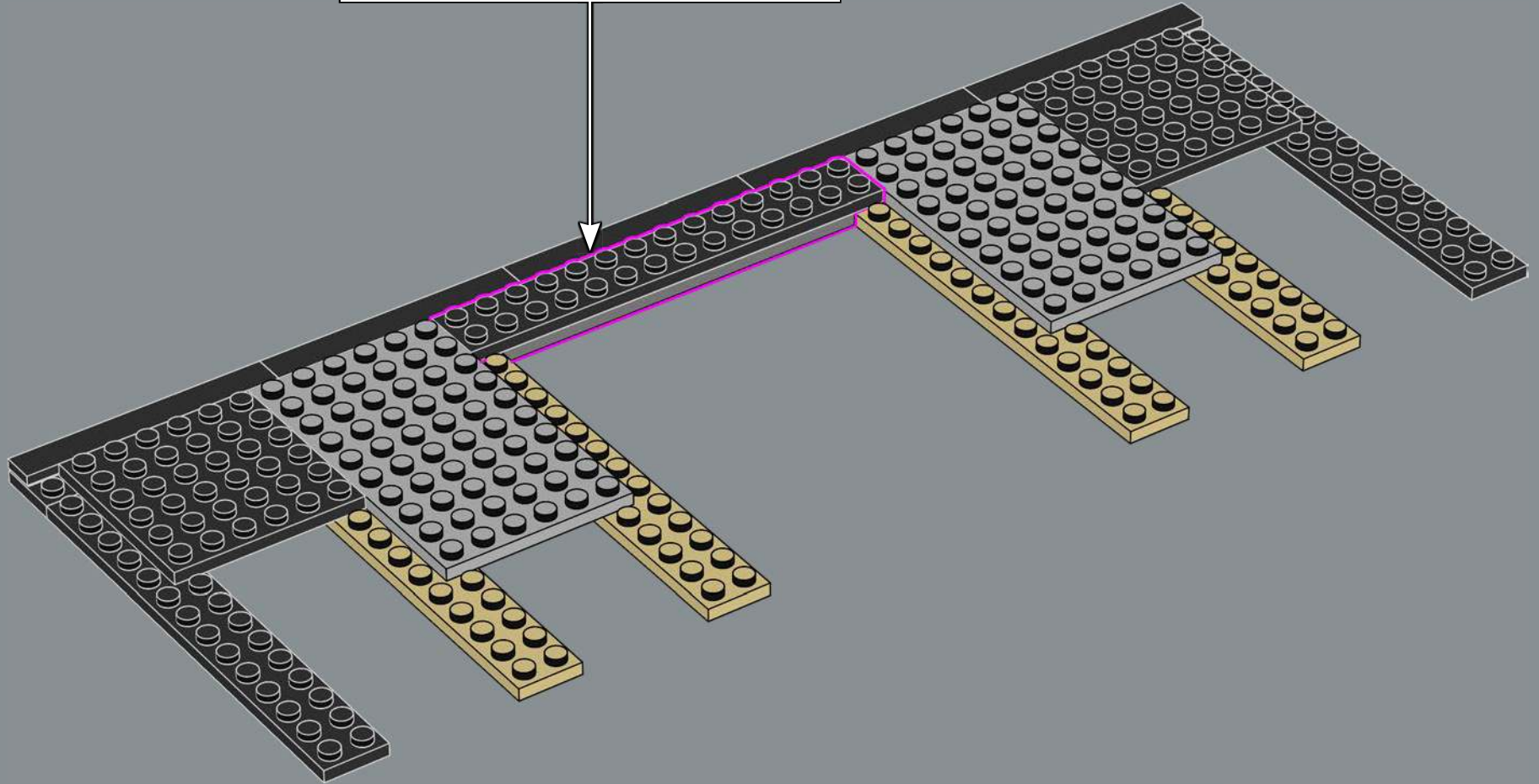
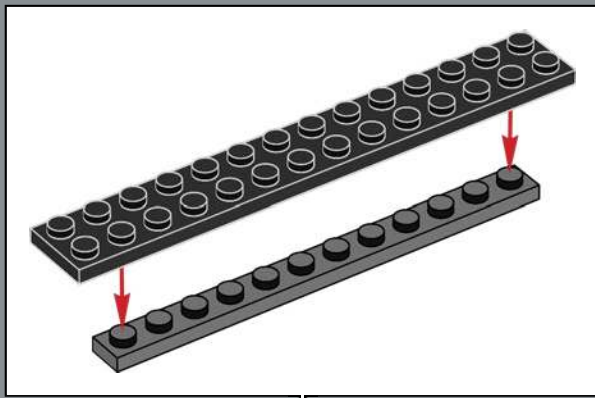

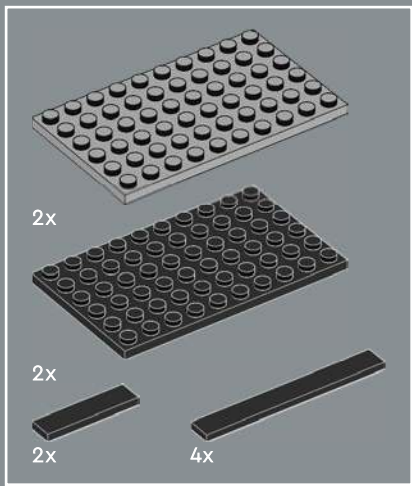

9

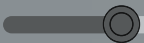
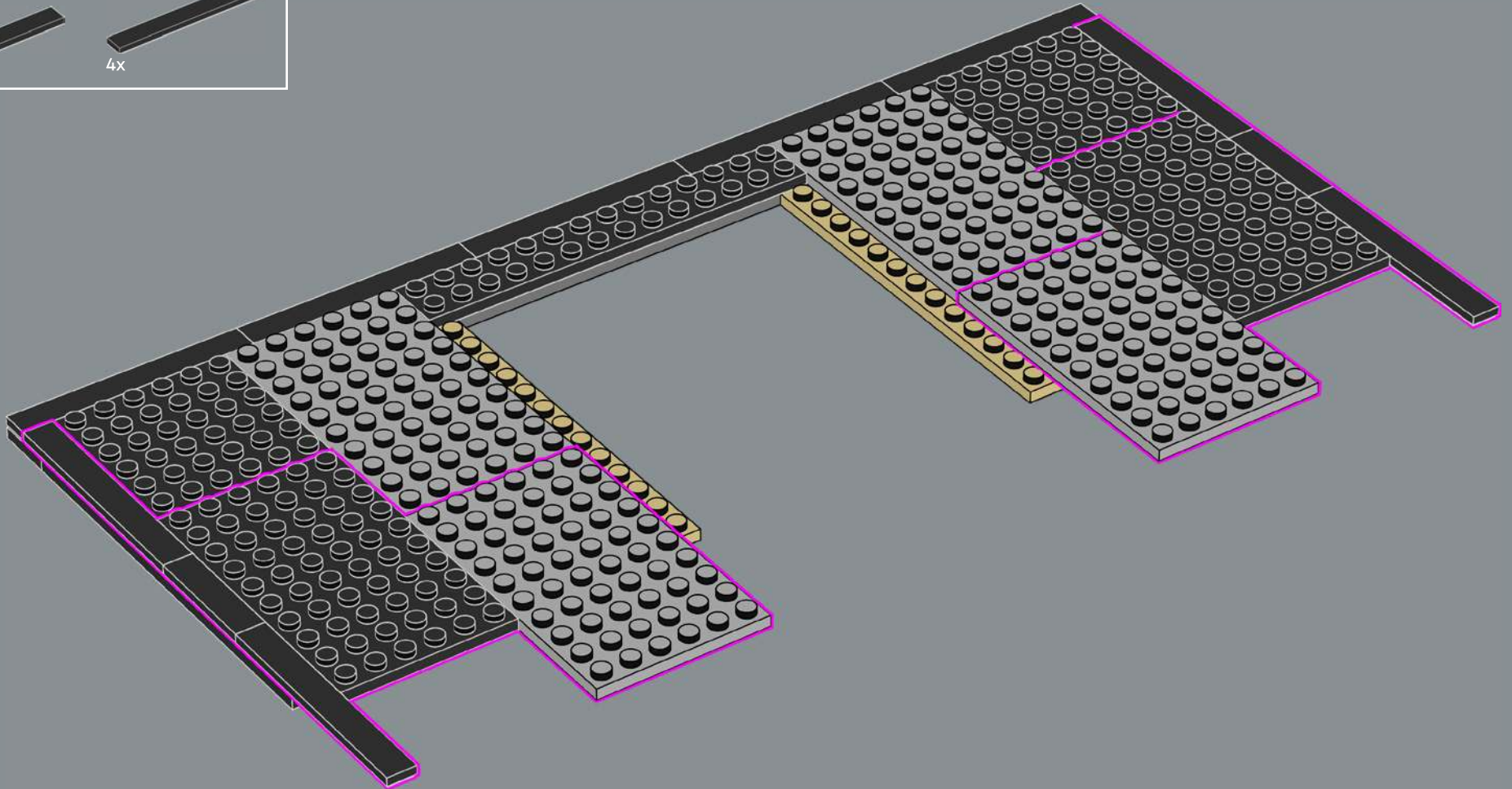

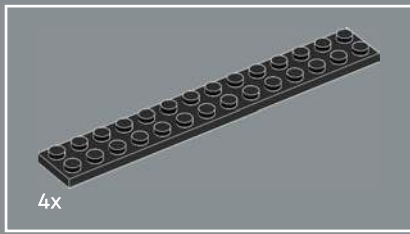

10

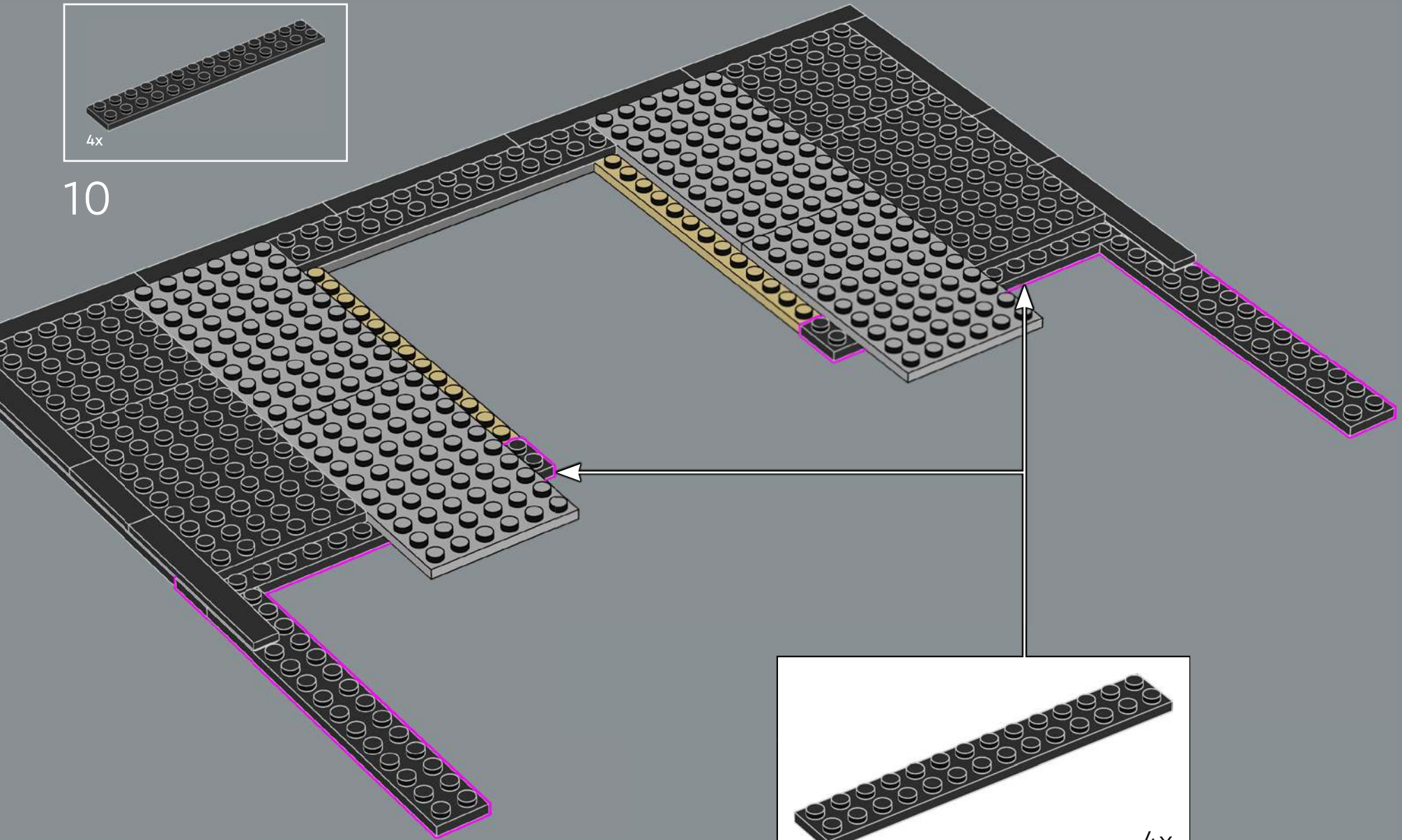

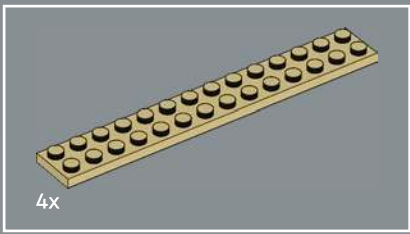

11

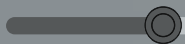
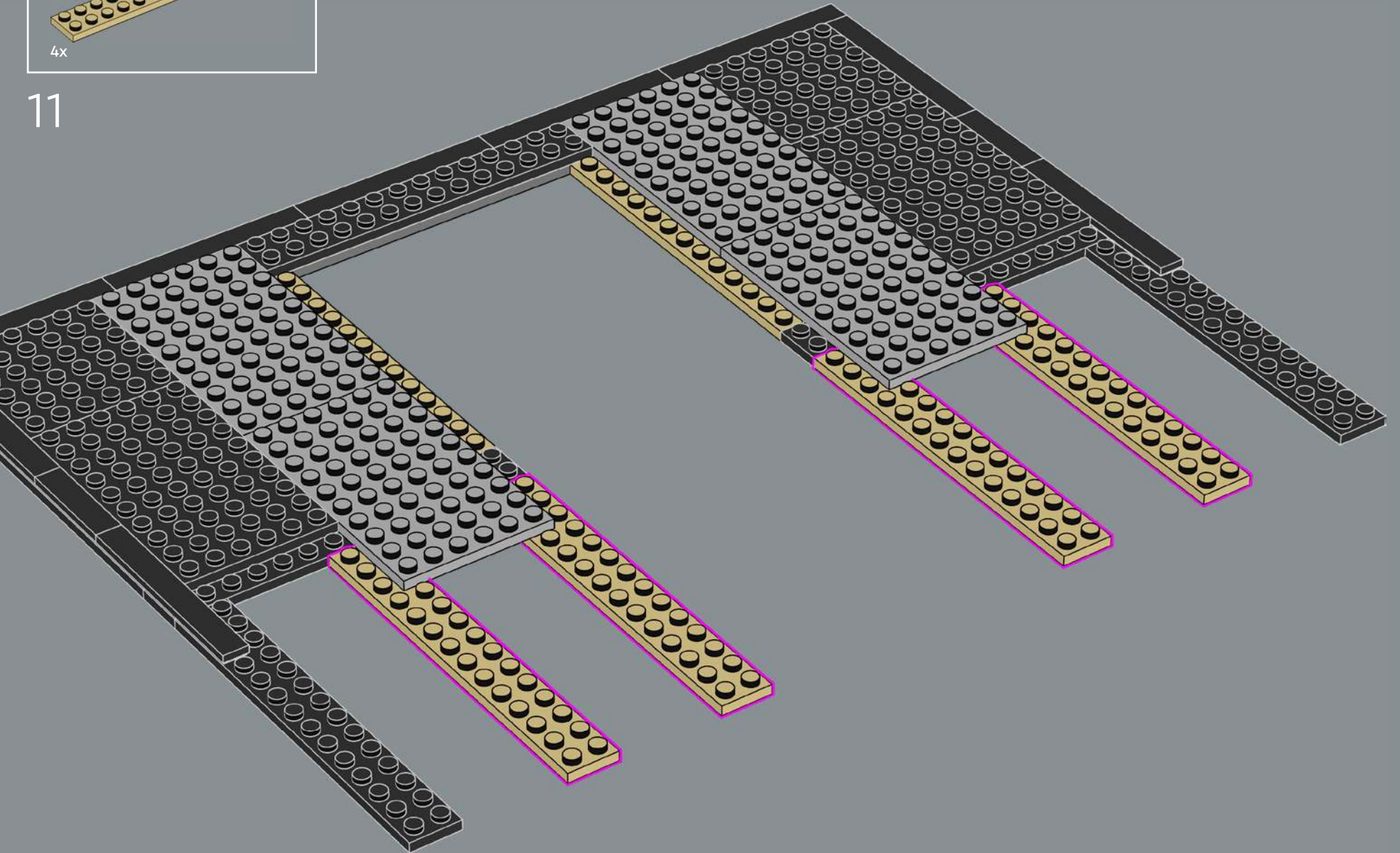

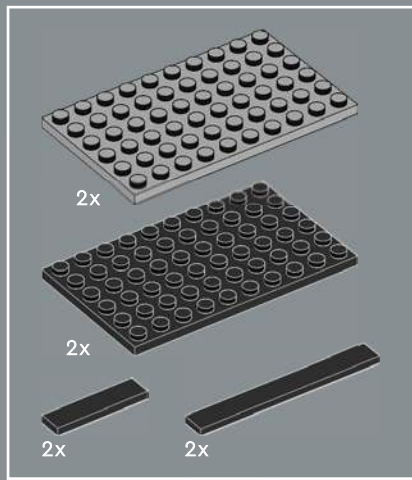

12

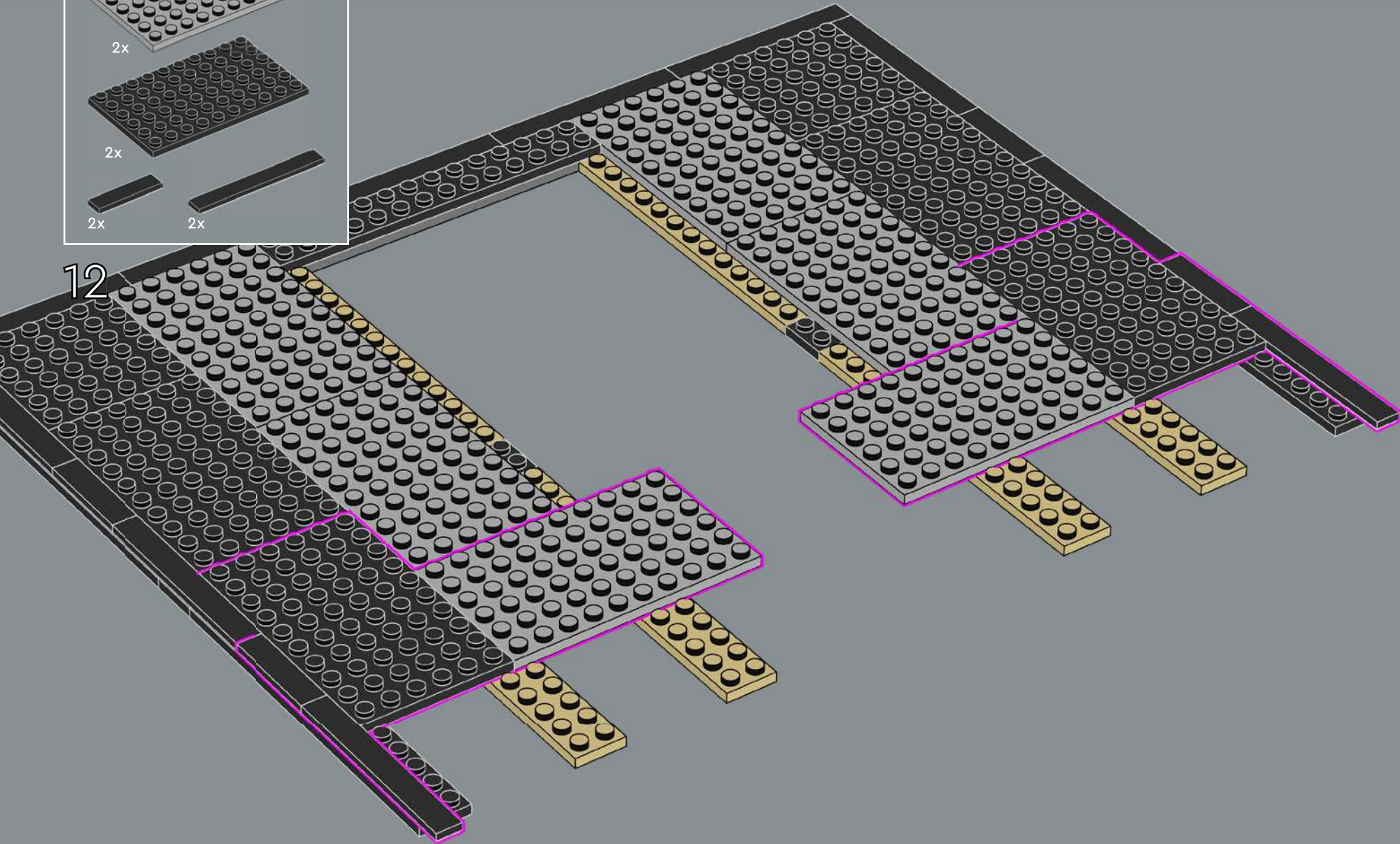

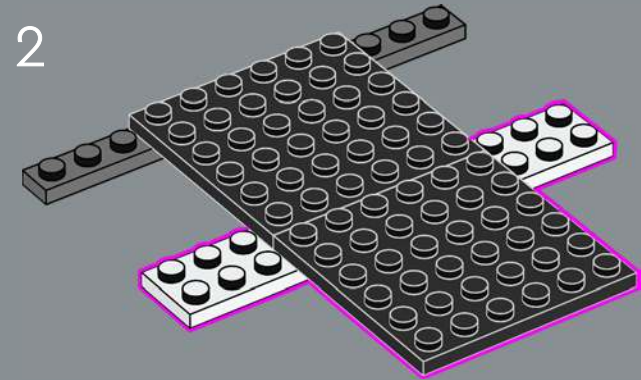
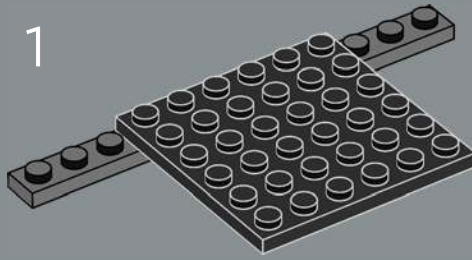
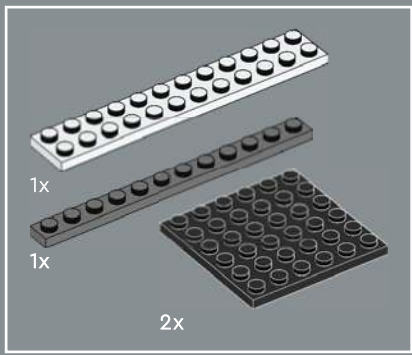

13

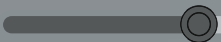
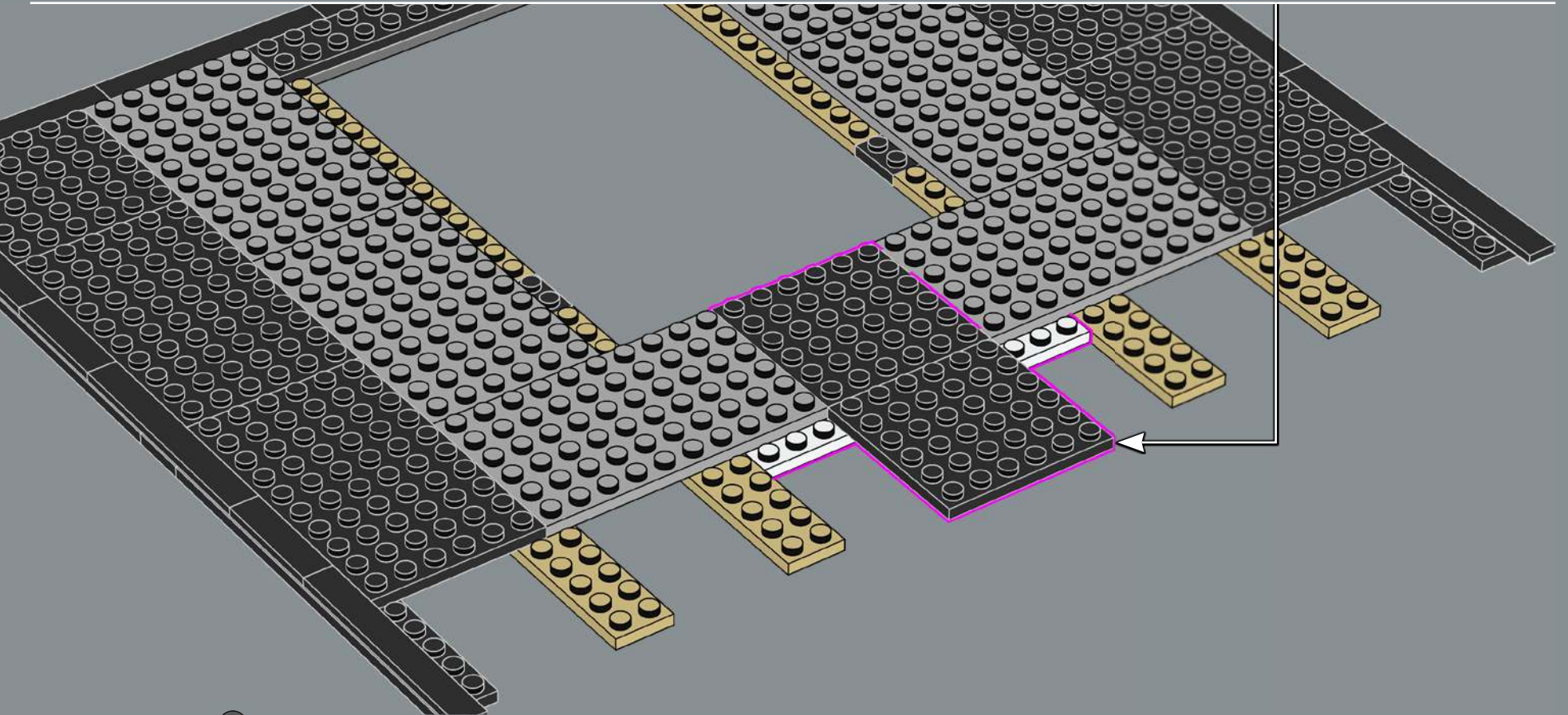

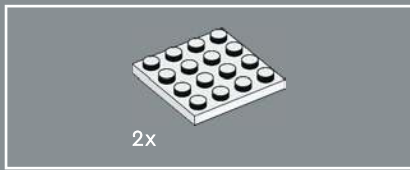

14

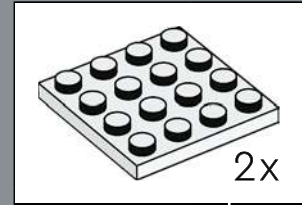
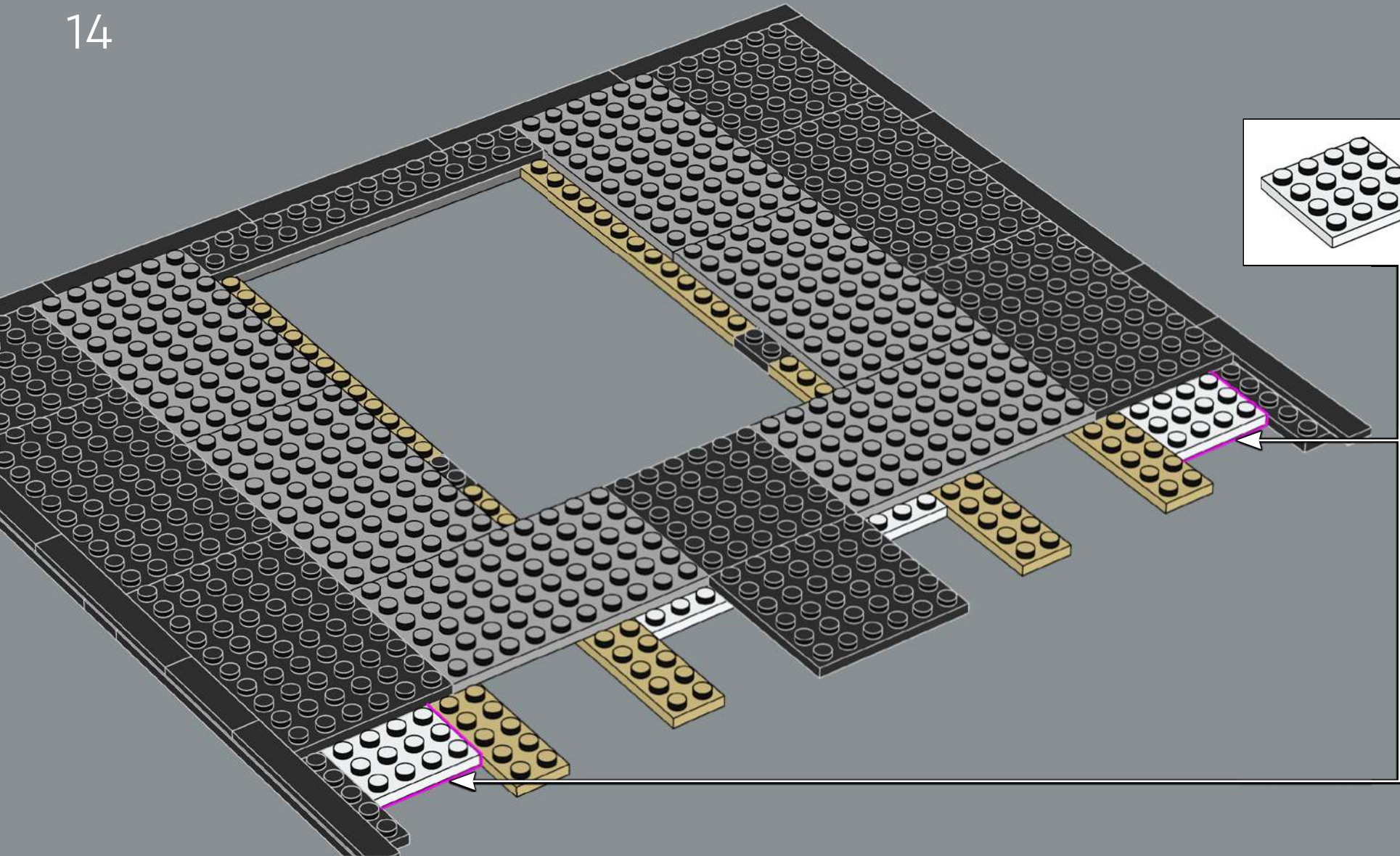

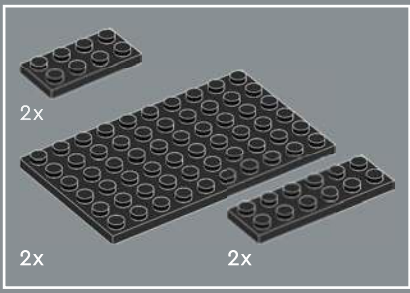

15

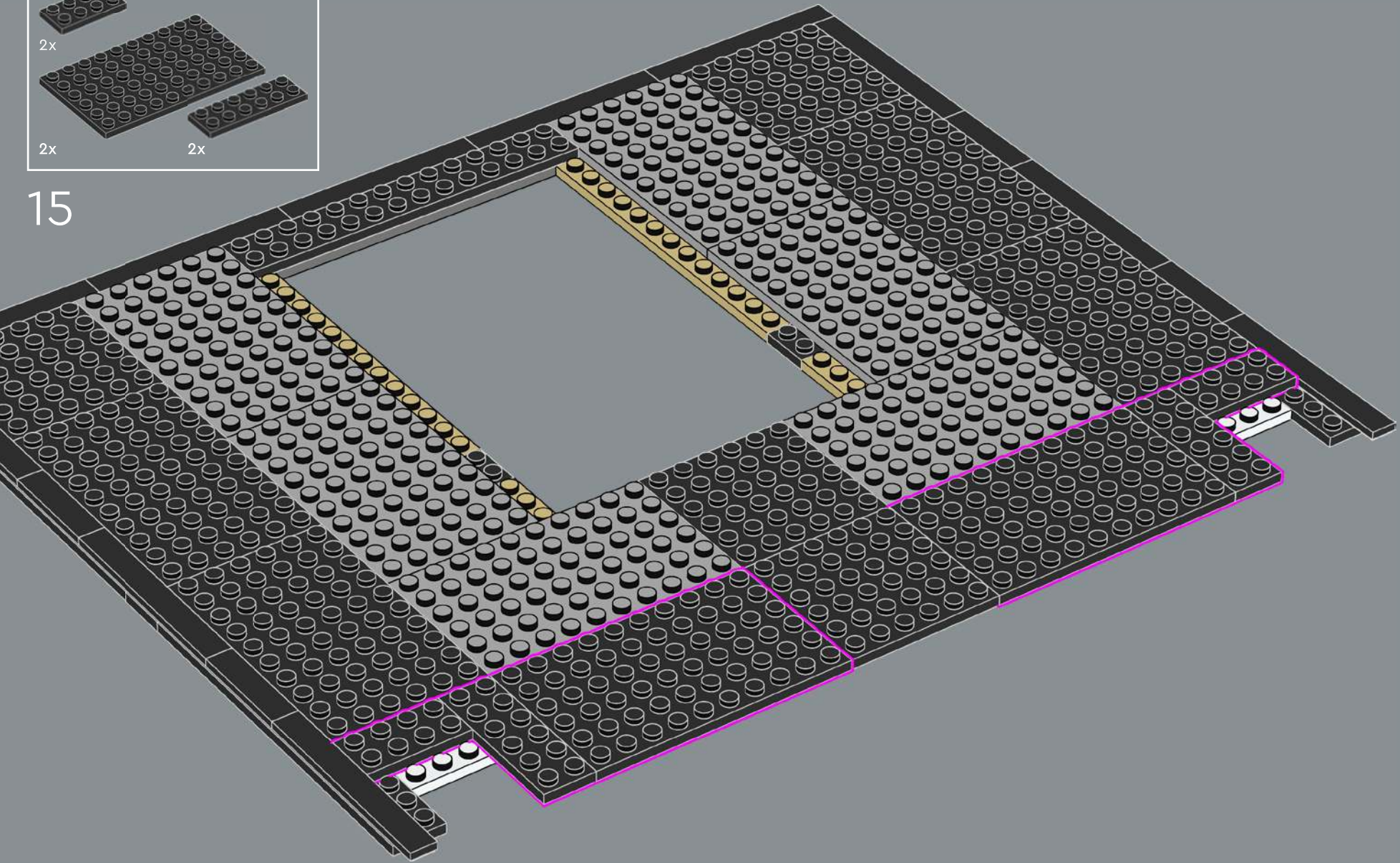

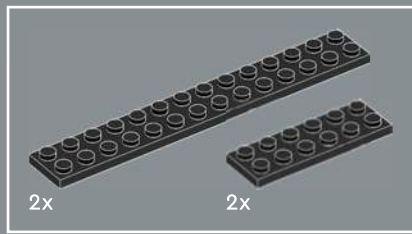

16

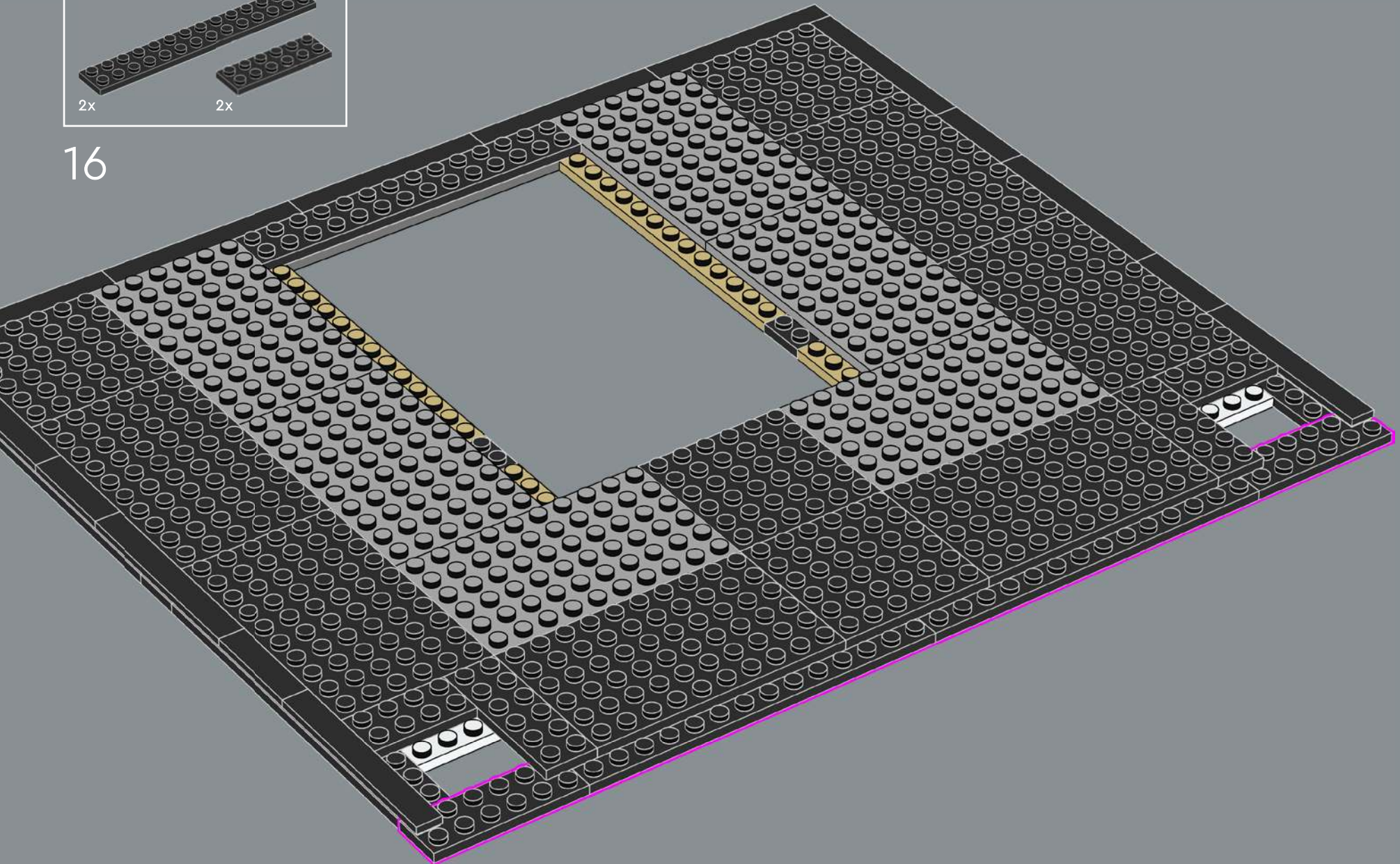

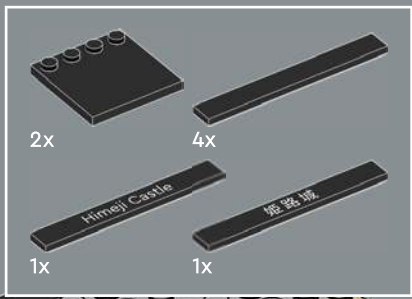

17

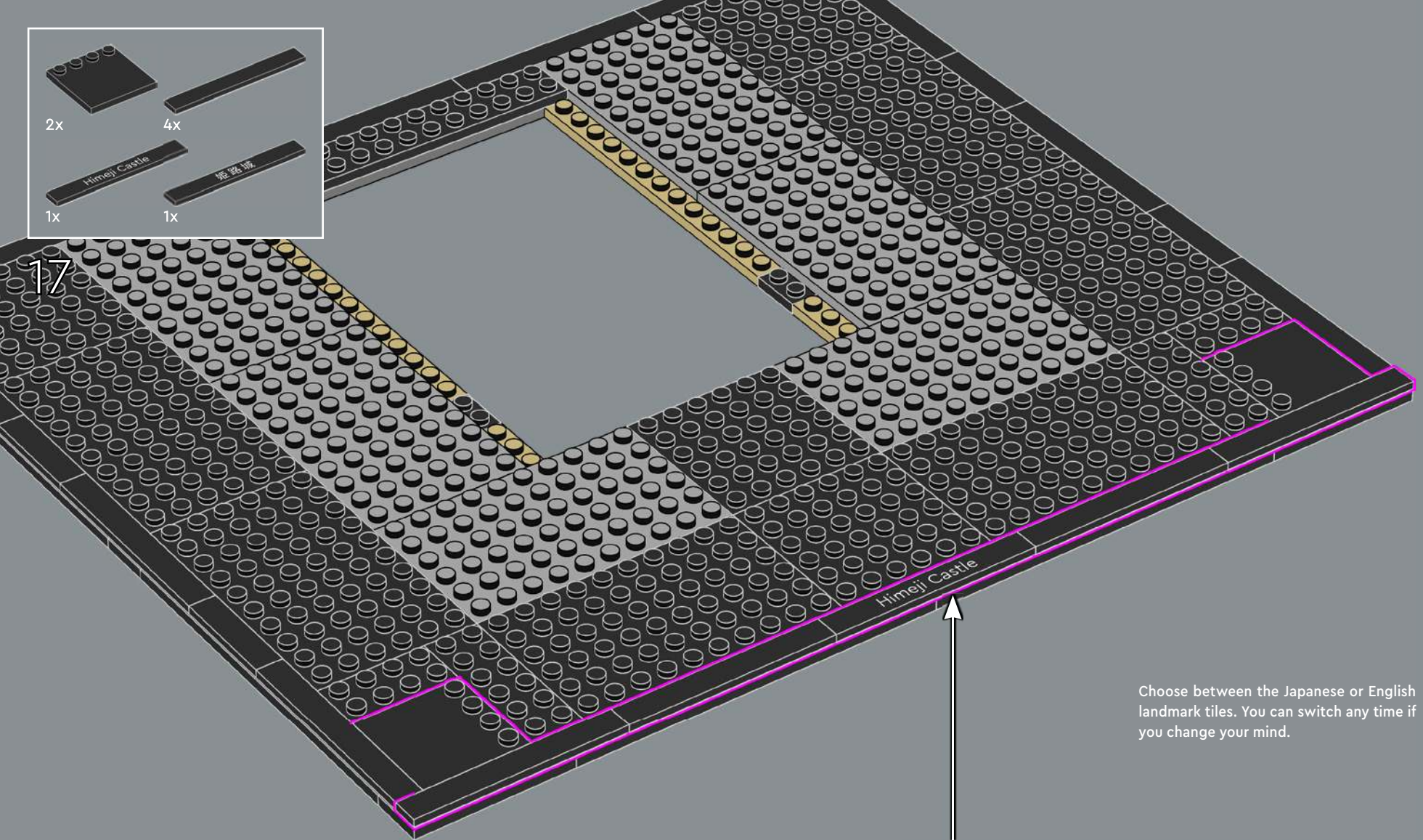

Choose between the Japanese or English landmark tiles. You can switch any time if you change your mind.

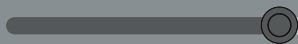

In 1993, Himeji Castle was inscribed on UNESCO's World Heritage list, honouring the landmark as a masterpiece and the culmination of Japanese castle architecture in wood.

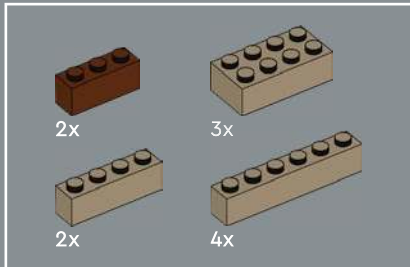

18

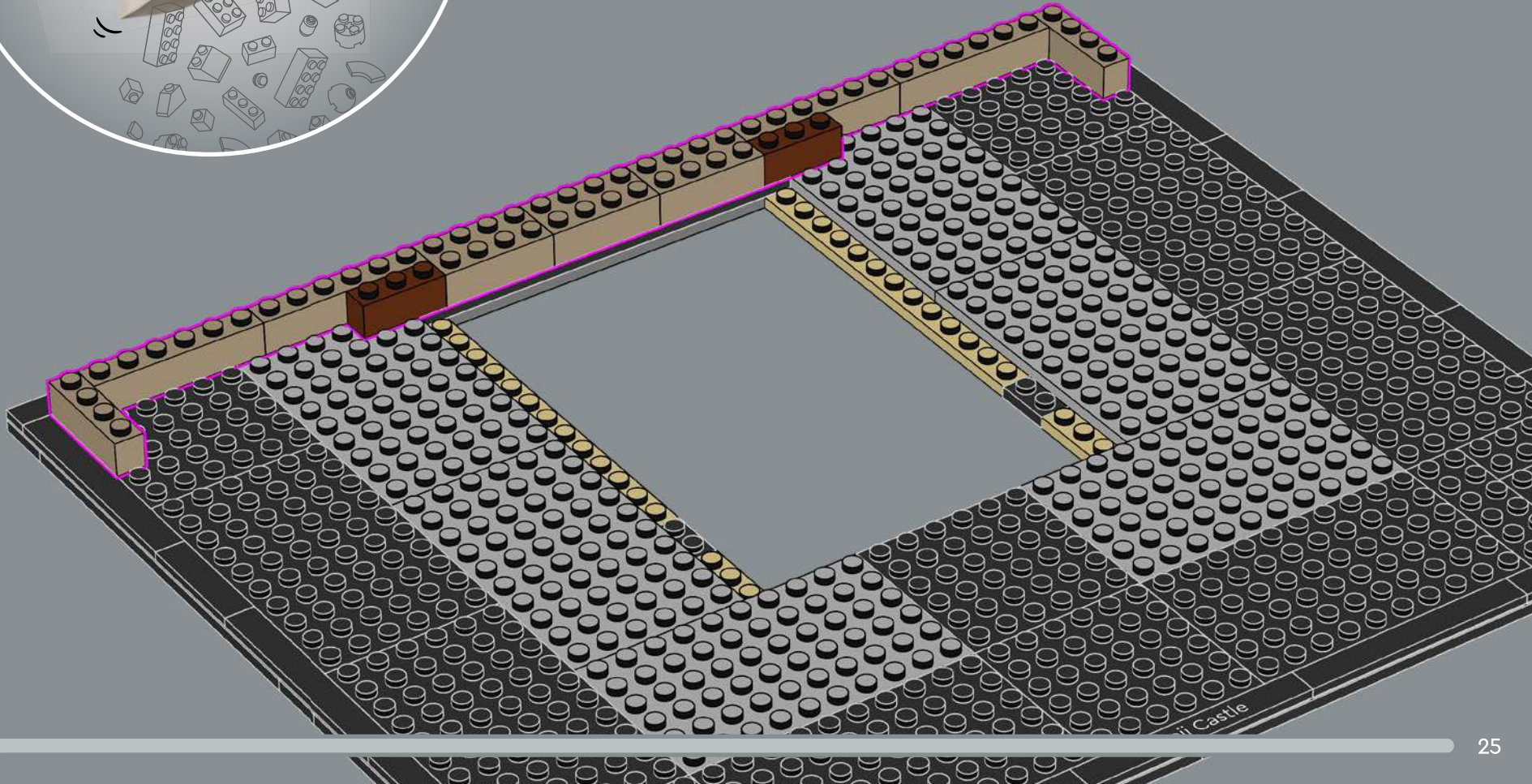

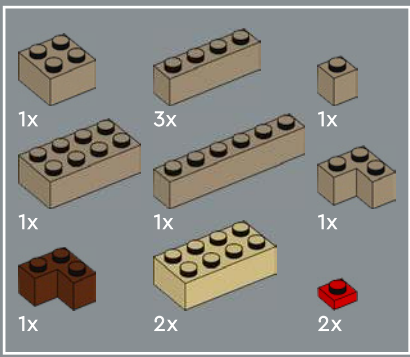

19

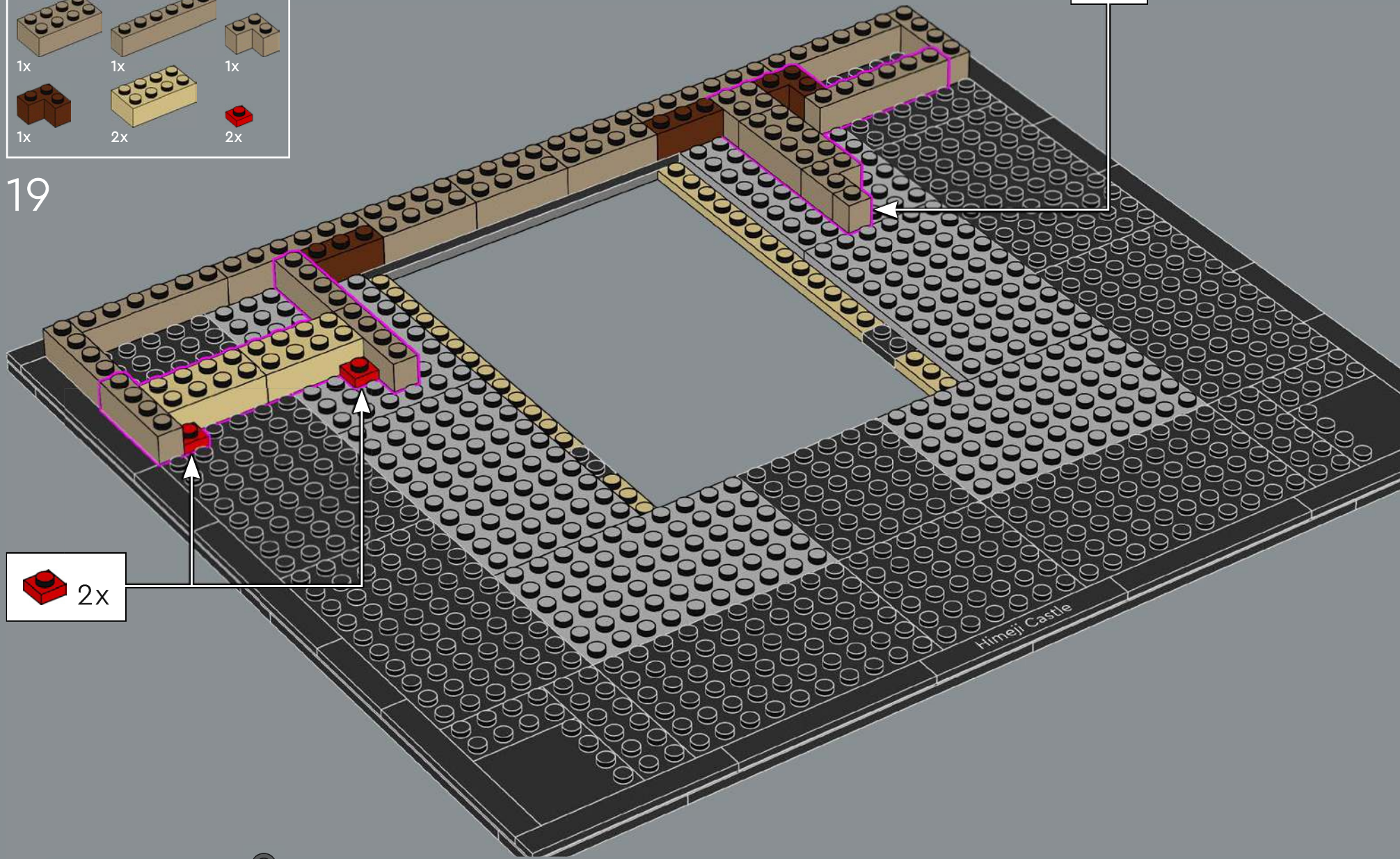

Himeji Castle

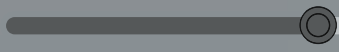

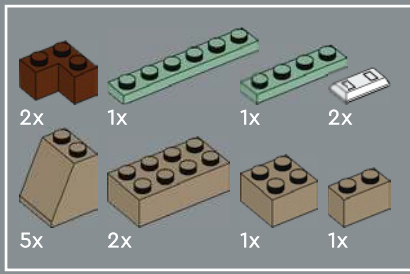

20

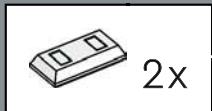
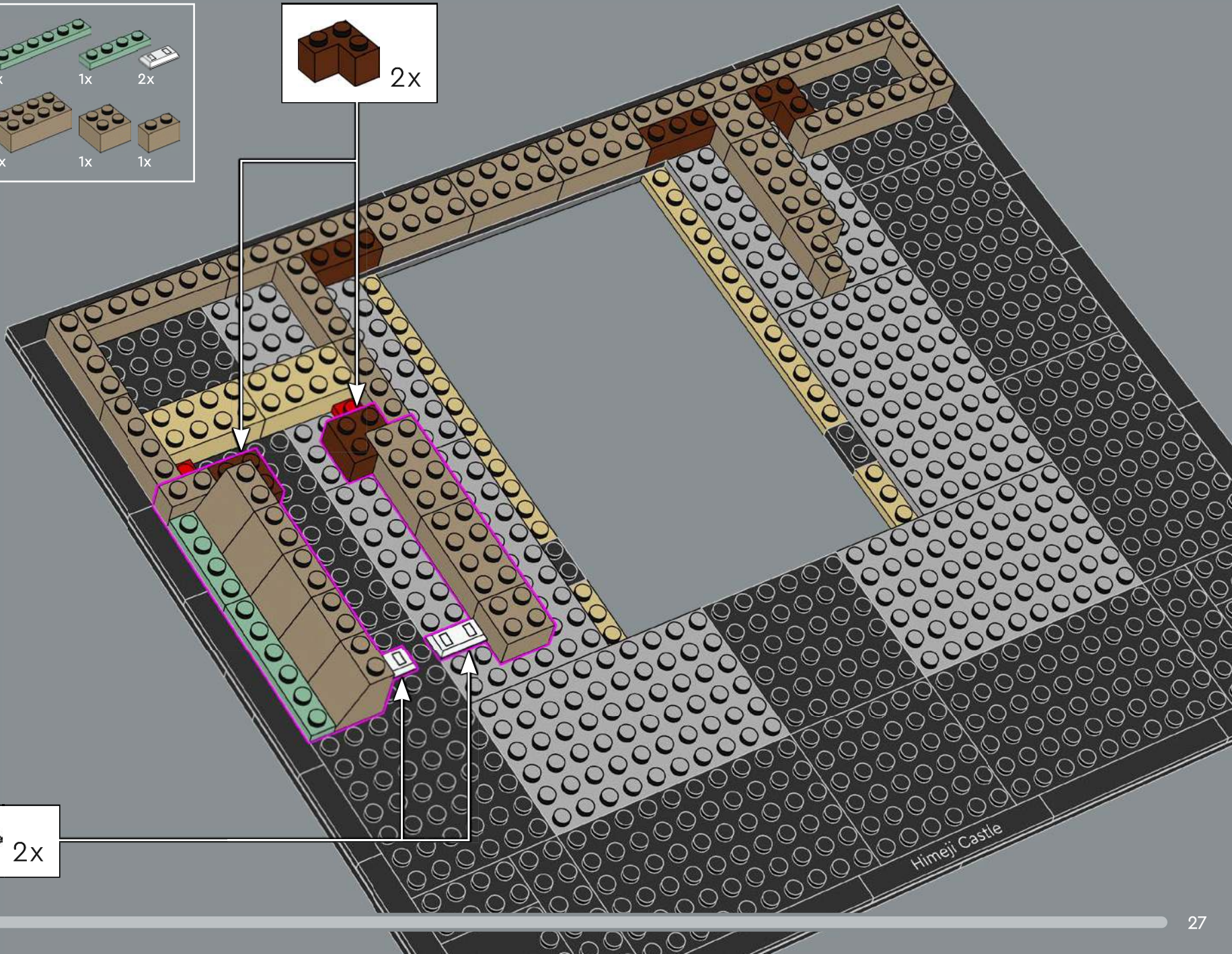

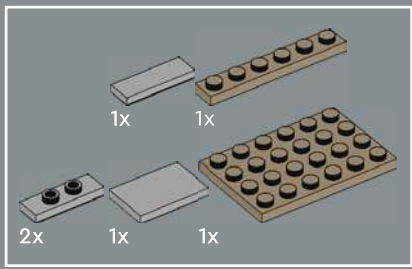



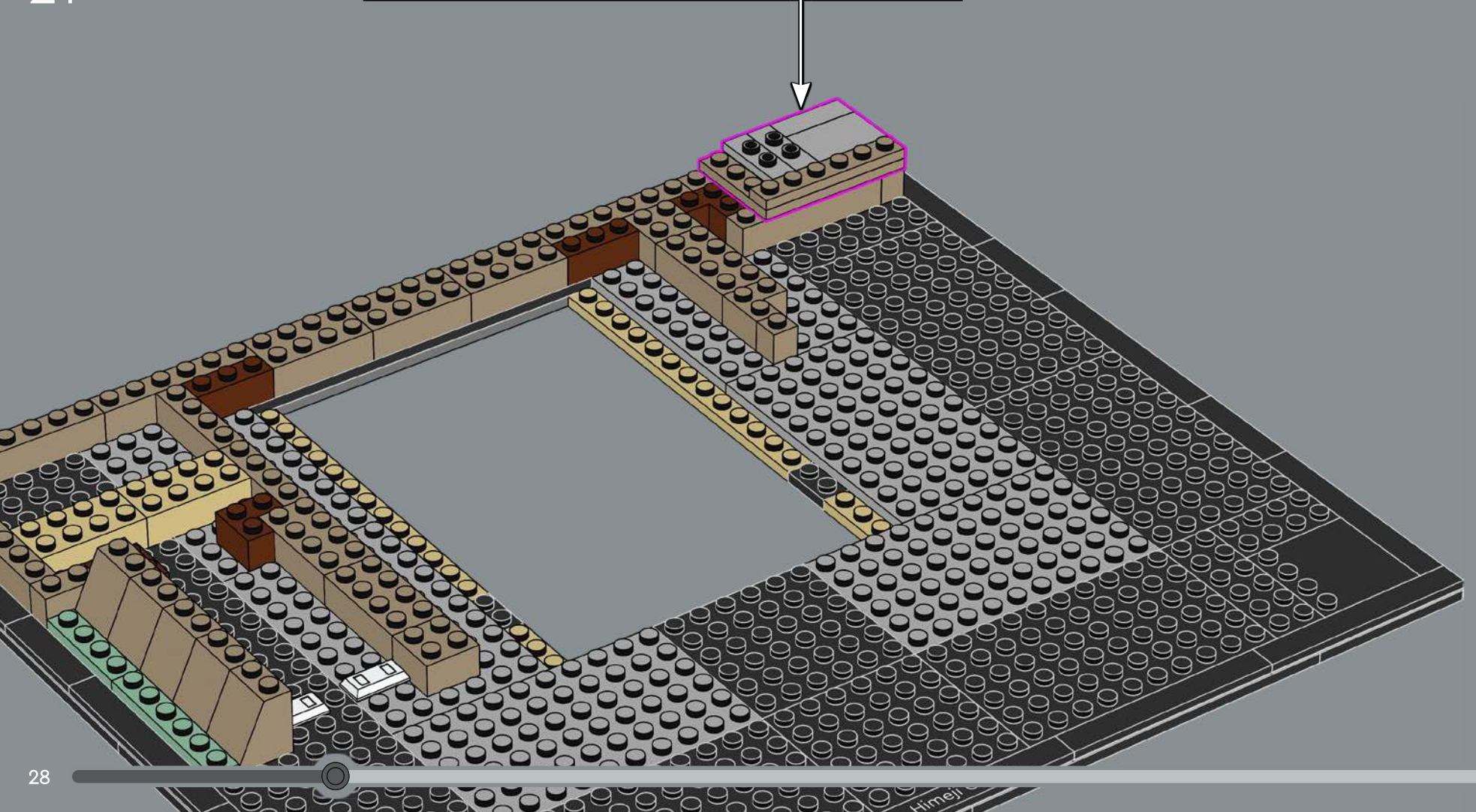
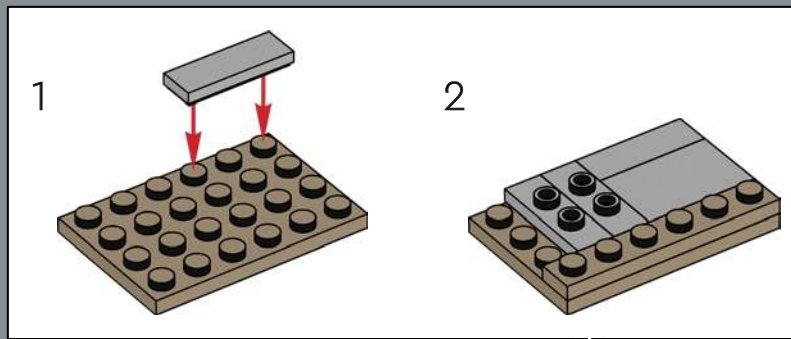

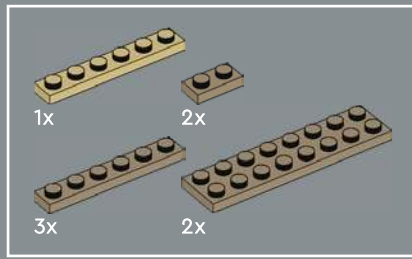

21

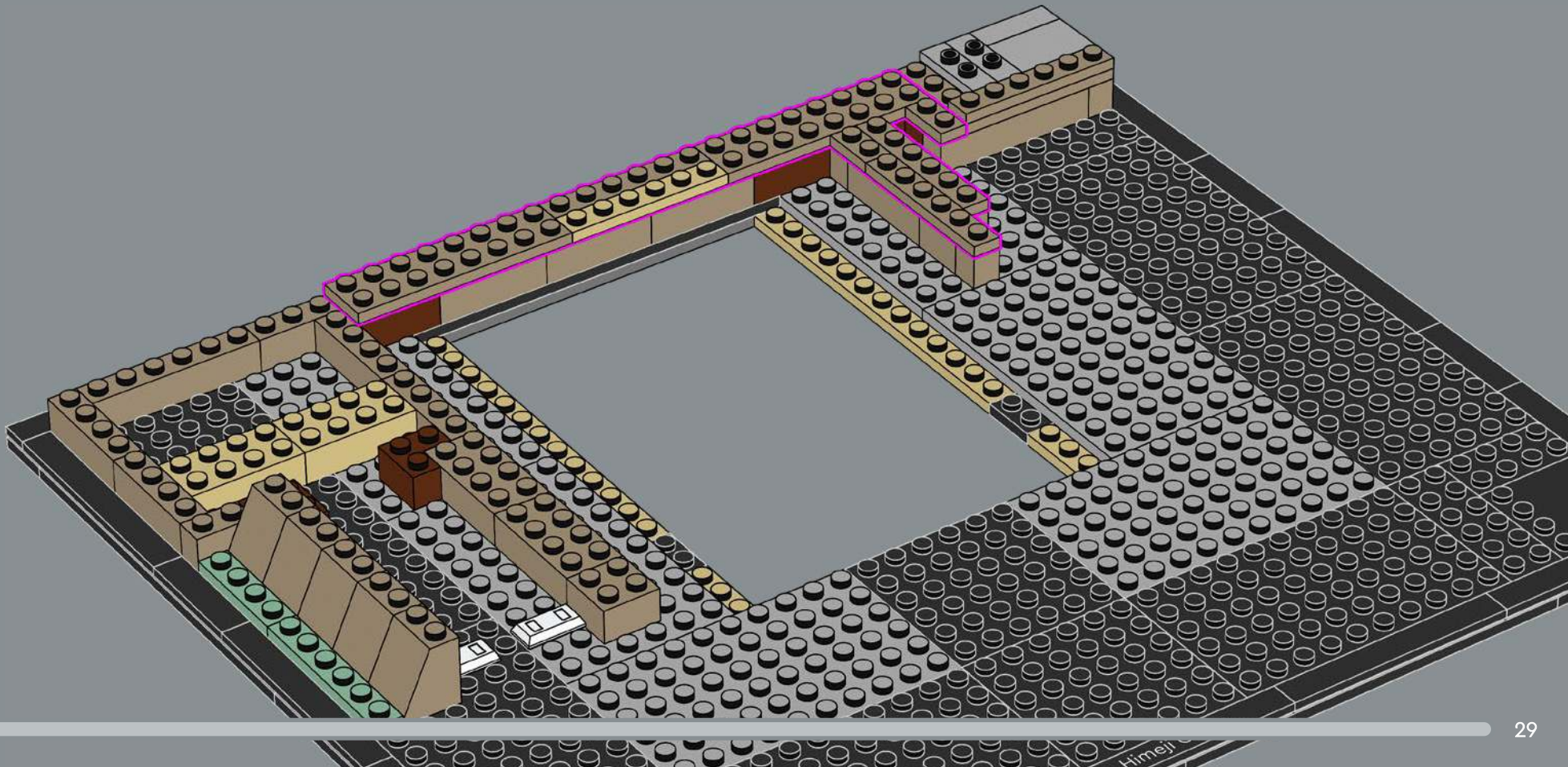



22



- 1x 
- 1x 
- 2x 
- 2x 
- 1x 

23

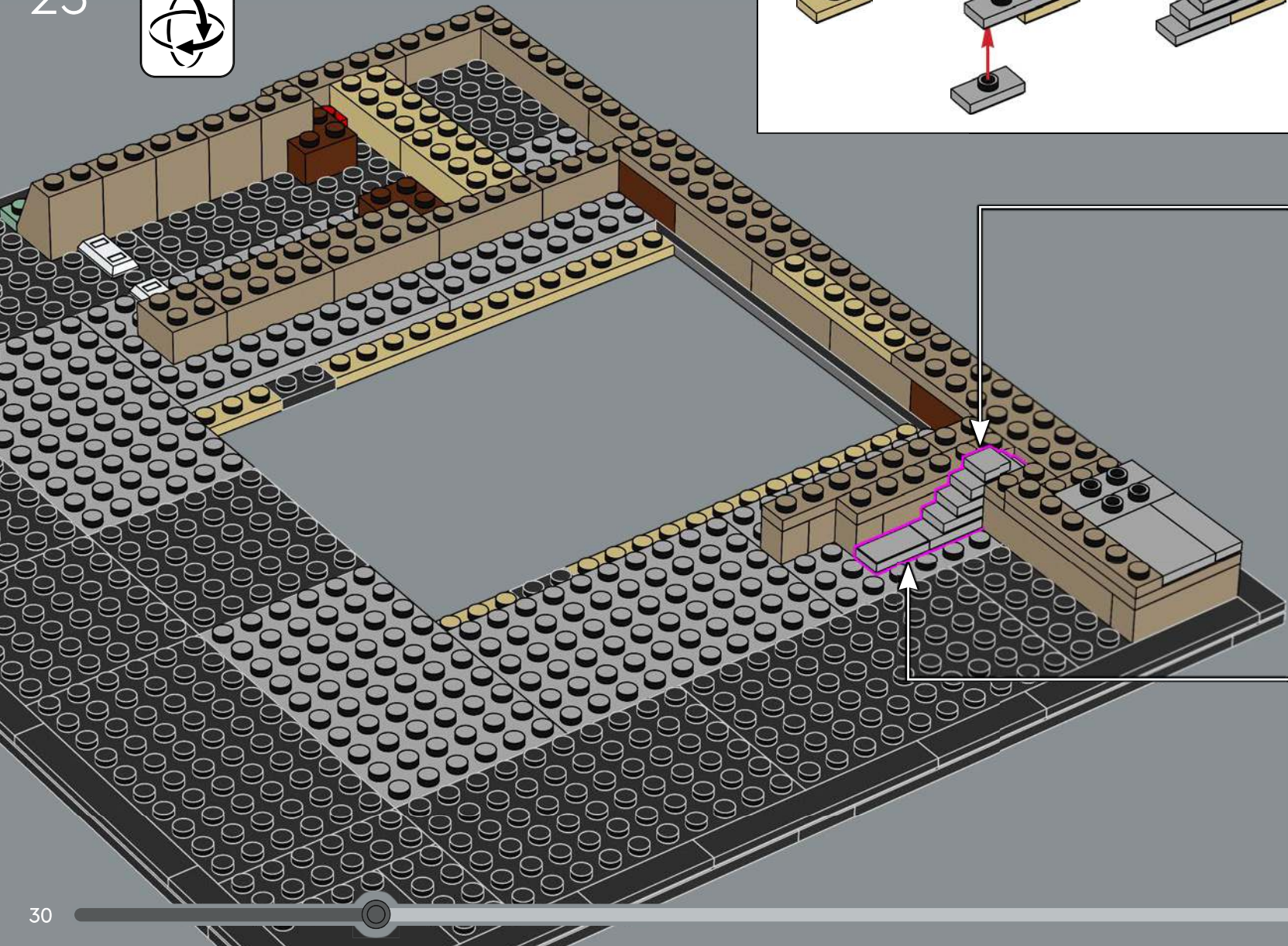
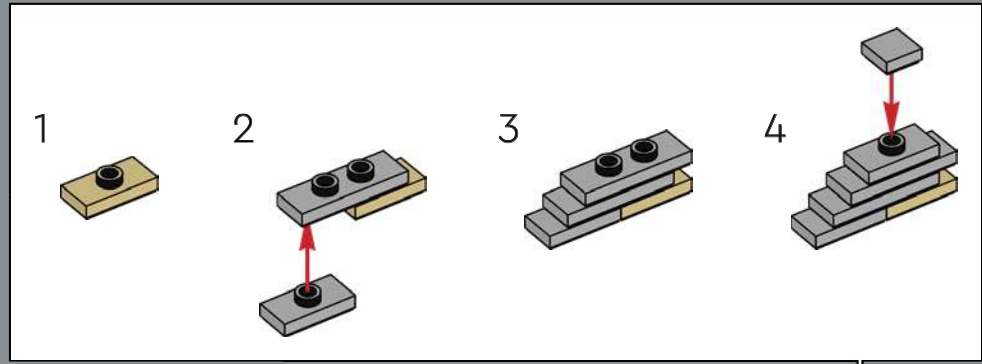

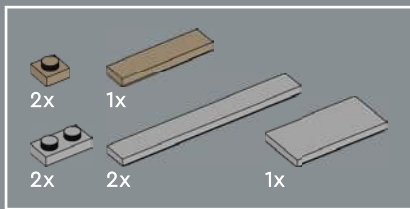

24

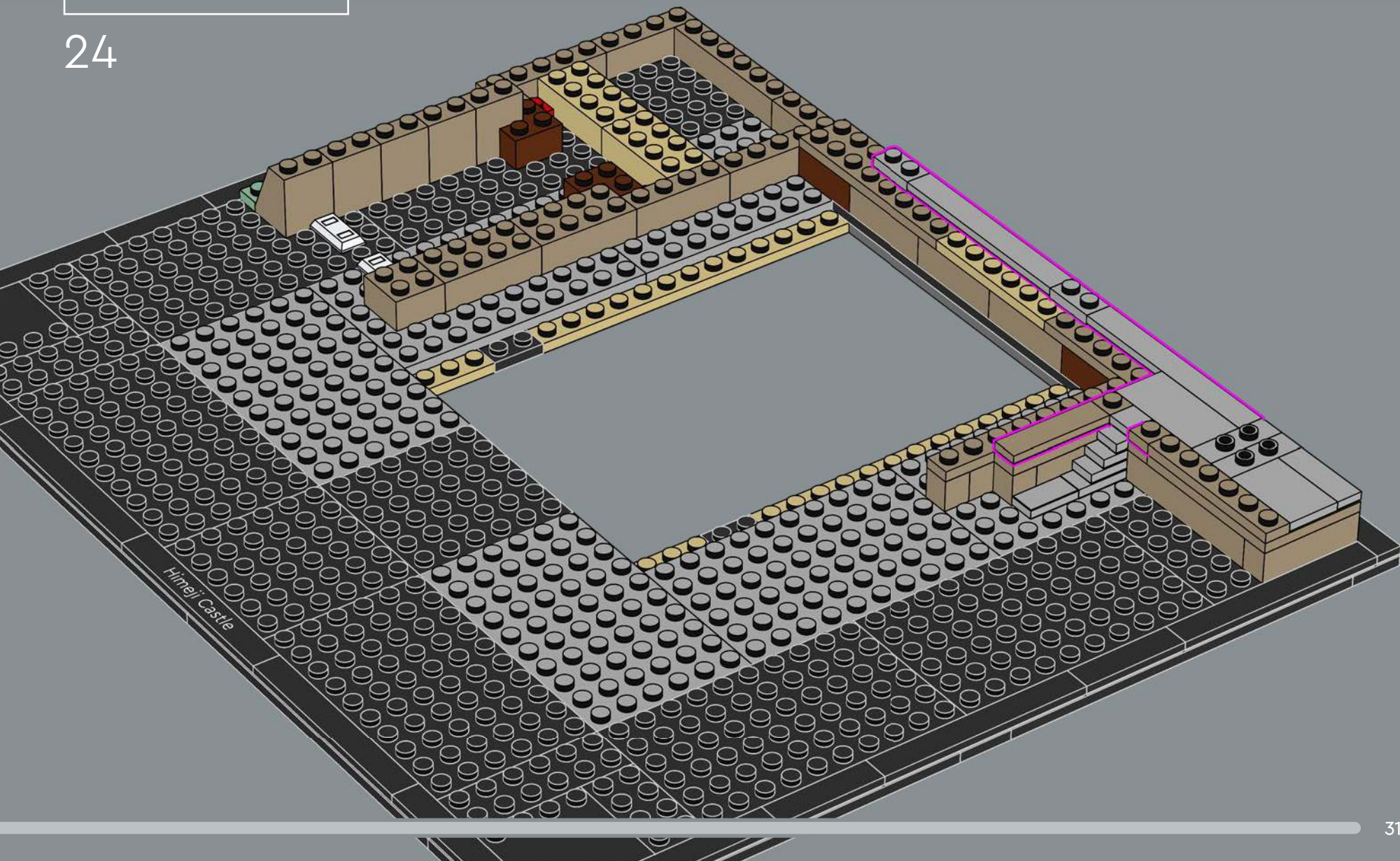

1x  4x  1x 

25

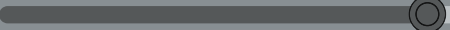
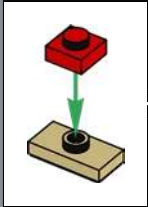
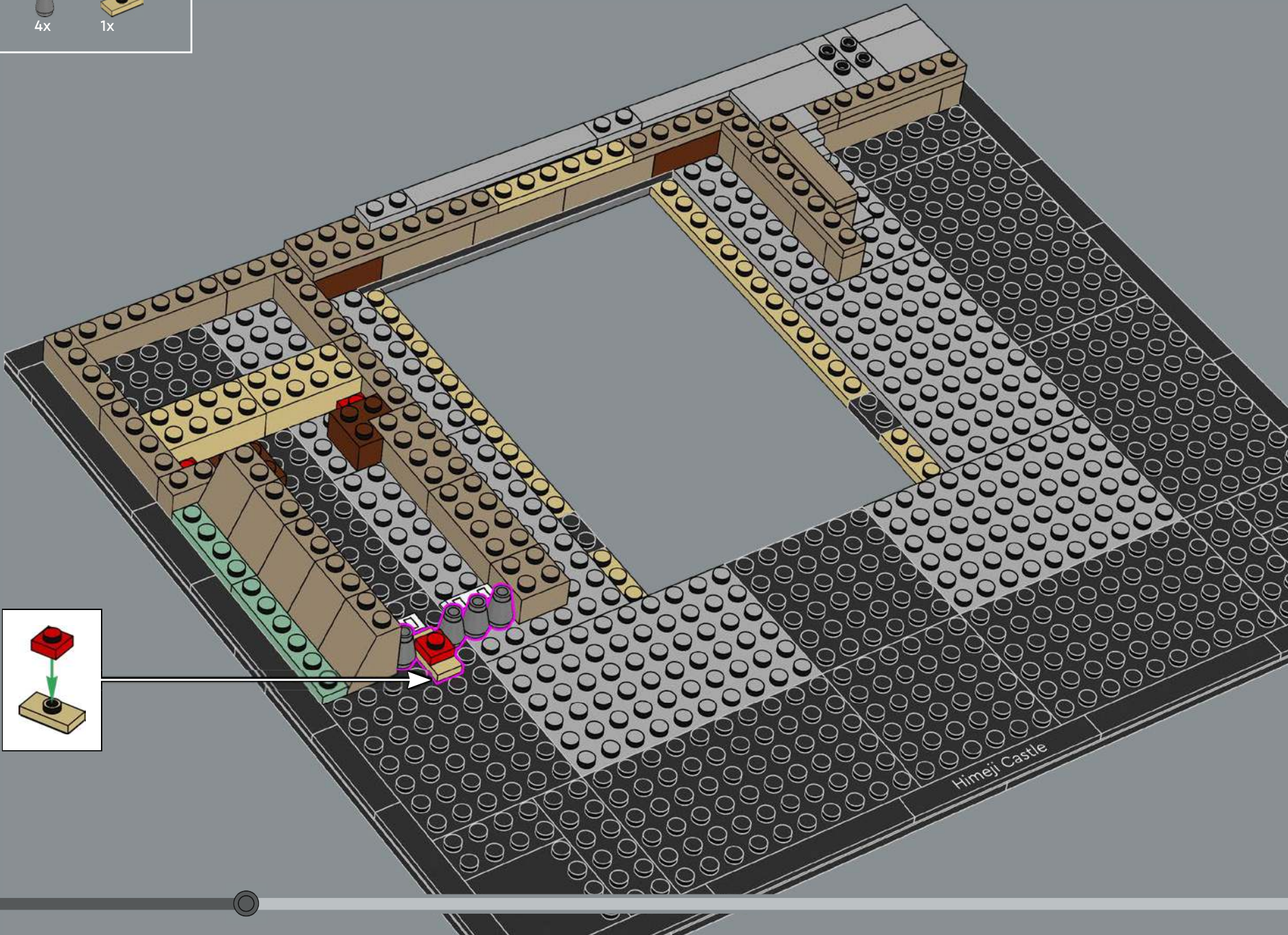

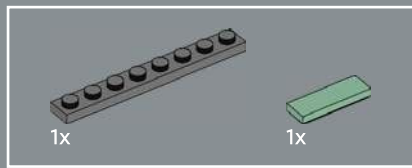

26

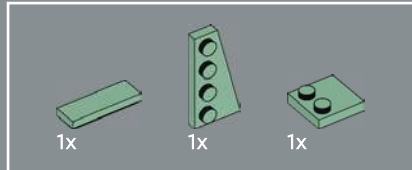
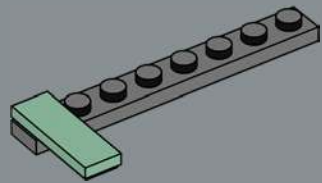

27

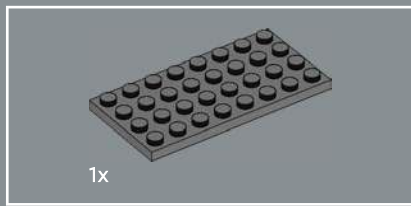
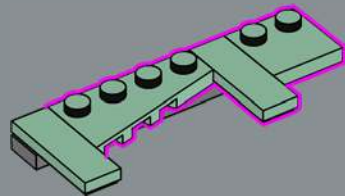

28

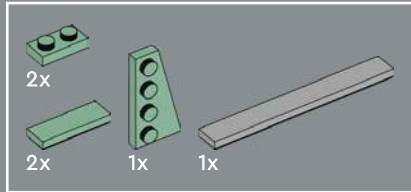
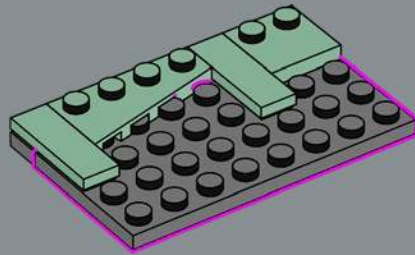

29

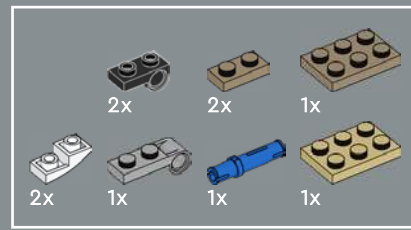
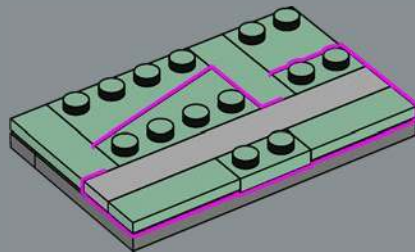

30

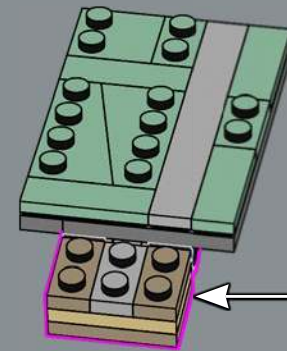
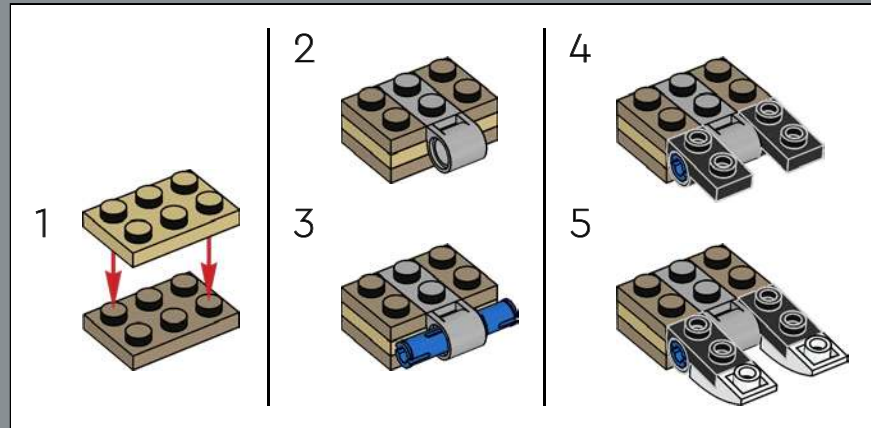

31

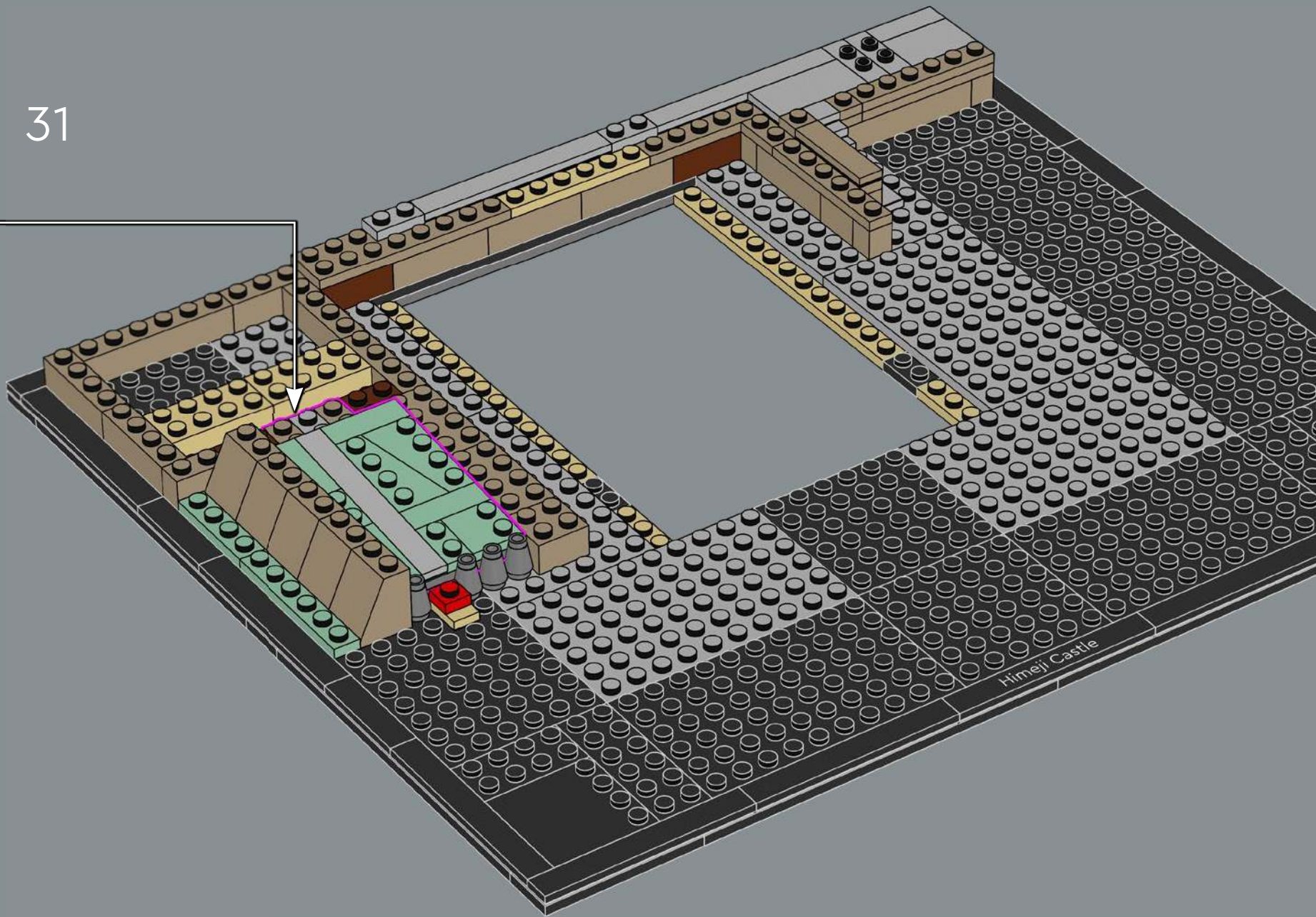

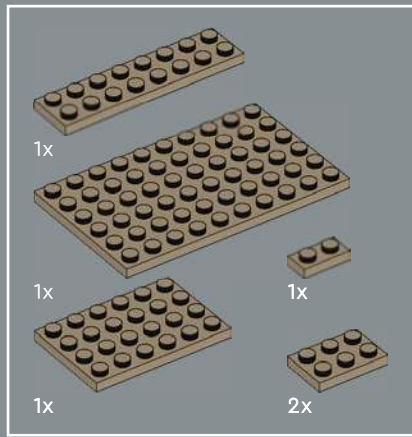

32

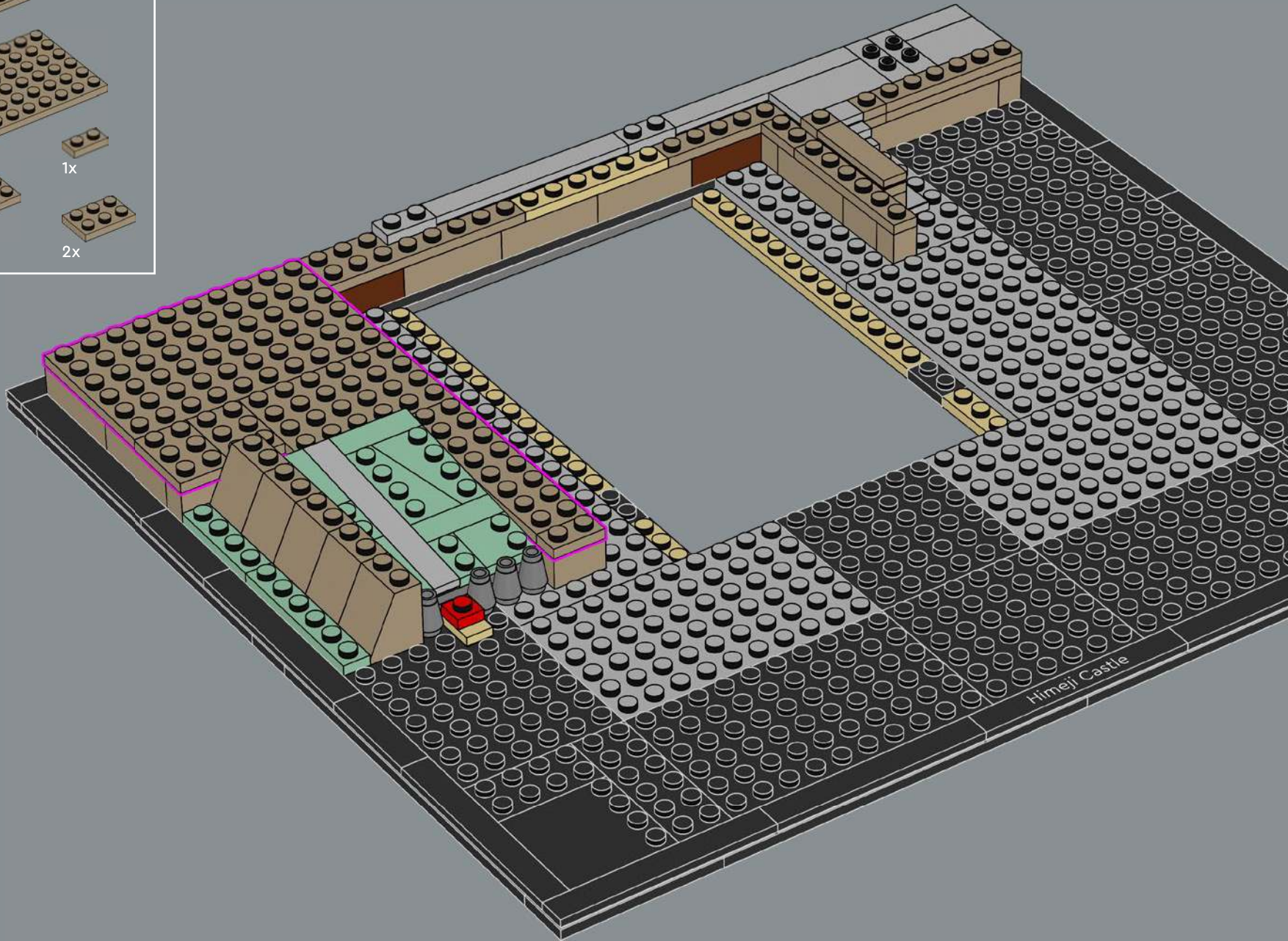

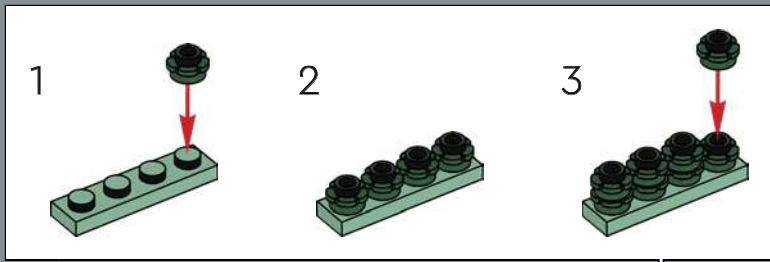
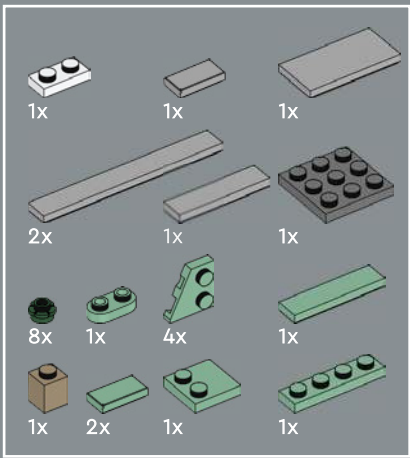

33

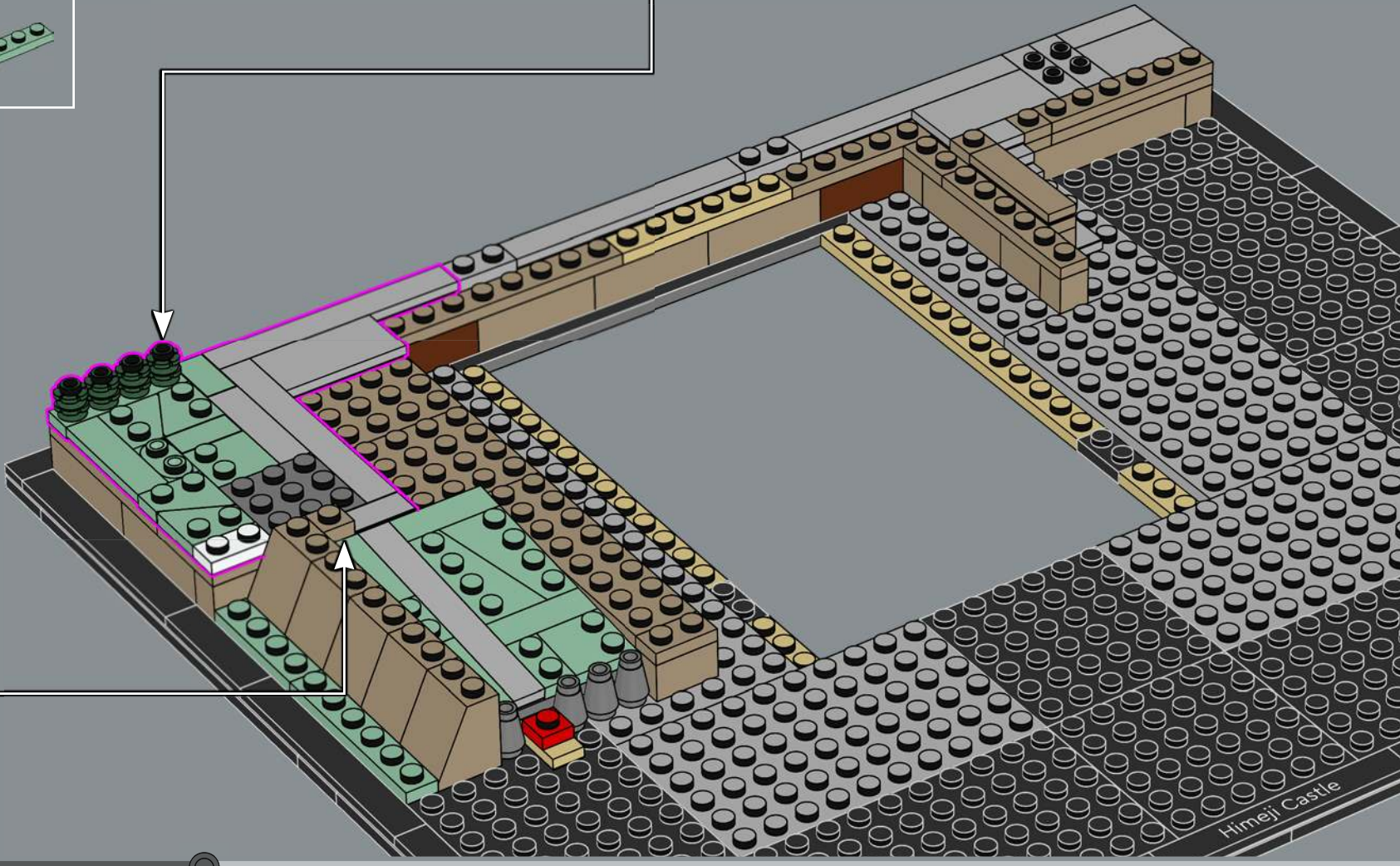



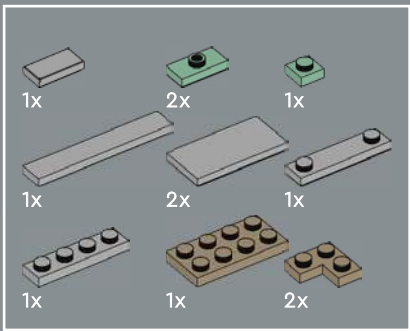

35

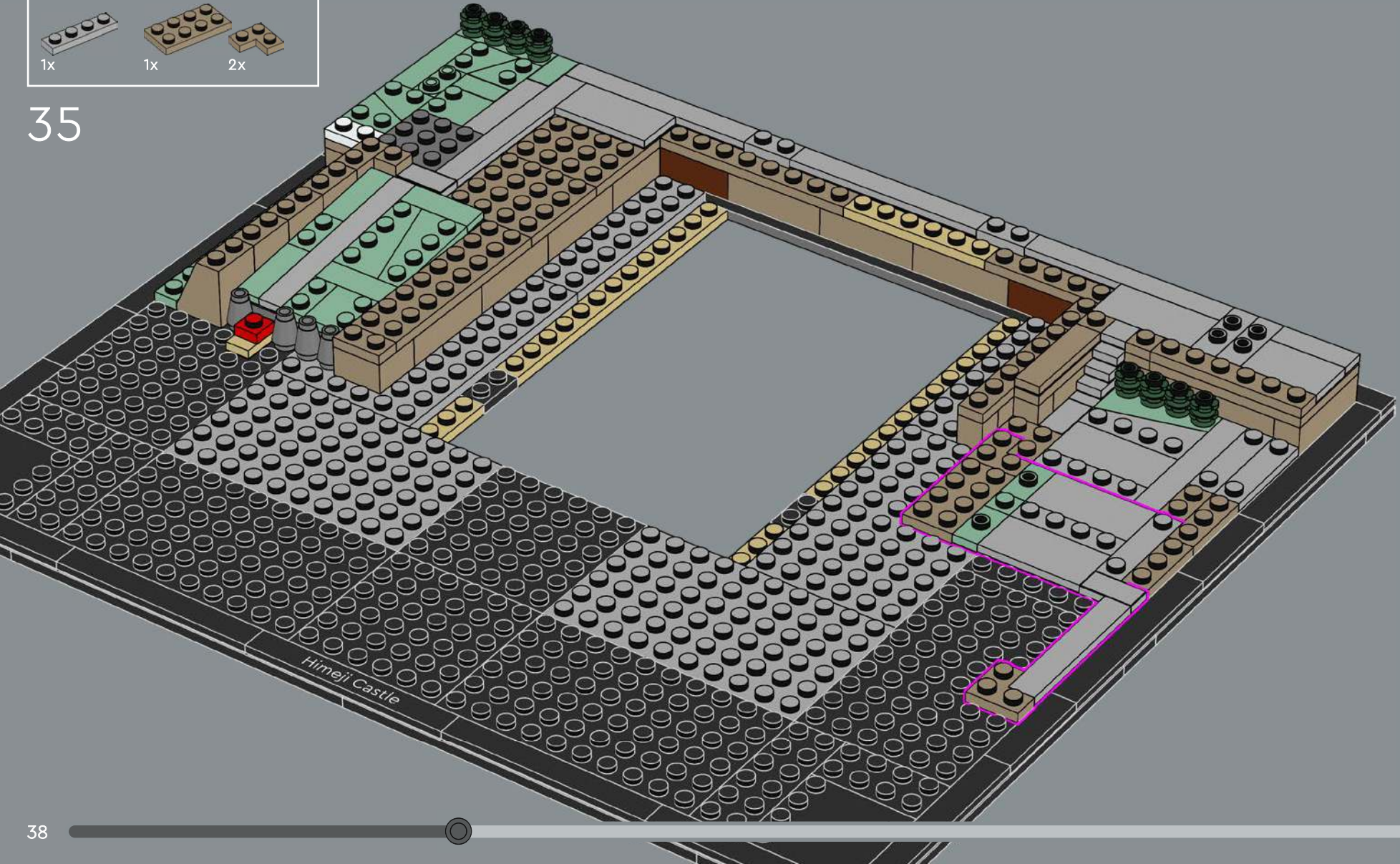

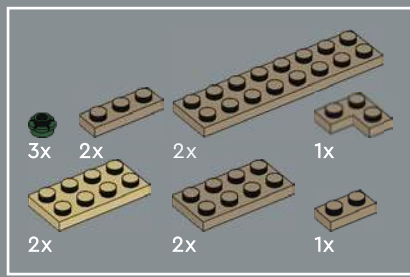

36

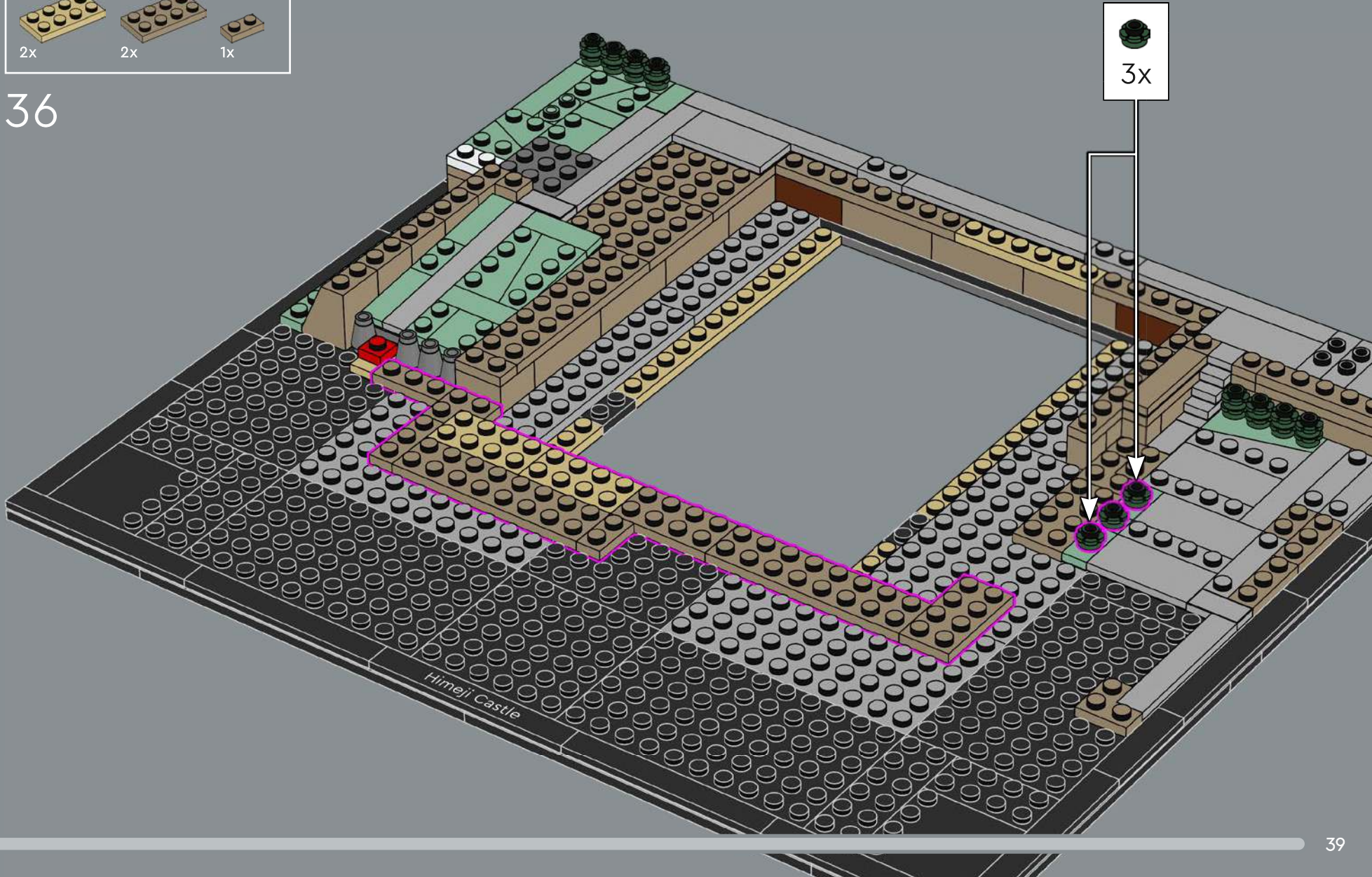

Himeji Castle

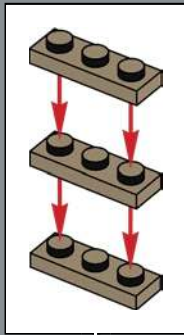
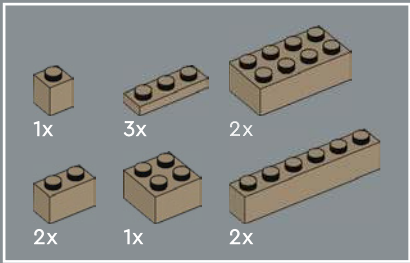

37

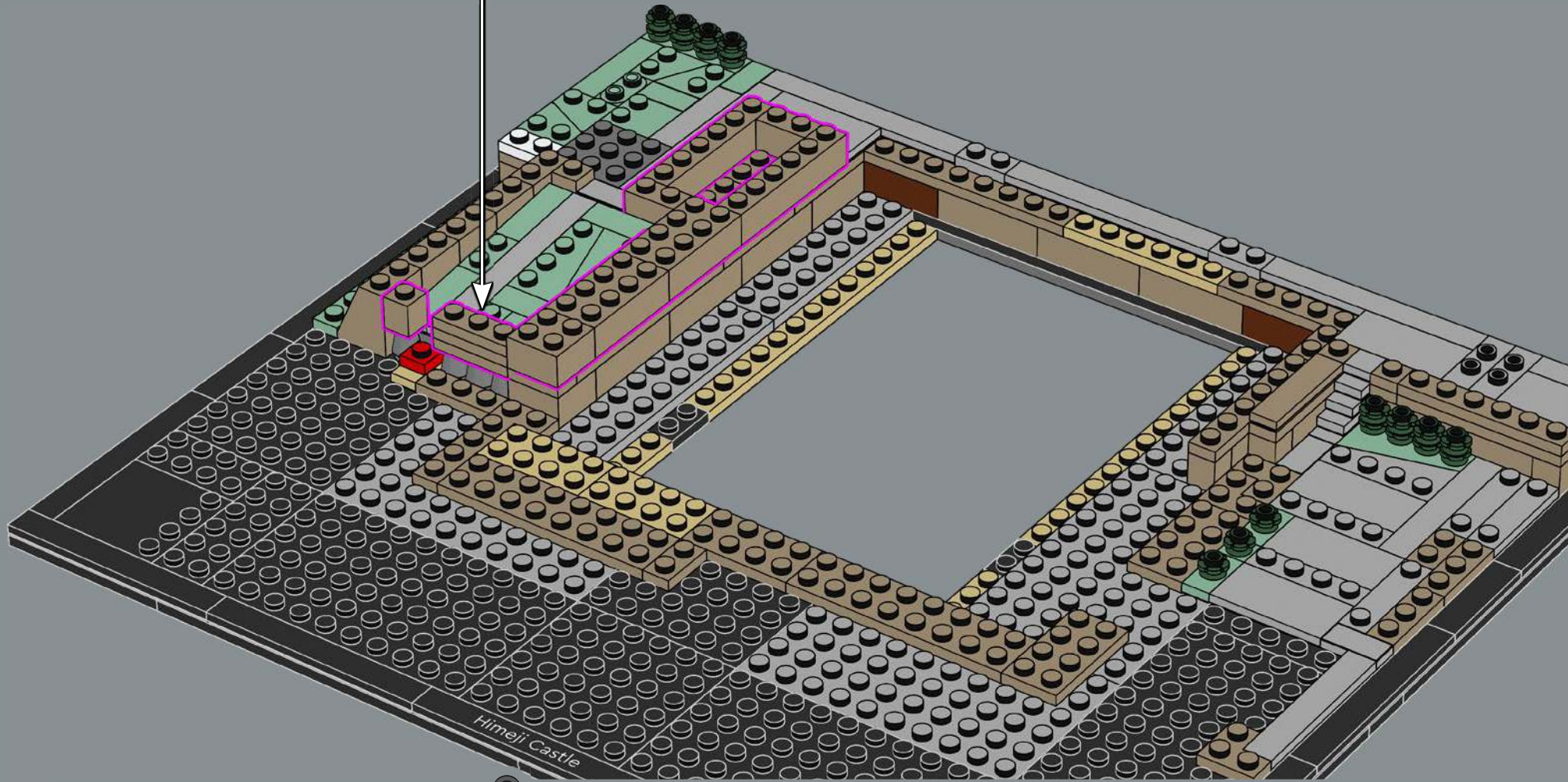

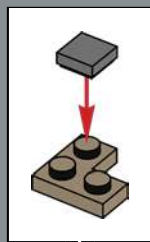
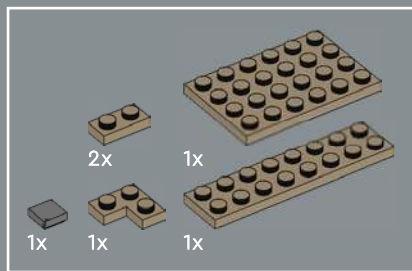

38

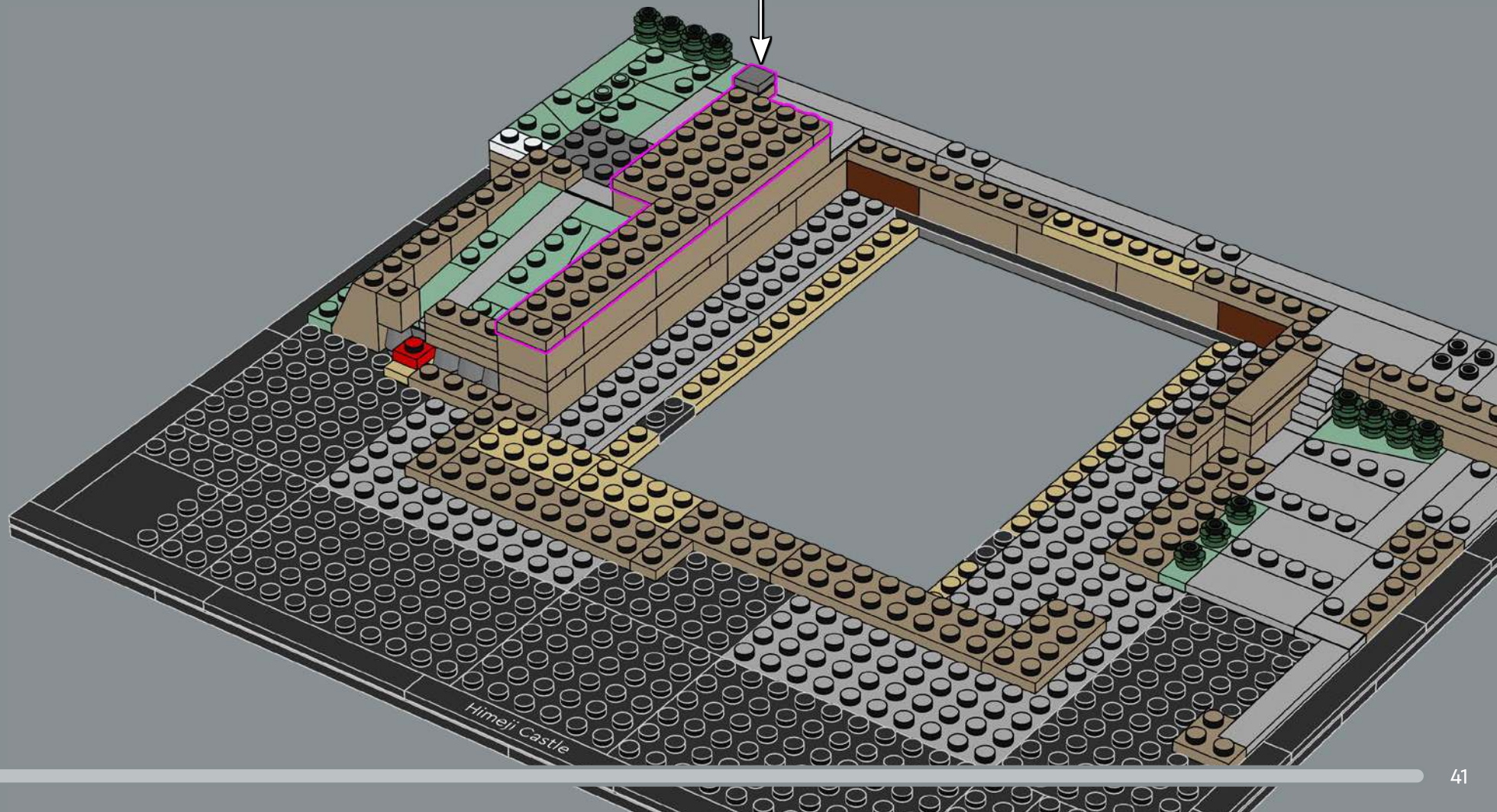

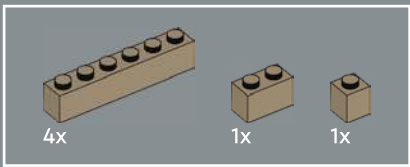

39

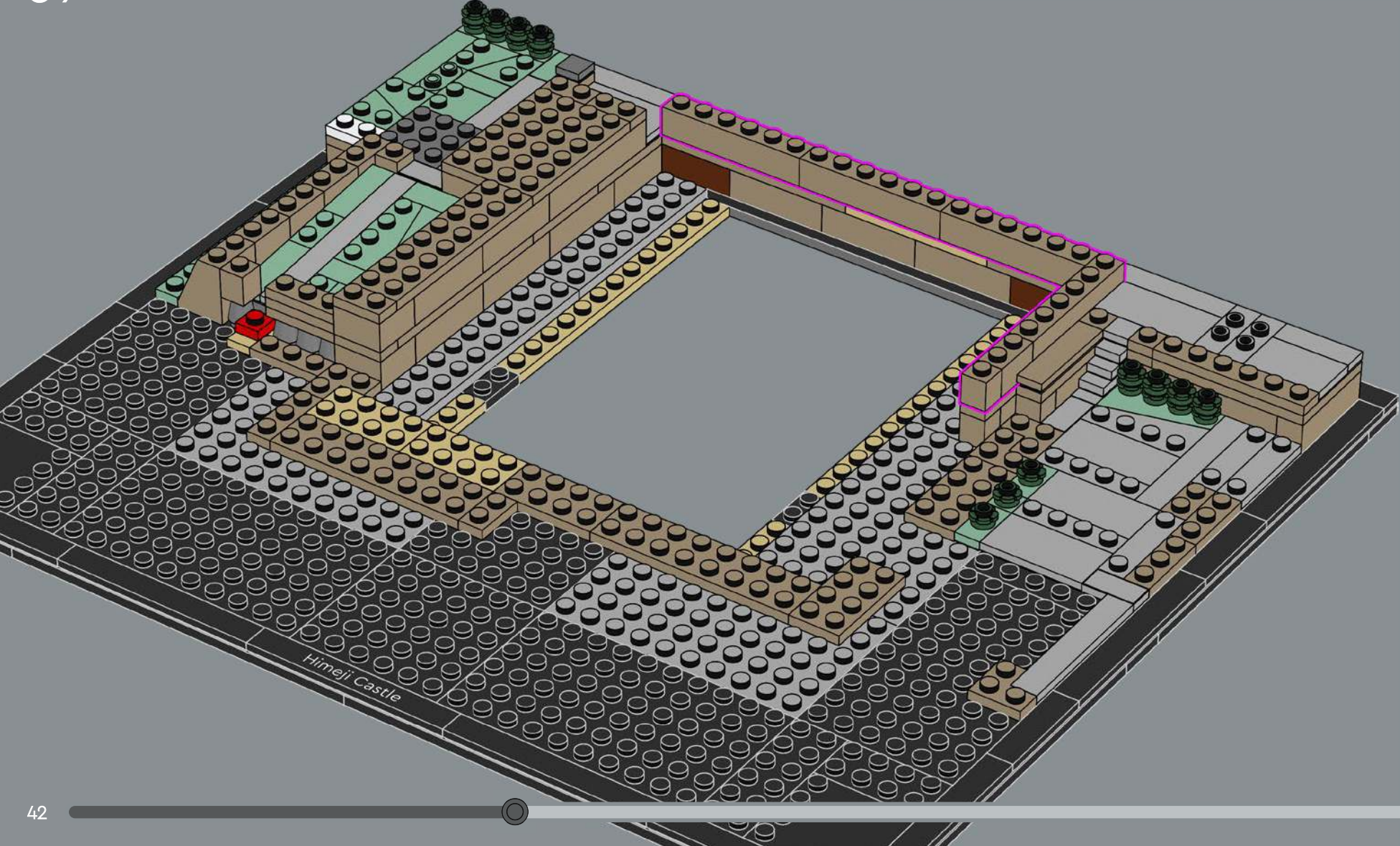

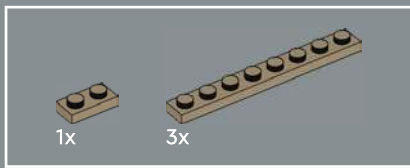

40

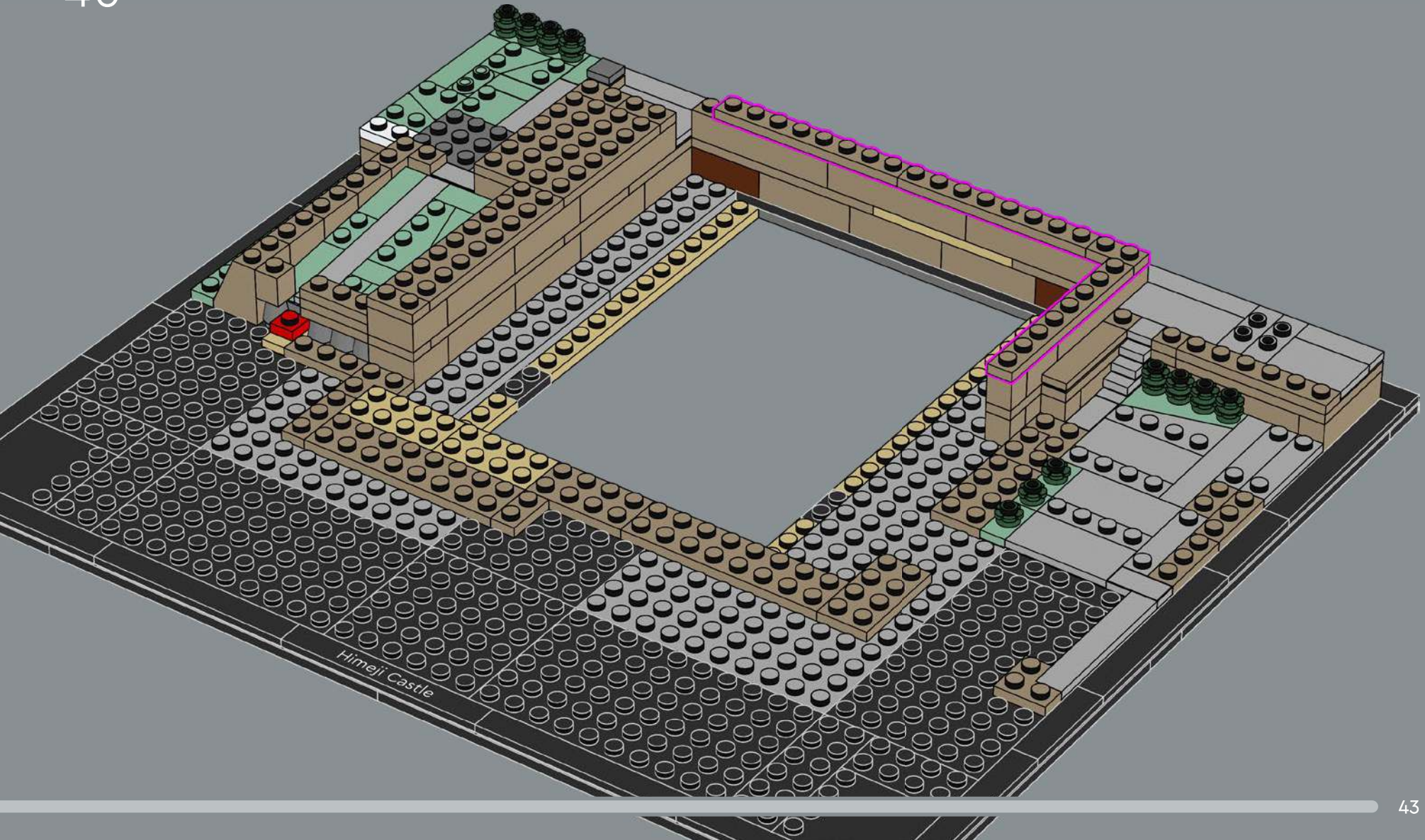

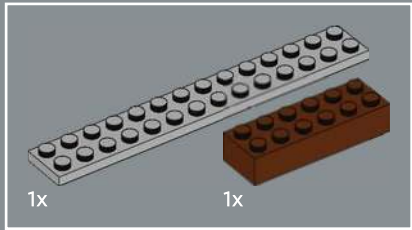
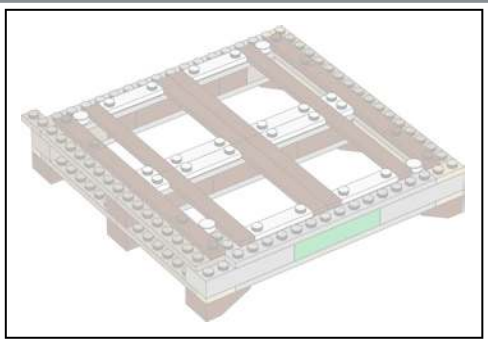

41

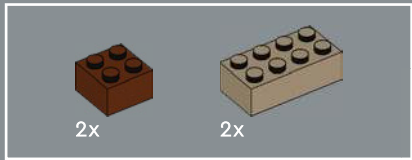
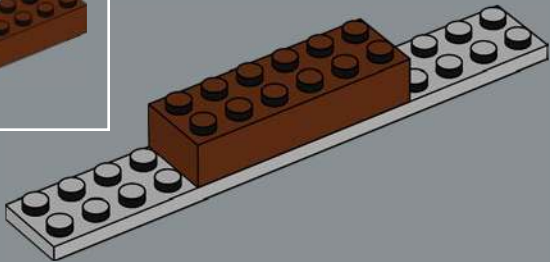

42

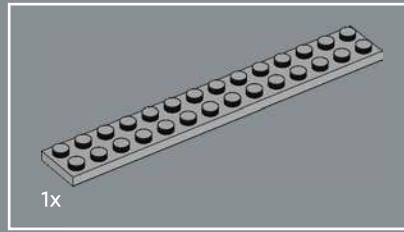
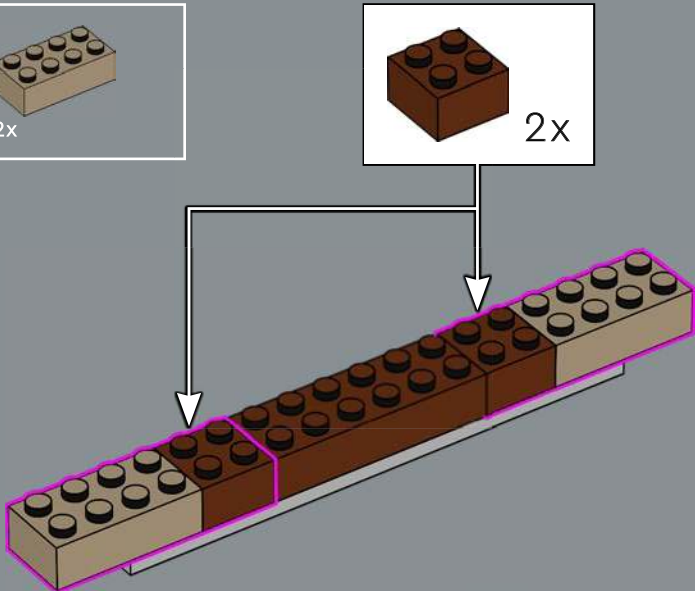

43

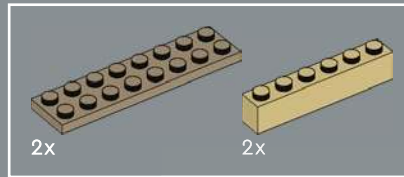
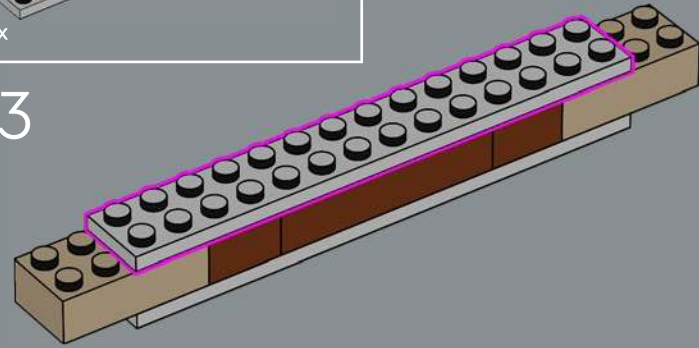

44

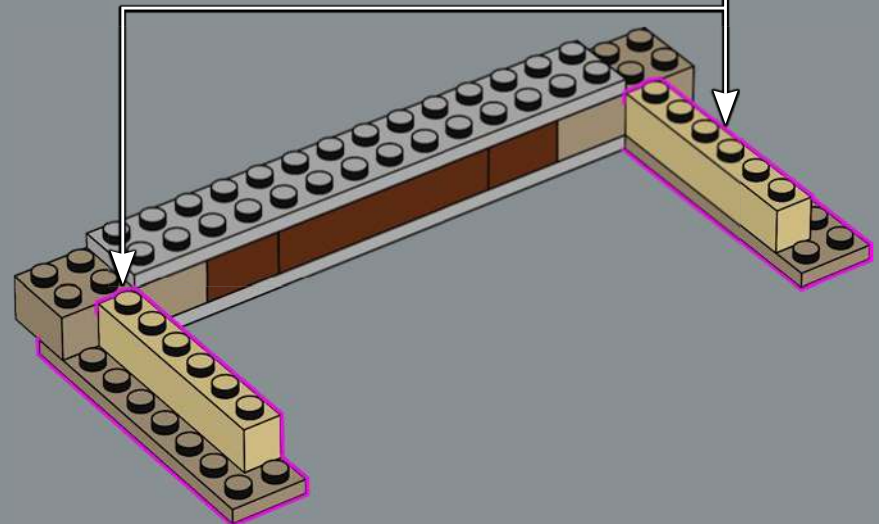
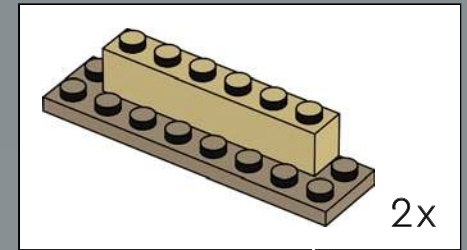

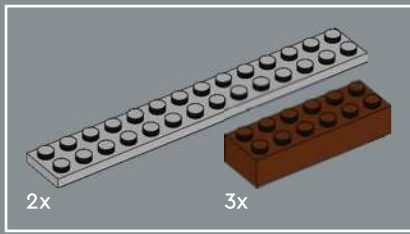

45

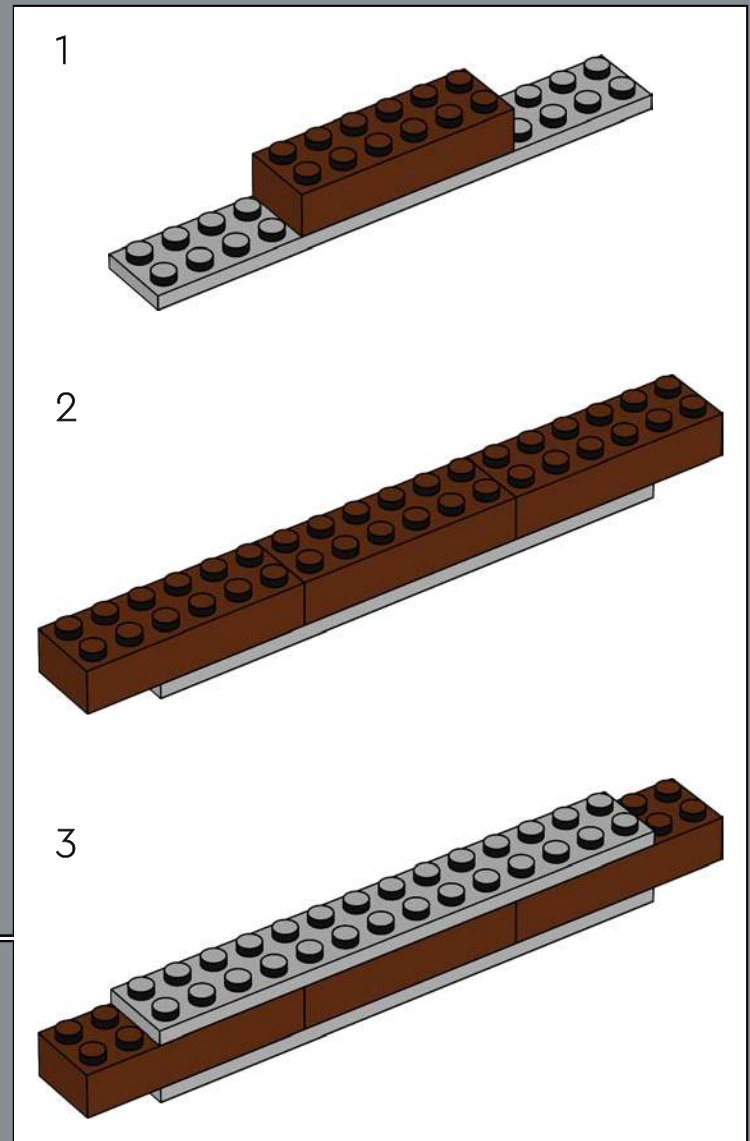
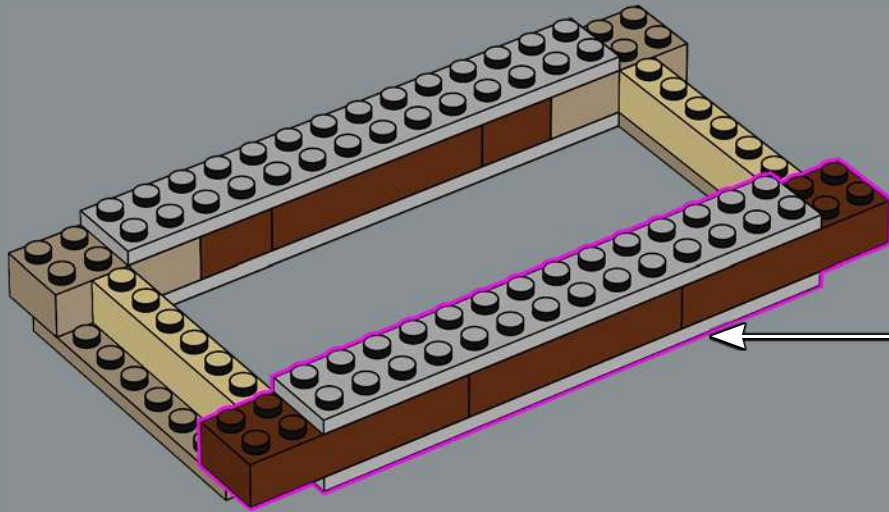

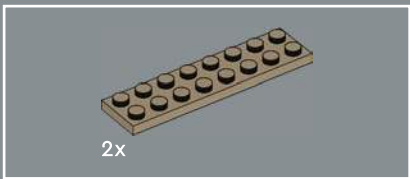

46

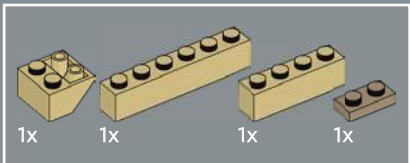
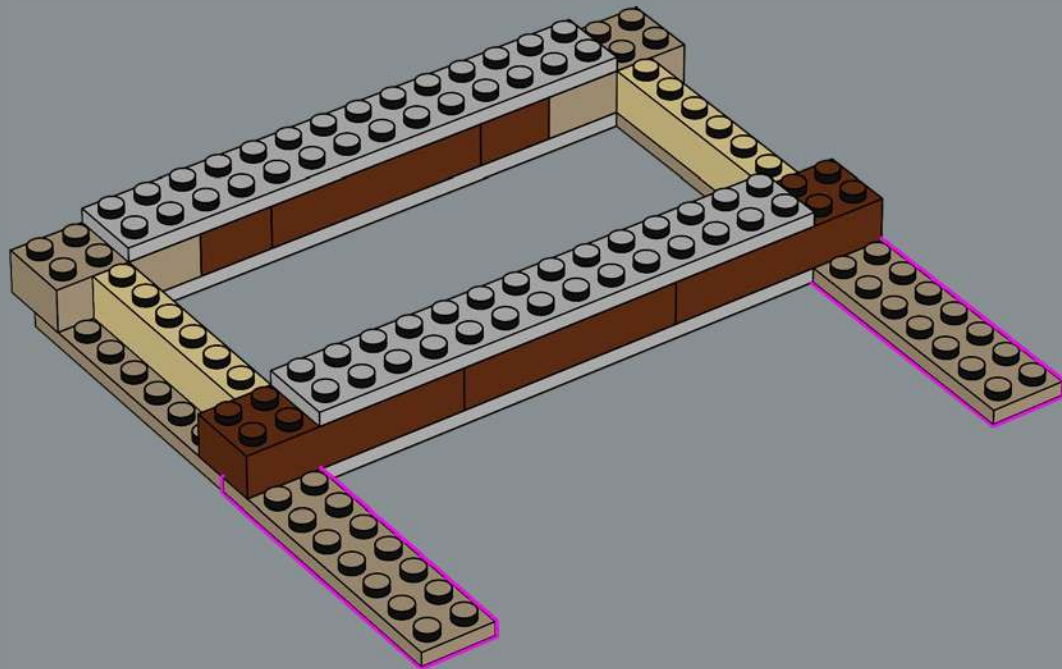

47

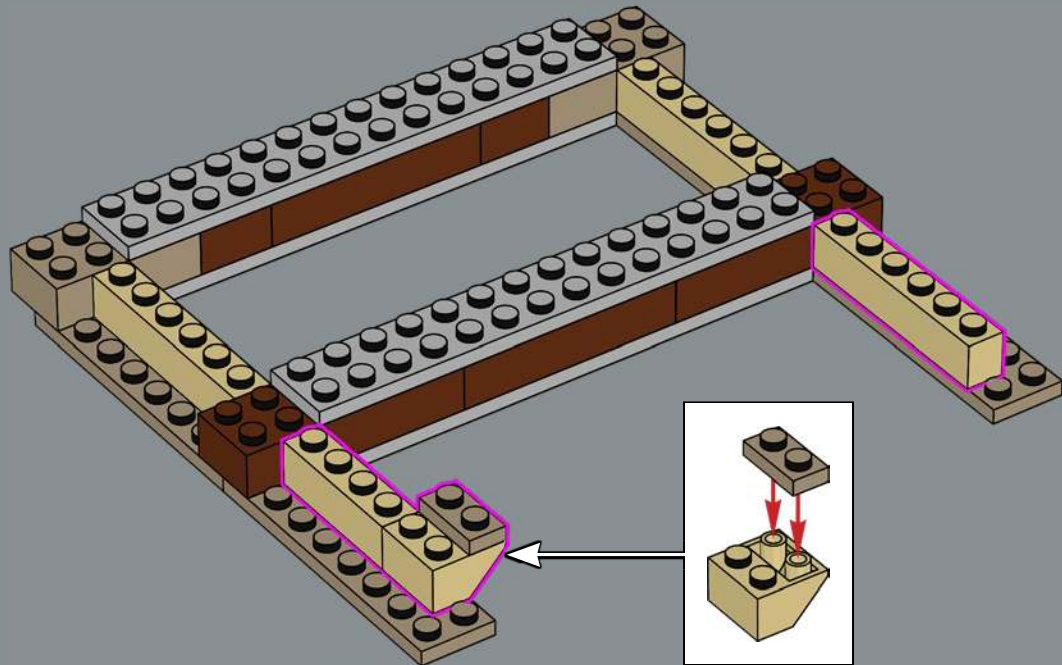

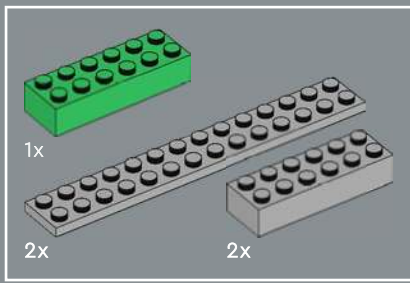

48

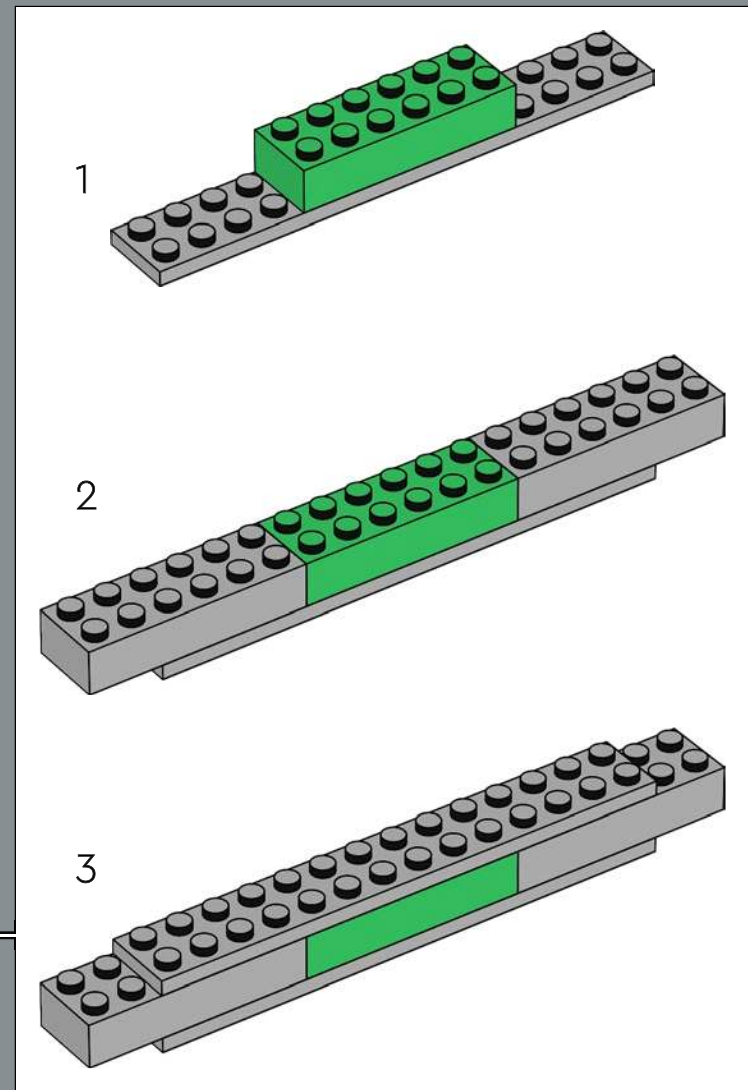

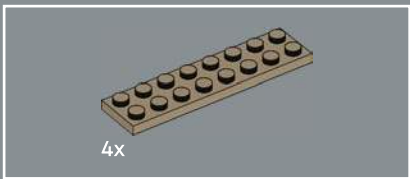

49

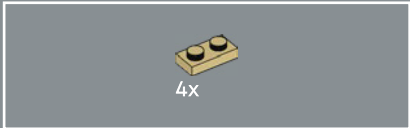
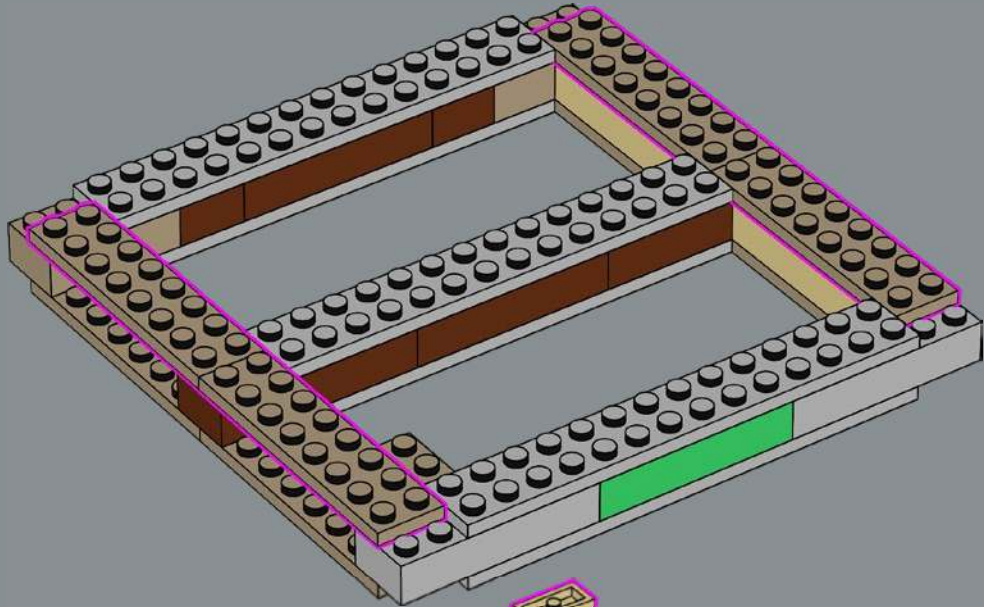

50

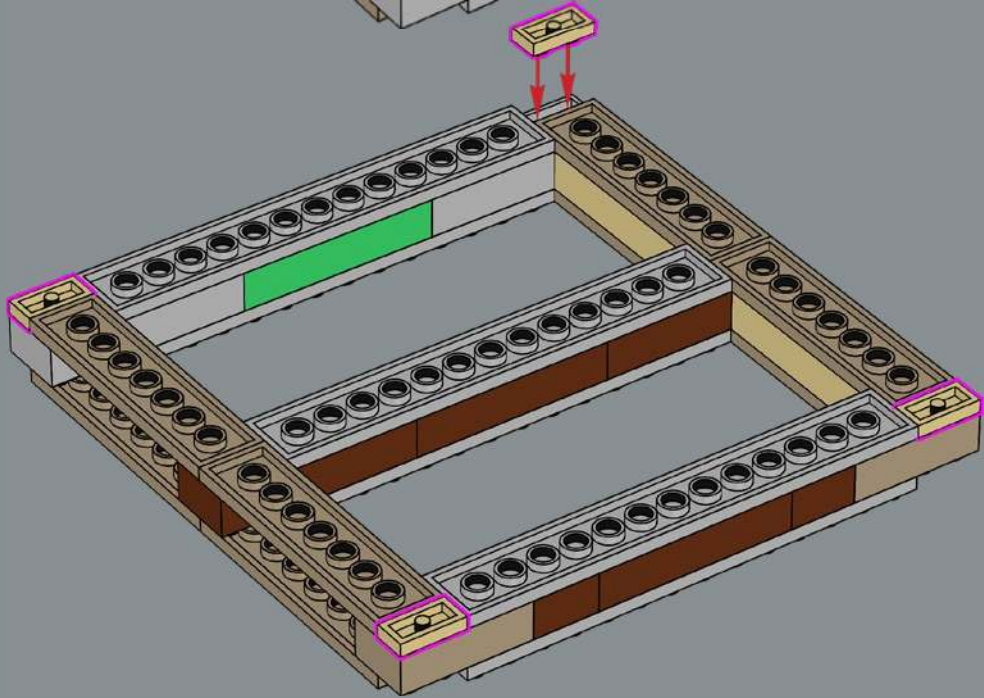



51

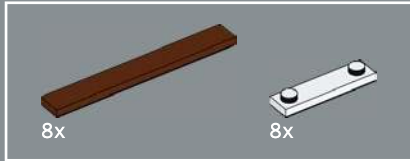
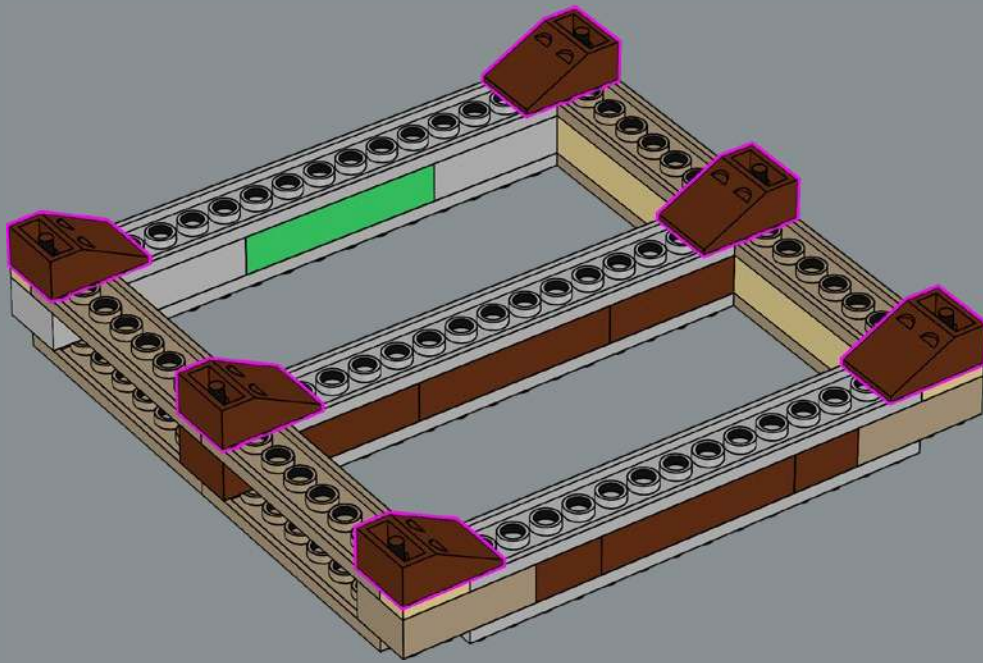

52

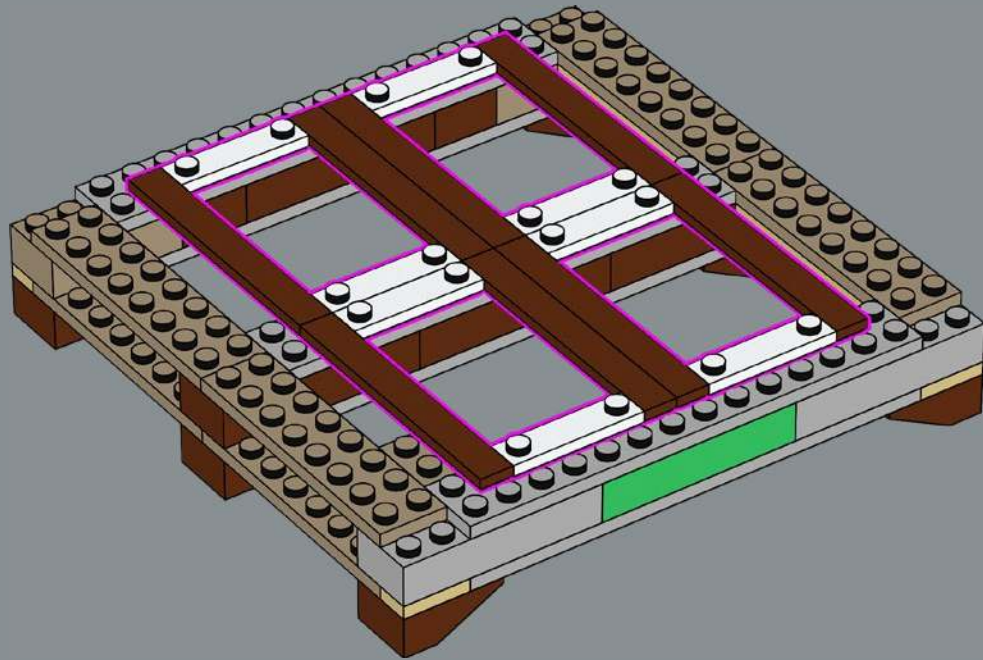

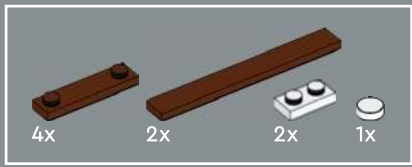

53

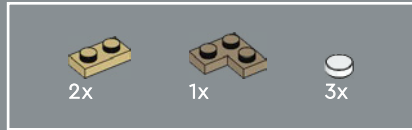
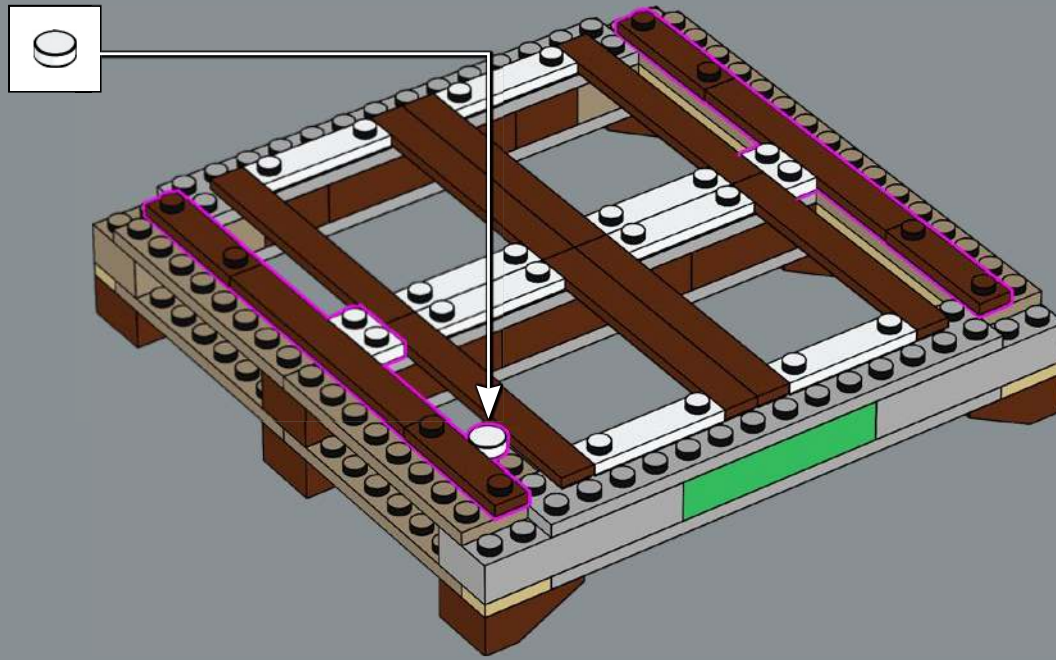

54

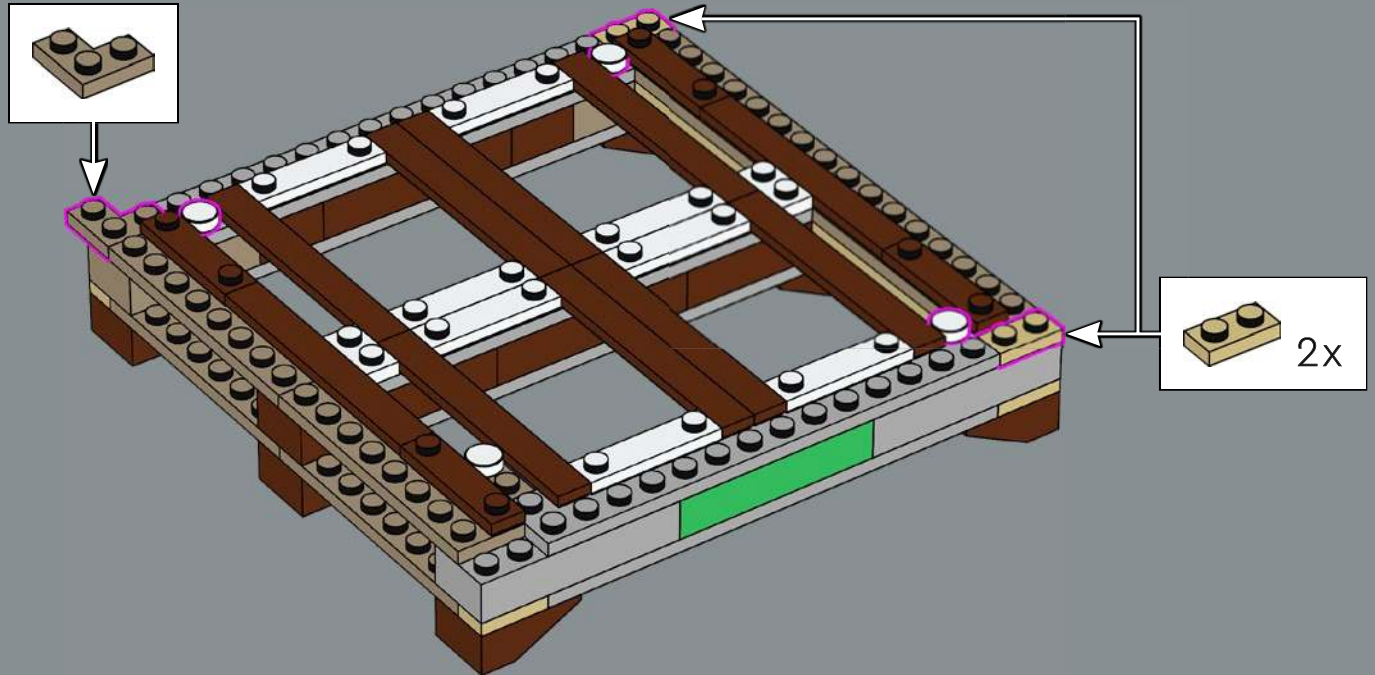

55

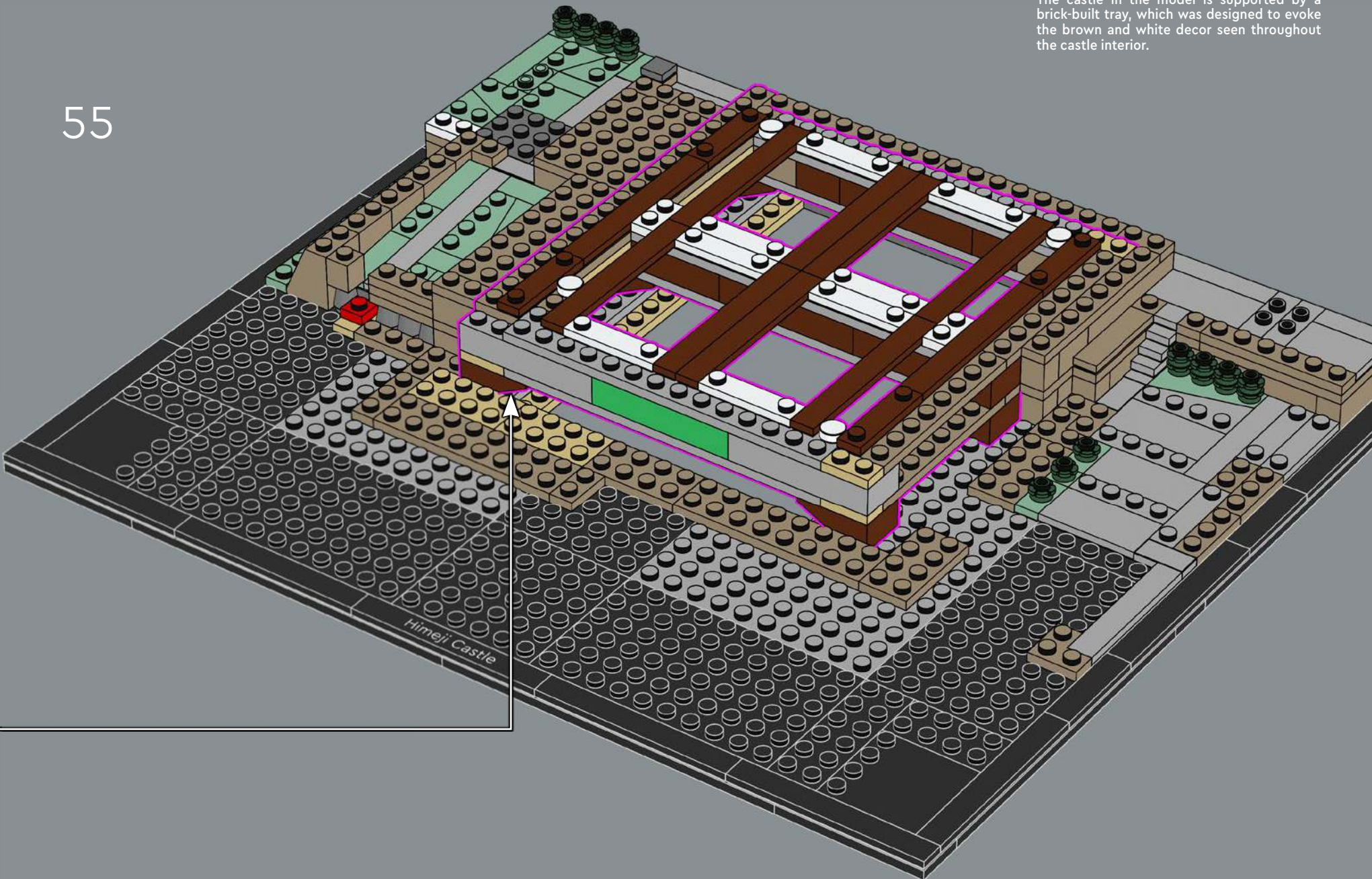

The castle in the model is supported by a brick-built tray, which was designed to evoke the brown and white decor seen throughout the castle interior.

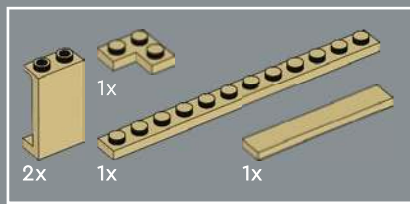

56

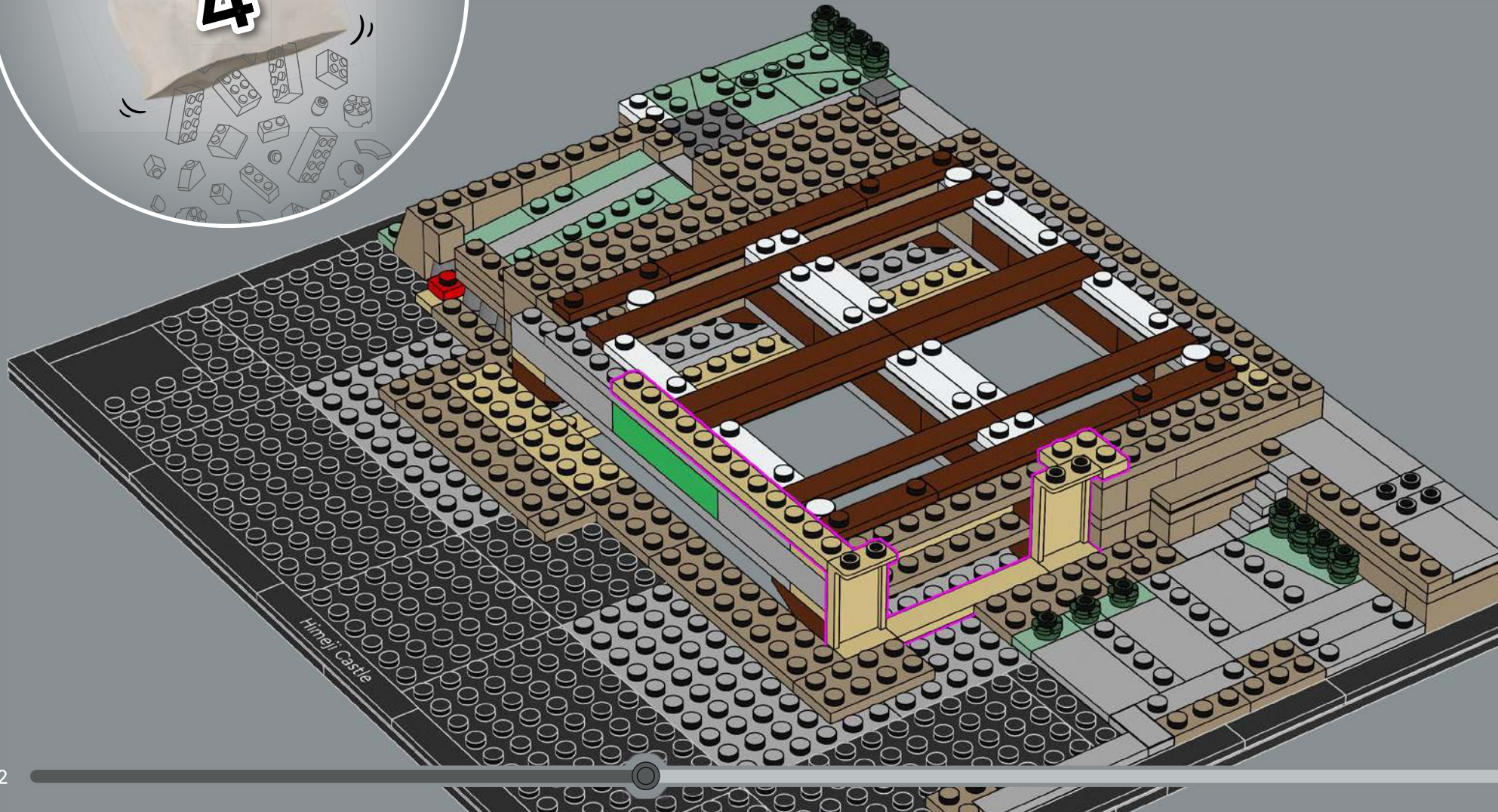

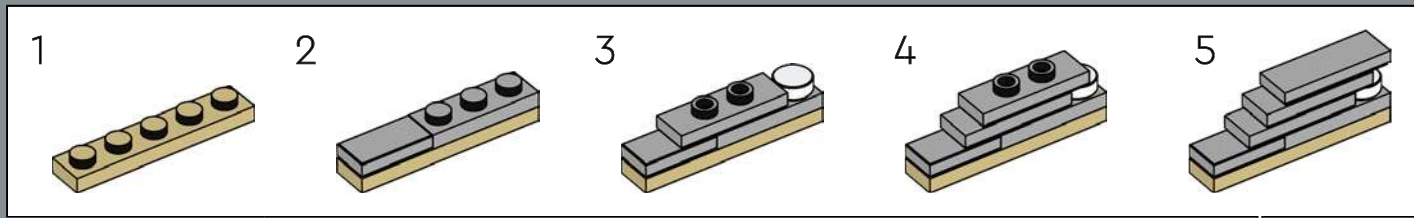
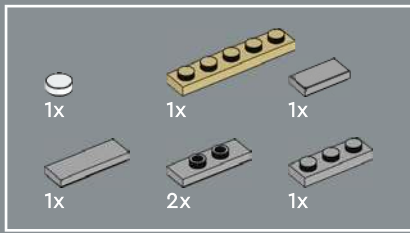

57

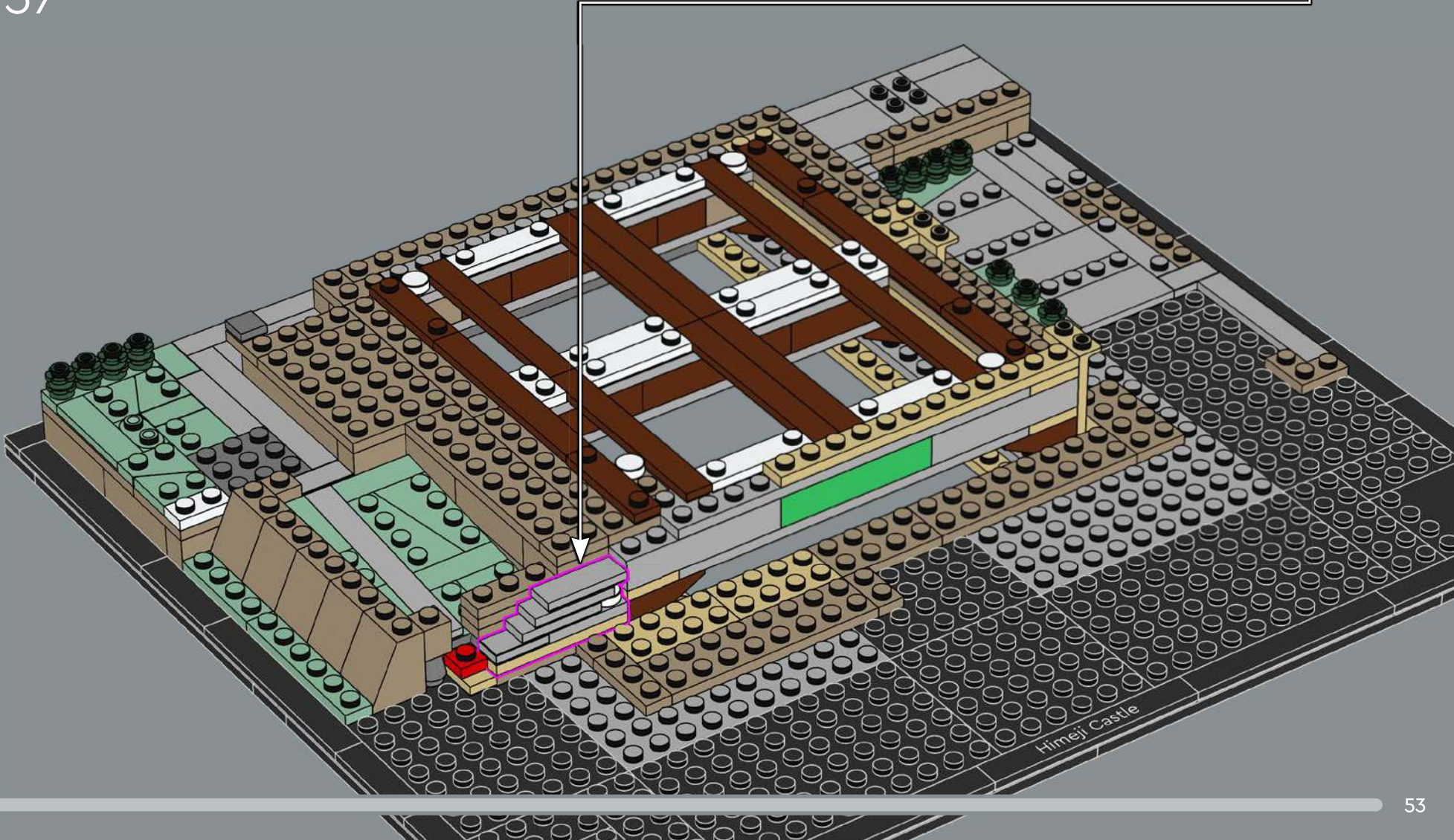

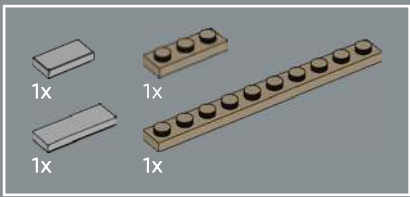

58

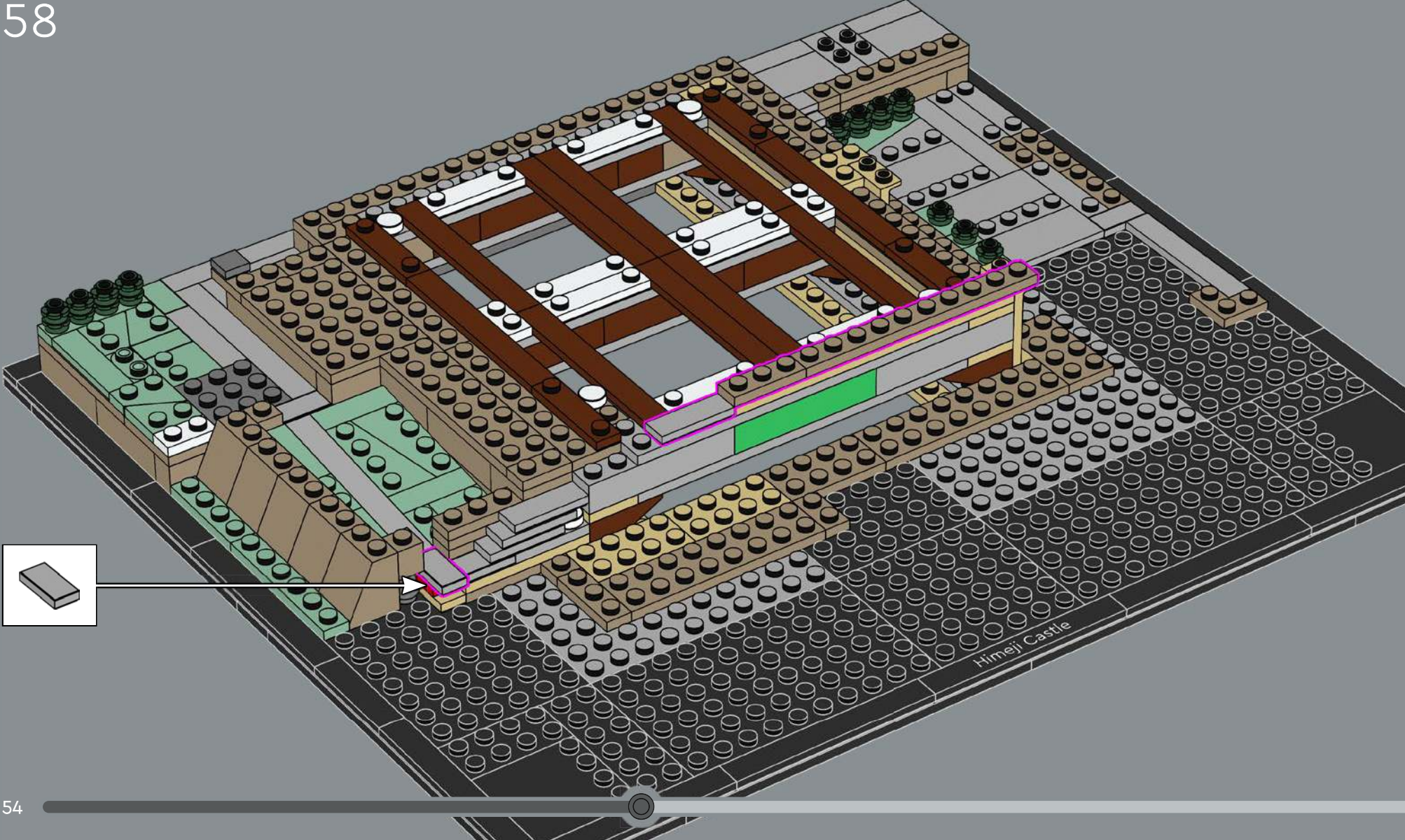

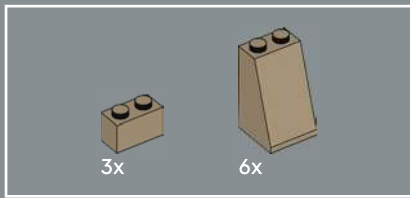

59

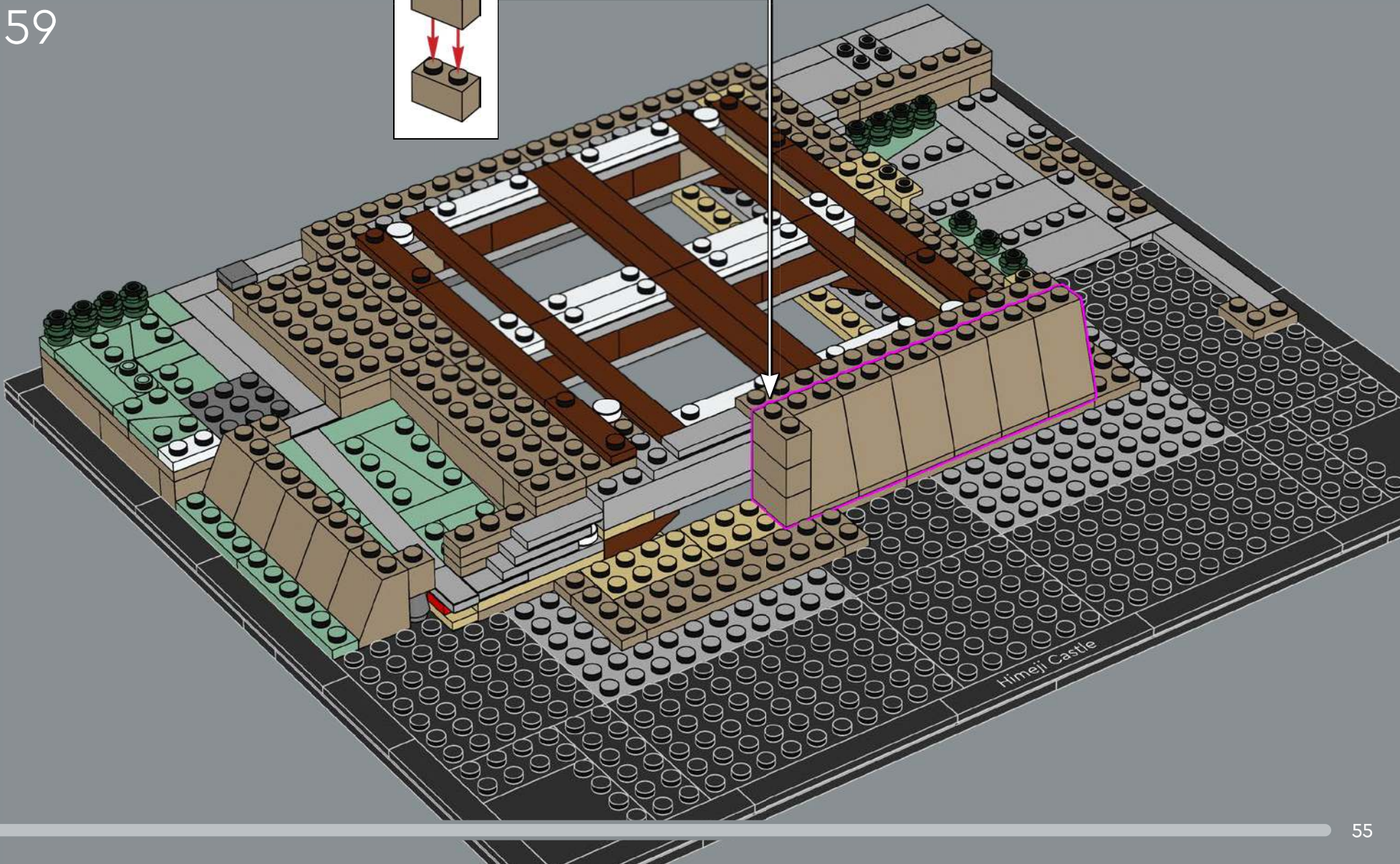
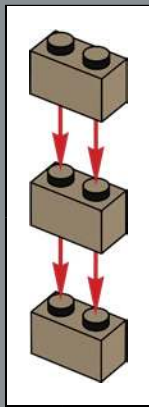

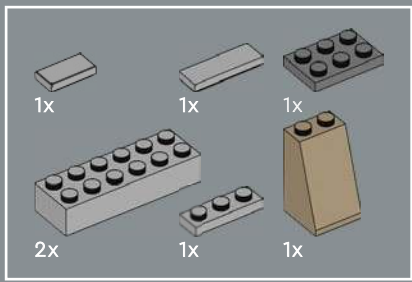

60

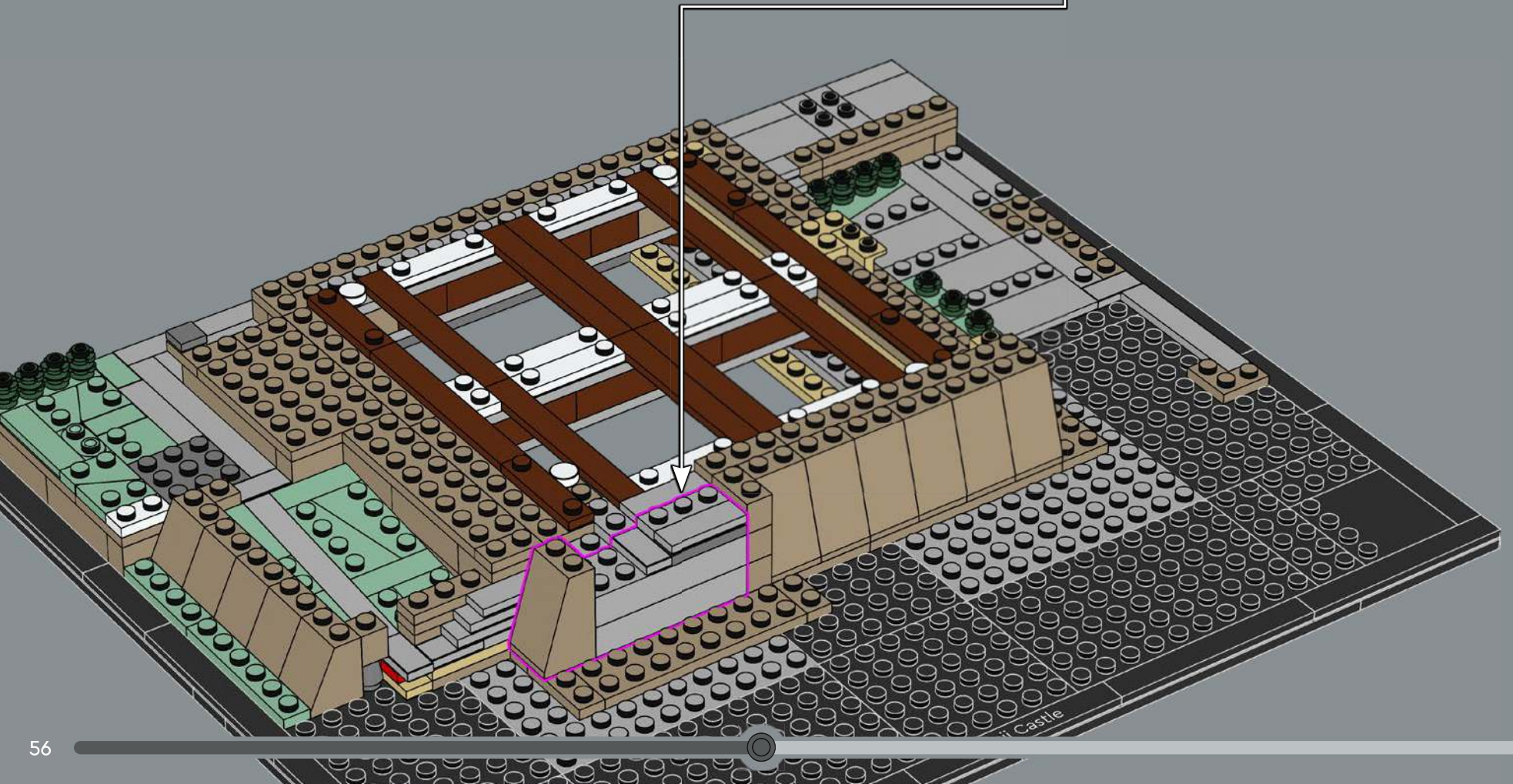
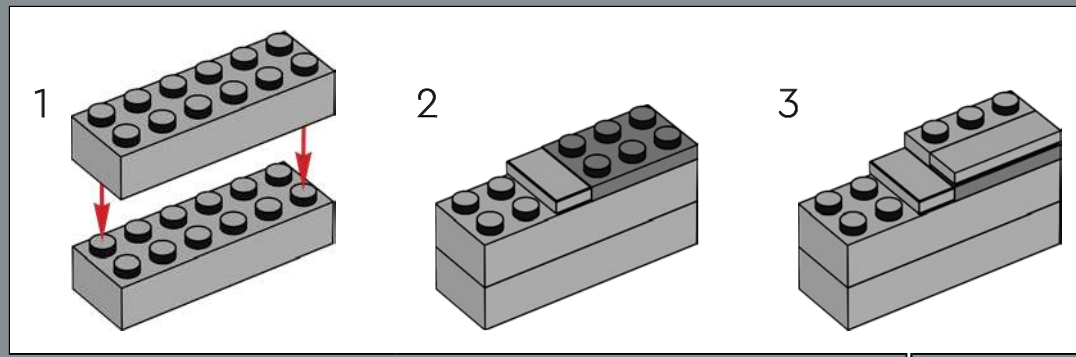

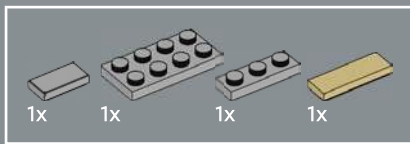

61

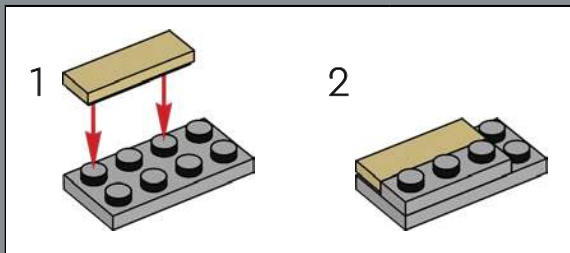
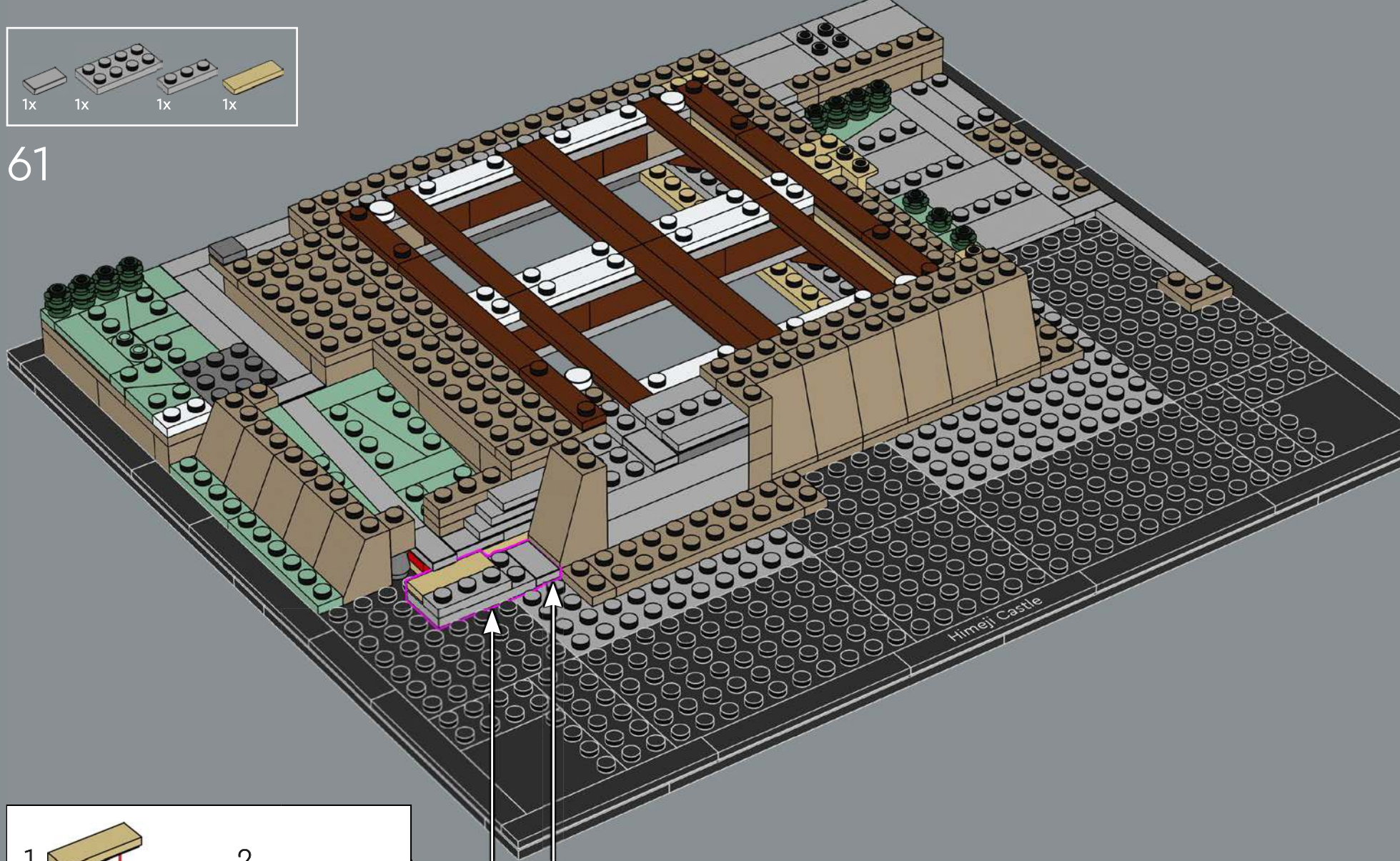

2

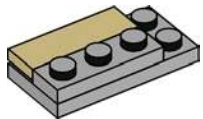

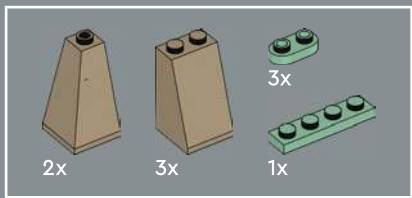

62

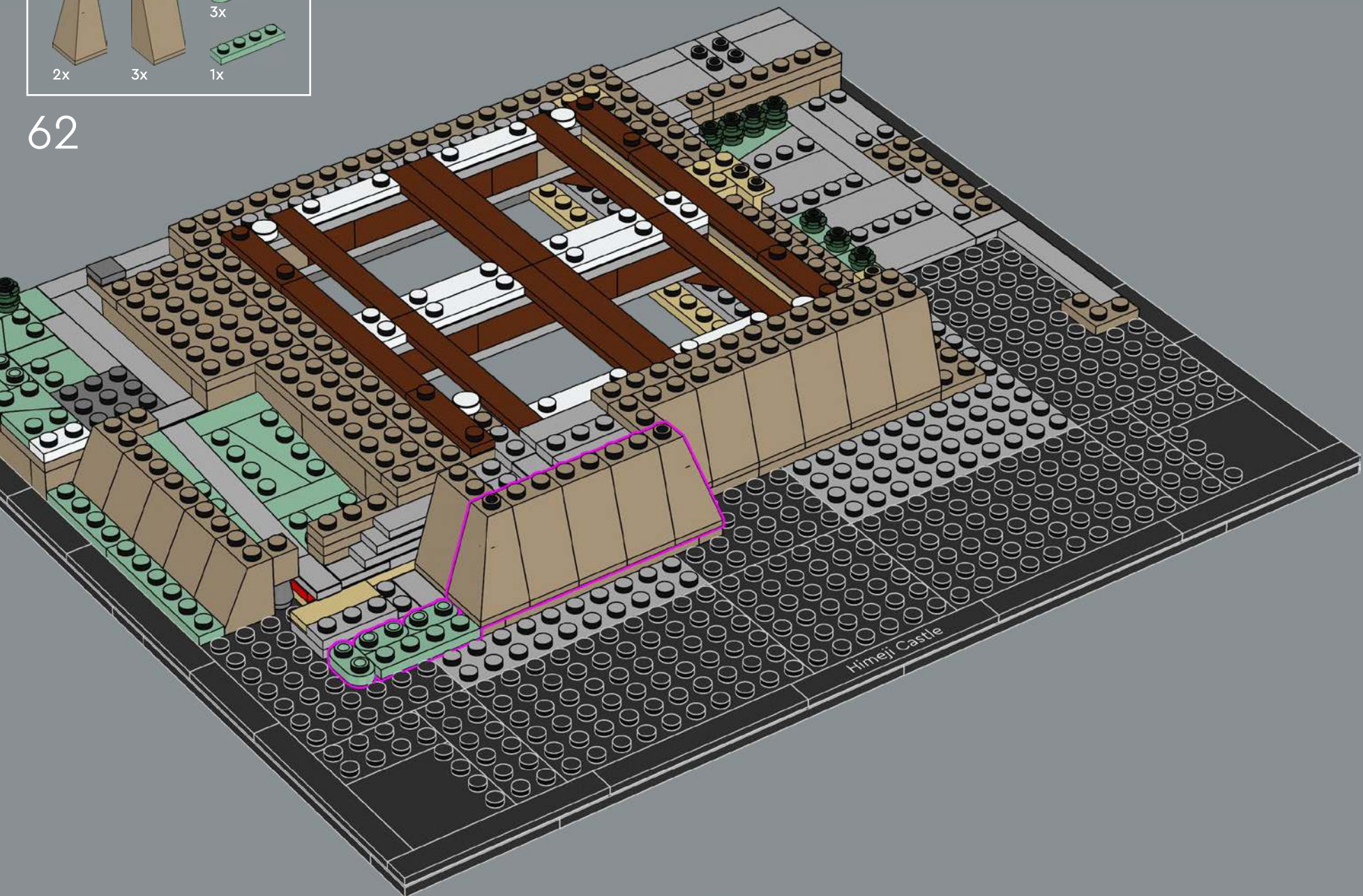

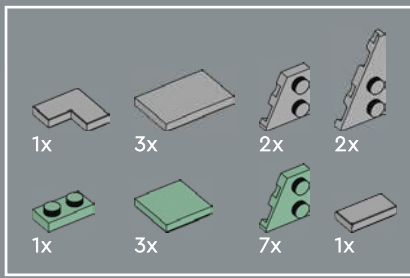

63

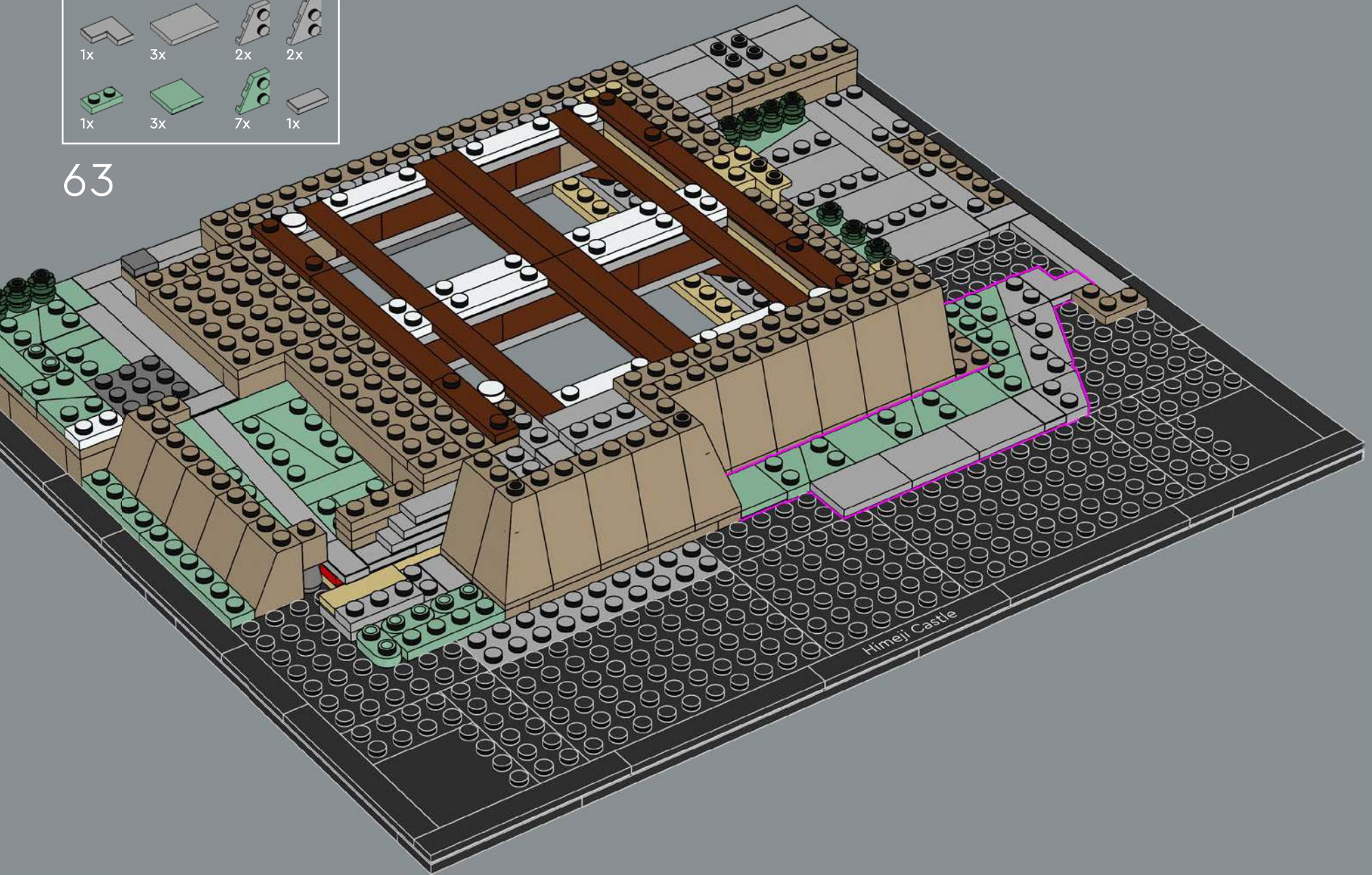

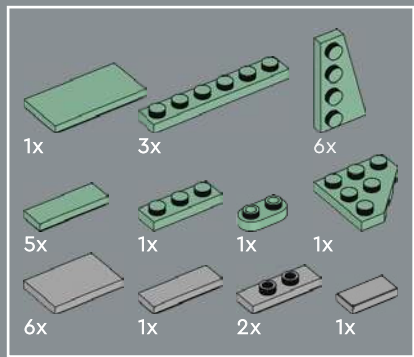

64

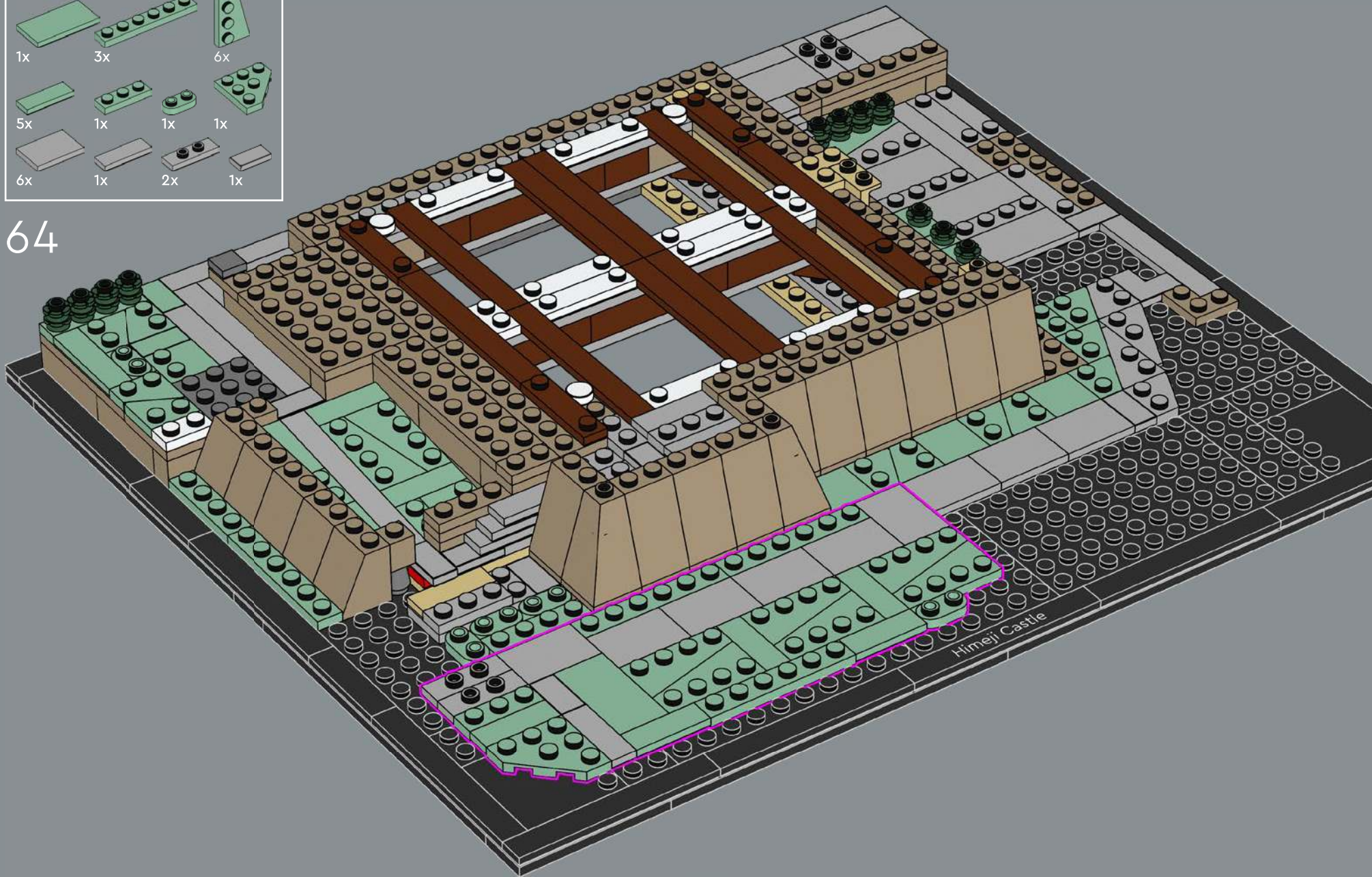

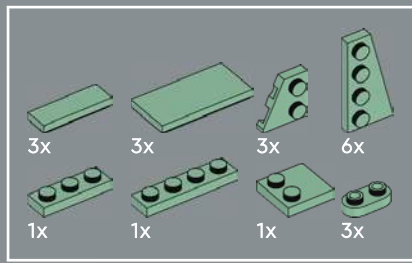

65

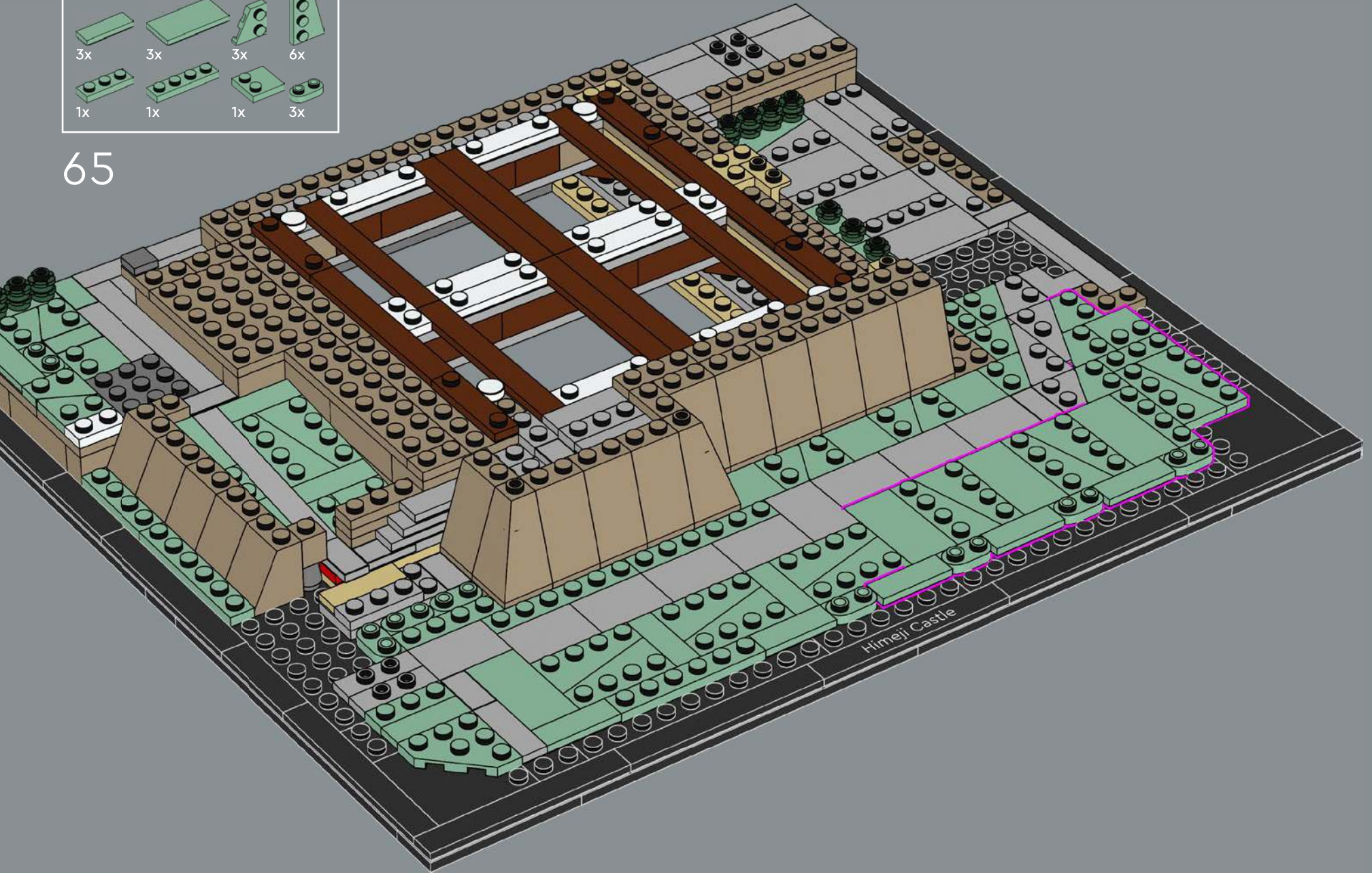

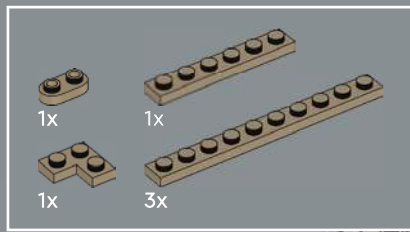

66

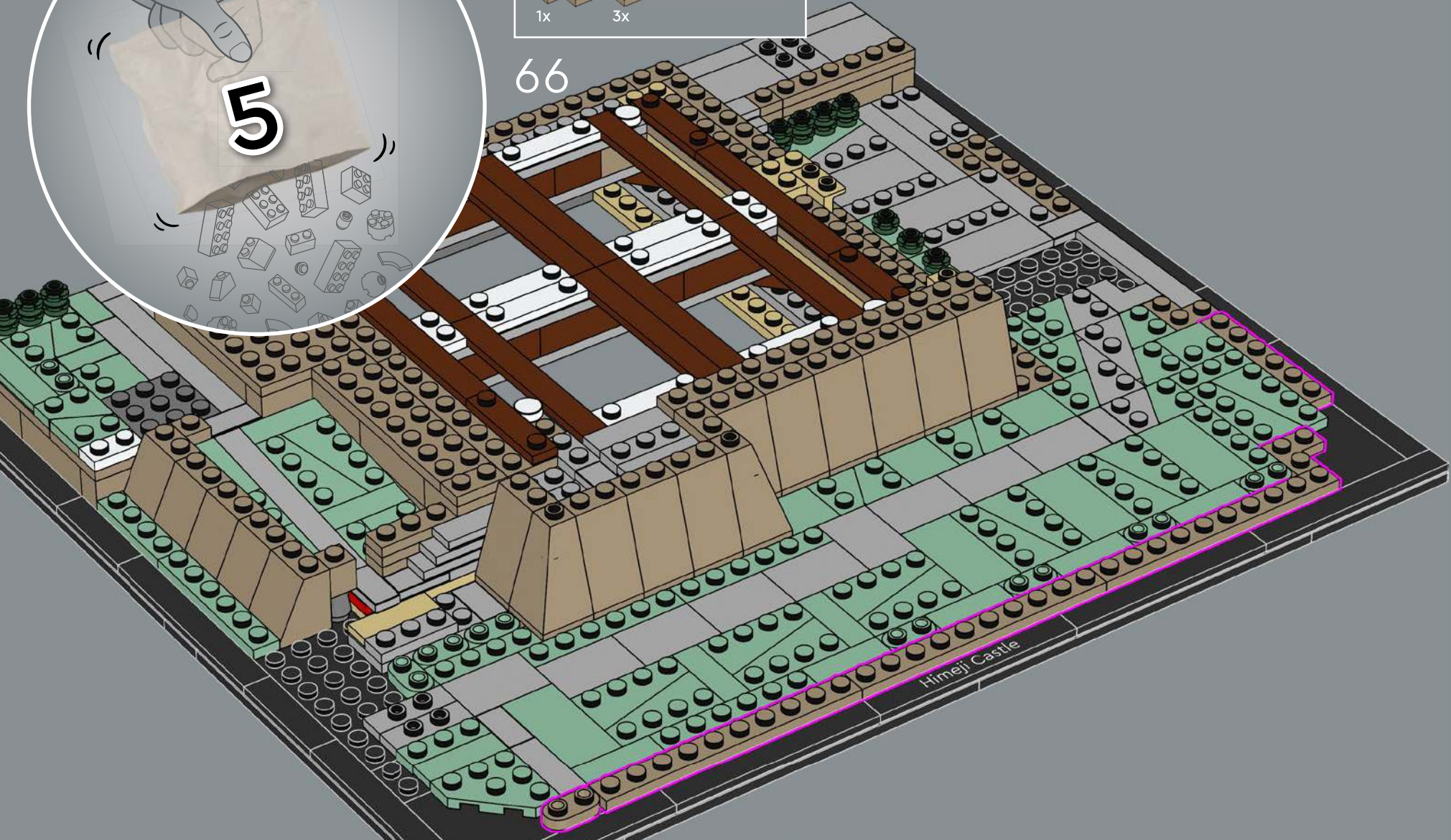

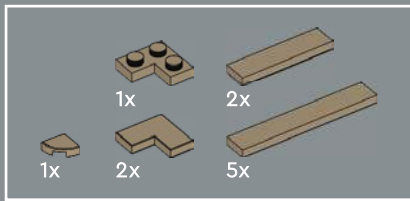

67

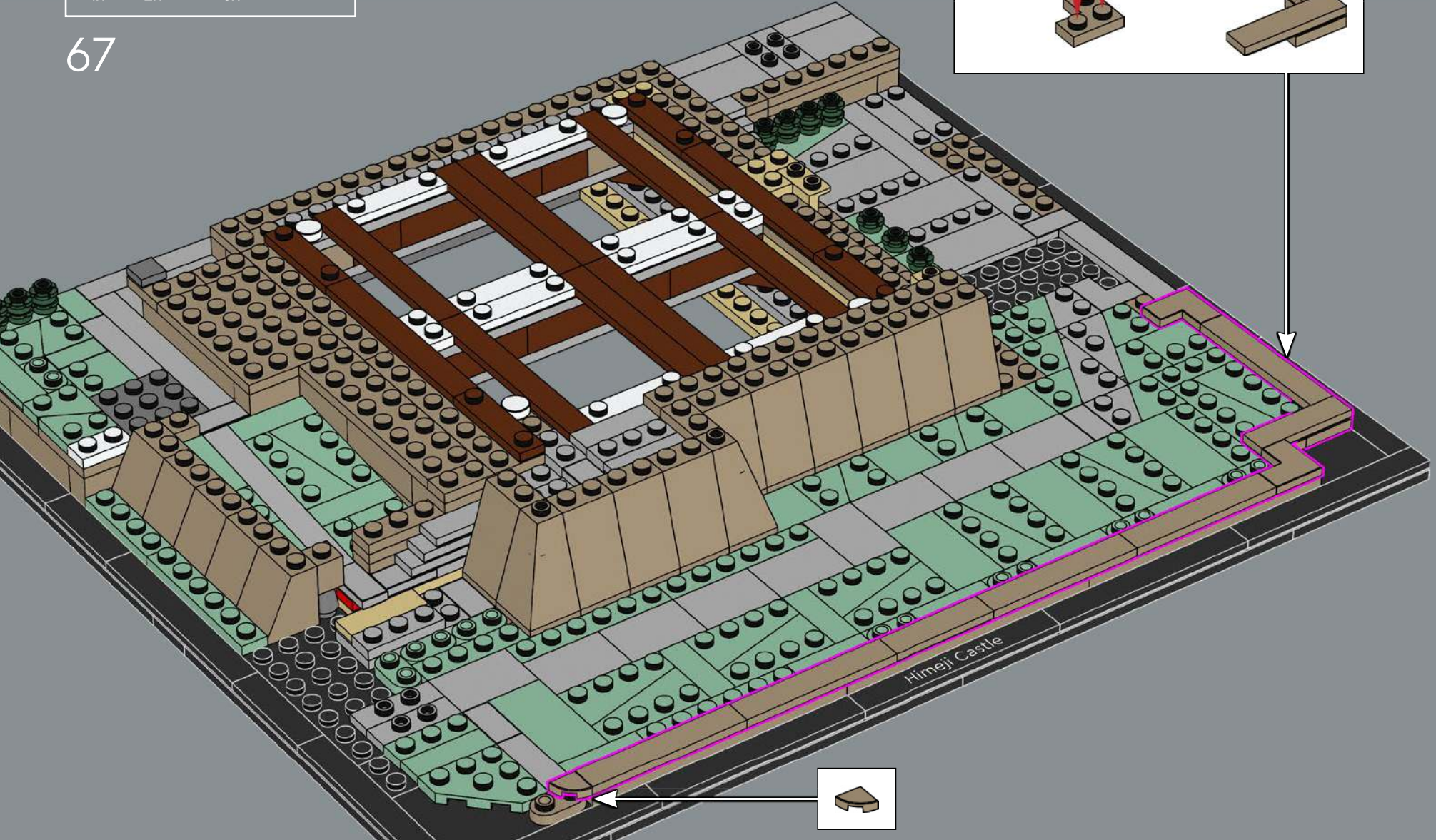
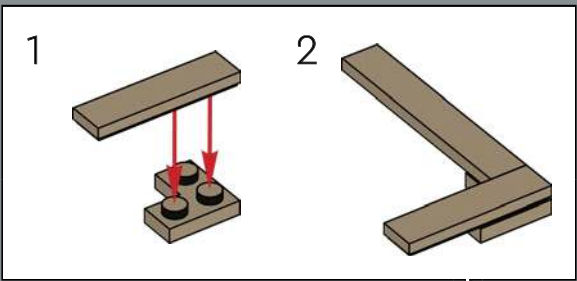

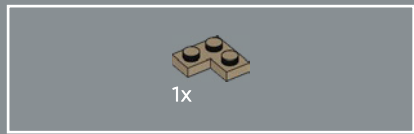

68

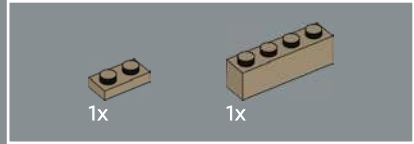

69

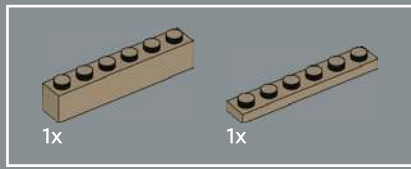
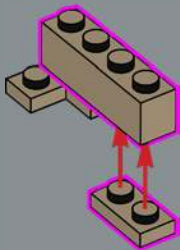

70

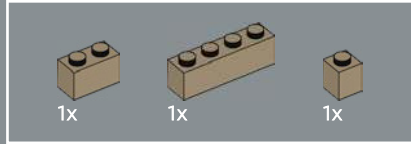
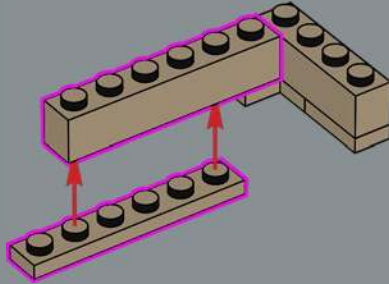

71

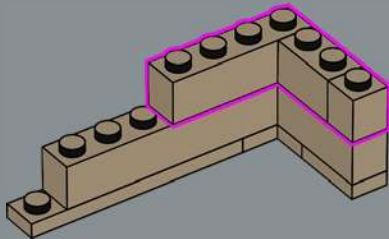

72

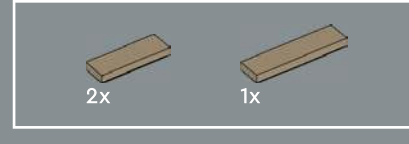
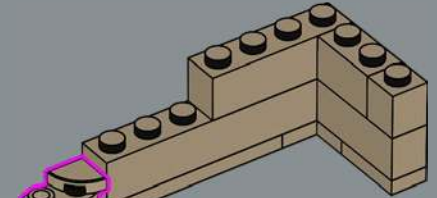
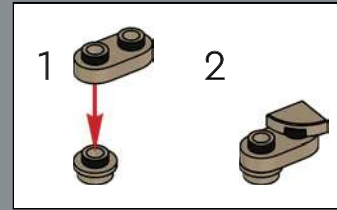

73

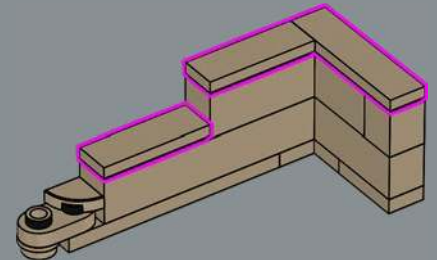

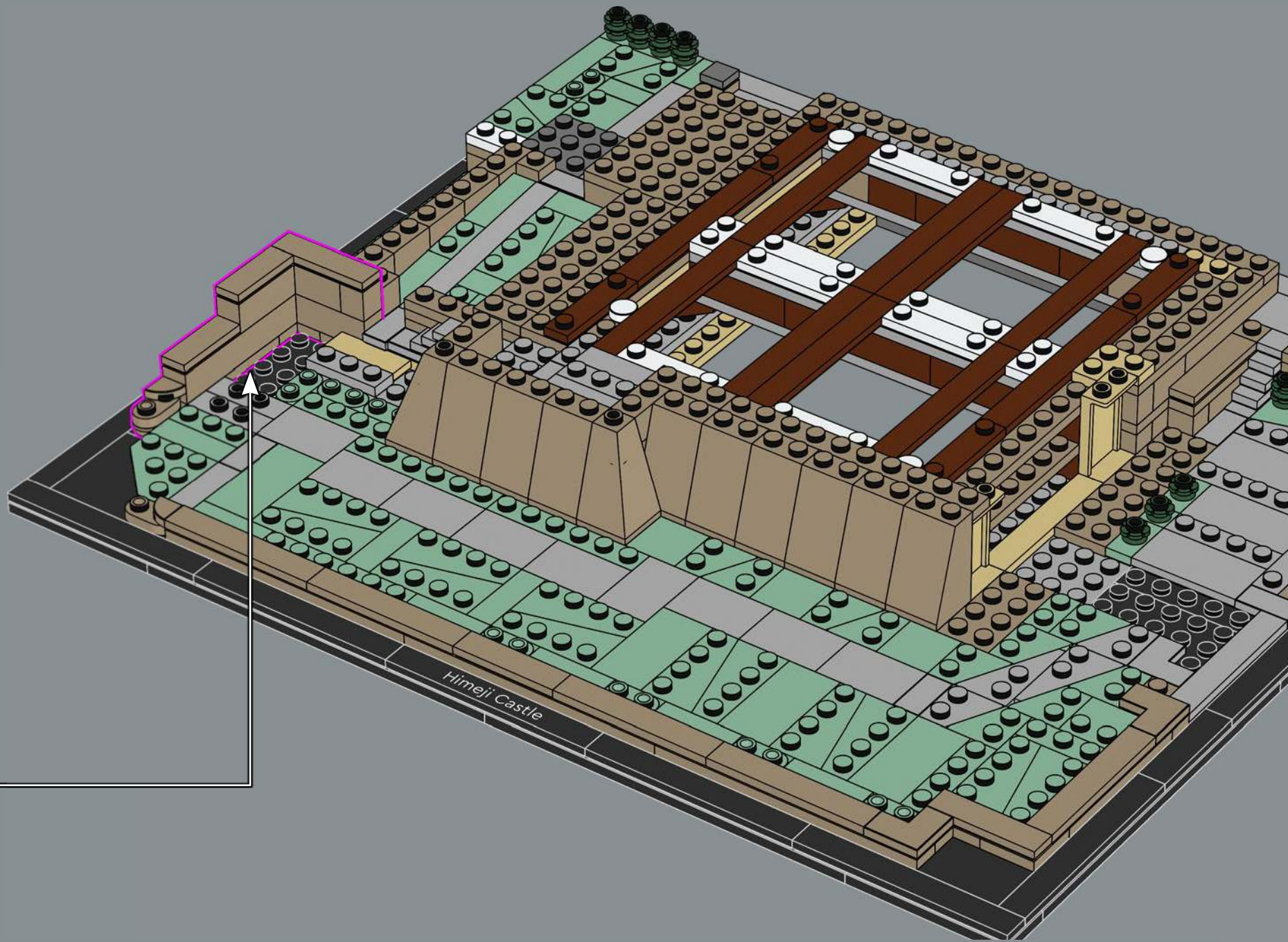

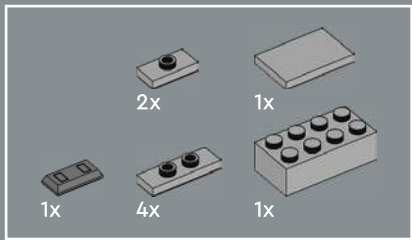

75

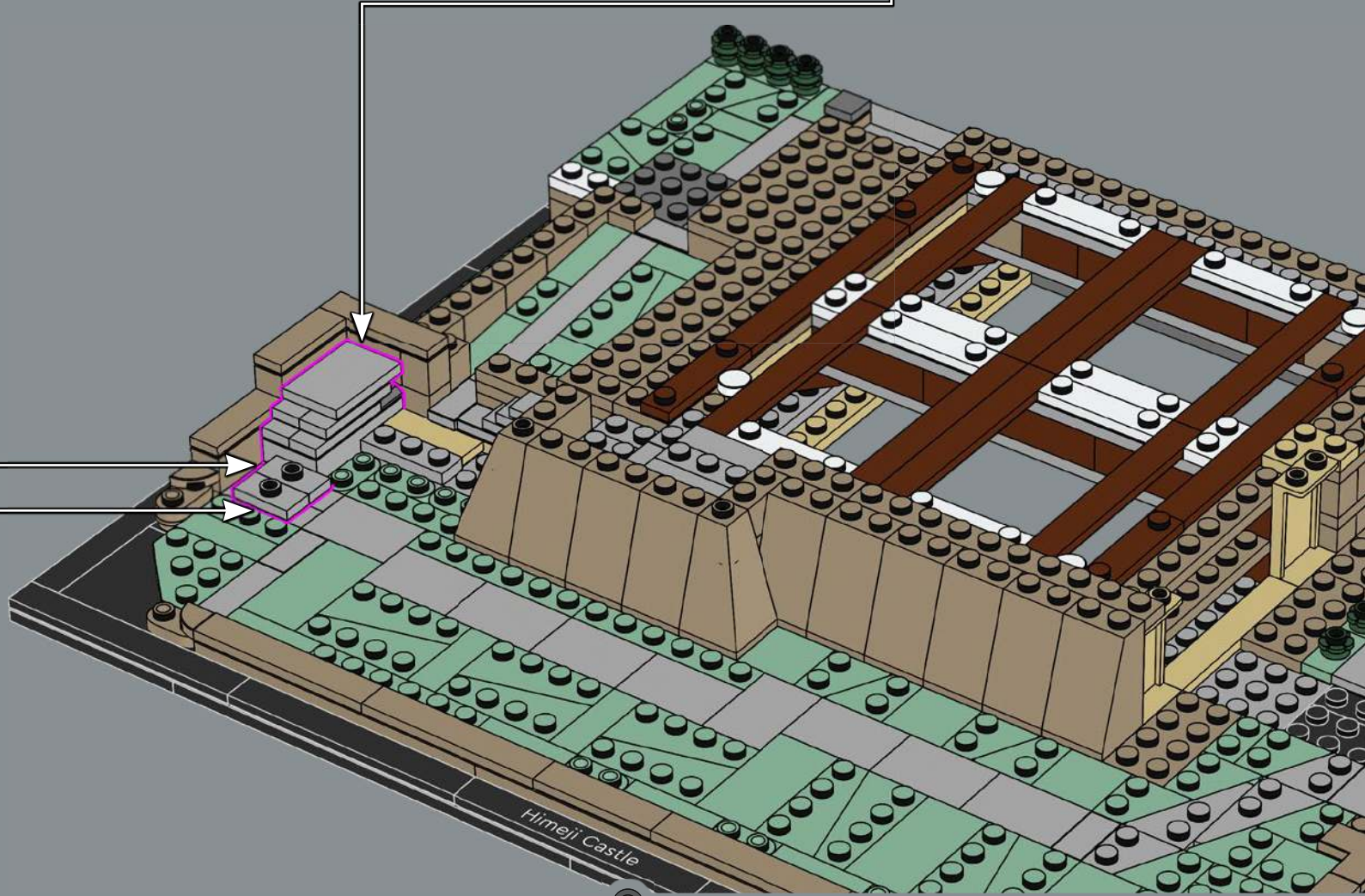
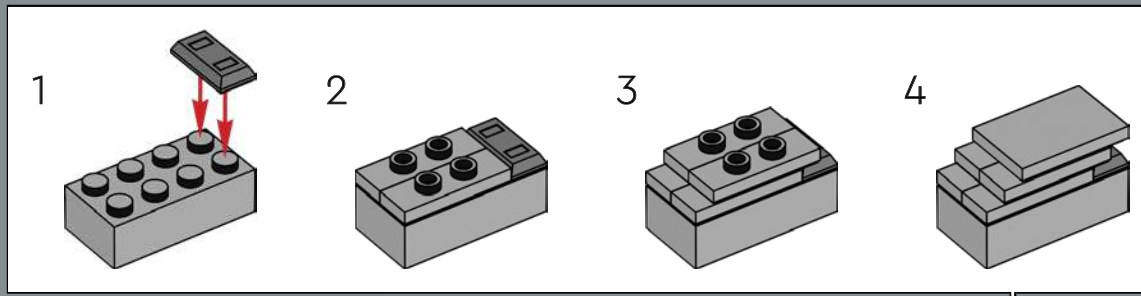

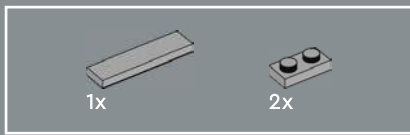

76

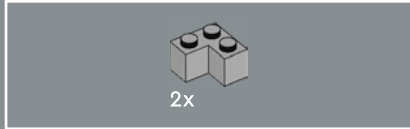
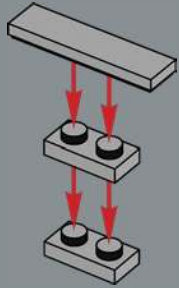

77

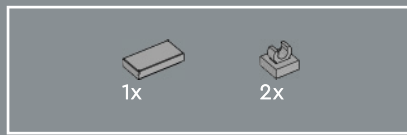
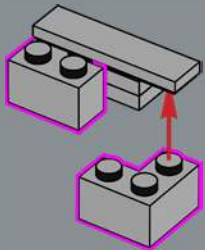

78

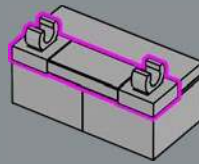

79

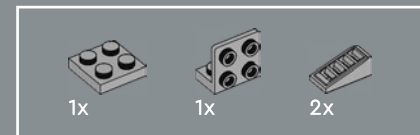
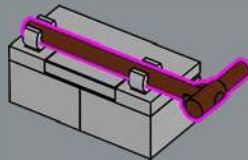

80

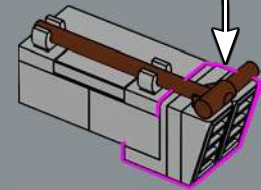
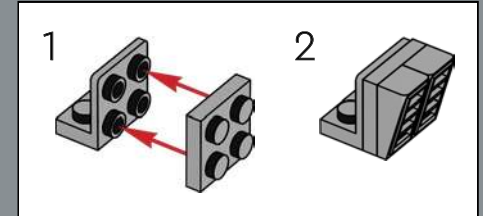

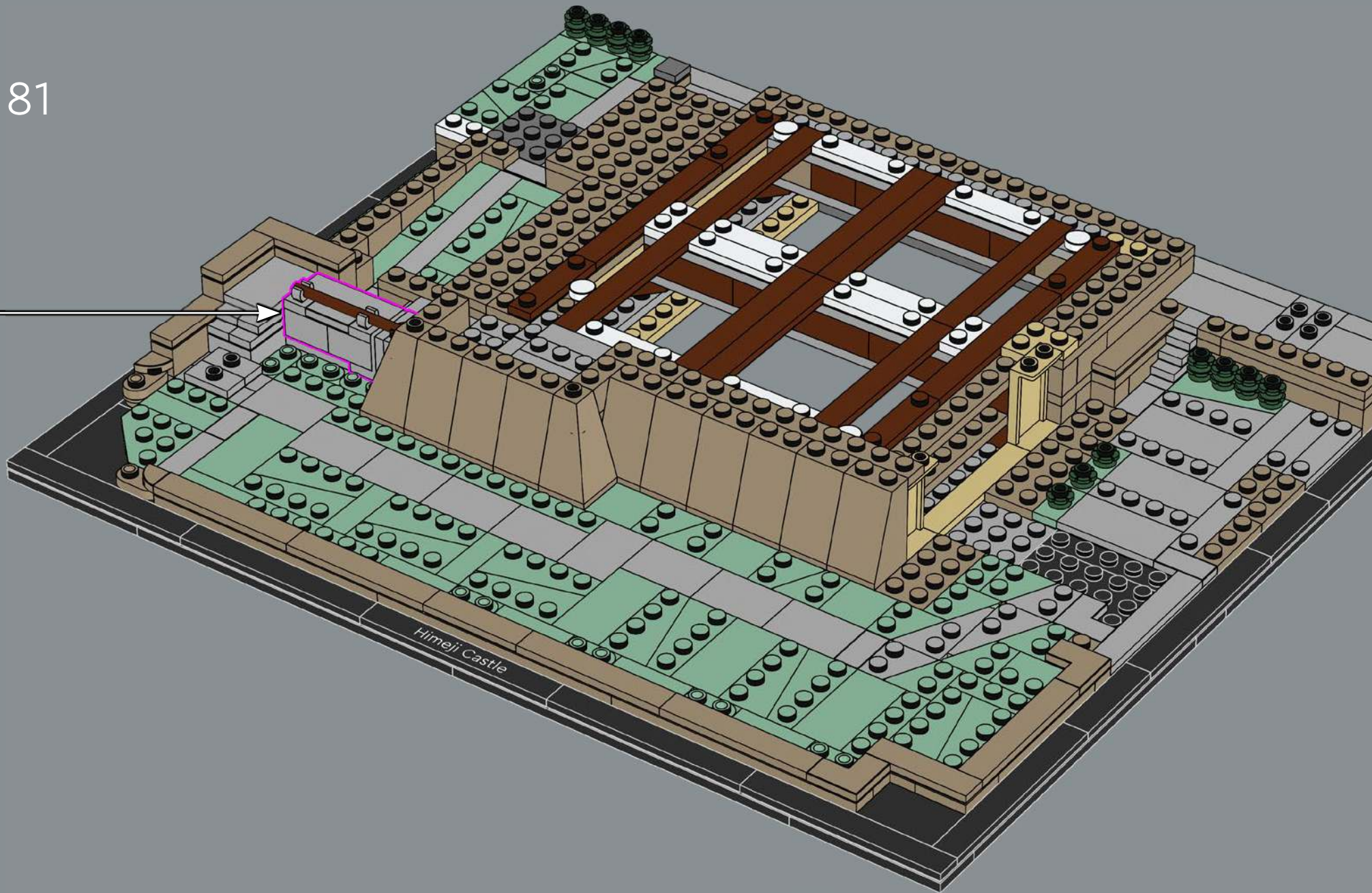

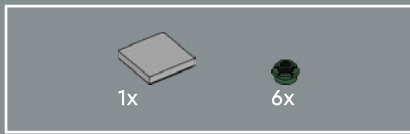

82

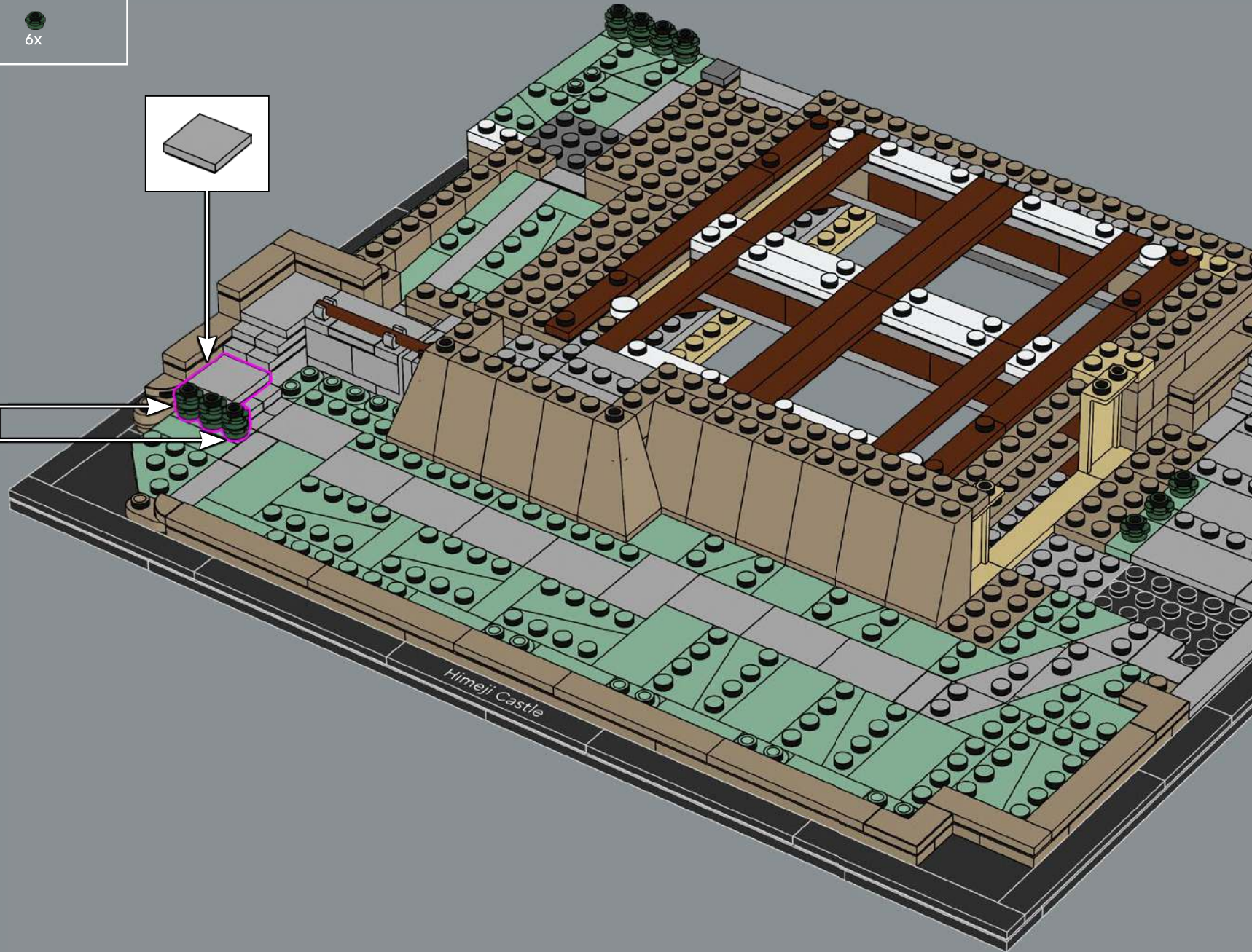
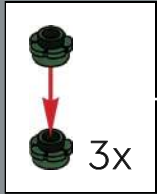
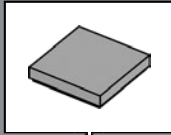

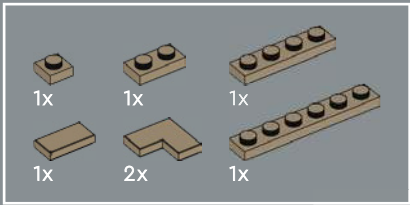

83

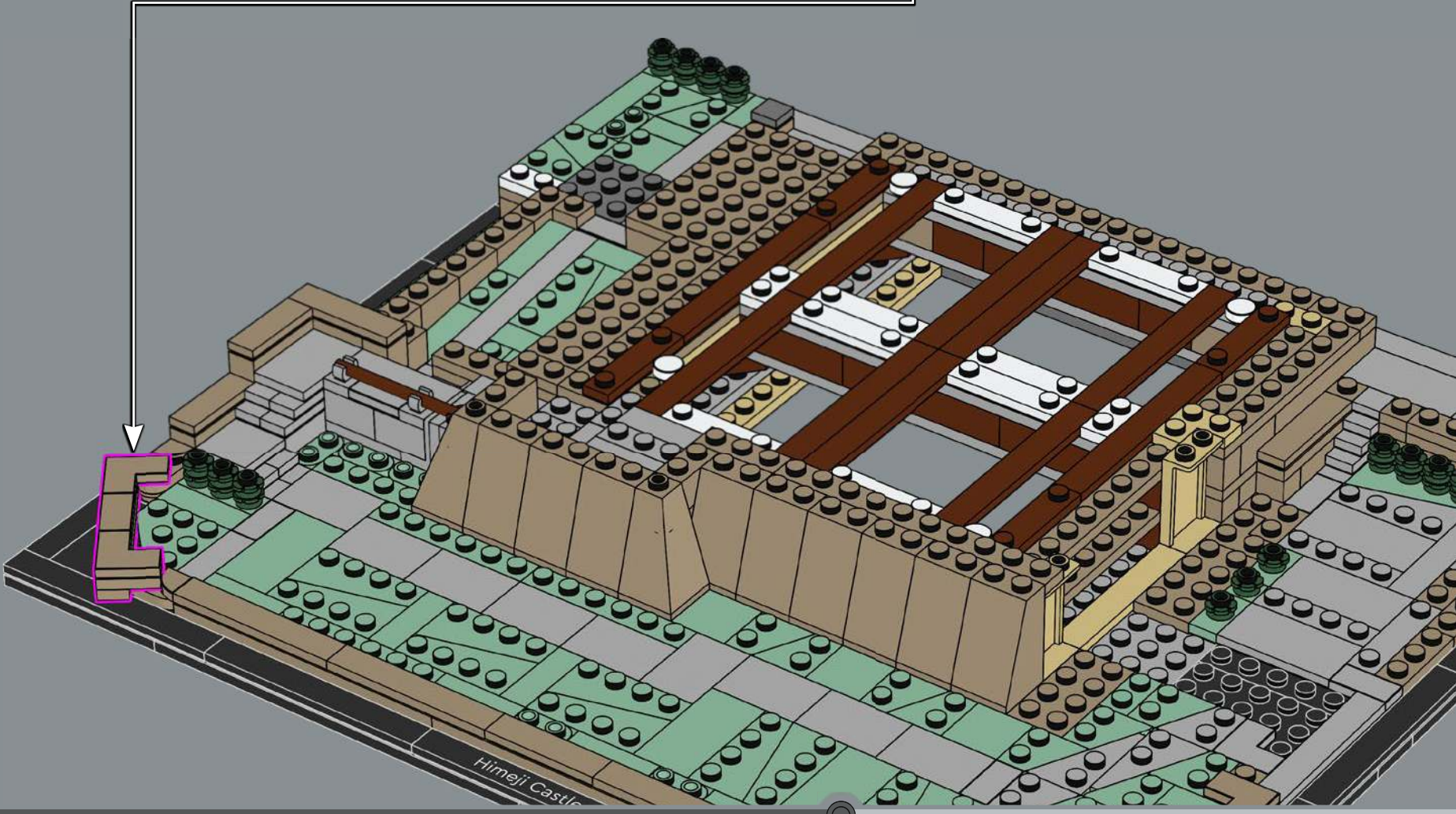
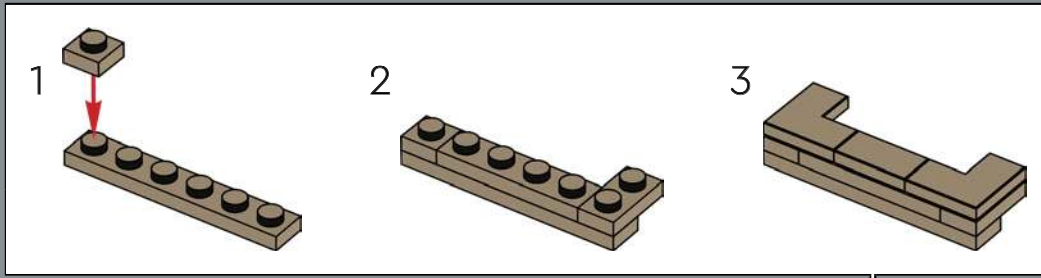

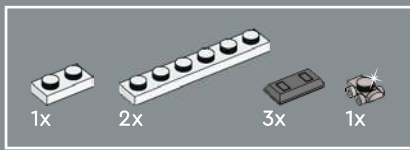

84

1

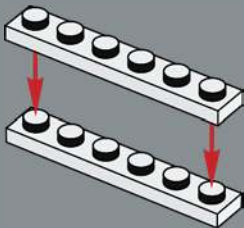

2

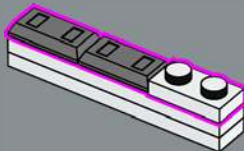

3

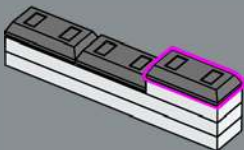

4



1:1

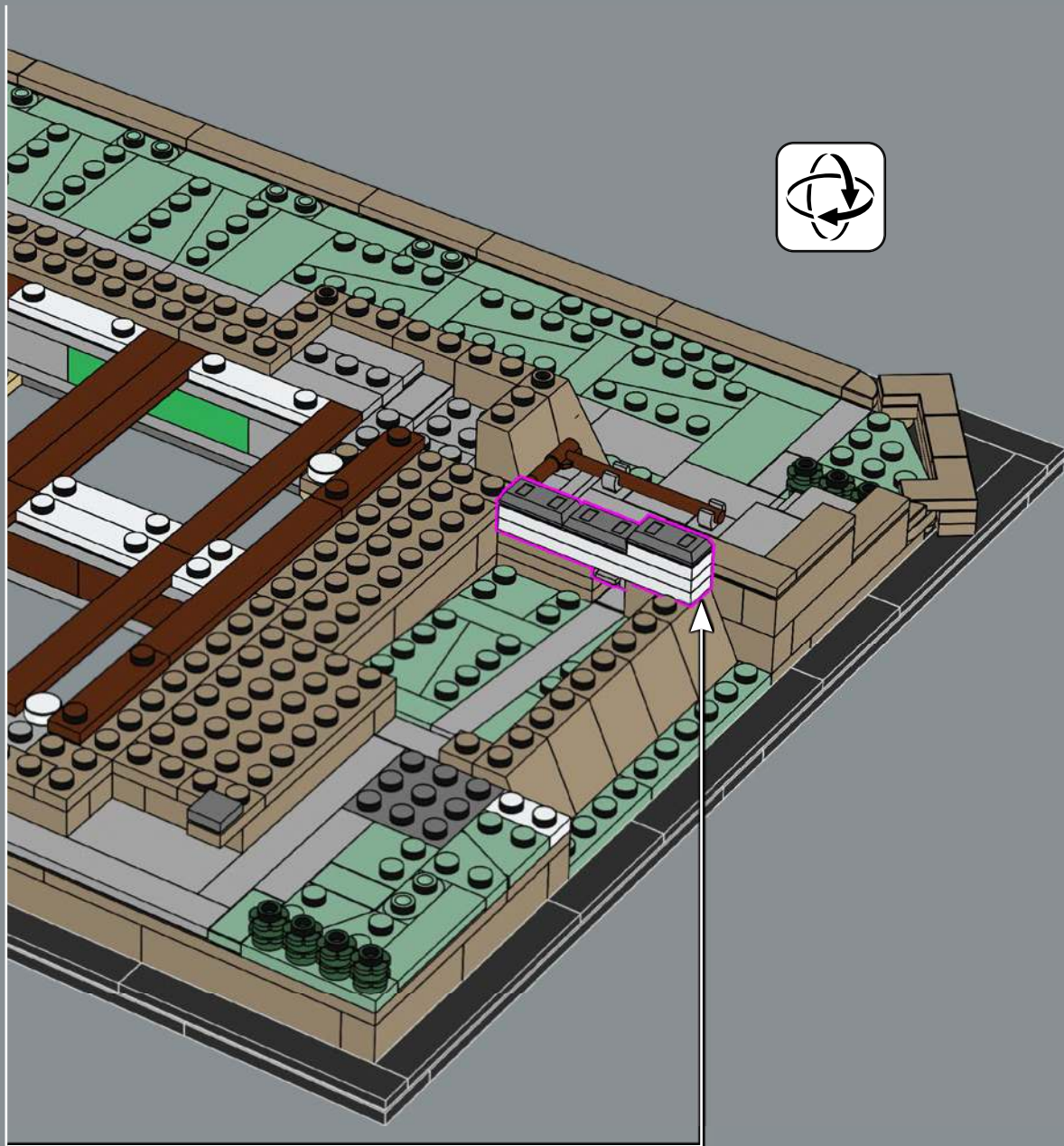
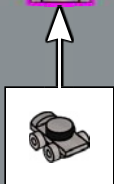

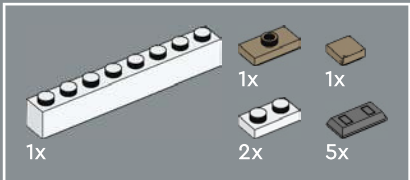

85

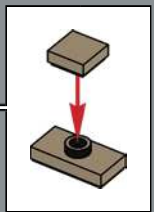
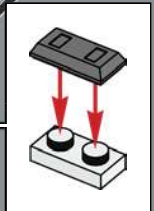
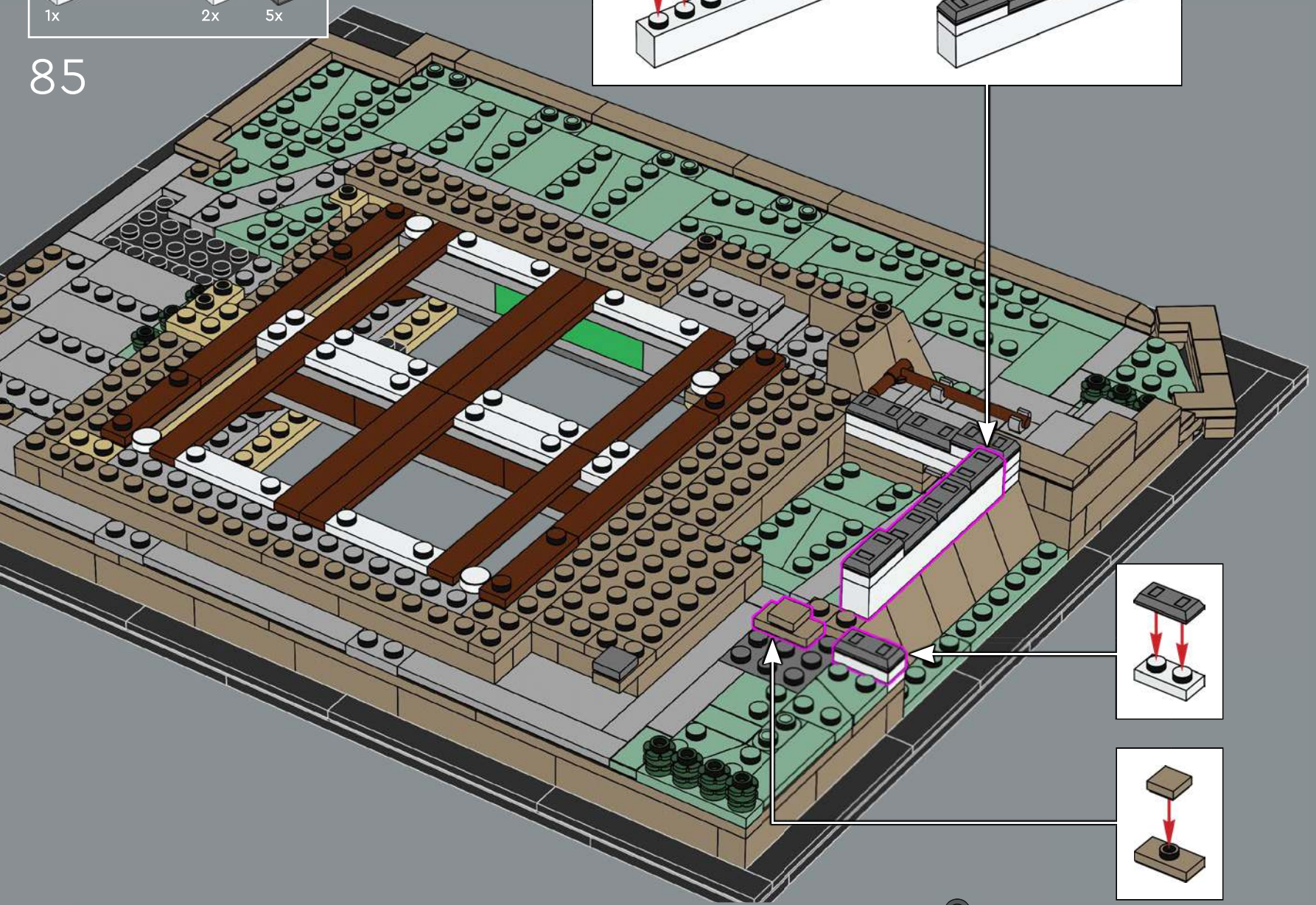
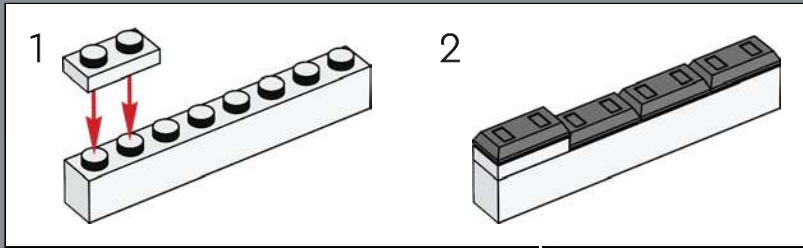

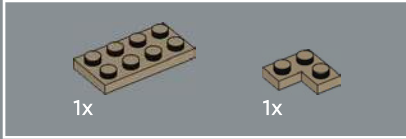
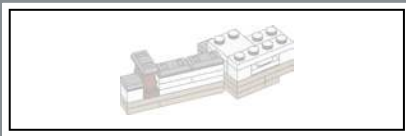

86

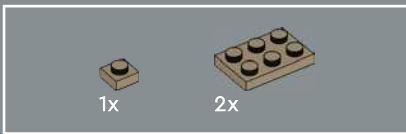
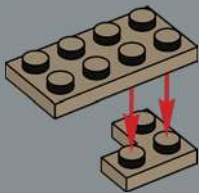

87

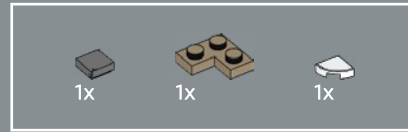
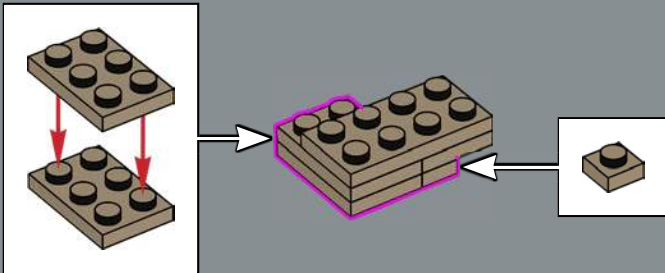

88

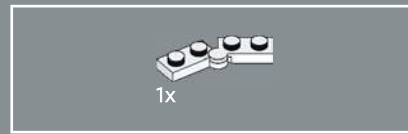
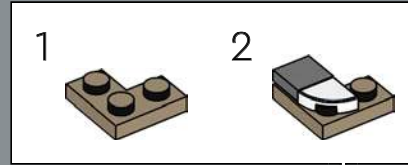

89

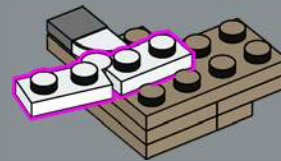

90

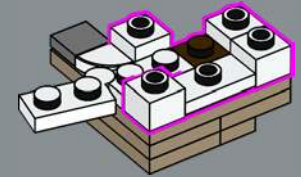

91

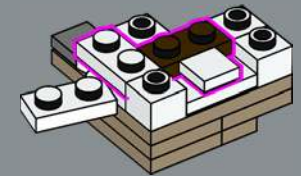

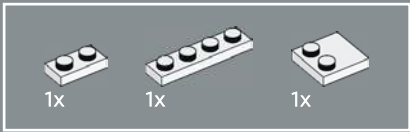

92

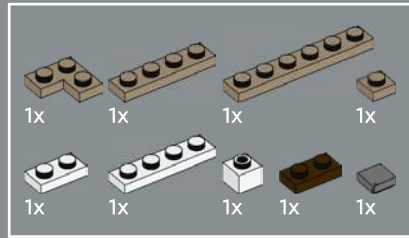
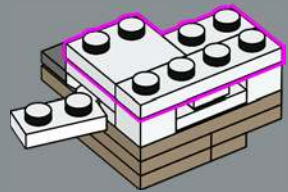

93

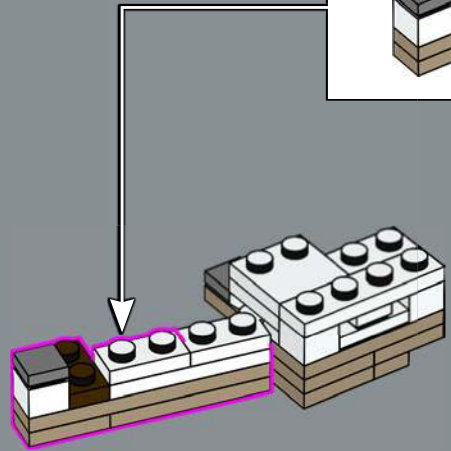
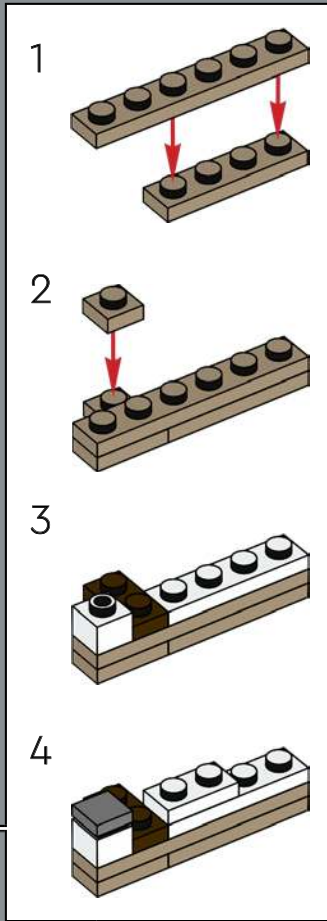

94

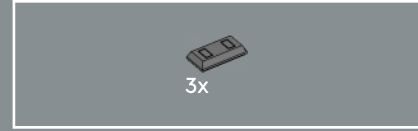
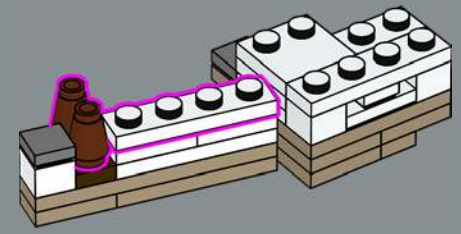

95

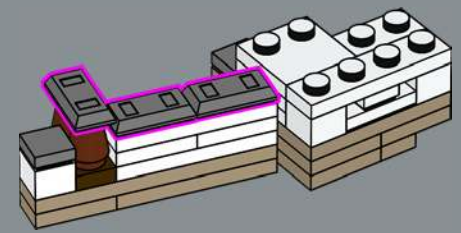

One of the features that make the castle's architecture so interesting is that many of the walls, towers and pathways are placed at irregular angles.

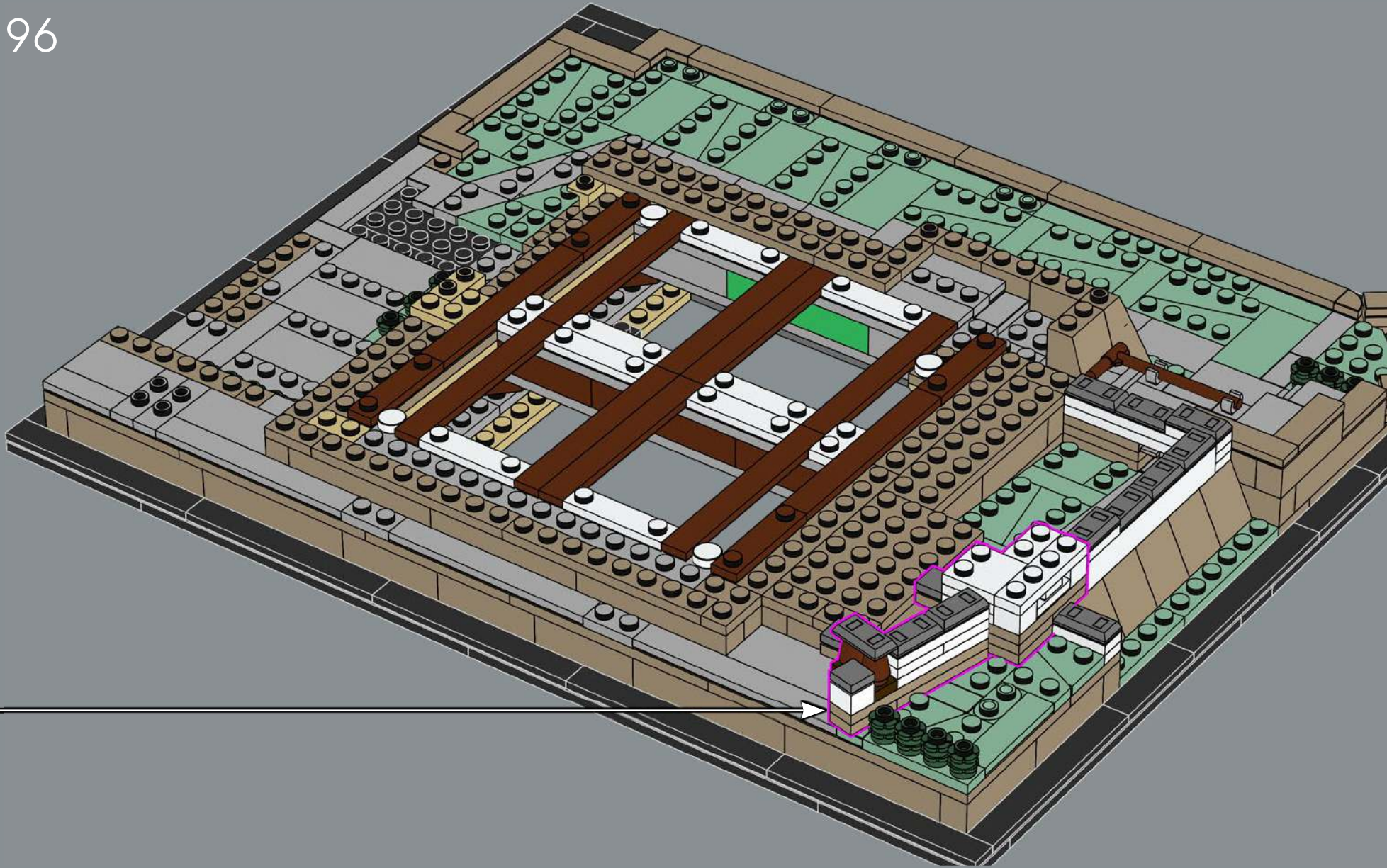

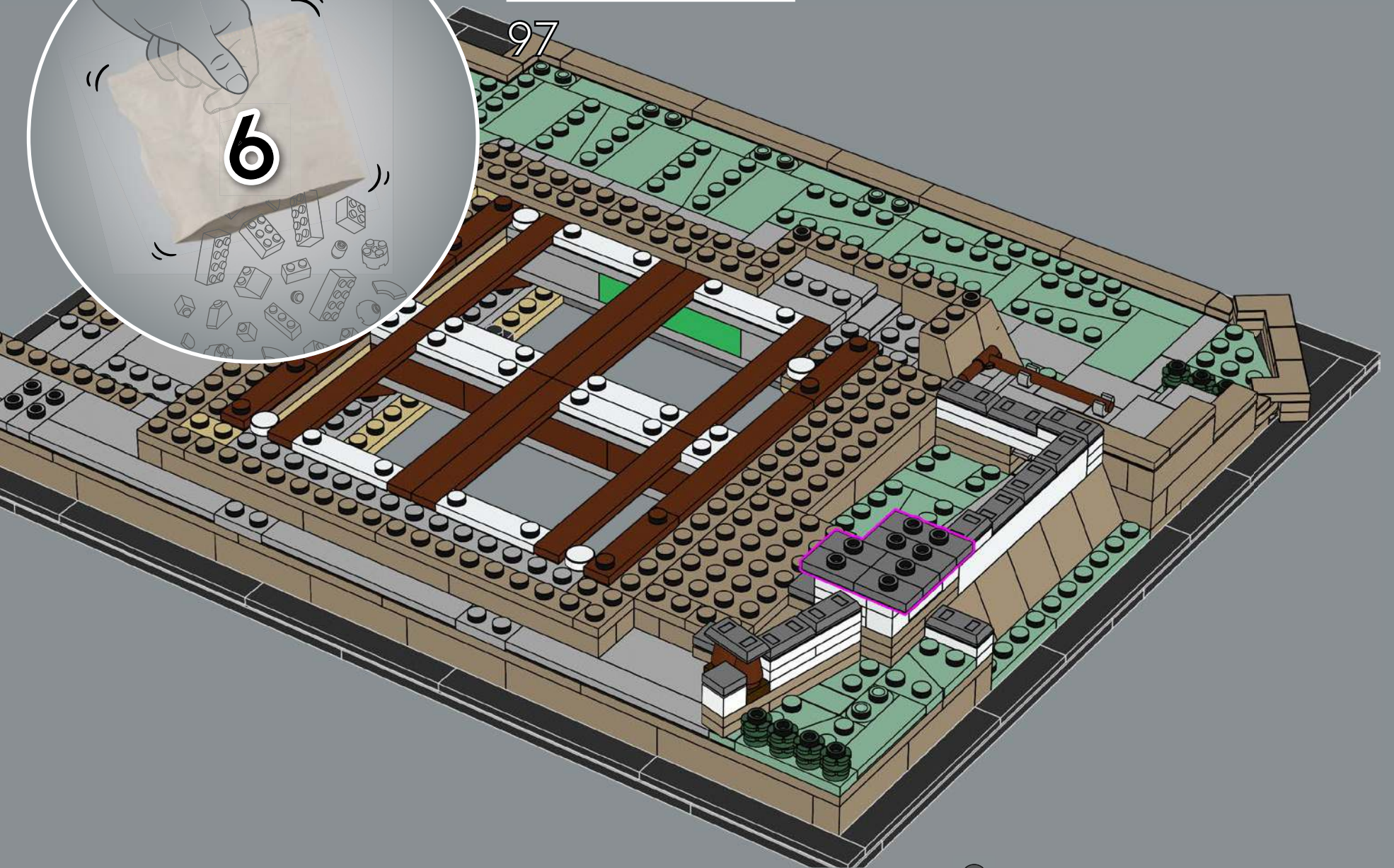
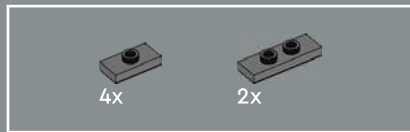

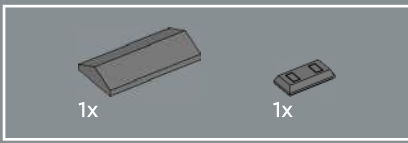

98

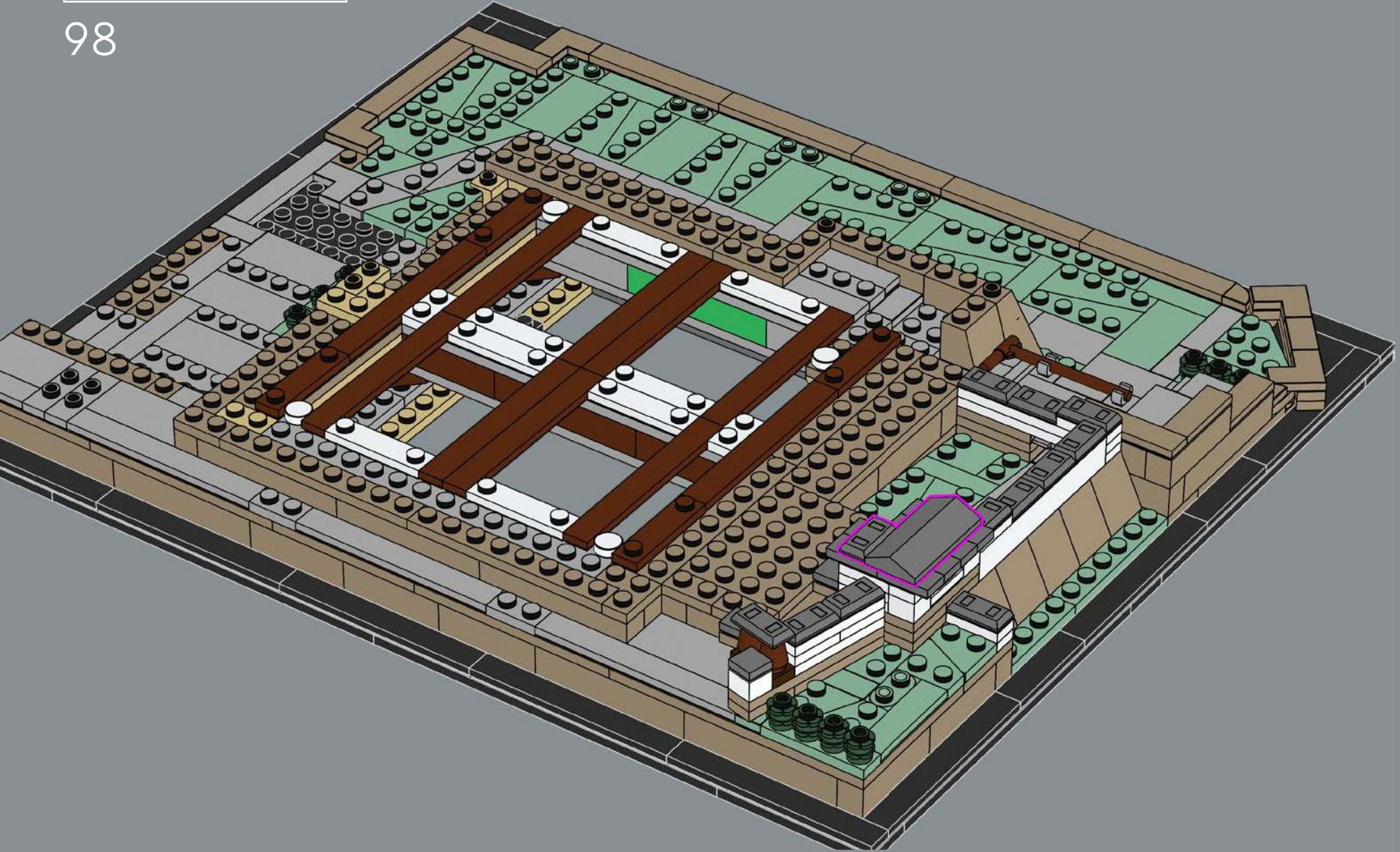

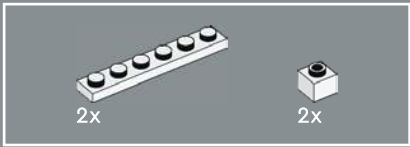

99

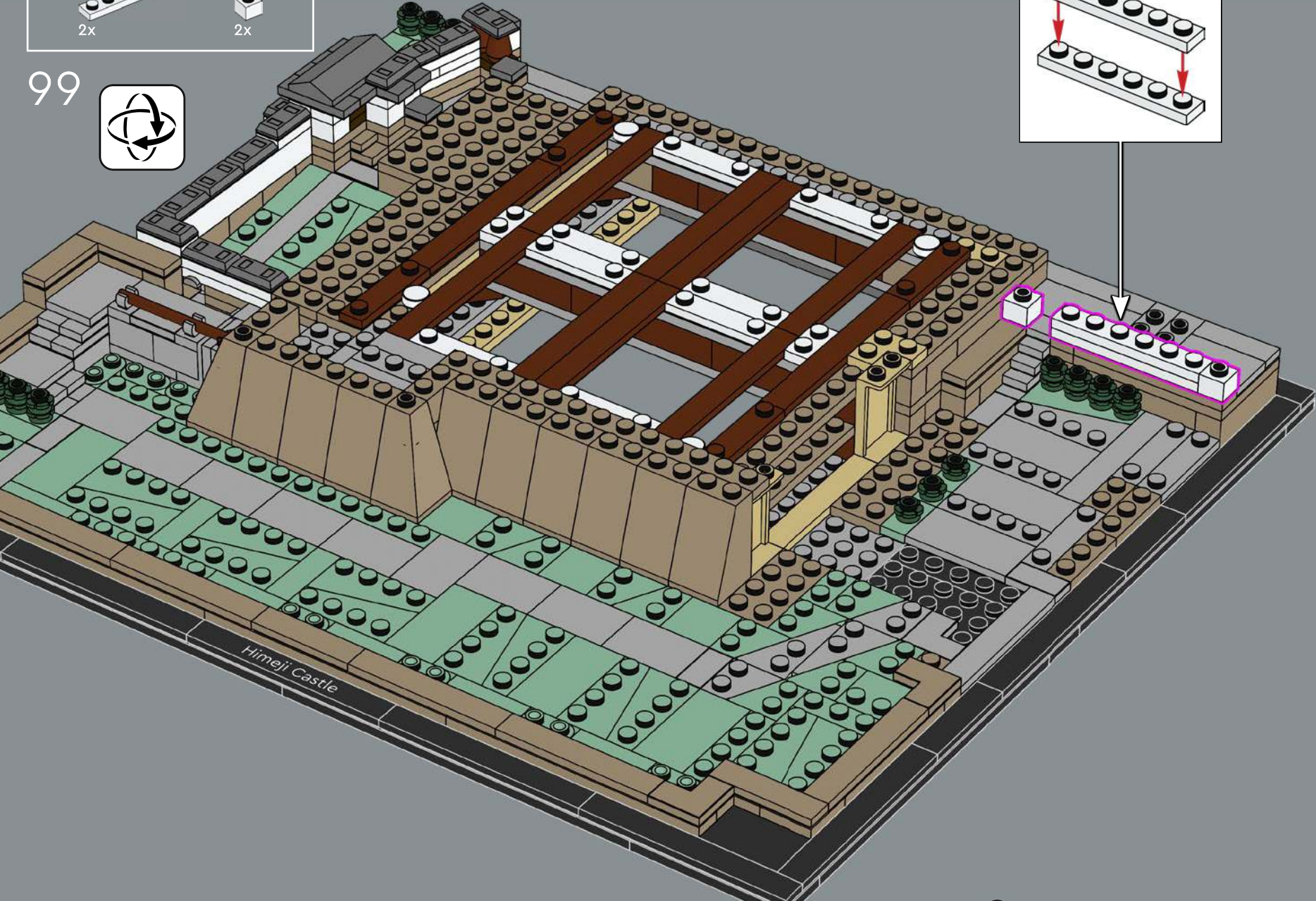
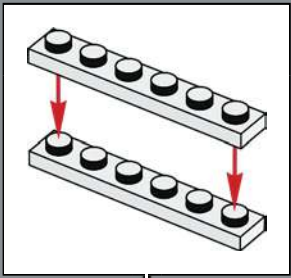

Himeji Castle



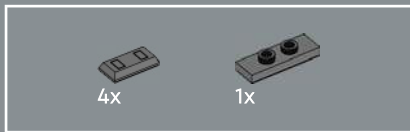

100

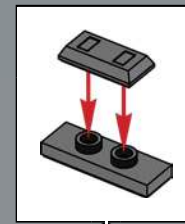

Himeji Castle

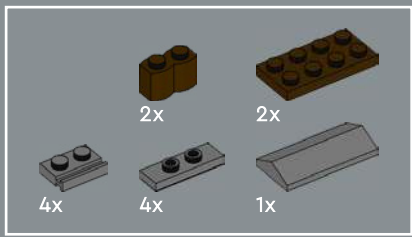

101

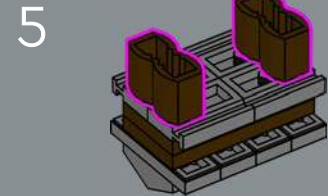
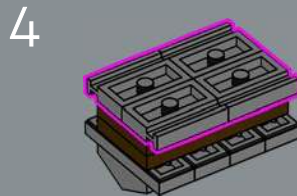
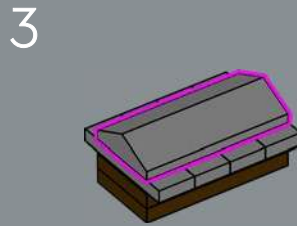
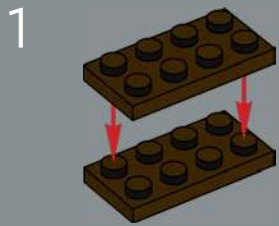

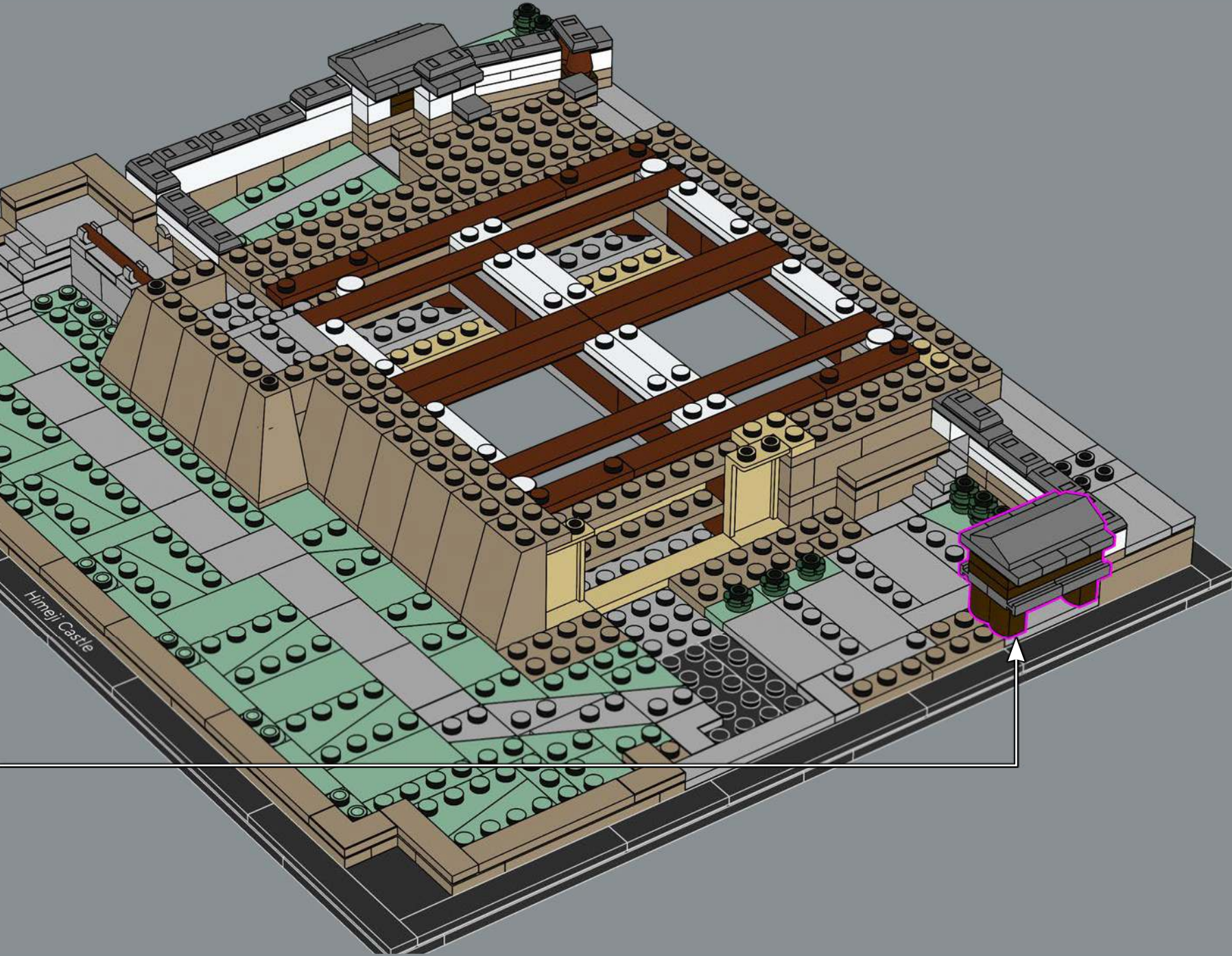

Himeji Castle

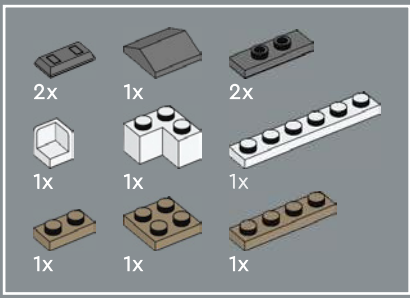

102

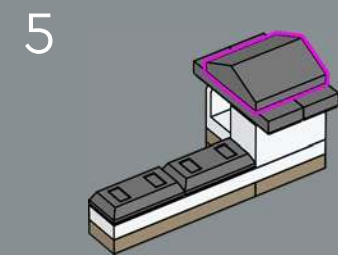
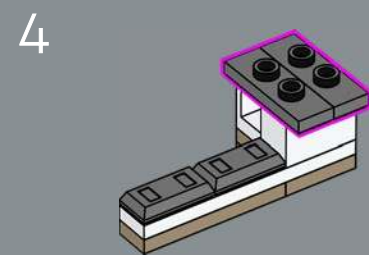
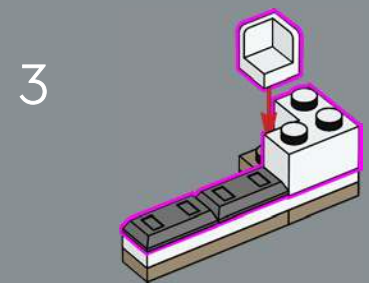
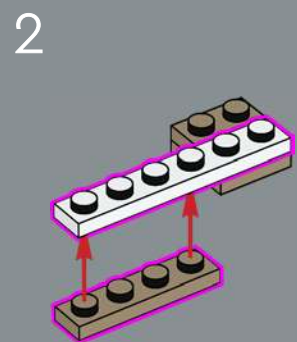
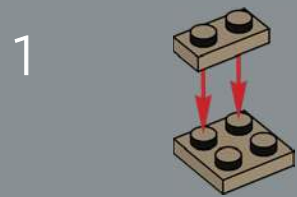

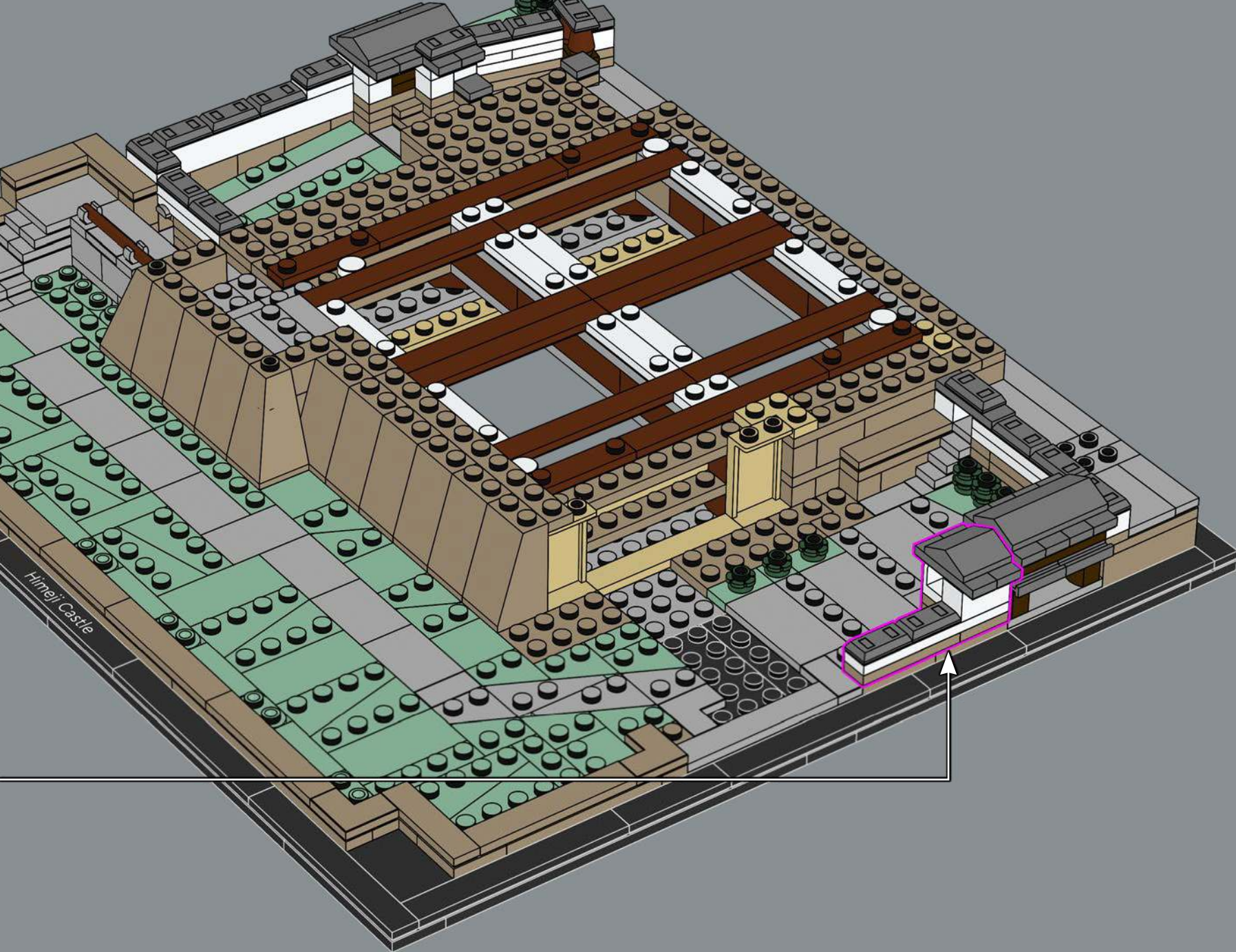

		
1x	2x	1x

103

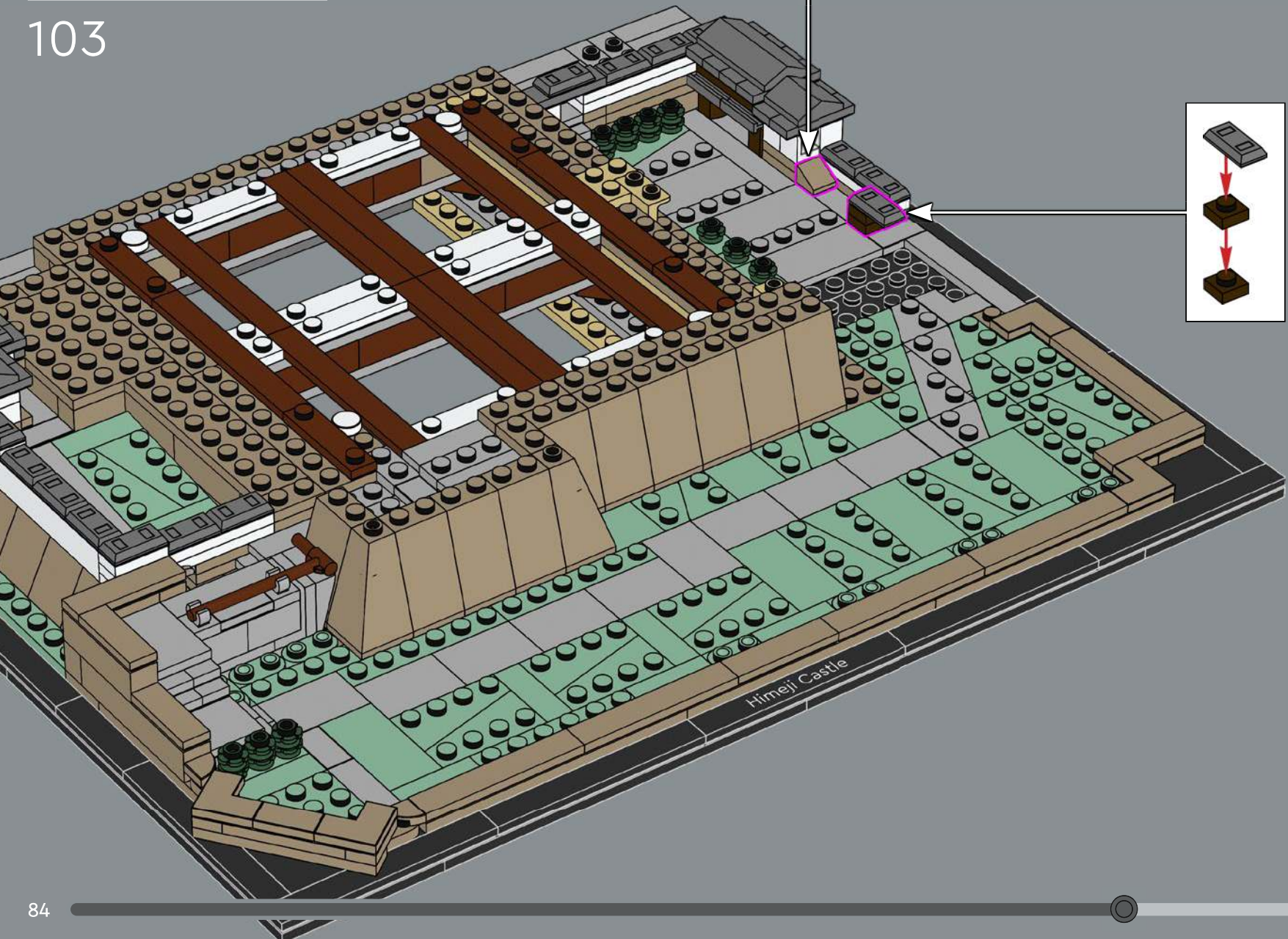
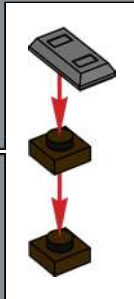

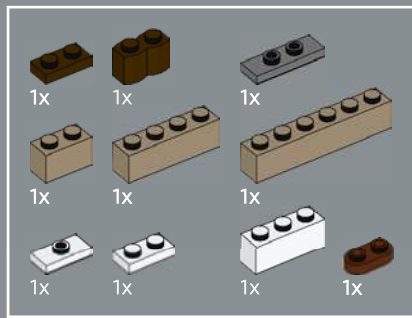

104

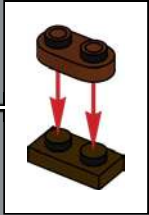
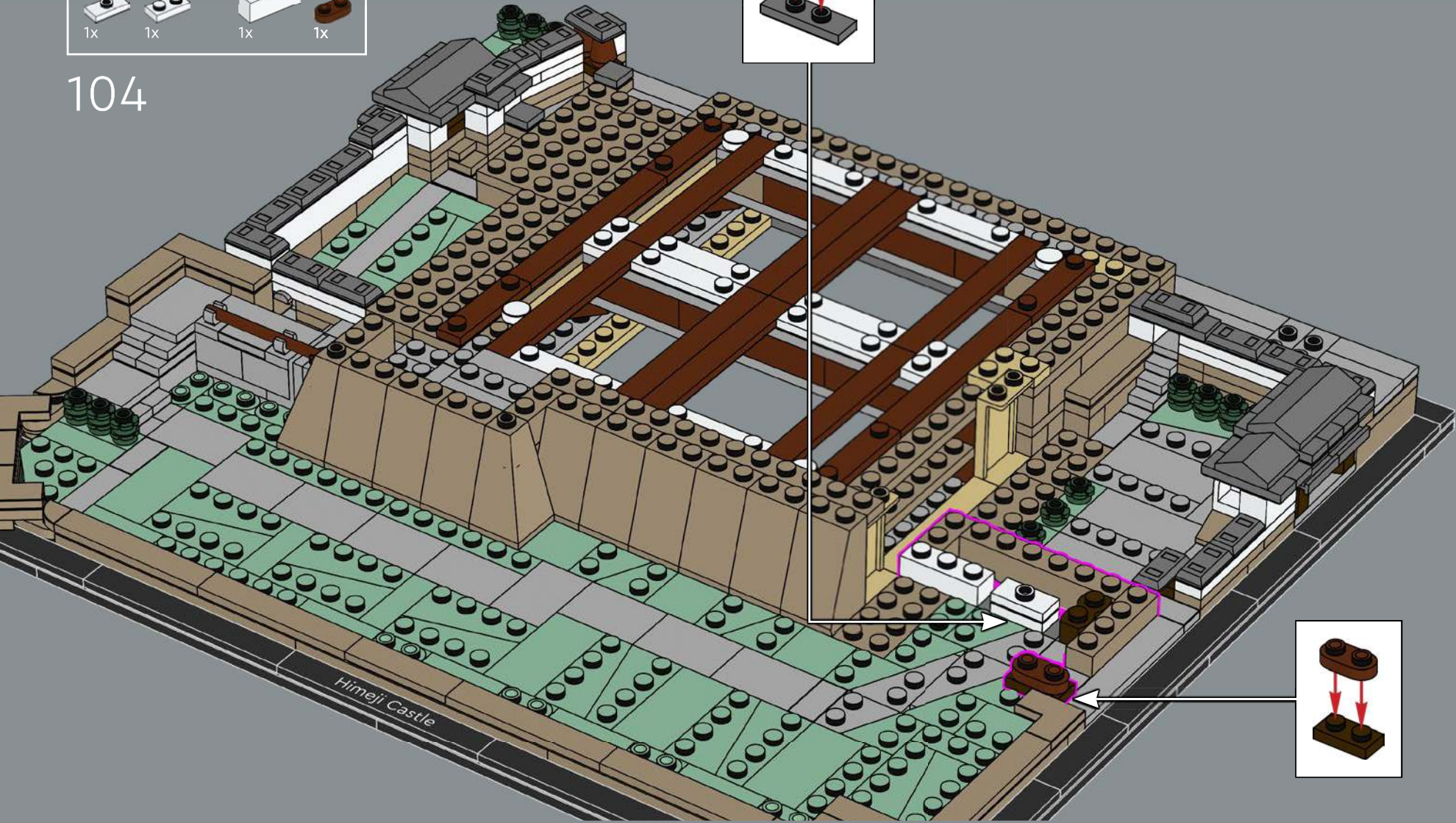
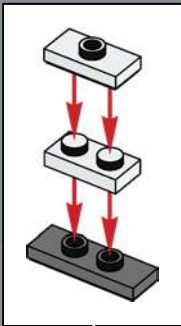

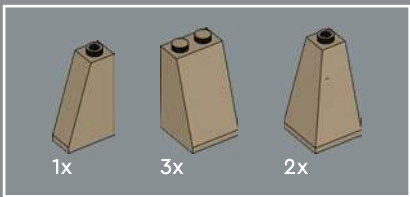

105

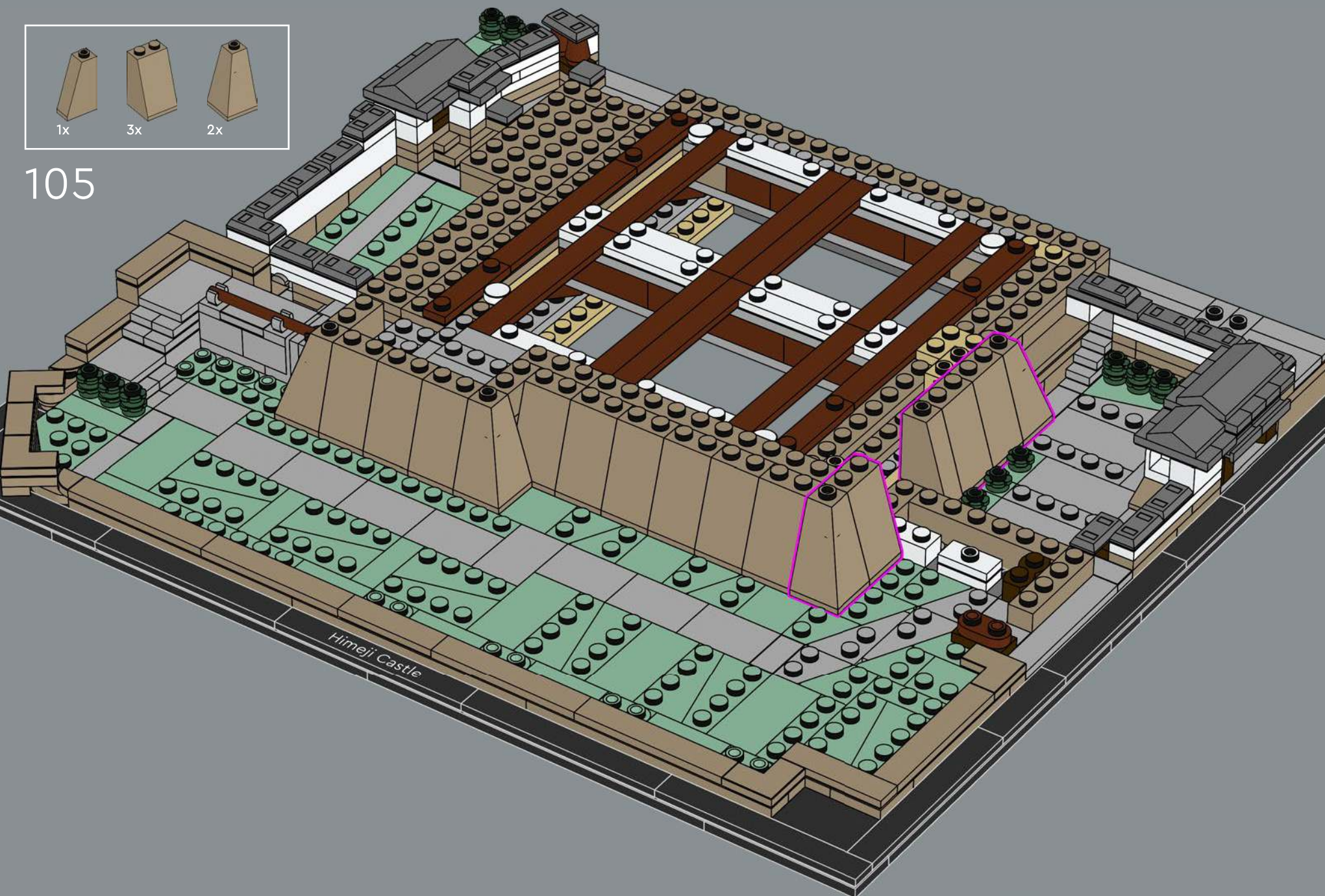

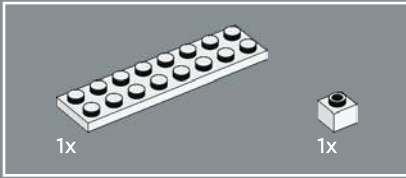
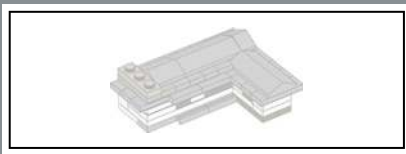

106

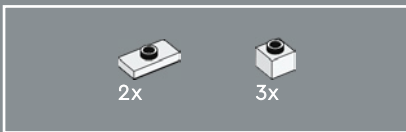
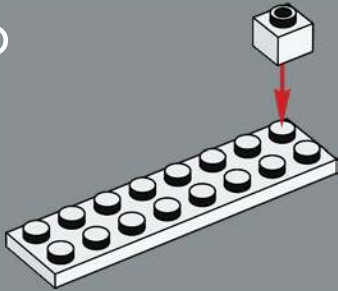

107

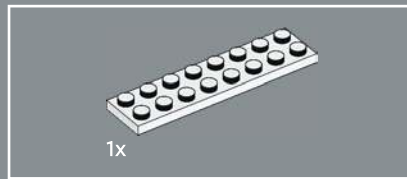
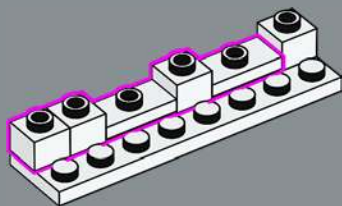

108

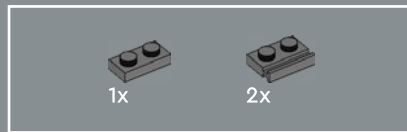
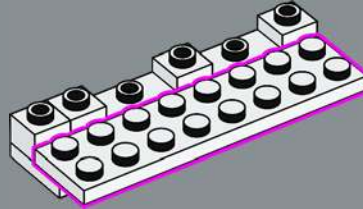

109

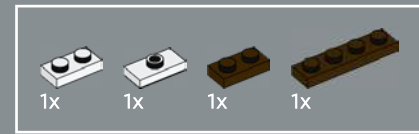
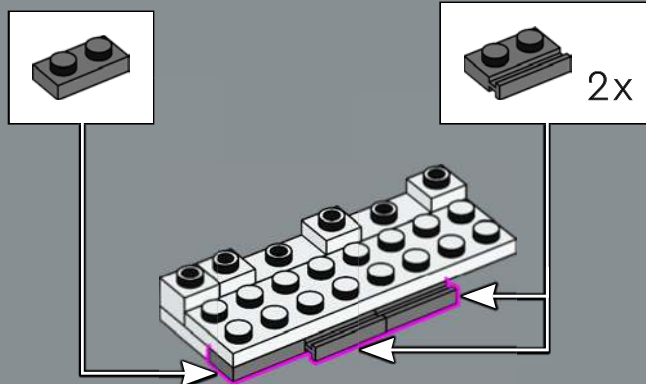

110

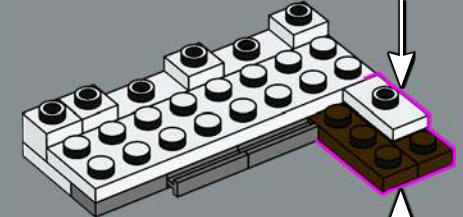
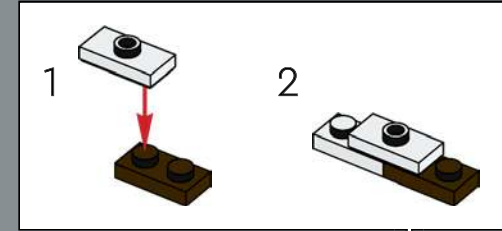

111

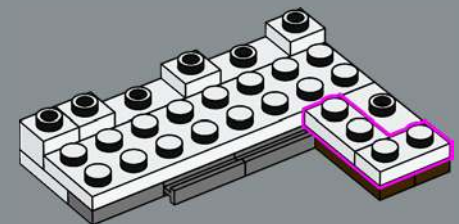

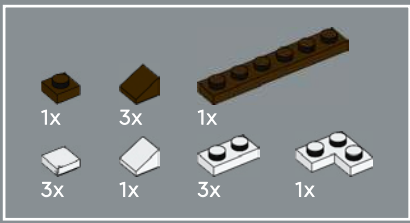

112

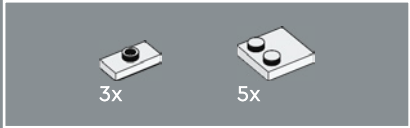
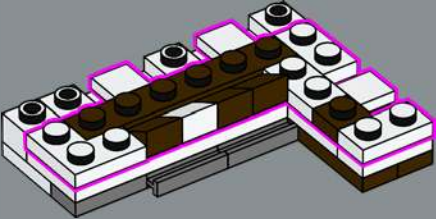

113

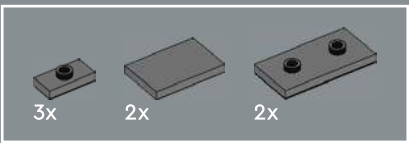
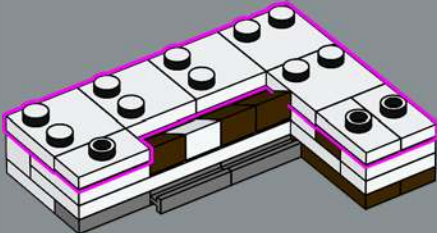

114

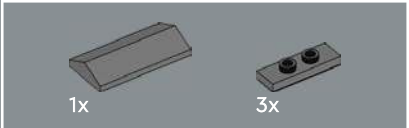
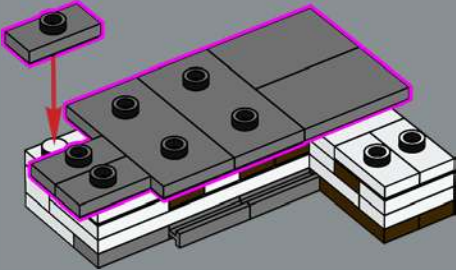

115

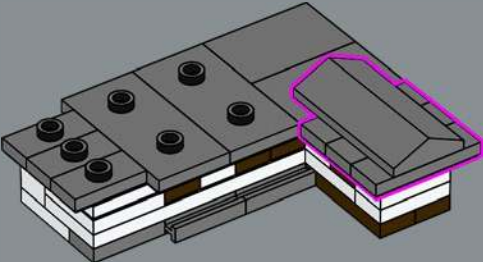
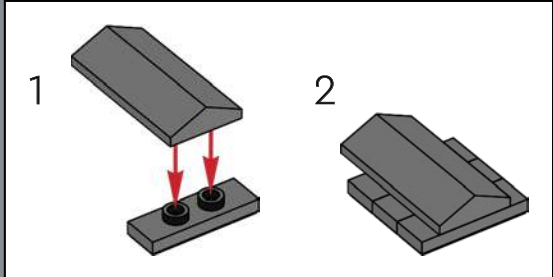

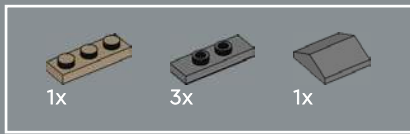

116

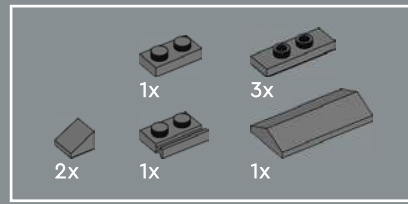
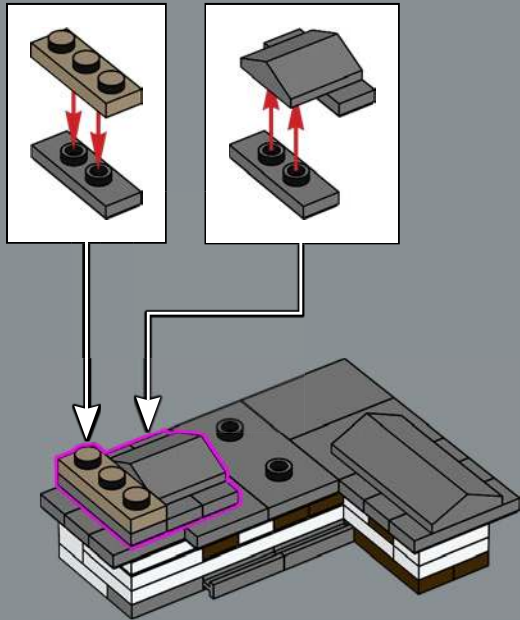

117

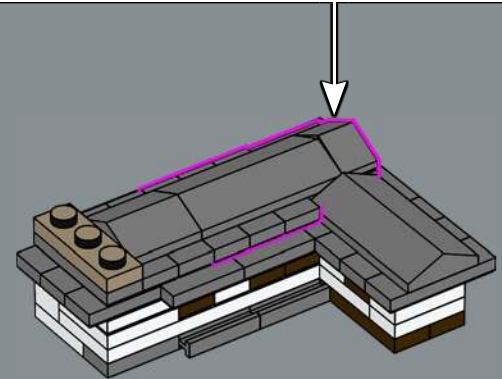
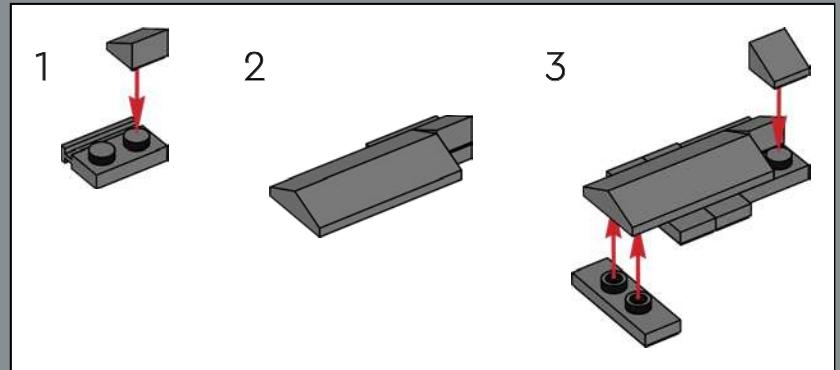



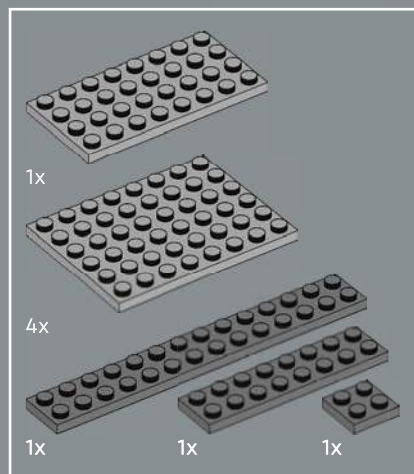

119

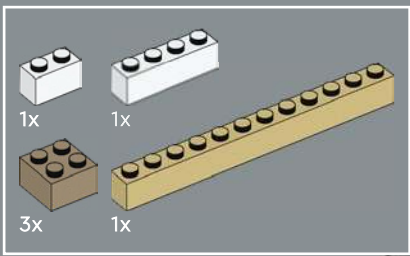

120

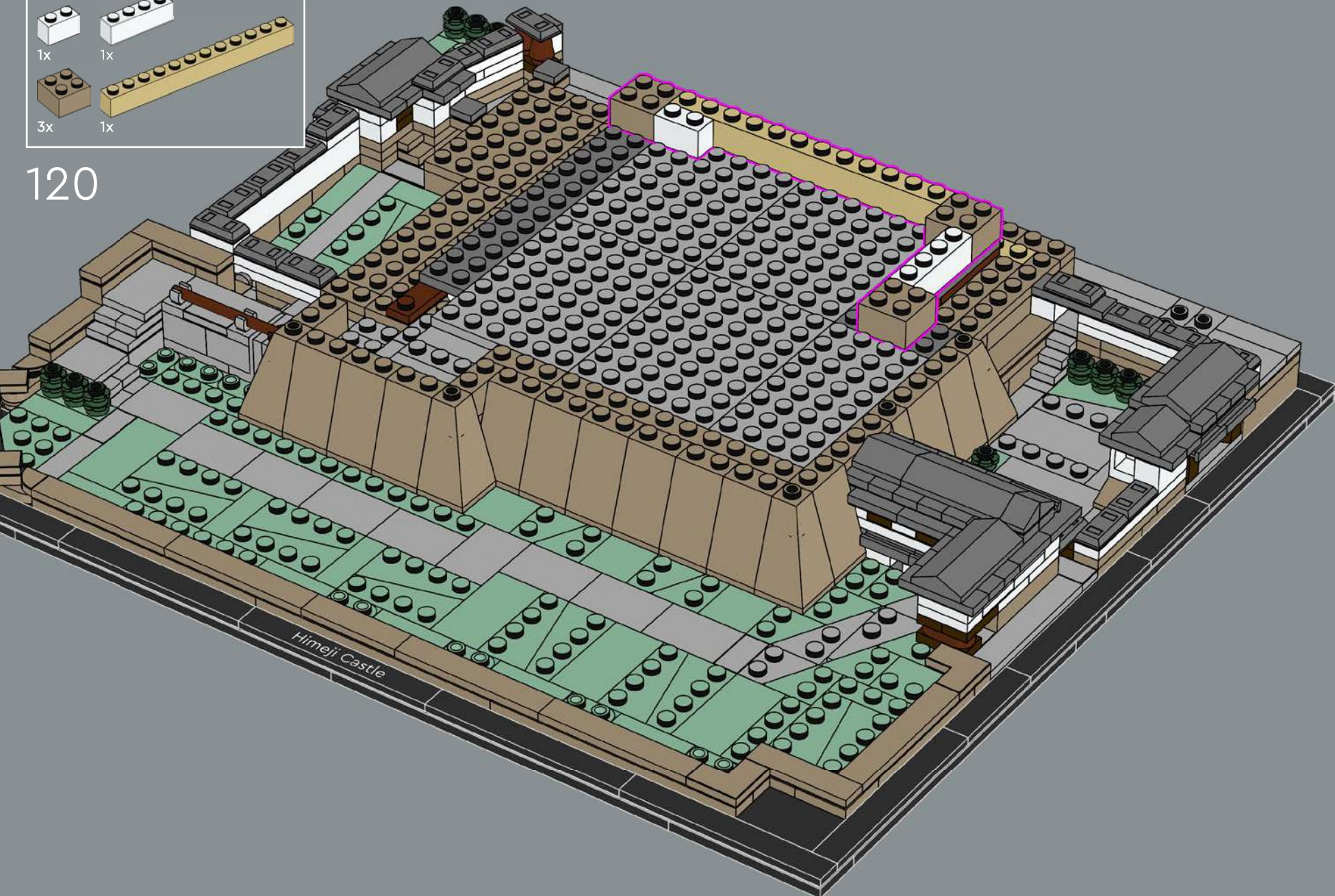

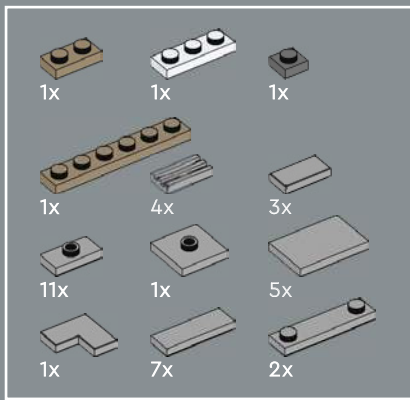

121

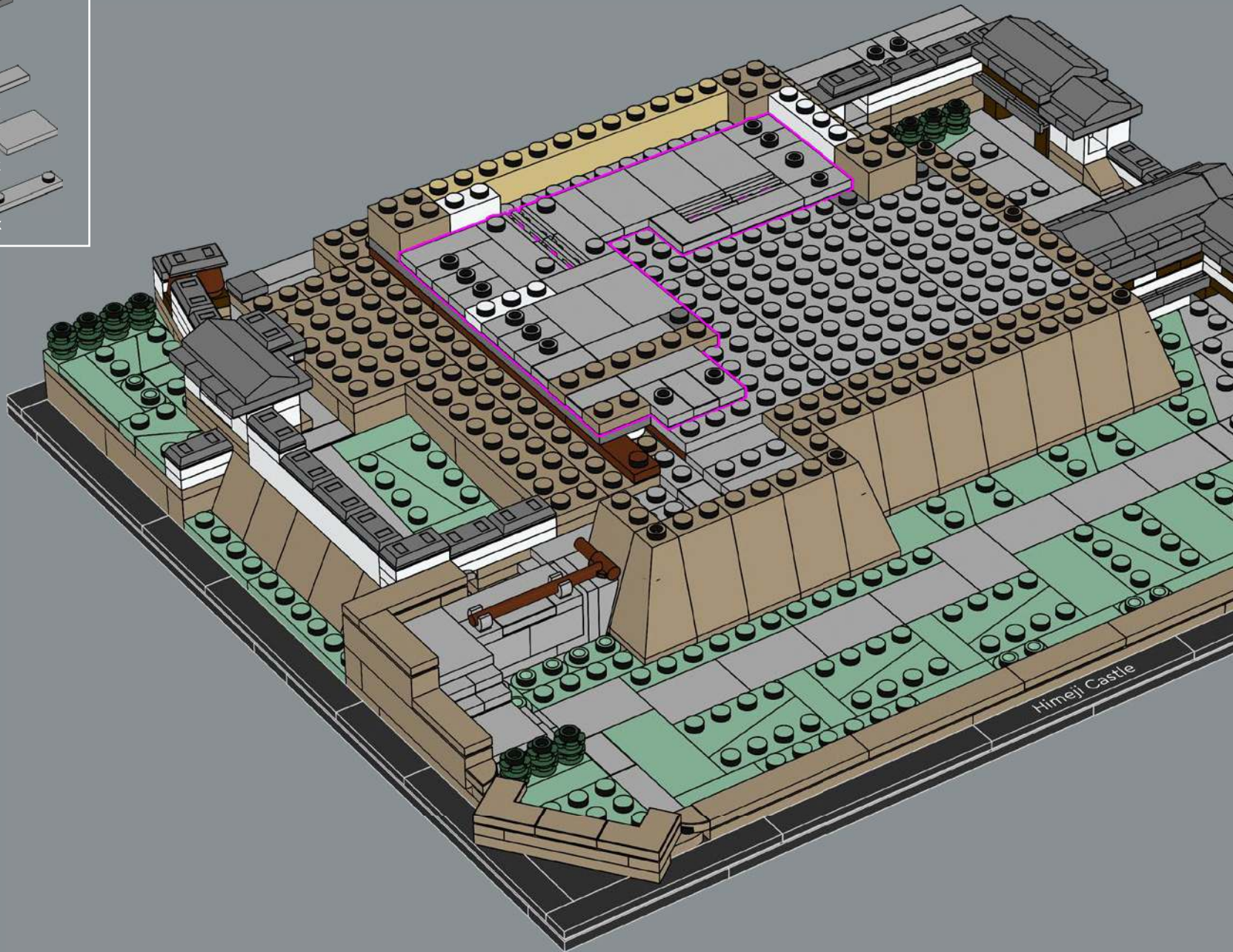

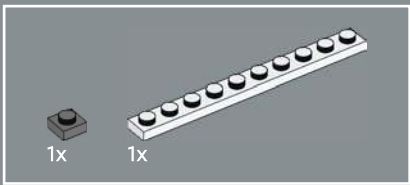

122

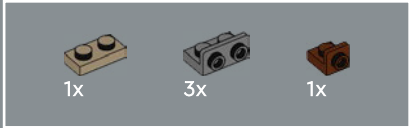
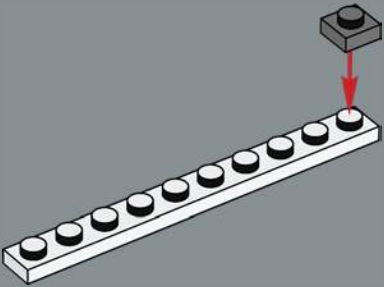

123

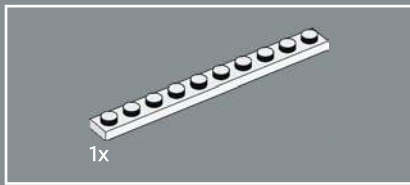
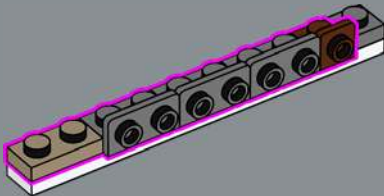

124

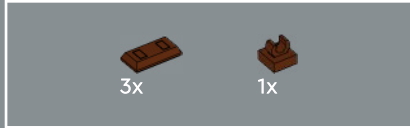
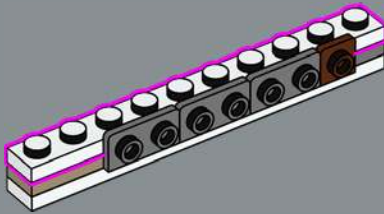

125

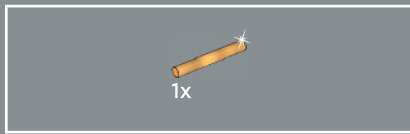
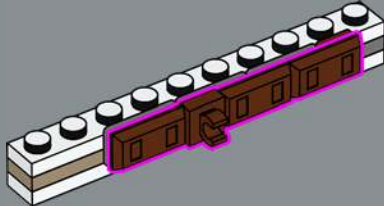

126

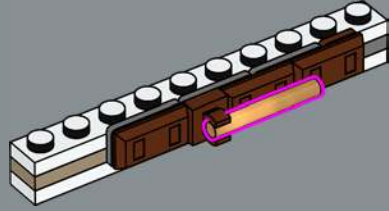

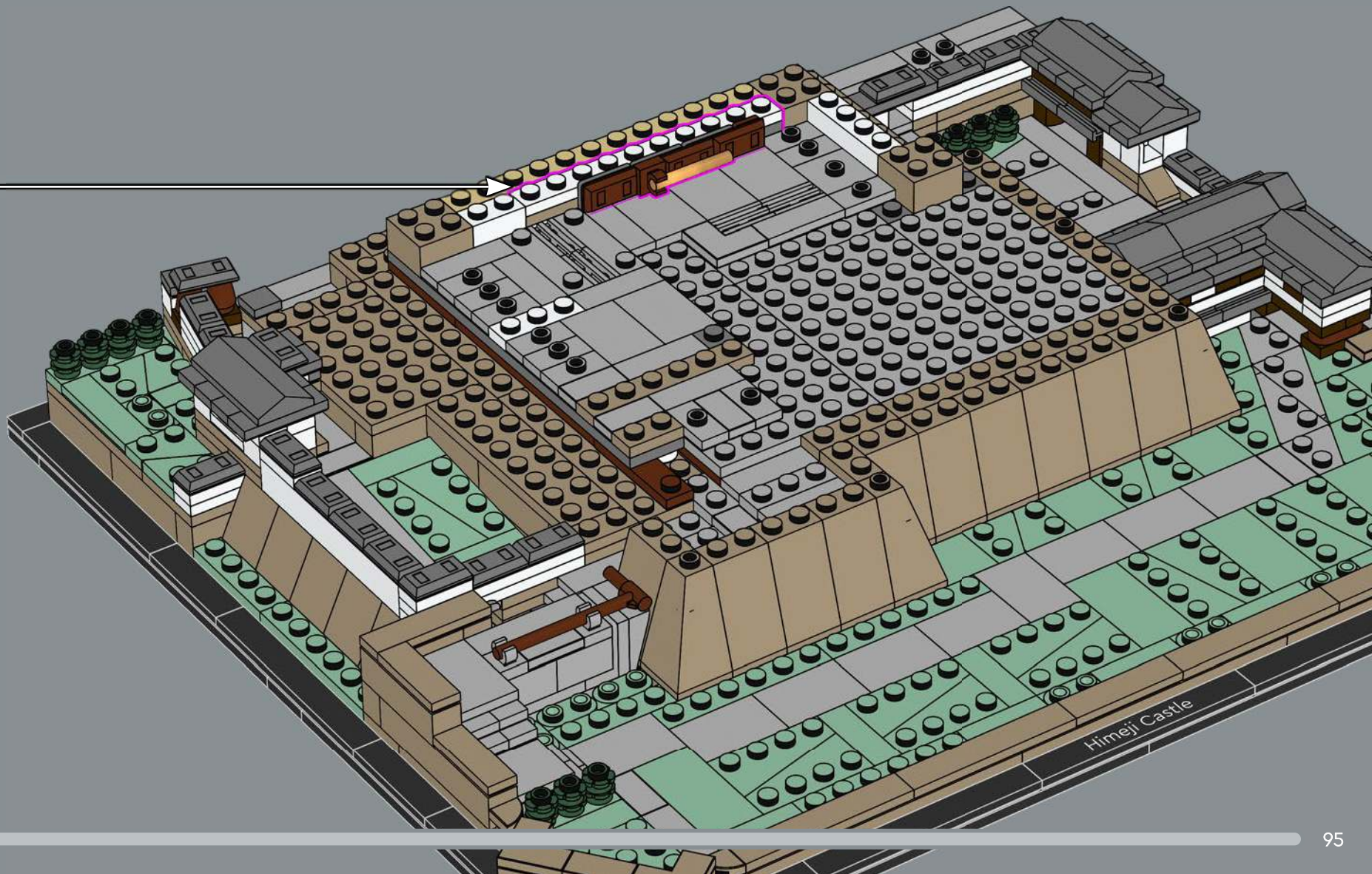

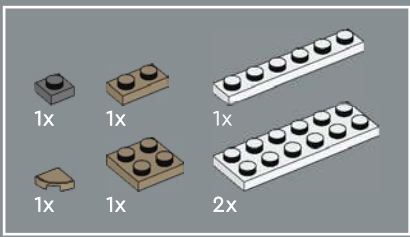

128

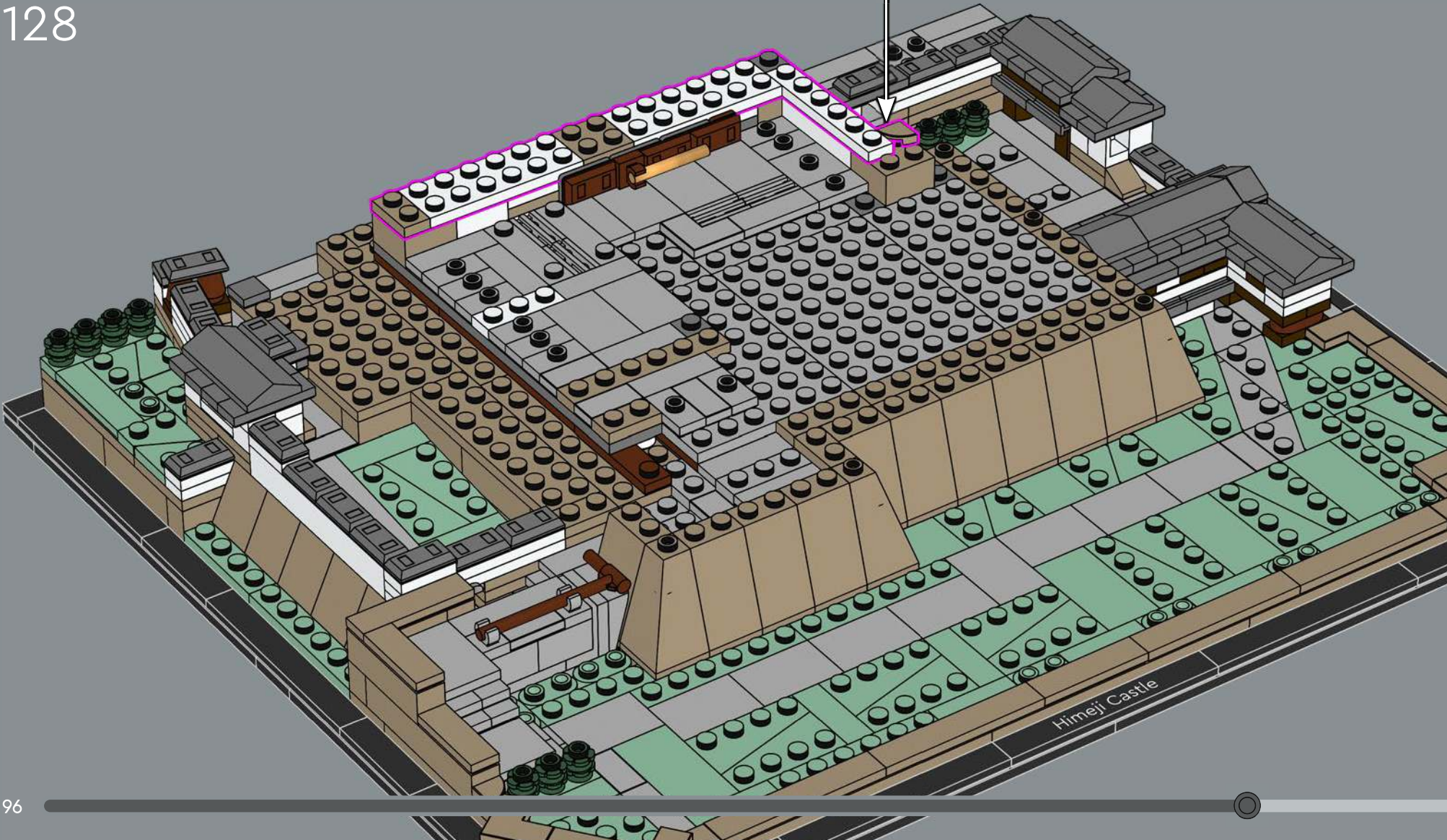

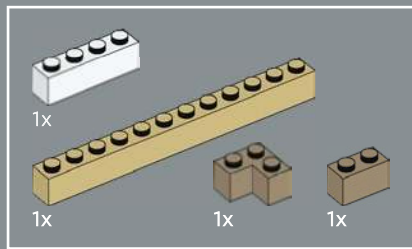

129

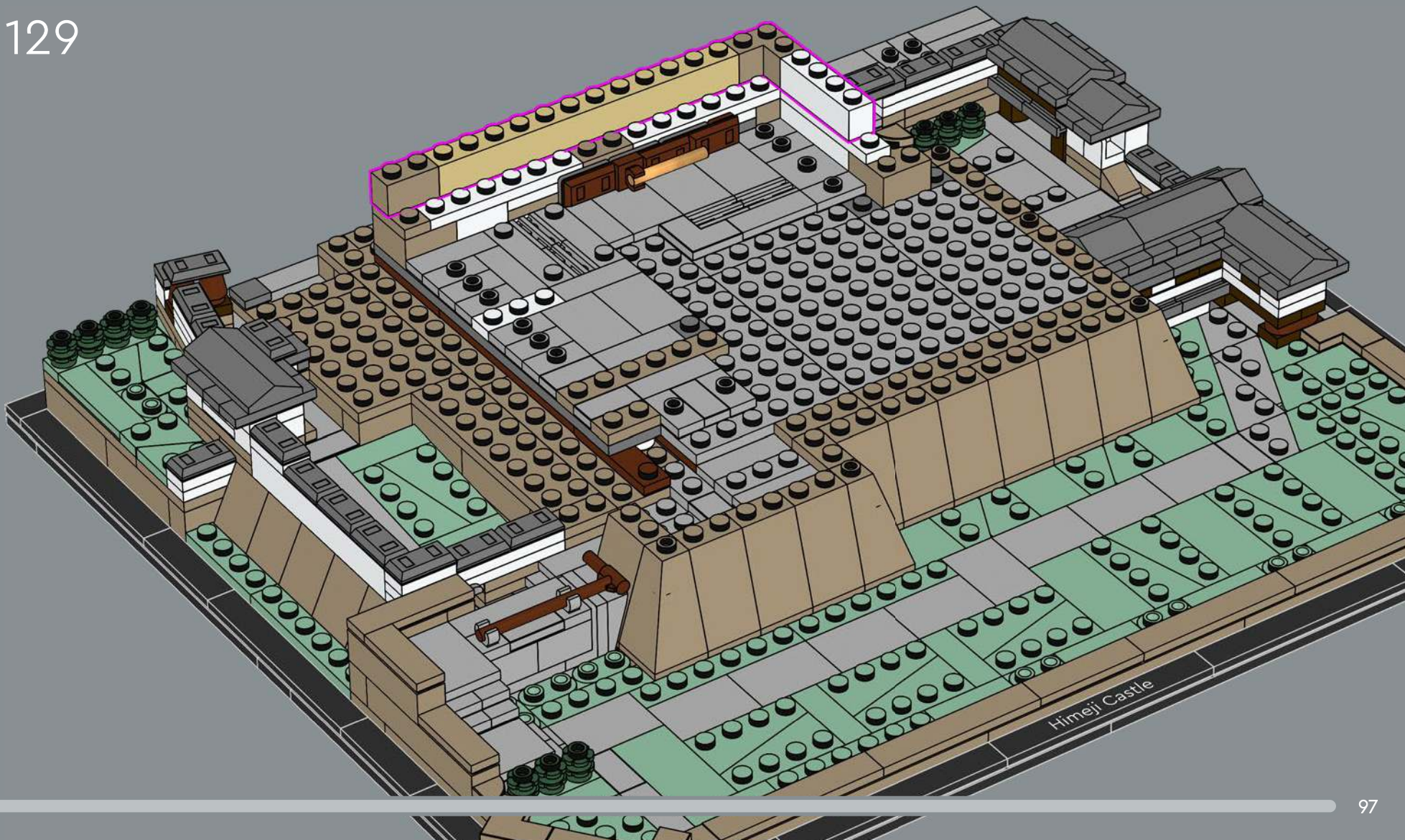

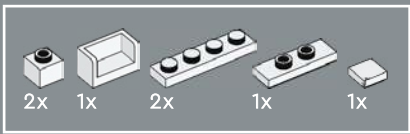

130

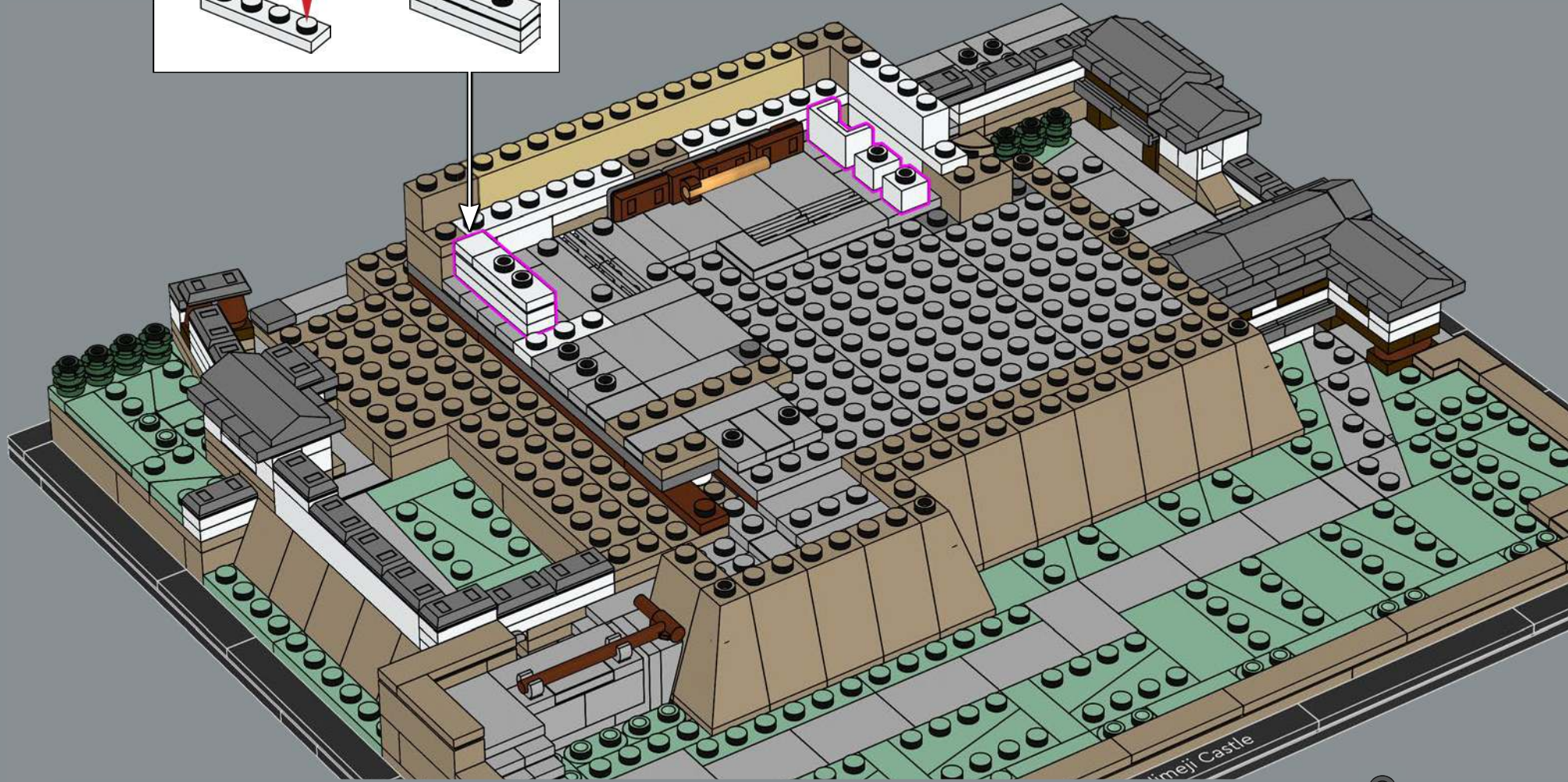
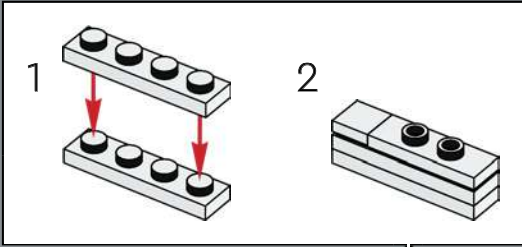

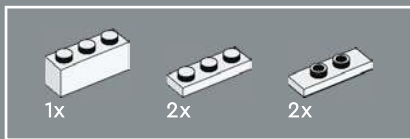

131

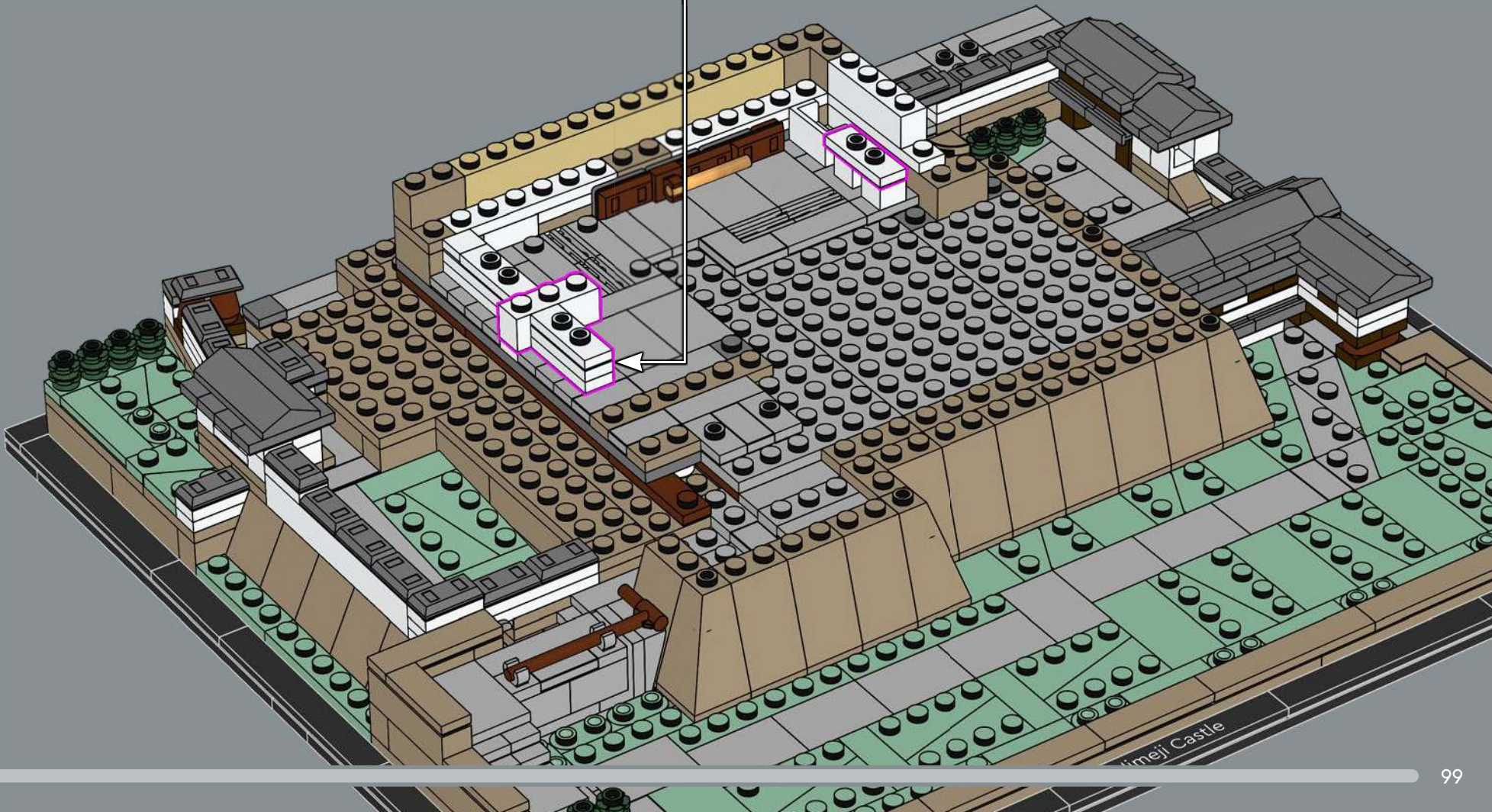
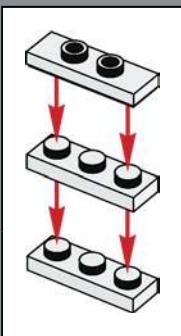

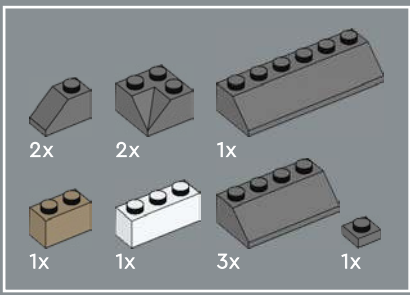

132



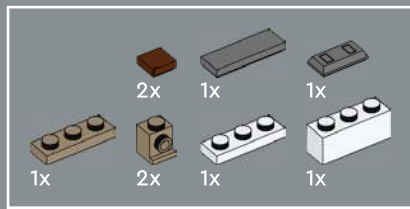

133

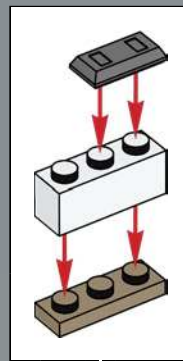
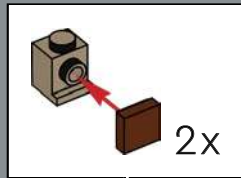

Meiji Castle

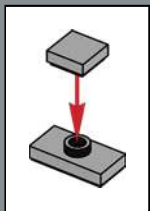
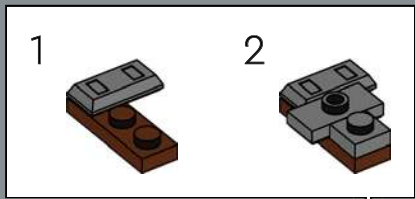
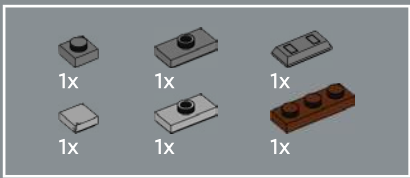

134

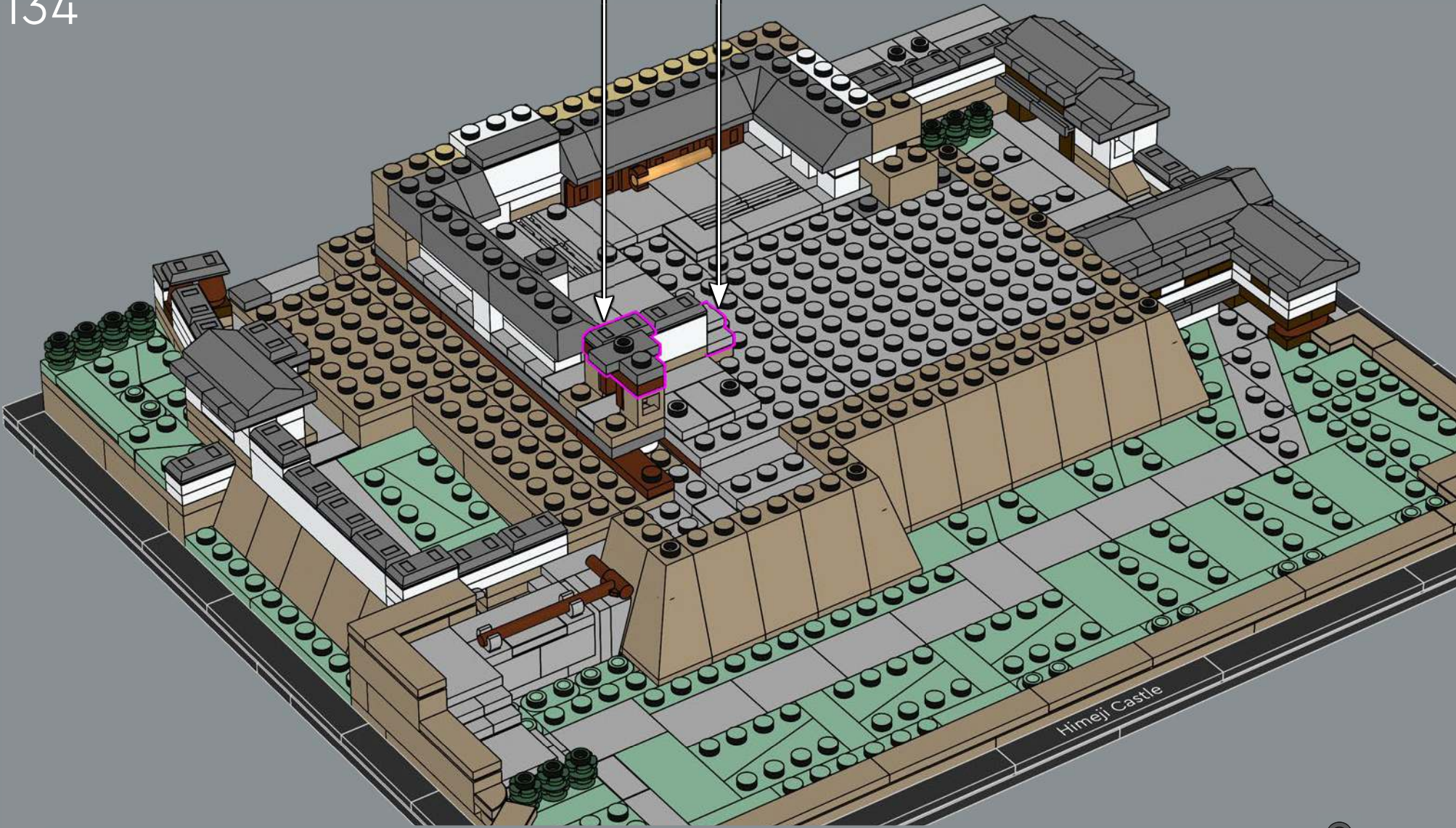

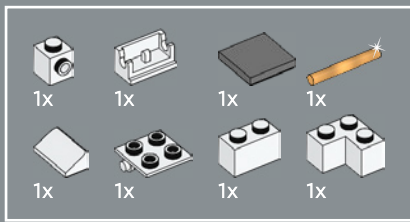

135

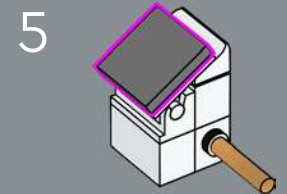
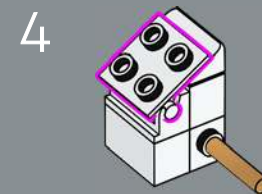
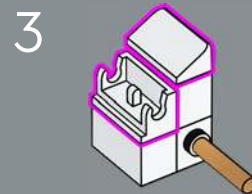
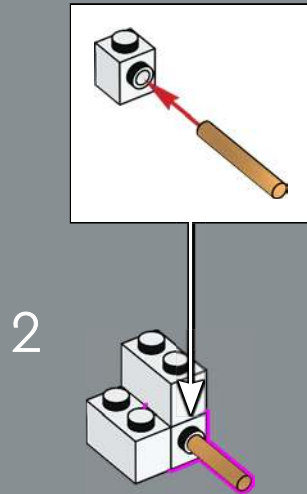
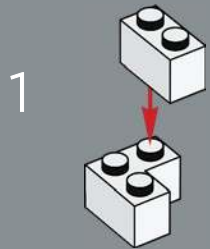

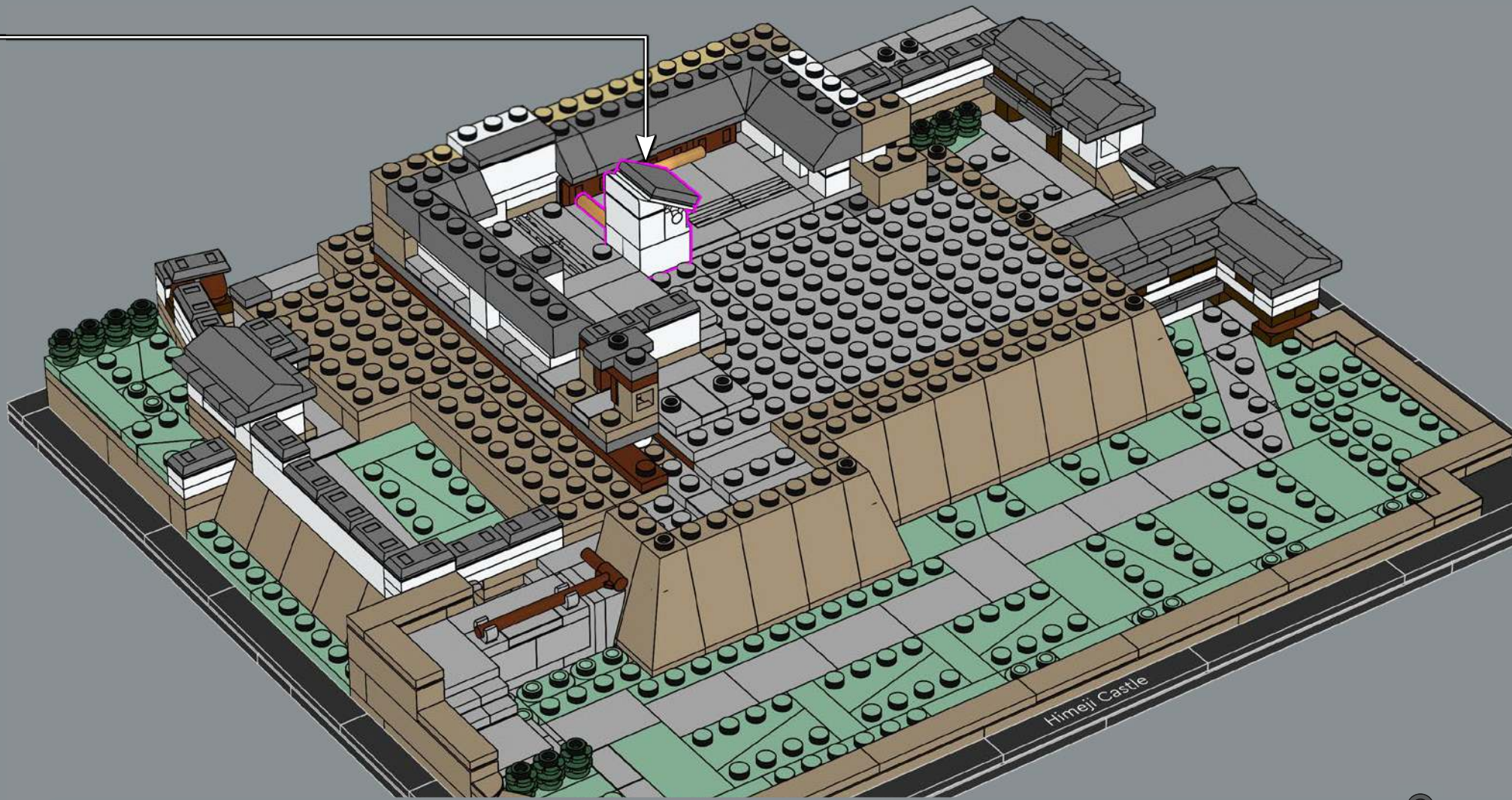

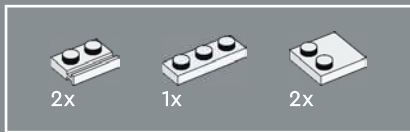

136

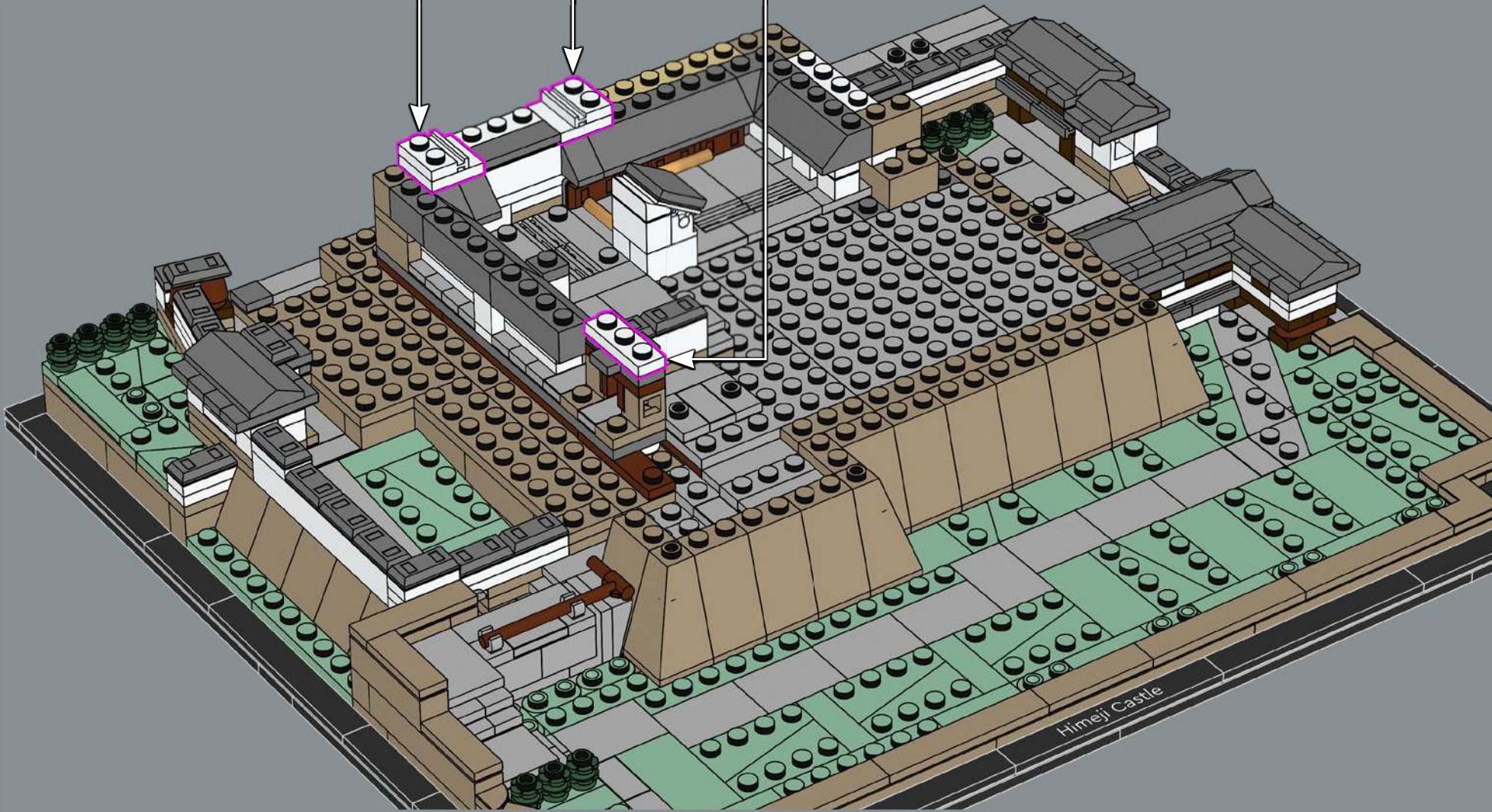
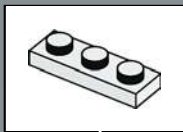
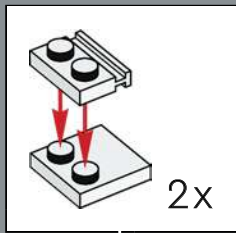

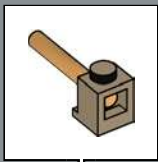
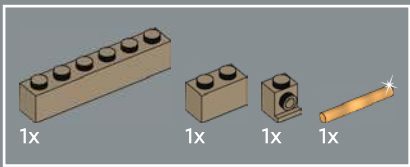

137

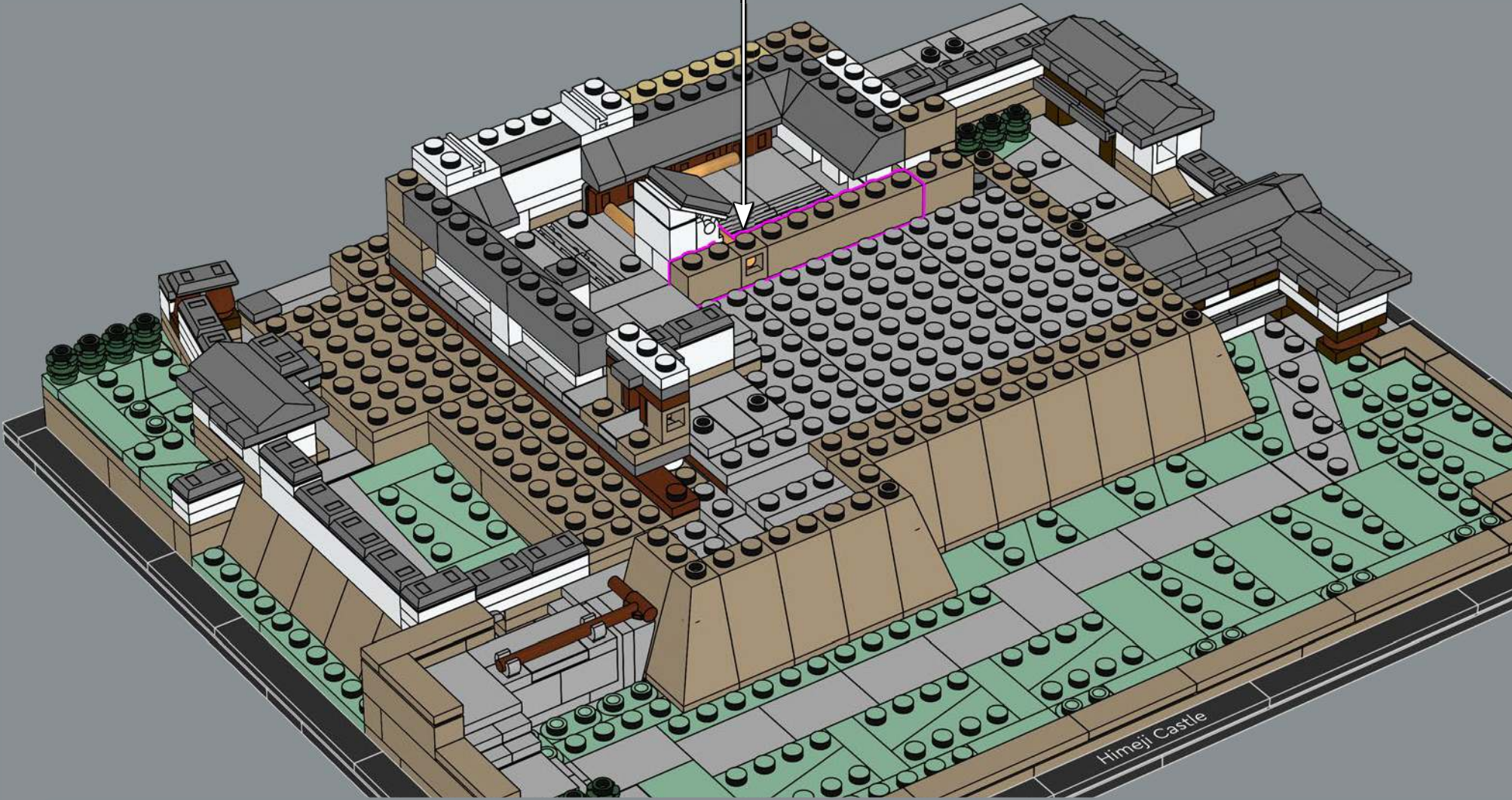

Himeji Castle

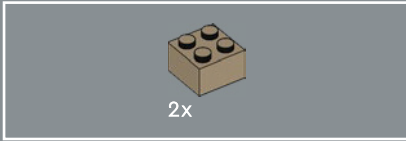
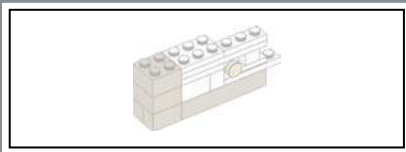

138

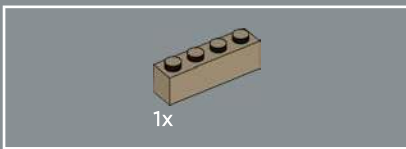
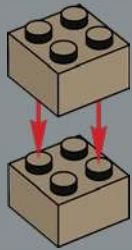

139

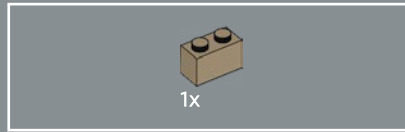
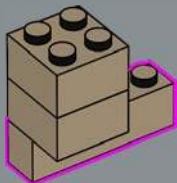

140

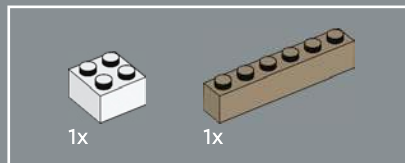
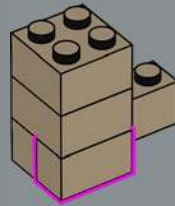

141

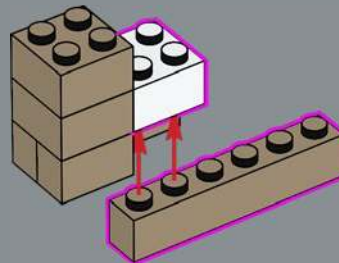

142

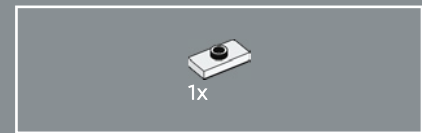
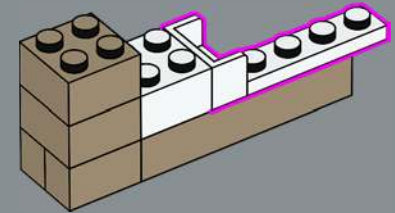

143

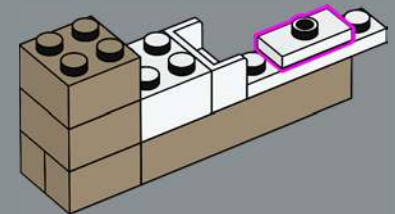

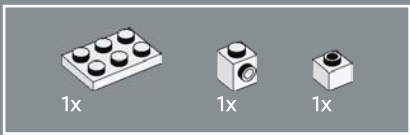

144

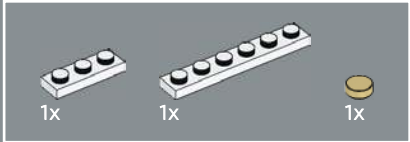
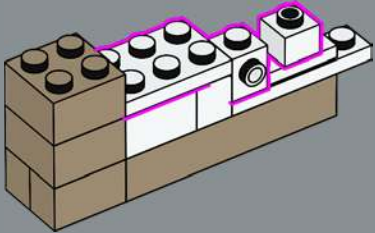

145

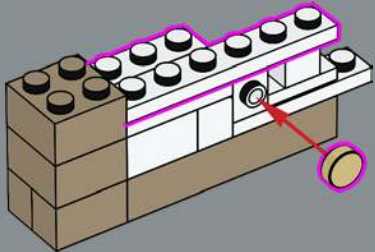

146

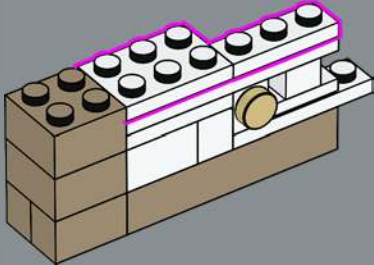

147

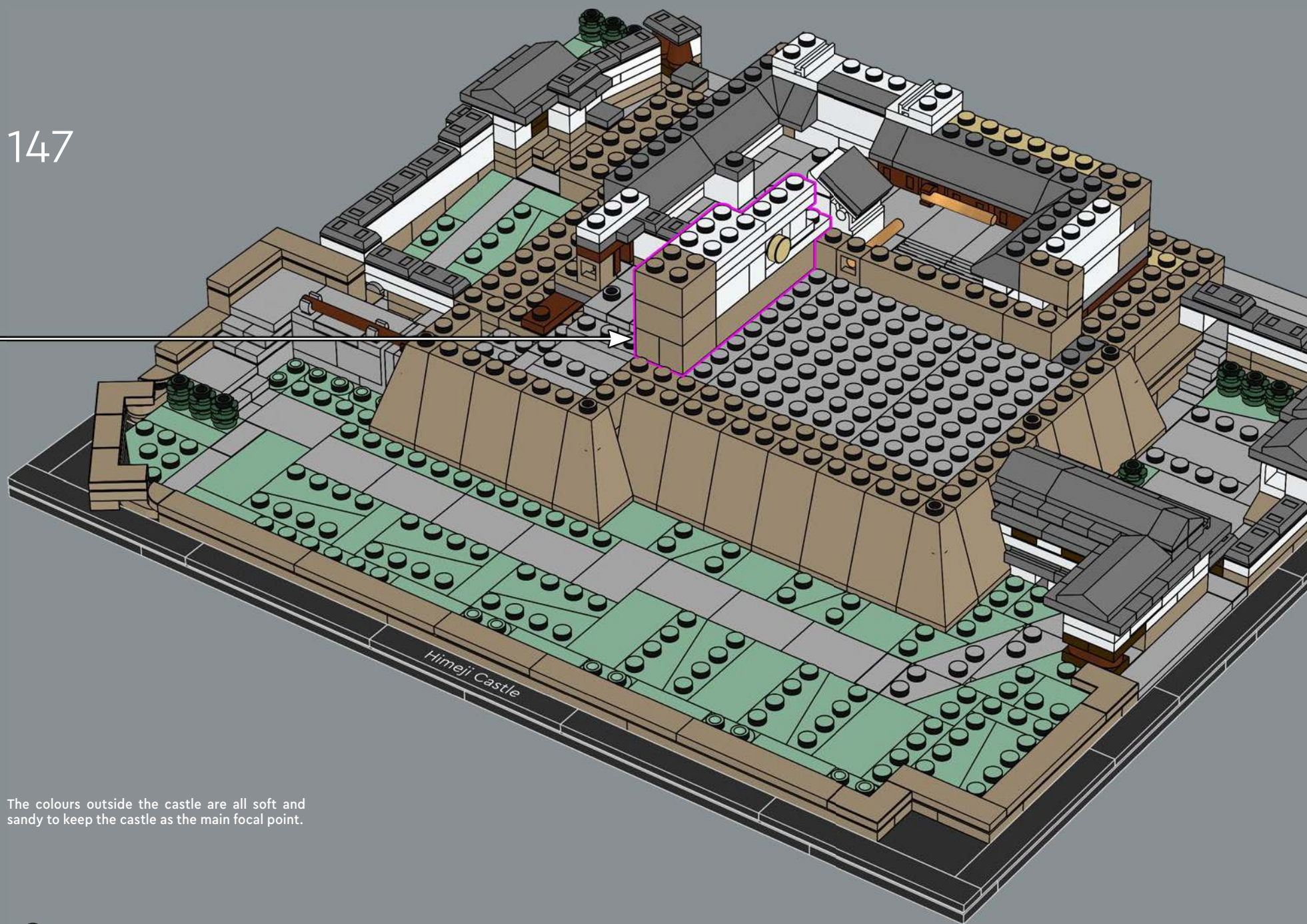

The colours outside the castle are all soft and sandy to keep the castle as the main focal point.



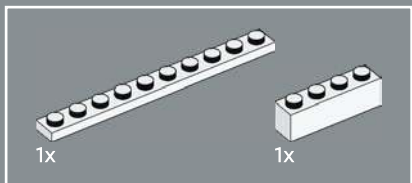

148

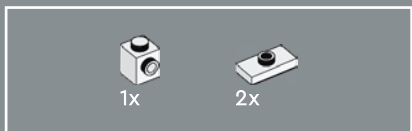
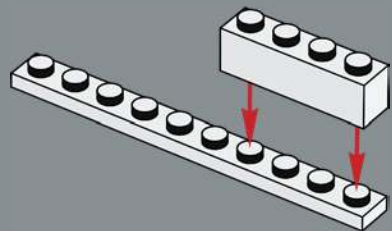

149

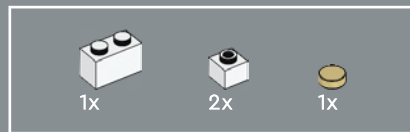
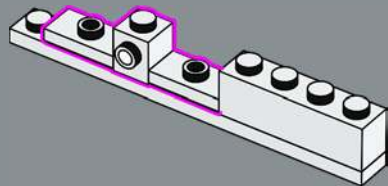

150

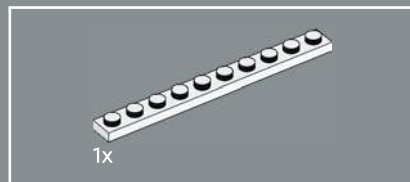
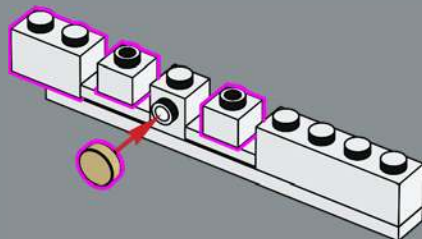

151

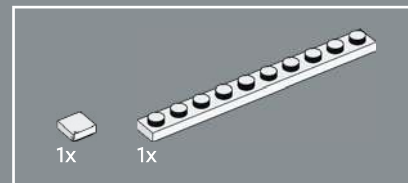
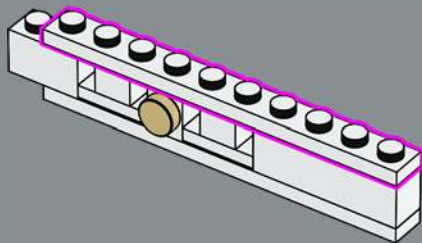

152

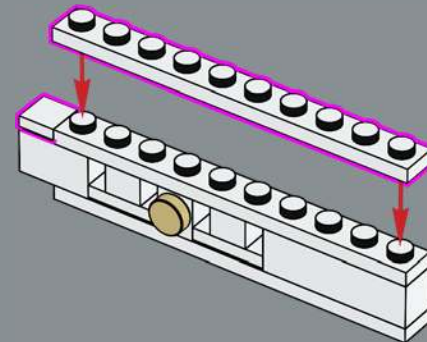

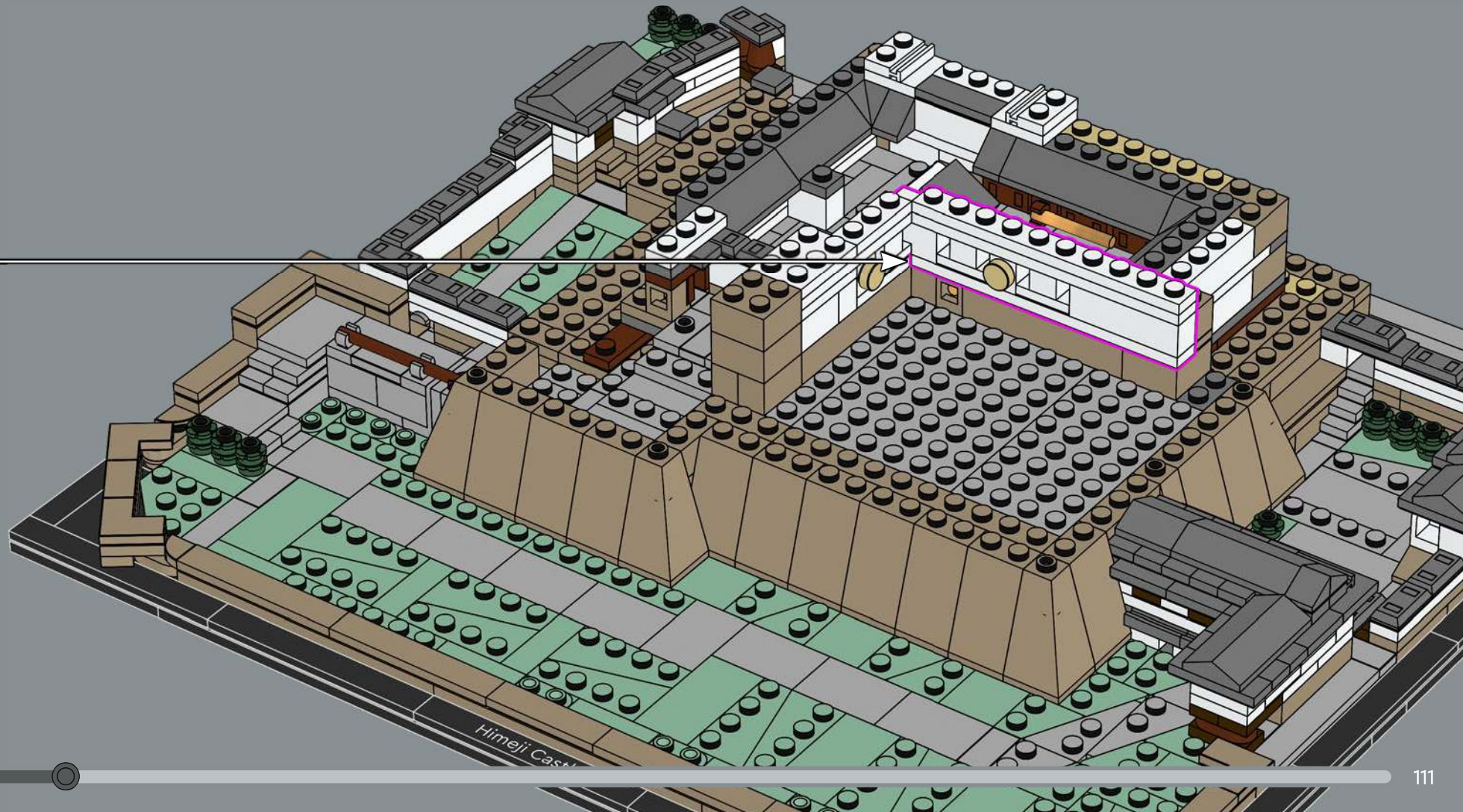

Himeji Castle

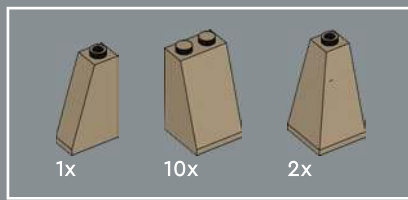

154

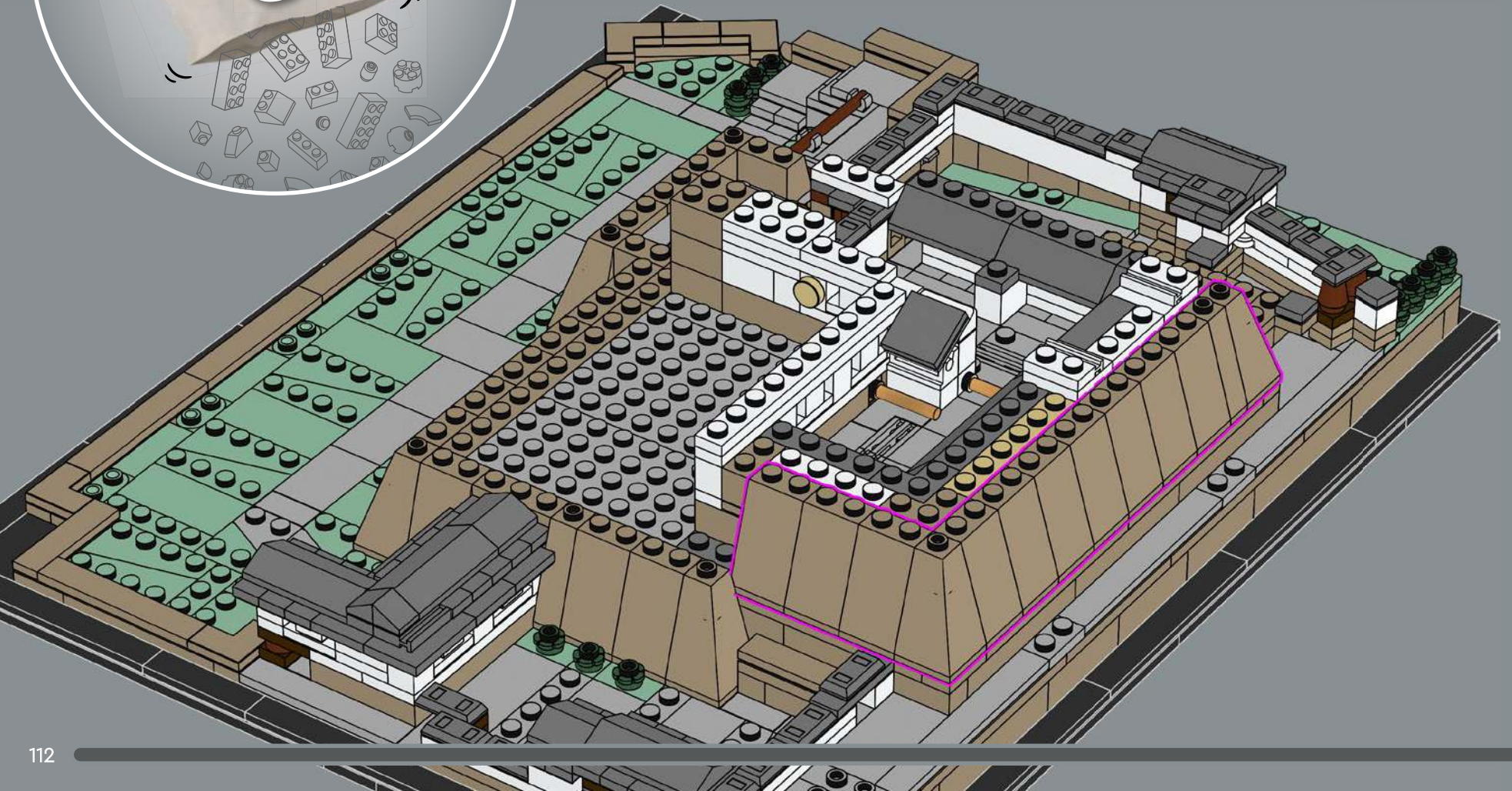

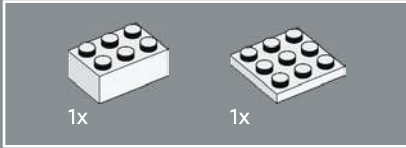

155

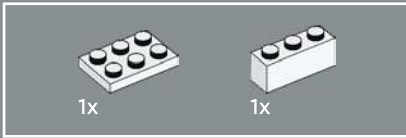
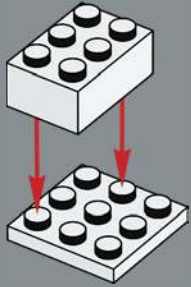

156

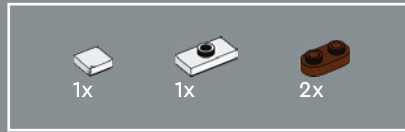
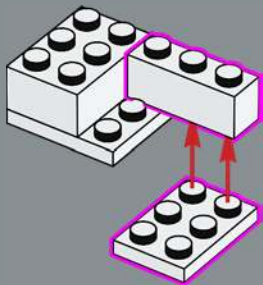

157

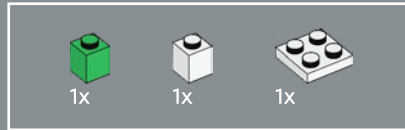
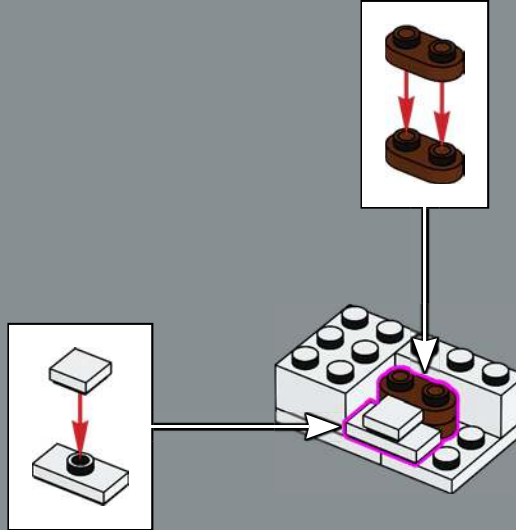

158

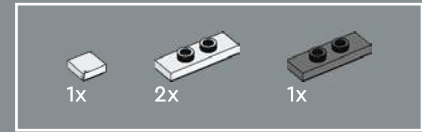
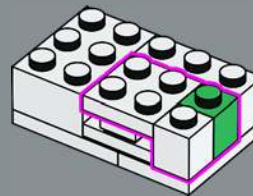

159

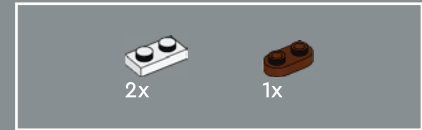
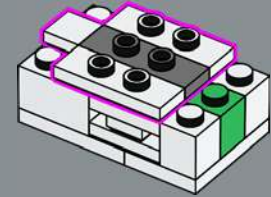

160

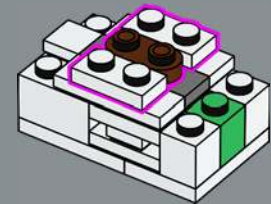

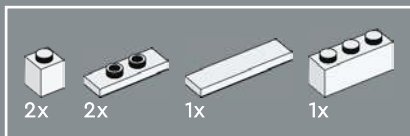

161

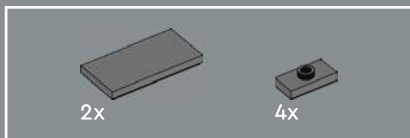
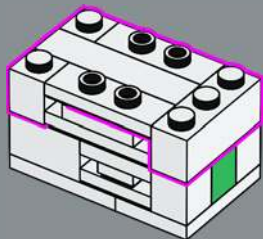

162

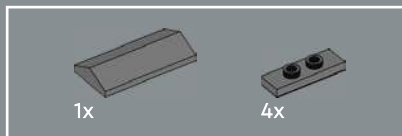
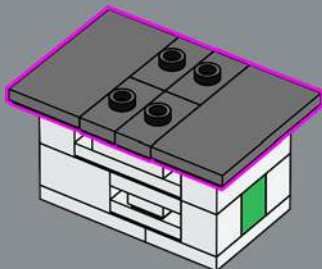

163

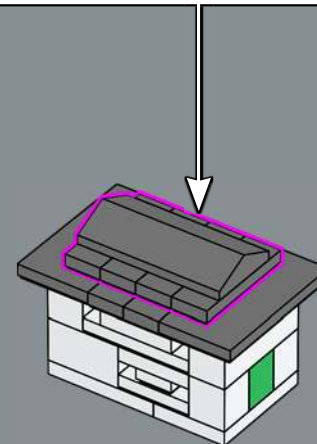
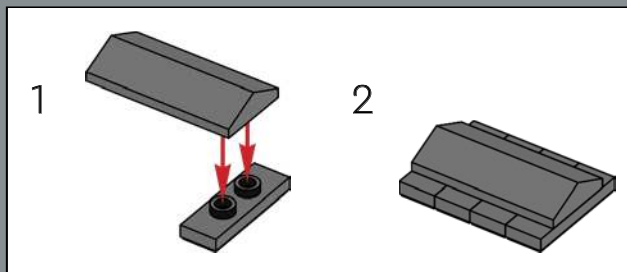

164





169

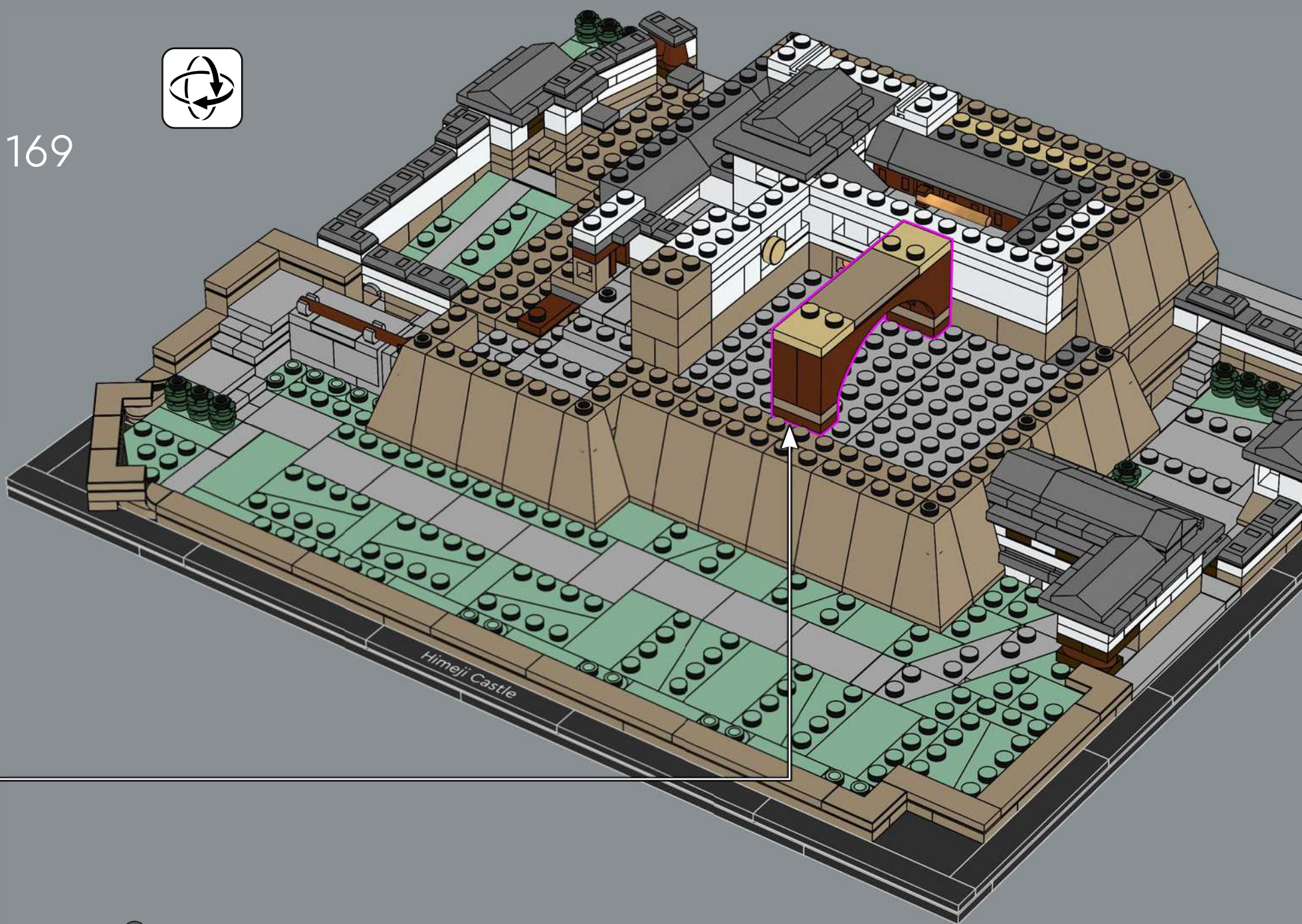

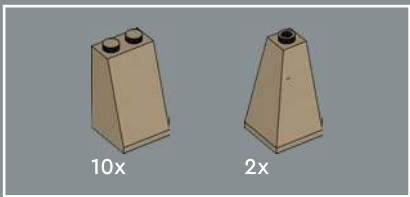

170

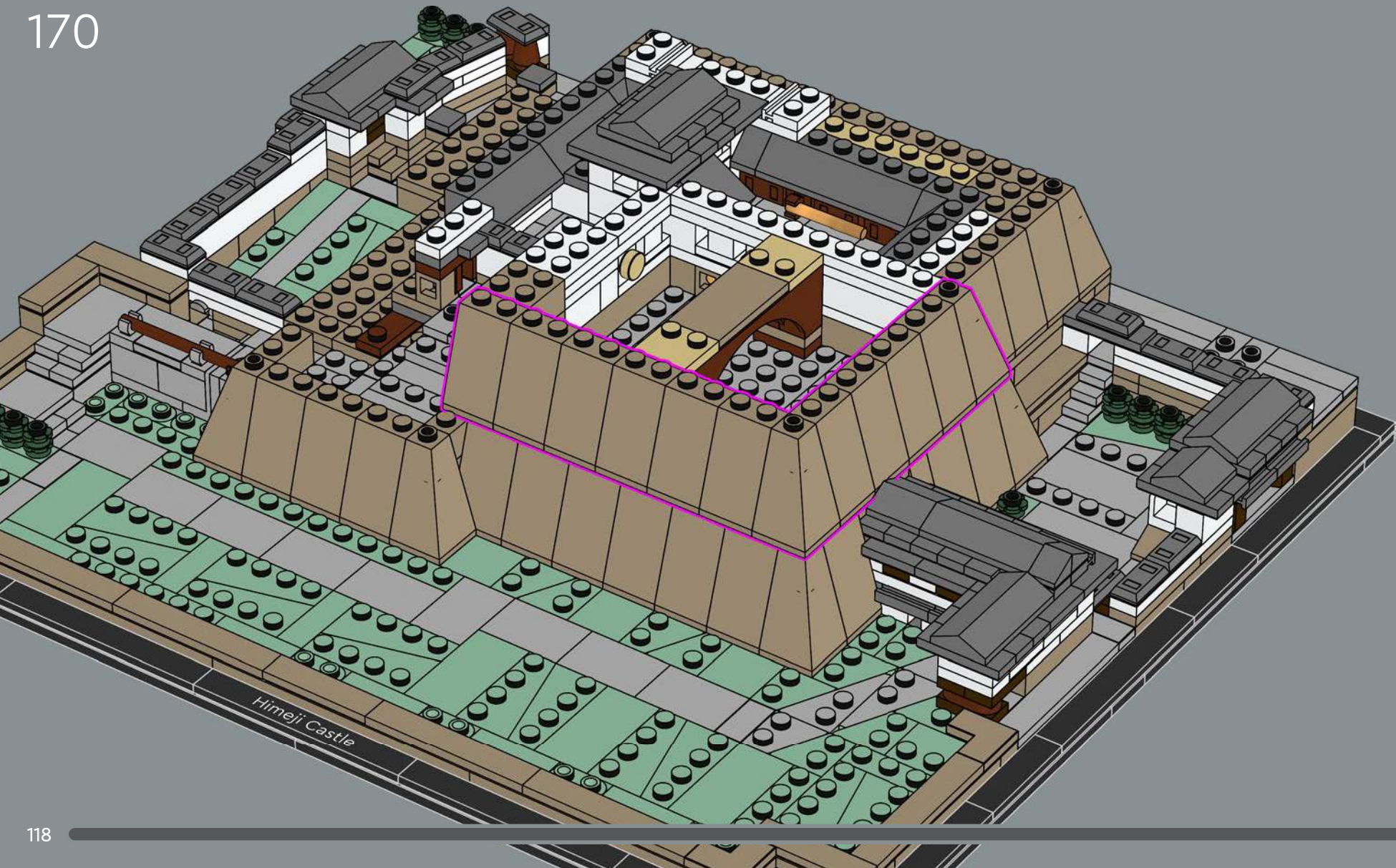

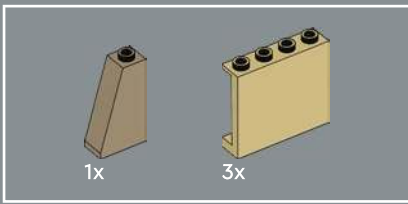

171



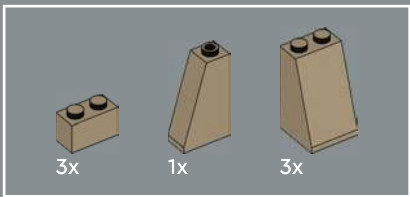

172

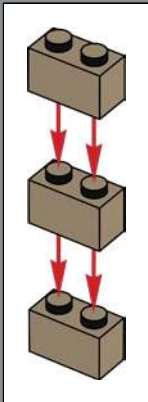

Himeji Castle

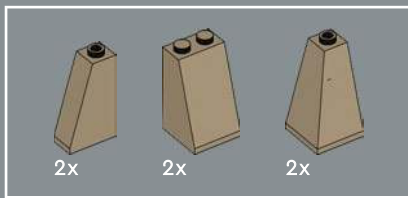

173



Himeji Castle

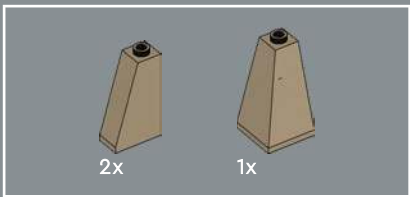

174

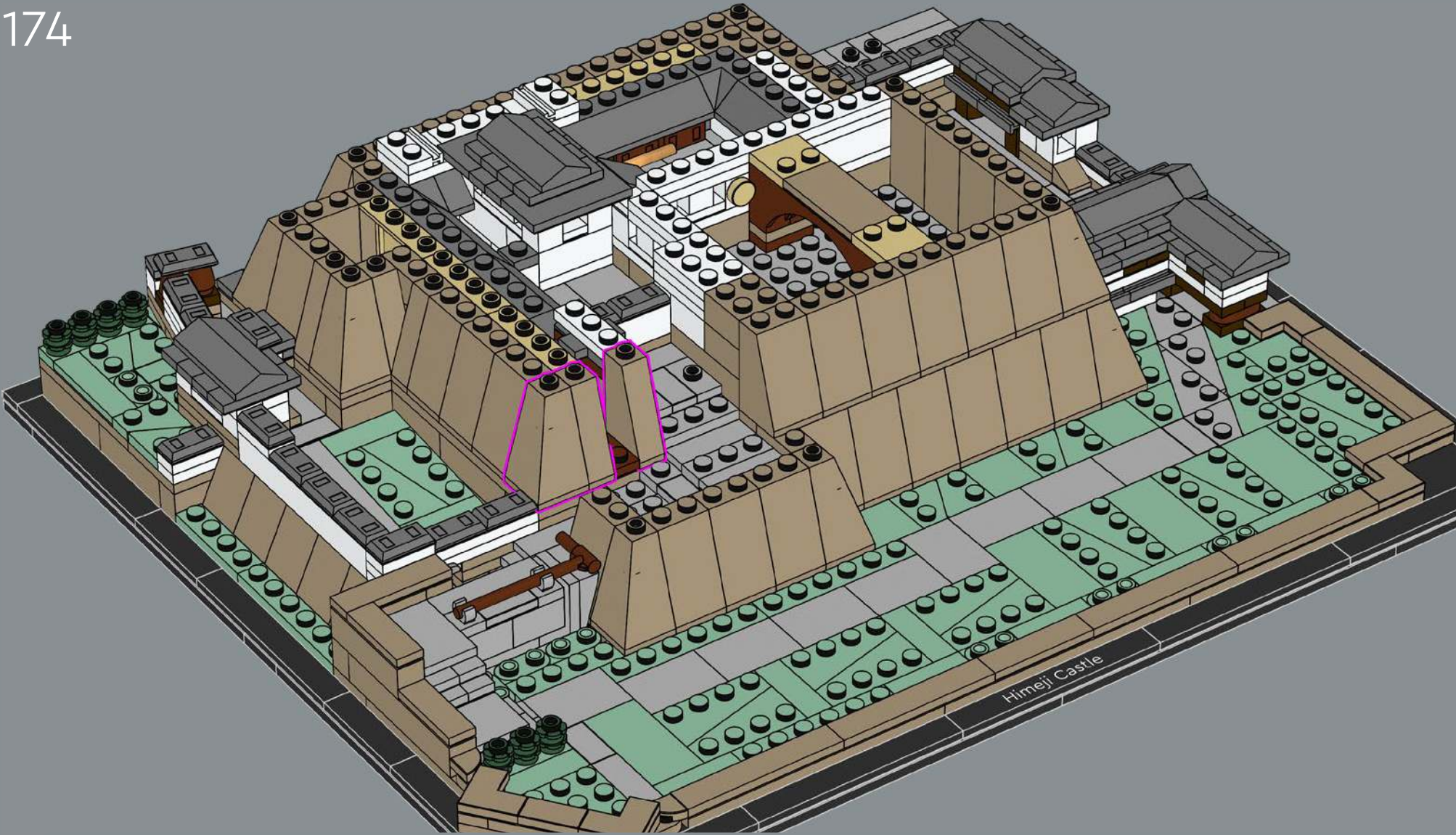



175

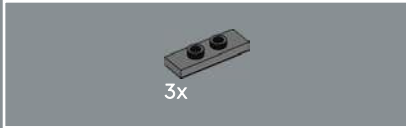
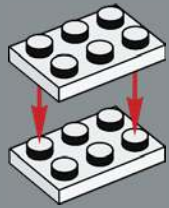

176

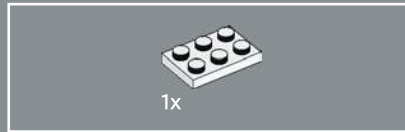

177

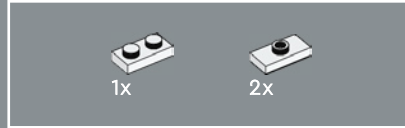

178

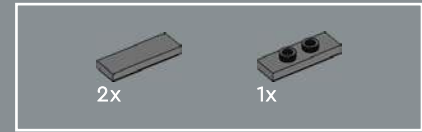
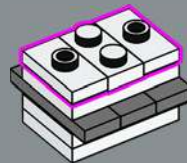

179

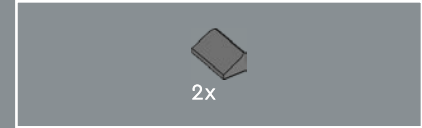
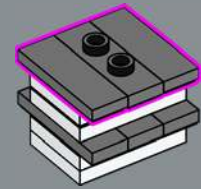

180

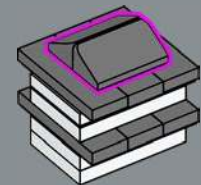

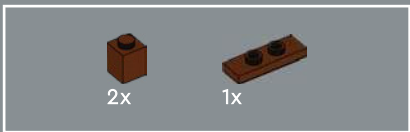

181

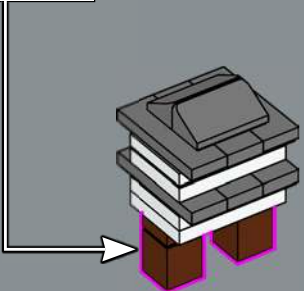
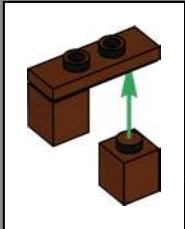

182

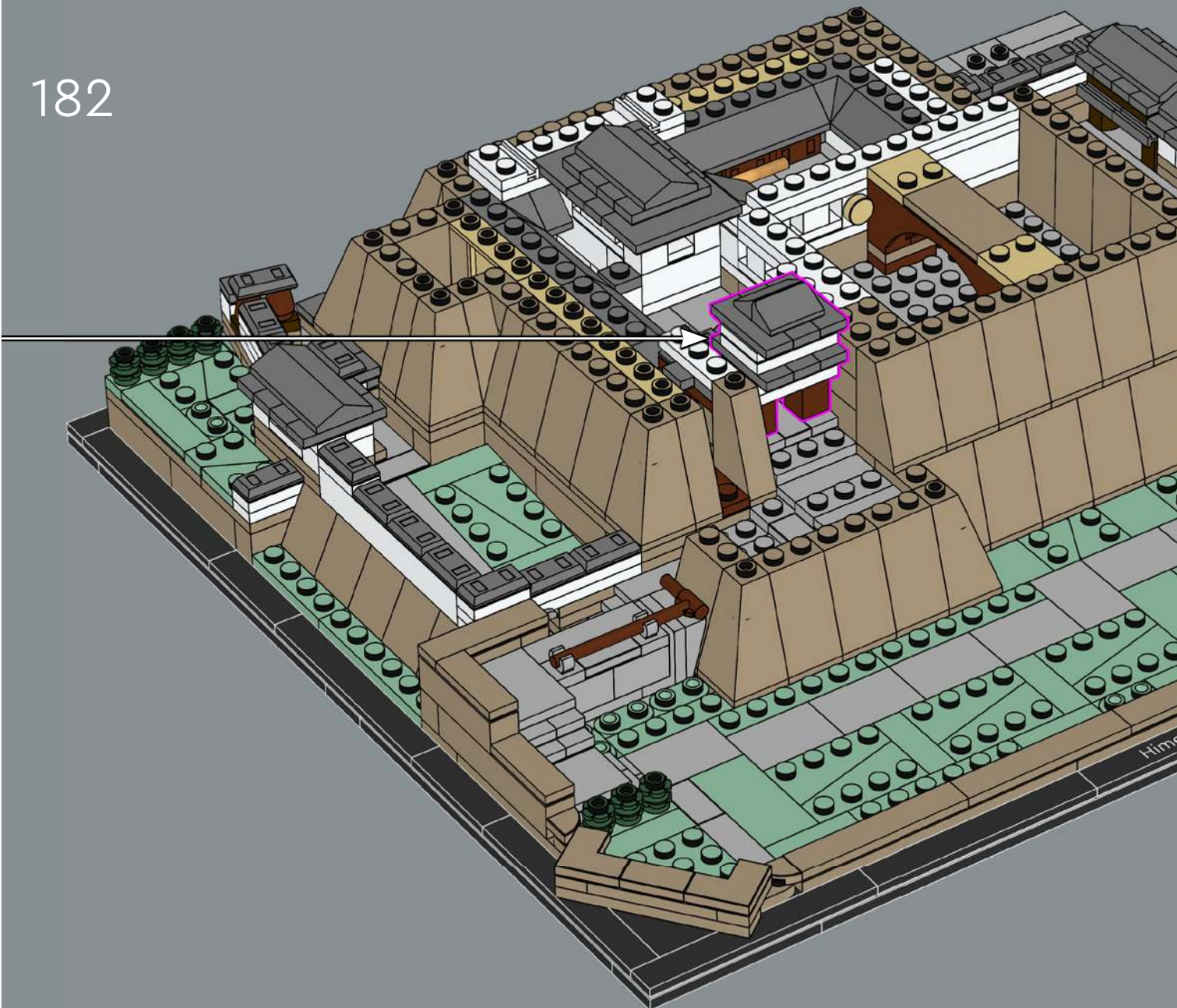

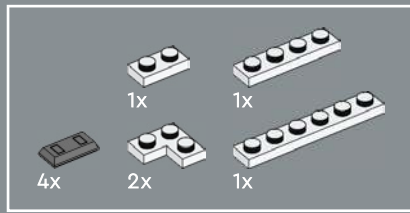

183

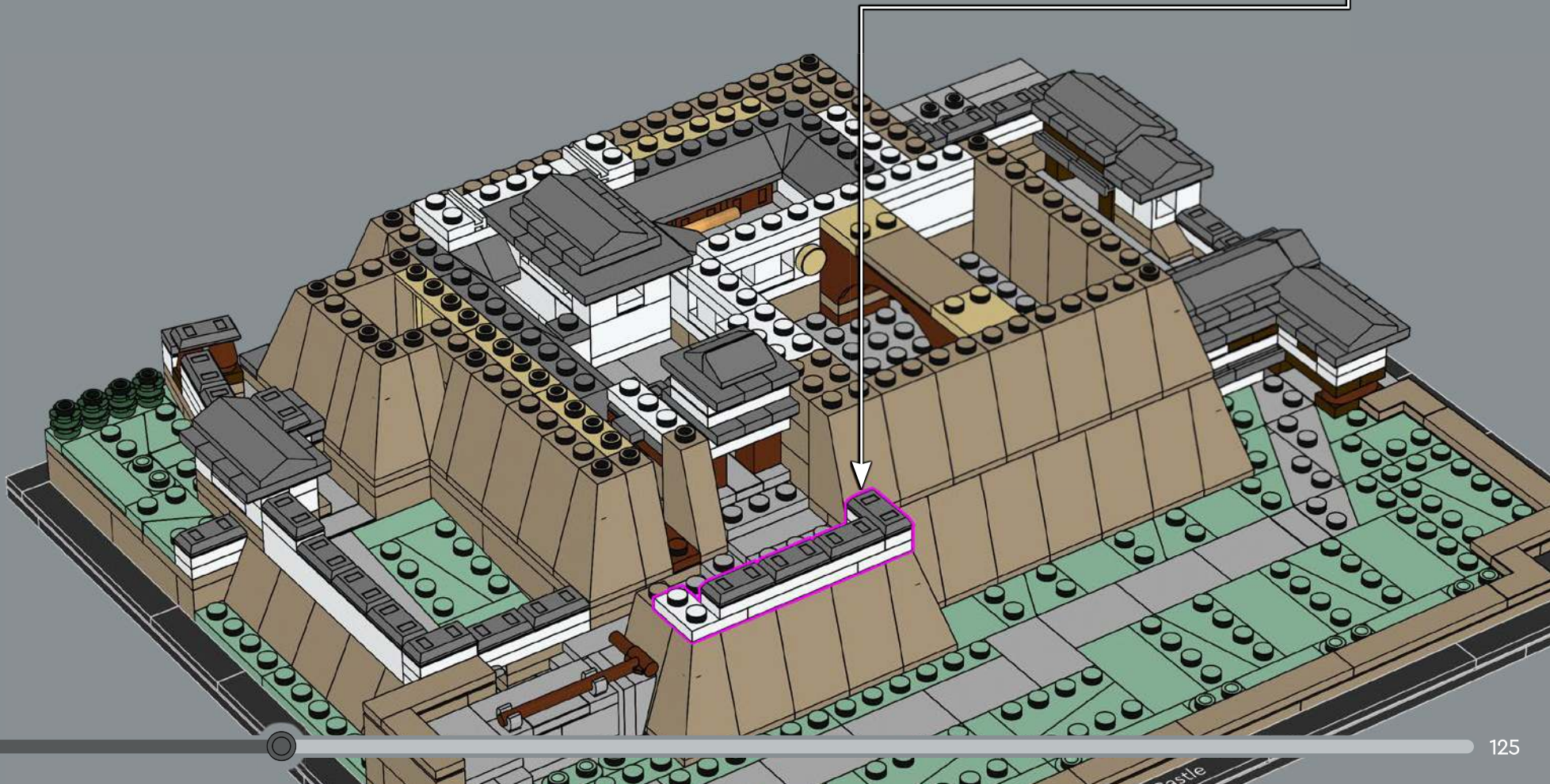
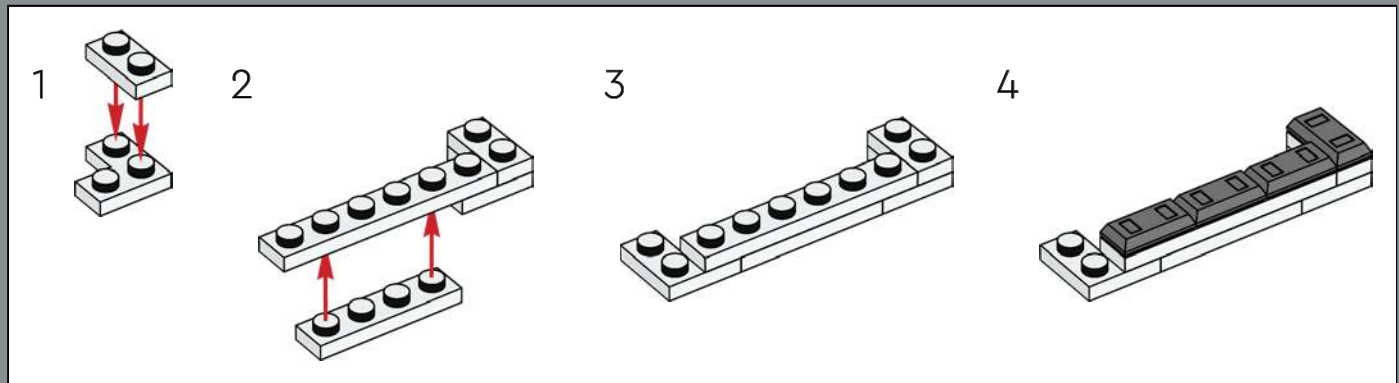

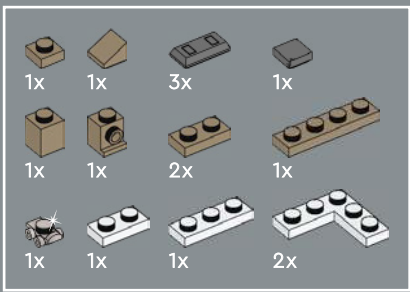

184

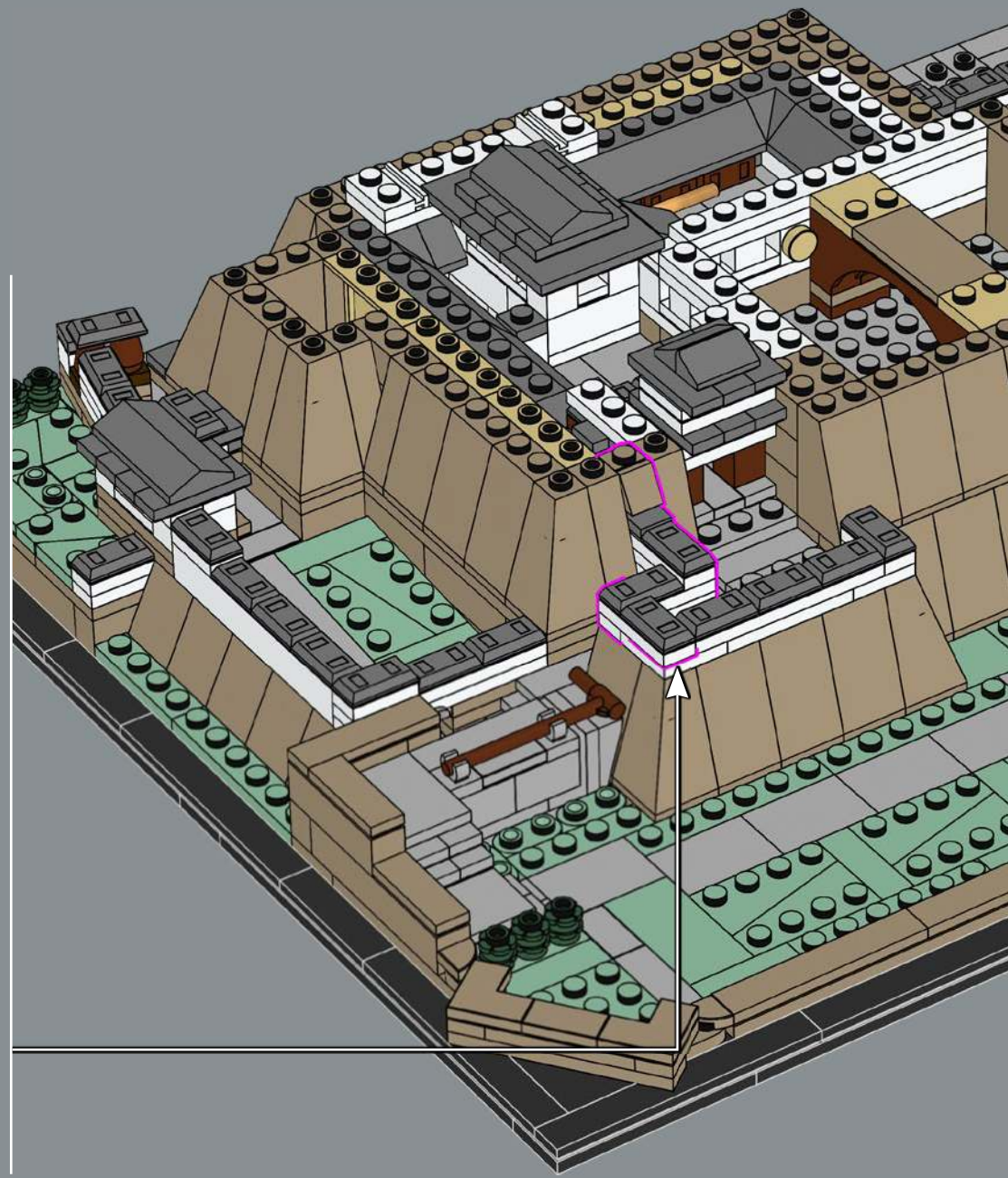
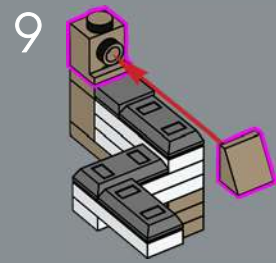
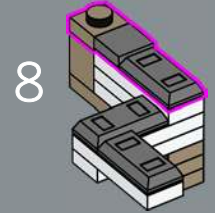
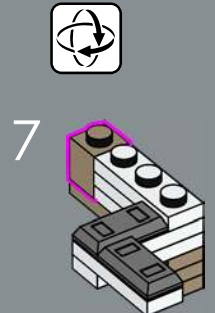
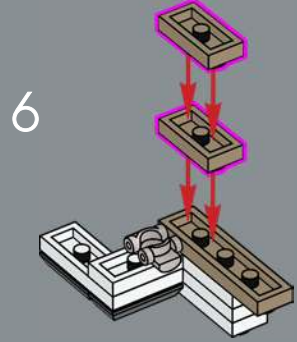
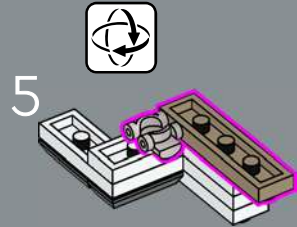
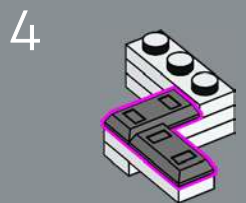
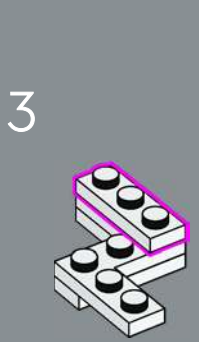
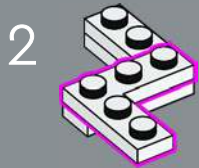
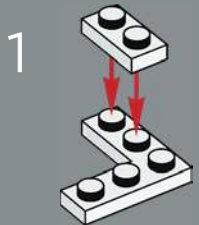

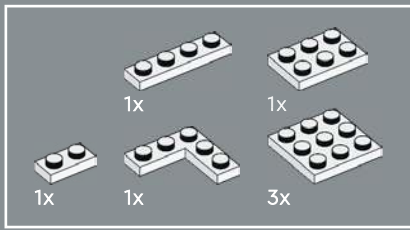

185

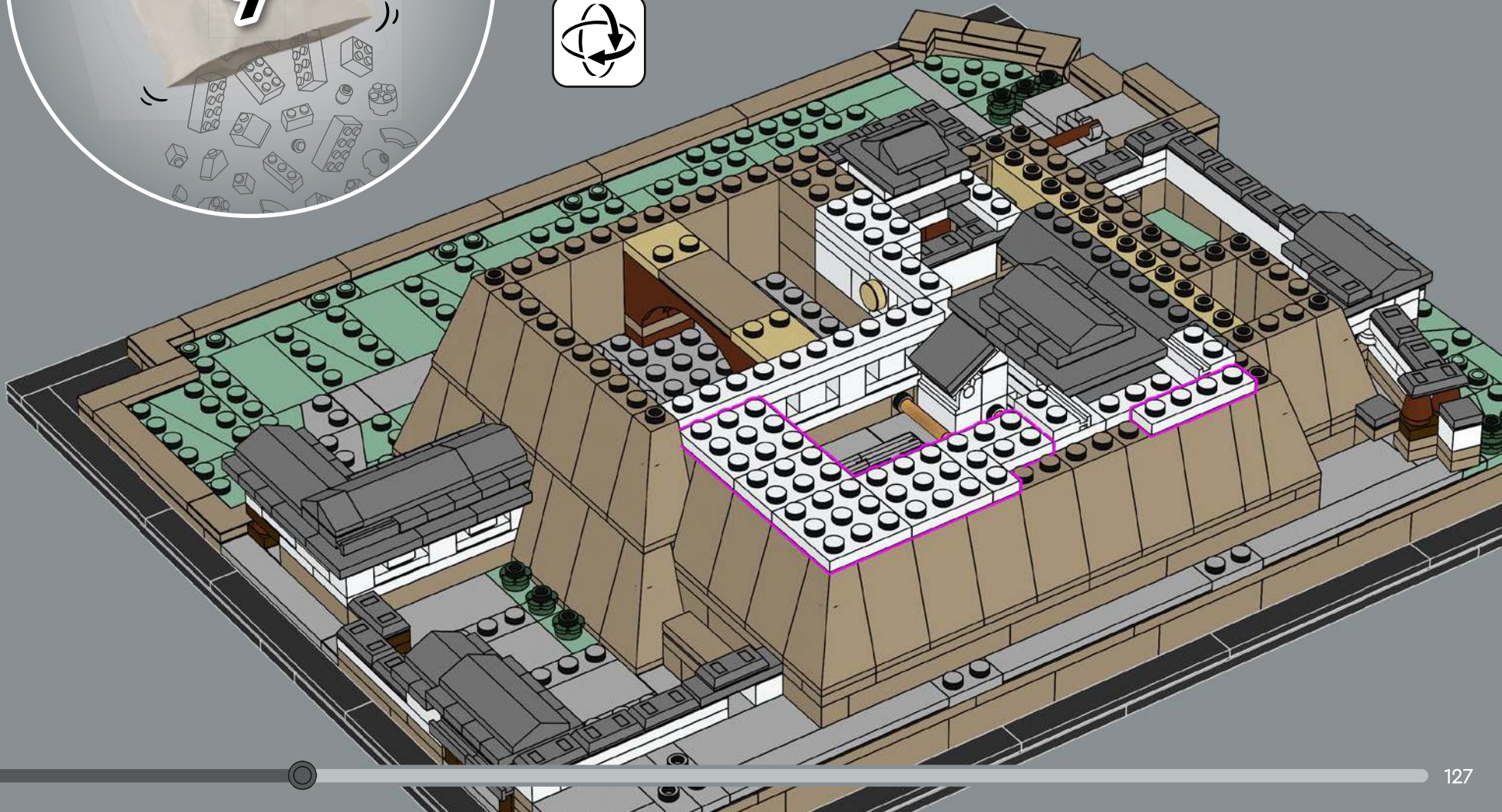

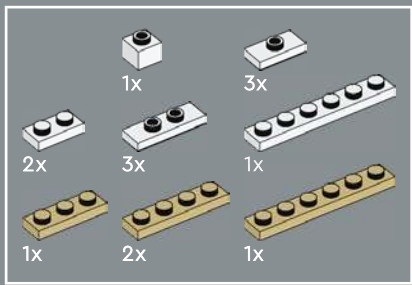

186

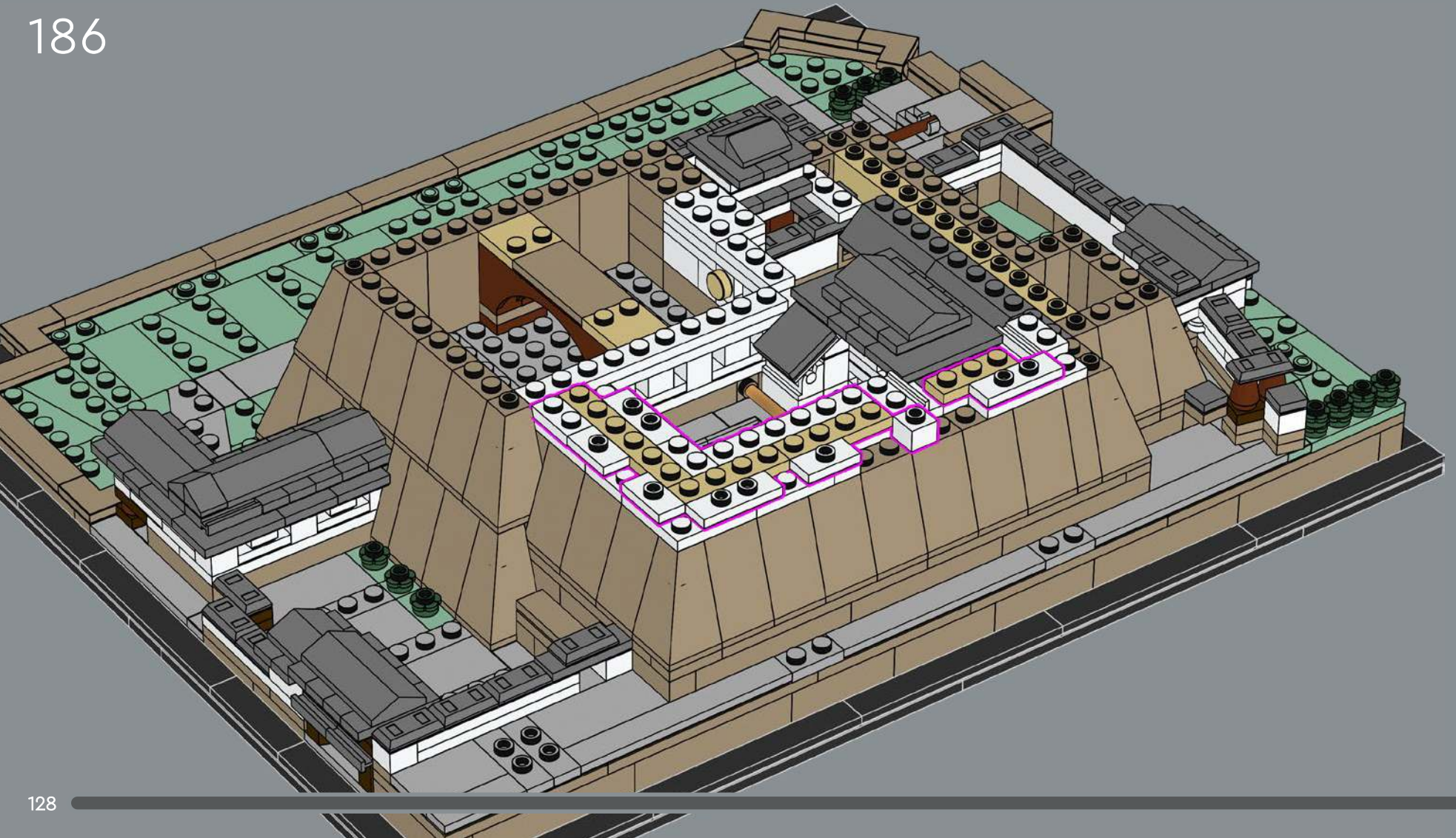

During the 2009–2015 renovation, several sides of the exterior scaffolding had line art drawings of the castle to keep the iconic landmark visible on the Himeji skyline.

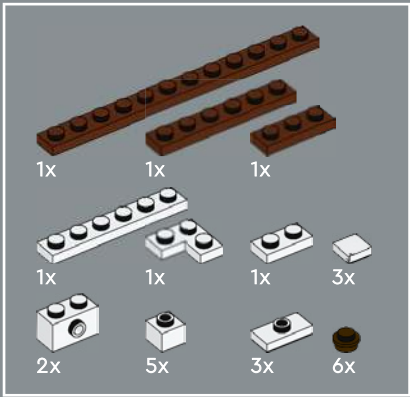

187



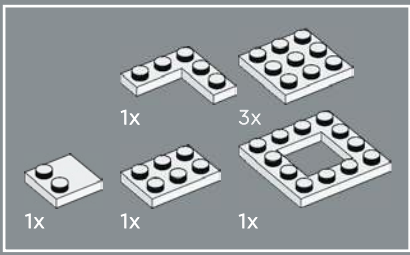

188

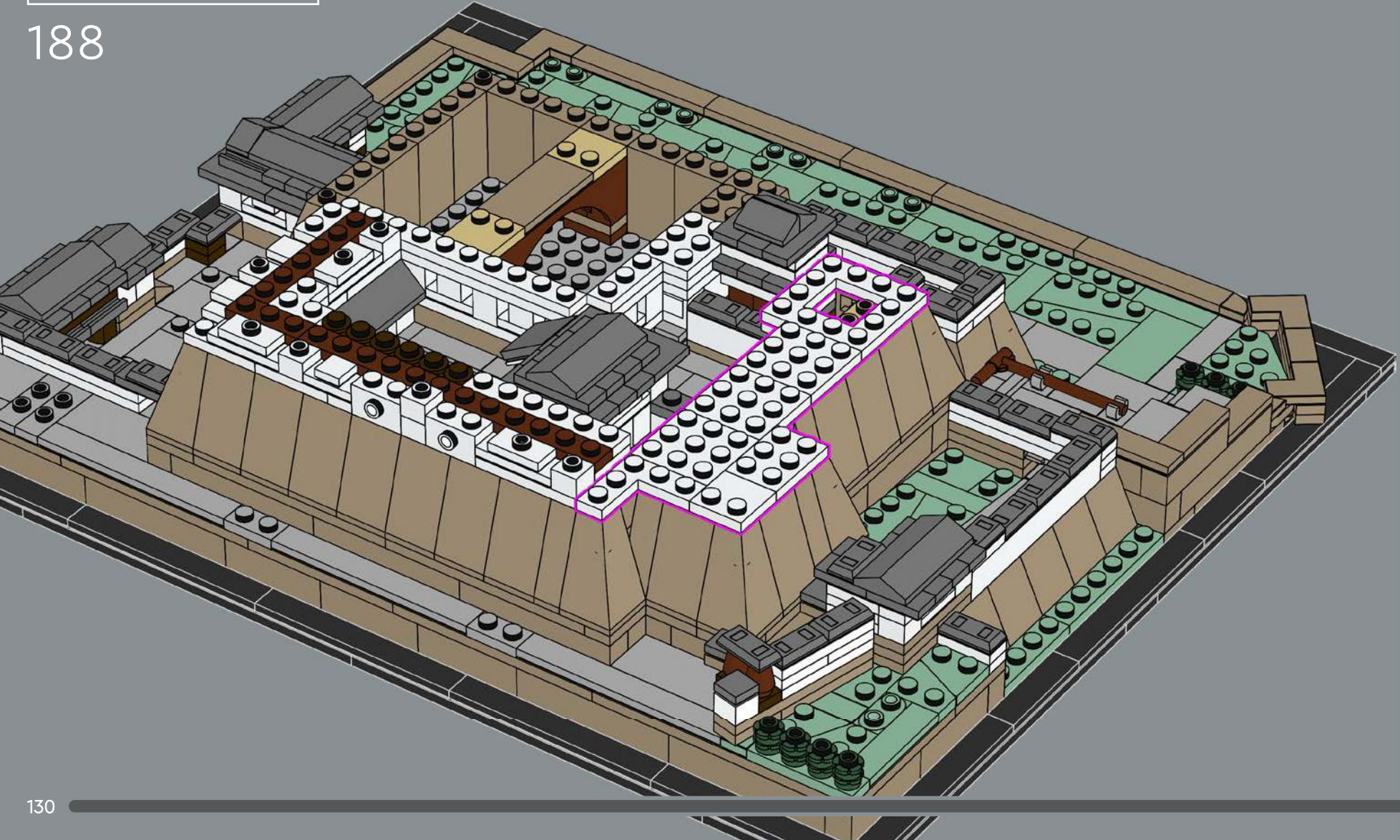

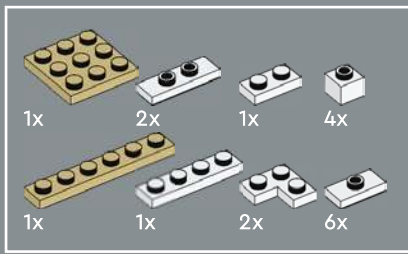

189



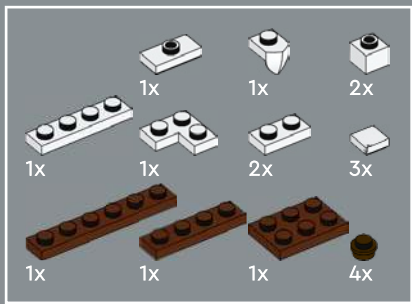

190



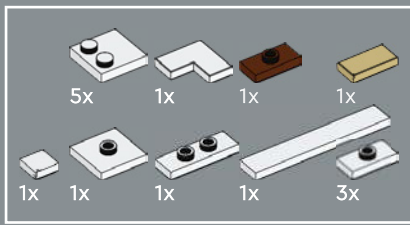

191

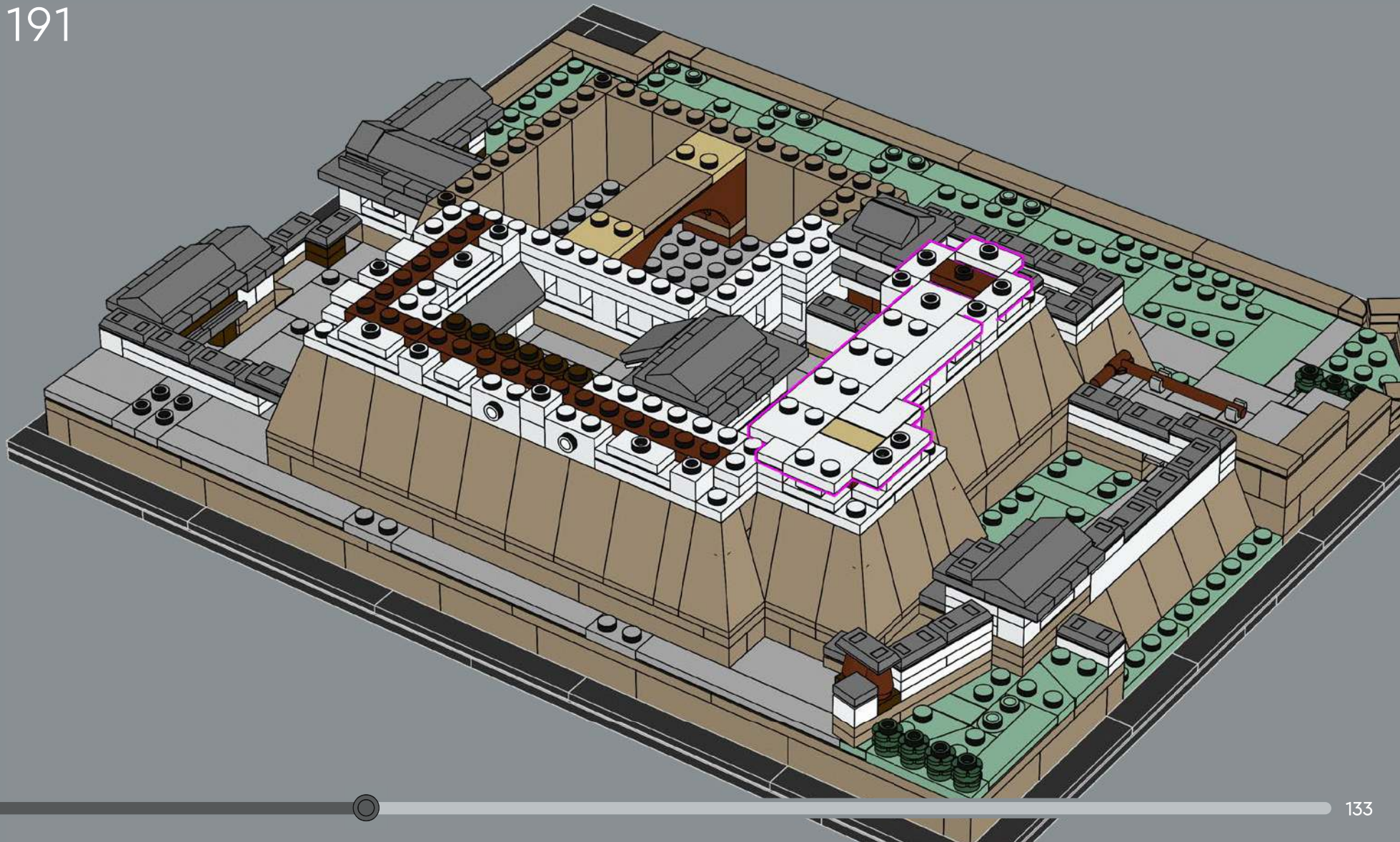

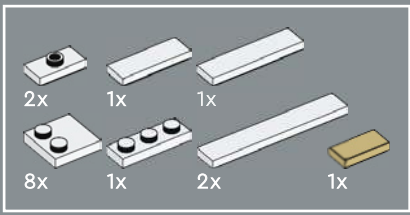

192

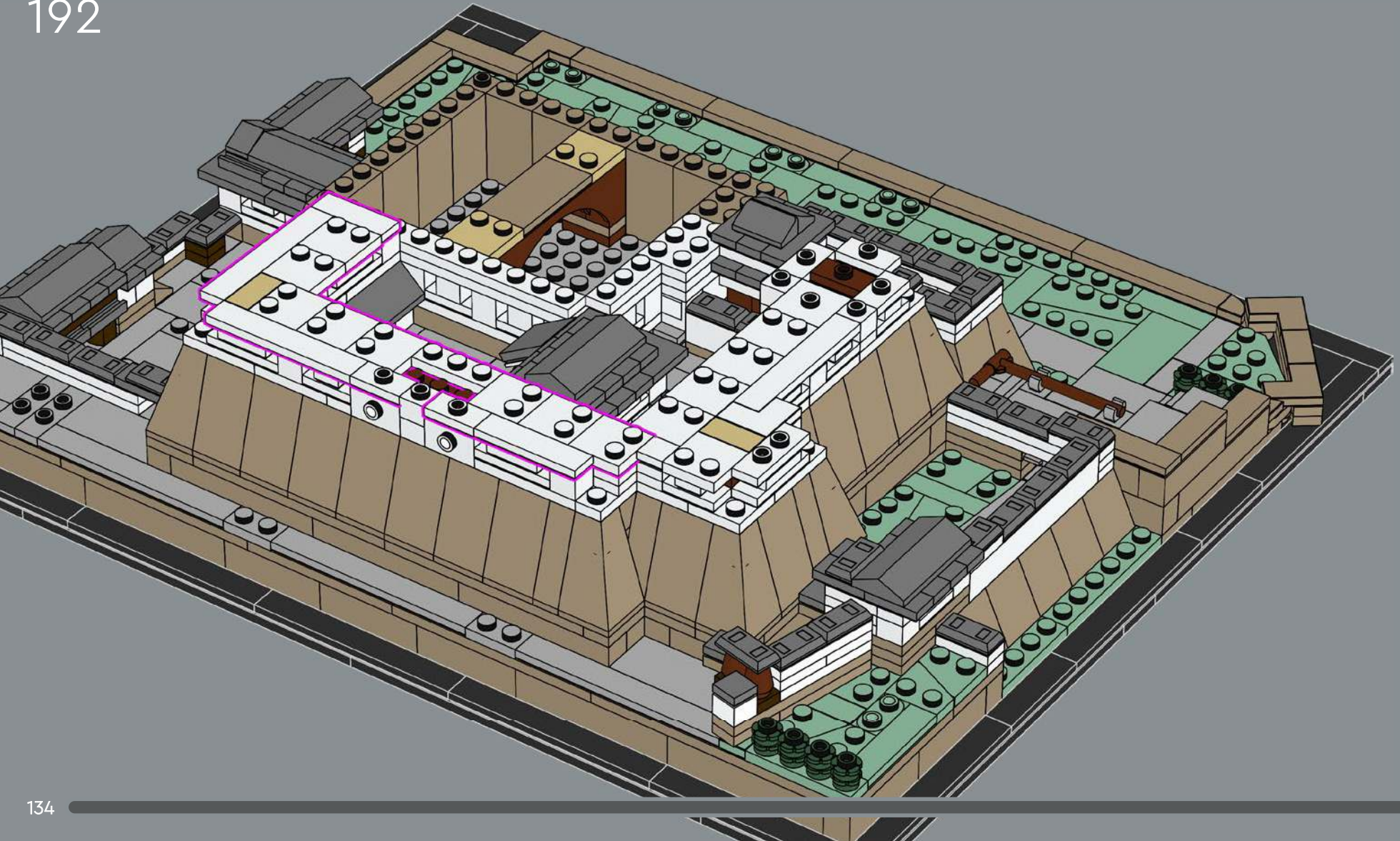

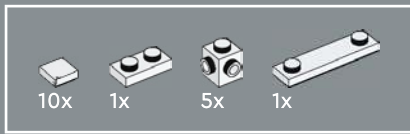

193

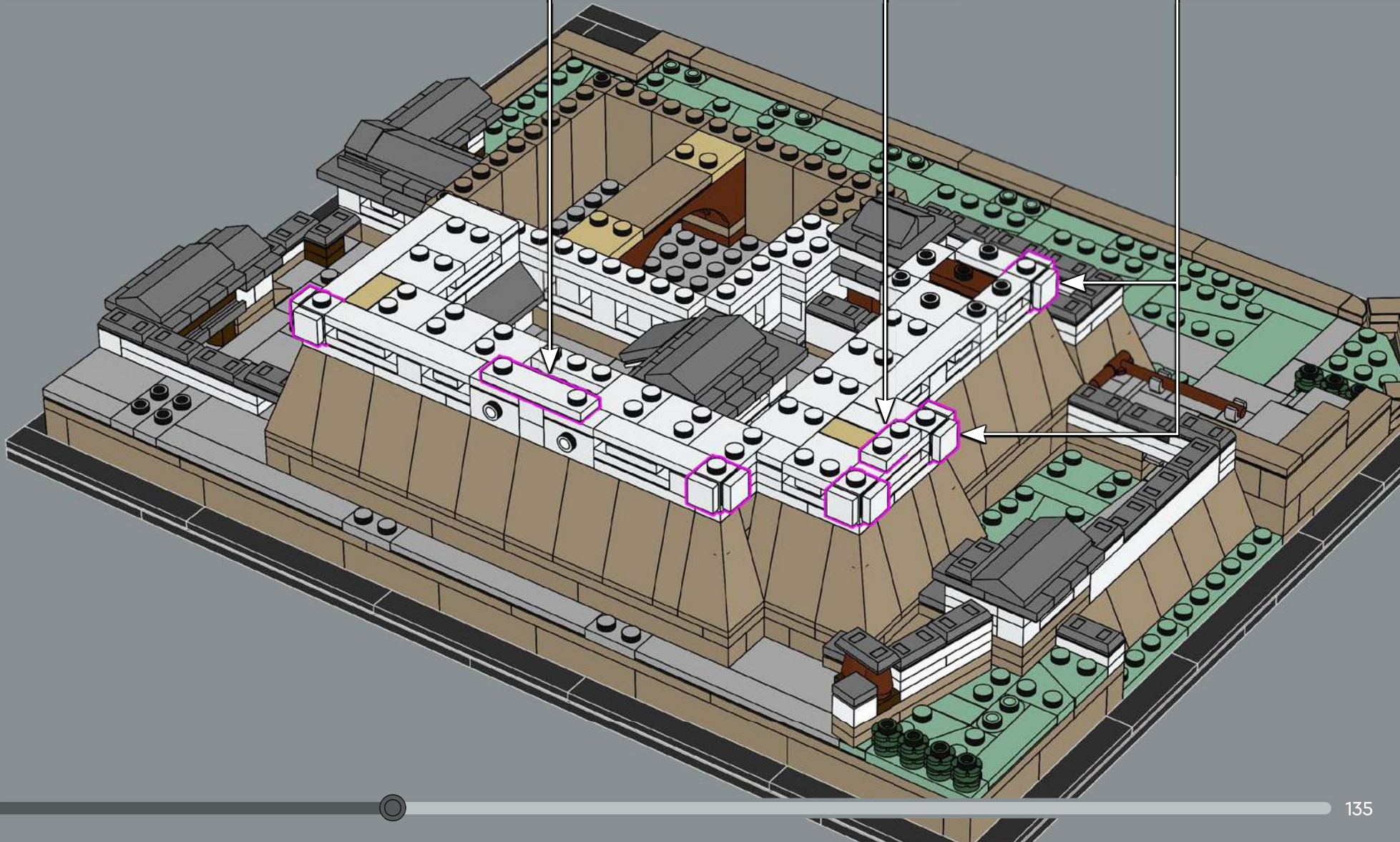
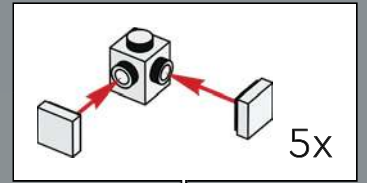
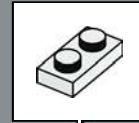
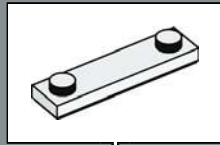

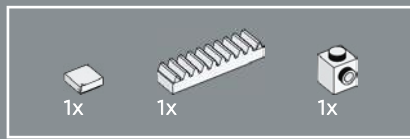

194

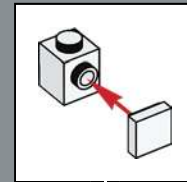
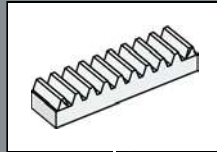

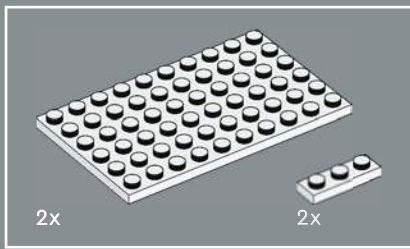

195

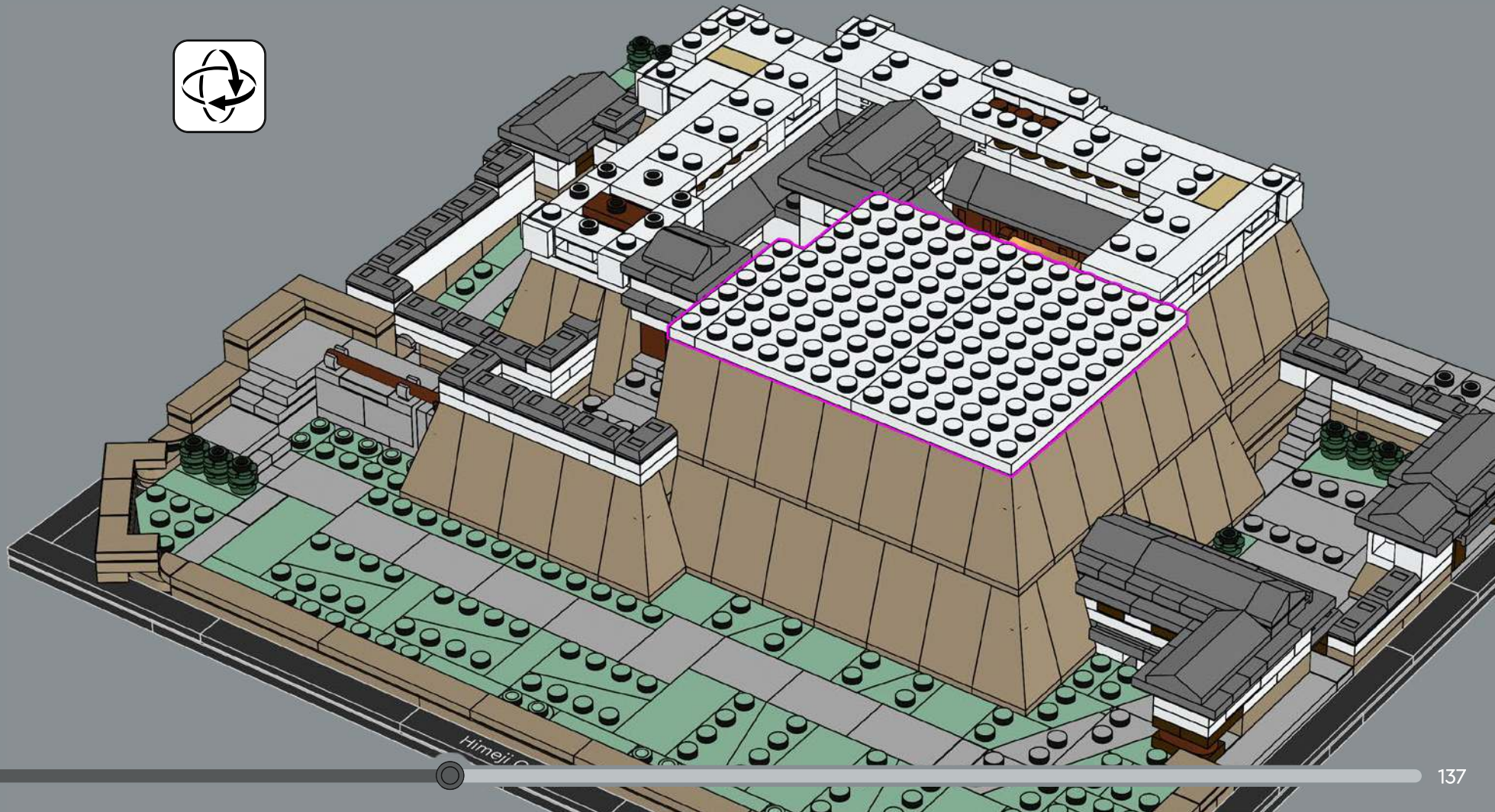

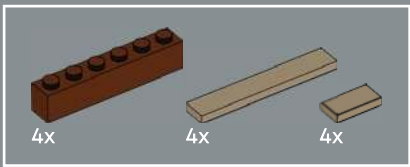

196

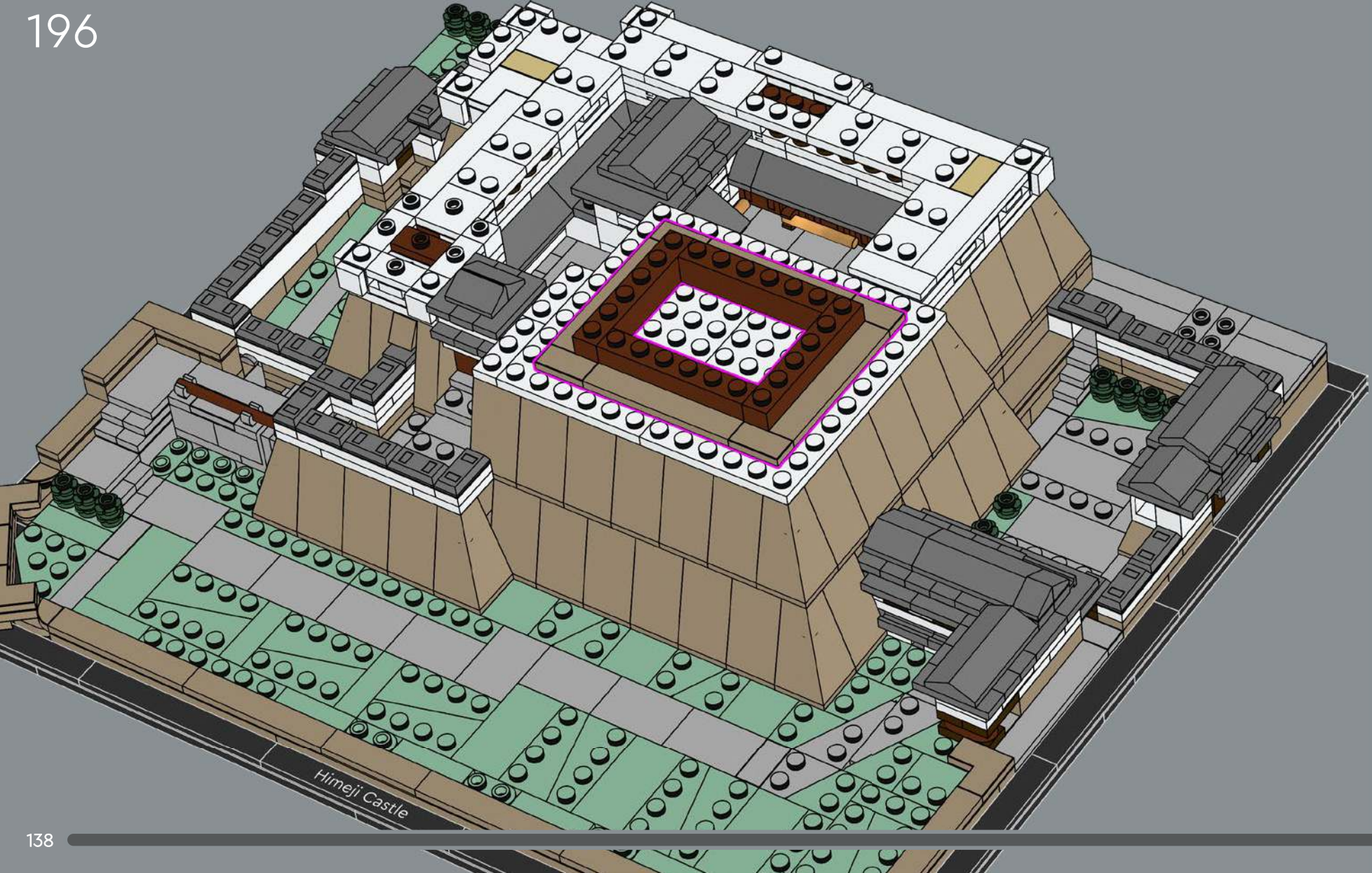

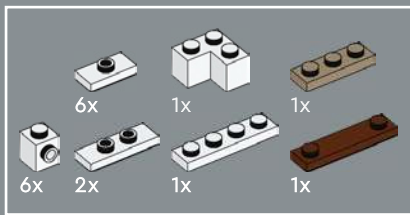

197

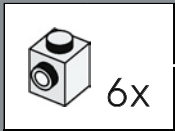
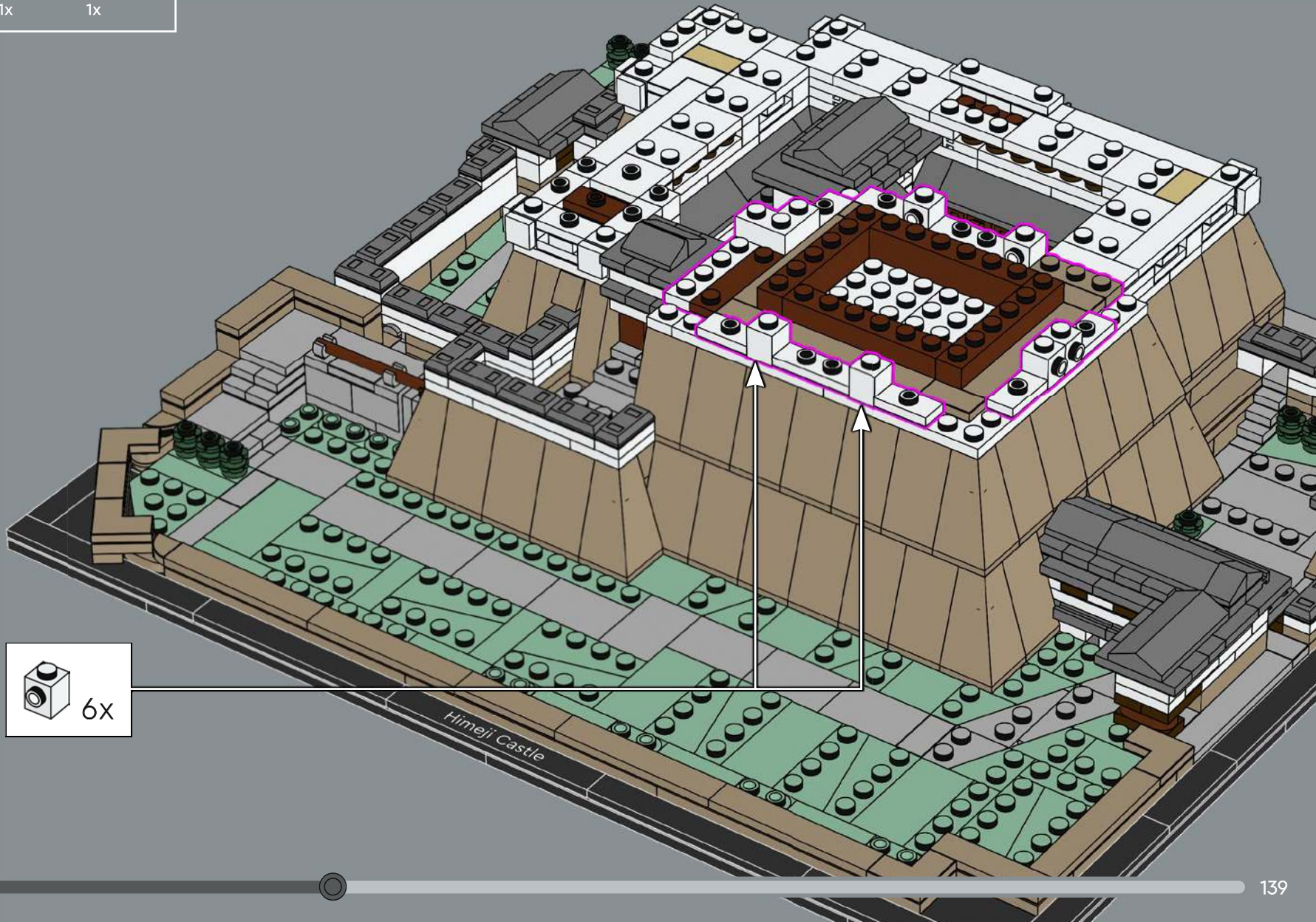

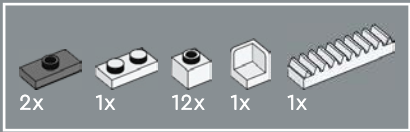

198

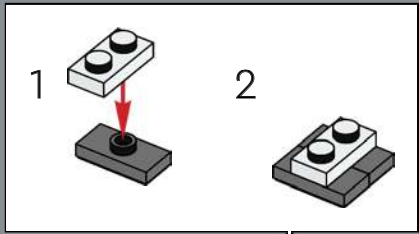

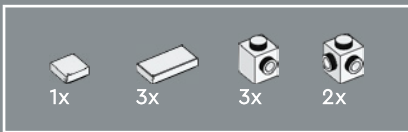

199

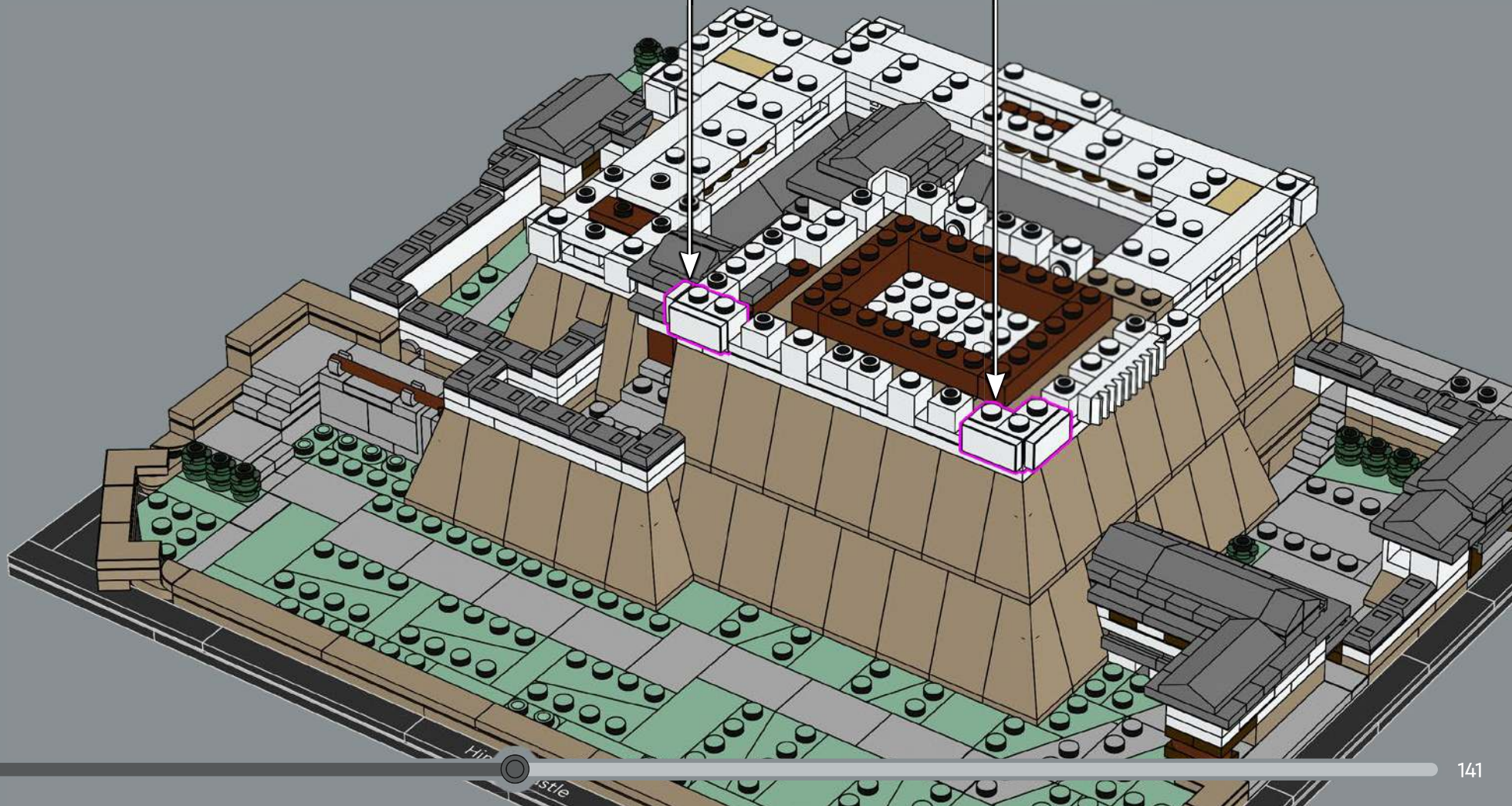
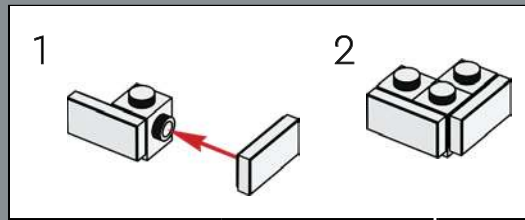
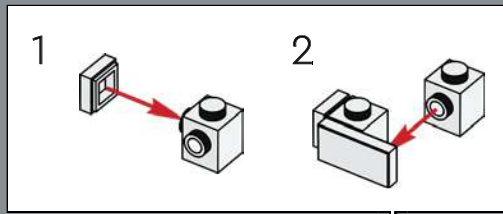

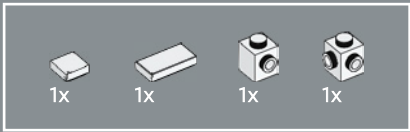

200

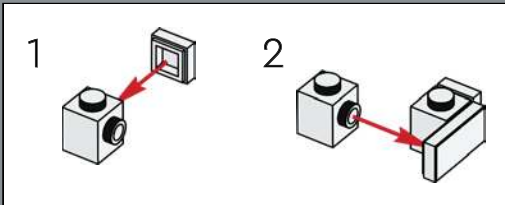

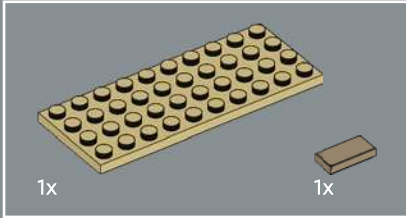
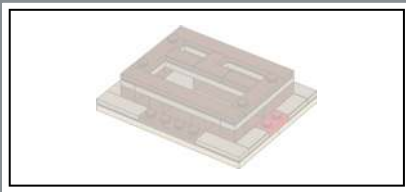

201

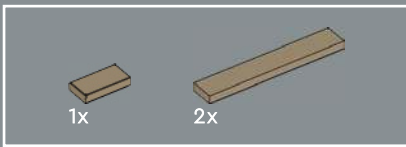
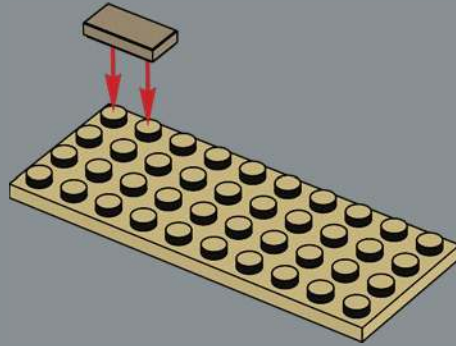

202

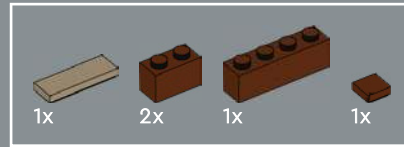
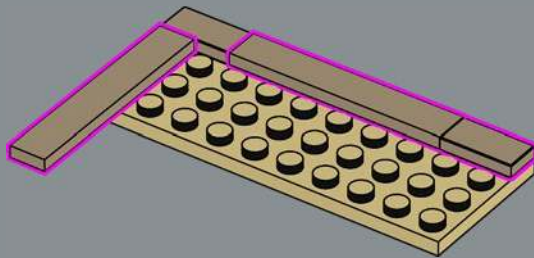

203

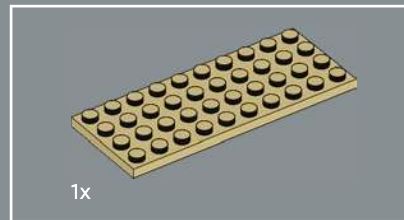
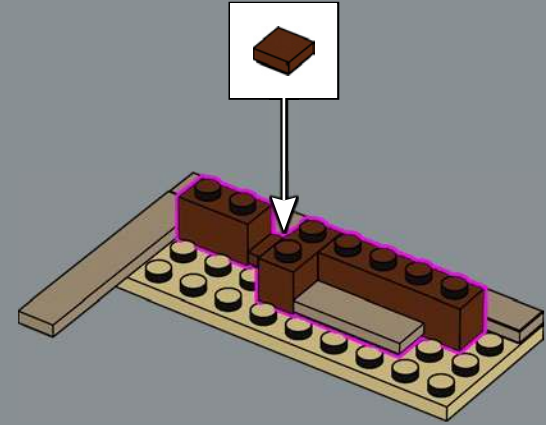

204

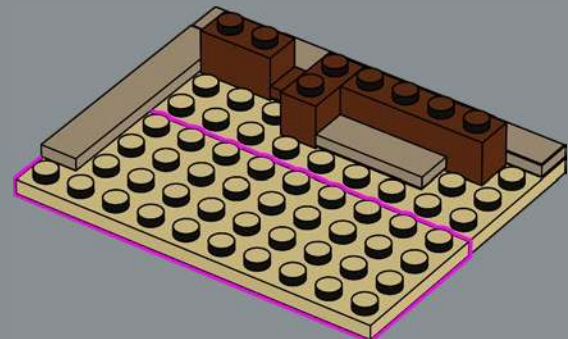

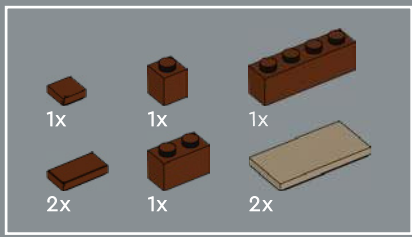

205

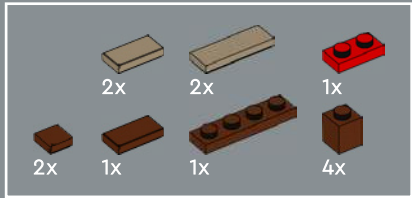
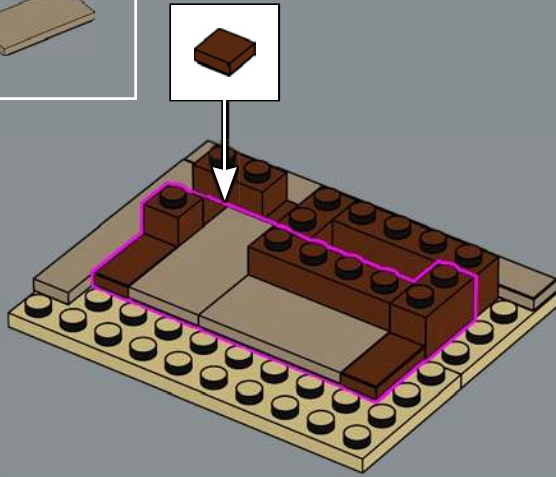

206

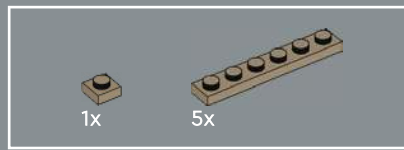
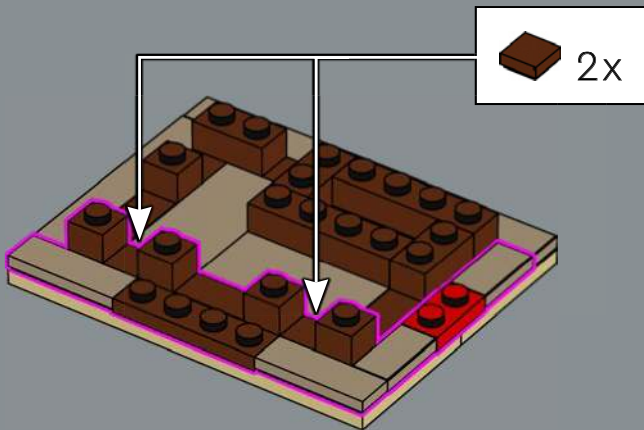

207

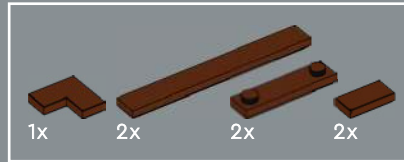
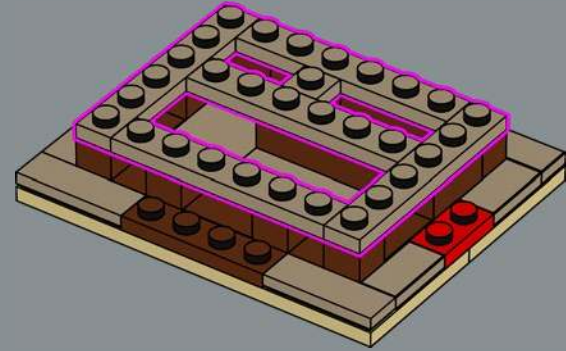

208

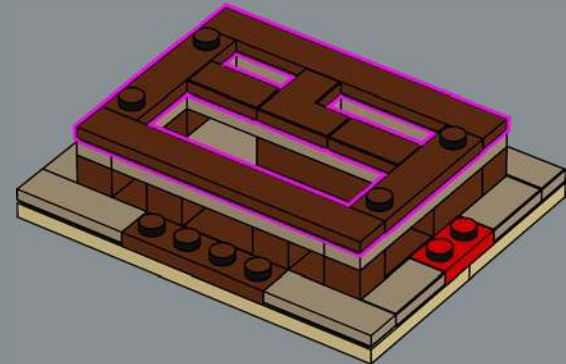

209

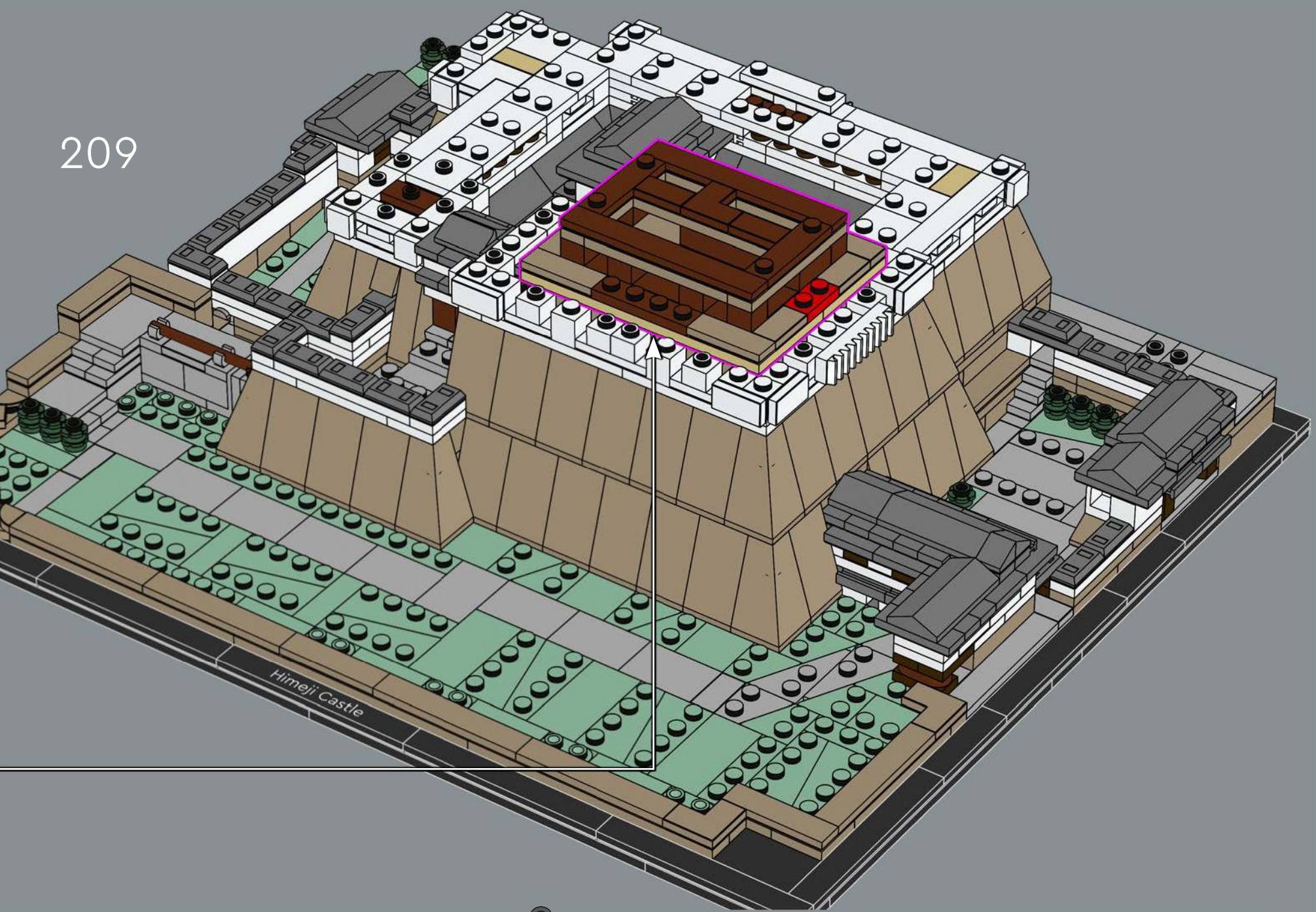

Himeji Castle

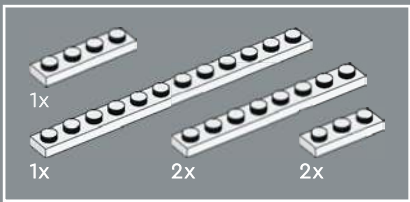

210

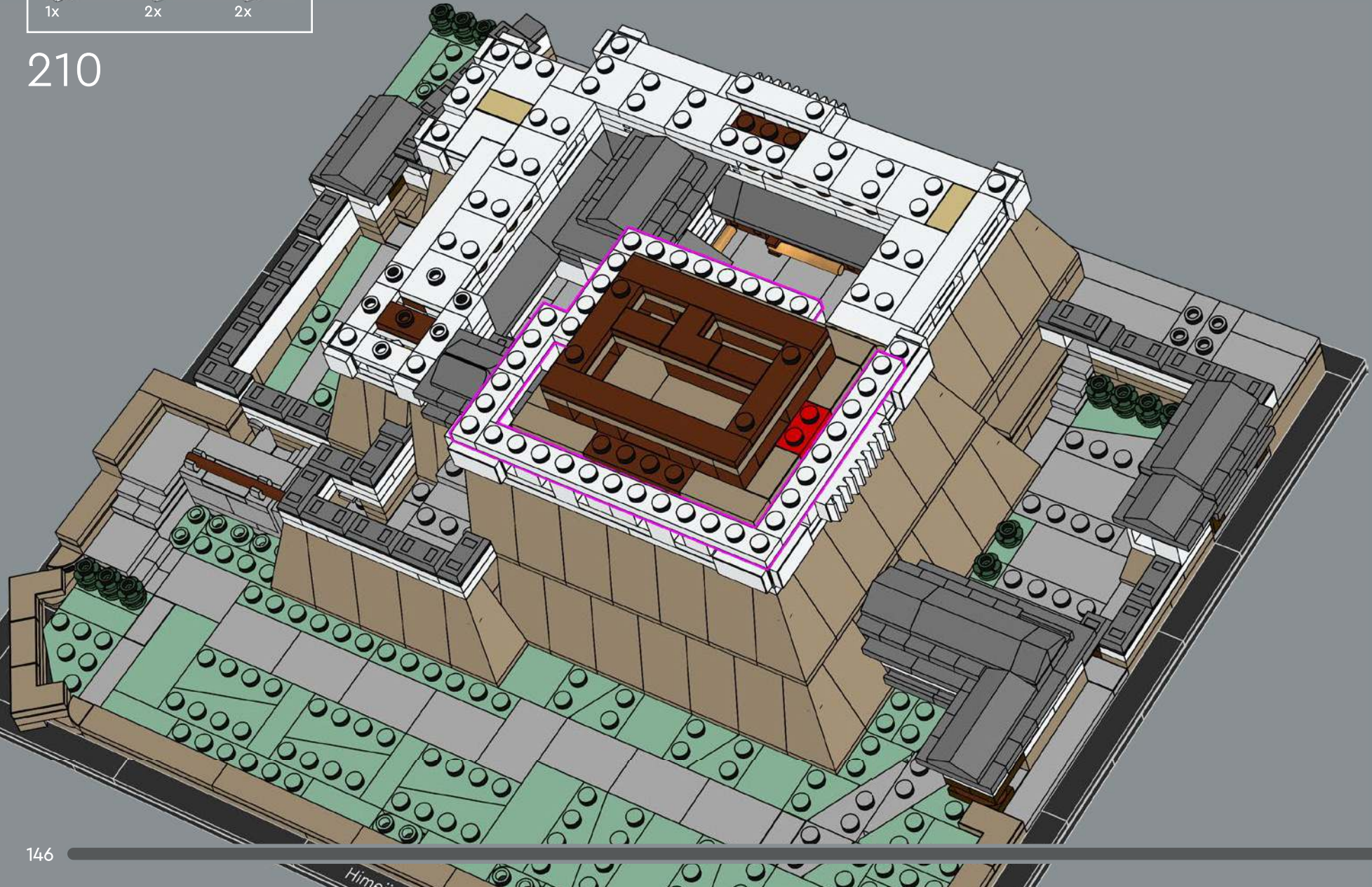

Though we had to adhere to 90-degree or other manageable angles for this set, we have kept some of the asymmetrical lines to honour the original castle.

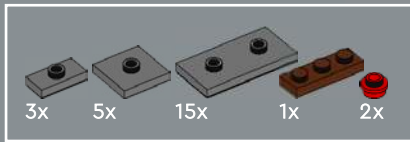

211

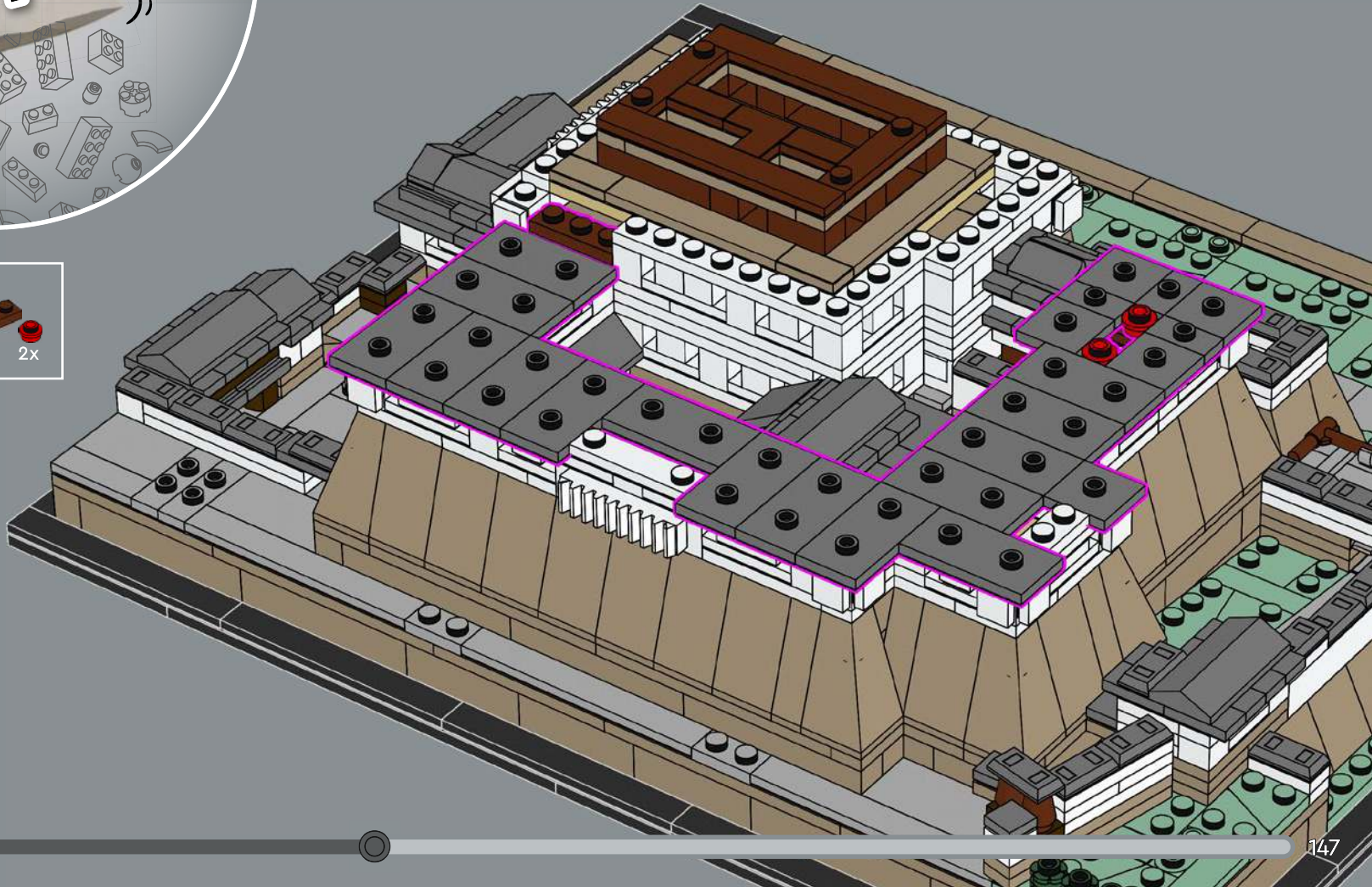

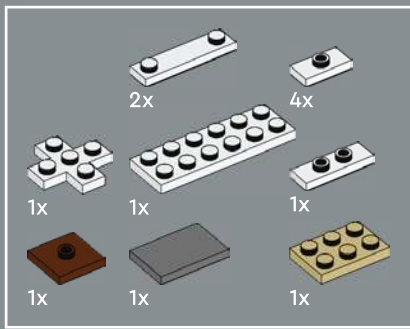

212

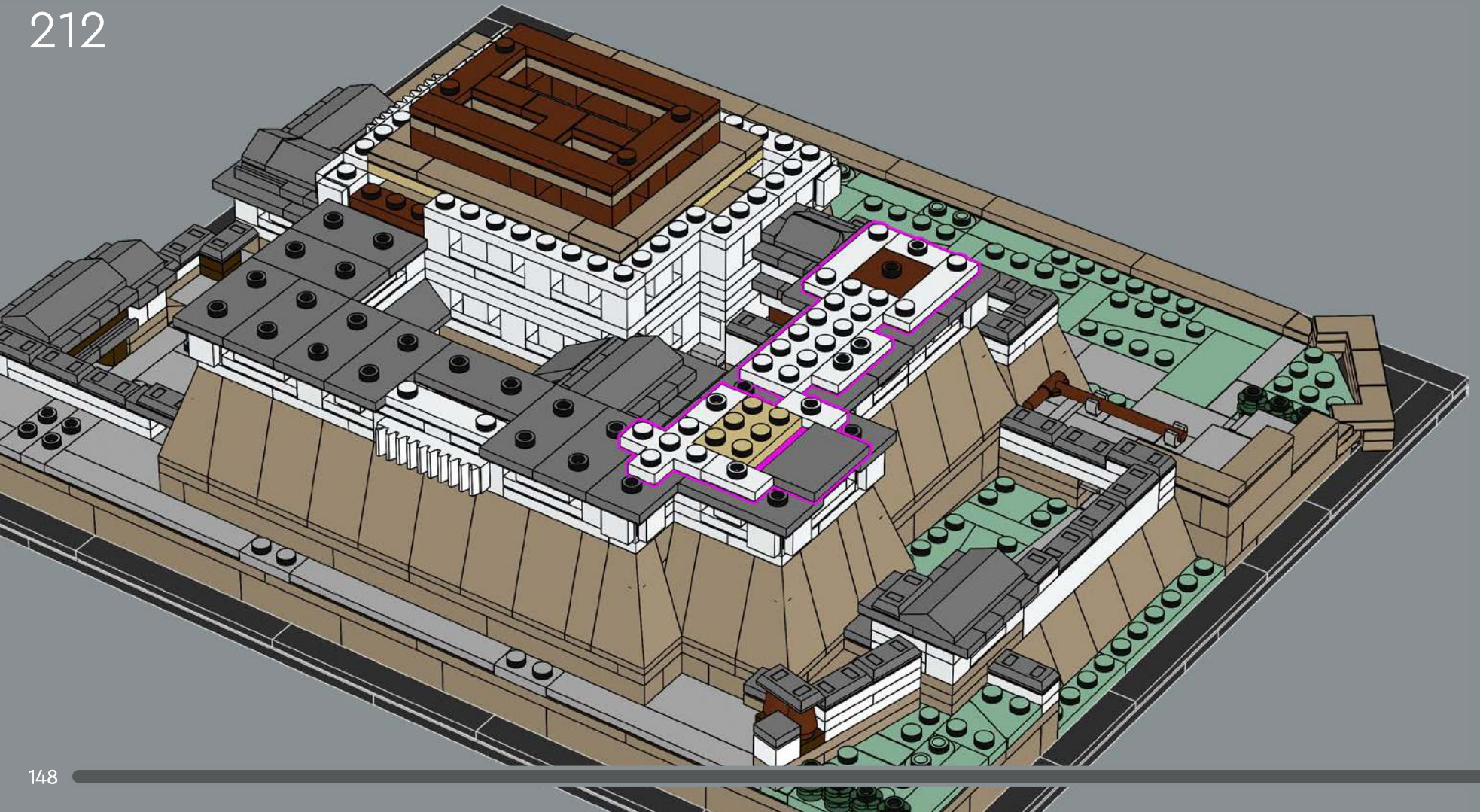

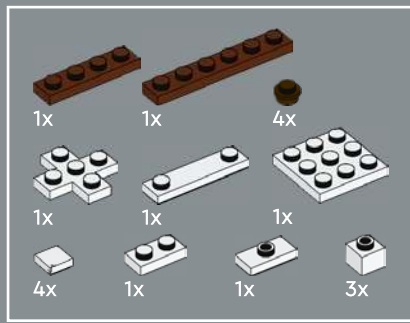

213

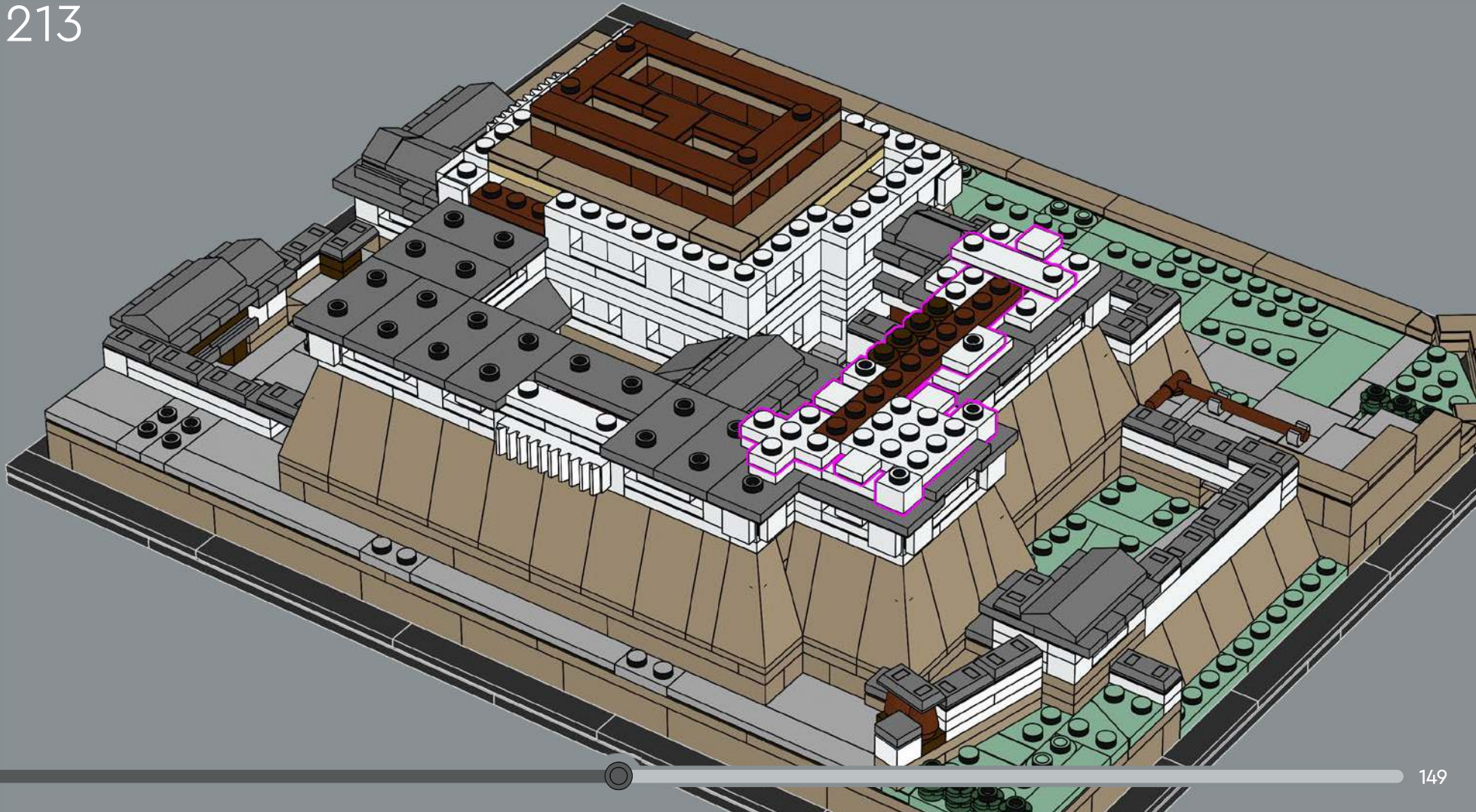

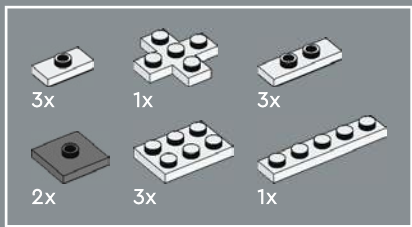

214

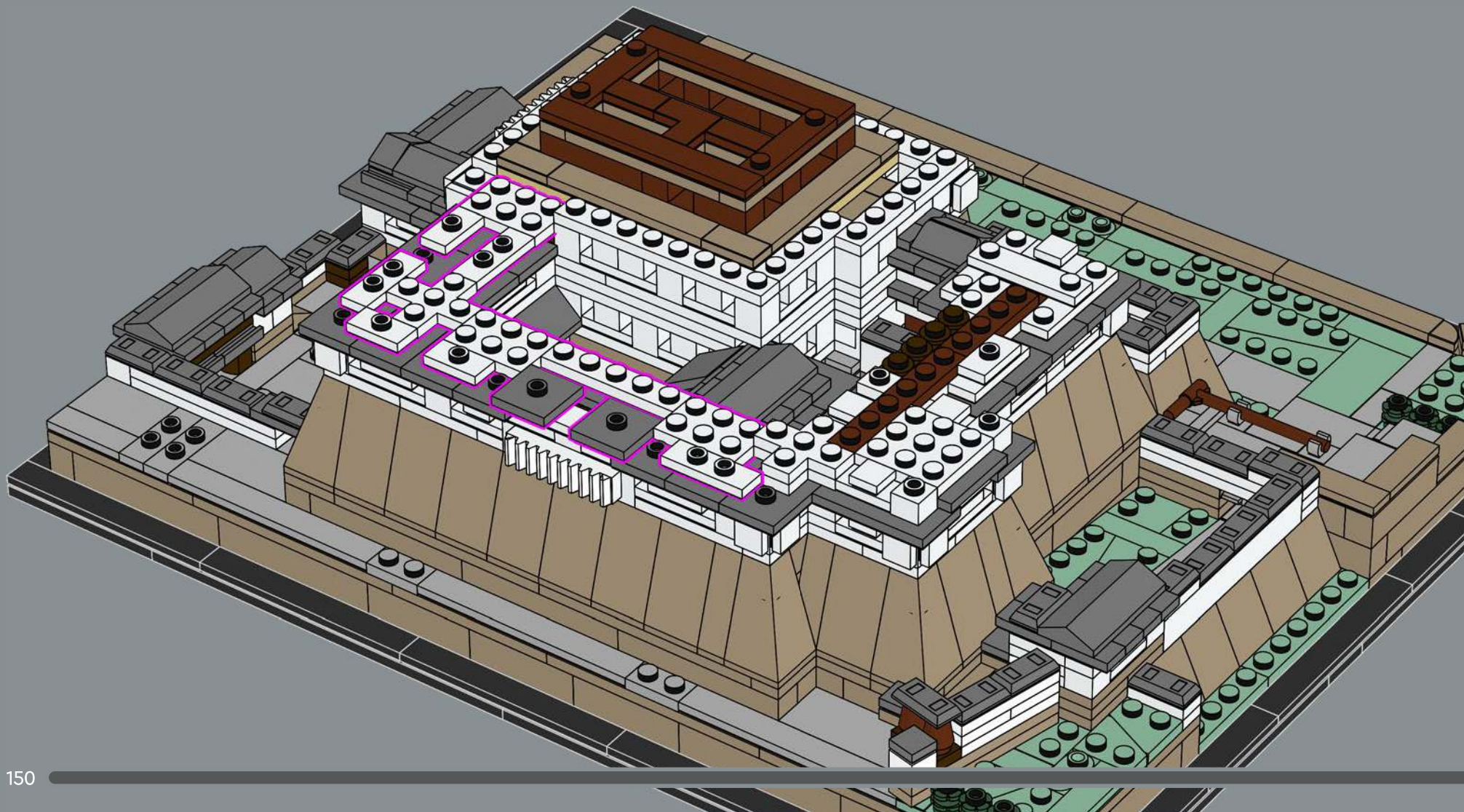

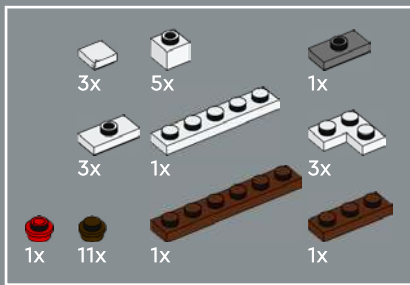

215

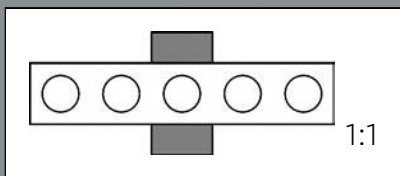
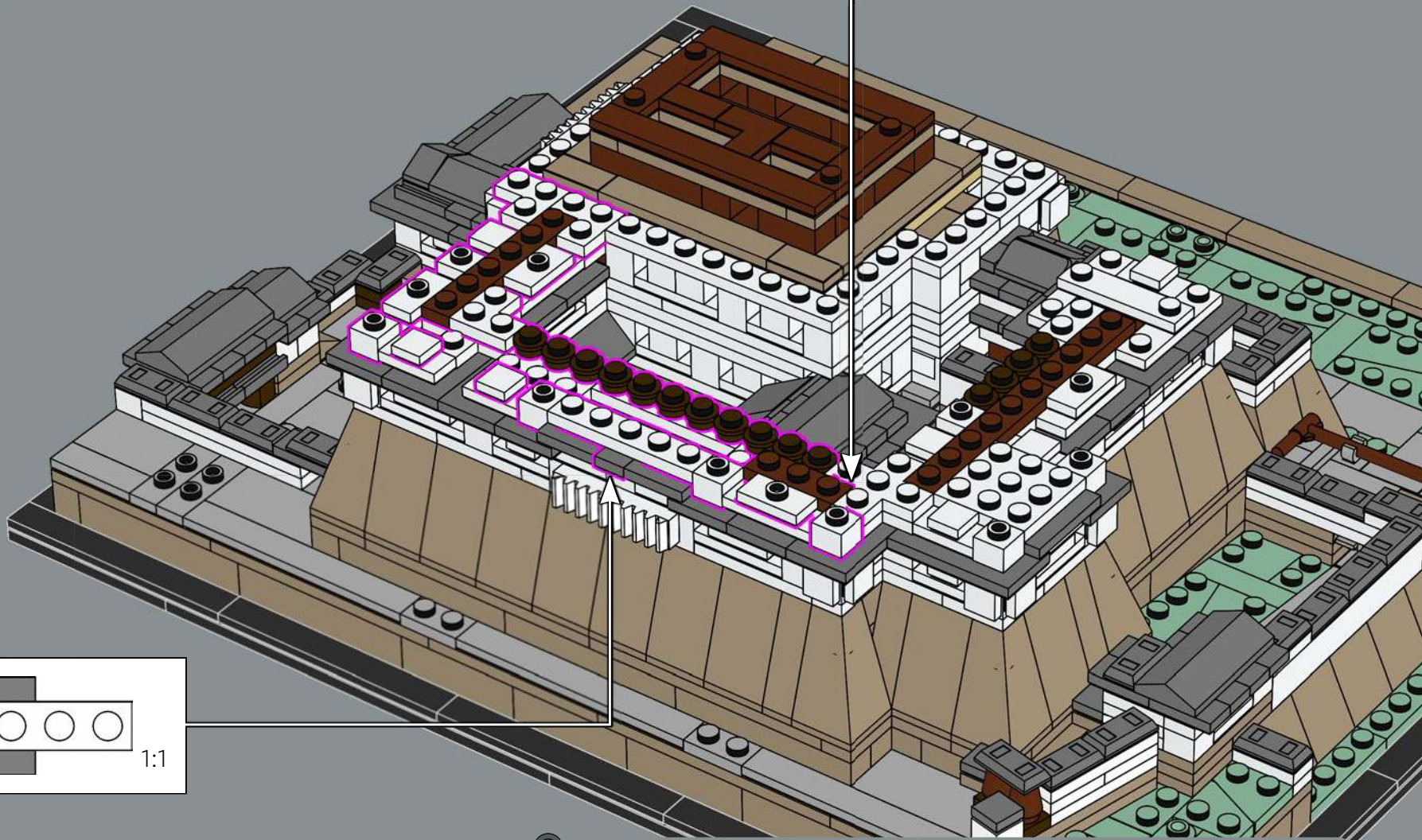
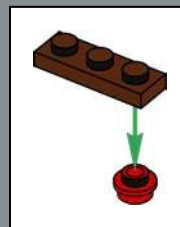

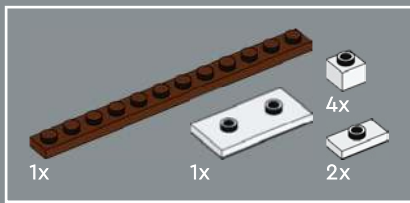

216

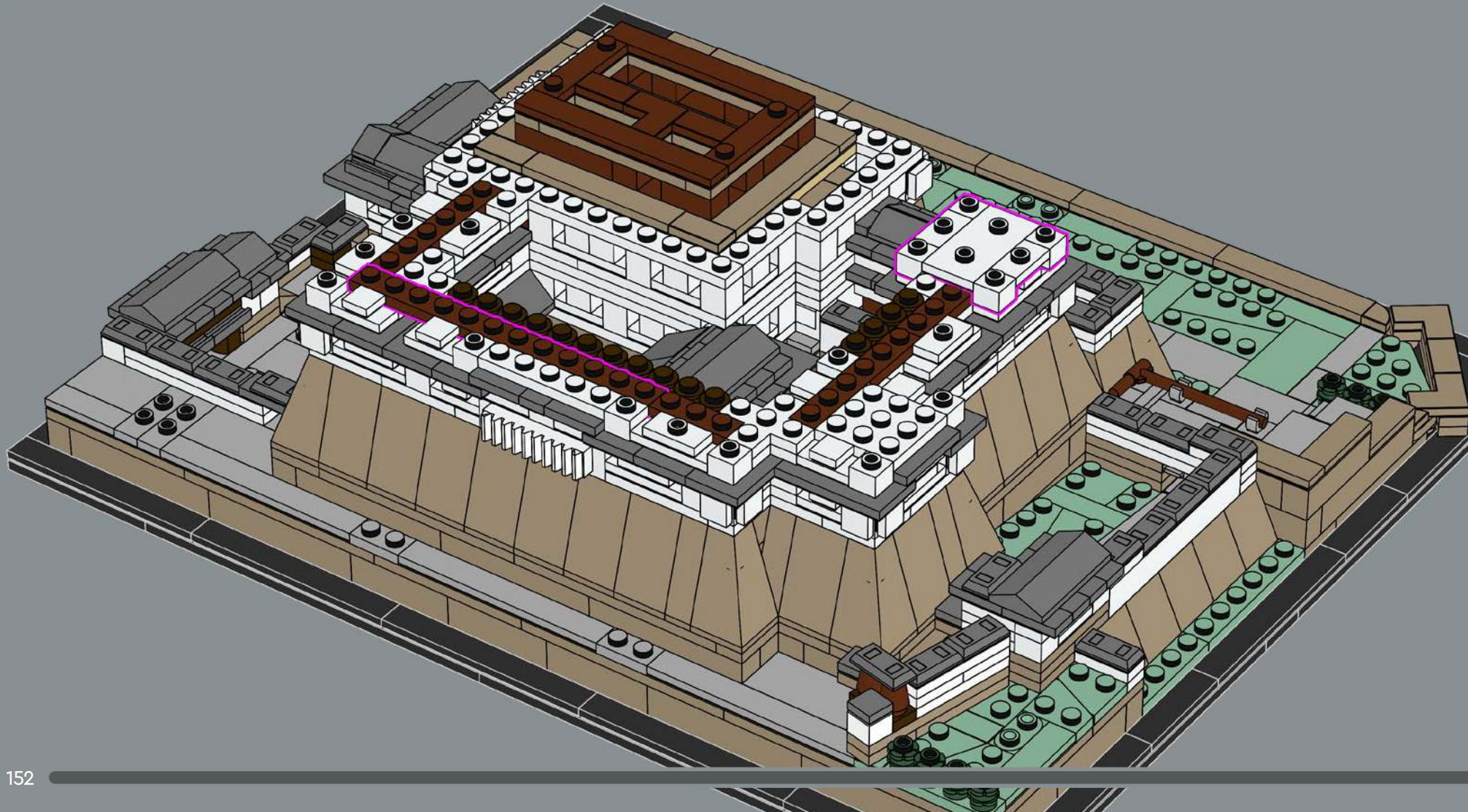

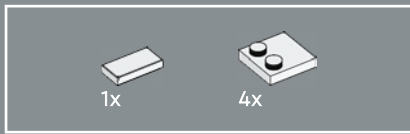

217

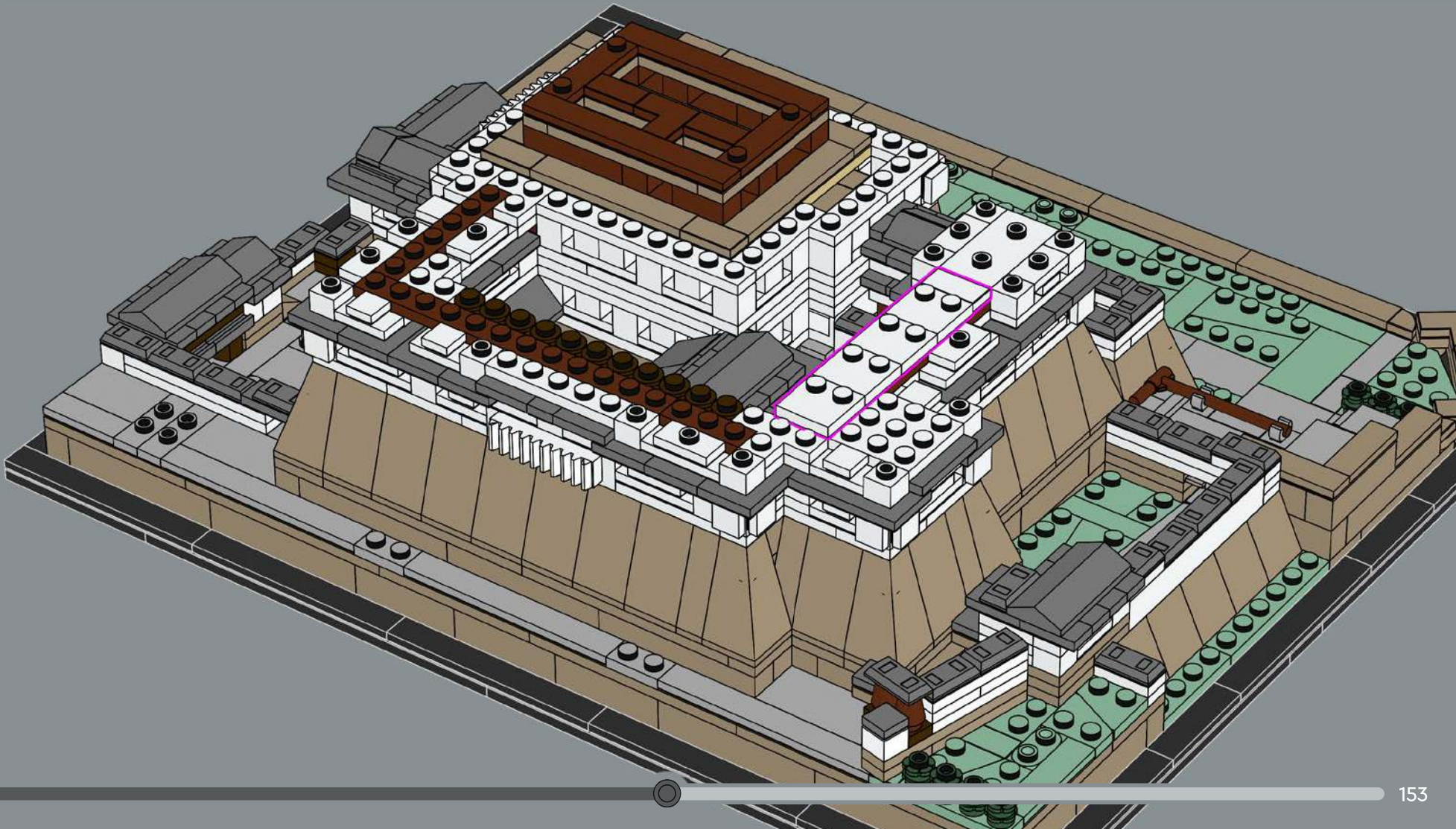

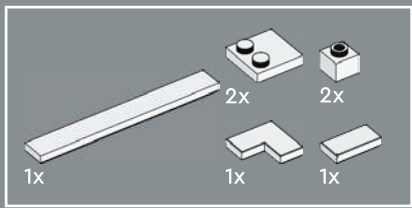

218

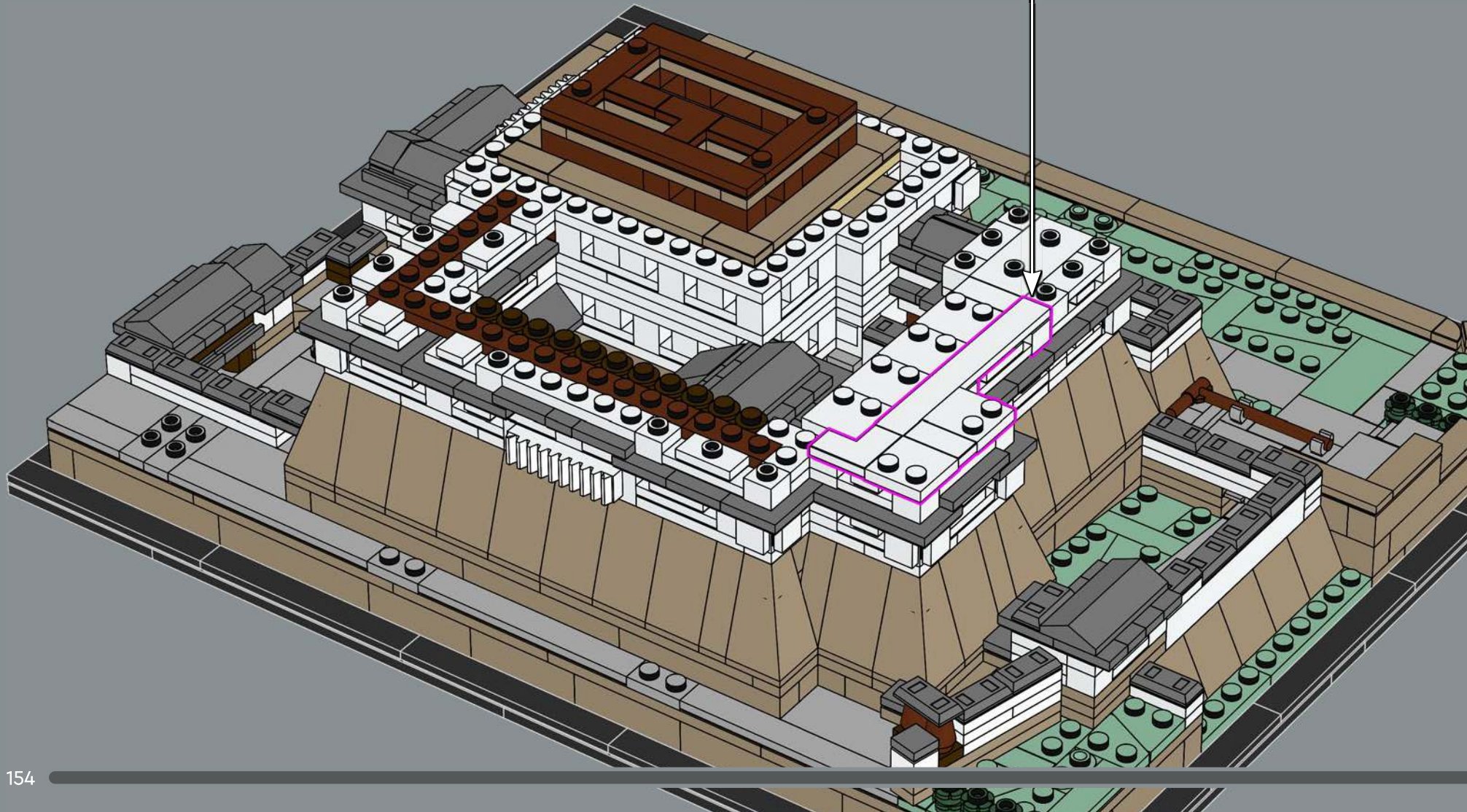
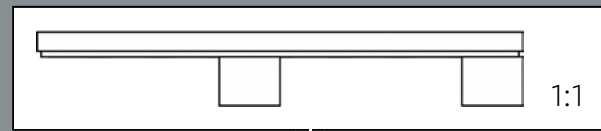

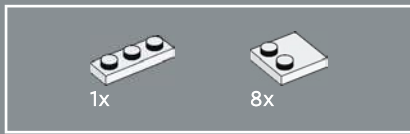

219

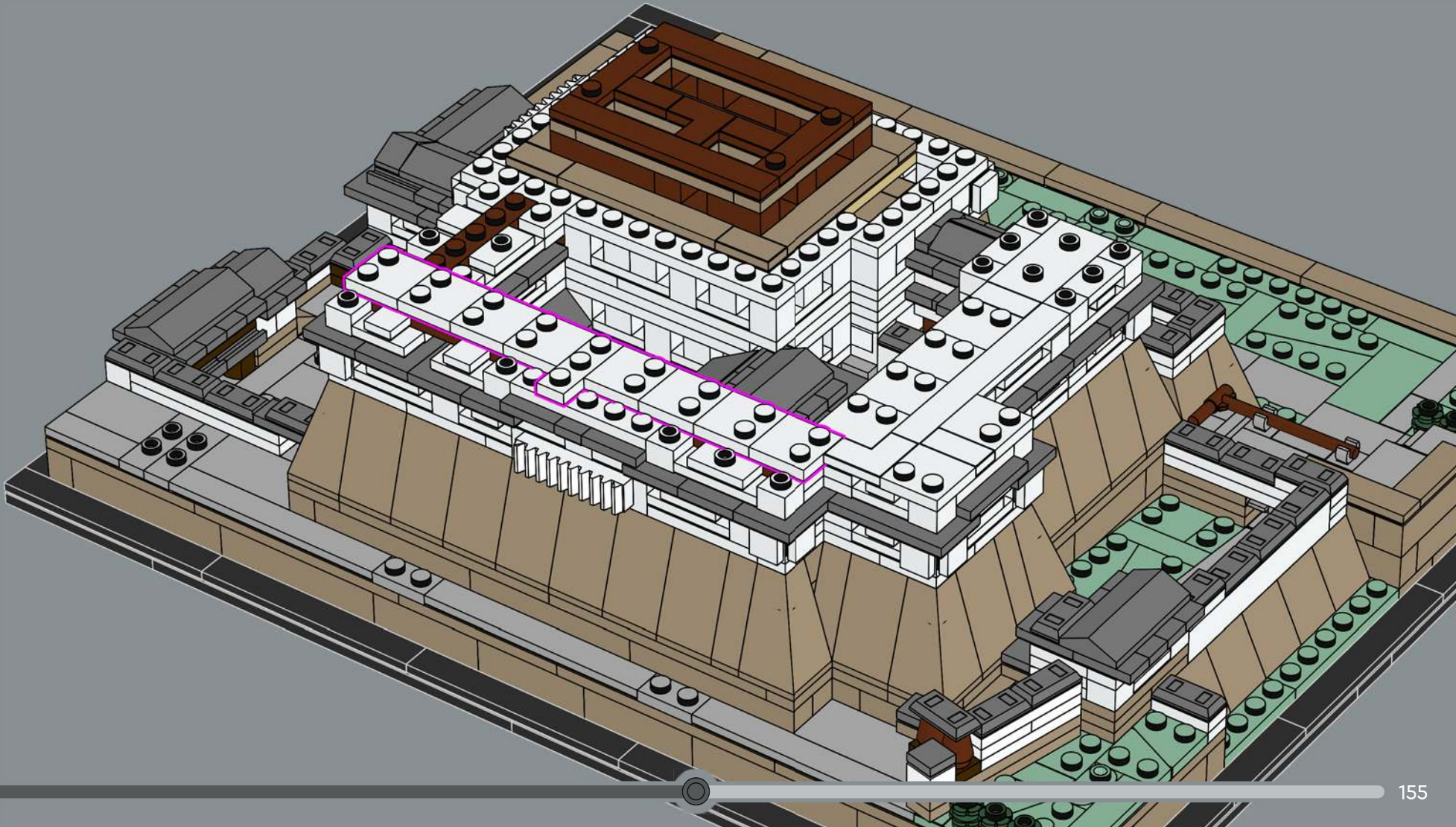

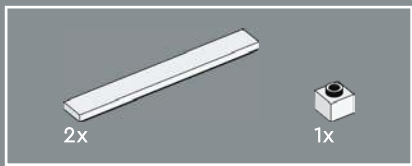

220

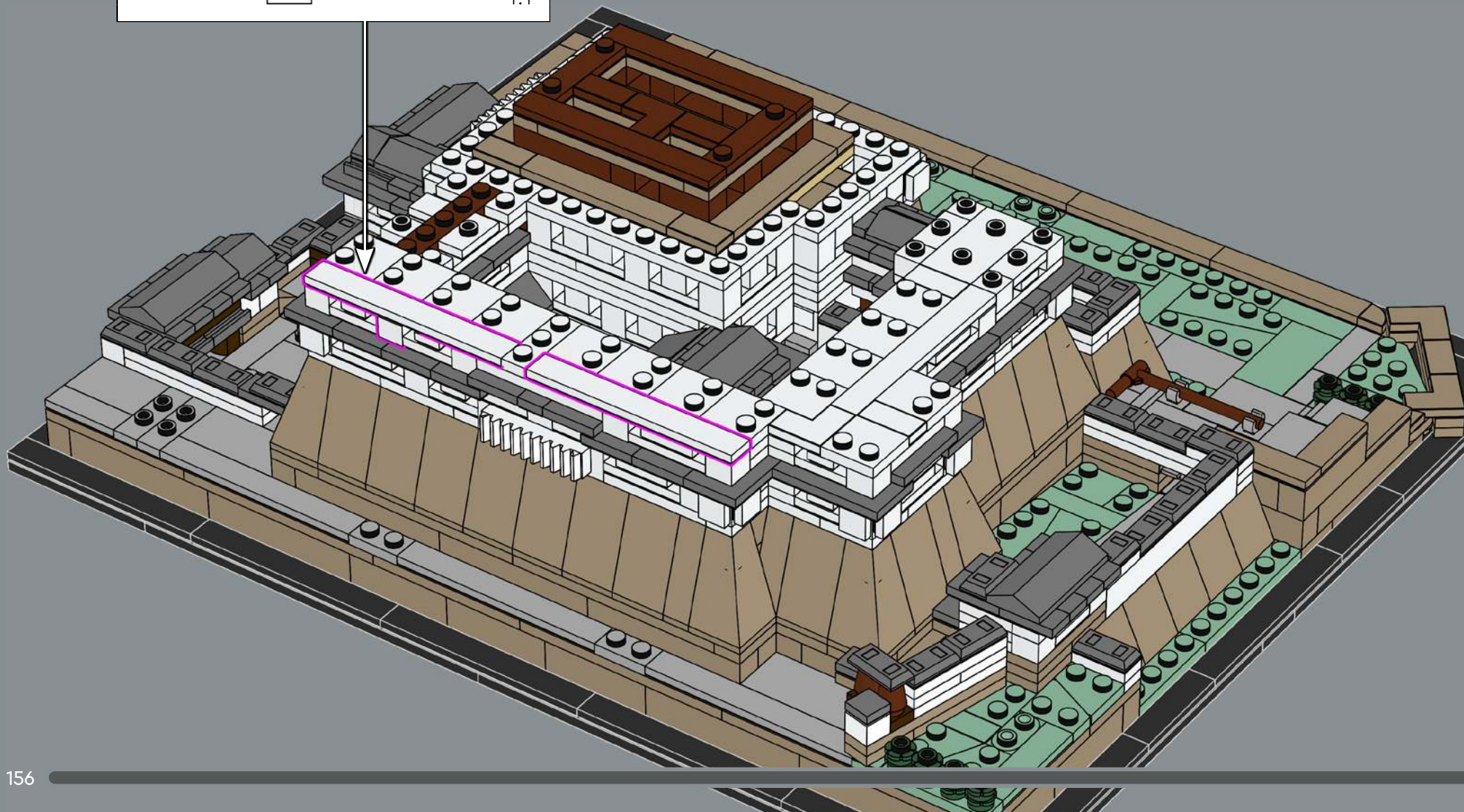
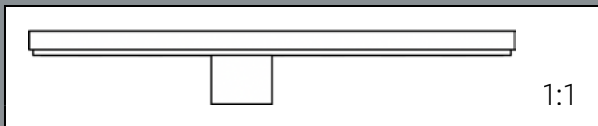

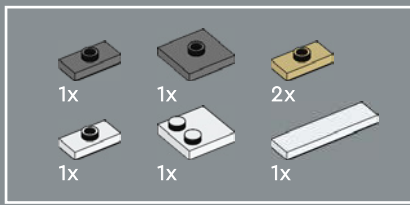

221

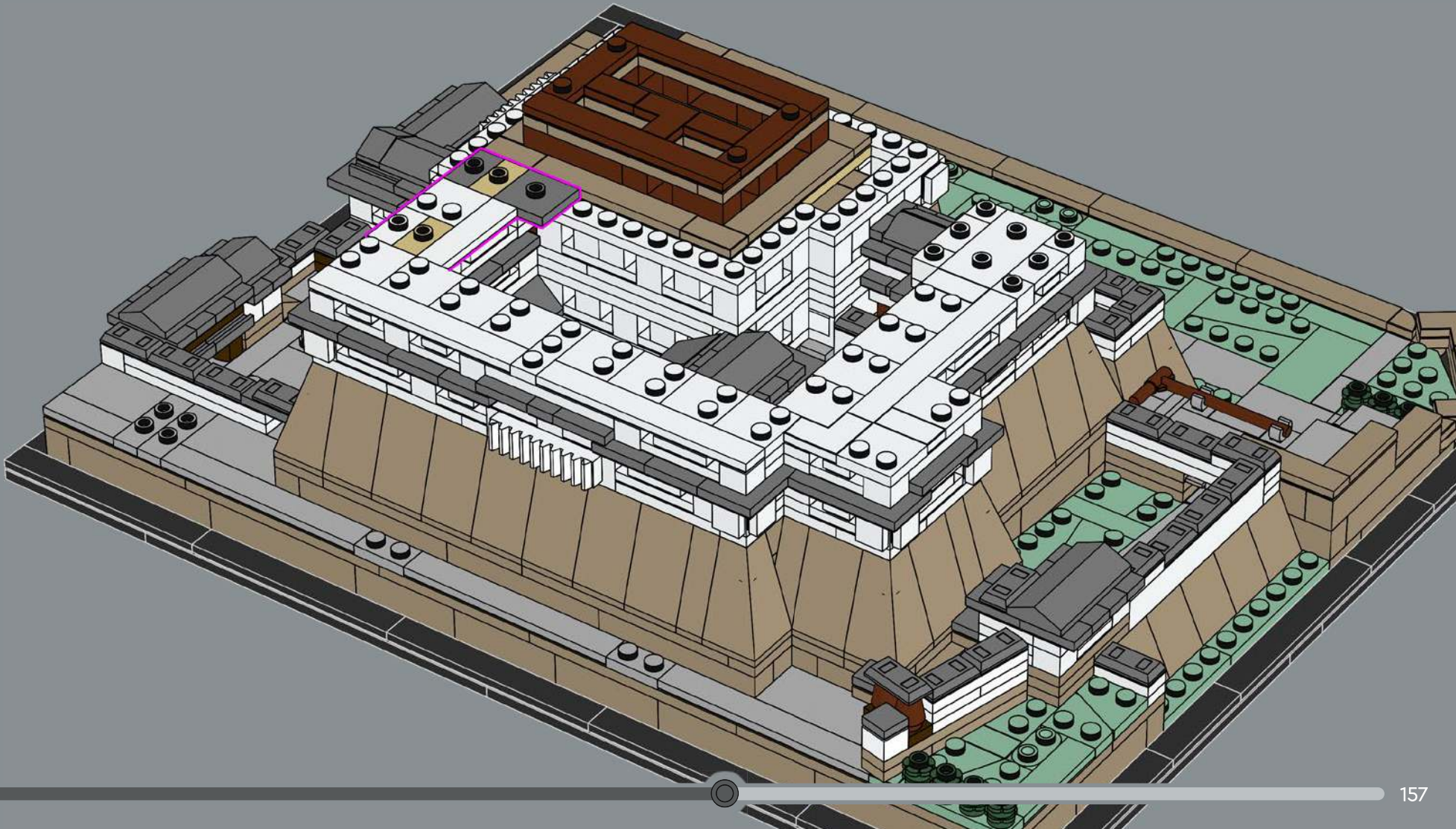

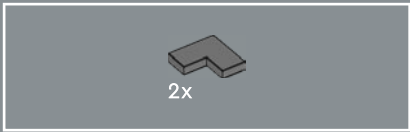

222

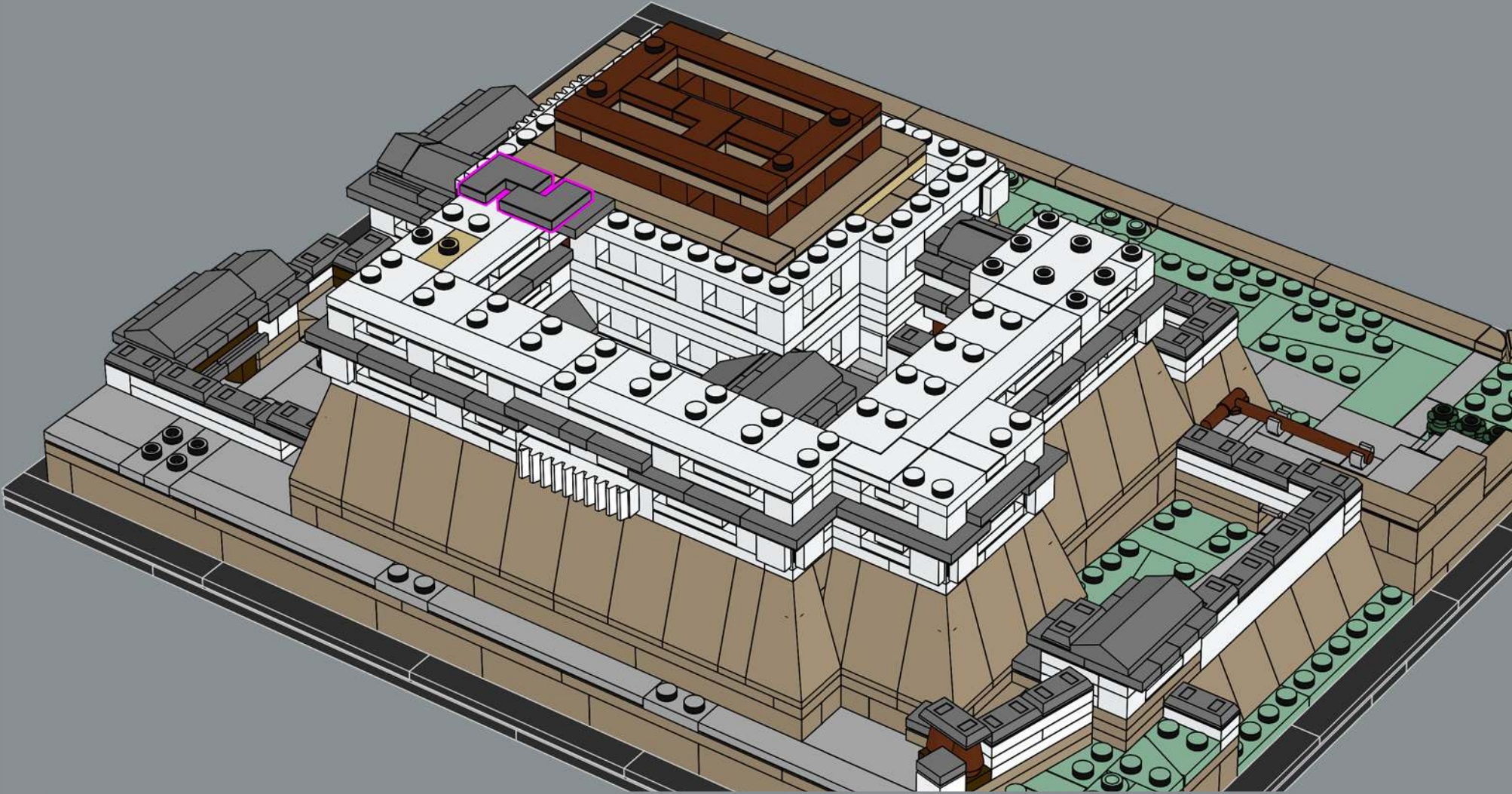

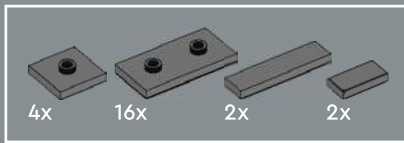

223

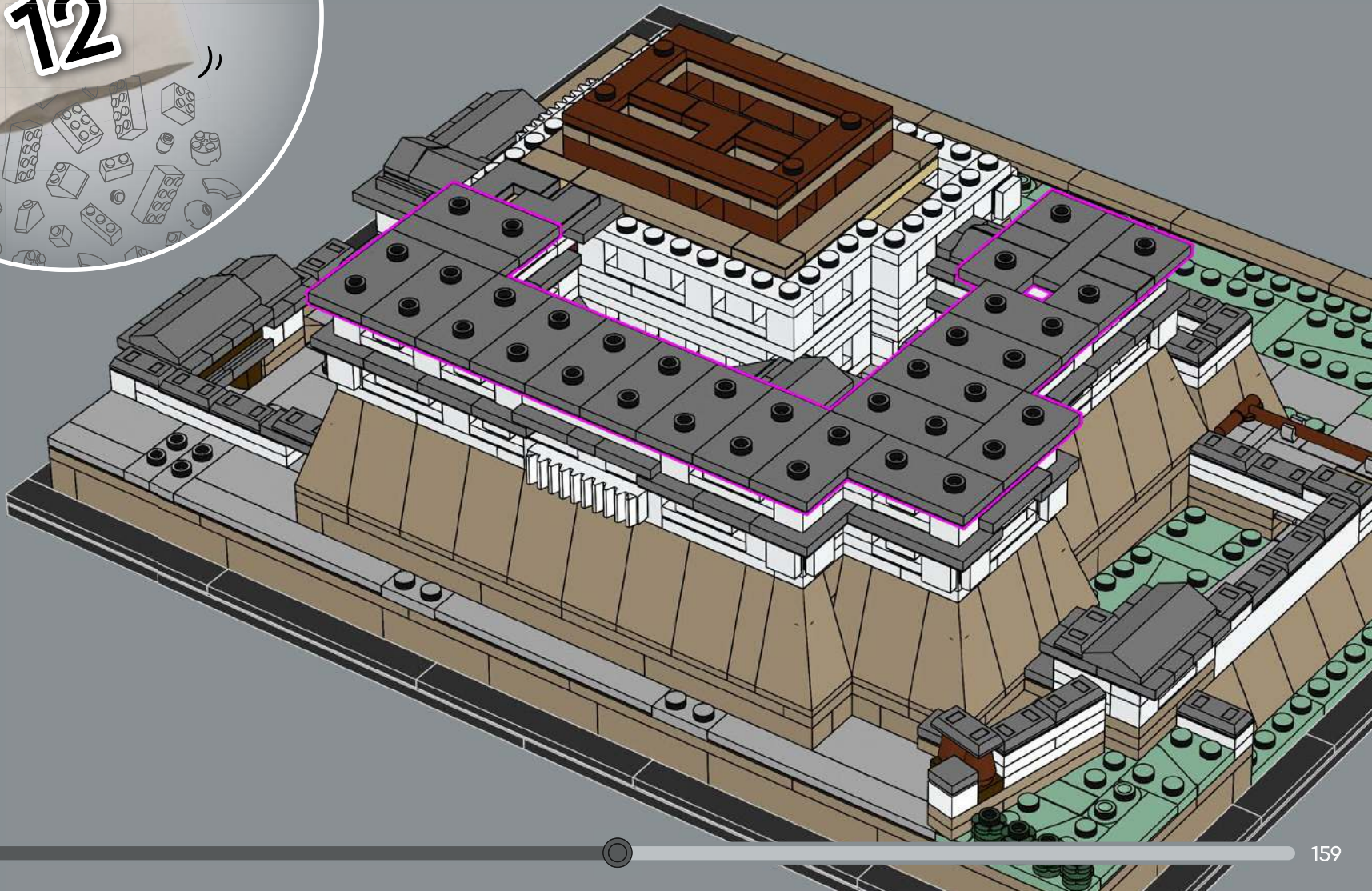

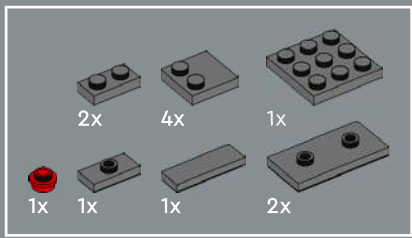

224

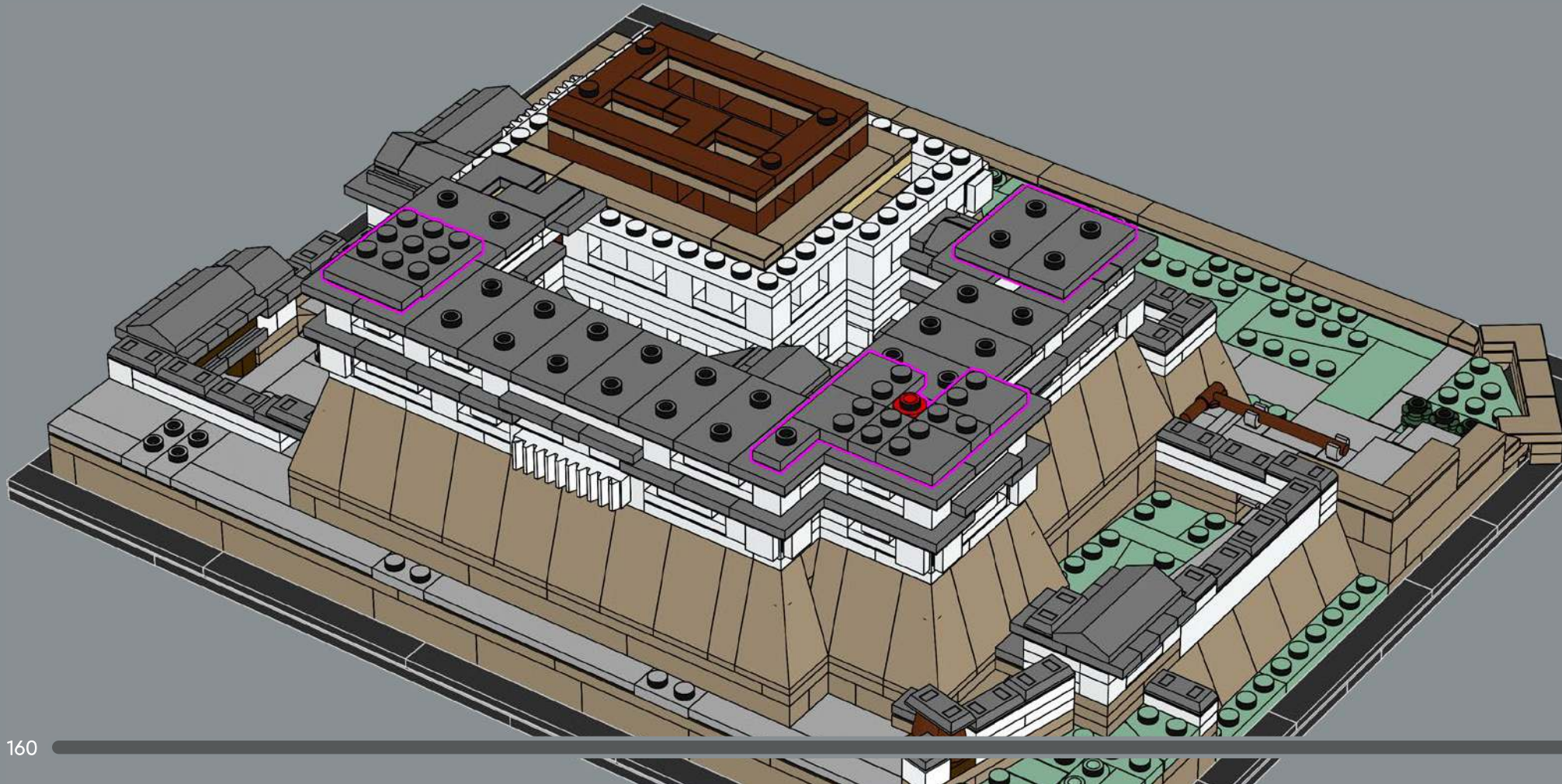

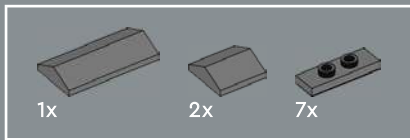

225

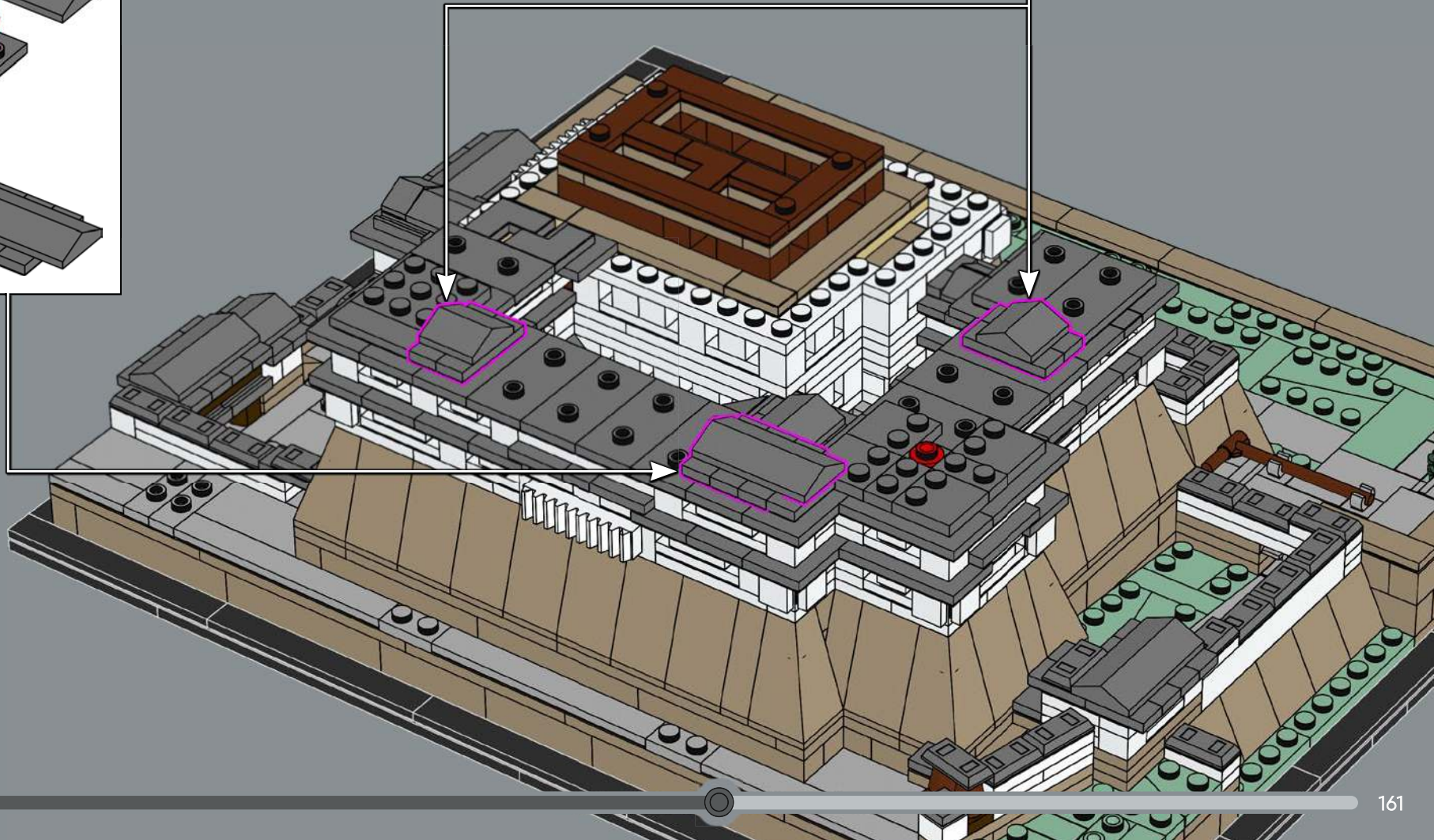
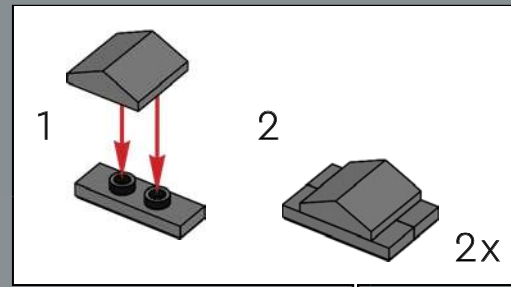
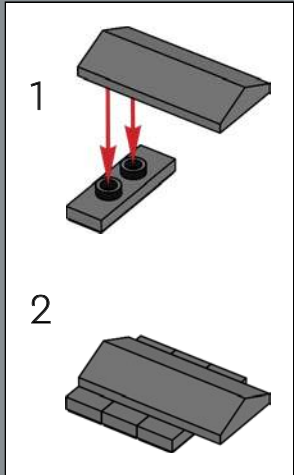

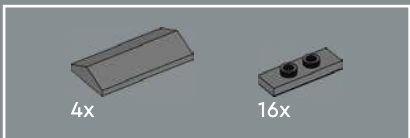

226

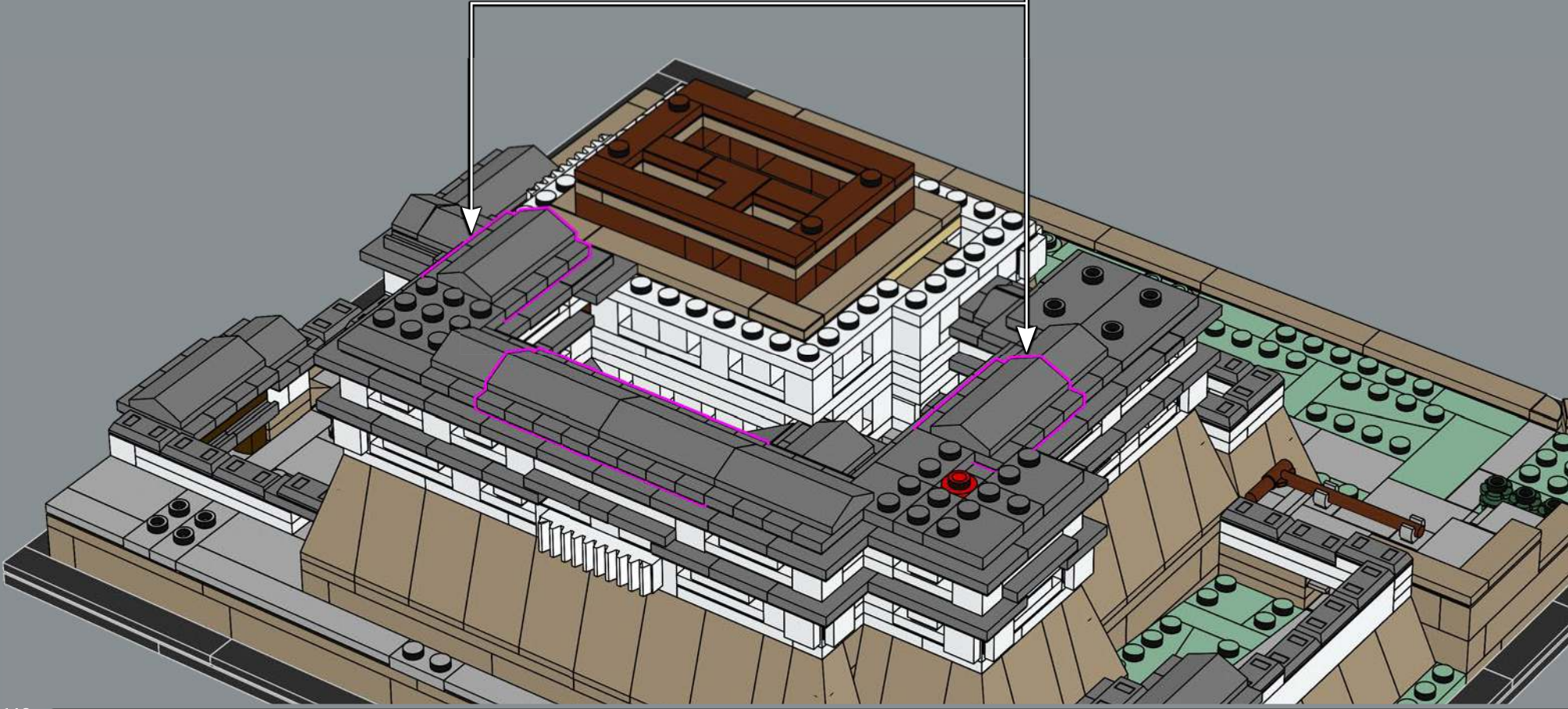
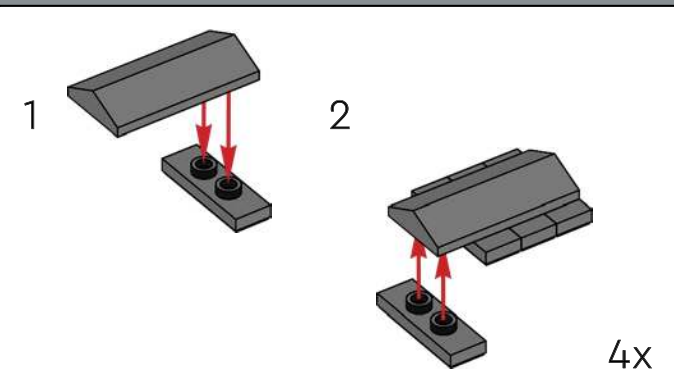

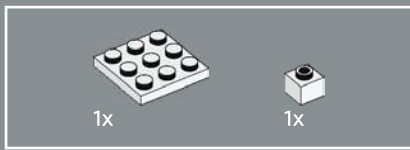

227

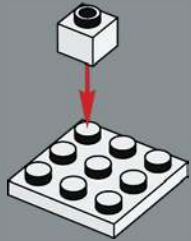

228

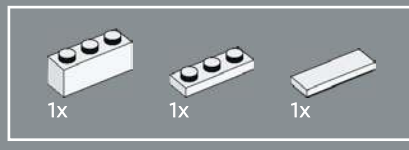
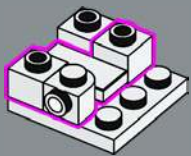

229

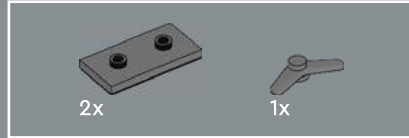
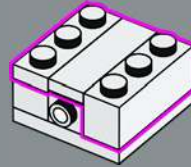

230

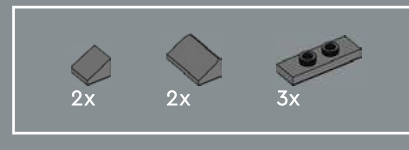
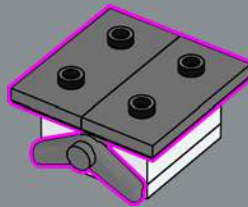

231

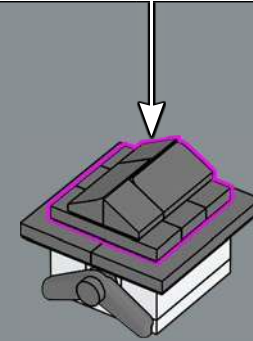
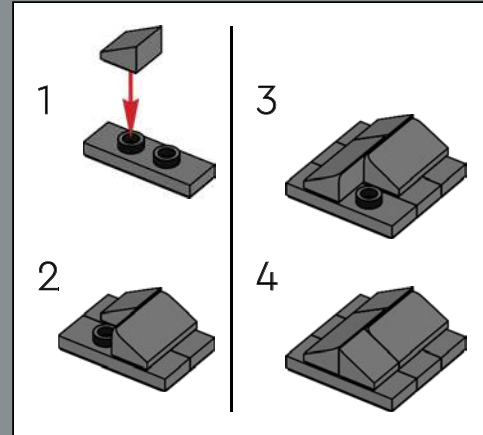

After years of exposure, the white clay on the roof starts to get dirty, slowly changing the appearance and colour of the roof.

232

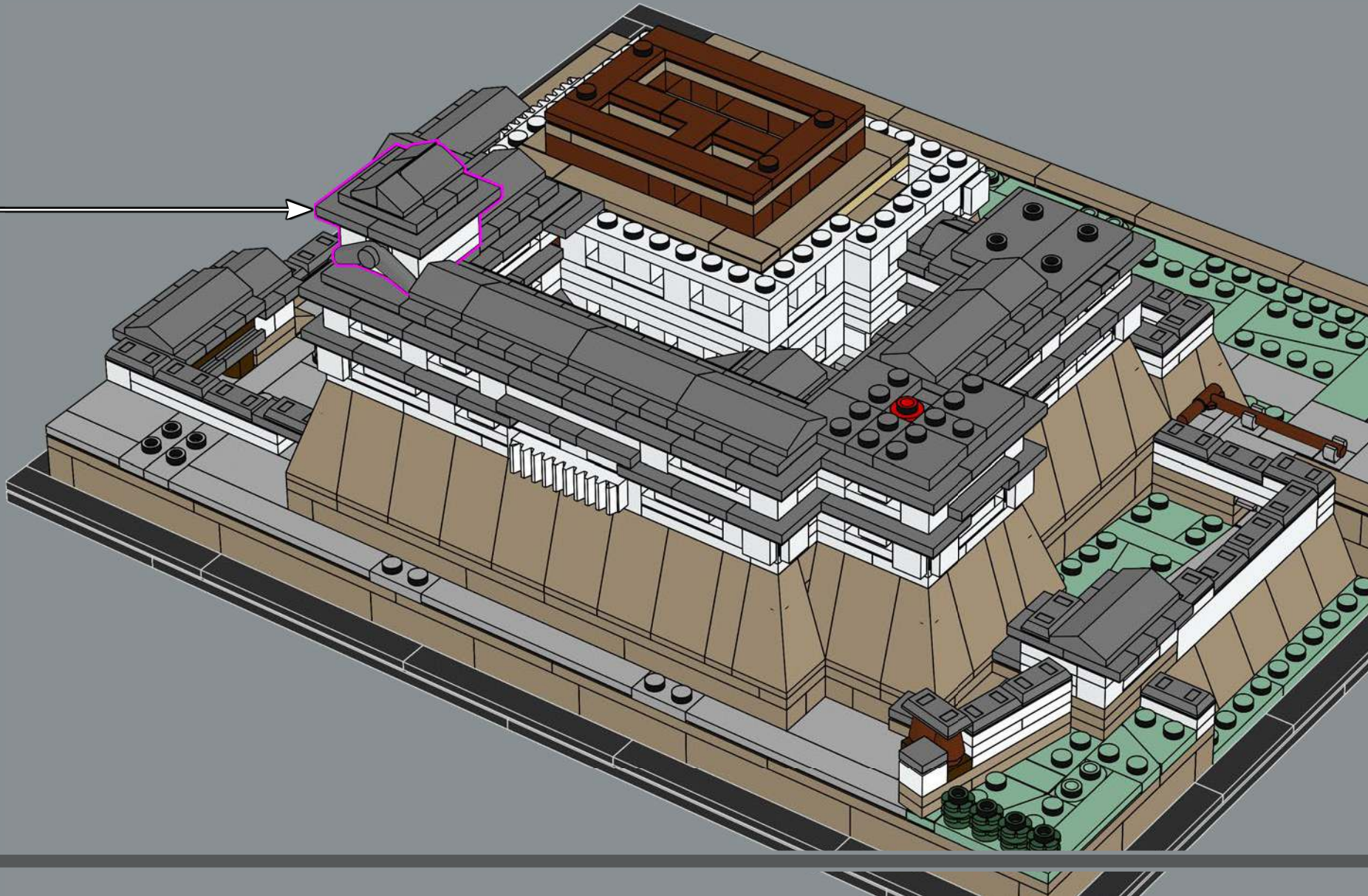

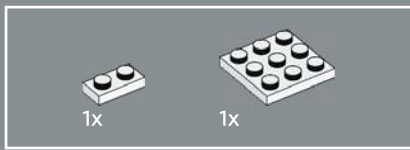

233

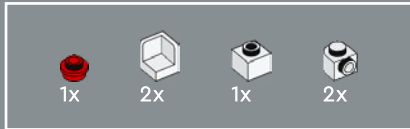
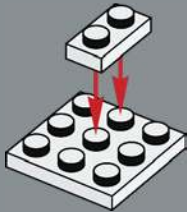

234

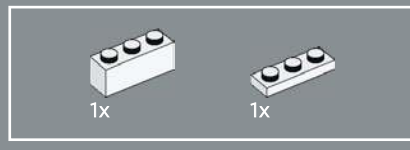
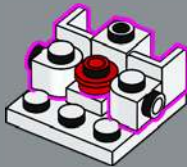

235

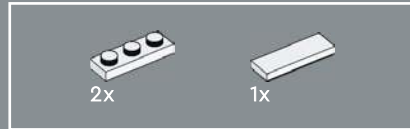

236

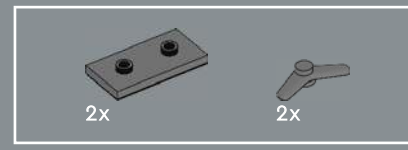
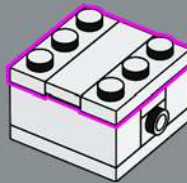

237

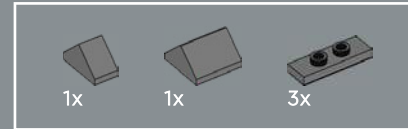
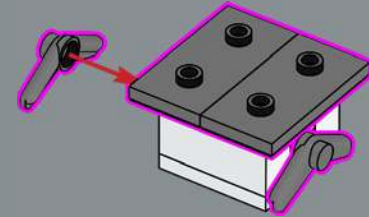

238

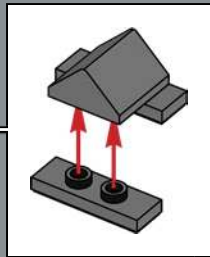
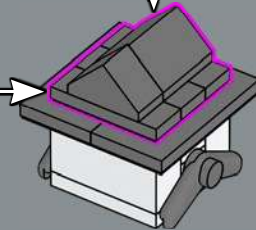
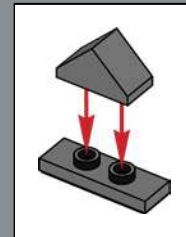

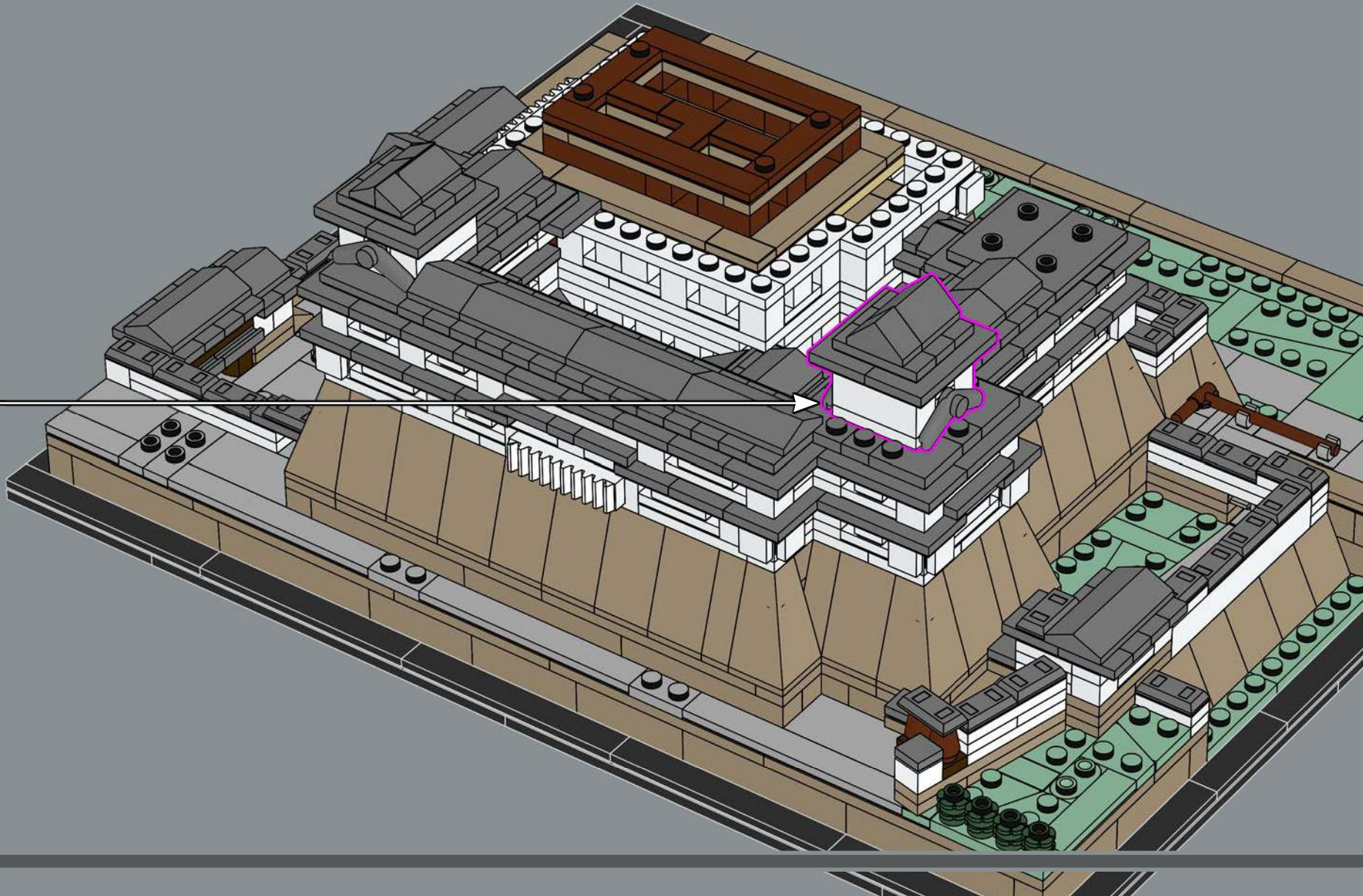



240

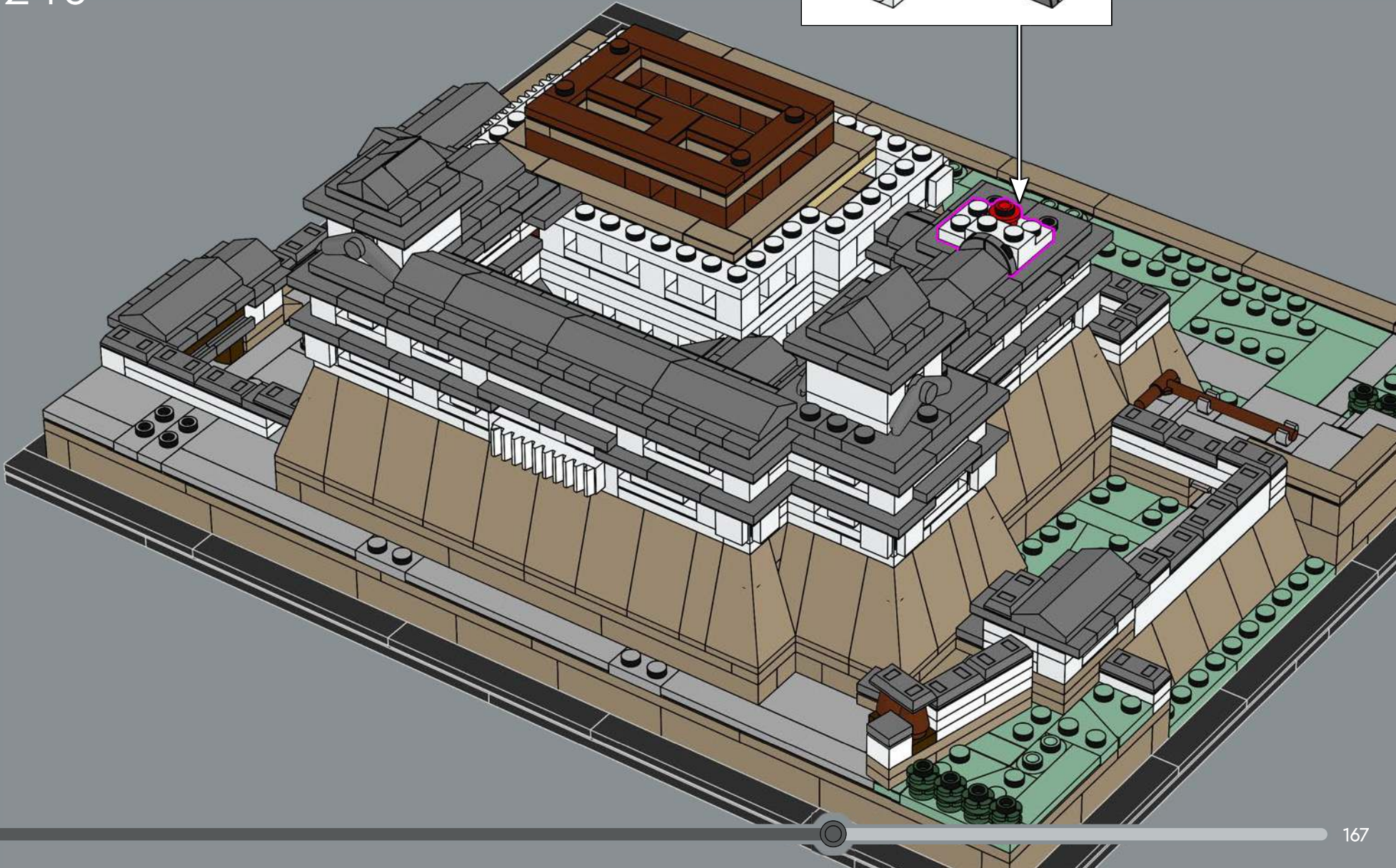
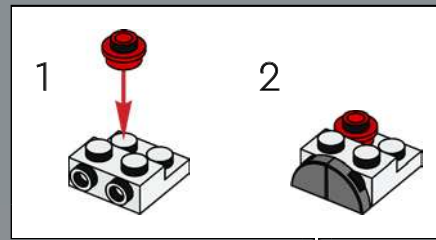

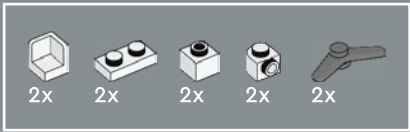

241

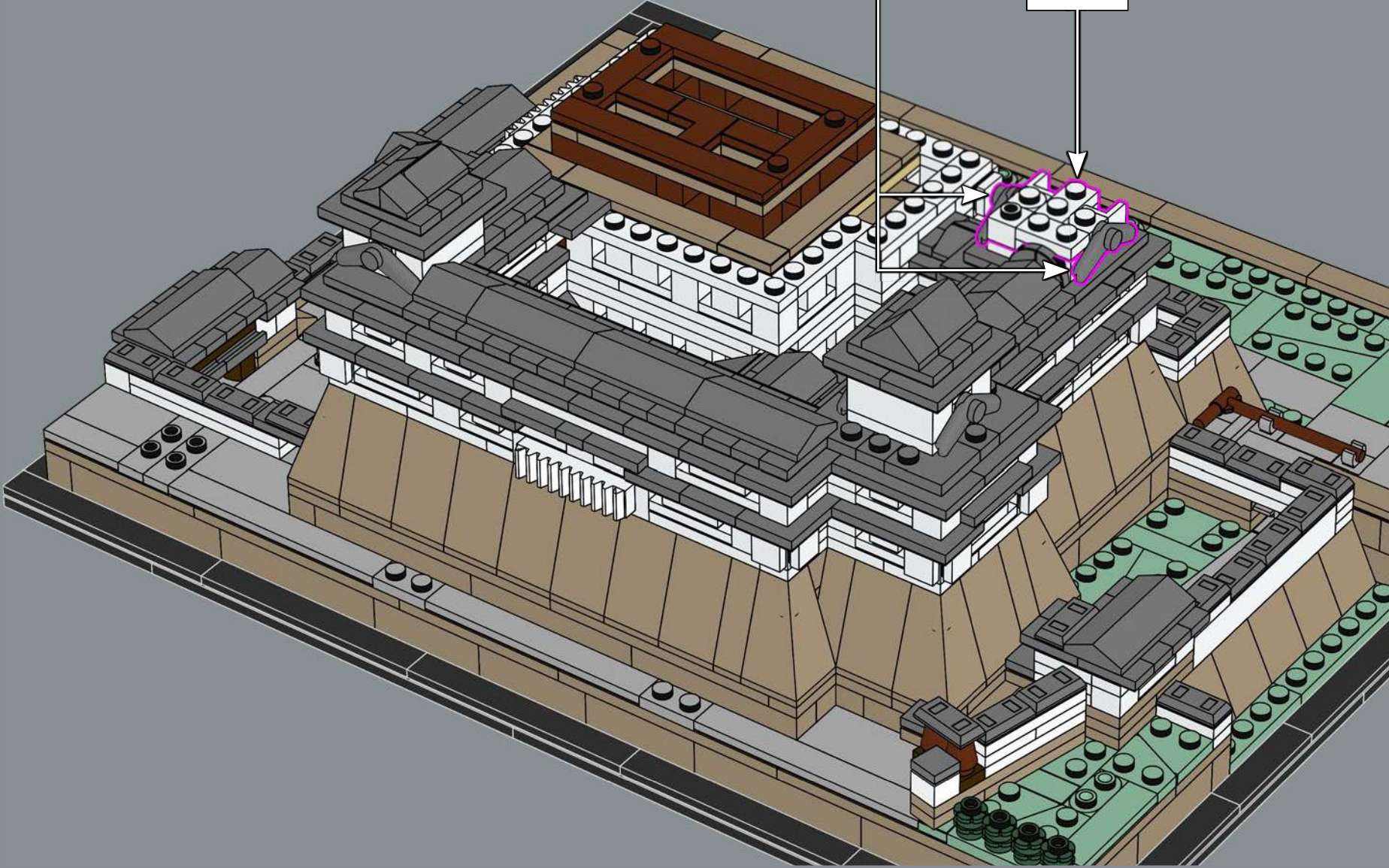
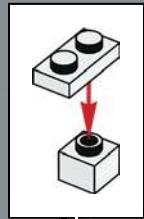
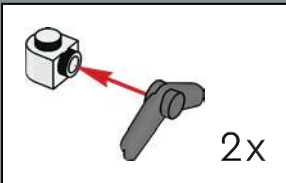

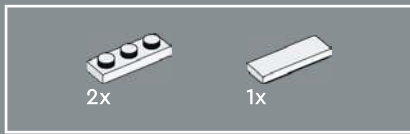

242

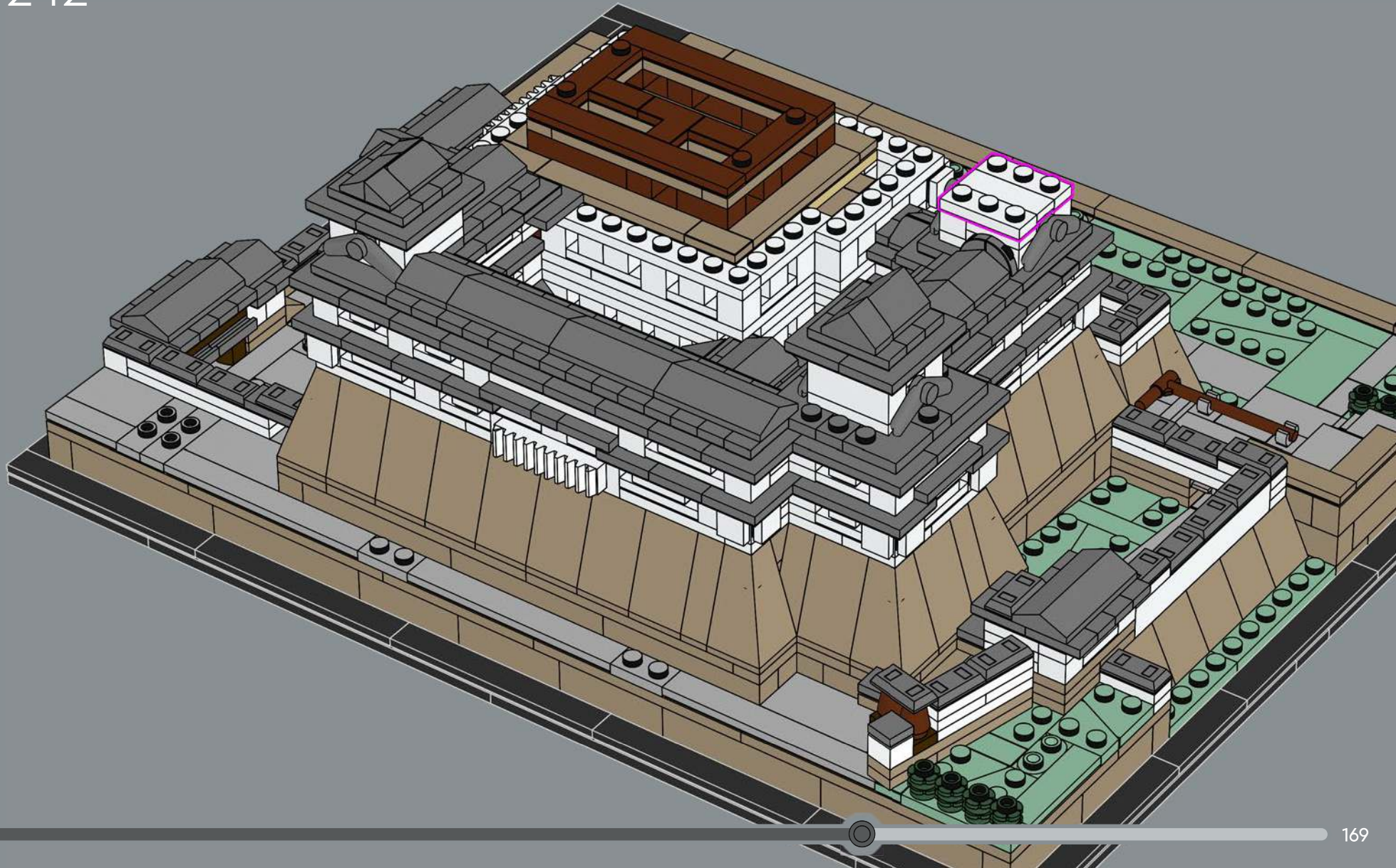

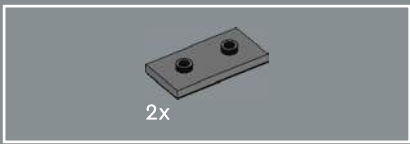

243

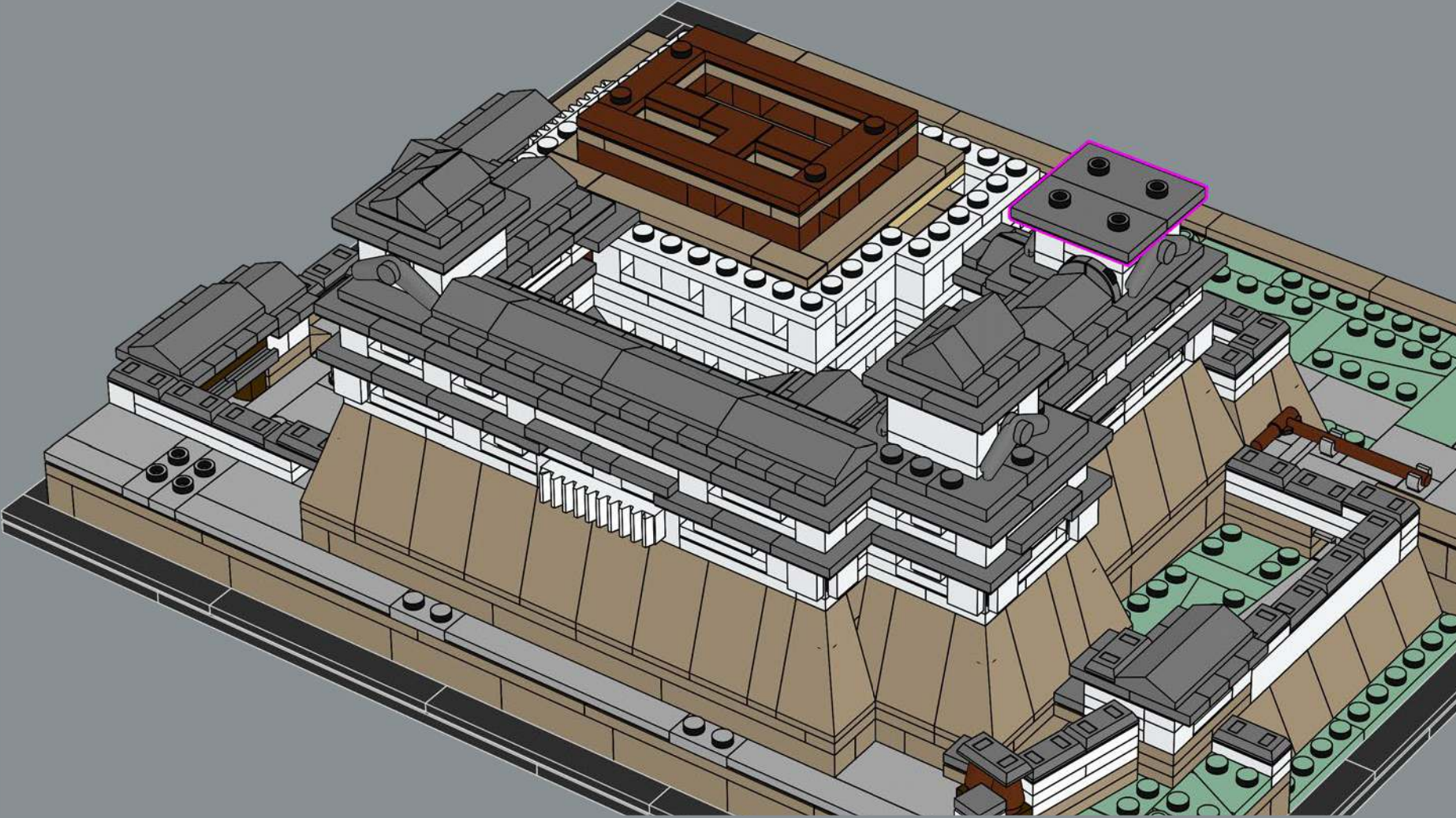

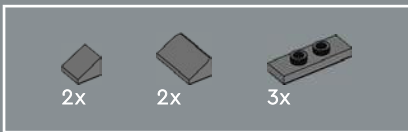

244

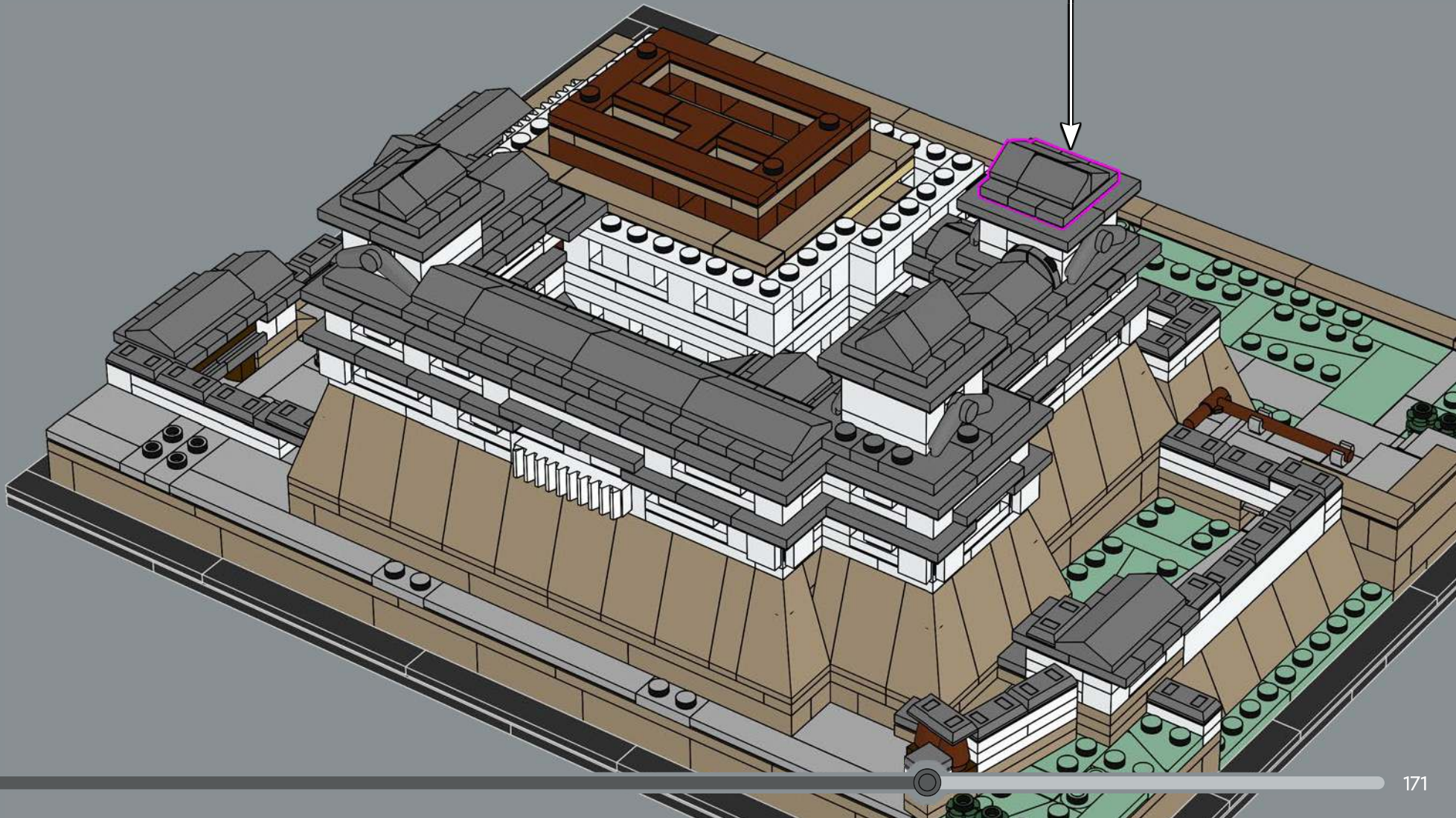
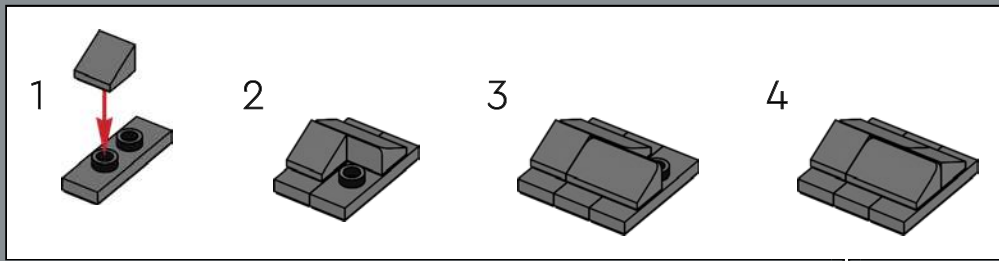

The new bowed 2x2 corner element is only the second NEW element to be approved for a LEGO® Architecture set. The first was a similar element in 3x3 size in Robie House 21010, (2011).

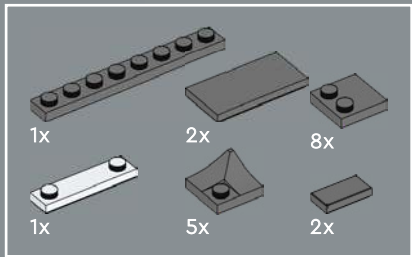

245

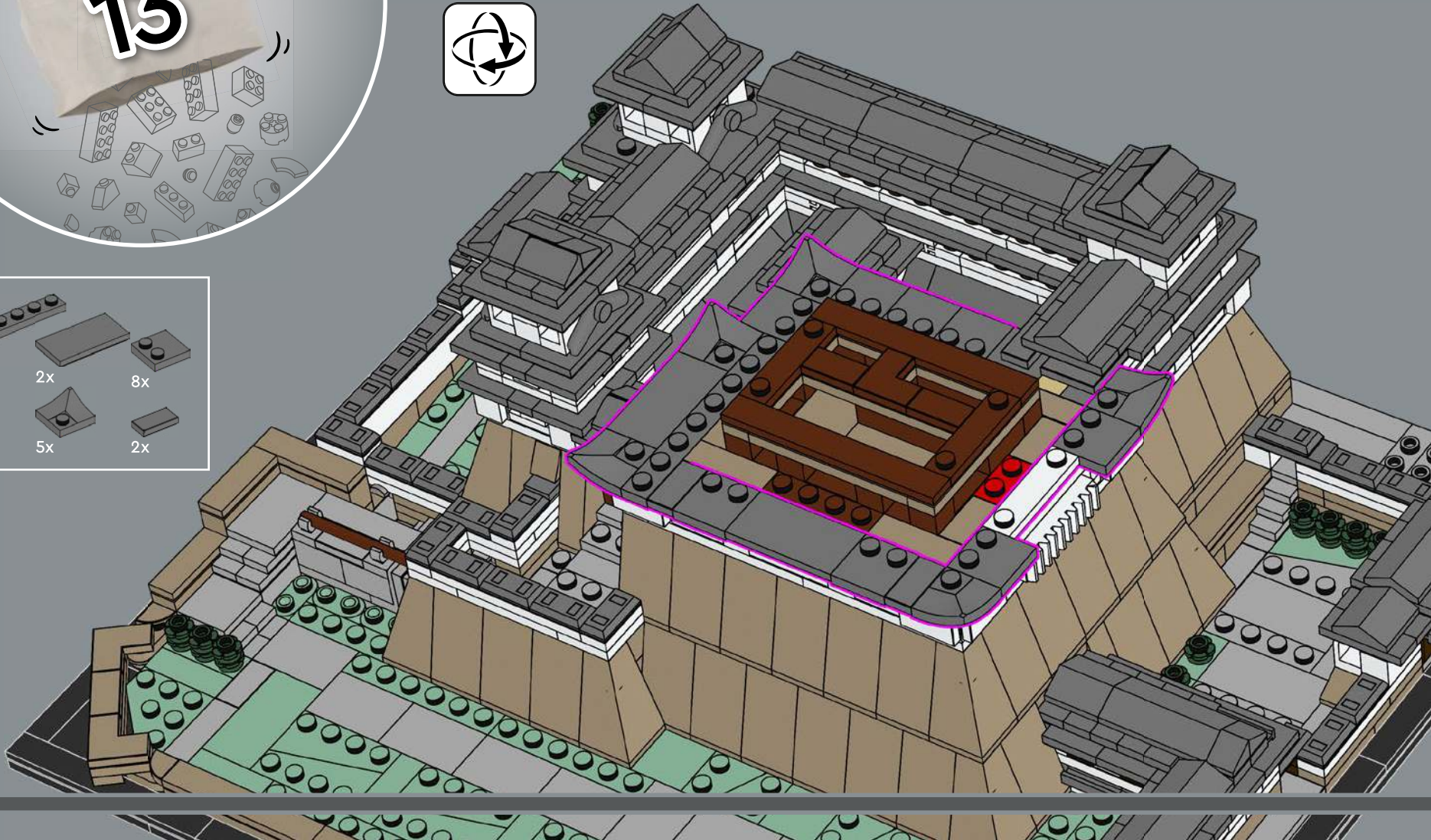

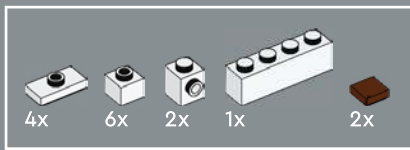

246

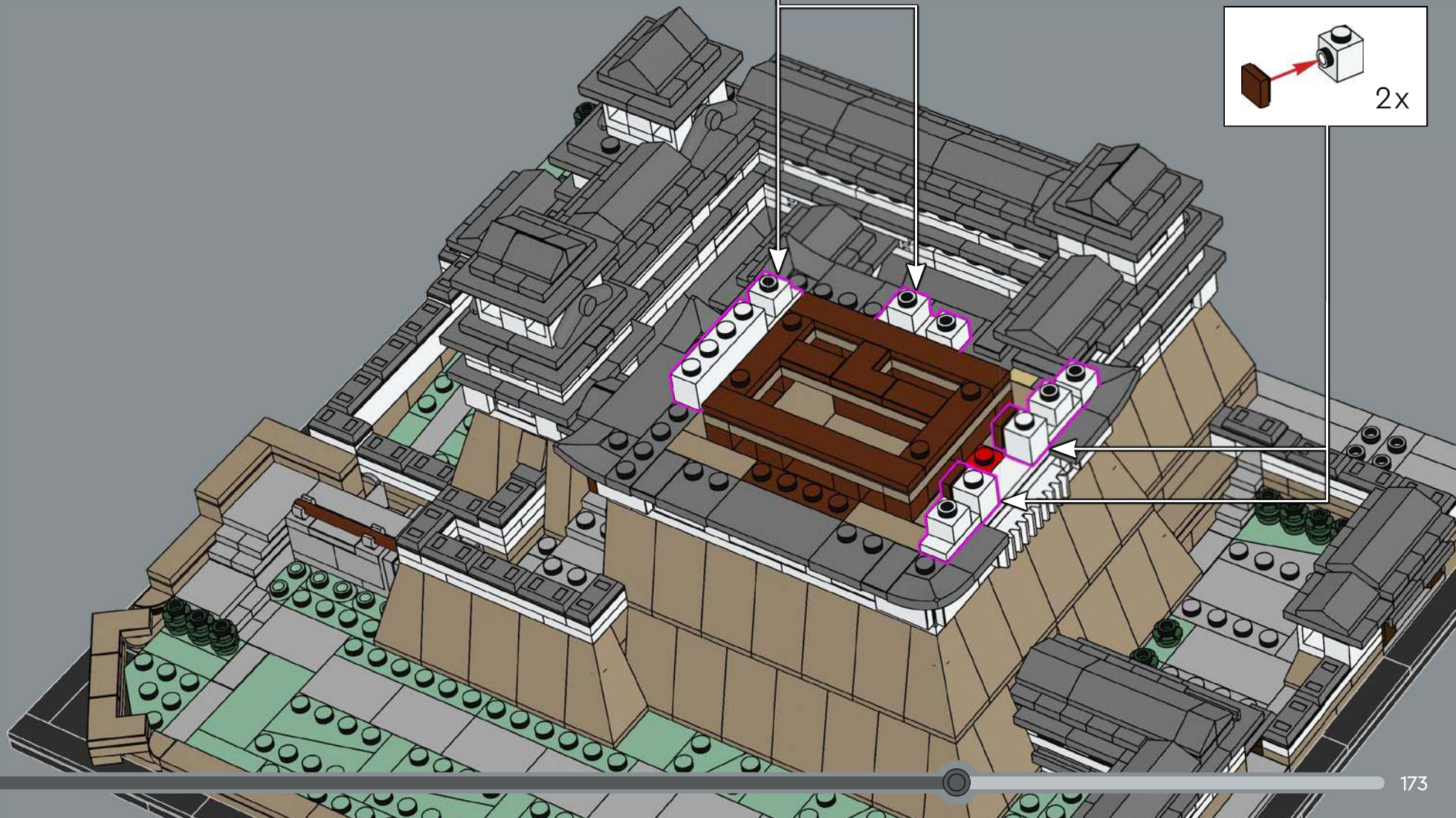
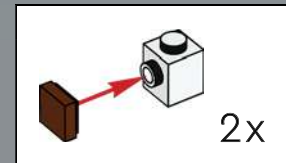
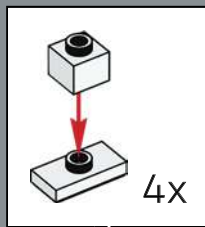

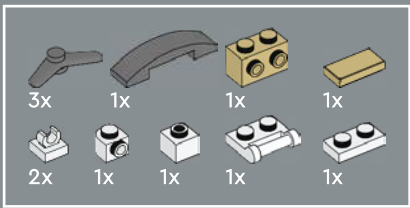

247

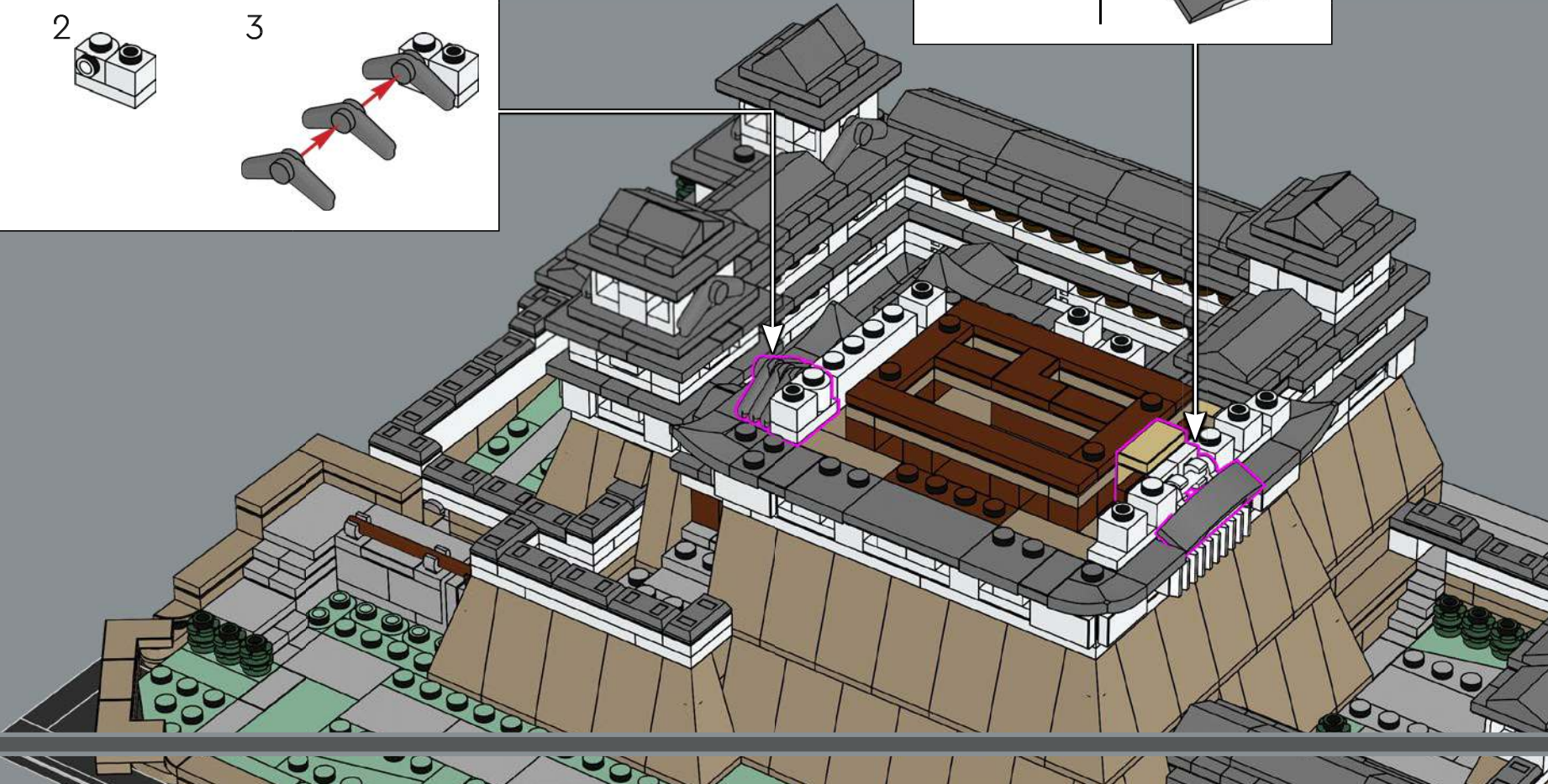
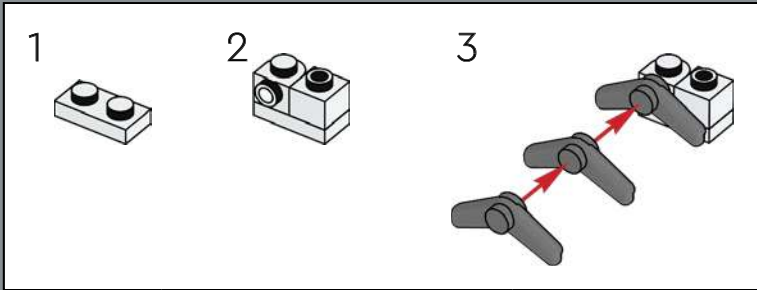
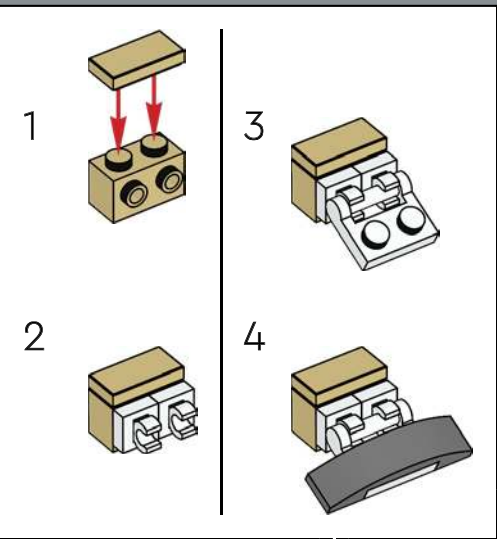

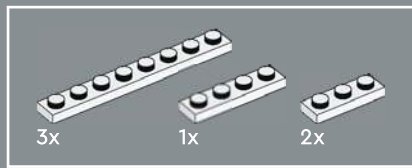

248

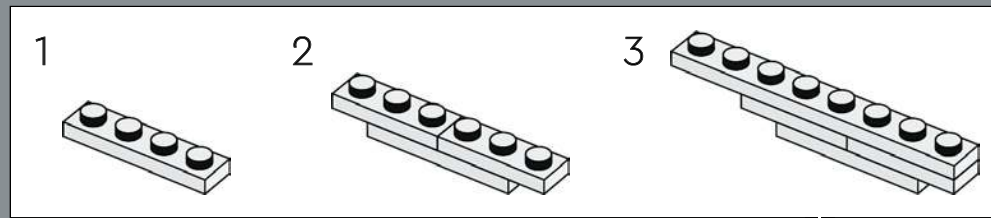

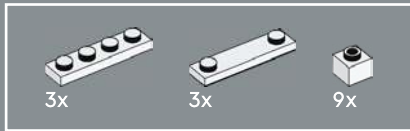
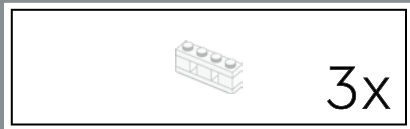

249

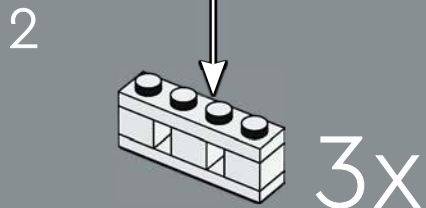
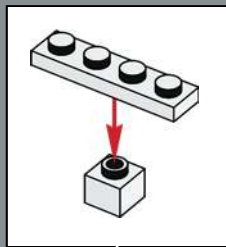
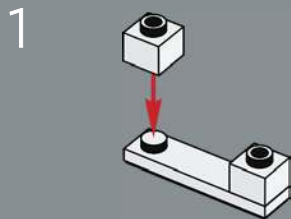

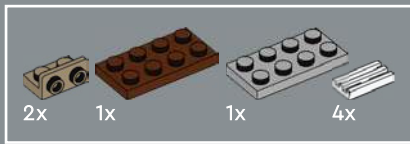

250

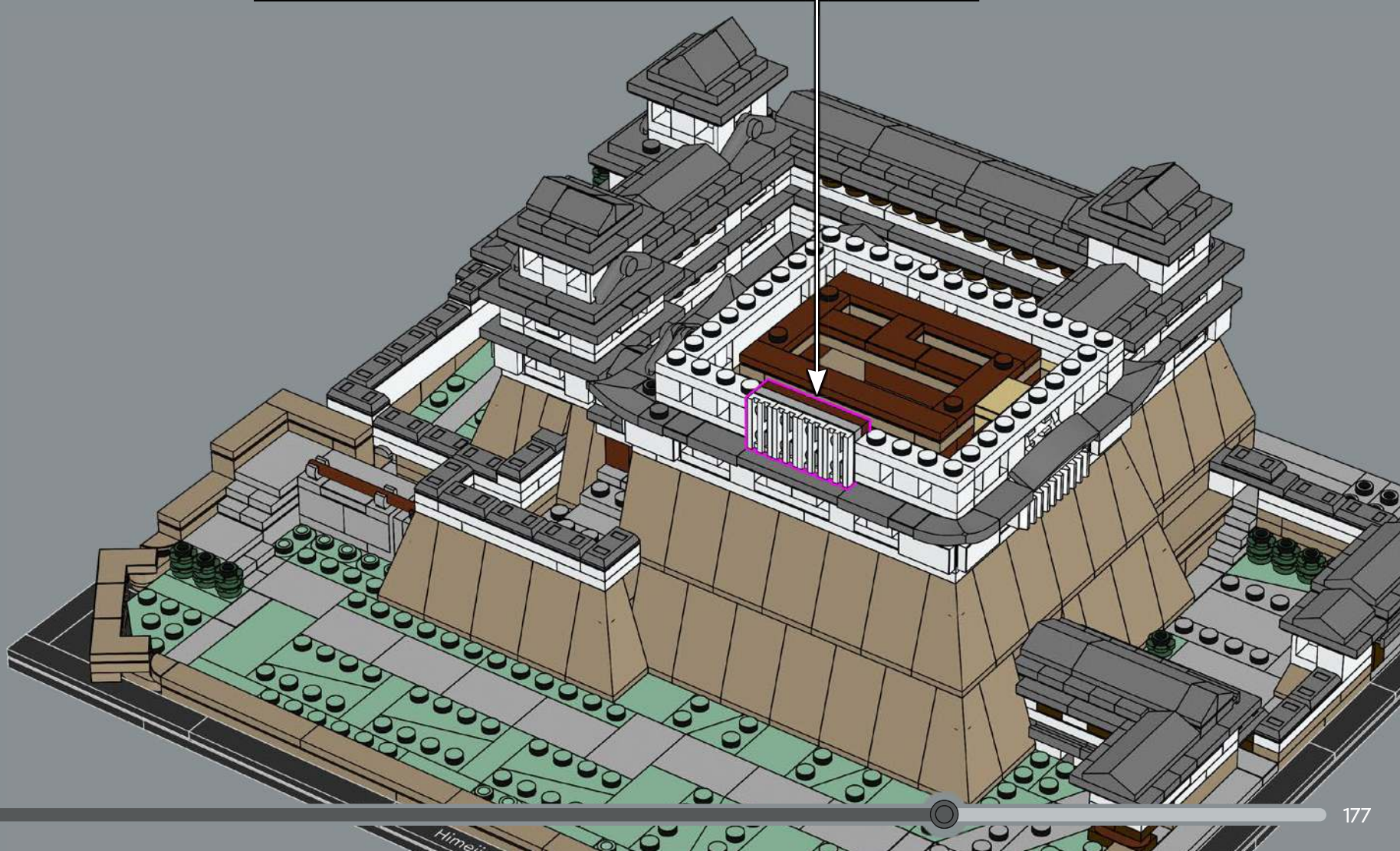
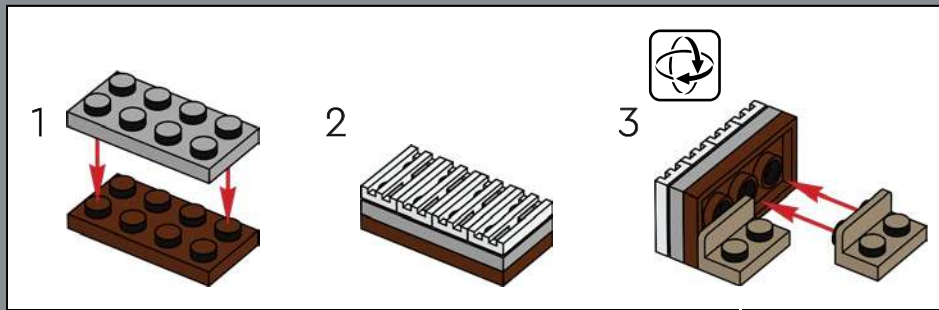

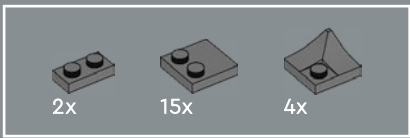

251



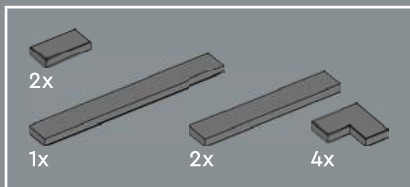

252

The top part of the structure can be removed to reveal some of the interiors, including the mostly empty council area to show what it looked like during the 2009-2015 renovation.

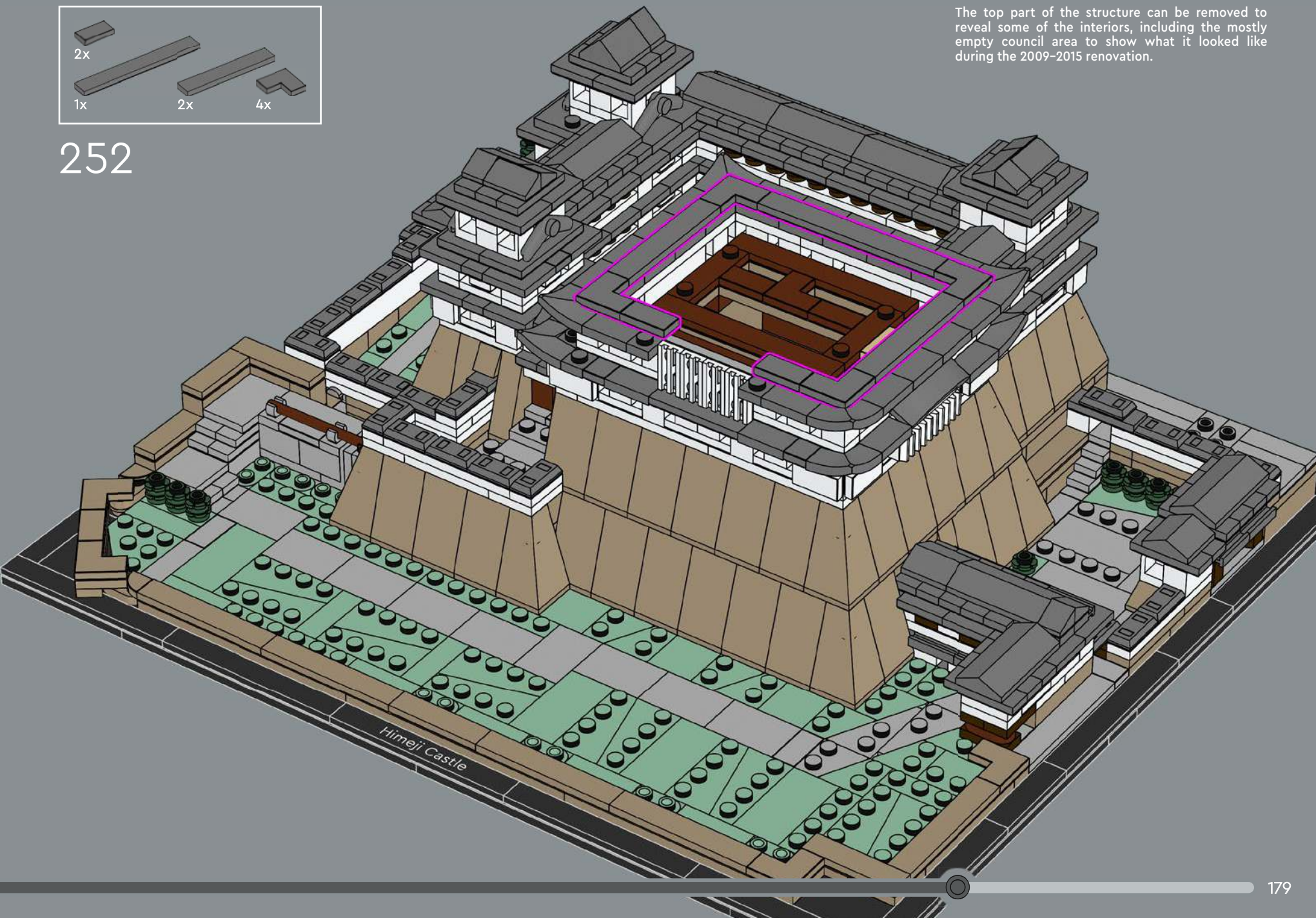

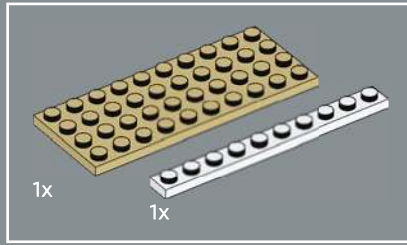
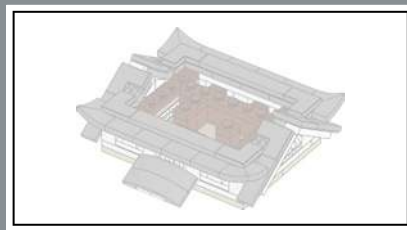

253

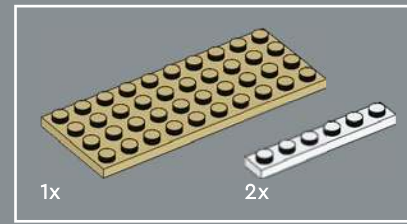
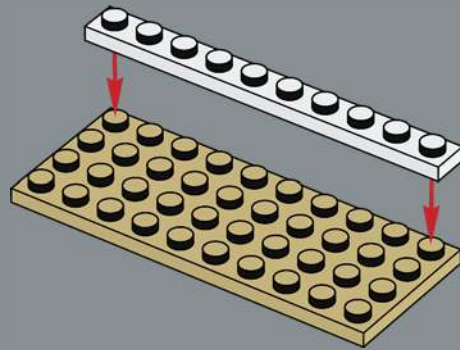

254

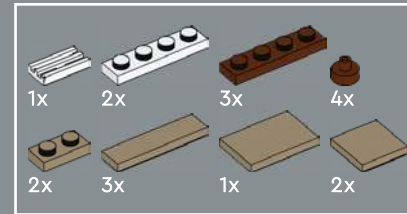
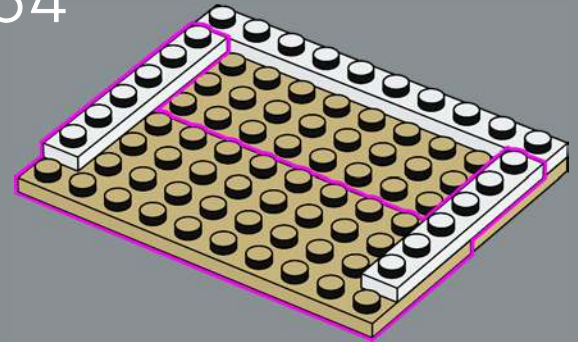

255

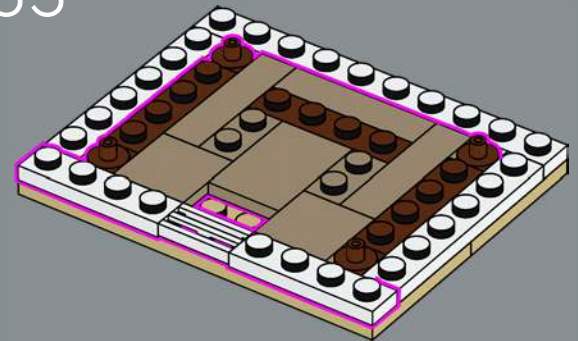

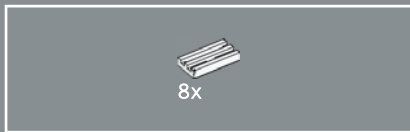

256

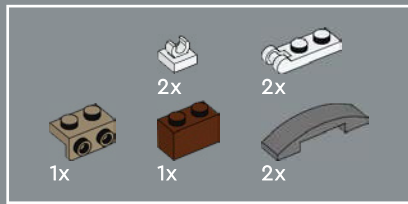
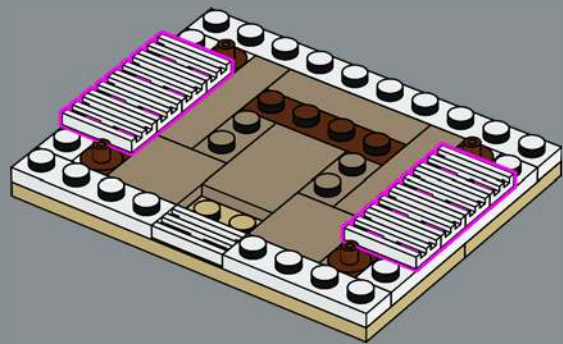

257

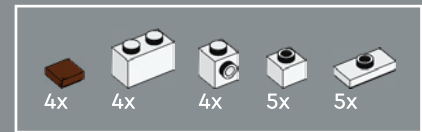
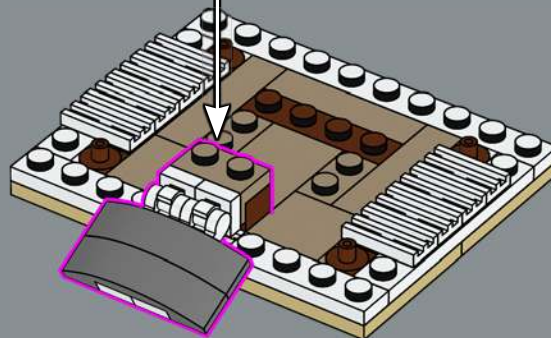
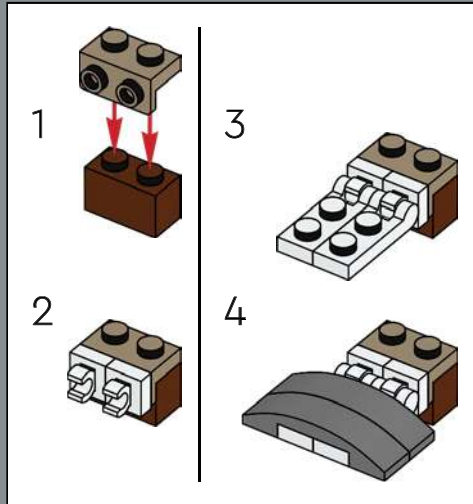

258

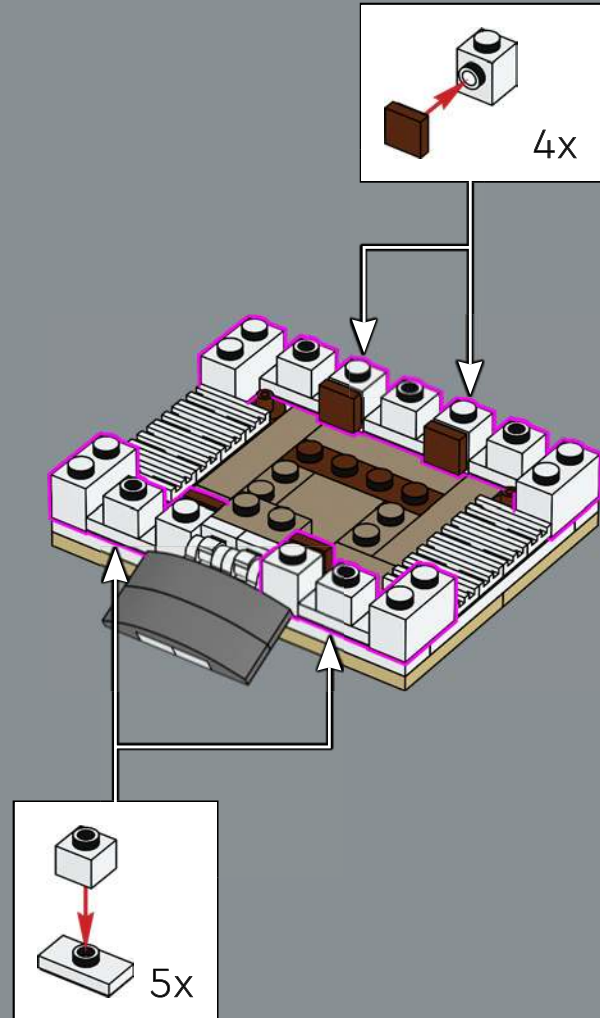

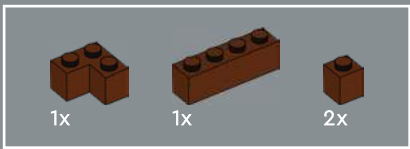

259

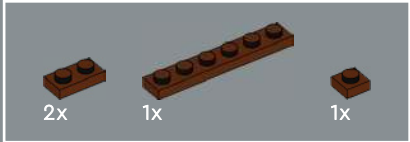
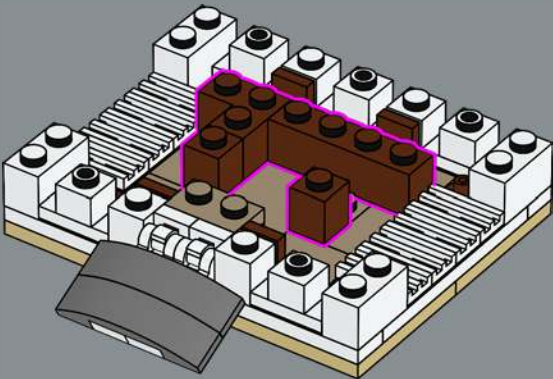

260

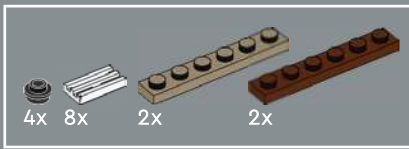
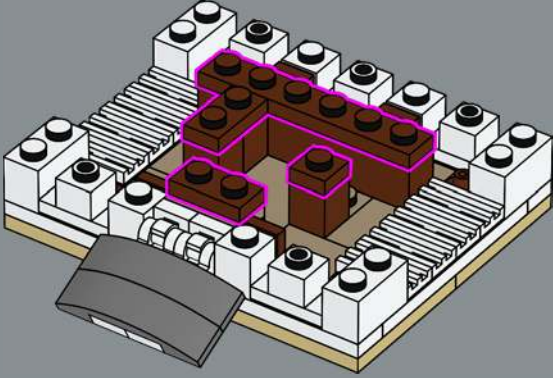

261

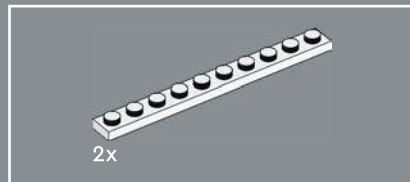
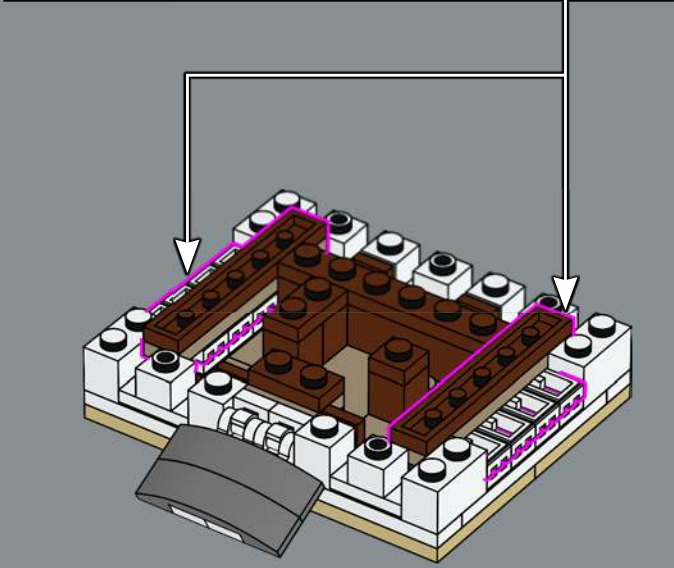
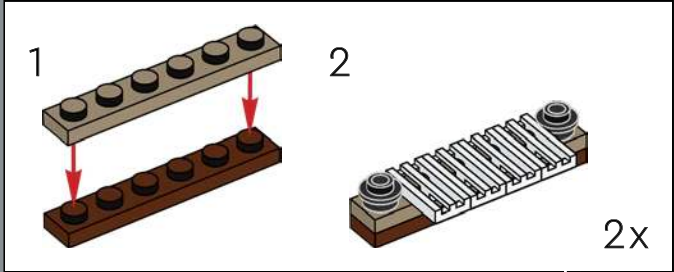

262

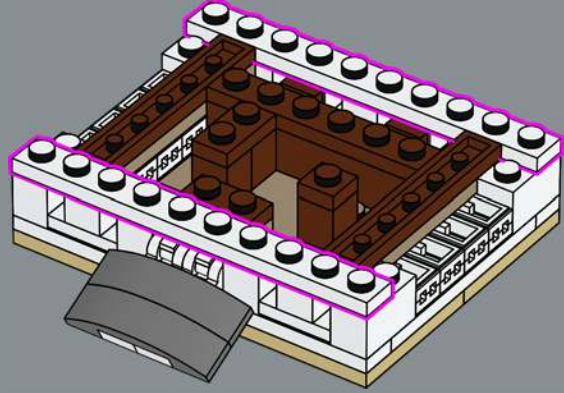

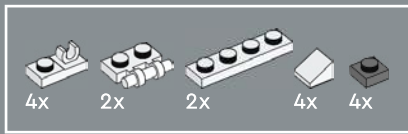

263

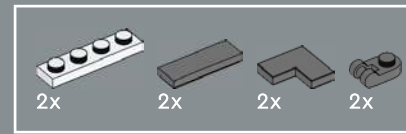
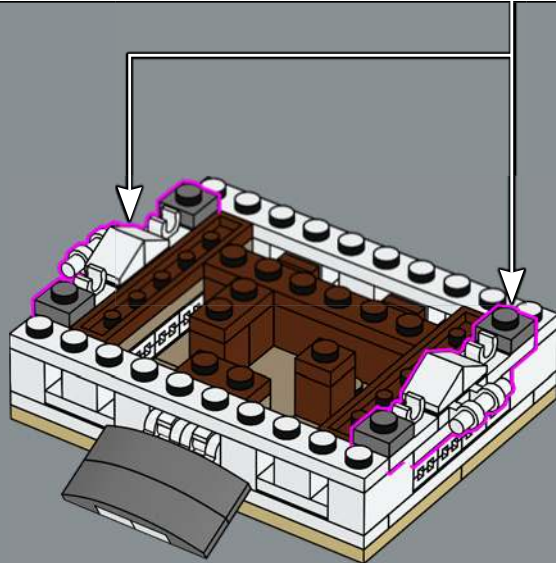
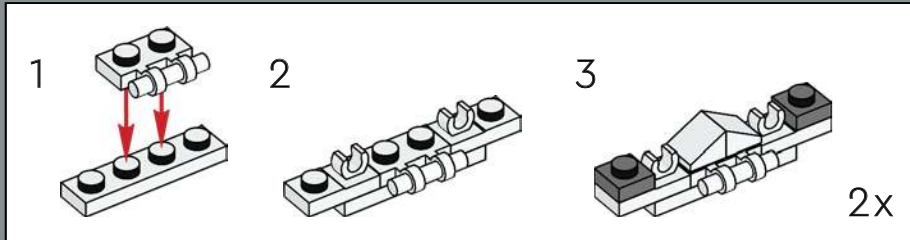

264

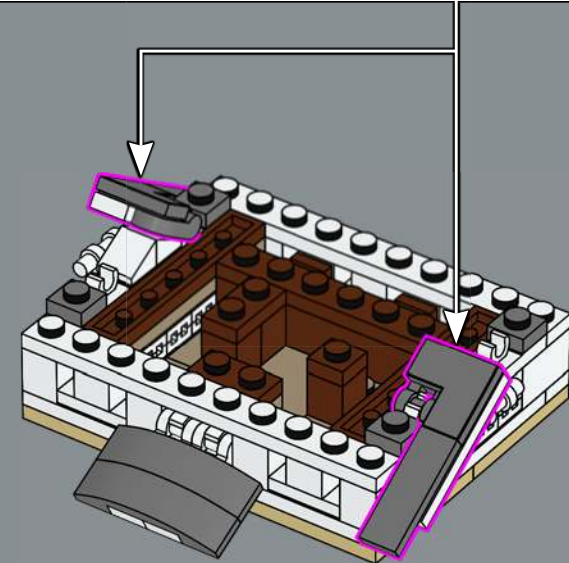
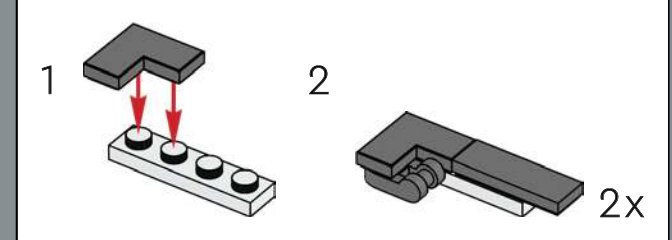

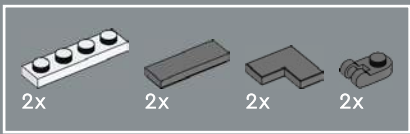

Each floor of the castle's Main Keep has a unique layout that draws from the floor plans of the original castle.

265

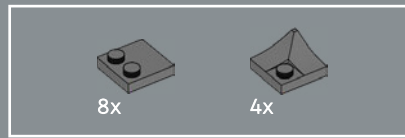
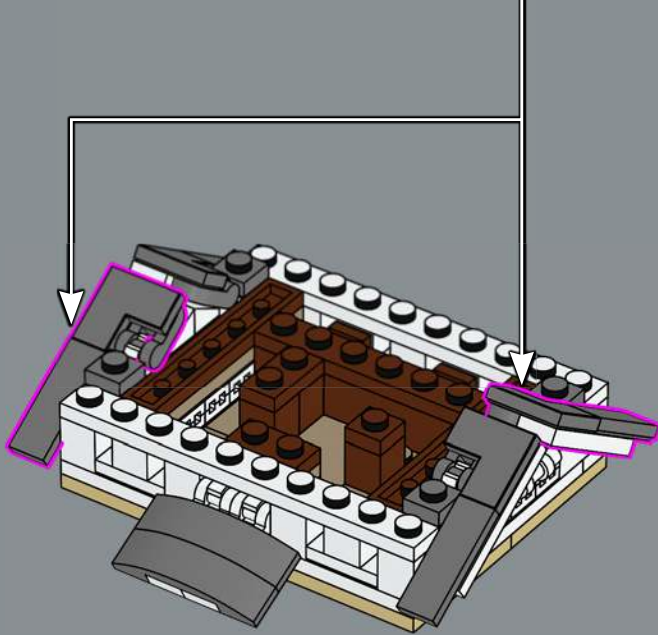
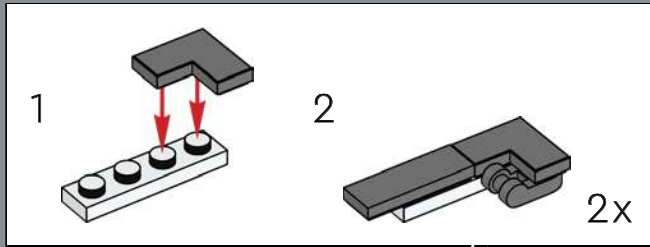

266

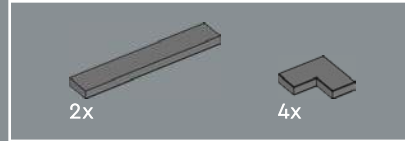
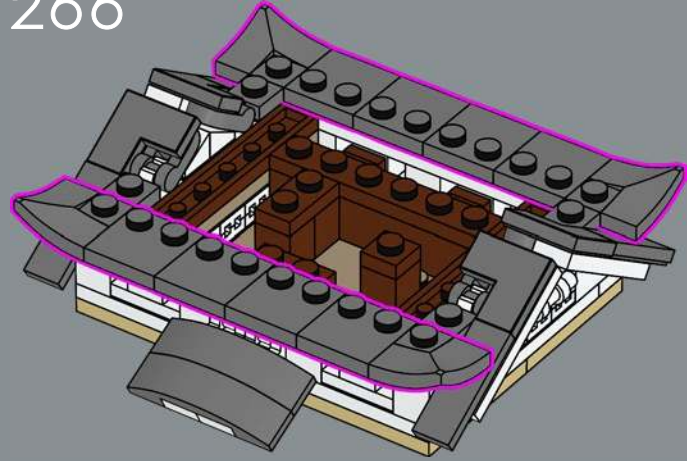

267

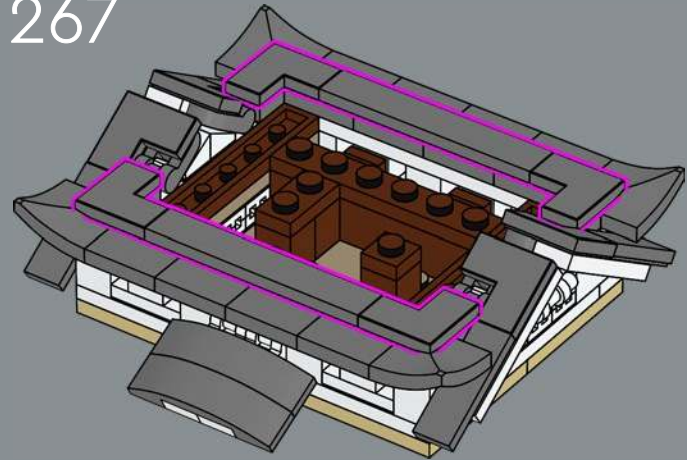

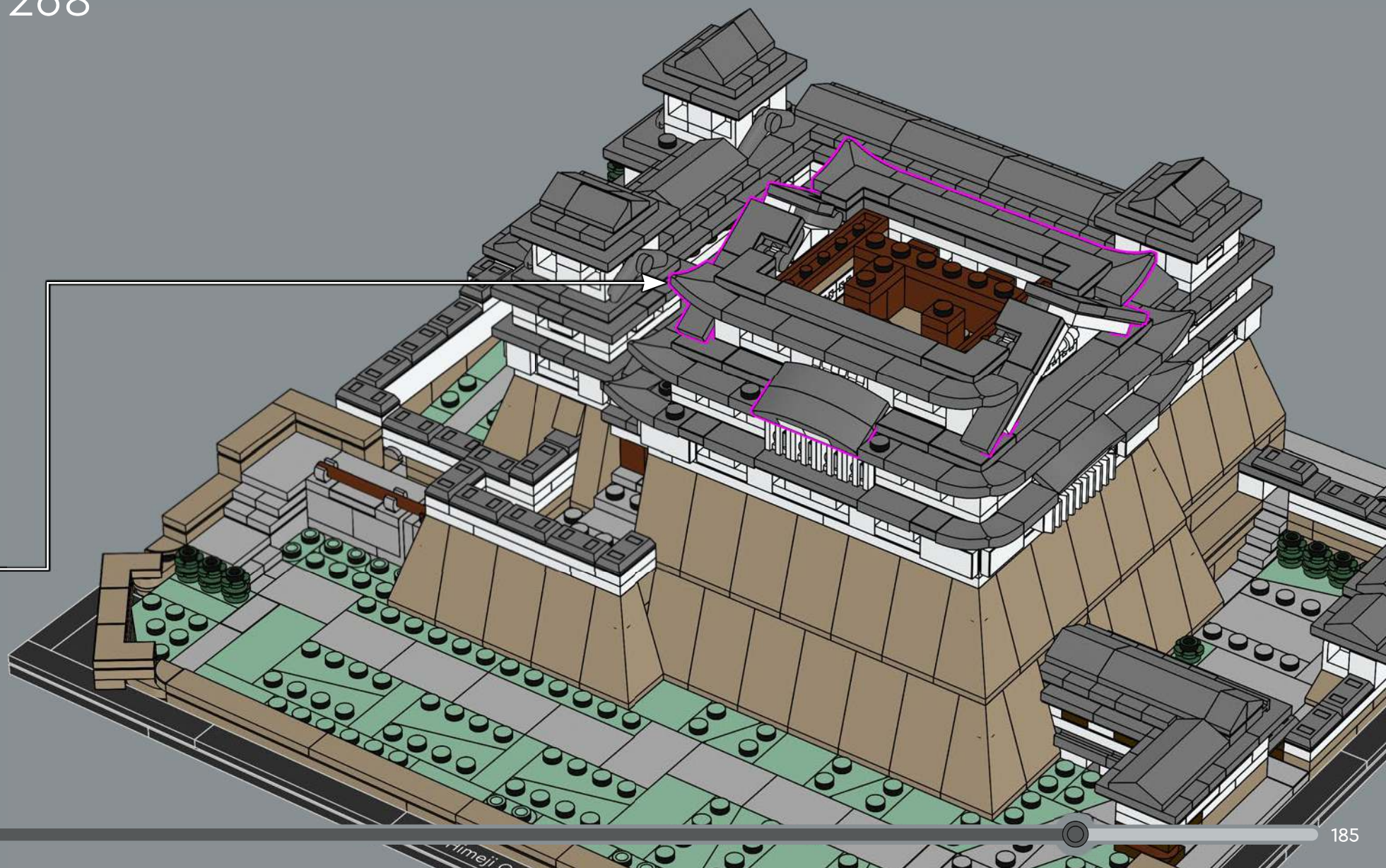

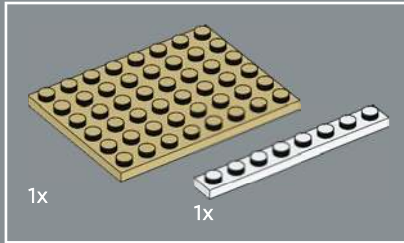
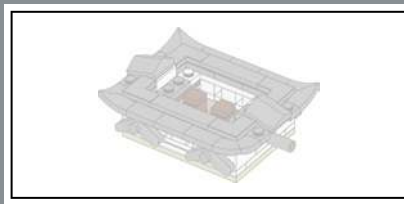

269

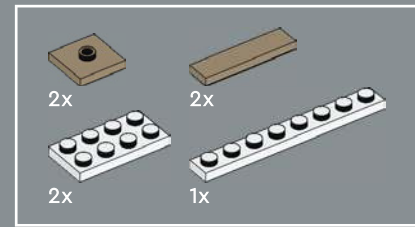
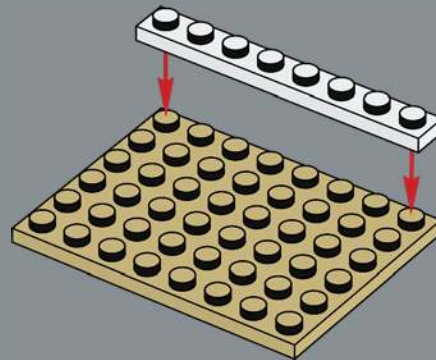

270

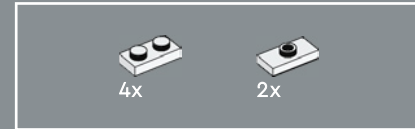
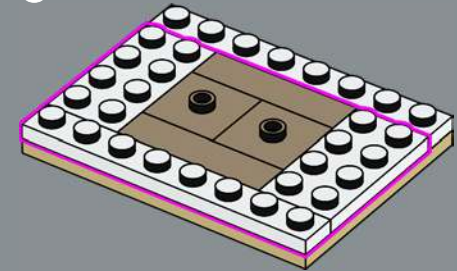

271

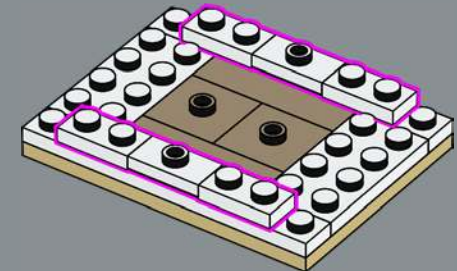

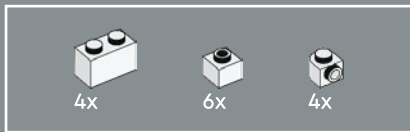

272

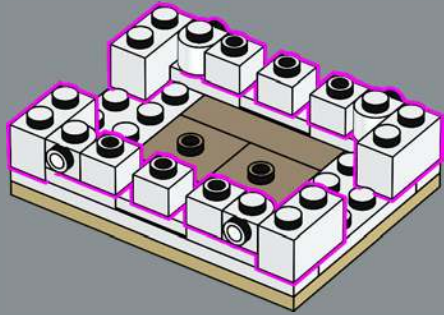

273

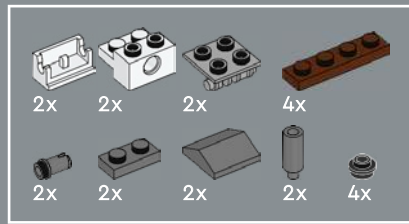
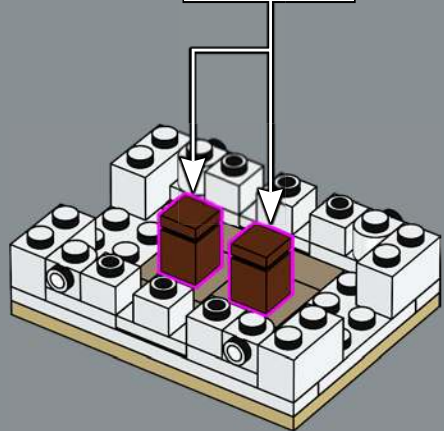
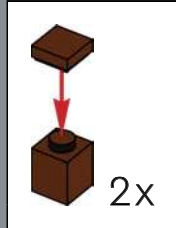

274

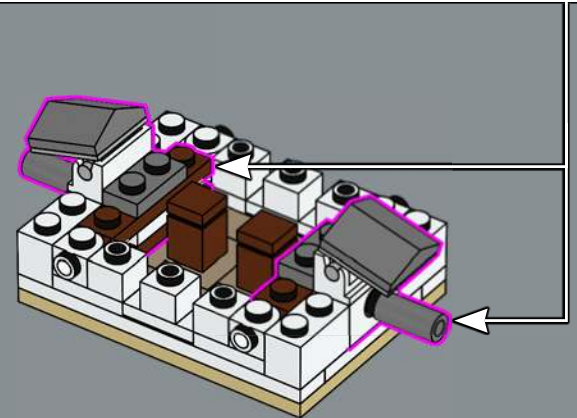
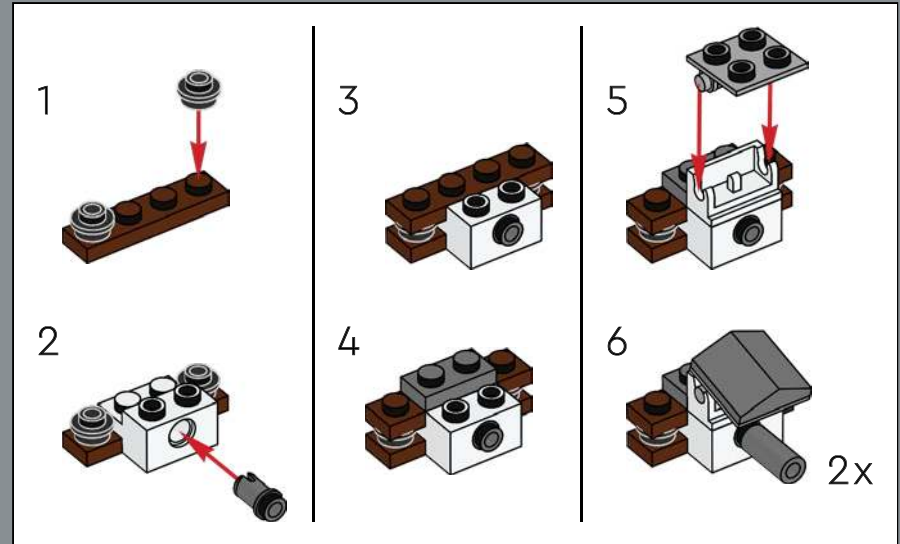

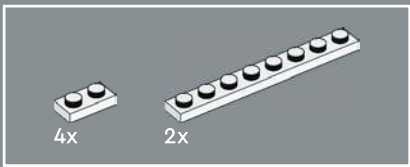

275

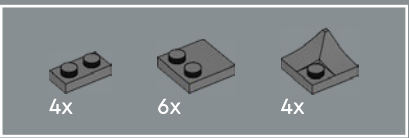
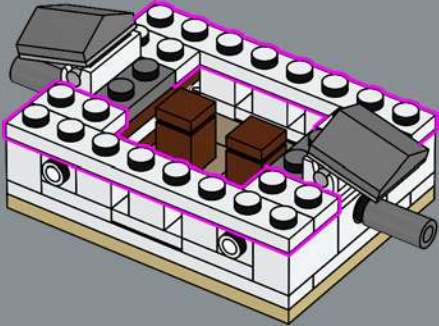

277

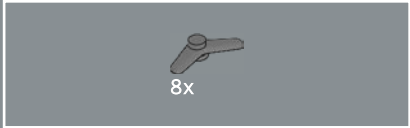
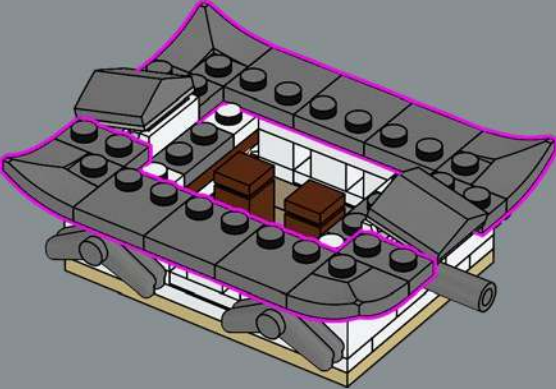

276

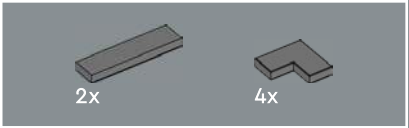
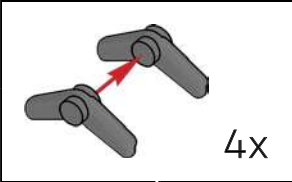
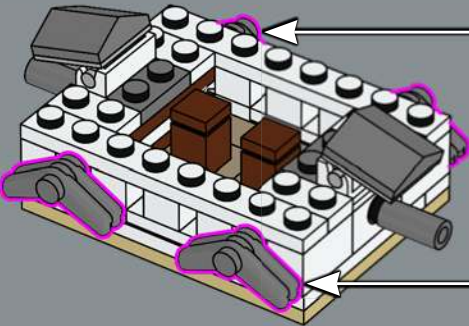

278

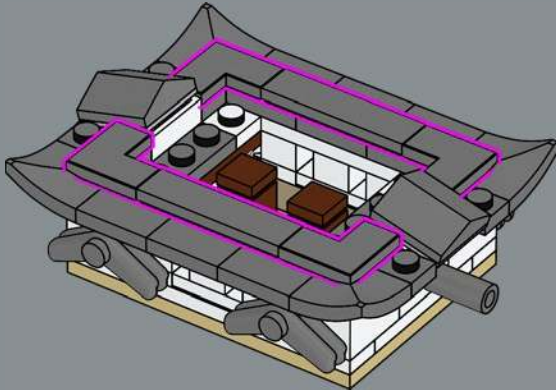

279

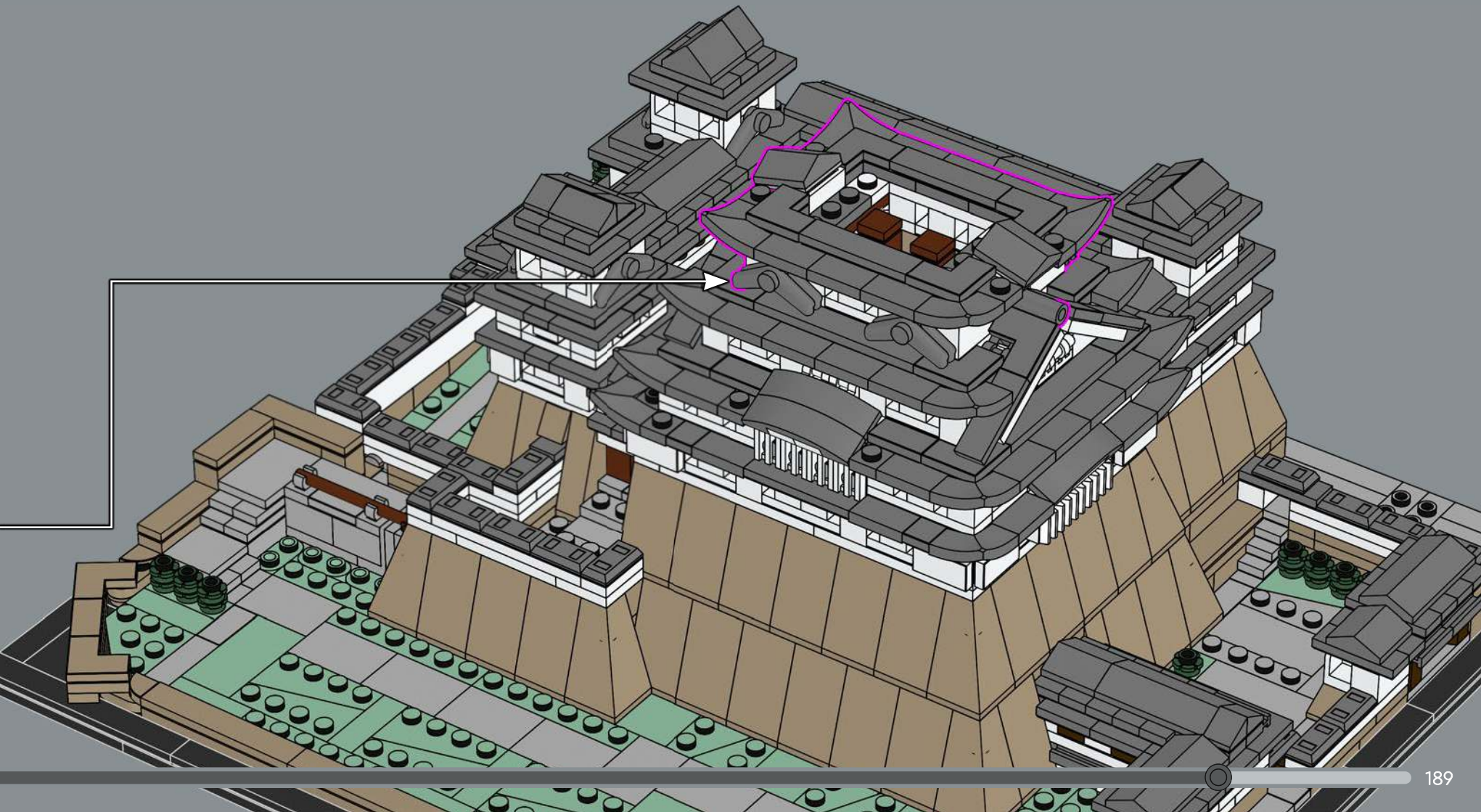

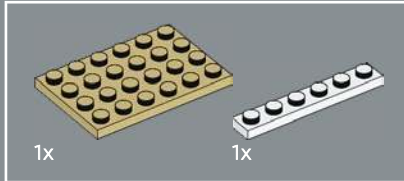
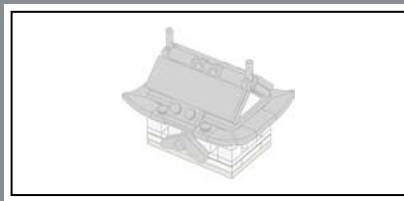

280

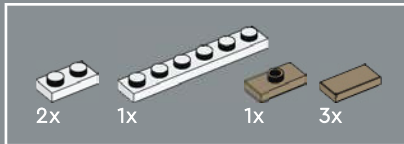
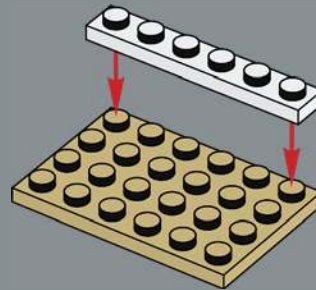

281

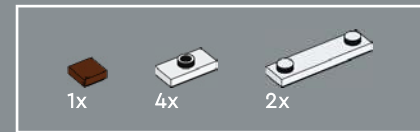
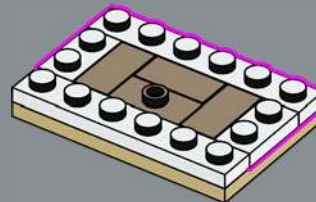

282

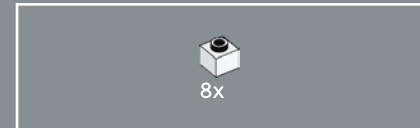
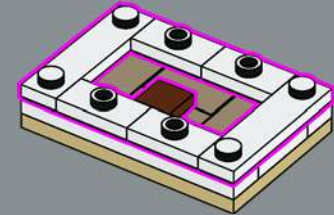

283

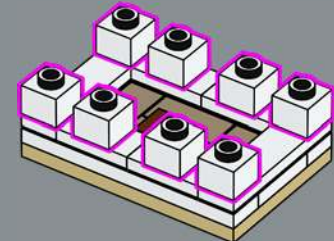

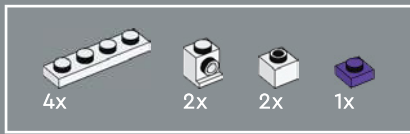

The purple 1x1 tile in the top floor chamber of the Main Keep is a nod to the small sacred wooden shrine covered in a purple drape inside this castle chamber.

284

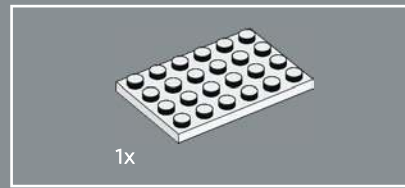
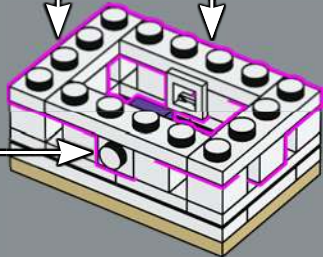
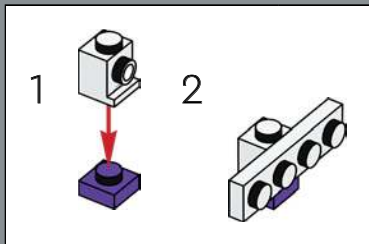
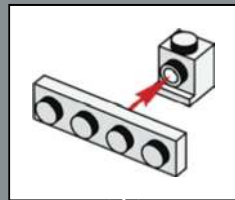
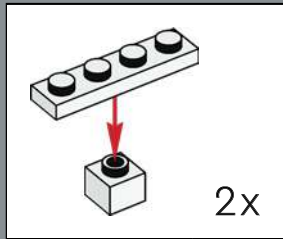

285

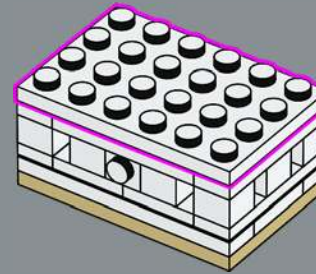

286

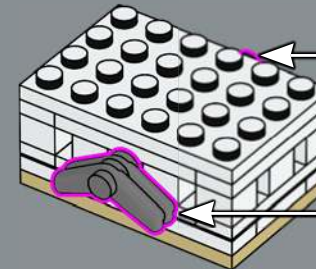
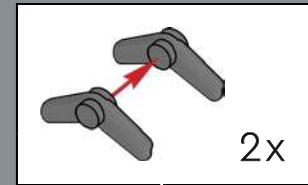

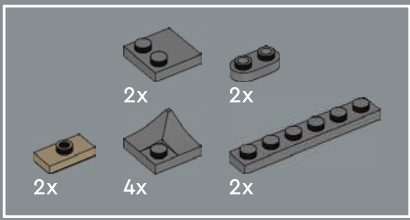

287

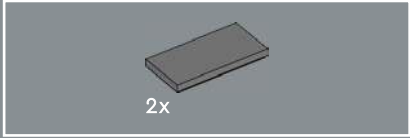
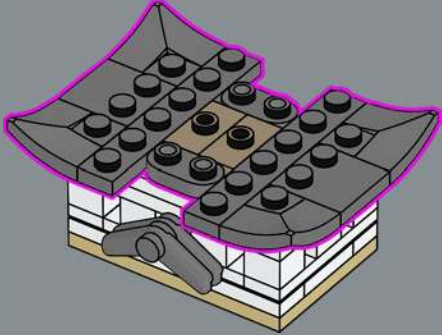

288

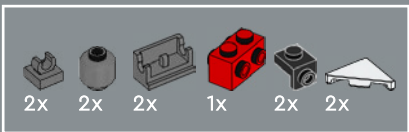
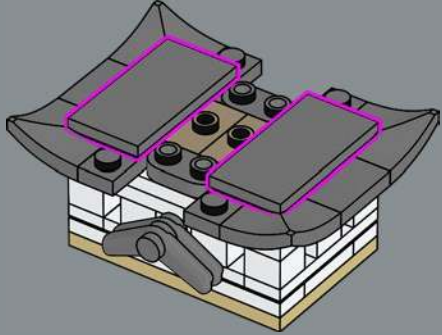

289

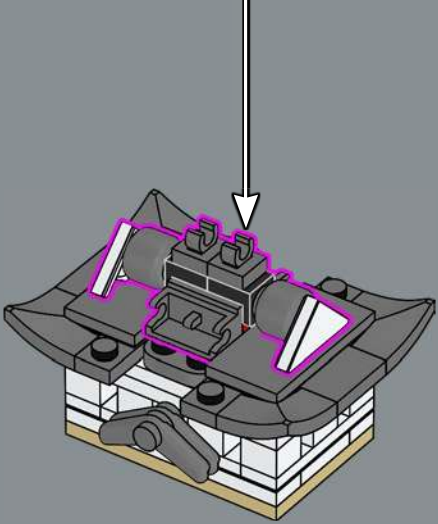
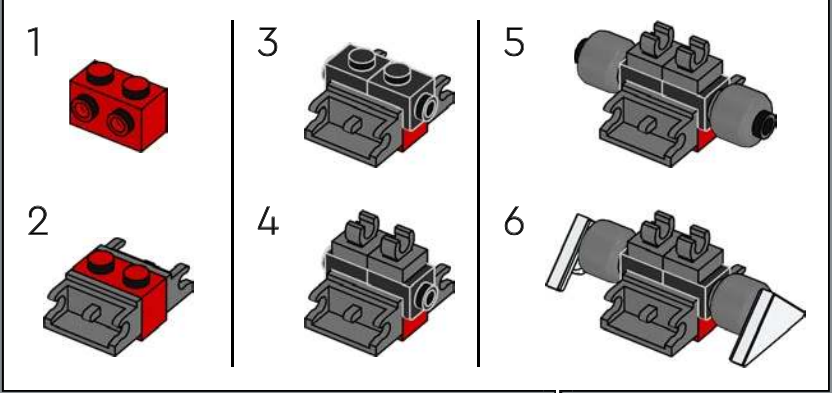

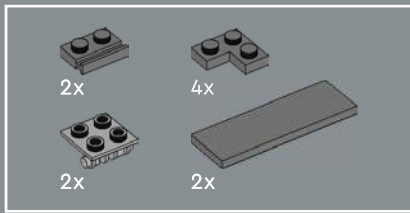

290

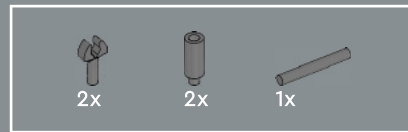
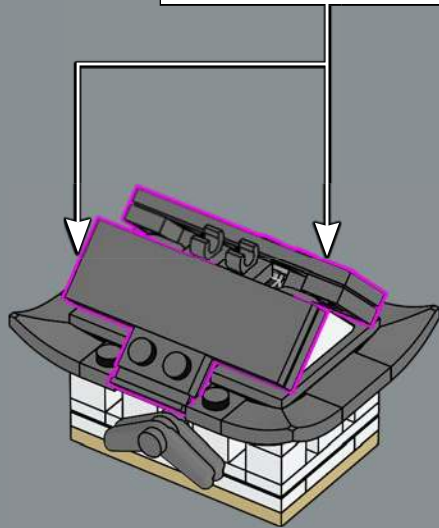
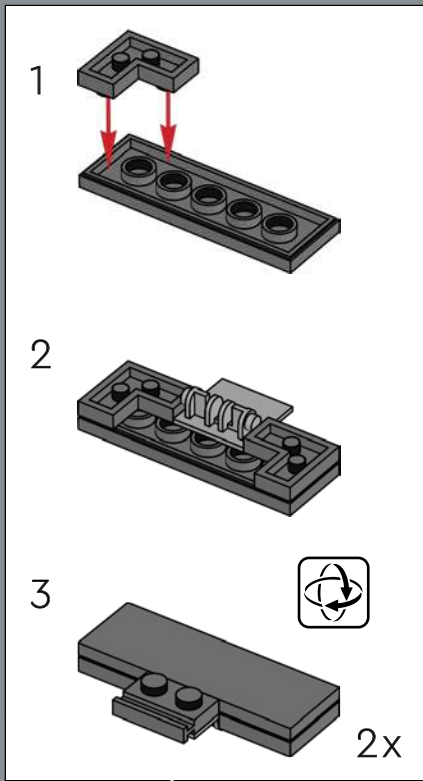

291

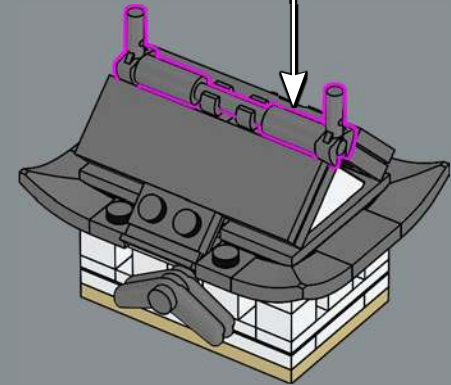
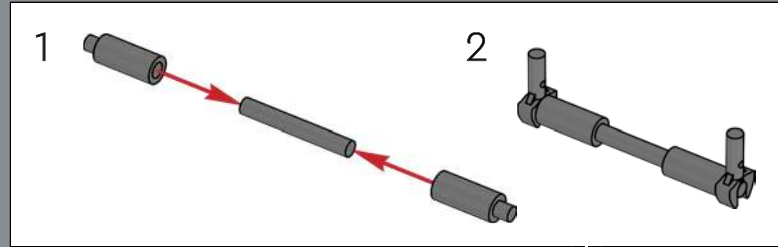

The Main Keep roof tiles were replaced during the 2009–2015 renovation. The new, thinner tiles weigh 0.75 kg (1.6 lbs.) less per tile, making the entire roof 45+ tonnes (50+ tons) lighter than before!

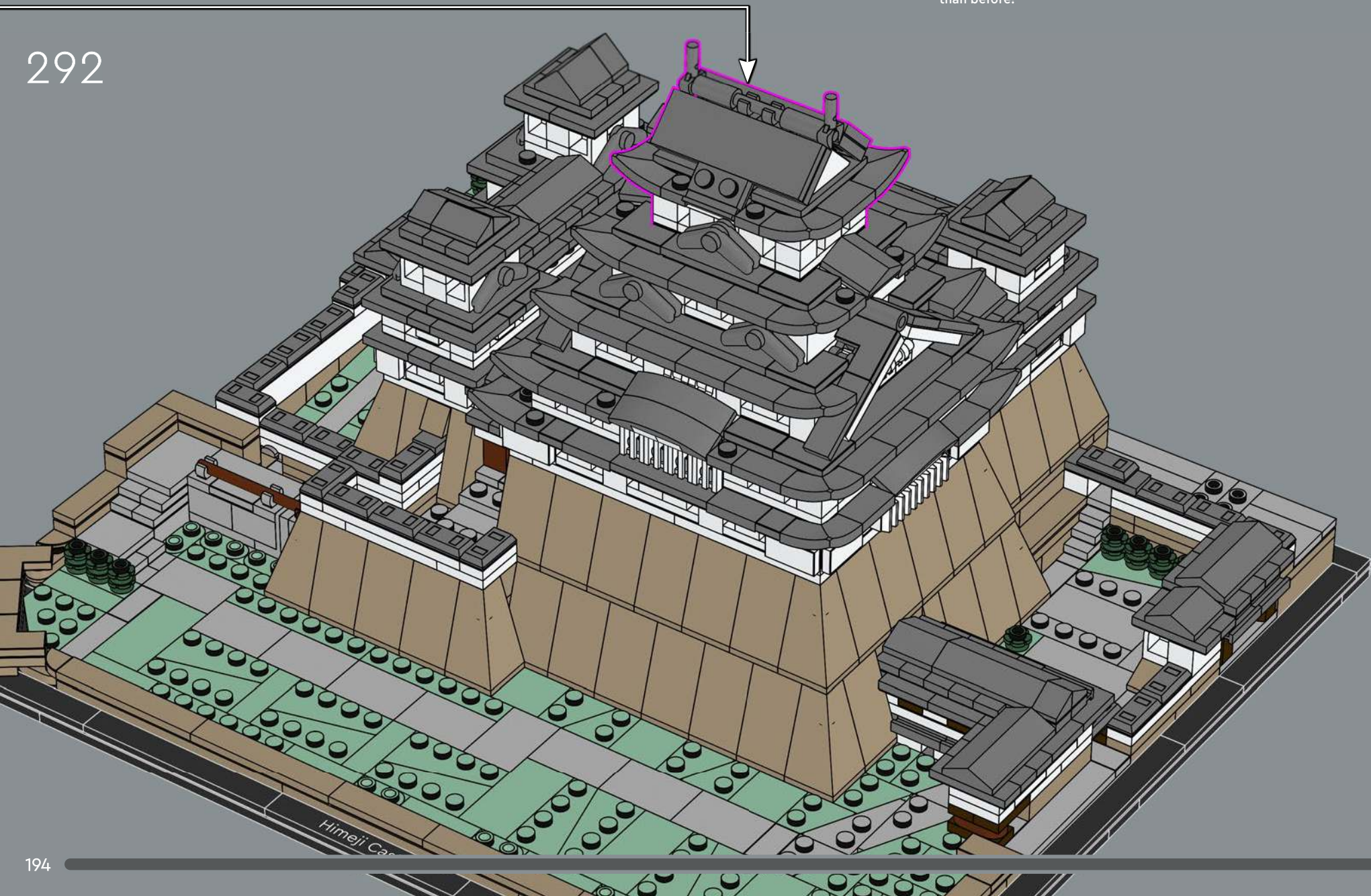



293

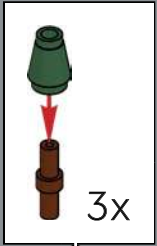



294

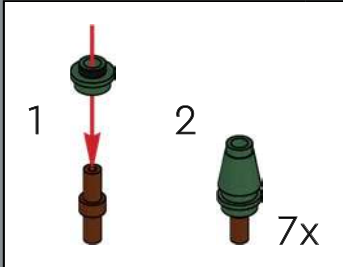

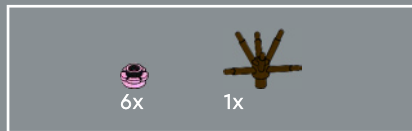

295

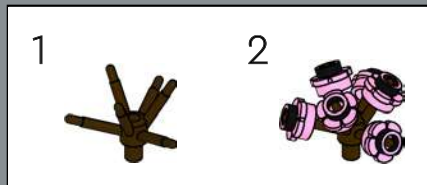



3x

296



3x

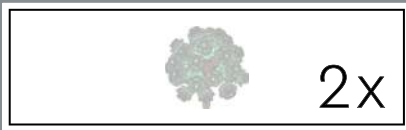

297

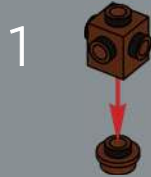
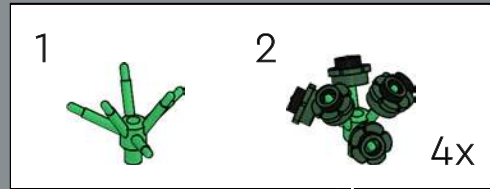
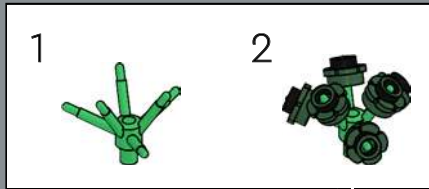



298

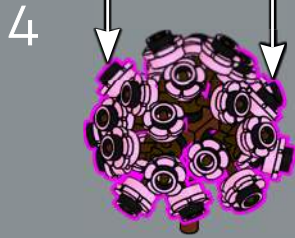
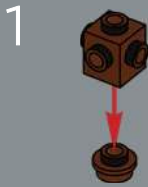
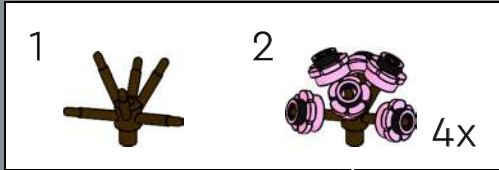
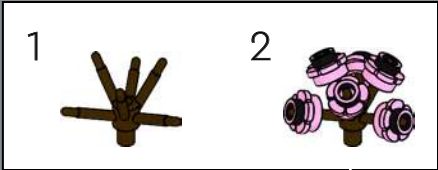





299

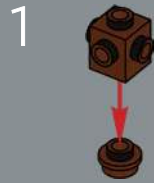
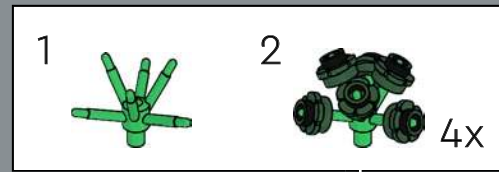
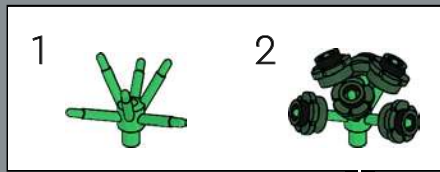

Himeji Castle is also known as The Castle of the White Heron, as it resembles the majestic bird about to take flight.

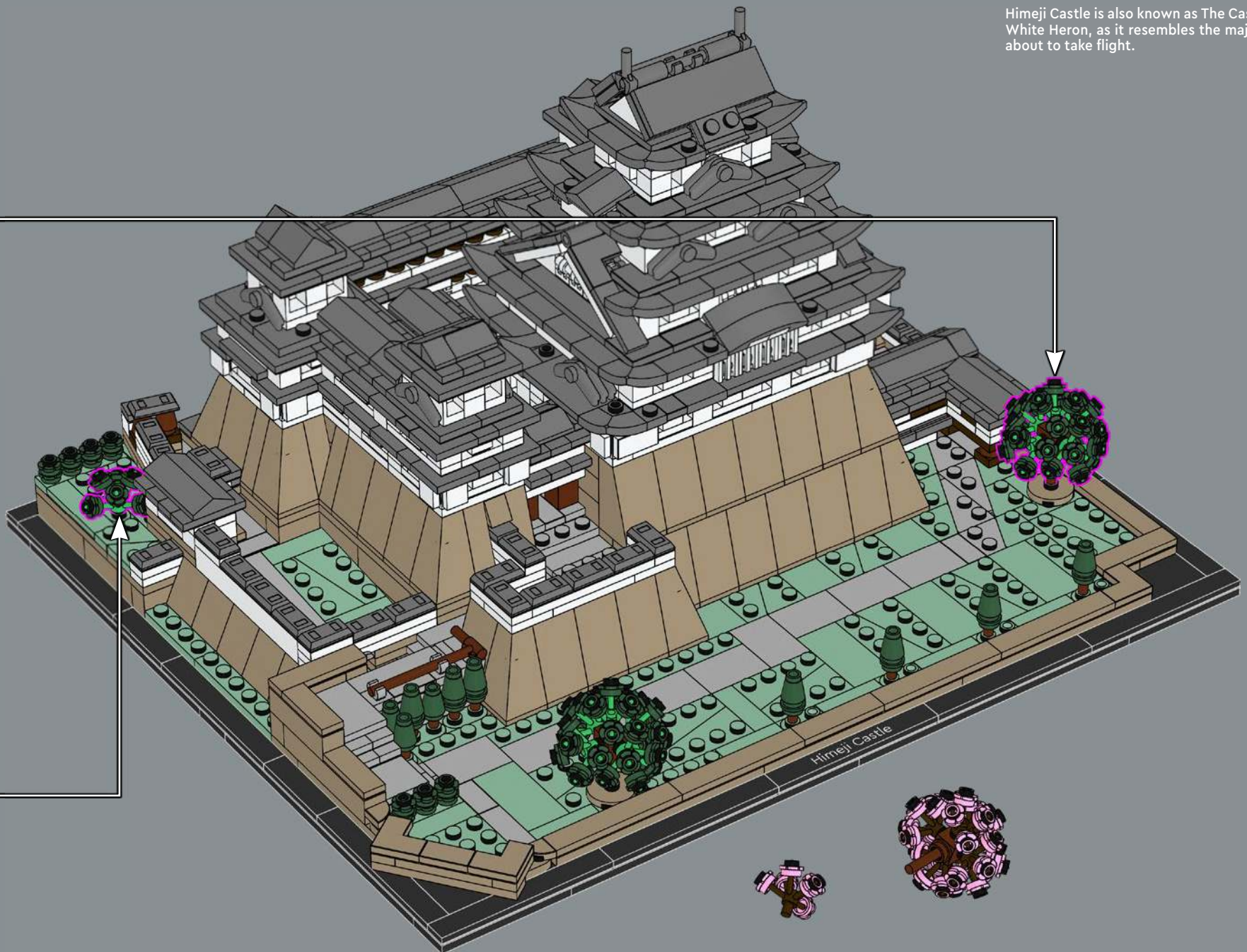

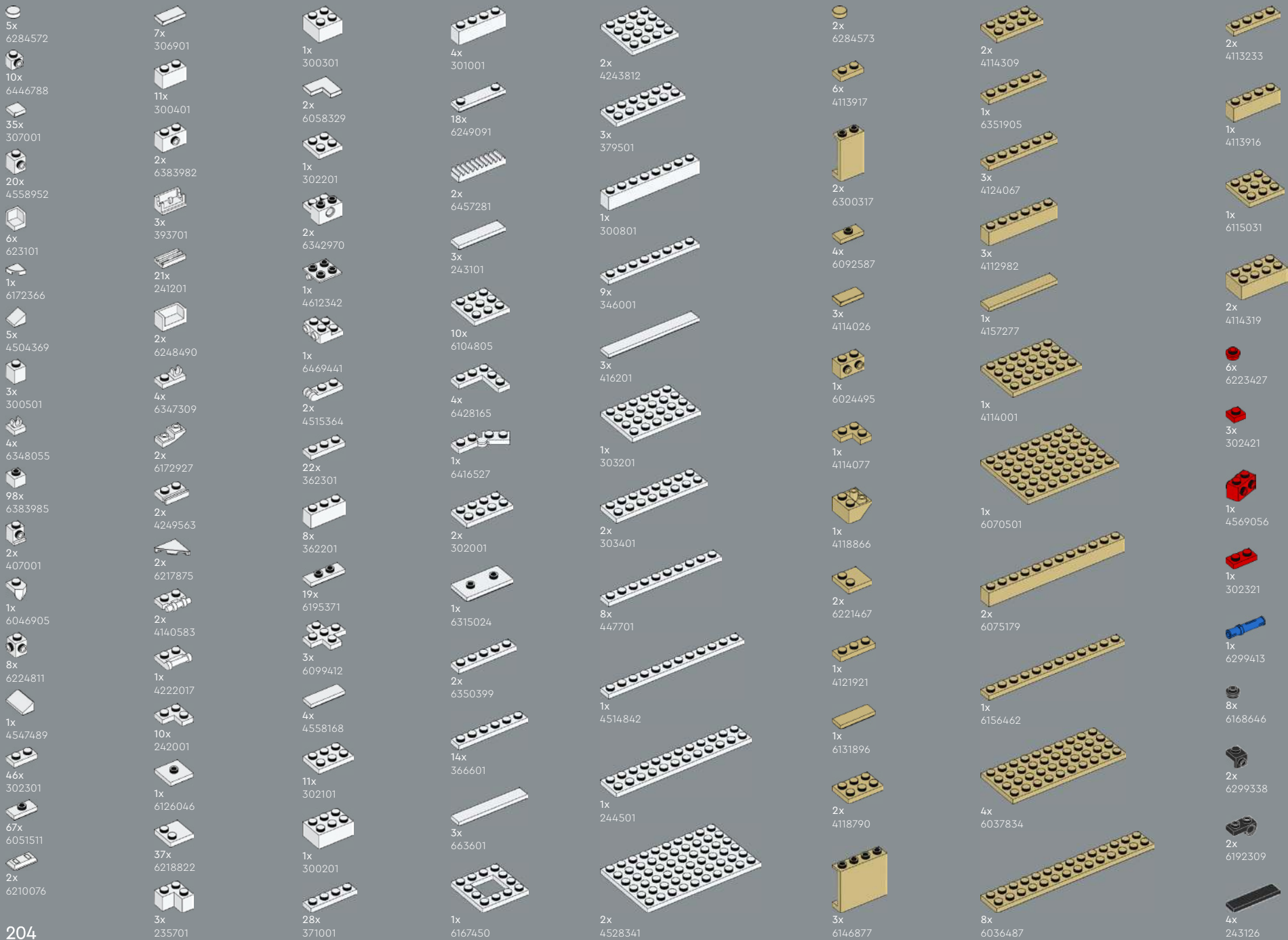

- 2x 302026
- 2x 617926
- 6x 379526
- 15x 416226
- 1x 6454242
- 1x 6454243
- 4x 395826
- 6x 303326
- 11x 6001494
- 1x 300528
- 16x 6269940
- 1x 4181135
- 1x 6240515
- 1x 6300322
- 4x 6273590
- 2x 6040126
- 7x 4549436
- 6x 6001824
- 1x 6055172
- 3x 6362967
- 2x 6231386
- 3x 6132767
- 23x 4528604
- 16x 4521914
- 4x 6092591
- 8x 4653509
- 12x 4496699
- 2x 6250168
- 1x 6328477
- 38x 6000852
- 5x 4616593
- 11x 6436361
- 4x 6398654
- 2x 6047415
- 8x 4255416
- 12x 4550168
- 2x 6310830
- 2x 4507045
- 2x 6126075
- 11x 6132768
- 5x 6015452
- 5x 6035540
- 1x 6328307
- 4x 4626904
- 9x 6175927
- 9x 6001822
- 10x 4247145
- 4x 4267874
- 3x 6164288
- 11x 4507047
- 16x 6015424
- 15x 4247151
- 3x 6156492
- 3x 6167894
- 14x 4246957
- 4x 6232137
- 1x 6096215
- 121x 6446790
- 10x 6411591
- 7x 6230571
- 1x 6099189
- 14x 6247894
- 8x 6303004
- 15x 6258333
- 2x 4616578
- 2x 6184432
- 3x 4655080
- 3x 6133896
- 3x 6423384
- 12x 6202626
- 2x 6069257
- 1x 6416003
- 4x 6100234
- 1x 6192923
- 4x 4633693
- 4x 6099187
- 4x 6186673
- 2x 4529242
- 4x 6215659
- 15x 4211288
- 11x 4211242
- 1x 4221744
- 1x 6348057
- 1x 6214343
- 1x 6238874
- 4x 6133765
- 4x 6248944
- 10x 6451002
- 3x 6261744
- 4x 4211150
- 4x 4211149
- 5x 4211151
- 1x 6092590
- 4x 6428805
- 4x 4211200
- 2x 4211210
- 1x 6221608
- 1x 4565394
- 6x 4508616
- 1x 4211189
- 10x 4211190
- 7x 6257604
- 3x 4211225
- 1x 4211186
- 7x 4221590
- 4x 4211193
- 4x 4216615
- 12x 4585337
- 2x 6313665
- 2x 6055145
- 2x 4211220
- 4x 4211152
- 1x 6251470
- 2x 4211415
- 2x 6308012
- 2x 6306729
- 2x 6163478
- 1x 4211732
- 13x 4211414
- 4x 4211398
- 16x 6066097
- 4x 4211350
- 2x 6092111
- 1x 4654580
- 2x 6065824

- 1x 6126082
- 1x 4211397
- 2x 4211349
- 1x 4211413
- 4x 4211881
- 1x 6438836
- 12x 4558169
- 12x 6211969
- 3x 4211429
- 16x 6171894
- 2x 4211356
- 5x 6257593
- 2x 4211445
- 5x 4560183
- 2x 4211395
- 1x 4211385
- 2x 4211549
- 4x 4211795
- 5x 4211481

- 1x 4211407
- 4x 4211408
- 6x 4211405
- 6x 4662161
- 4x 6058221
- 6x 6452882
- 1x 6252667
- 2x 6226792
- 1x 6223039
- 36x 6212501
- 4x 6388120
- 4x 4529240
- 2x 6439040
- 1x 4211407
- 4x 4211408
- 6x 4211405
- 4x 6058221
- 6x 6452882
- 1x 6252667
- 2x 6226792
- 1x 6223039
- 36x 6212501
- 4x 6388120
- 4x 4529240
- 2x 6439040

- 2x 6192569
- 2x 6395635
- 4x 4210848
- 9x 4210719
- 2x 6344022
- 6x 4504378
- 2x 6199549
- 2x 6221607
- 4x 6388119
- 1x 4226221
- 6x 4567887
- 29x 6331866
- 20x 6092572
- 12x 4211063
- 6x 4211052
- 2x 4211066
- 2x 4211135

- 3x 6000606
- 9x 4543086
- 20x 6446785
- 1x 6310596
- 12x 6126083
- 6x 6446786
- 1x 4211094
- 43x 6309059
- 2x 4210702
- 18x 6247784
- 1x 6232193
- 21x 6447212
- 4x 4210635
- 1x 4211055
- 60x 6343852
- 8x 4568734

- 1x 4211043
- 3x 6187008
- 4x 4211053
- 3x 4648256
- 2x 6039176
- 41x 6307616
- 6x 4560184
- 3x 4211127
- 10x 6189120
- 4x 4210651
- 2x 4211056
- 2x 6321746
- 1x 6230281

- 2x 4210998
- 1x 4211008
- 1x 4210997
- 1x 4211061
- 2x 6133611
- 1x 6000970
- 1x 6231376
- 2x 6215447
- 3x 6093529
- 25x 6315780
- 3x 6259071
- 4x 6194729
- 3x 4519970



 [LEGO.com/service](https://www.LEGO.com/service)



# YOU COULD WIN



## YOU COULD WIN

Your feedback will help shape the future development of this product series.

Visit:

## DU KÖNNTEST GEWINNEN

Dein Feedback trägt zur Weiterentwicklung dieser Produktreihe bei.

Geh auf:

## VOUS POURRIEZ GAGNER

Vos commentaires nous aideront à concevoir les futurs produits de cette gamme.

Visitez :

## POTRESTI VINCERE TU

La tua opinione ci aiuterà a migliorare la creazione futura di questa linea di prodotti.

Visita:

## PUEDES GANAR

Tu opinión contribuirá al futuro de esta serie de productos.

Visita:

## 轻松获奖

您的反馈将有助于我们在今后改进本产品系列。

请访问:

---

**[LEGO.com/productfeedback](https://www.lego.com/productfeedback)**

---

You also have the chance to win a LEGO® set.

Terms and conditions apply.\*

Außerdem hast du die Chance, ein LEGO® Set zu gewinnen.

Es gelten die Teilnahmebedingungen.\*

Vous pourriez également gagner un ensemble LEGO®.

Des conditions s'appliquent.\*

Hai anche la possibilità di vincere un set LEGO®.

Termini e condizioni sono applicabili.\*

También tienes la oportunidad de ganar un set LEGO®.

Aplican términos y condiciones.\*

您还有机会赢取乐高®套装。

条款和条件适用。\*

\*[LEGO.com/productfeedback-terms](https://www.lego.com/productfeedback-terms)

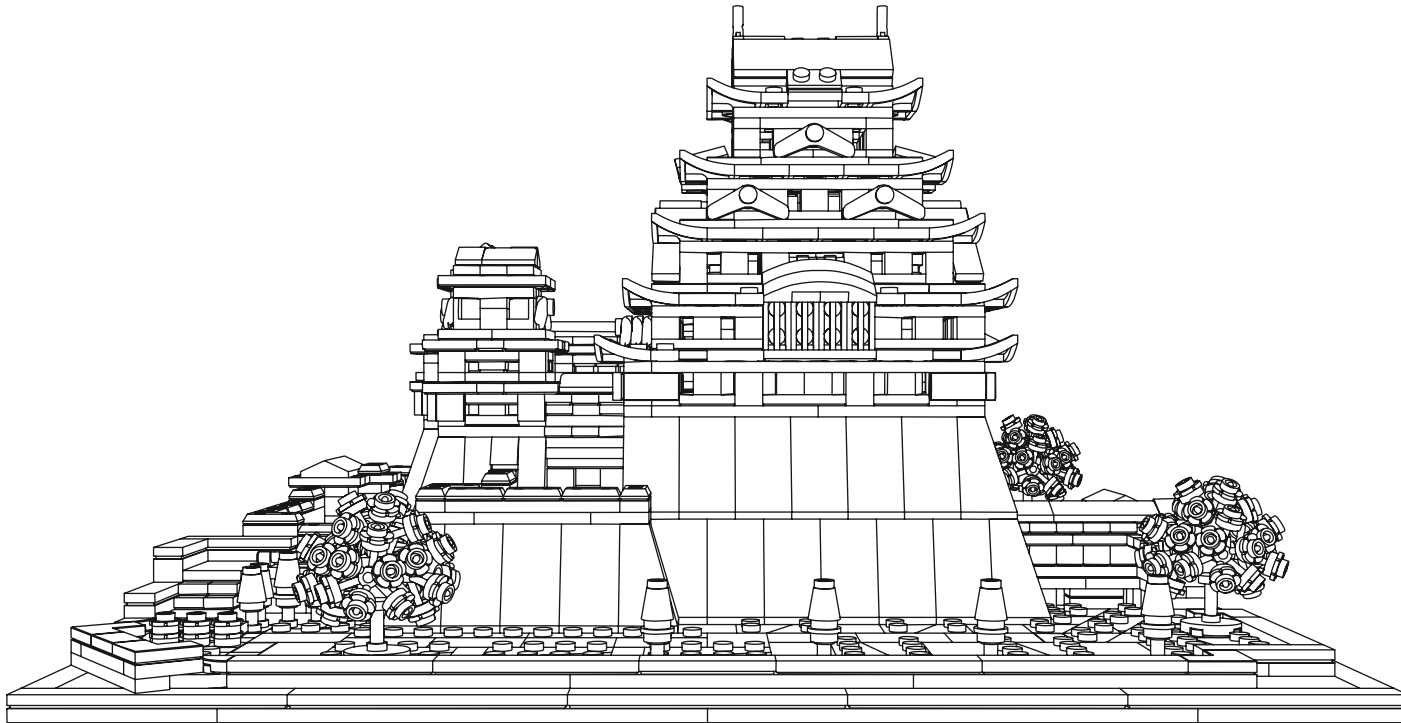

LEGO and the LEGO logo are trademarks of the LEGO Group. ©2023 The LEGO Group.

Adam Reed Tucker is the co-developer of the LEGO® Architecture product line.

6493762