

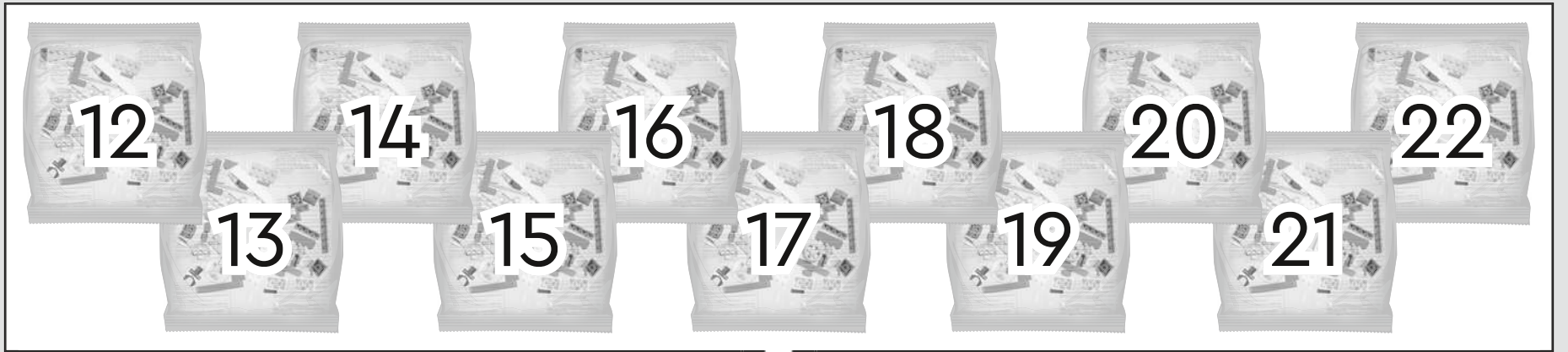

Harry Potter



WIZARDING  
WORLD





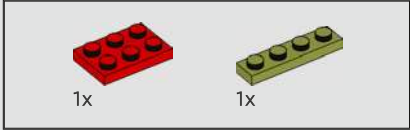
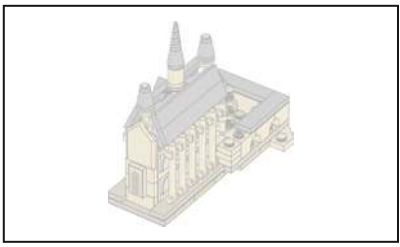

309

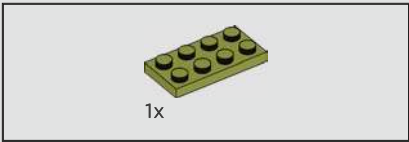
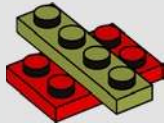

310

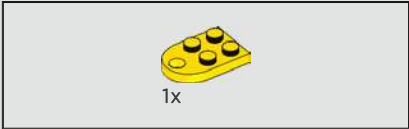

311



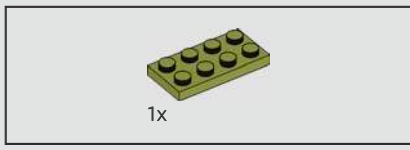

312

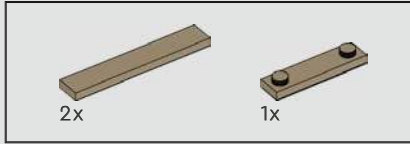

313

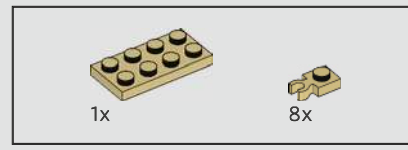
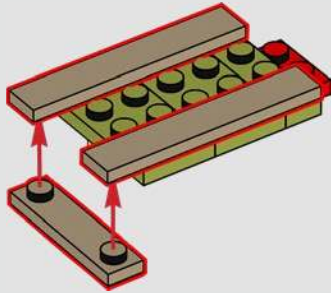

314

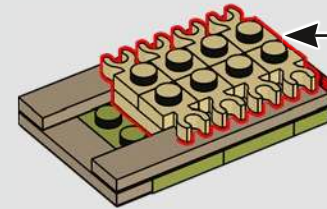
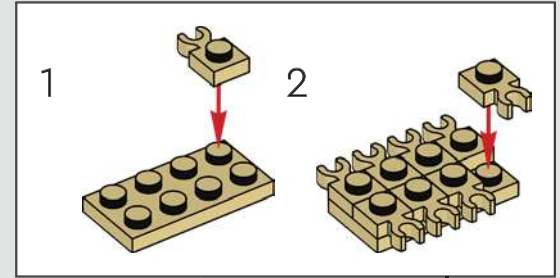

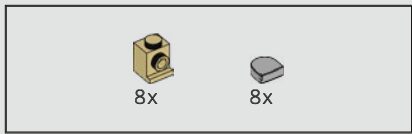

315

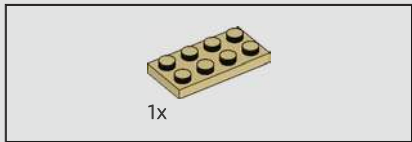
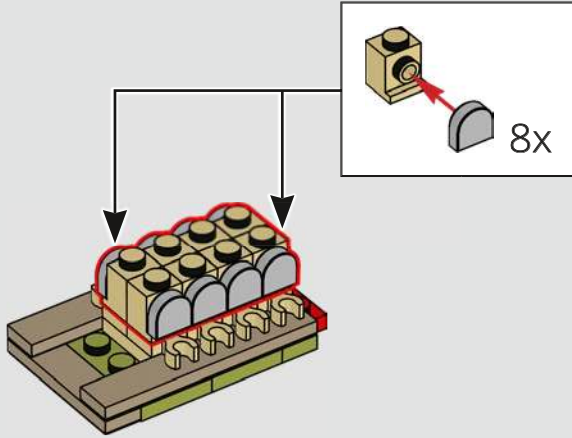

316

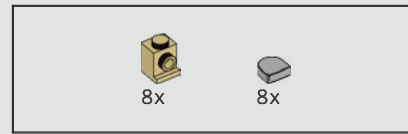
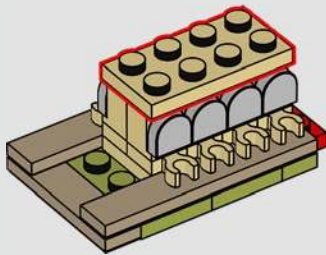

317

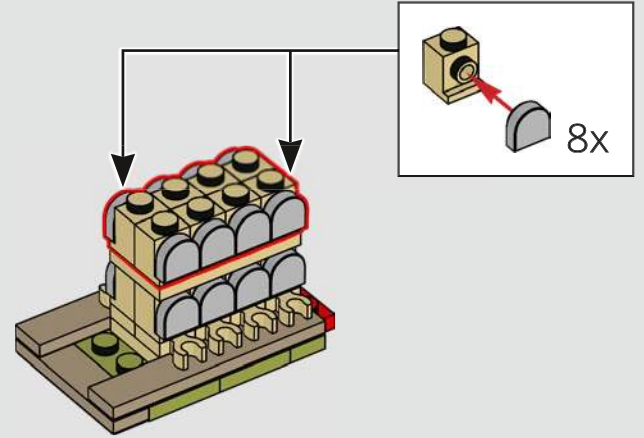

318

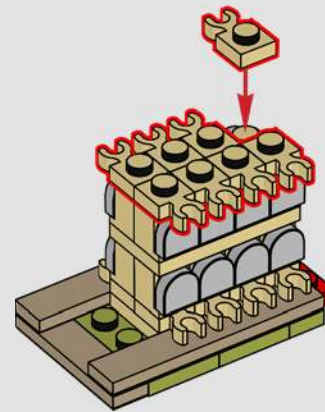



319

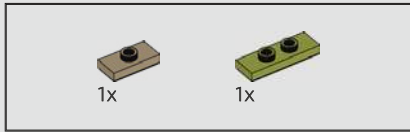
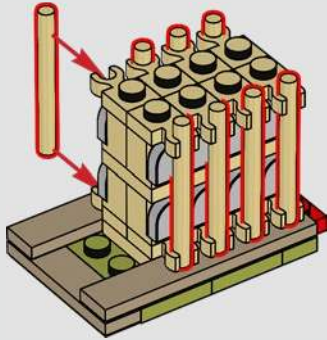

320

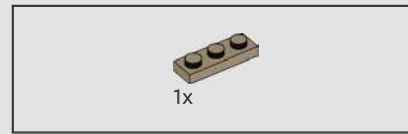
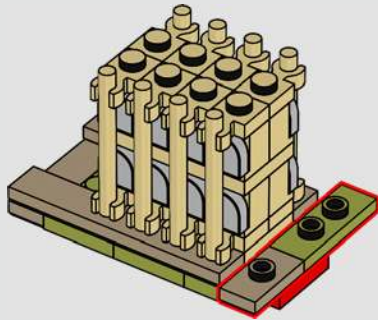

321

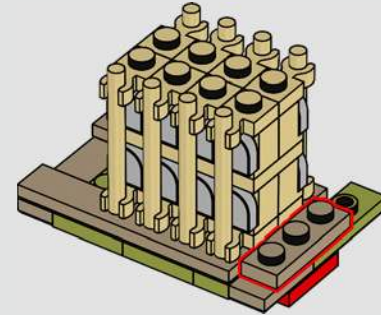

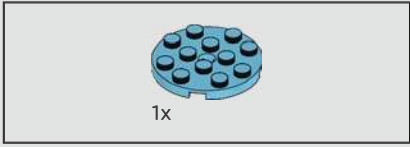

322

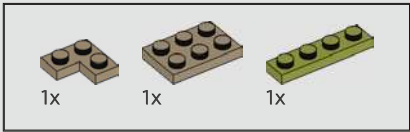
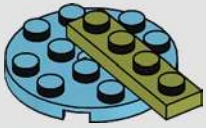

323

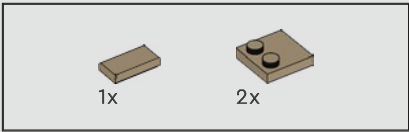

324

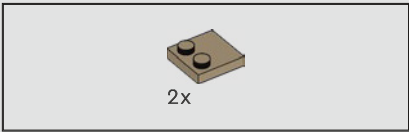
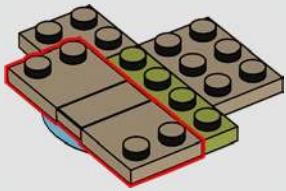

325

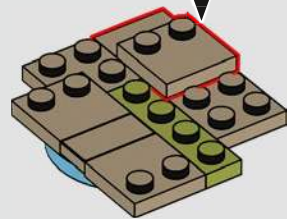
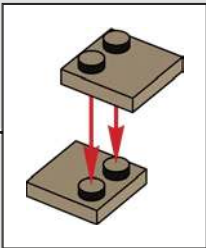

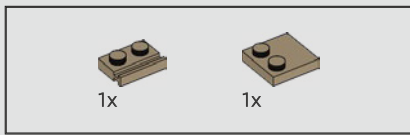

326

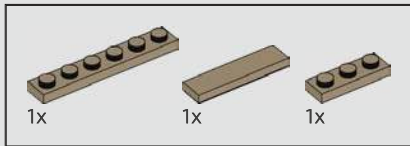
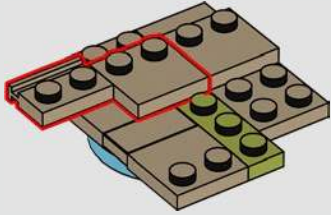

327

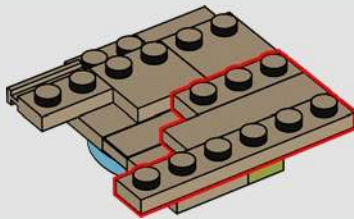

328

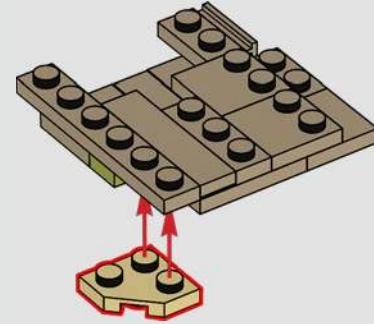

329

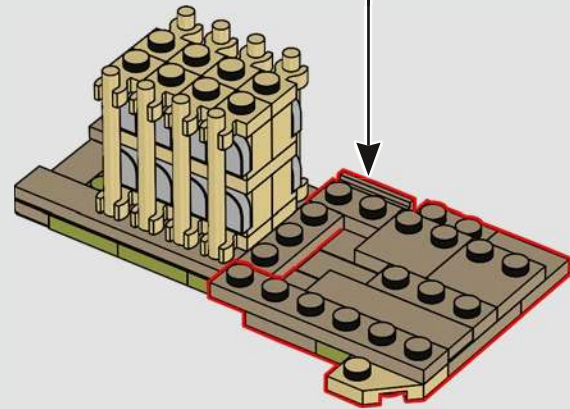

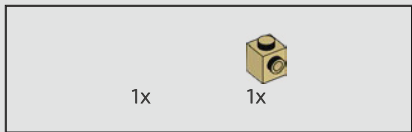

330

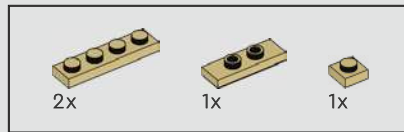
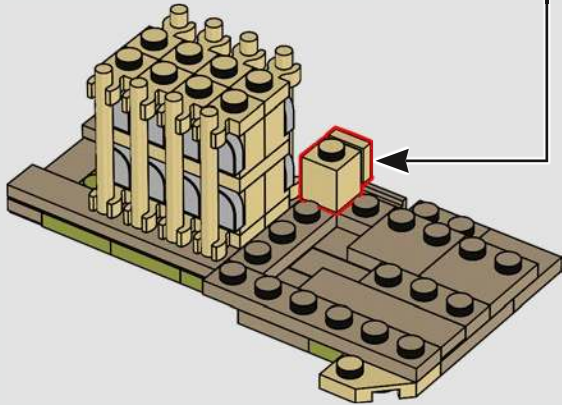
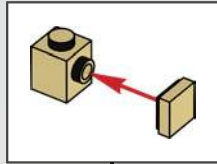

331

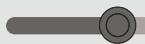
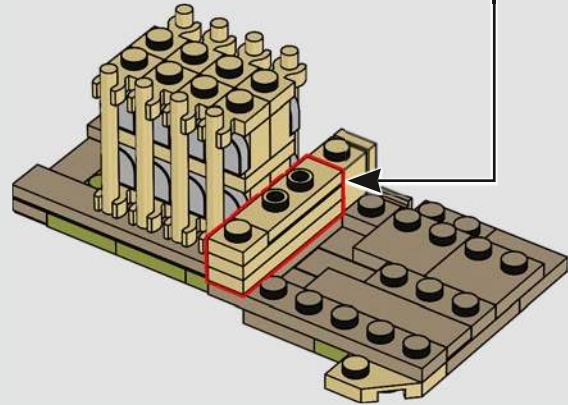
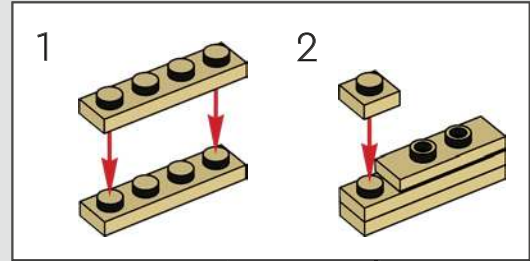

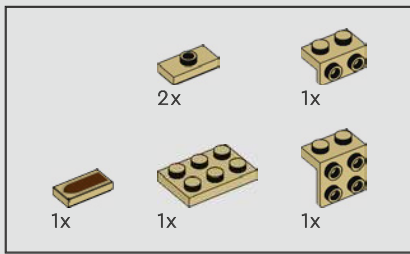

332

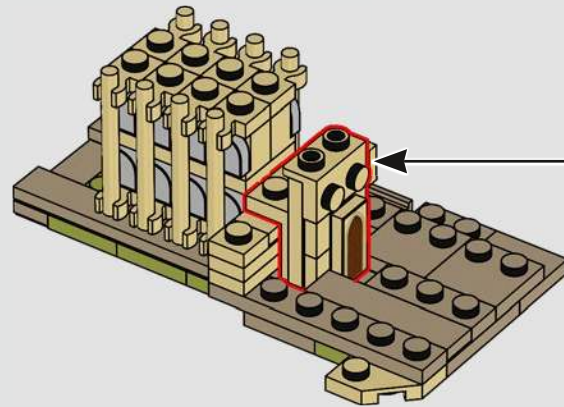
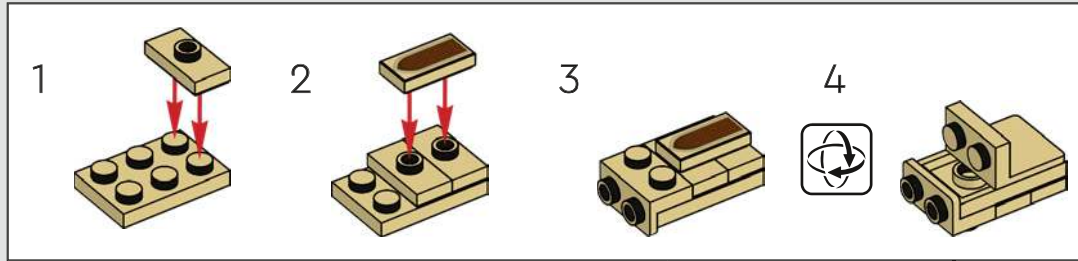



333

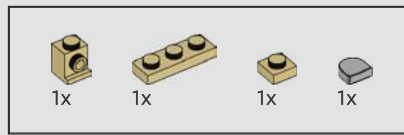
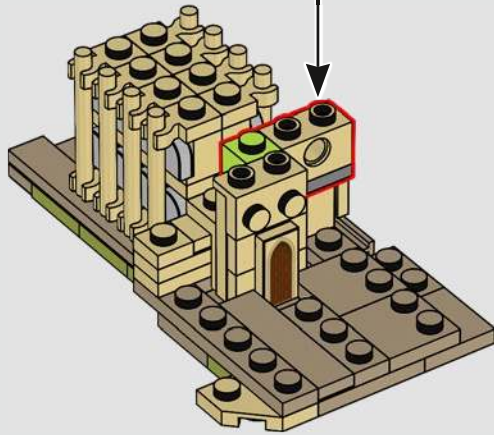
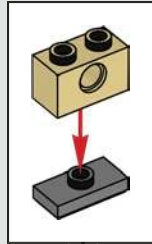

334

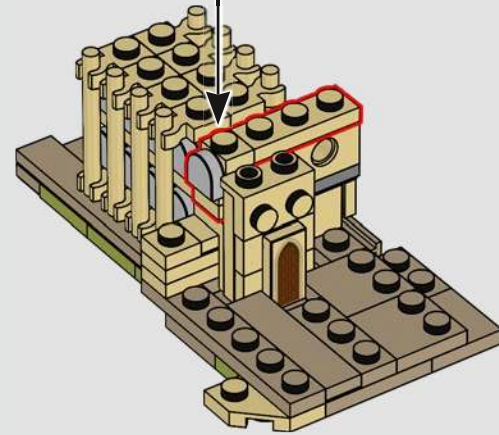
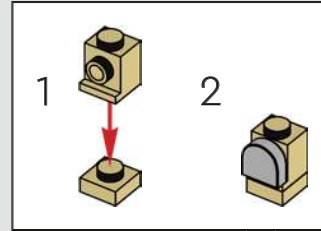



335

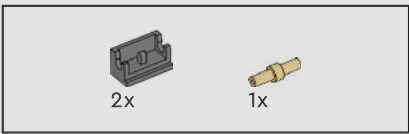
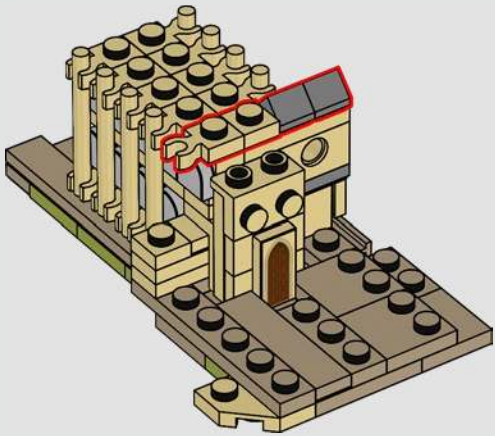

336

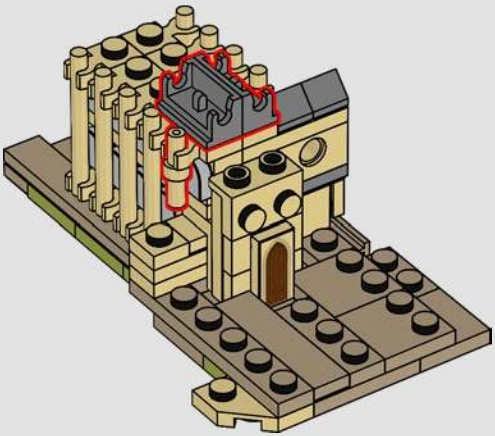

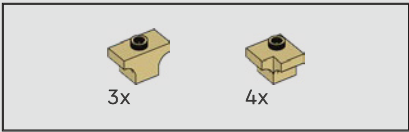

337

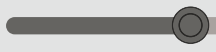
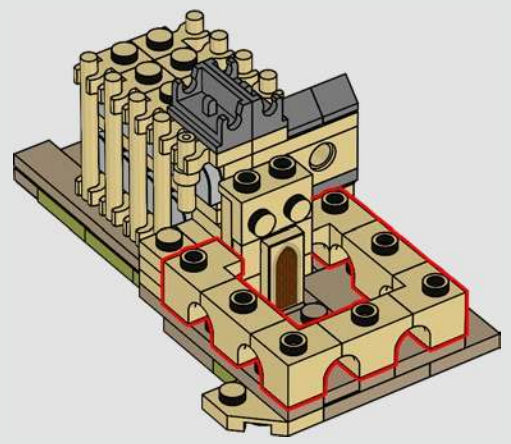

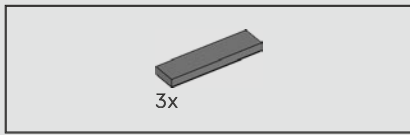

338

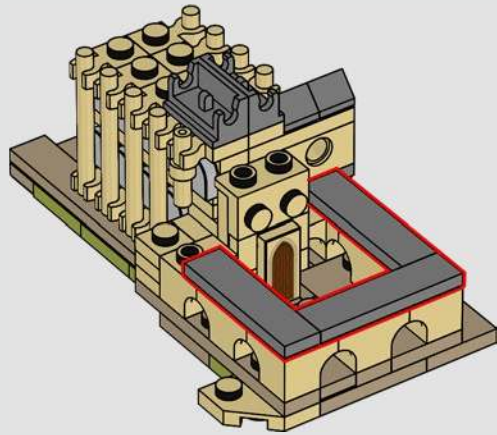

339

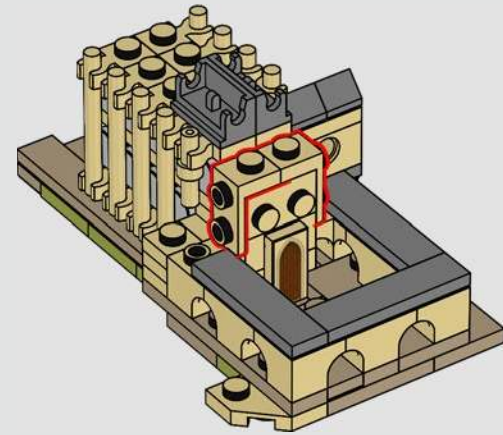



340

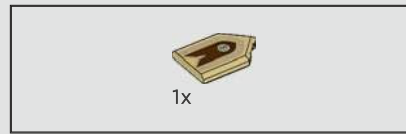
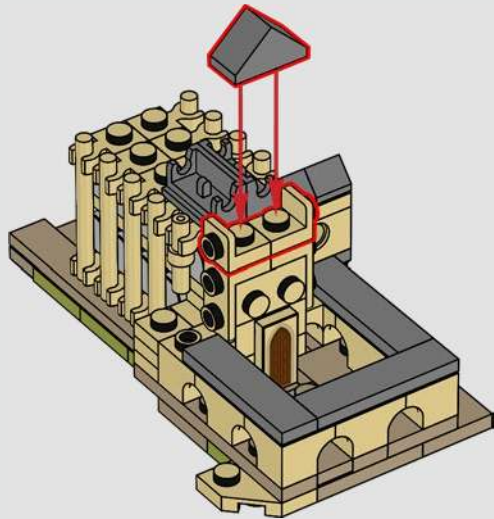

341

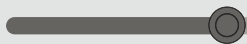
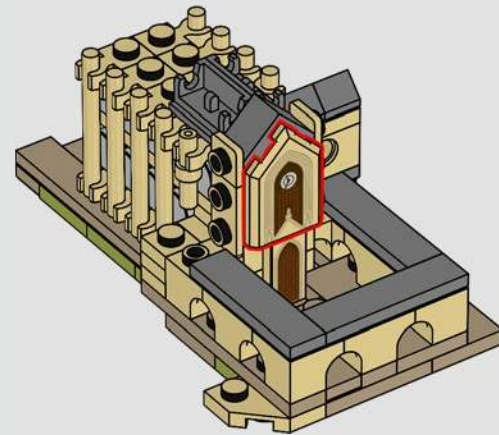

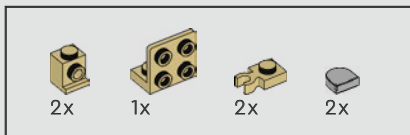

342

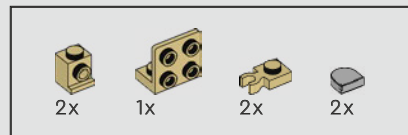
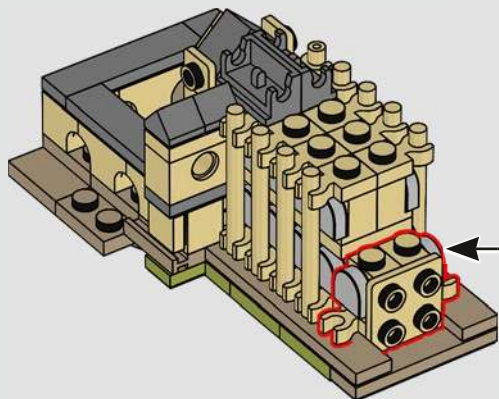
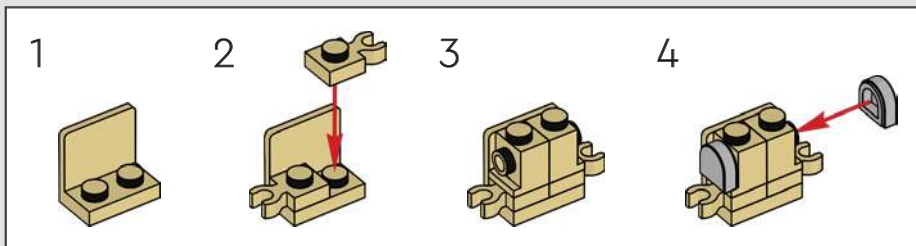

343

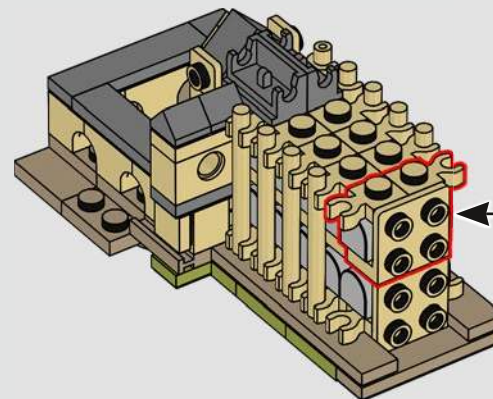
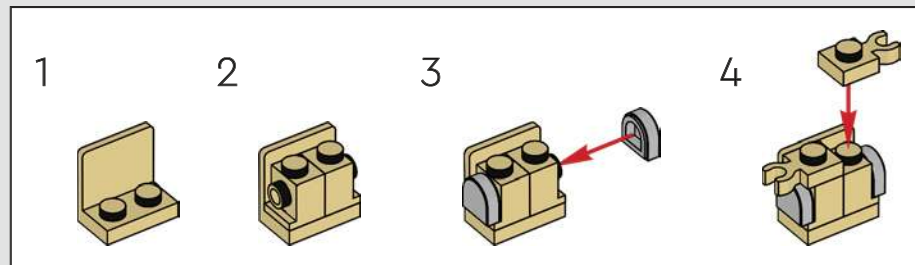



344

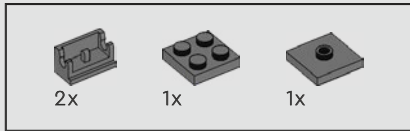
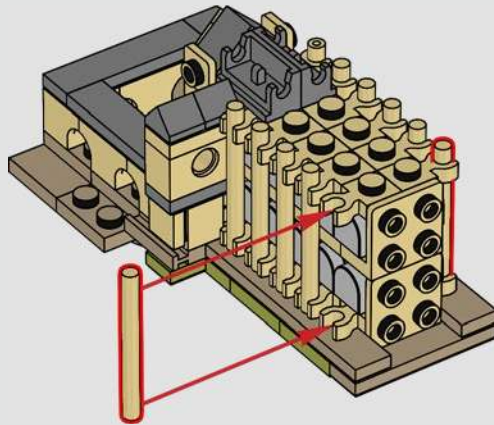

345

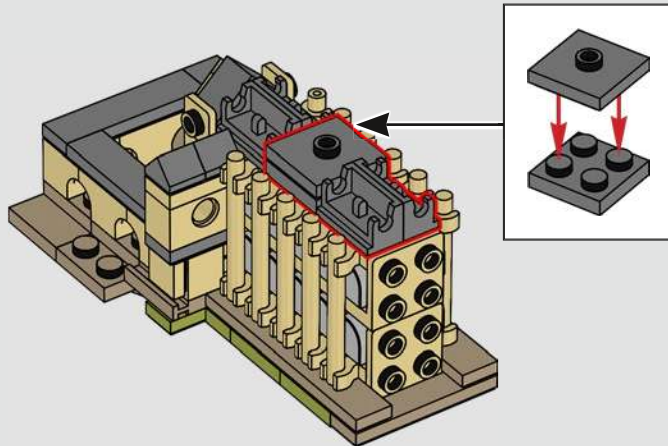

346

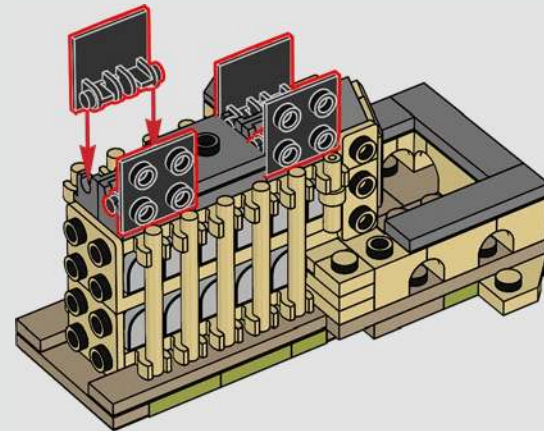

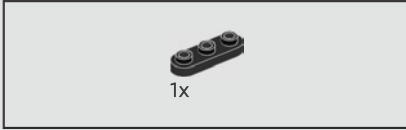

1x

347

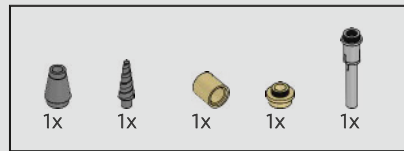

348

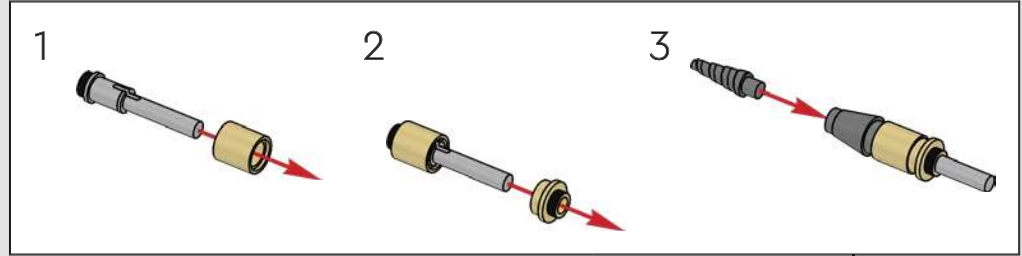



349

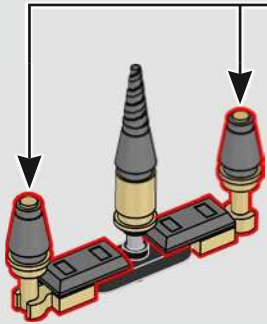
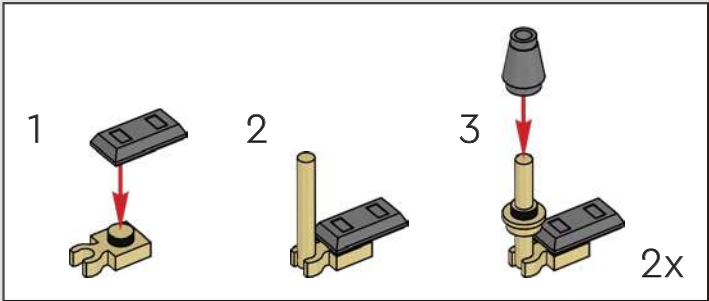

350

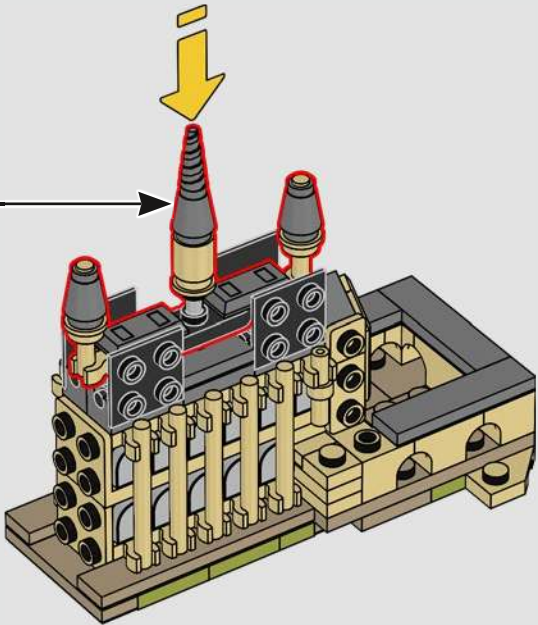

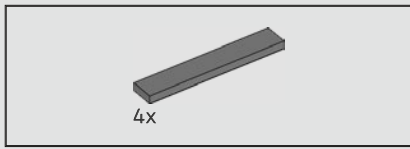

351

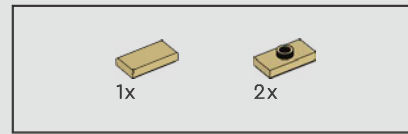
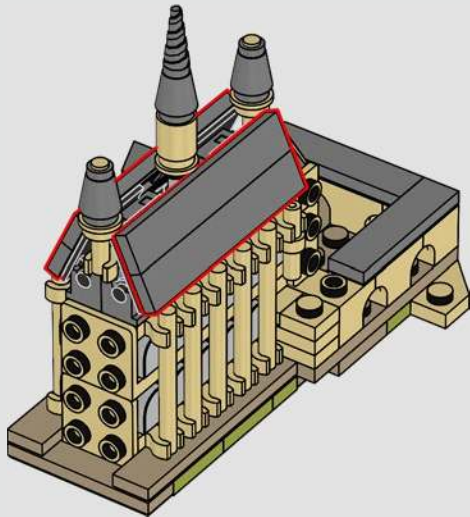

352

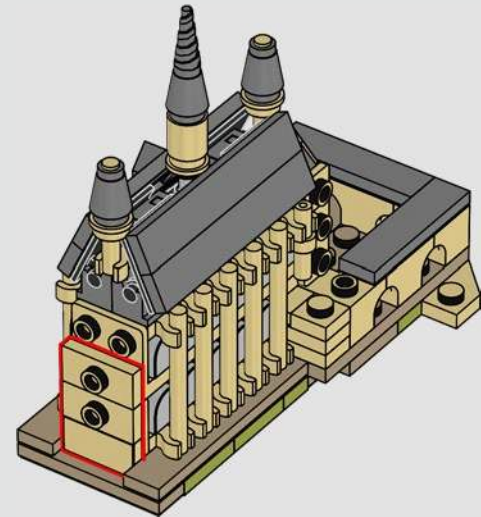

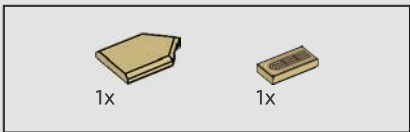

353

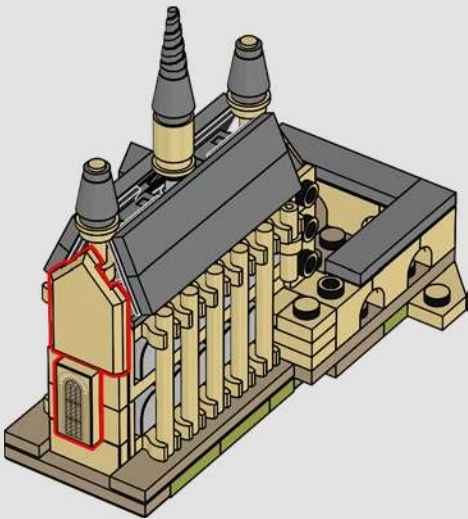

The ceiling in the Great Hall can be enchanted to mimic the night sky.

354



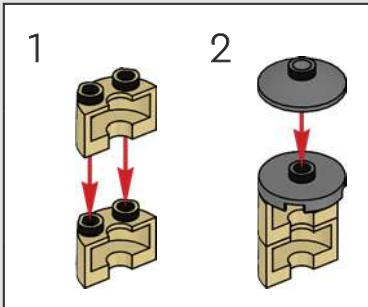
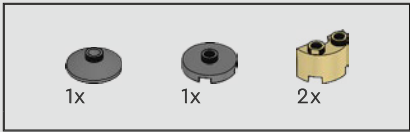

355



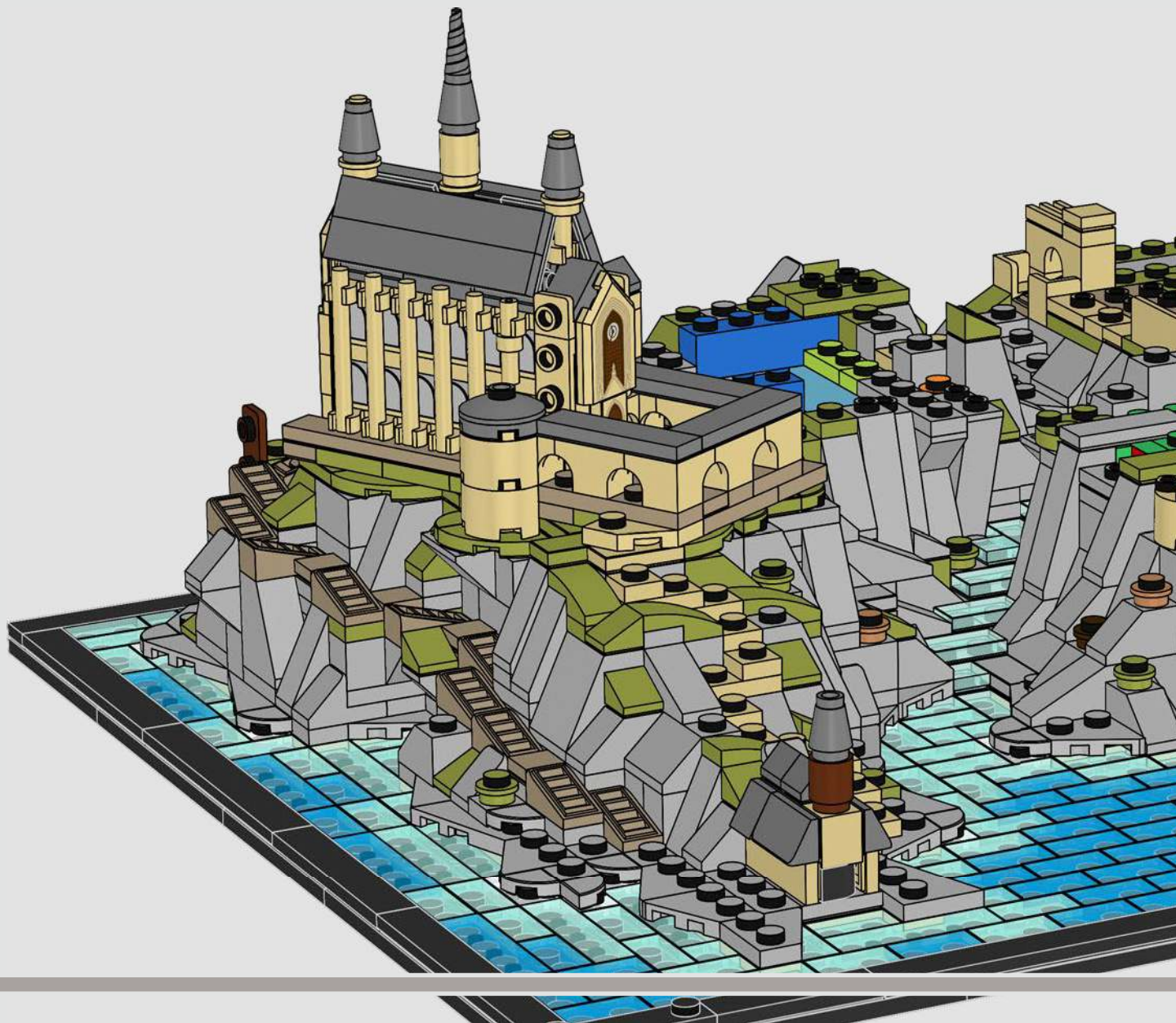

Immediately after arriving at Hogwarts™, first-year students are shown to the Great Hall where The Sorting Hat™ determines which house will be their home away from home.



356



The trees are built with LEGO® crystal and ice cream elements (and a little magic).

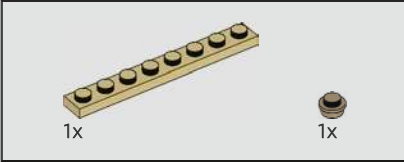

357



358

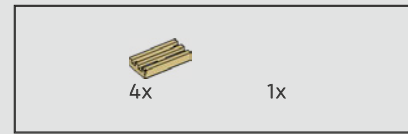
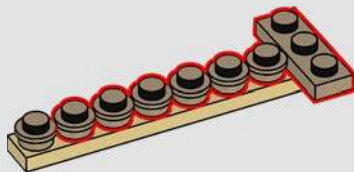

359

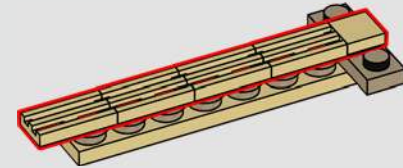

360

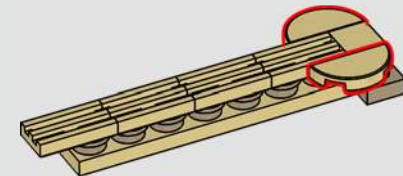

8x

361

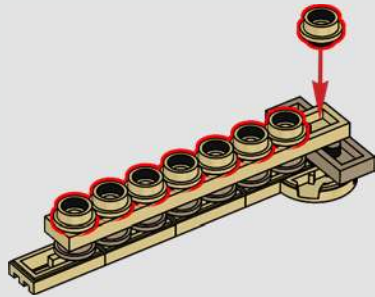

2x

362

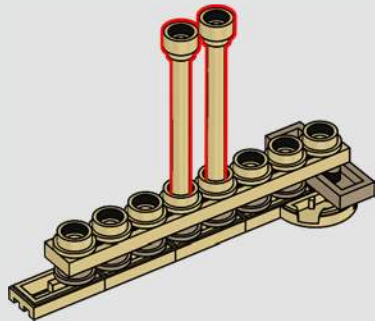

2x

3x

363

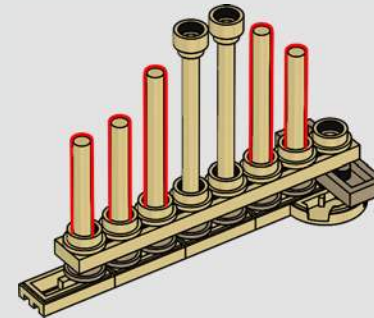

364



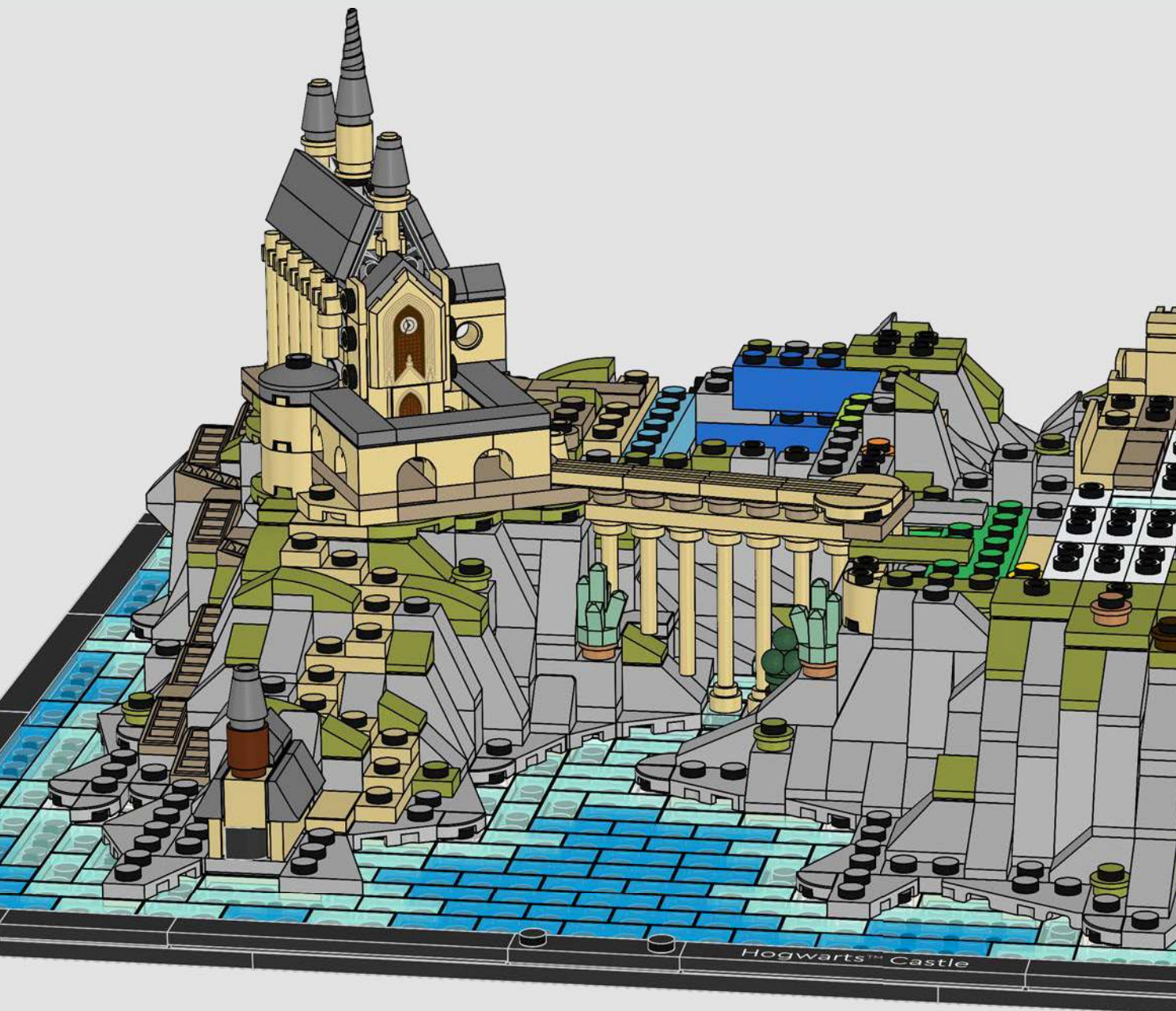

The Viaduct Bridge is not only iconic to the Hogwarts™ silhouette, but is also a central location during the Battle of Hogwarts: when Professor McGonagall™ enchants the suits of armour to do their duty to the school by protecting everyone inside, they head towards the bridge. It is also the setting for a key moment during the First Task of the Triwizard Tournament, when the Hungarian Horntail soars underneath it to chase Harry.



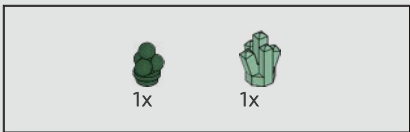

365

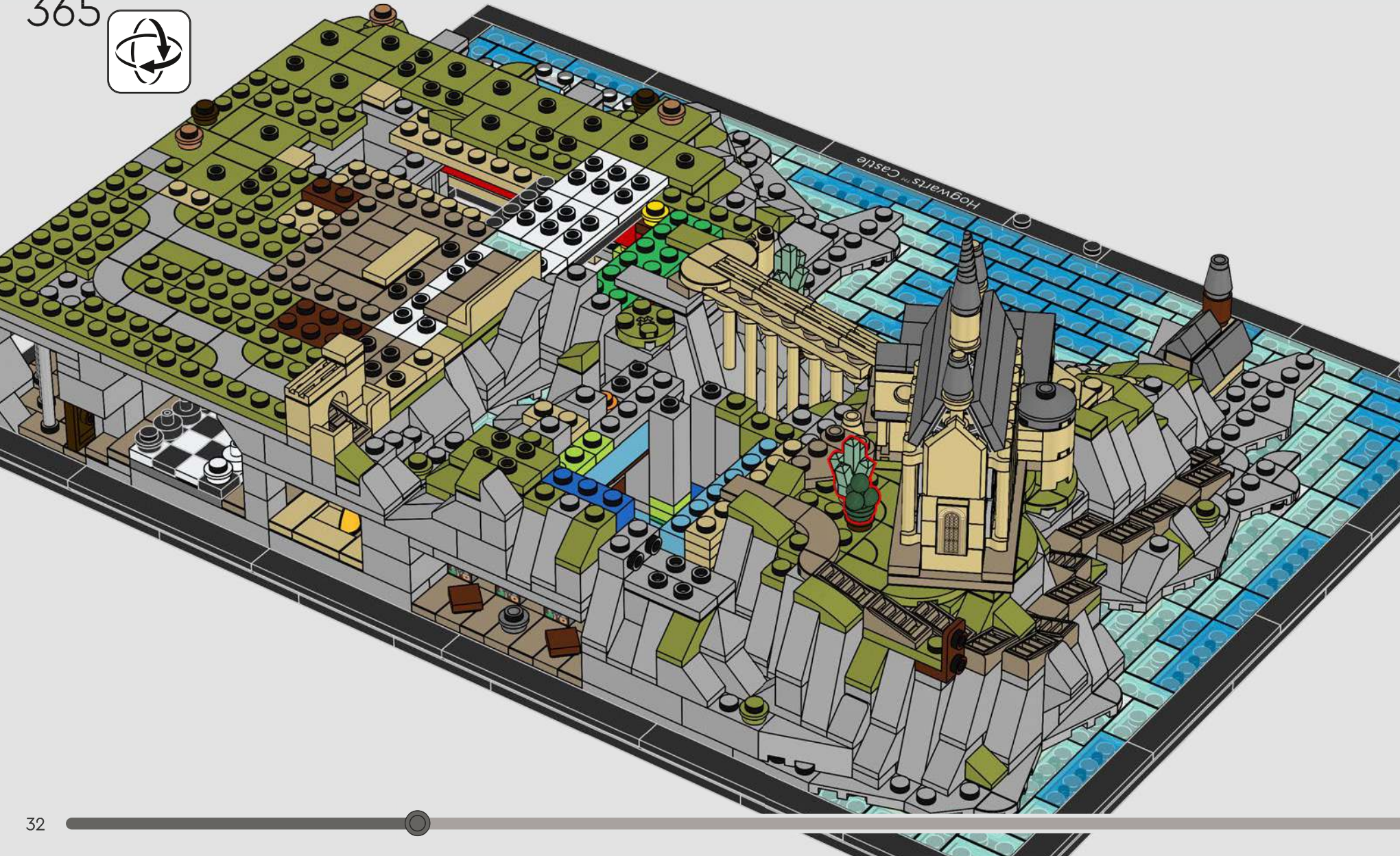



2x

366

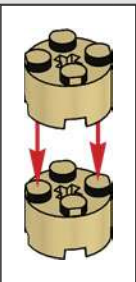
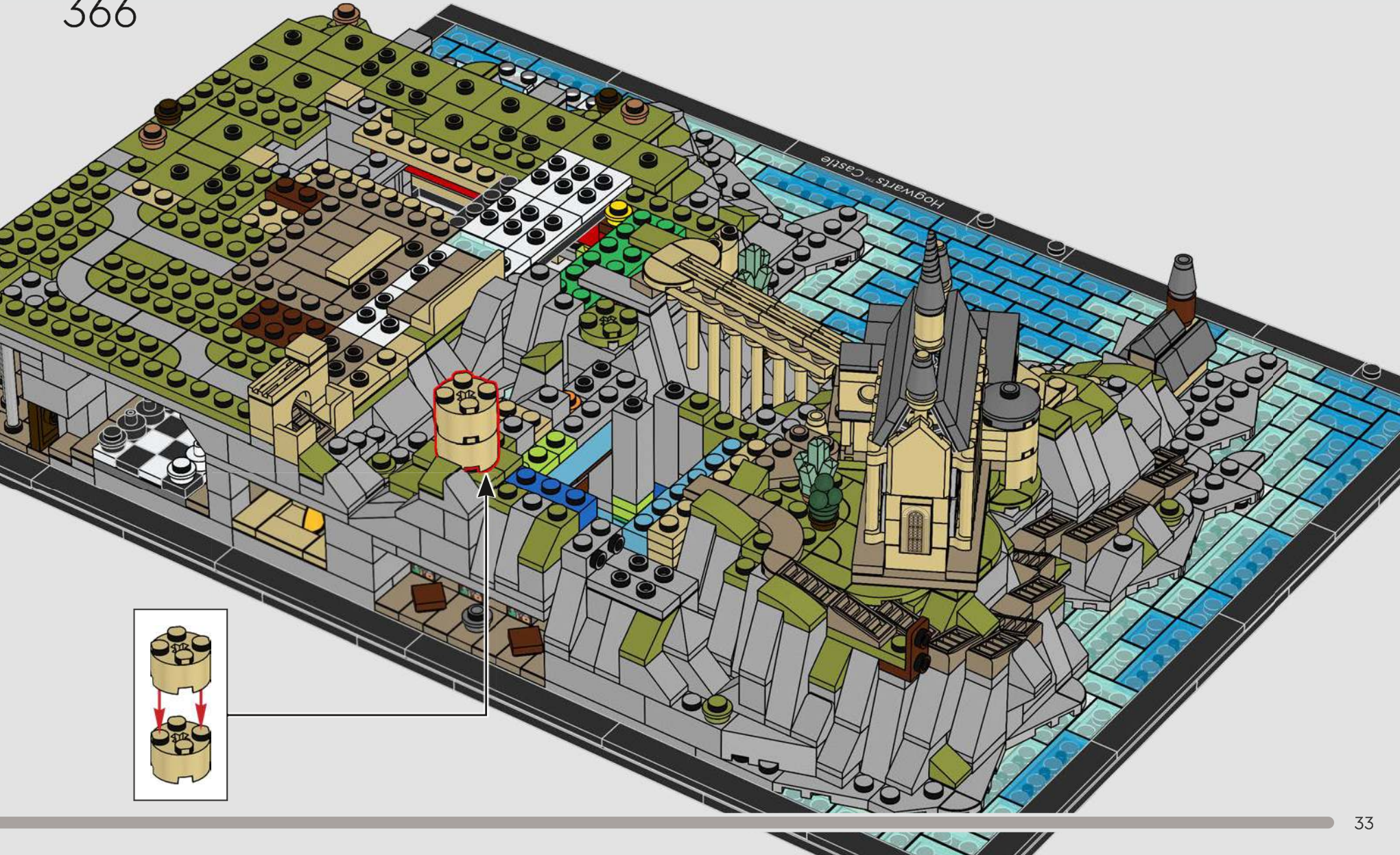

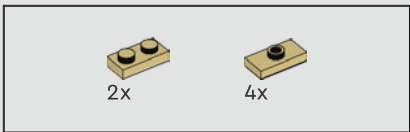

367

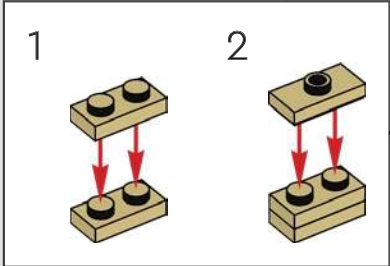
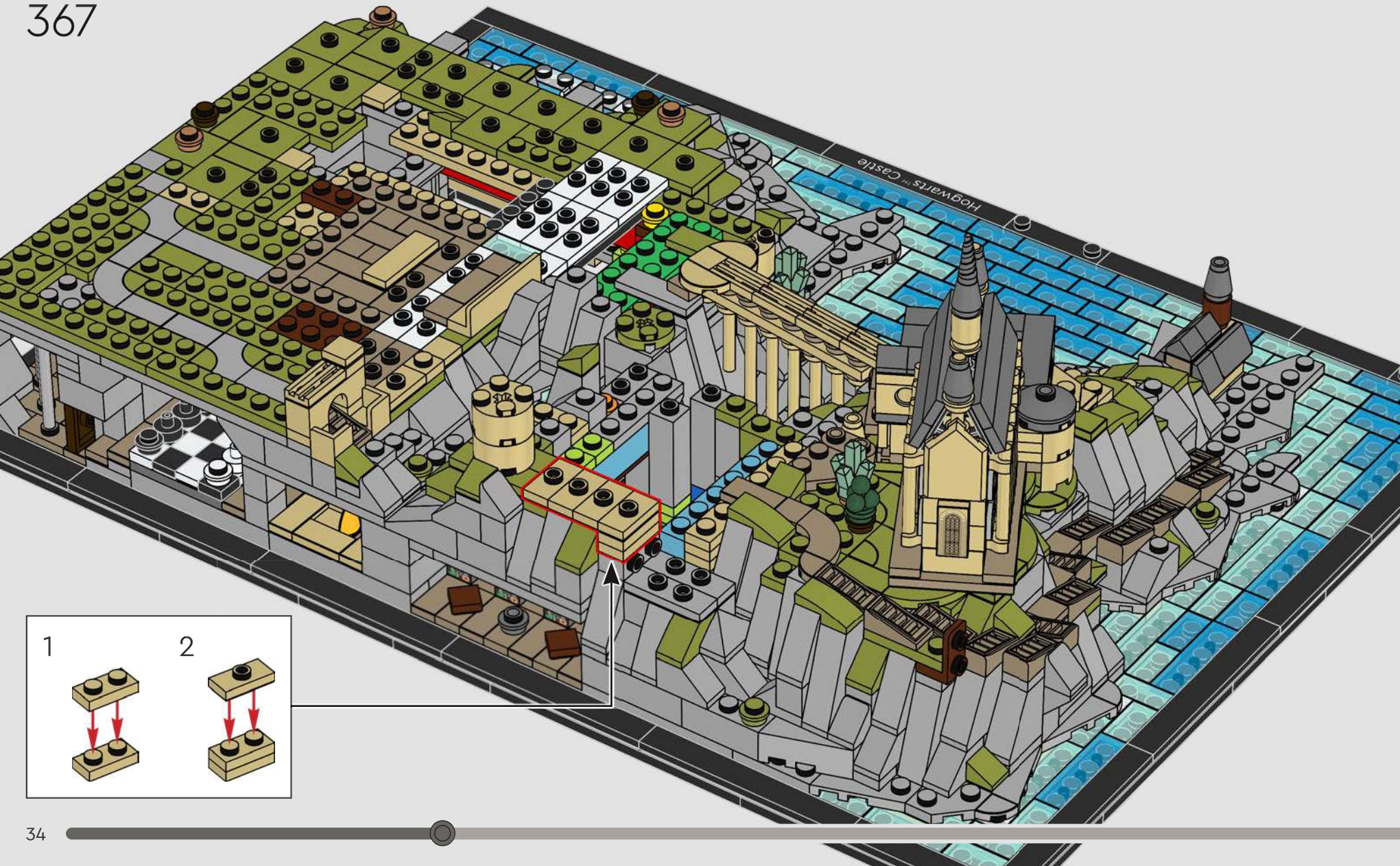

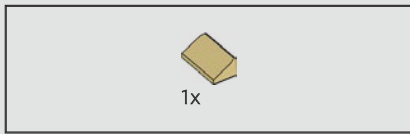

368

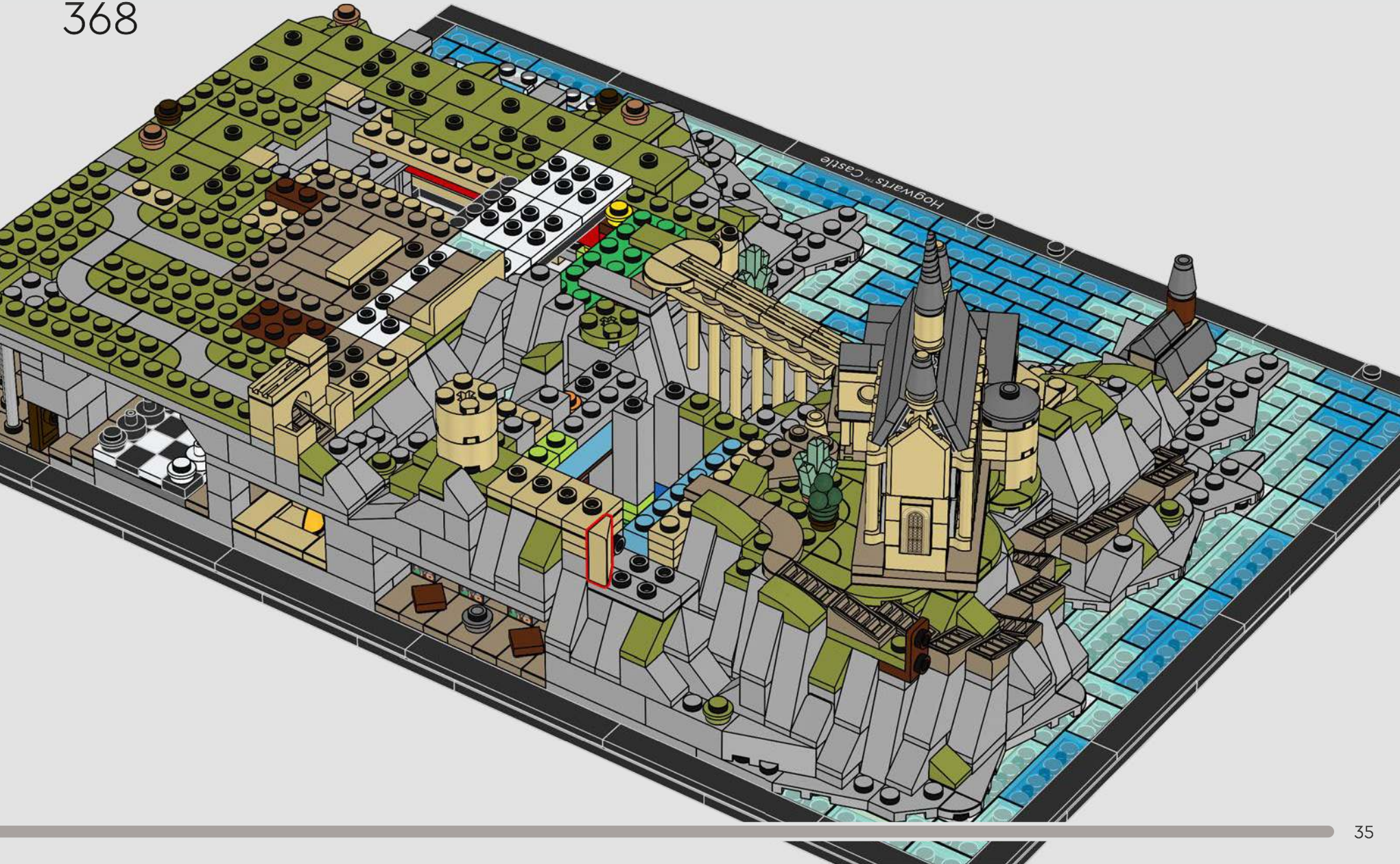

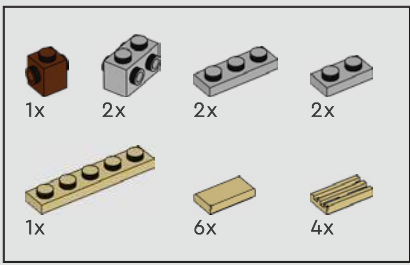

369

1

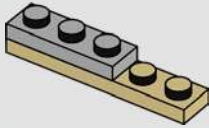

2

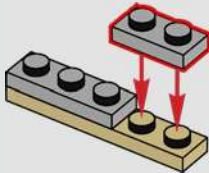

3

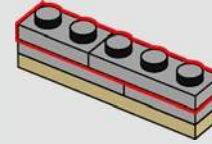

4

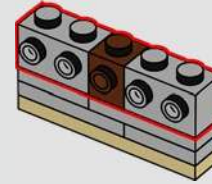

5

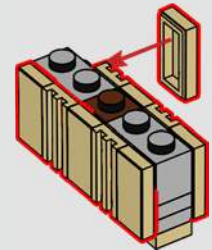

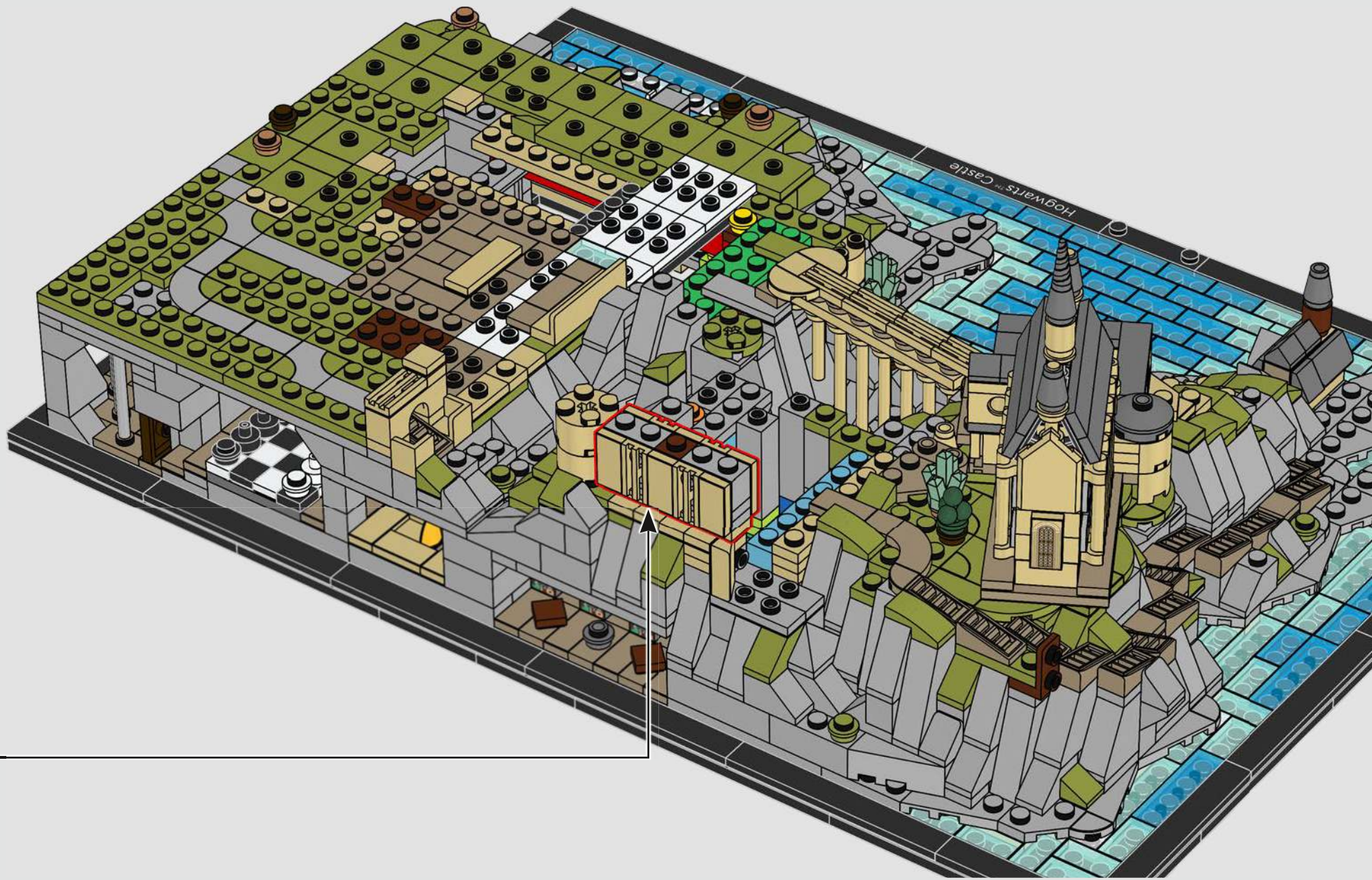

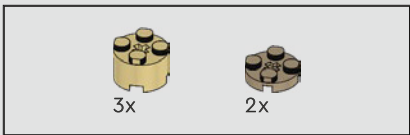

370

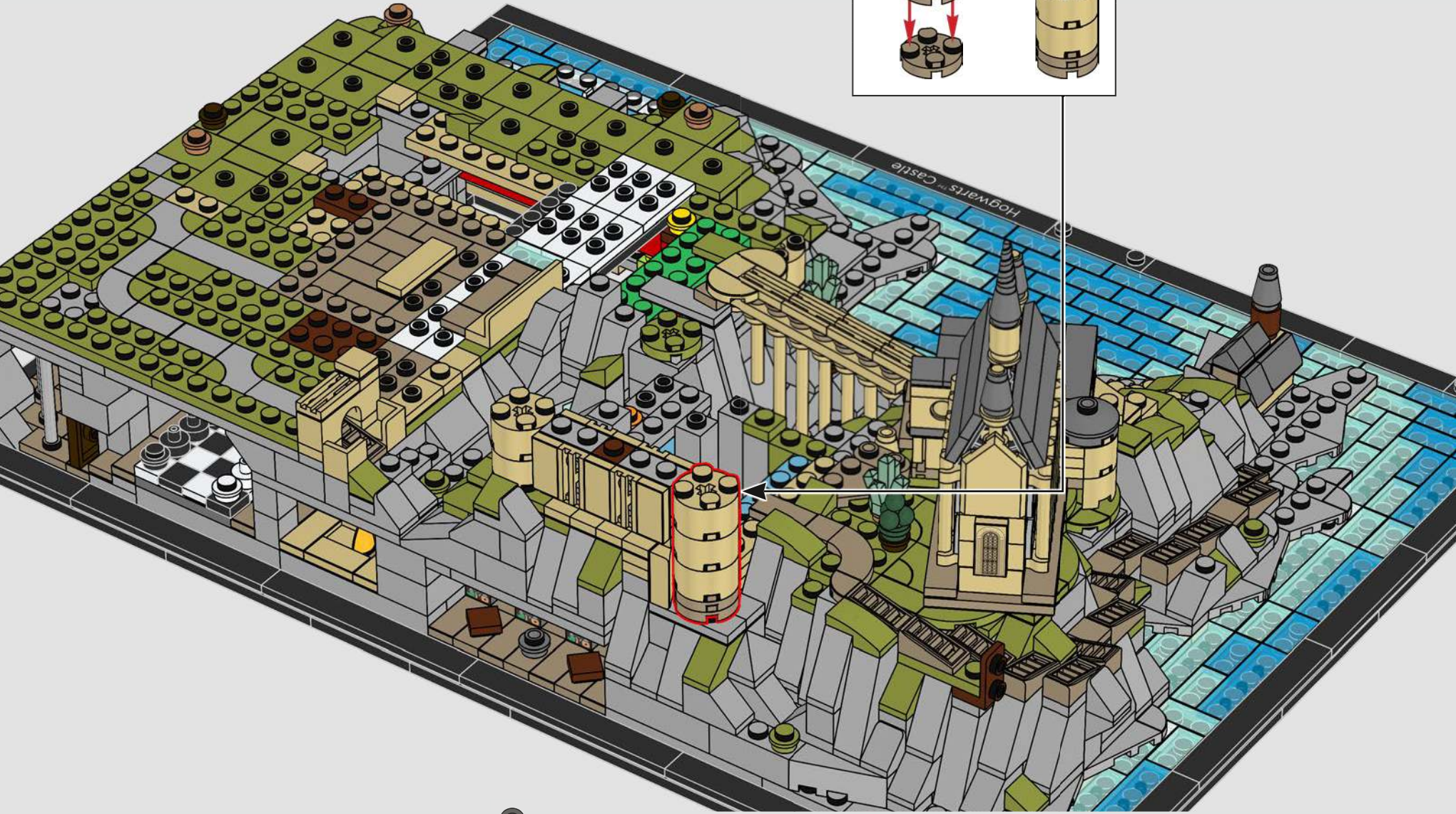
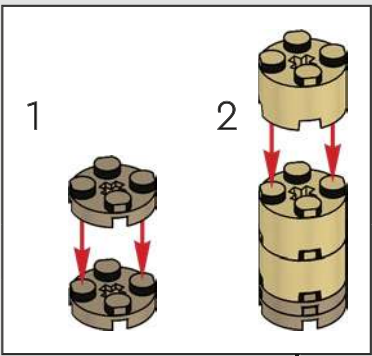

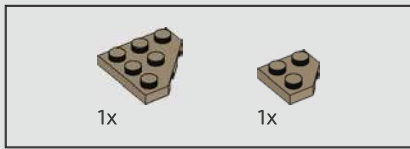

371

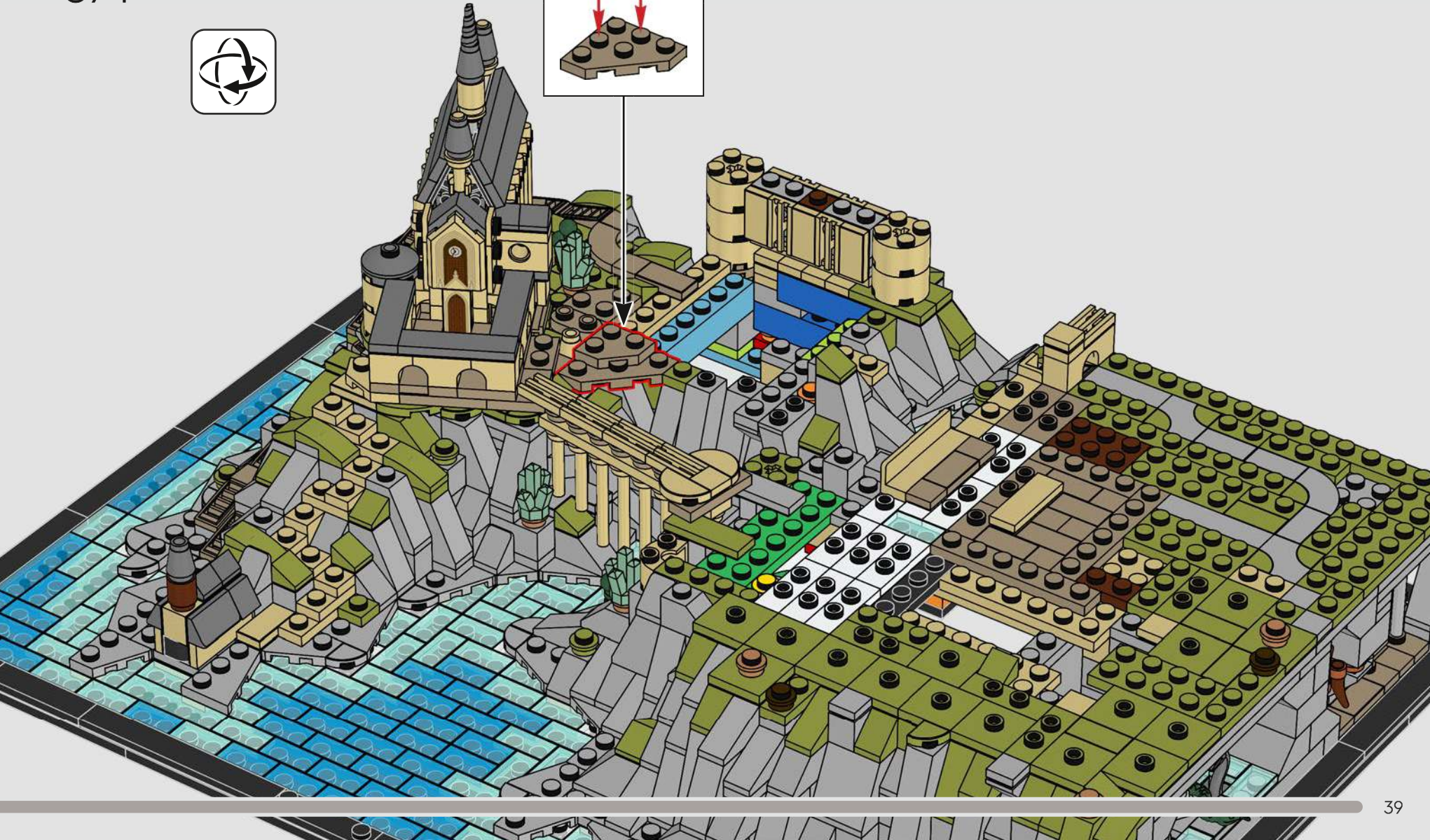
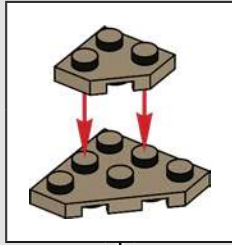

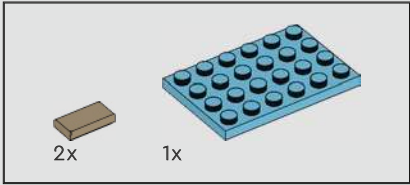
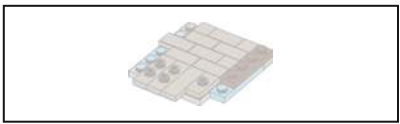

372

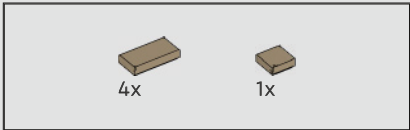
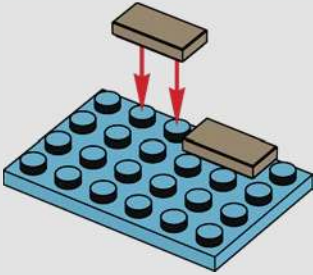

373

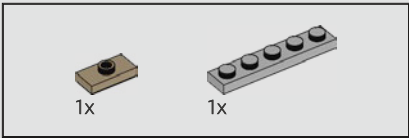
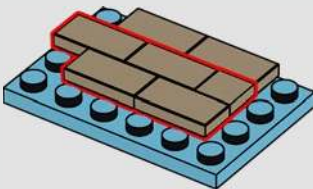

374

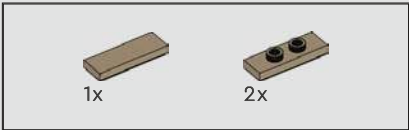
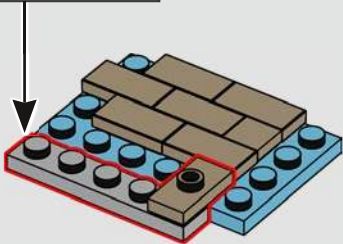
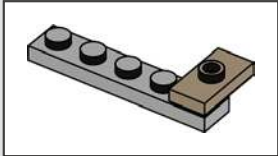

375

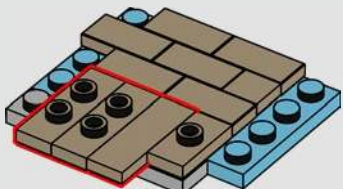

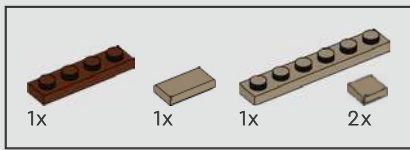

376

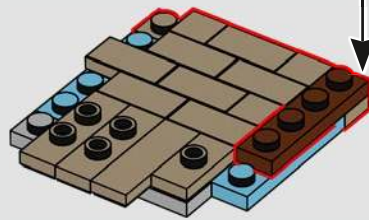
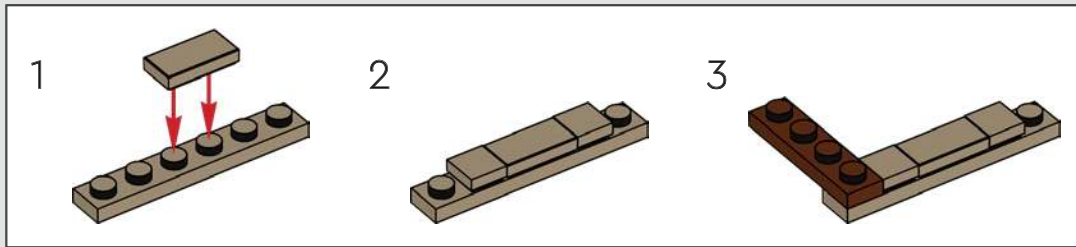

377



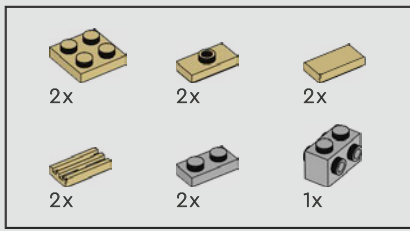

378

1

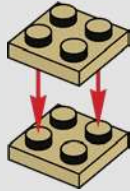

2

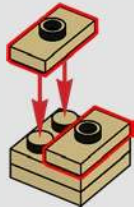

3

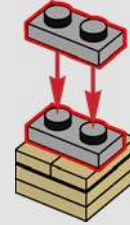

4



5

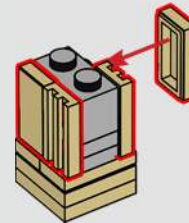



Hogwarts™ Castle

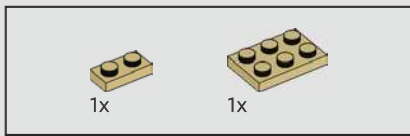

379

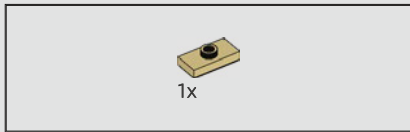
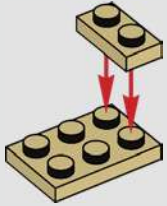

380

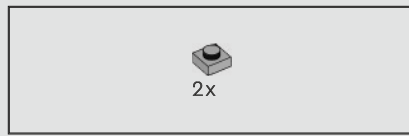

381

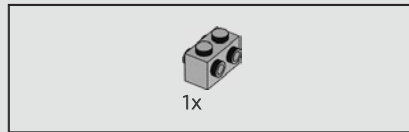
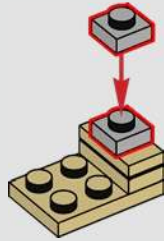

382

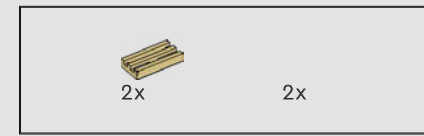
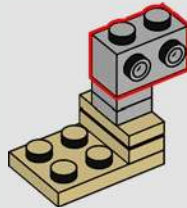

383

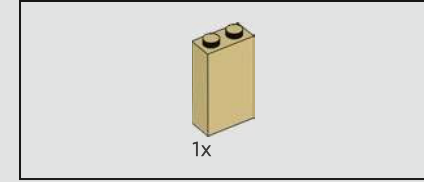
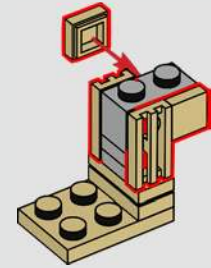

384

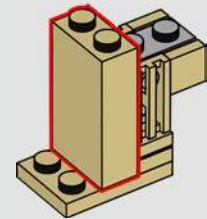

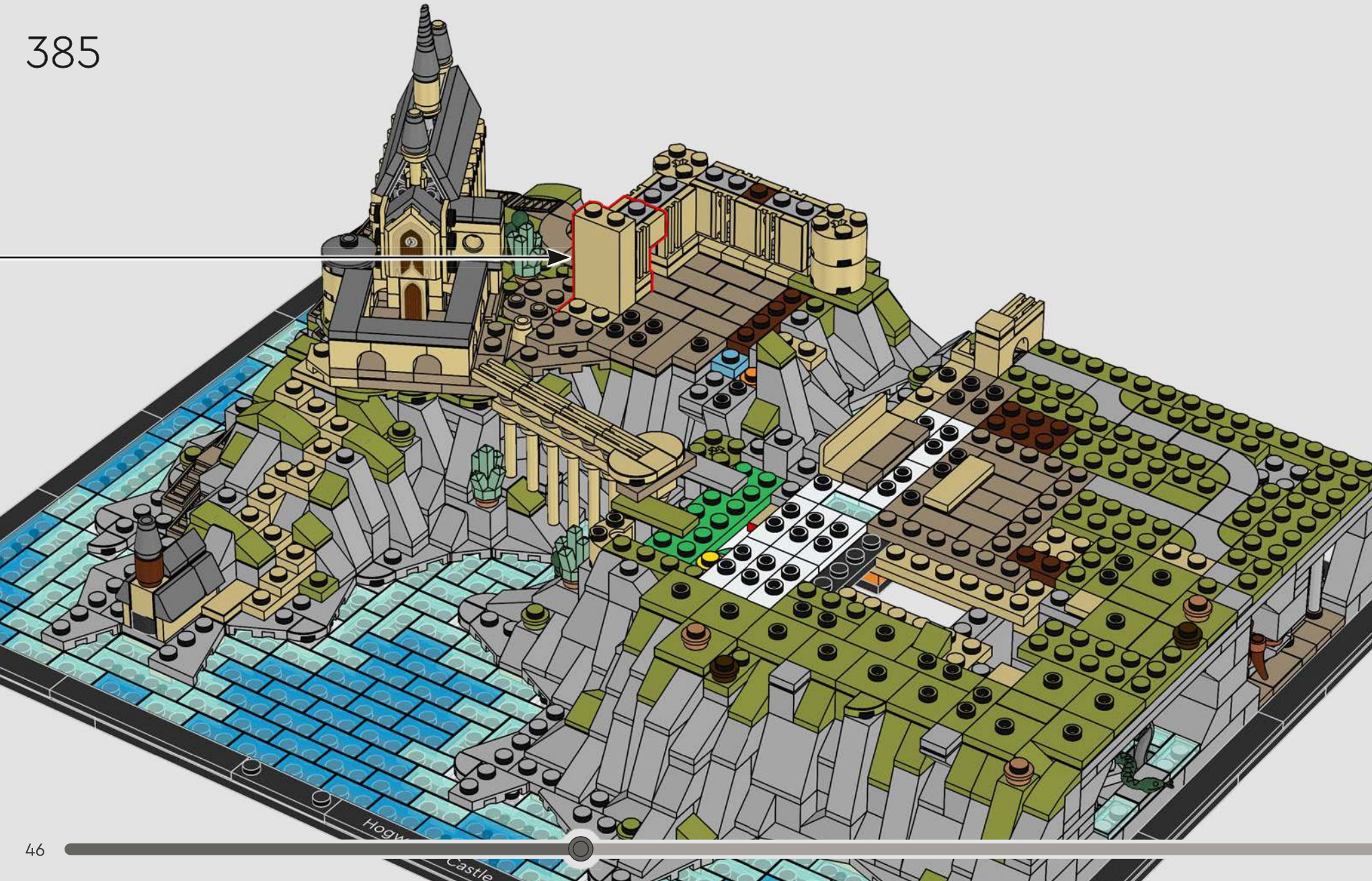

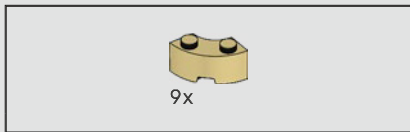

386

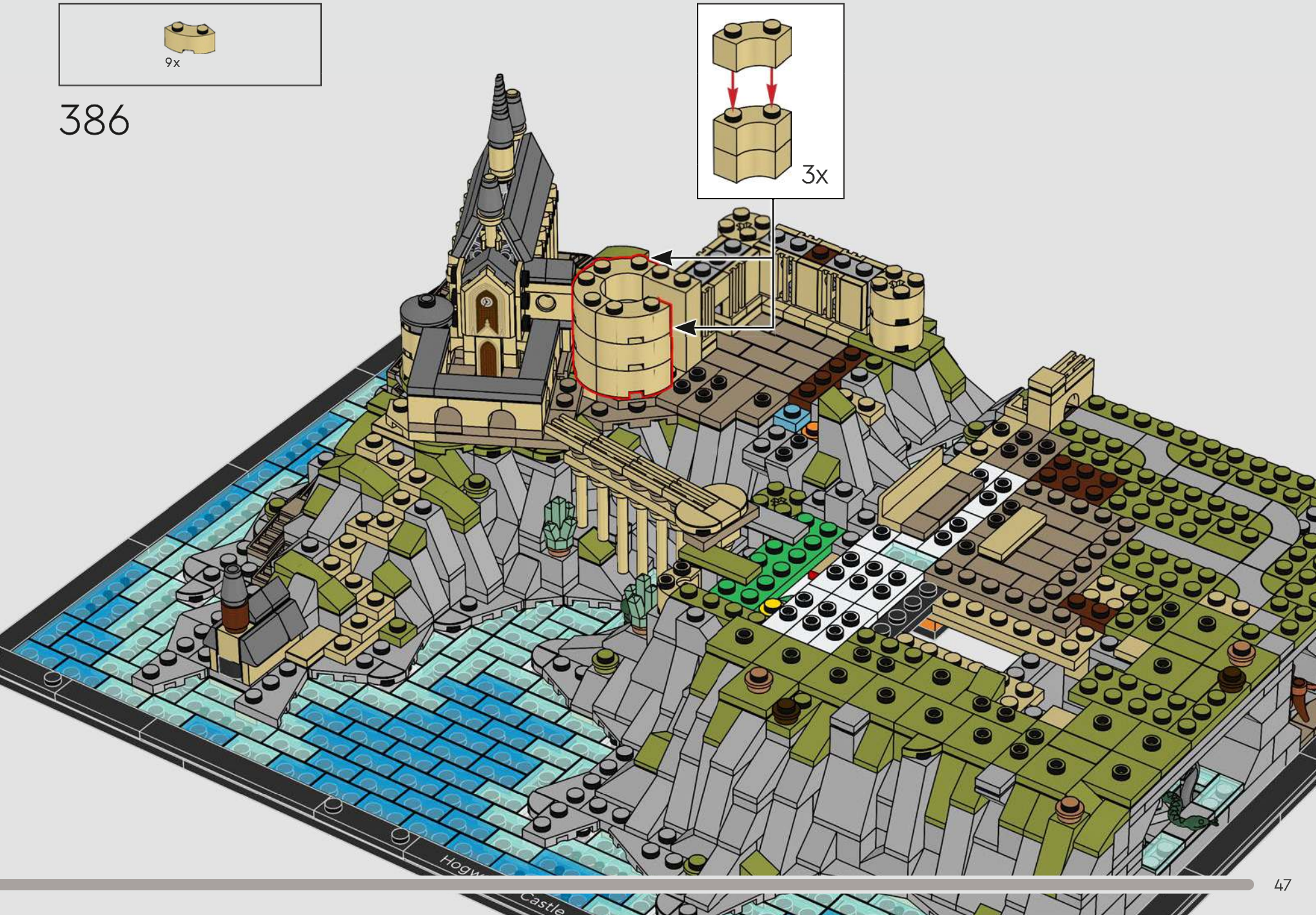
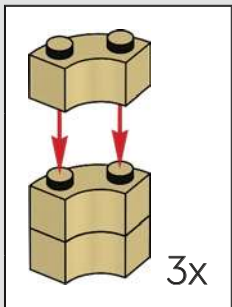

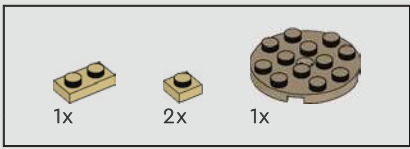

387

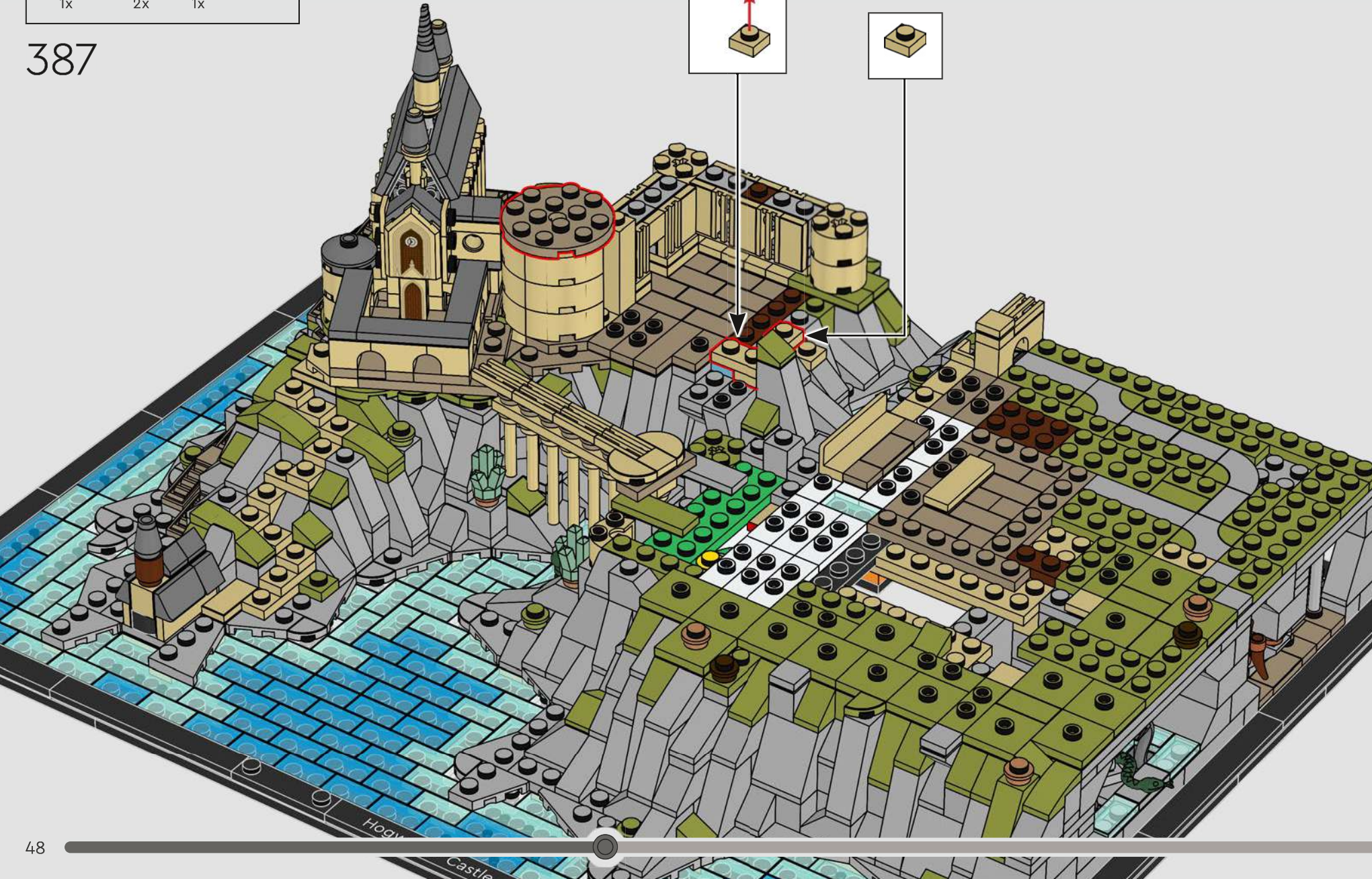
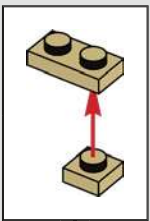

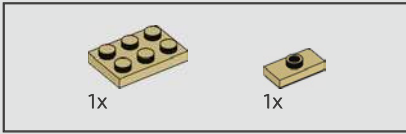

388

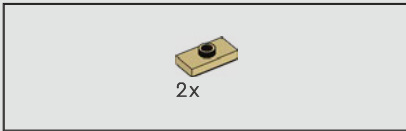
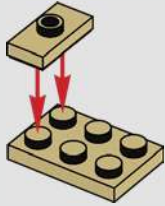

389

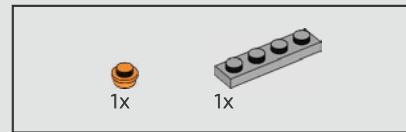

390

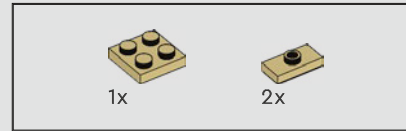
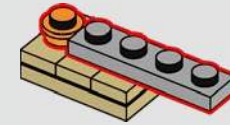

391

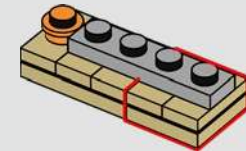
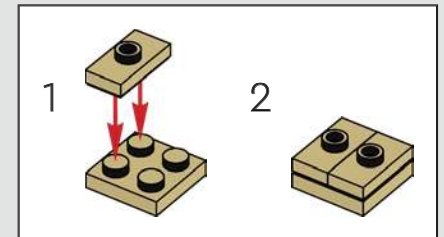

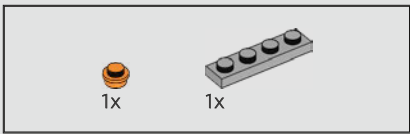

392

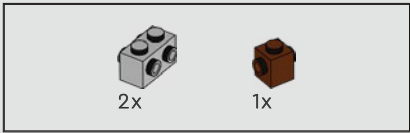
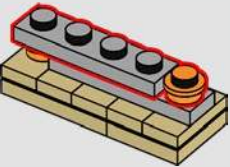

393

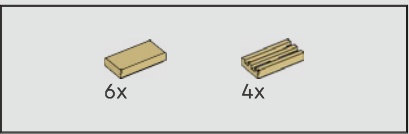
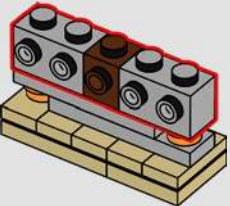

394

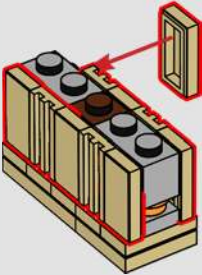

395

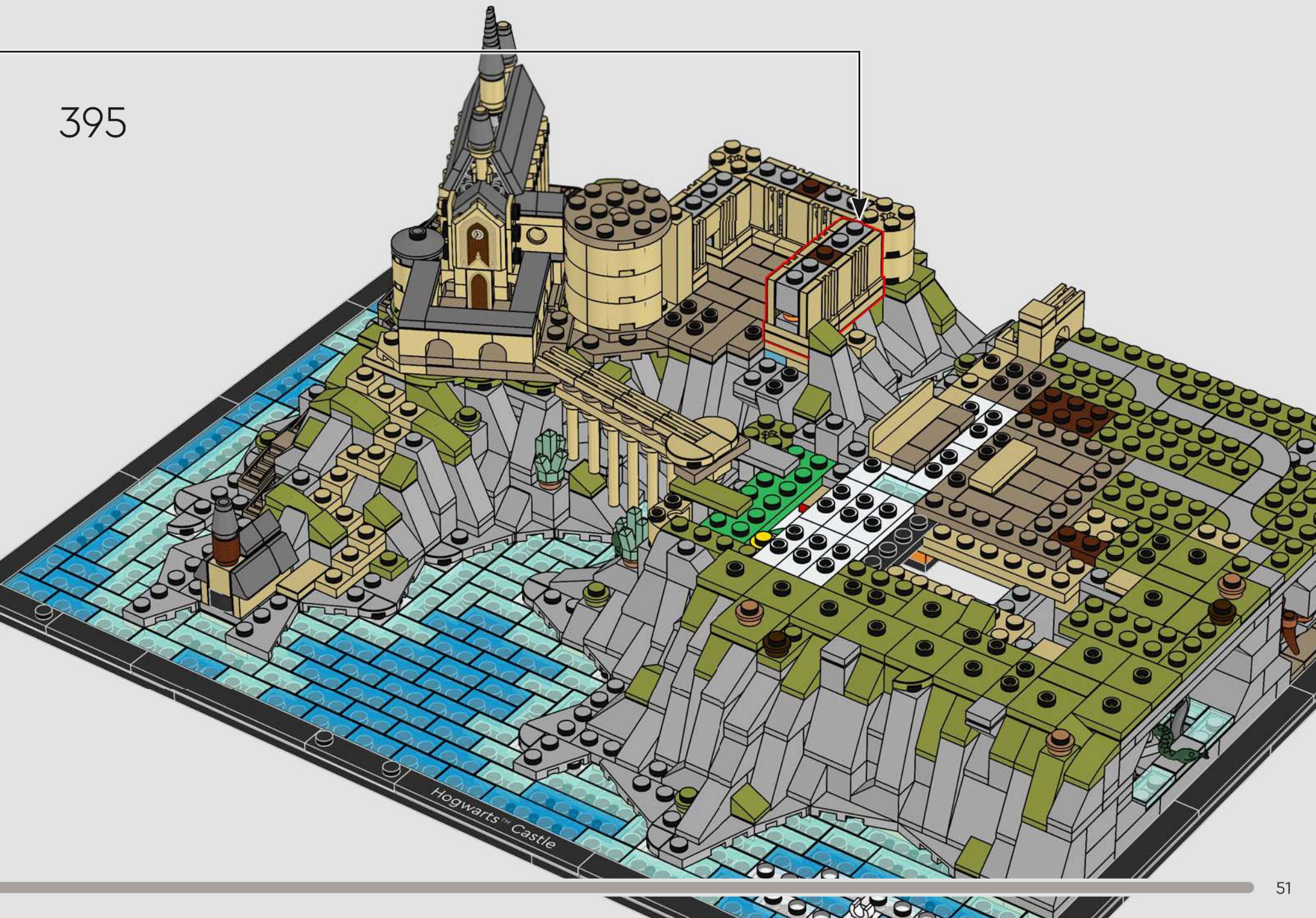

Hogwarts™ Castle

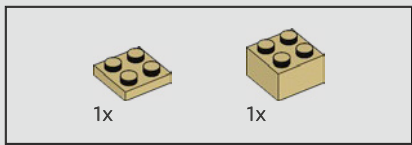

396

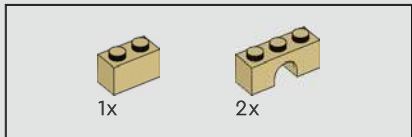
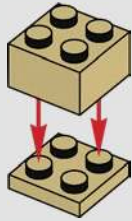

397

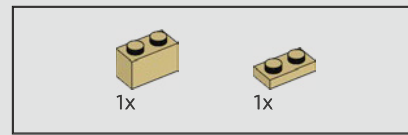
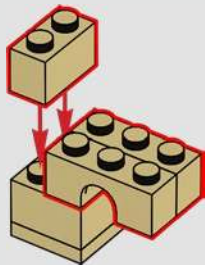

398

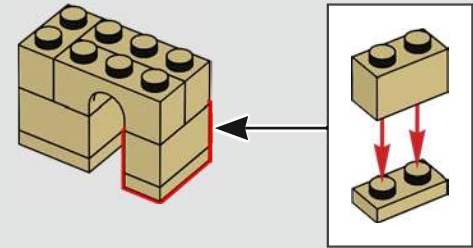

399

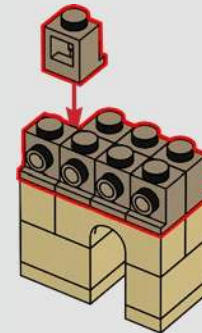

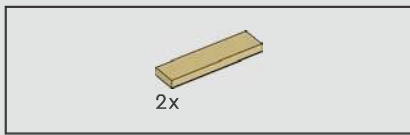

400

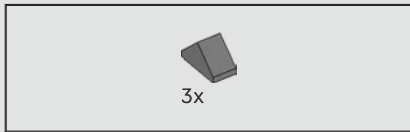
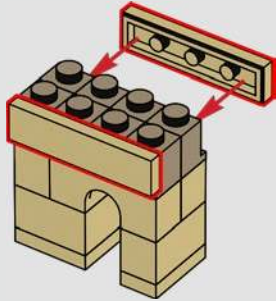

401

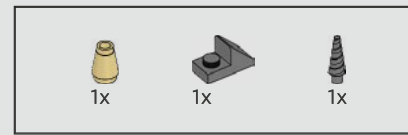
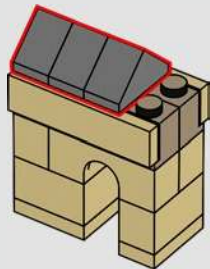

402

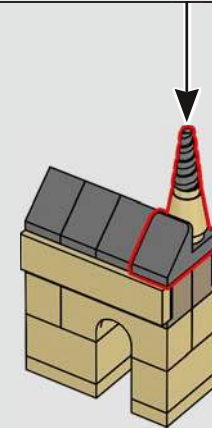
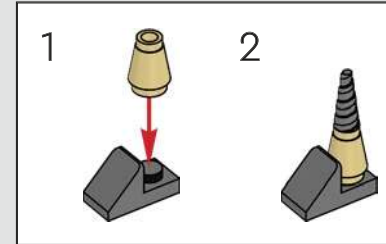

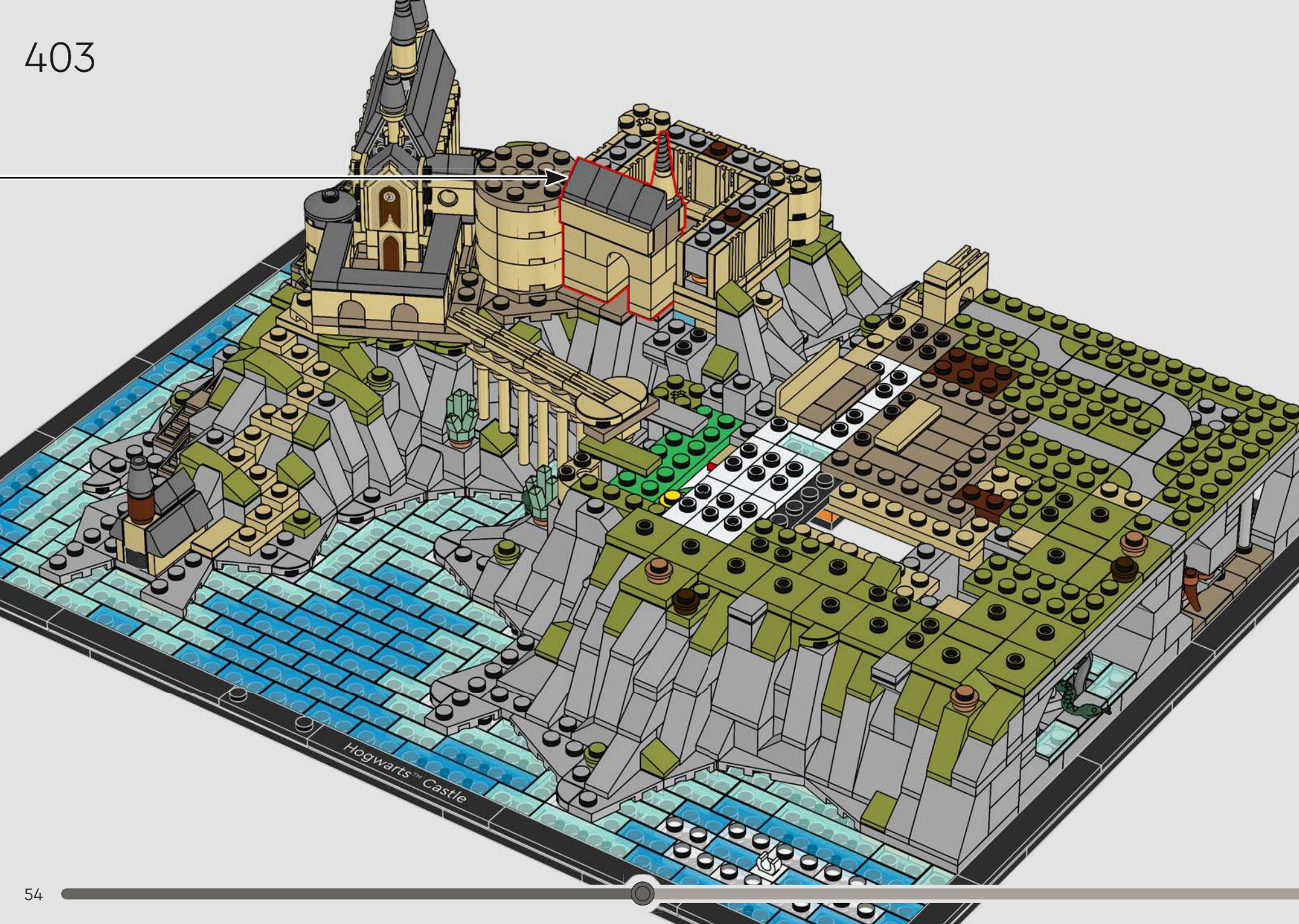

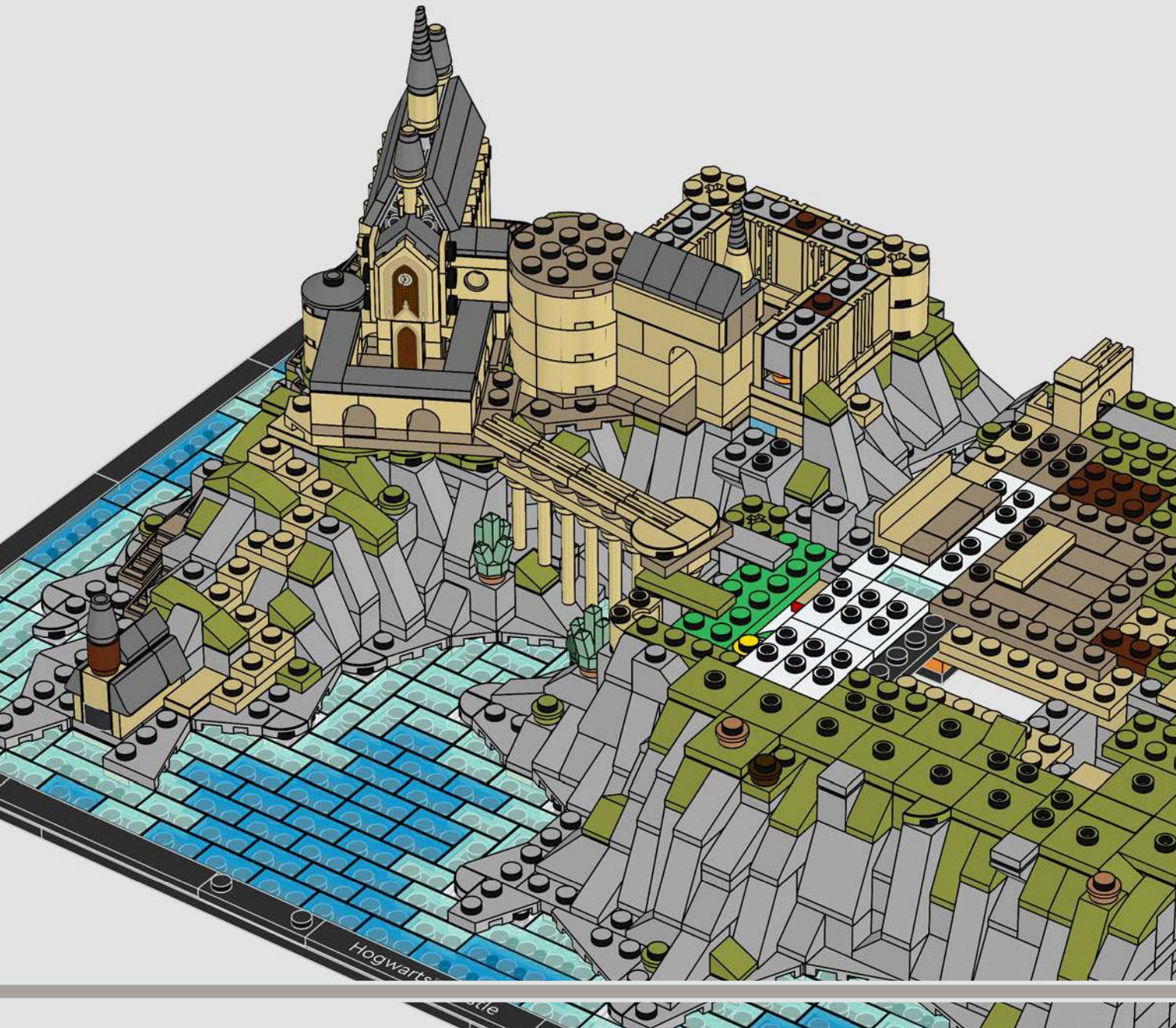

The Quad Courtyard is an outdoor meeting space for students nestled near the Clock Tower.

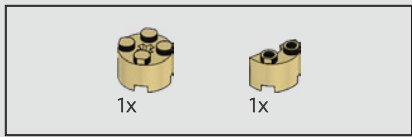

404

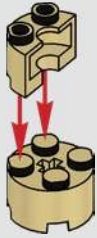

405



406

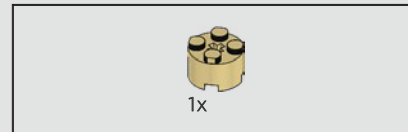
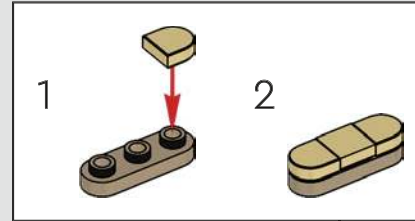

407

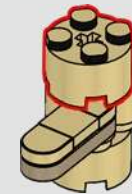

408



Hogwarts<sup>TM</sup> Castle





409

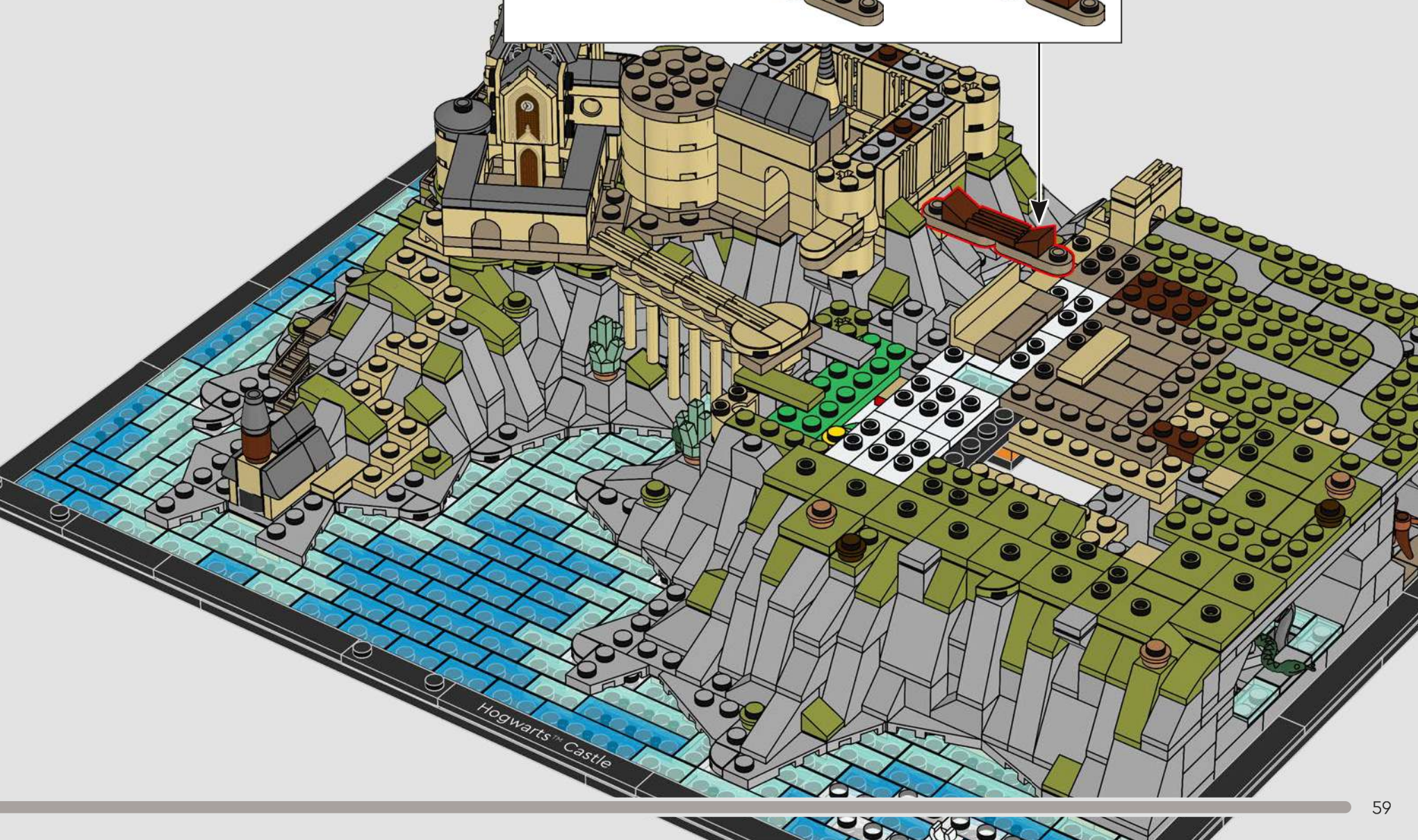
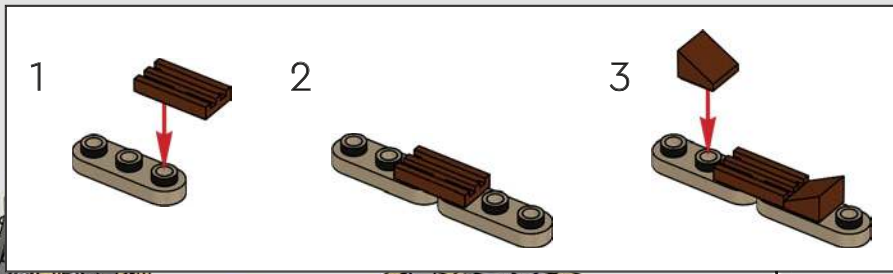



410

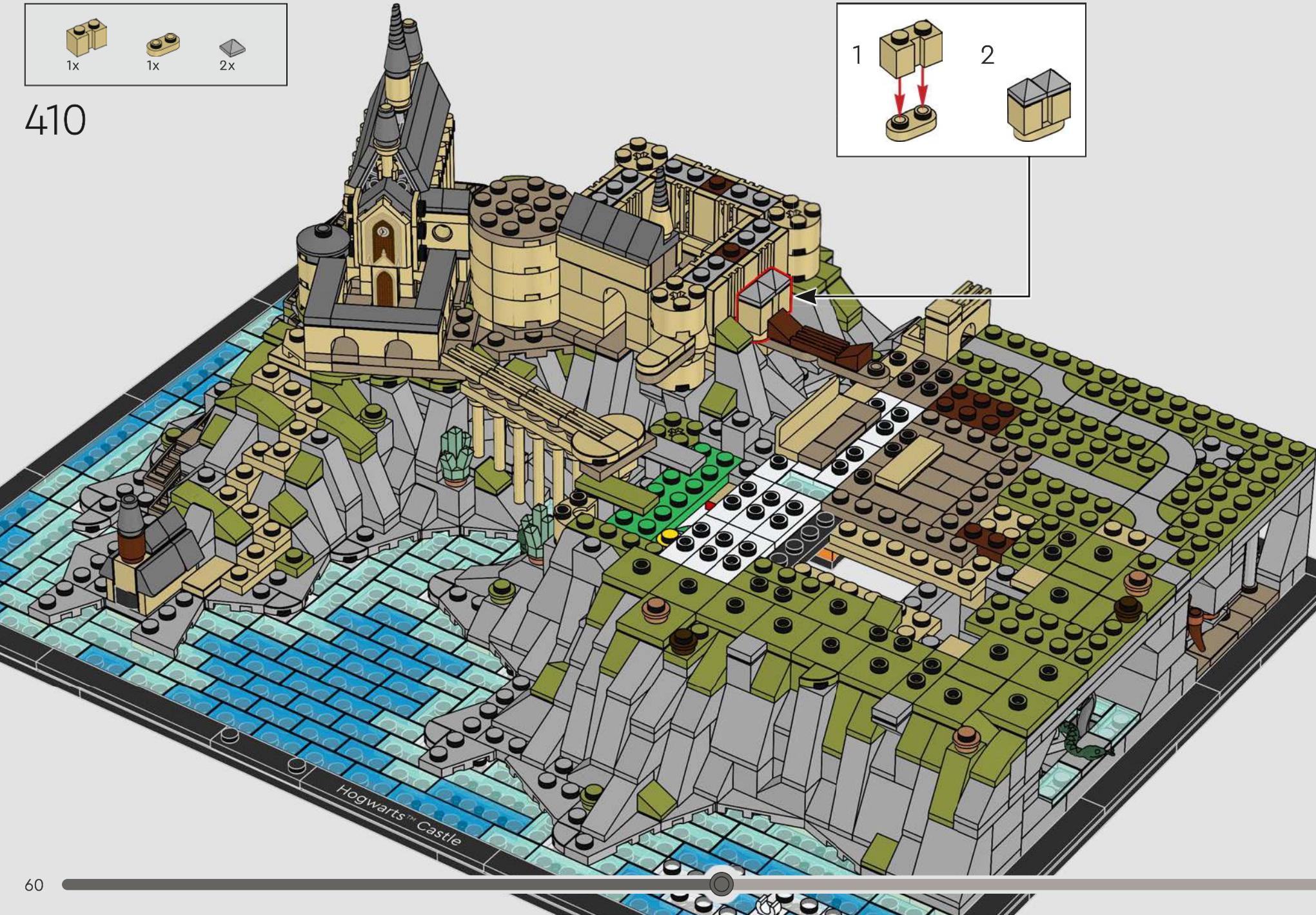
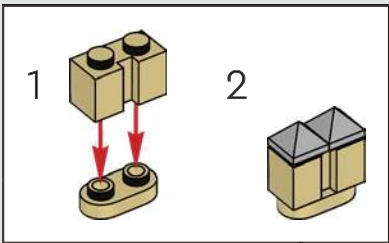

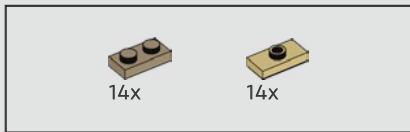

411

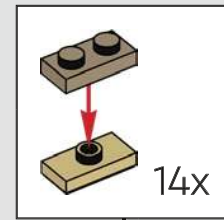

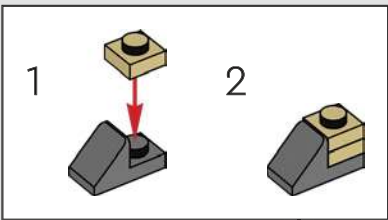
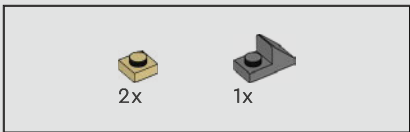

412

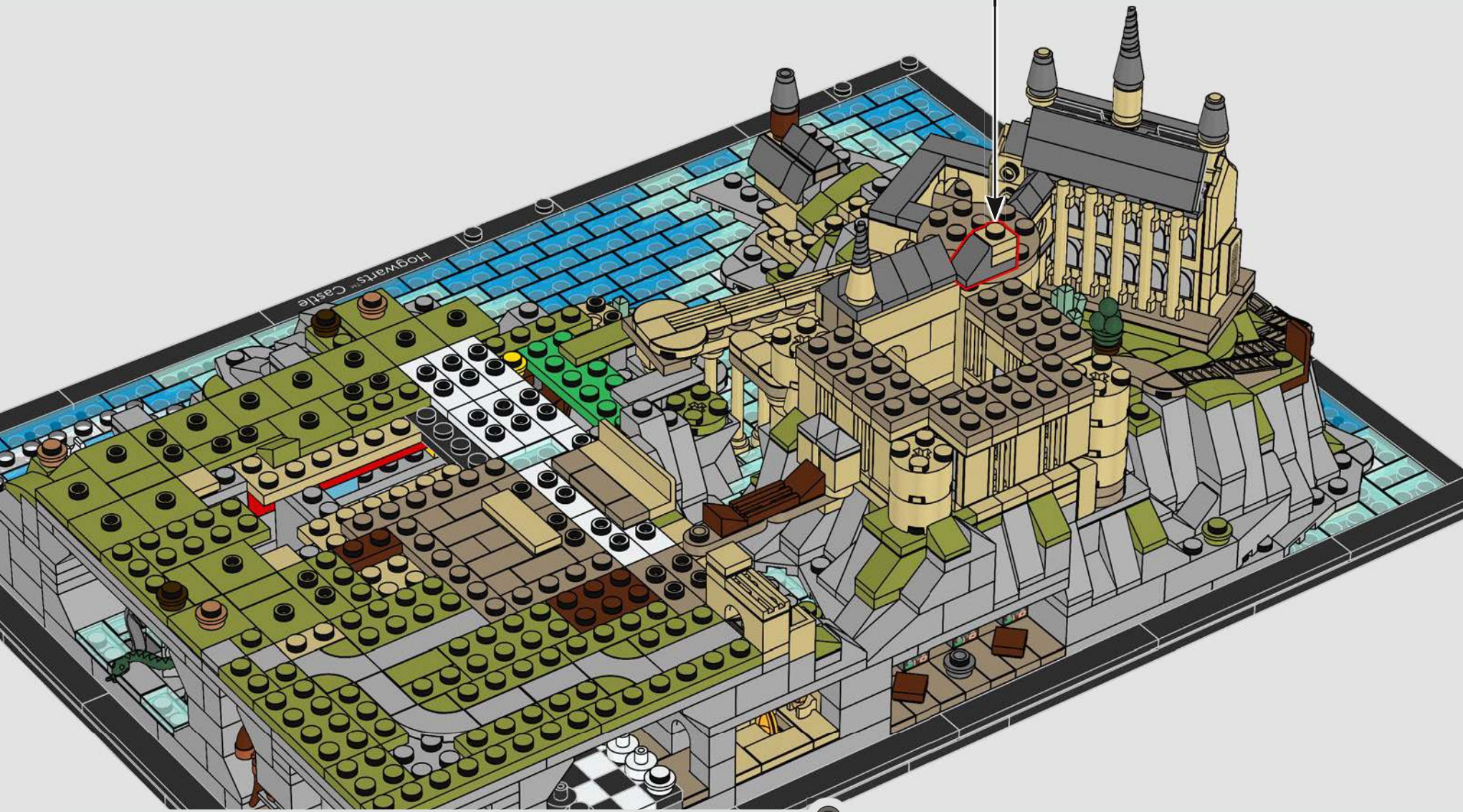

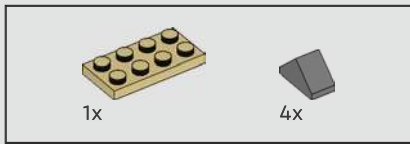

413

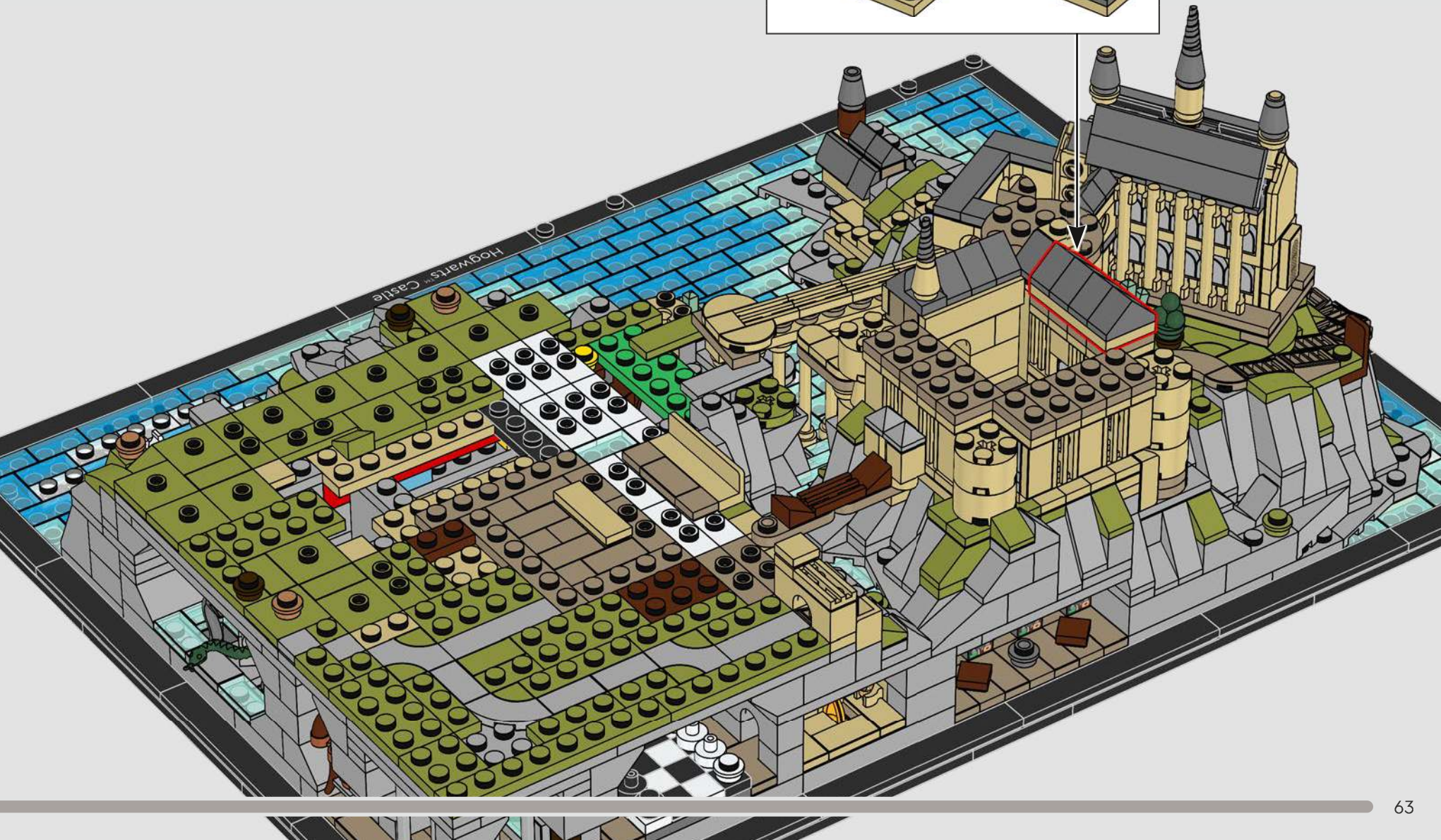
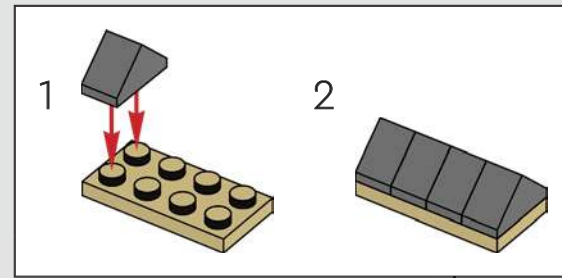

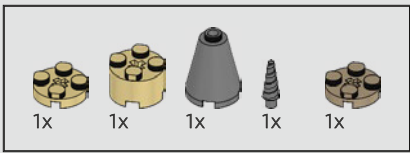

414

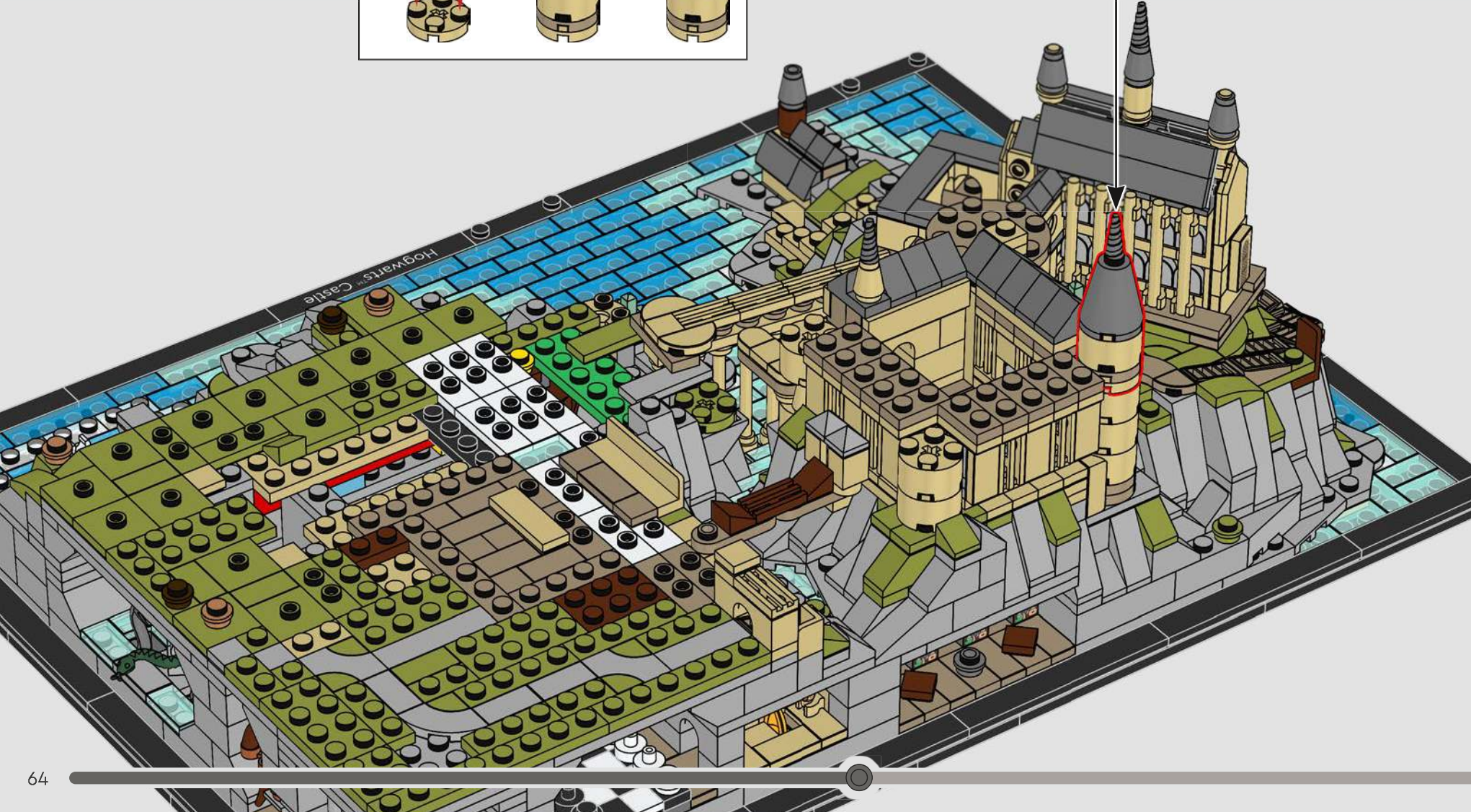
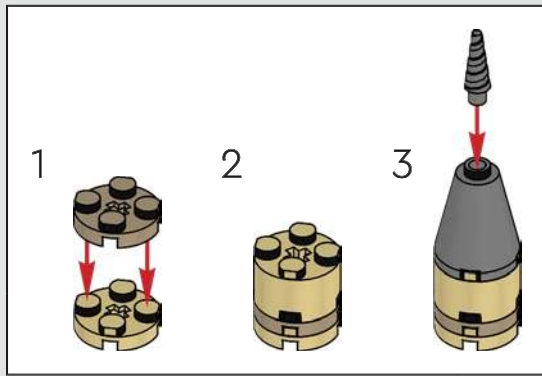

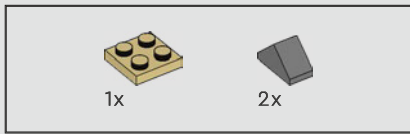

415

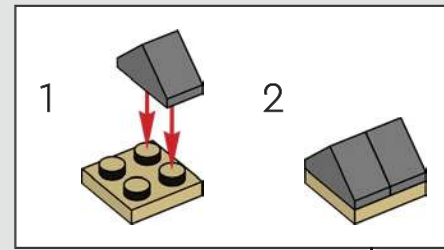

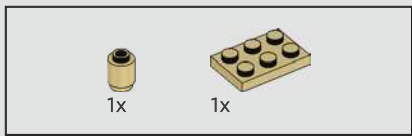

416

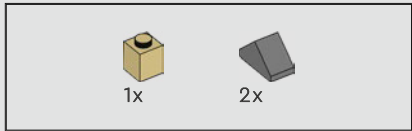
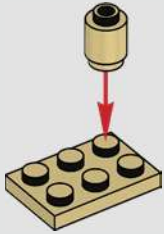

417

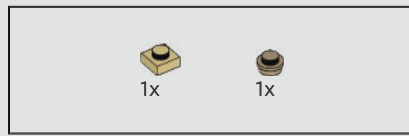
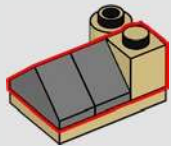

418

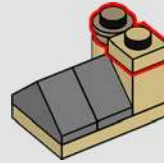

419

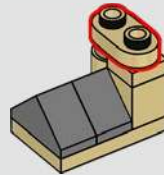

420

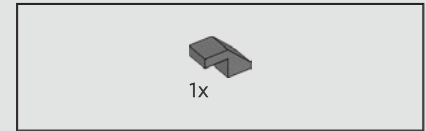
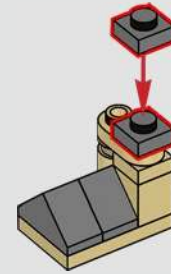

421

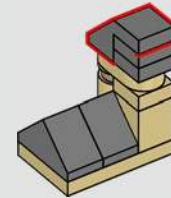

422

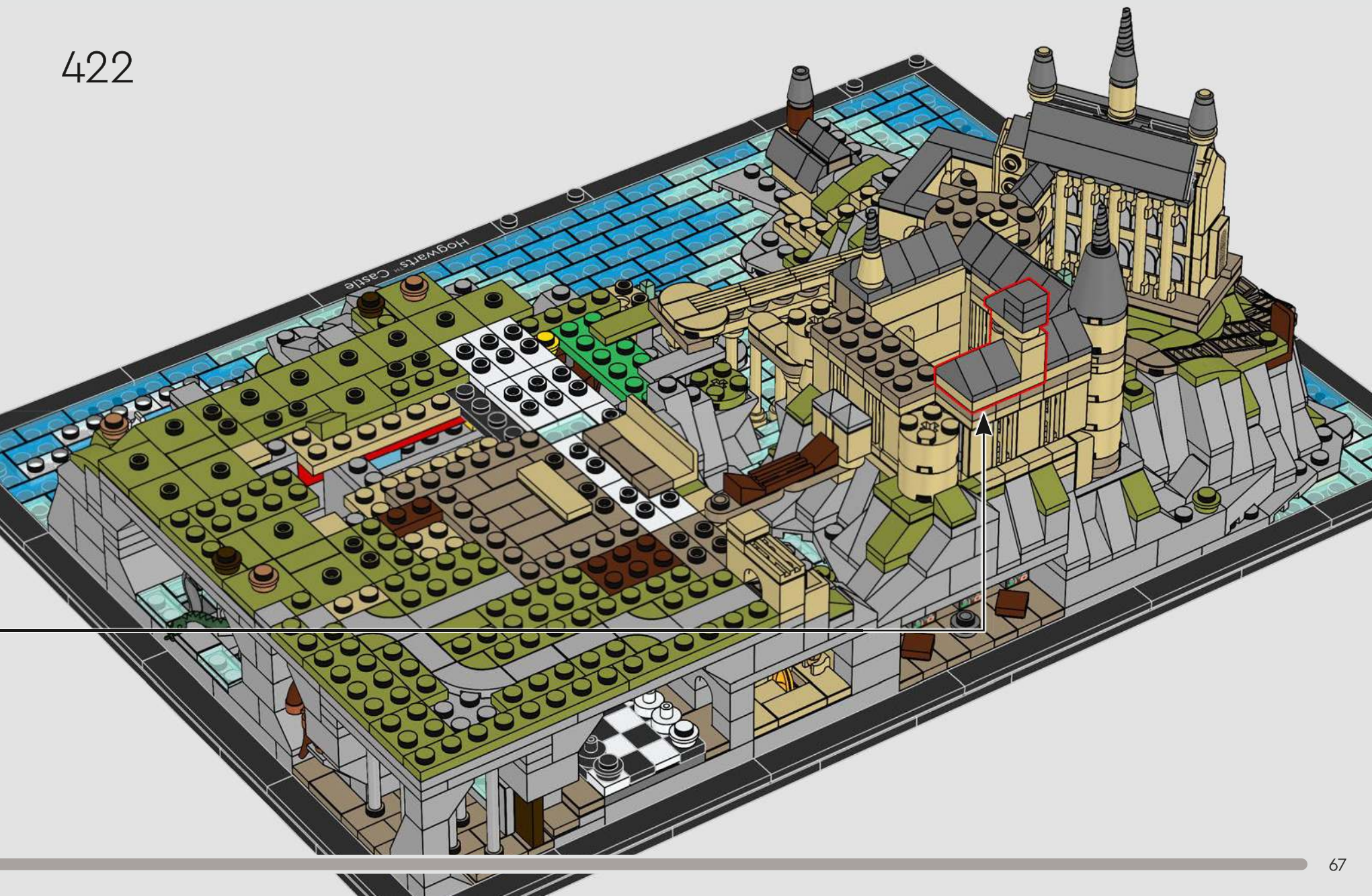

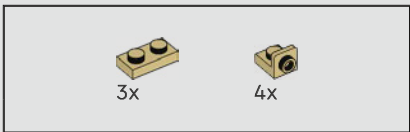

423



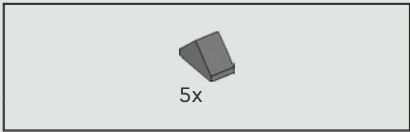

424



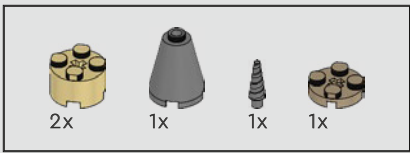

425

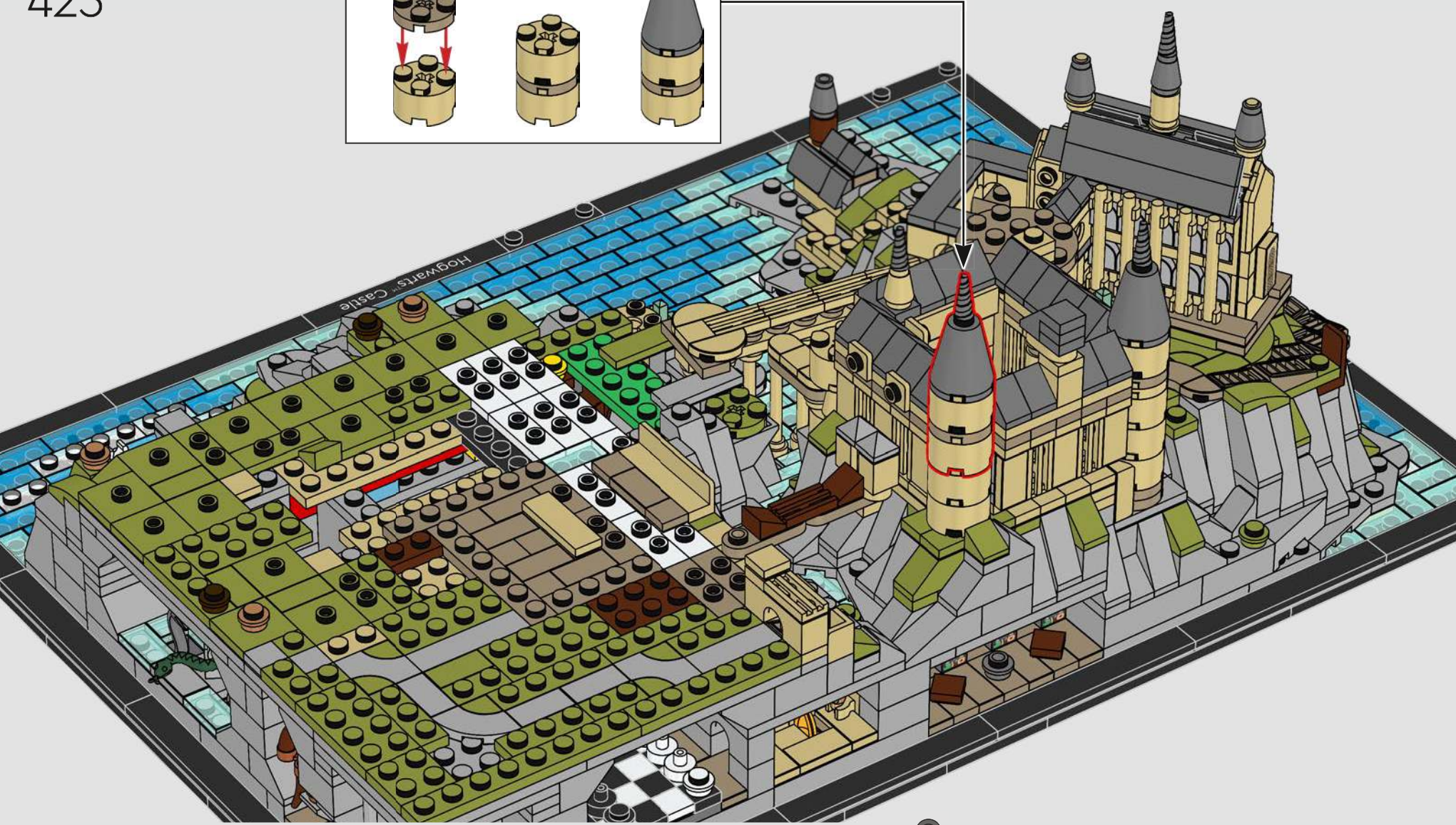
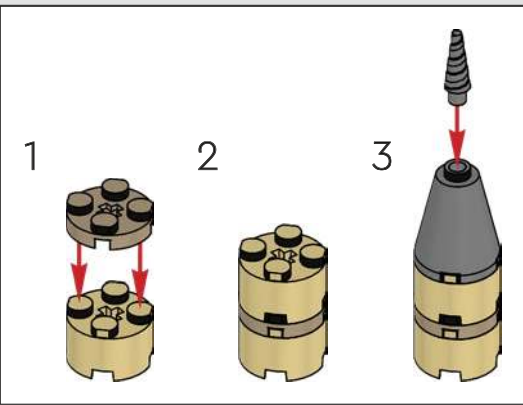

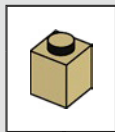
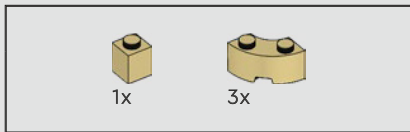

426

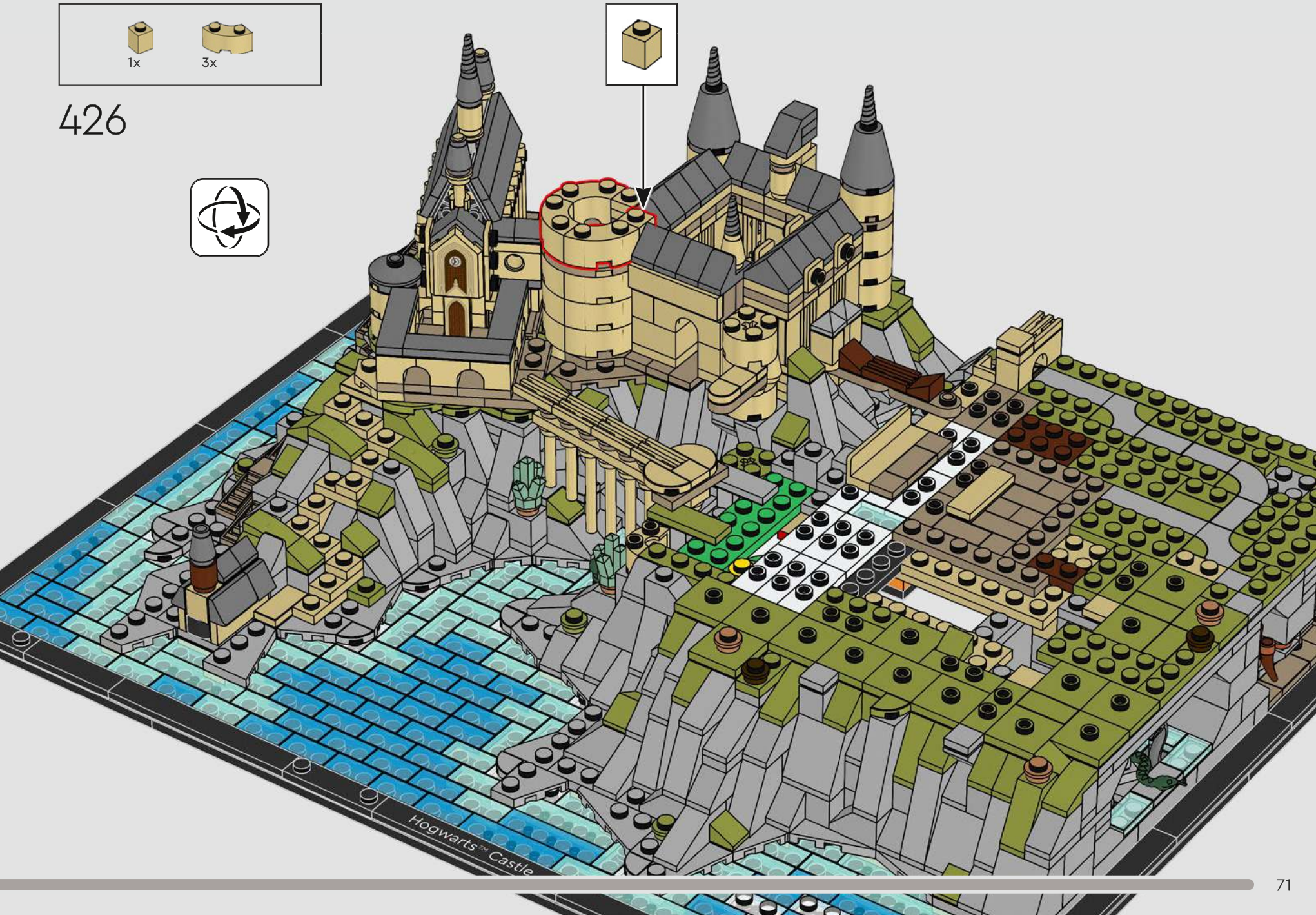

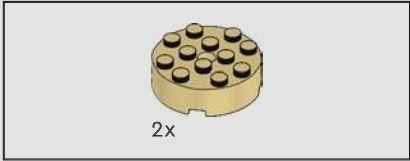
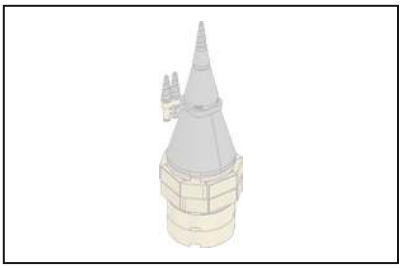

427

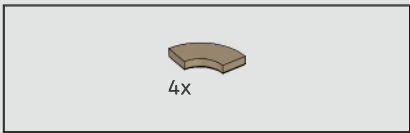
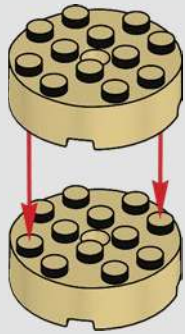

428

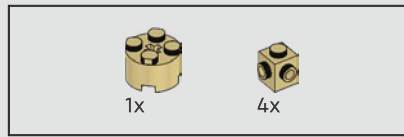
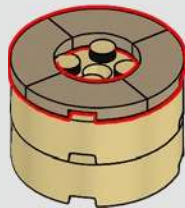

429

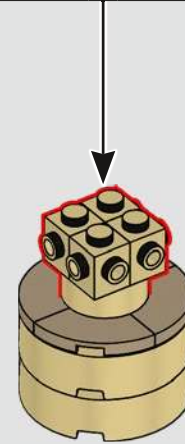
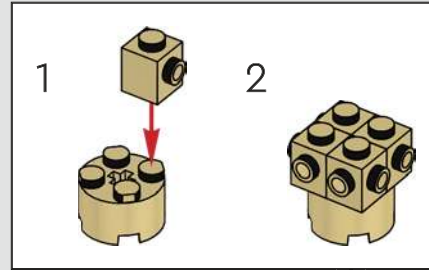

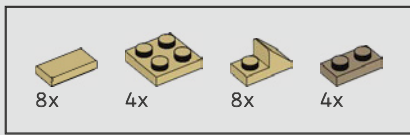

430

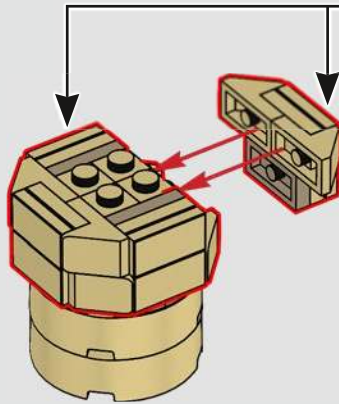
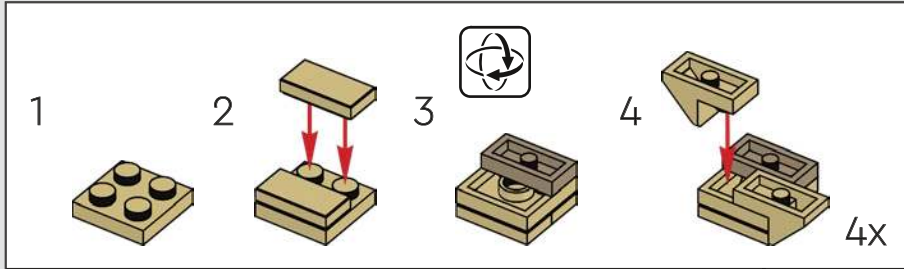

431

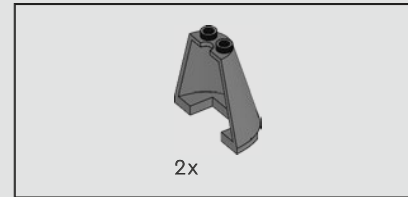
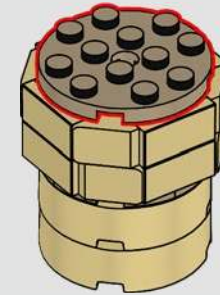

432

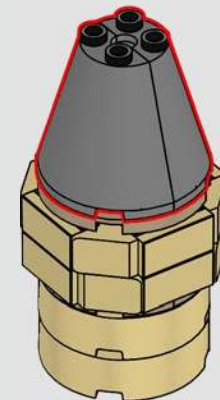

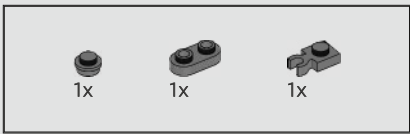

433

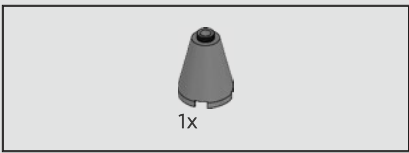
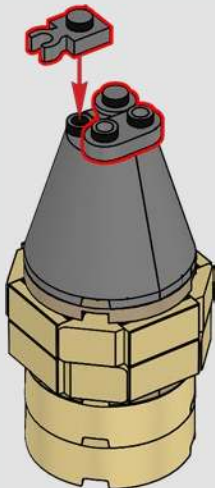

434

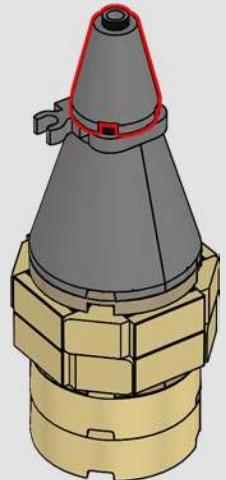

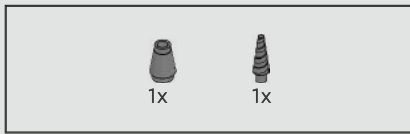

435

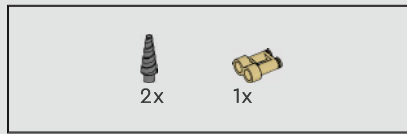
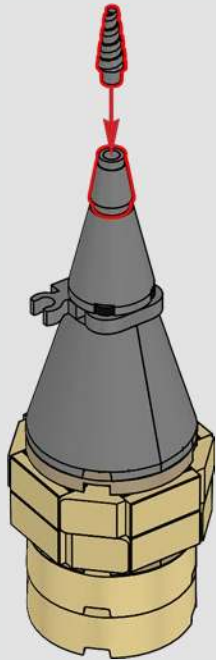

436

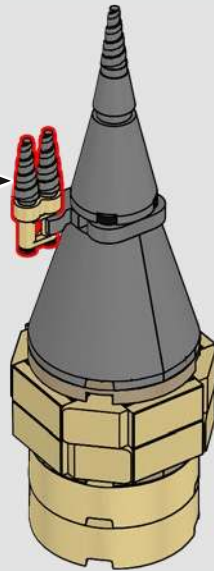
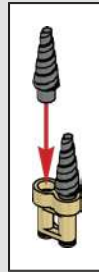

The office of Albus Dumbledore™, the small towers on the main tower, is built with a LEGO® telescope element.



437

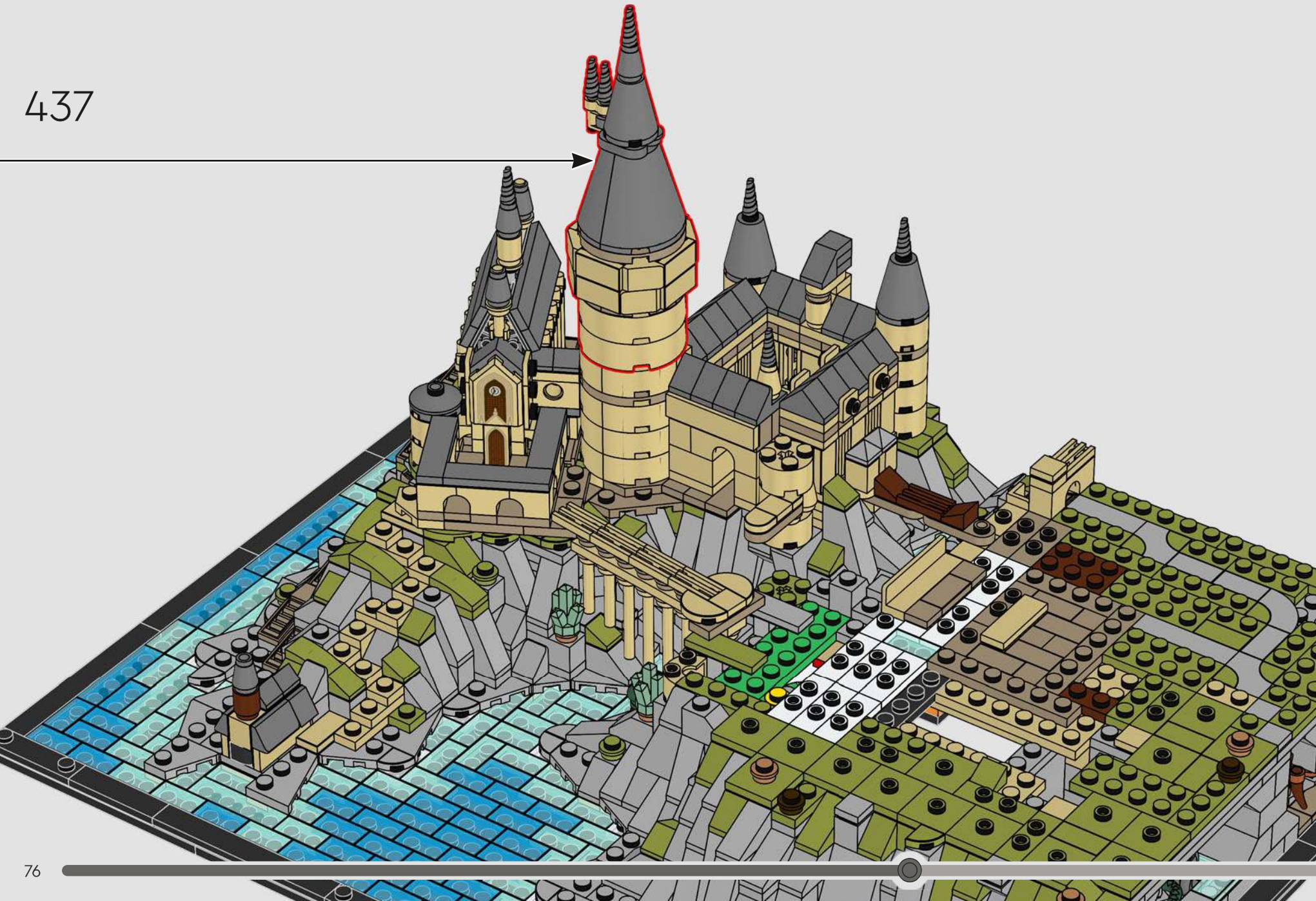



438

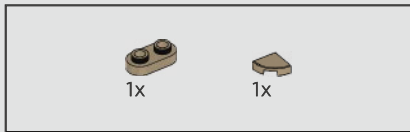
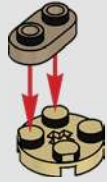

439

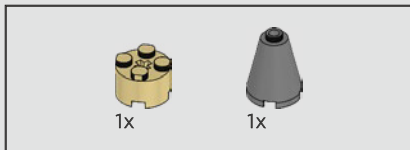

440

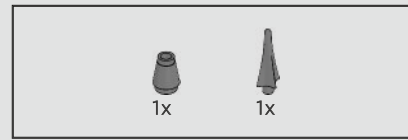
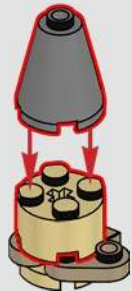

441

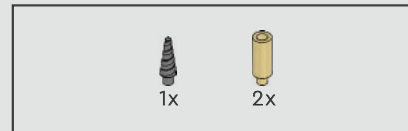

442

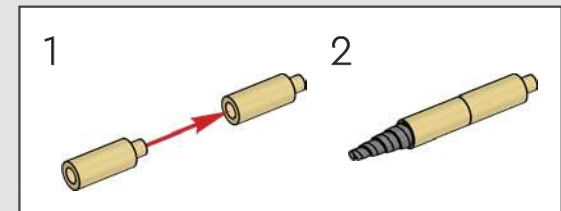

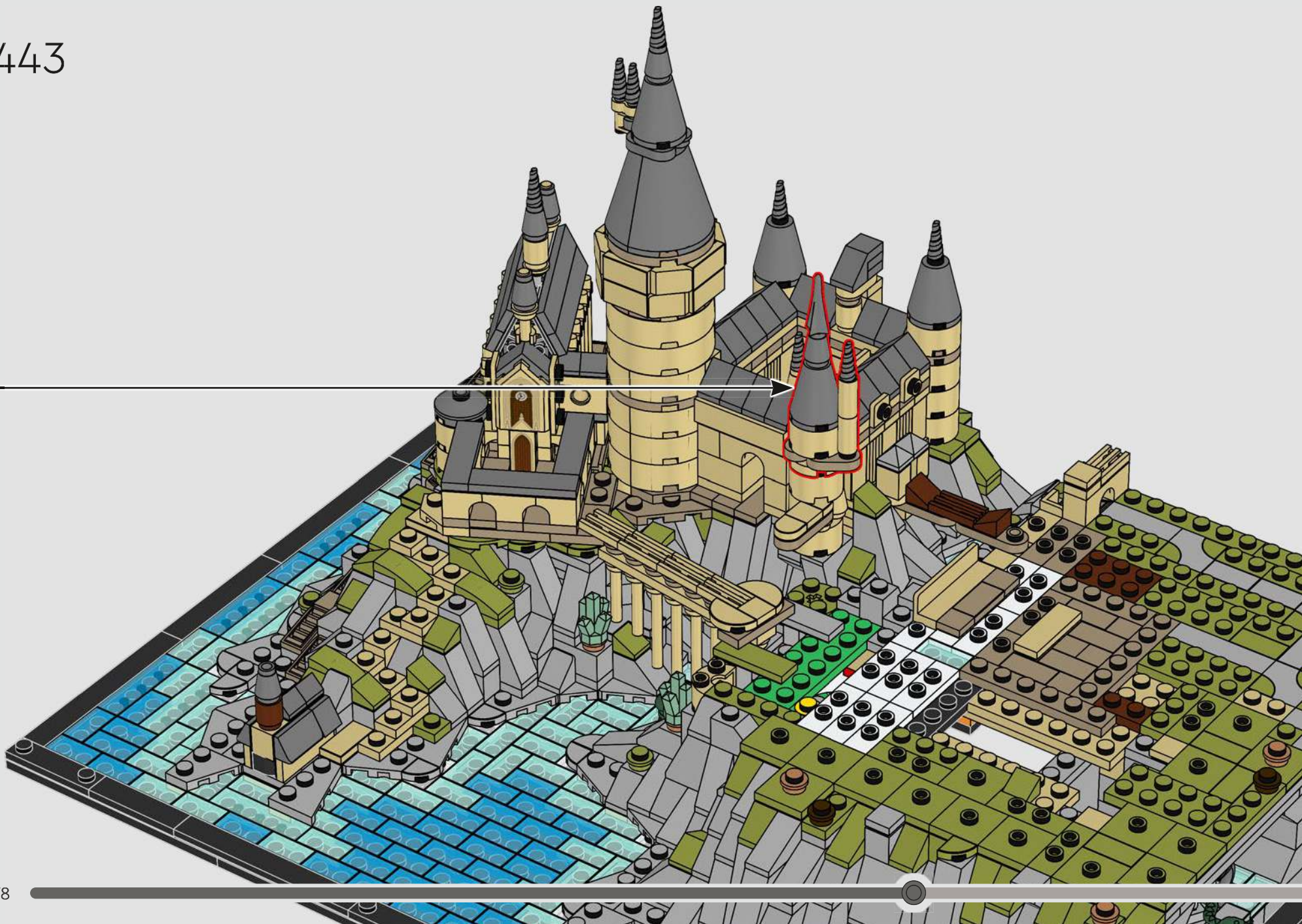



You wouldn't think the sprouting towers on the Headmaster's Tower could be an architecturally sustainable structure – but of course, at Hogwarts™ everything is possible!



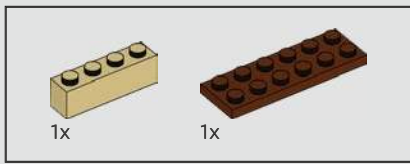

444

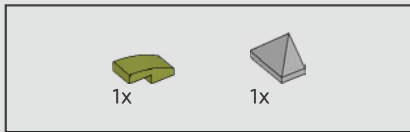
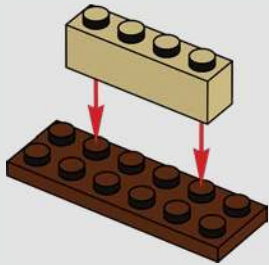

445

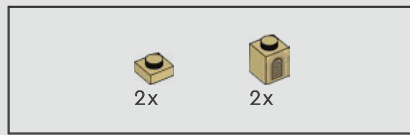
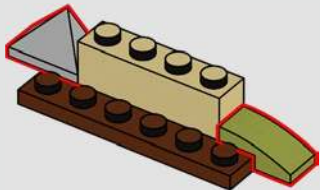

446

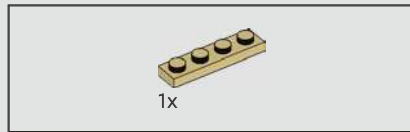
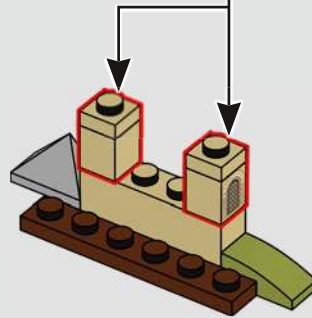
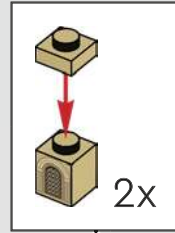

447

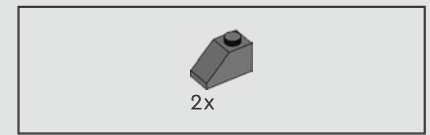
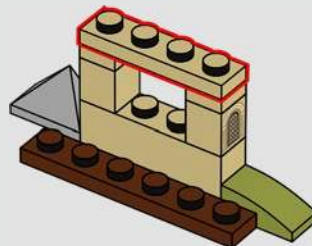

448

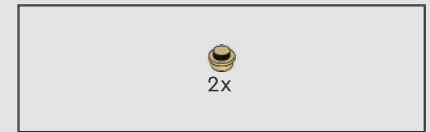
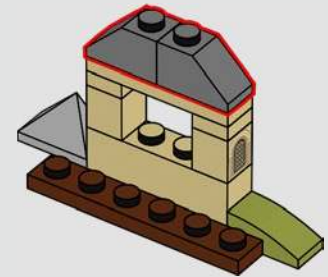

449

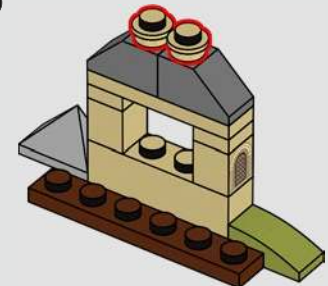

450

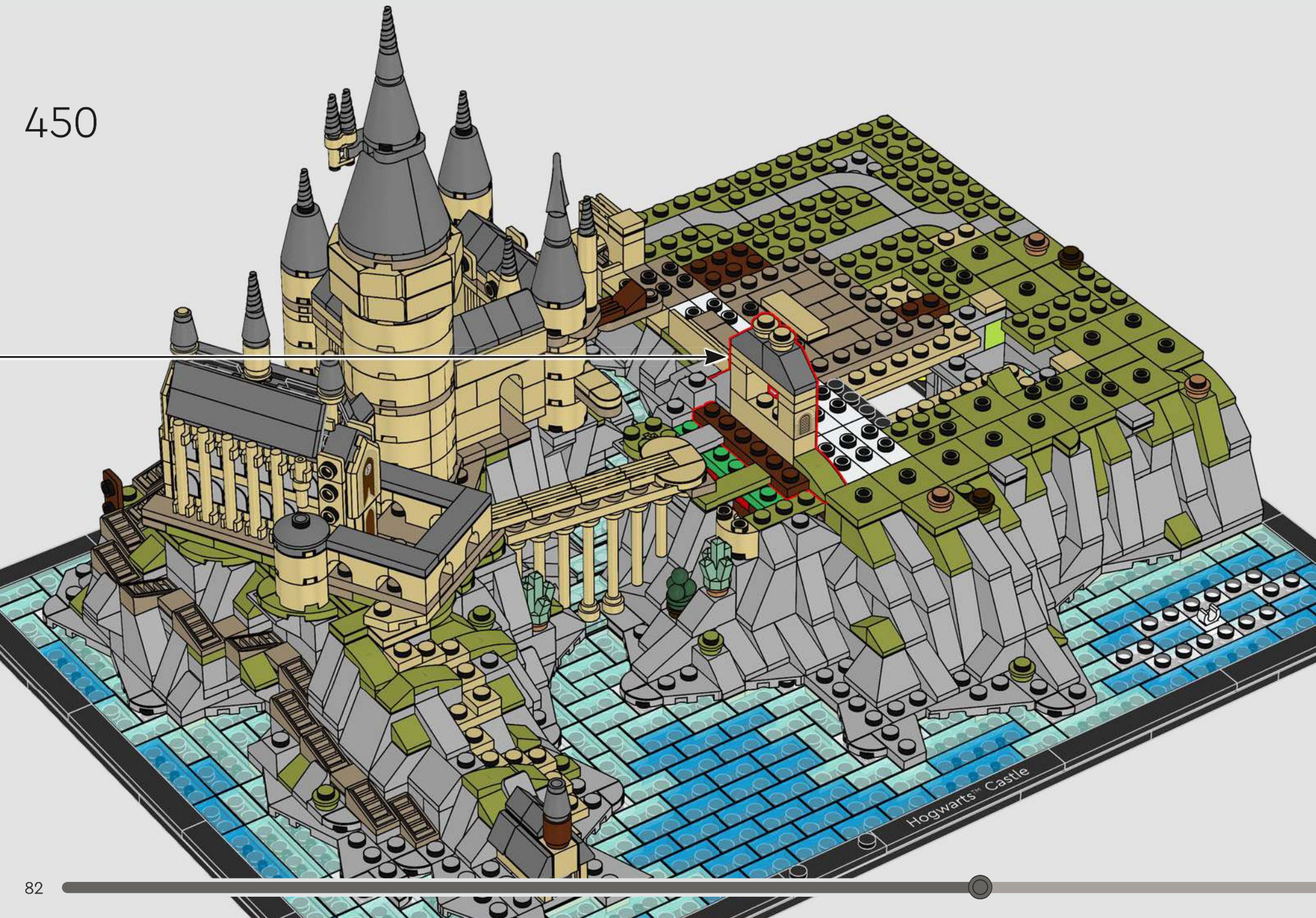

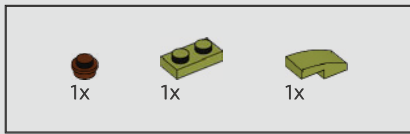

451

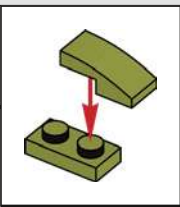
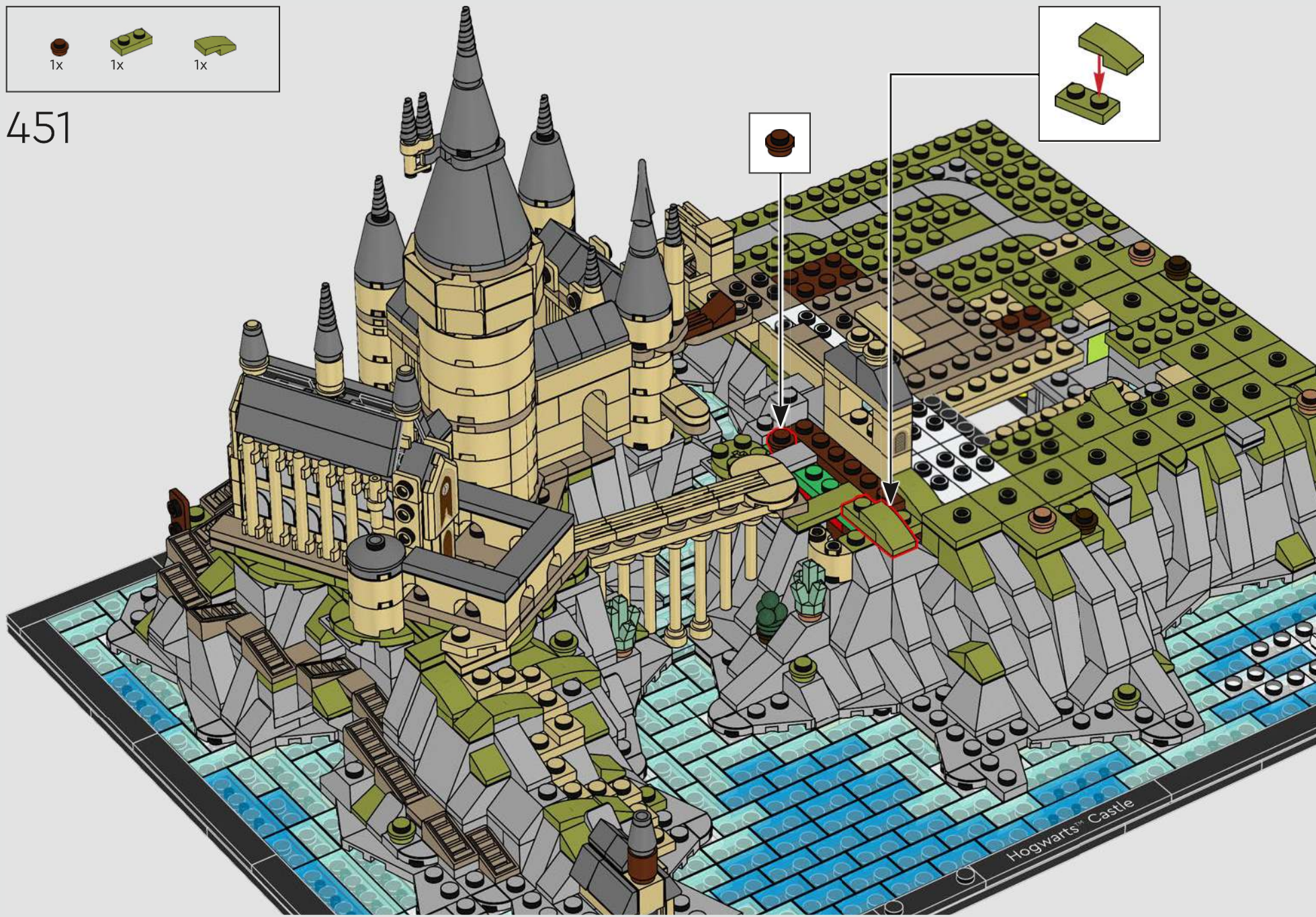

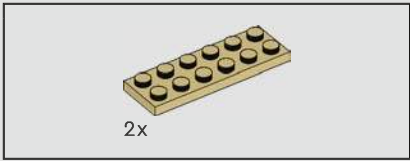

452

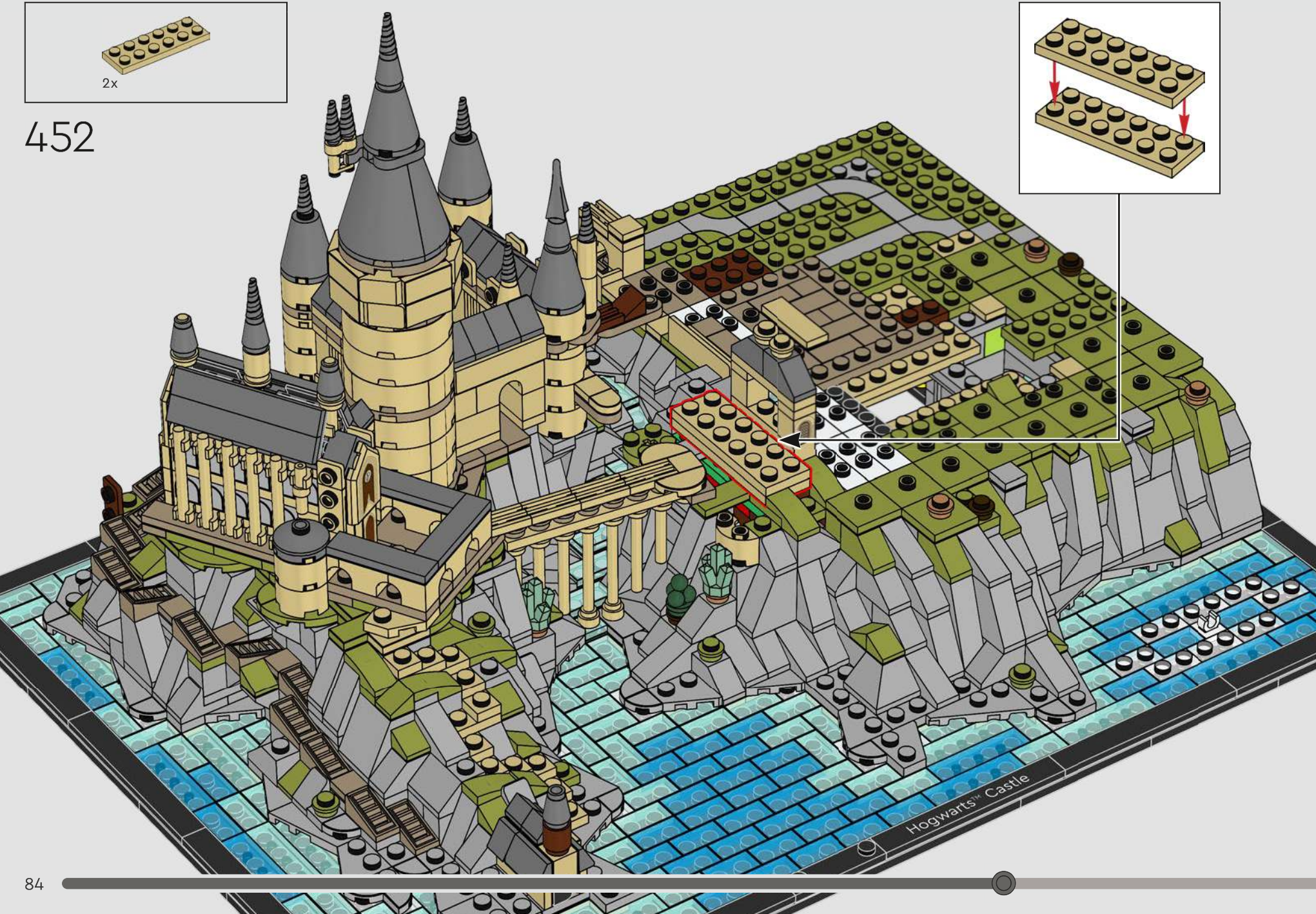
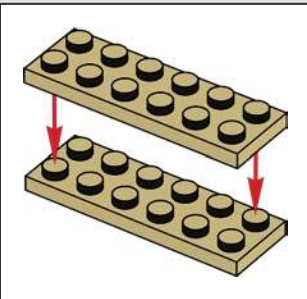

Hogwarts™ Castle

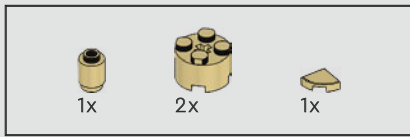

453

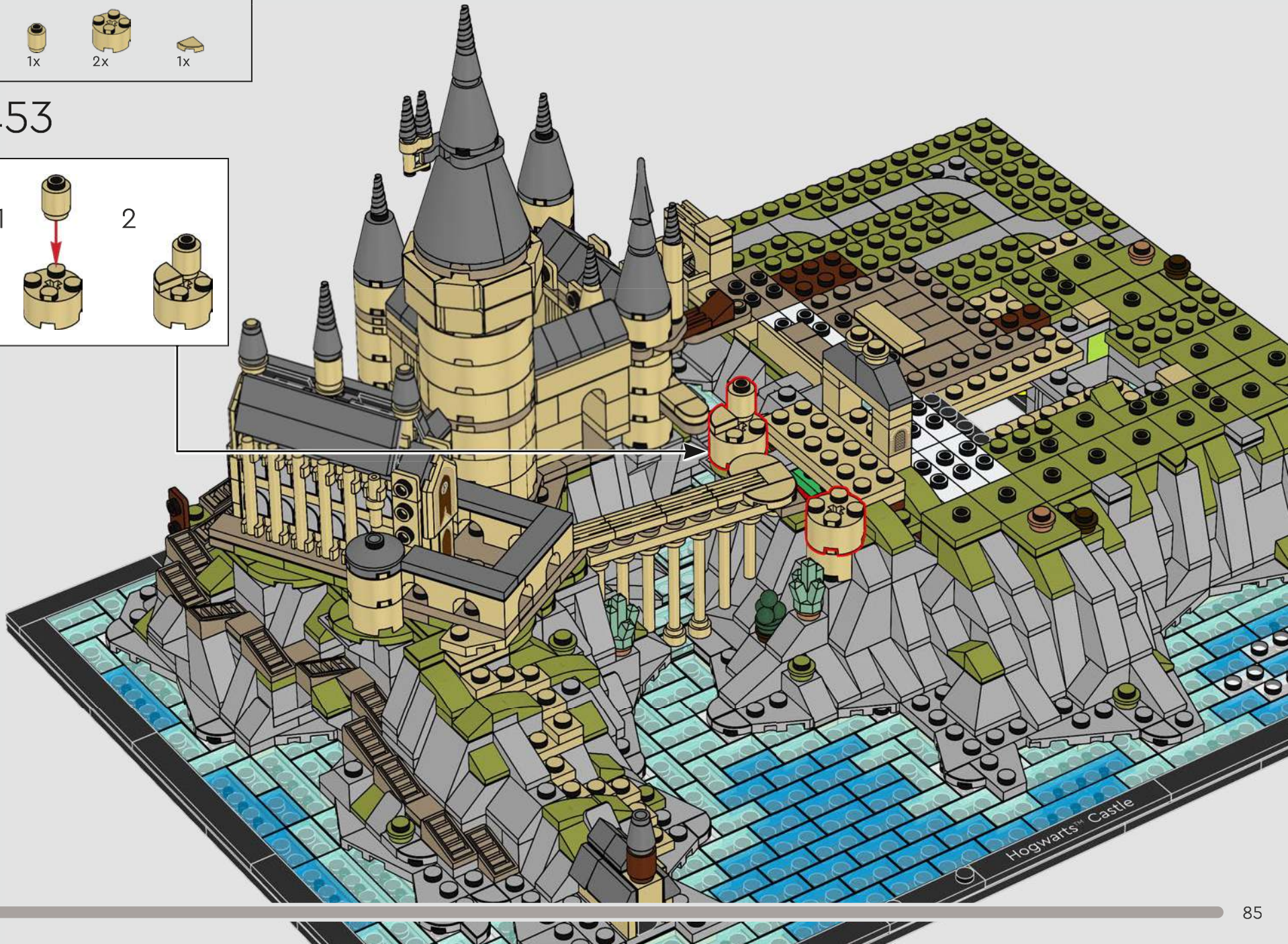
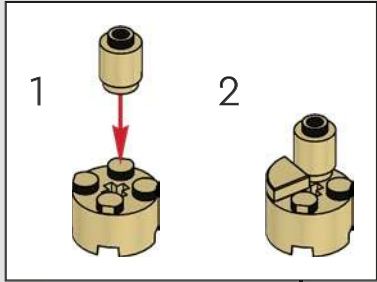



3x

454

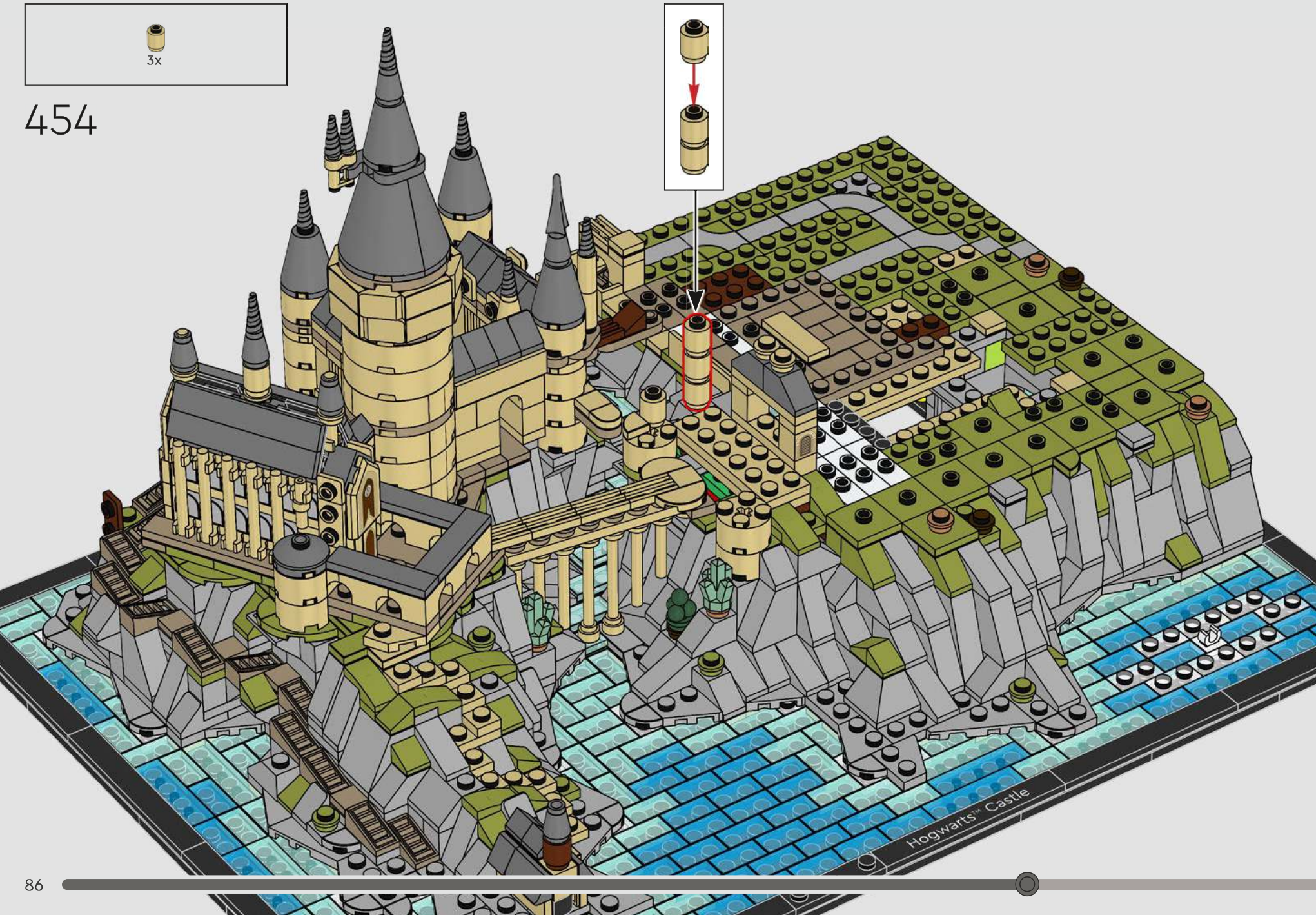
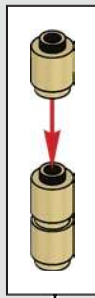

Hogwarts™ Castle

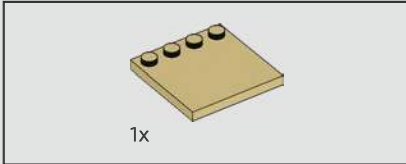
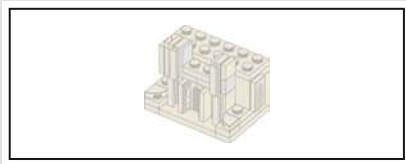

455

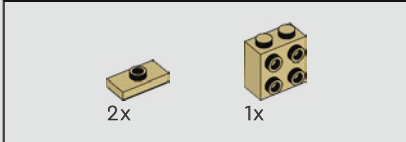
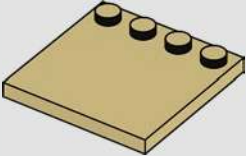

456

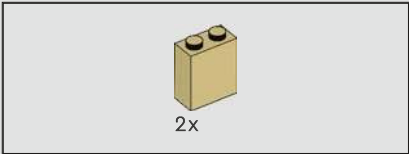
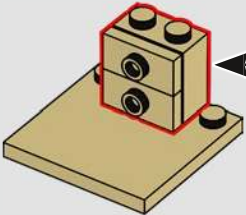
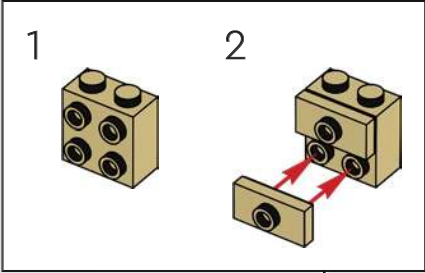

457

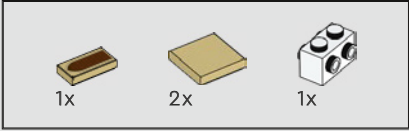
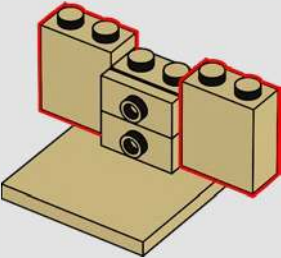

458

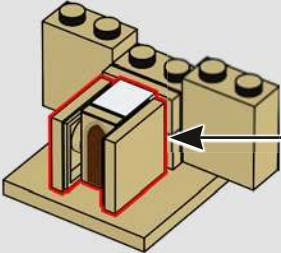
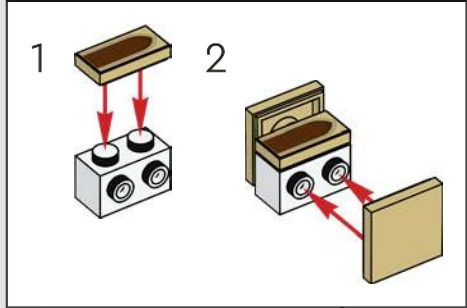

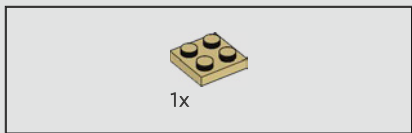

459

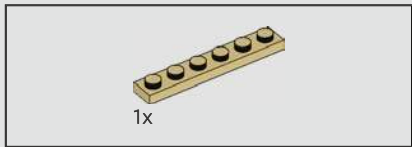
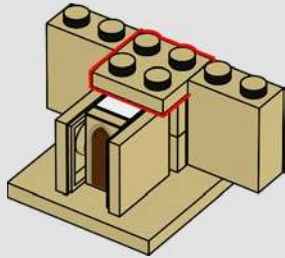

460

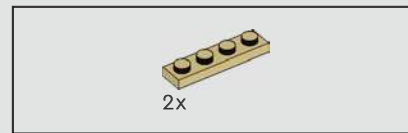
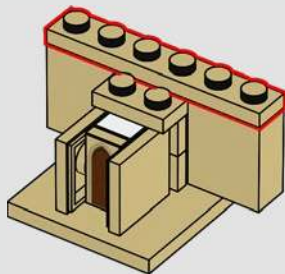

461

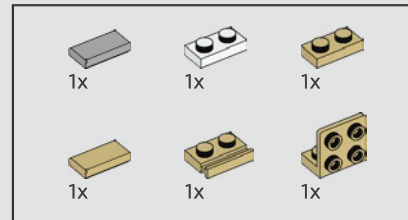
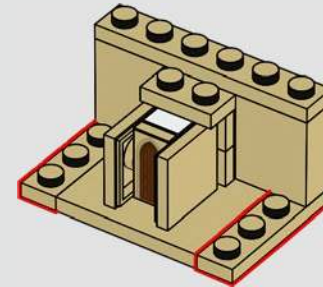

462

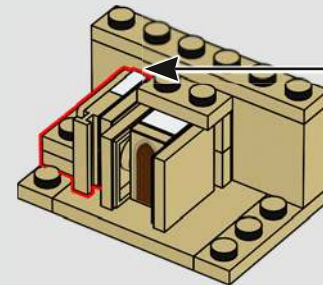
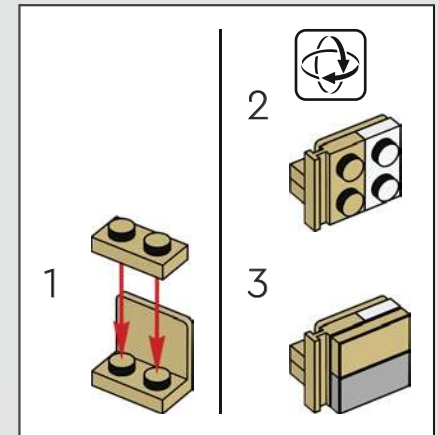

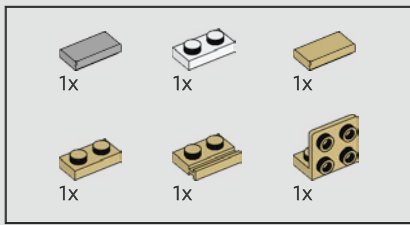

463

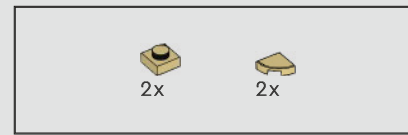
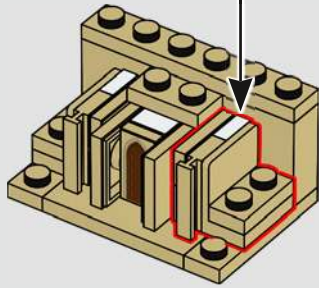
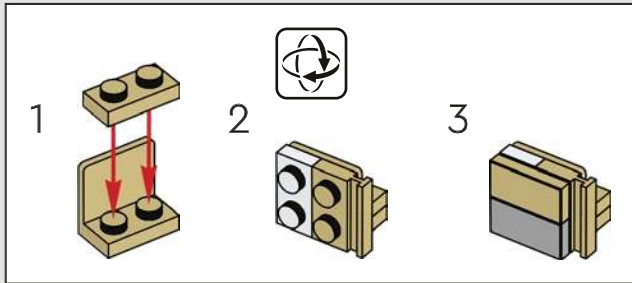

464

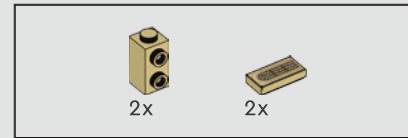
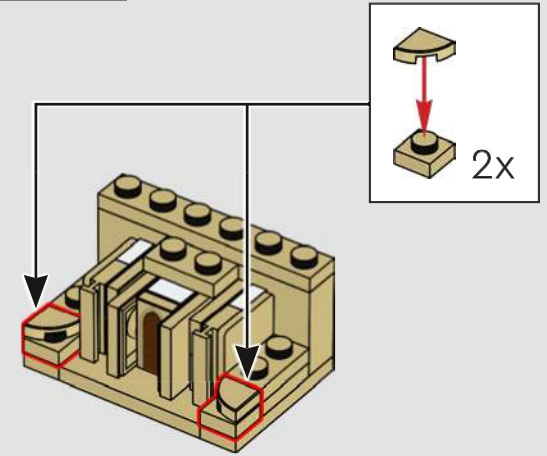

465

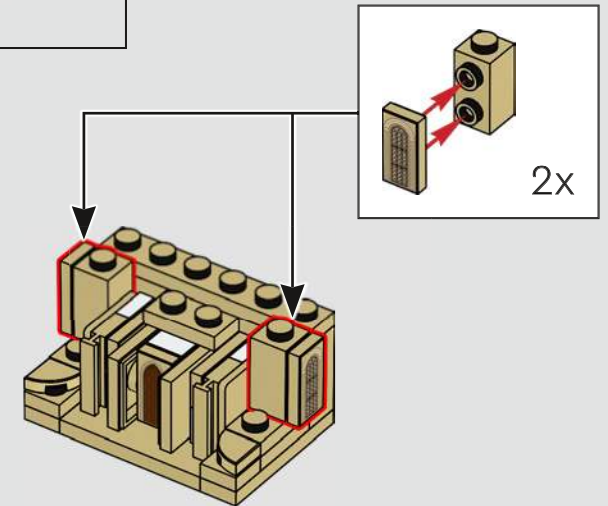

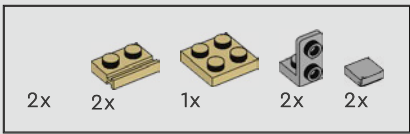

466

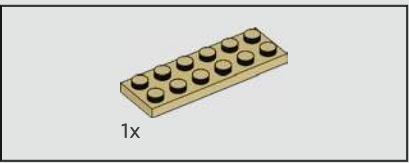
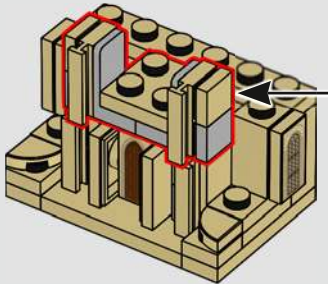
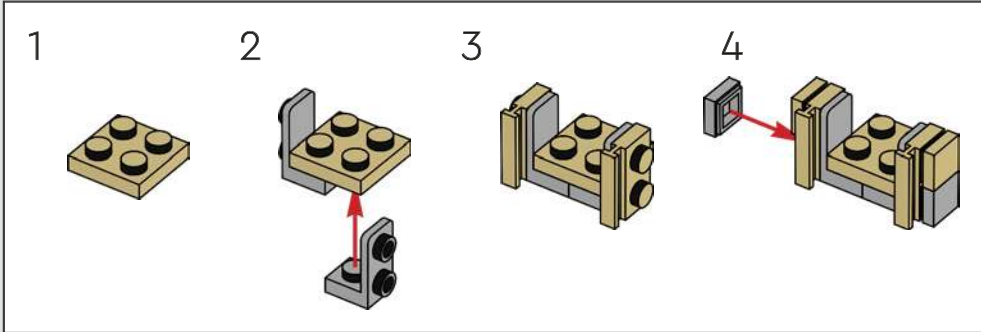

467

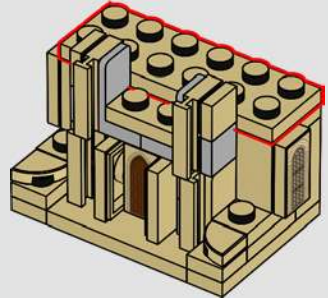

468



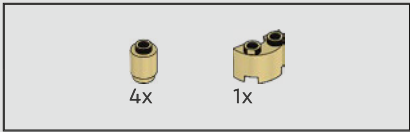

469

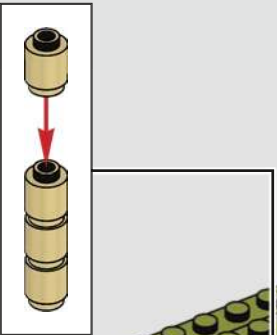

Hogwarts™ Castle



470

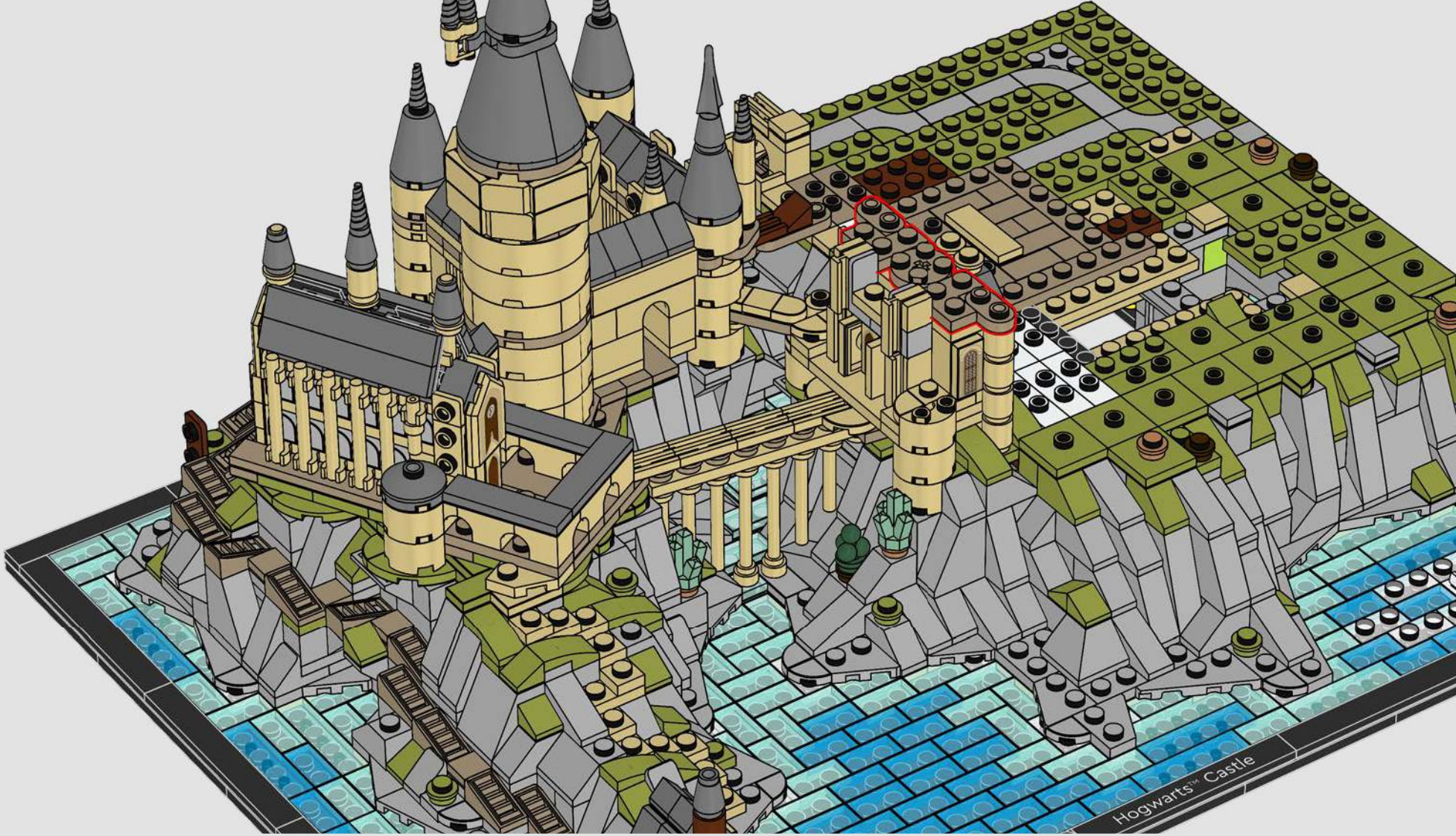

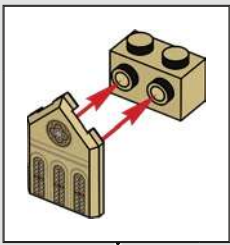
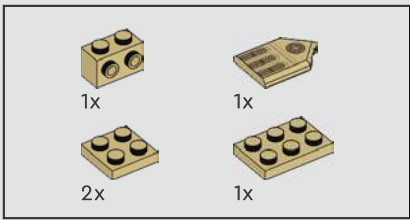

471

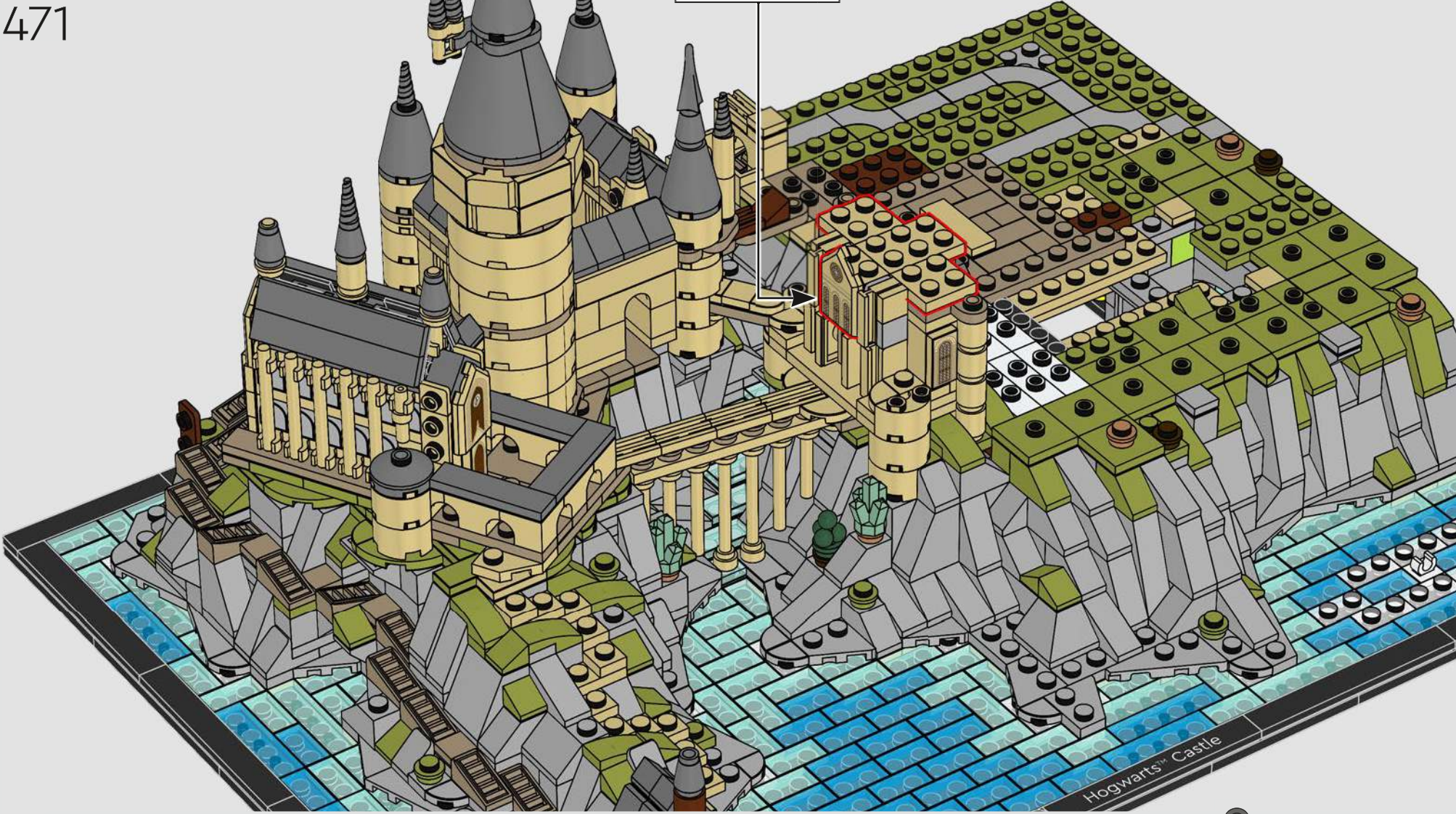

Hogwarts™ Castle

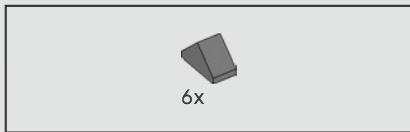

472

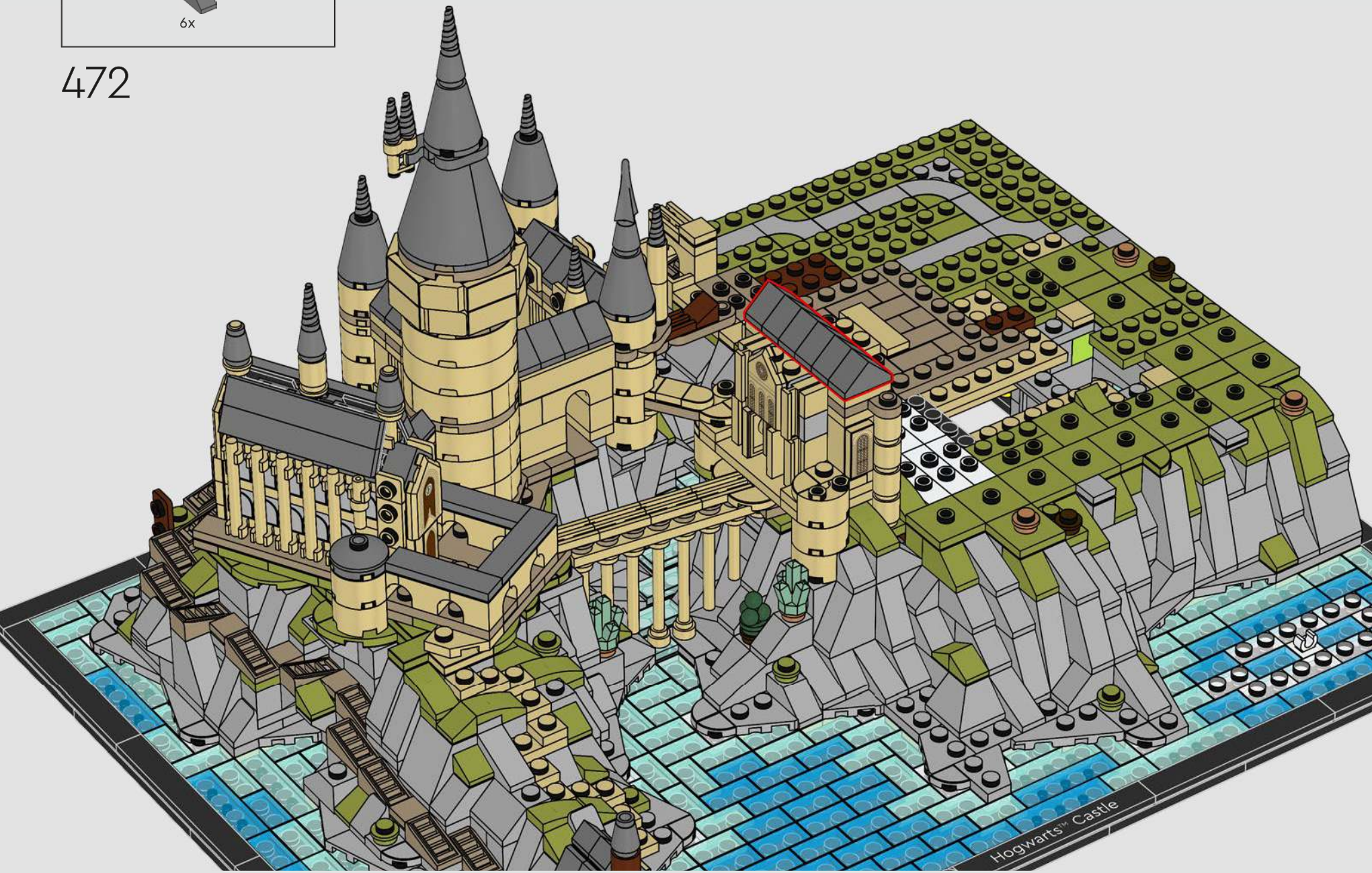

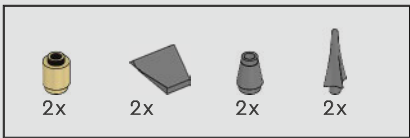

473

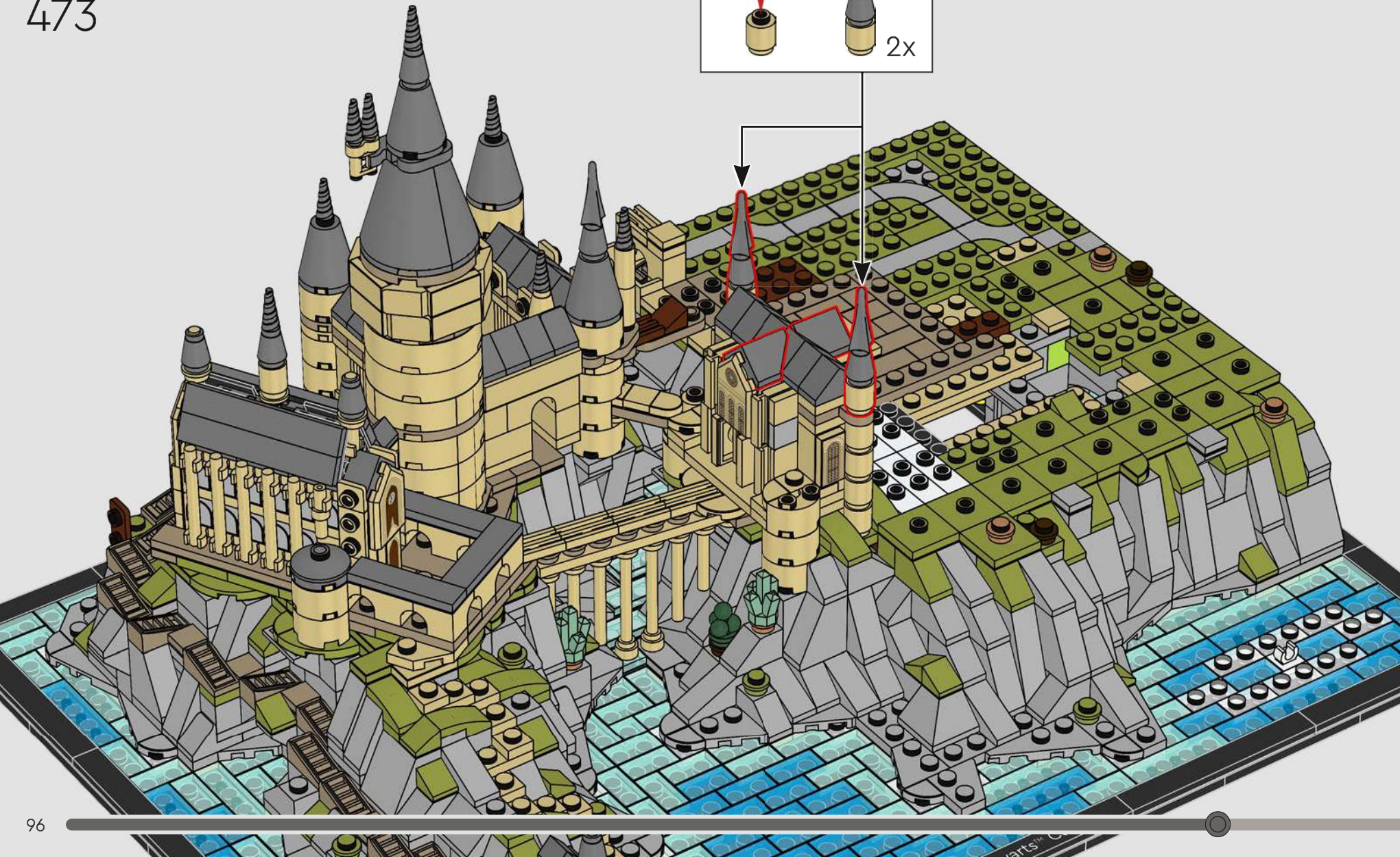
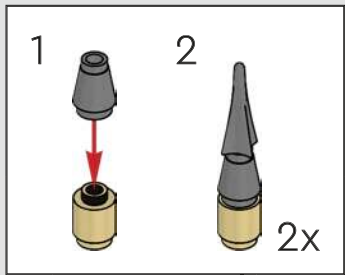

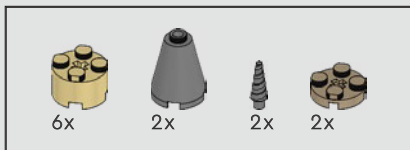

474

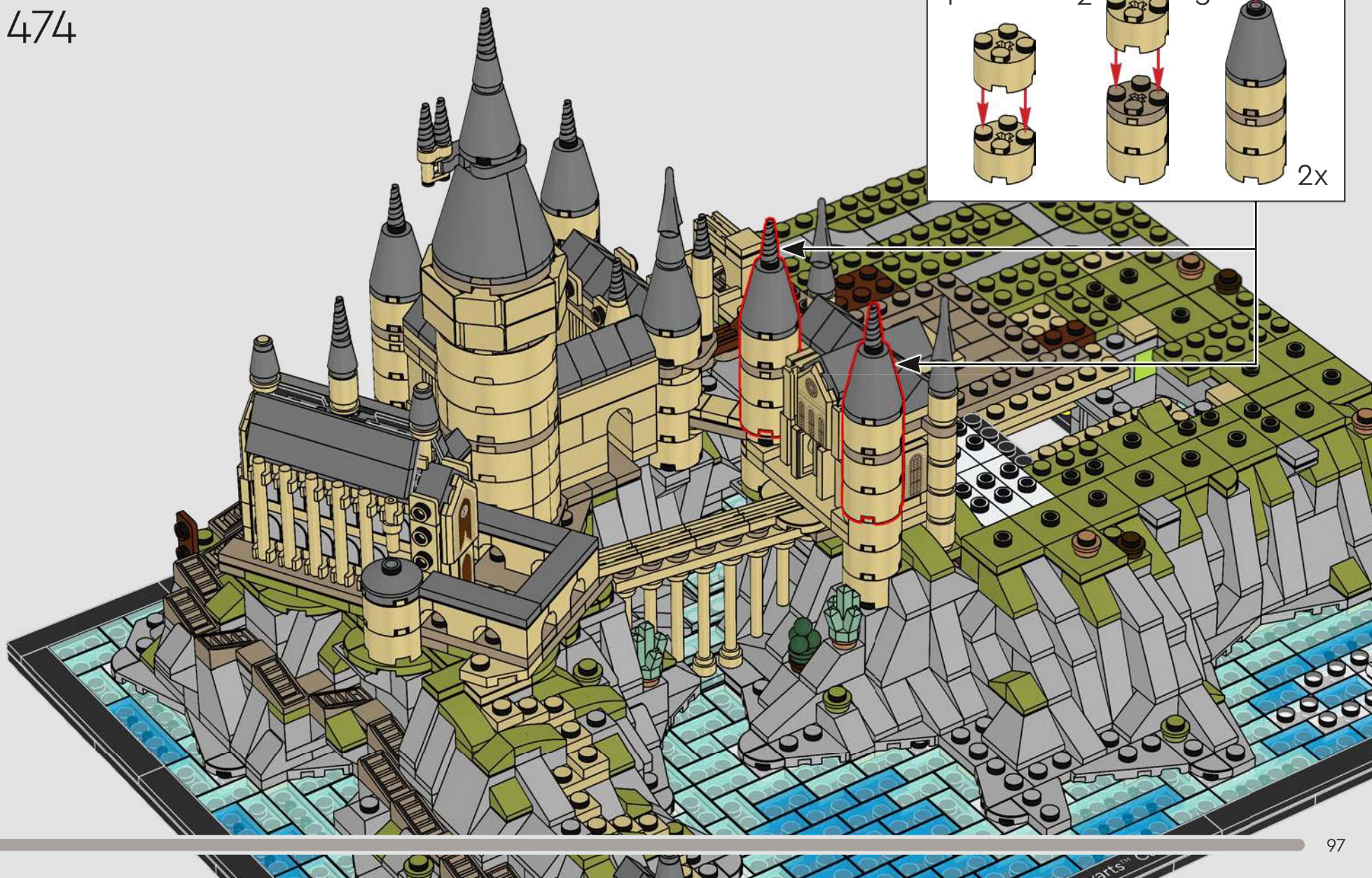
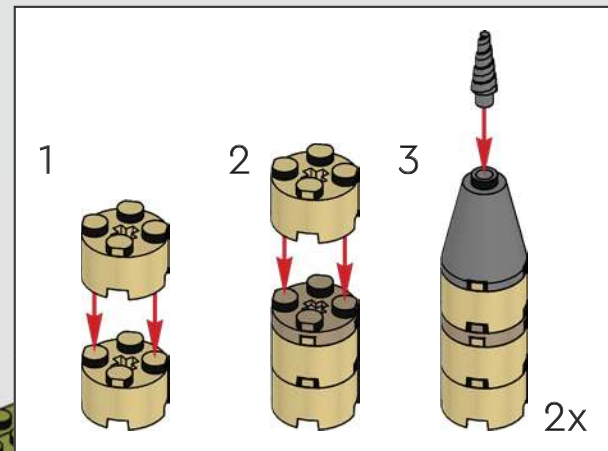

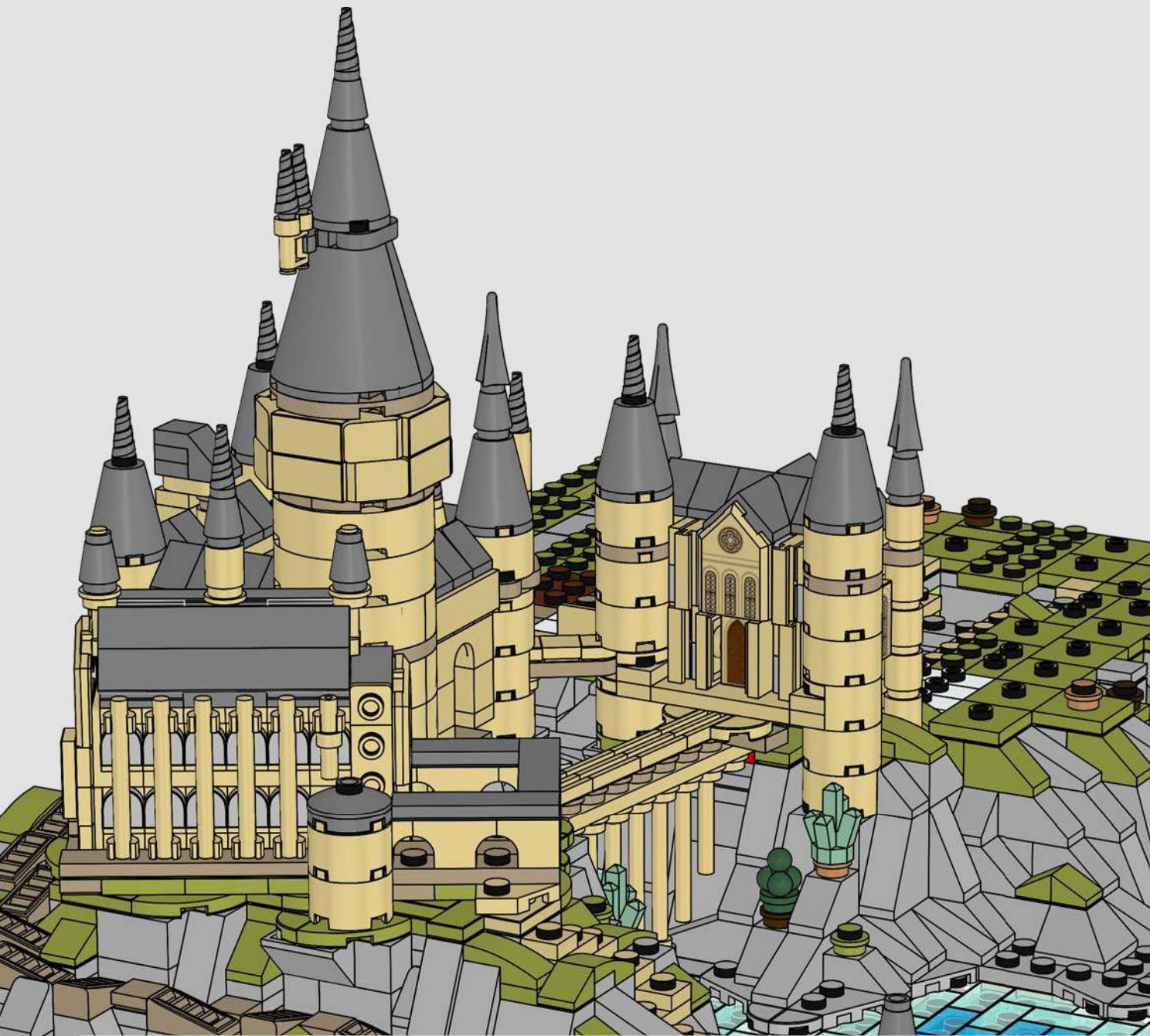

The girls' lavatories are located in this part of the castle. Maybe Moaning Myrtle™ will stop by as you build. Just watch out for trolls.





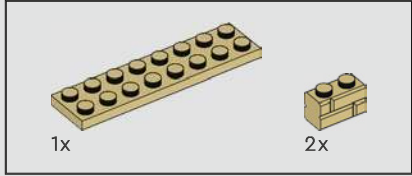
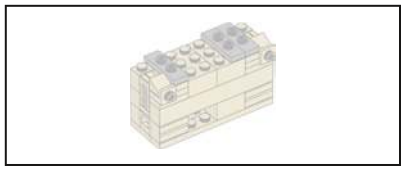

475

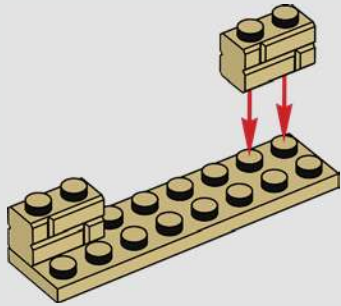

476

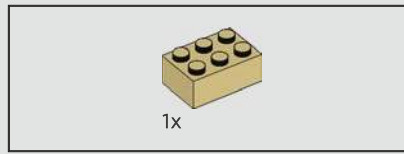
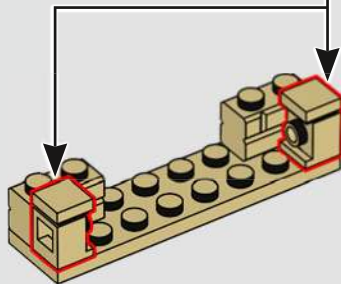
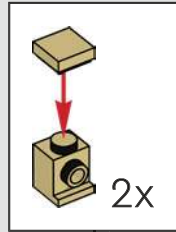

477

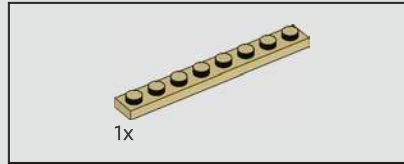
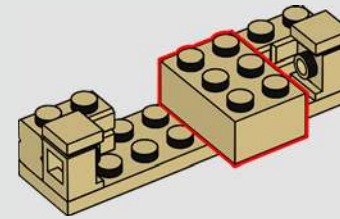

478

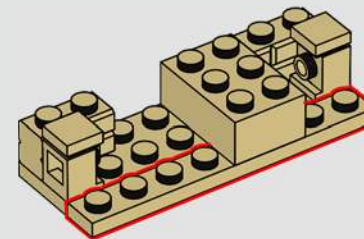

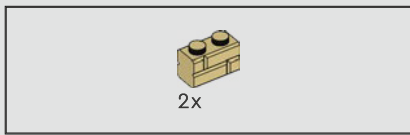

479

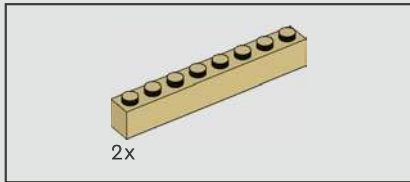
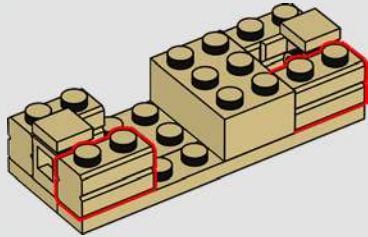

480

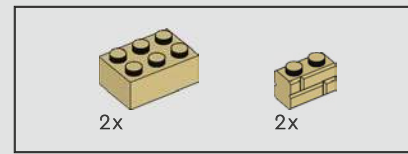
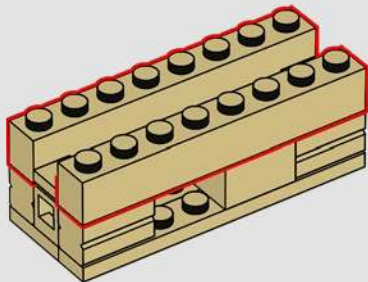

481

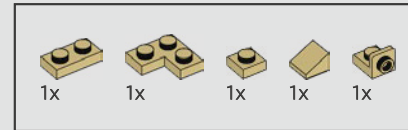
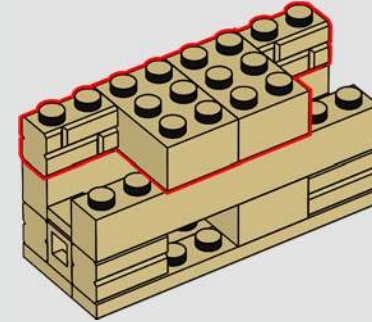

482

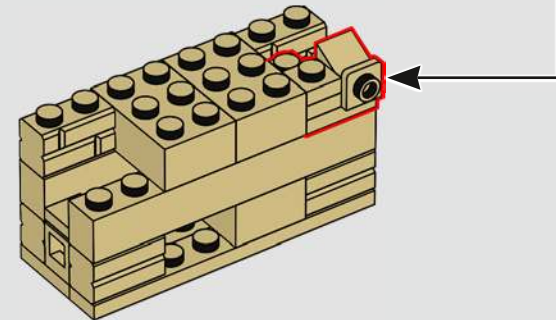
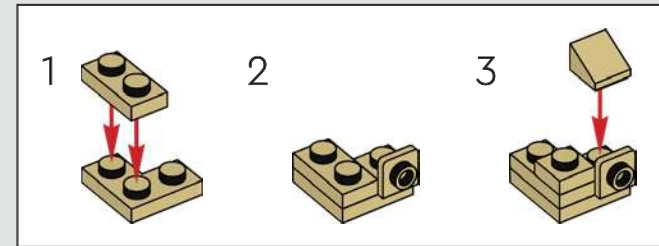

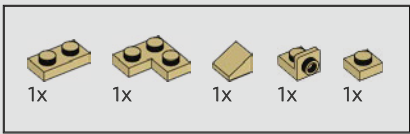

483

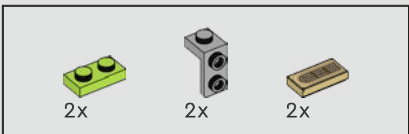
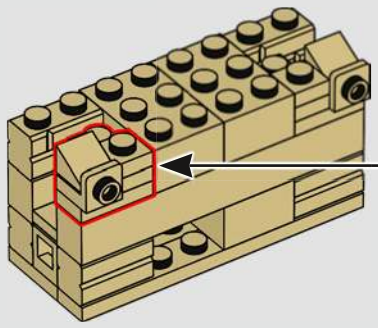
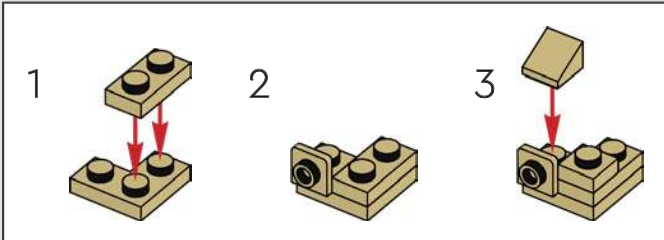

484

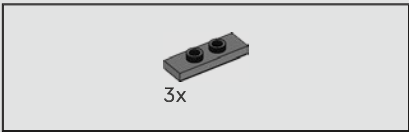
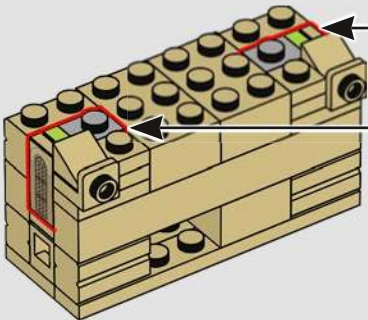
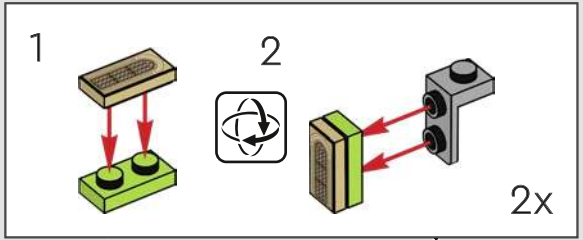

485

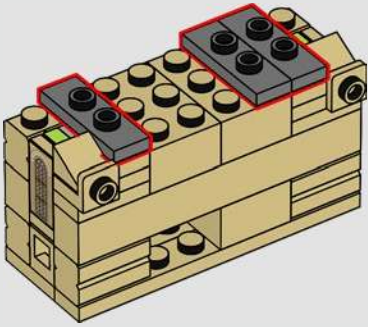

486

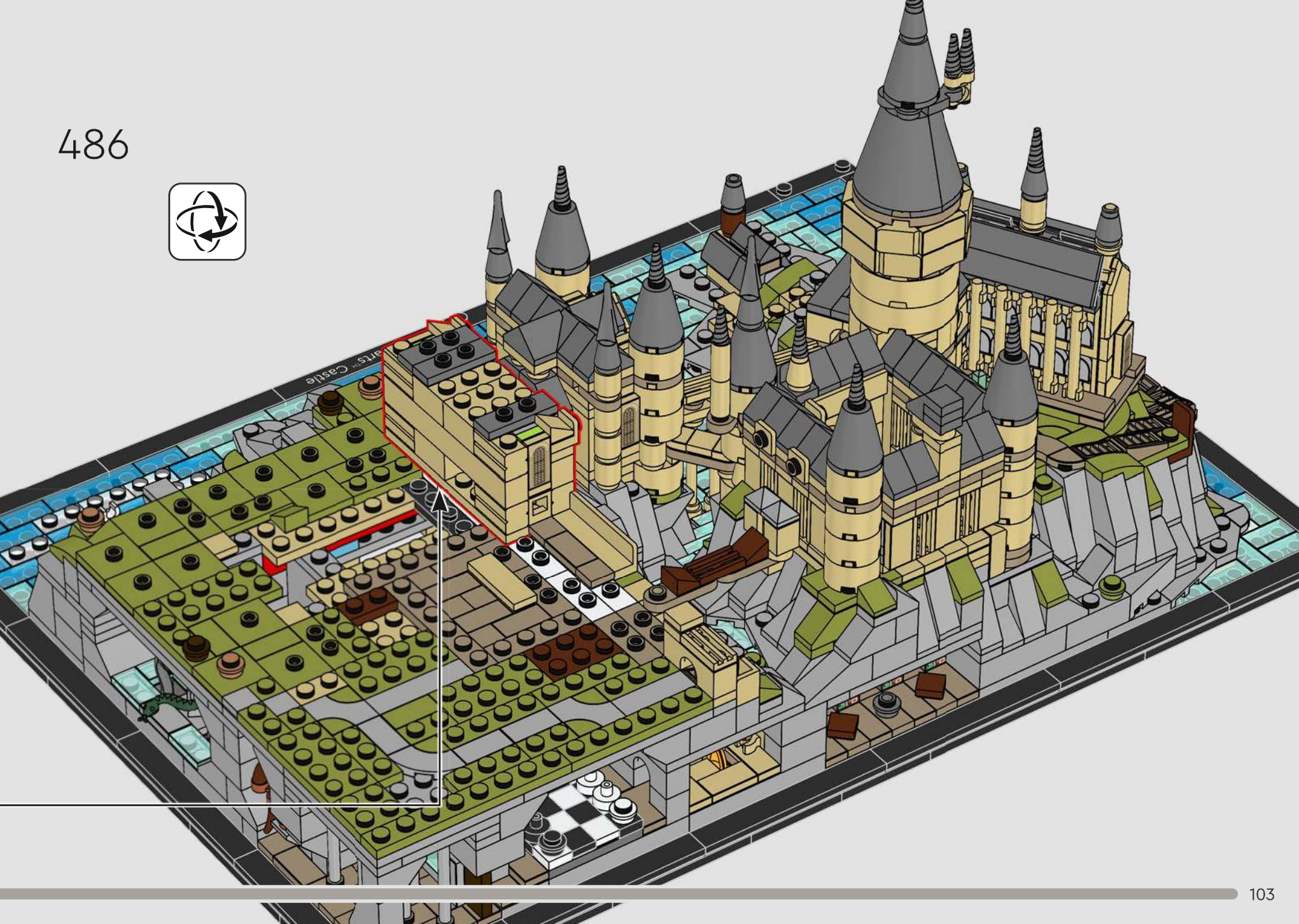

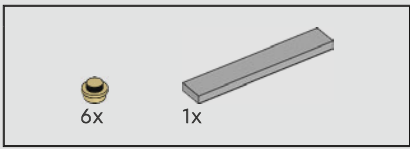

487

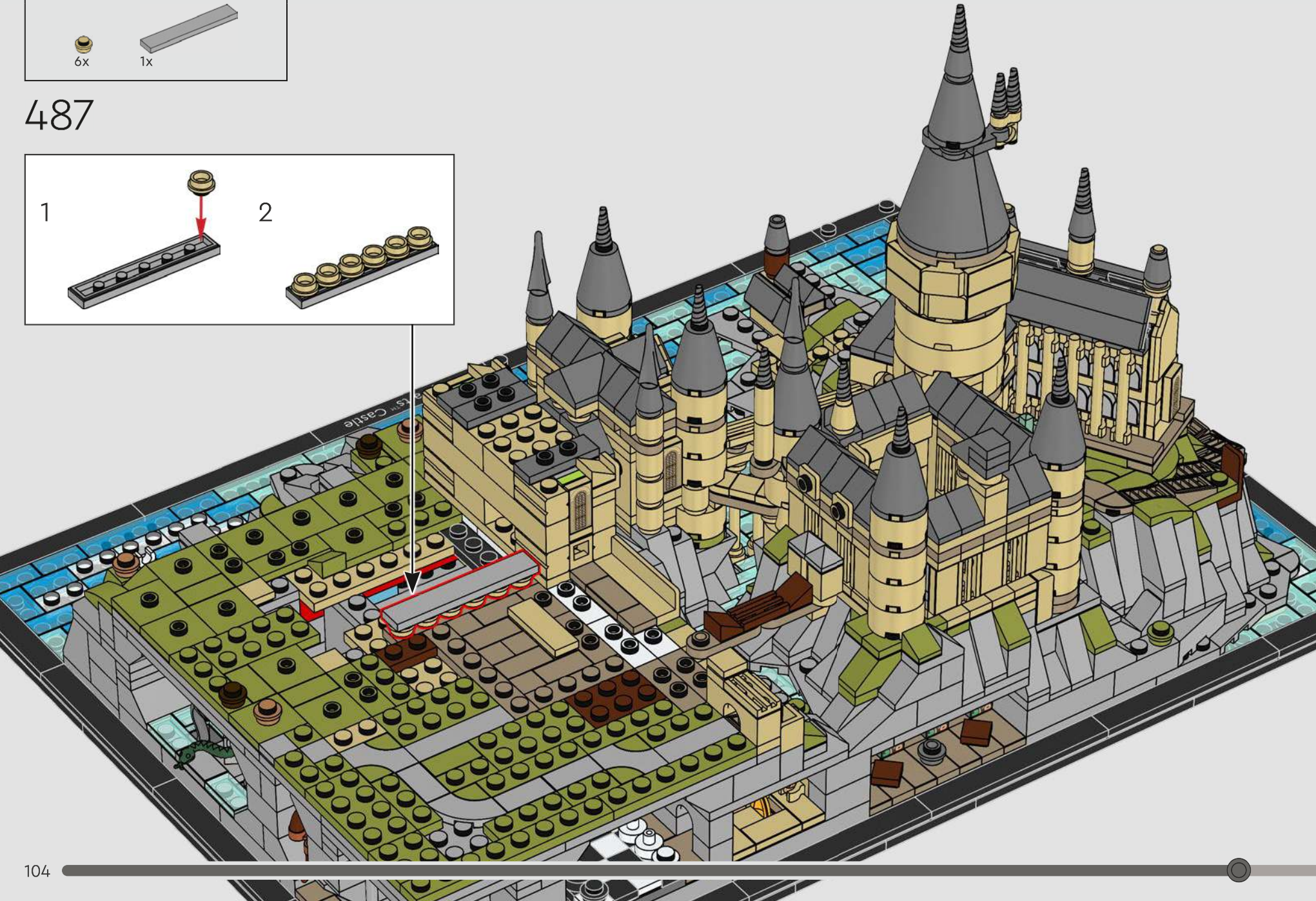
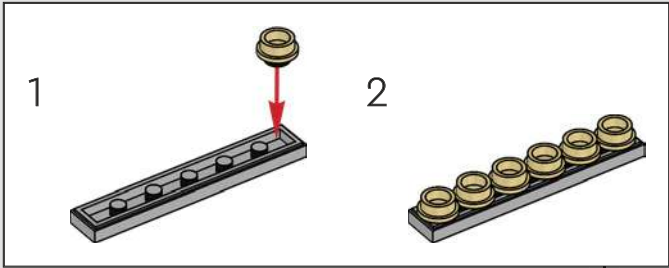

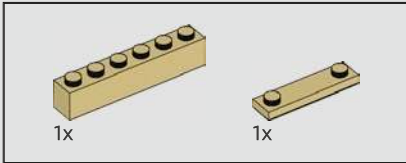
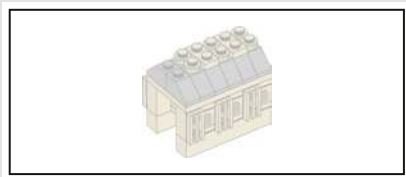

488

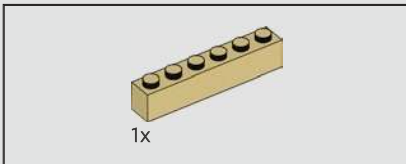
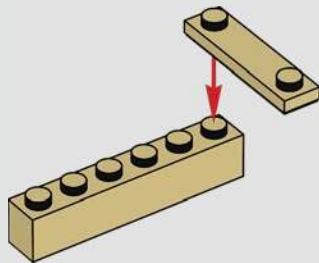

489

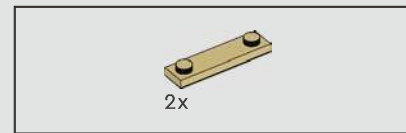
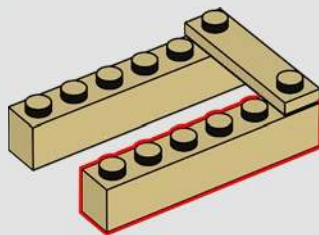

490

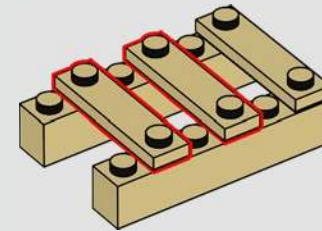

491

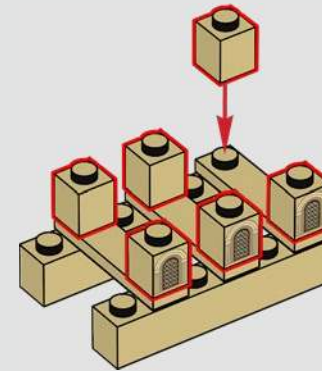

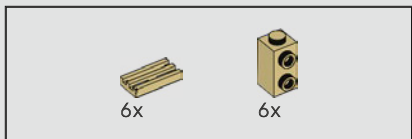

492

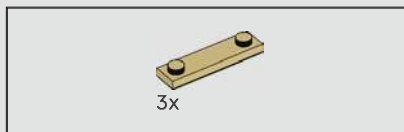
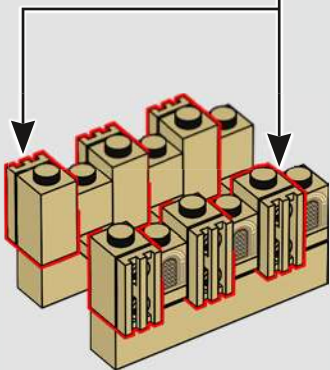
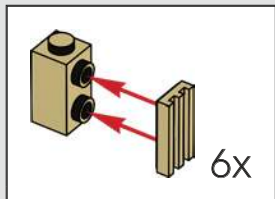

493

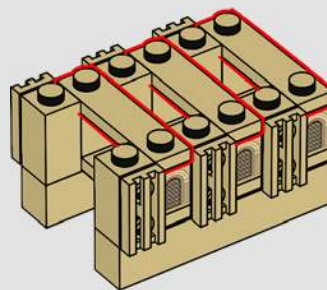

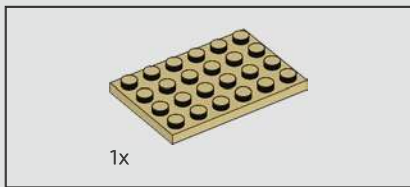

494

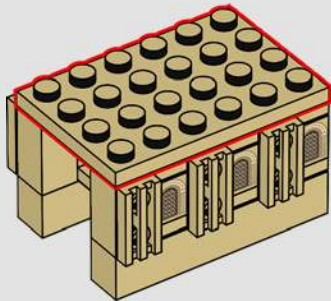

495

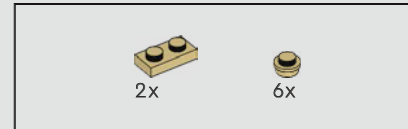
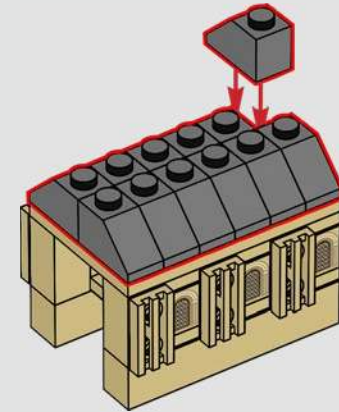

496

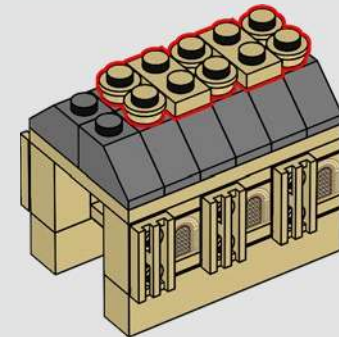

497

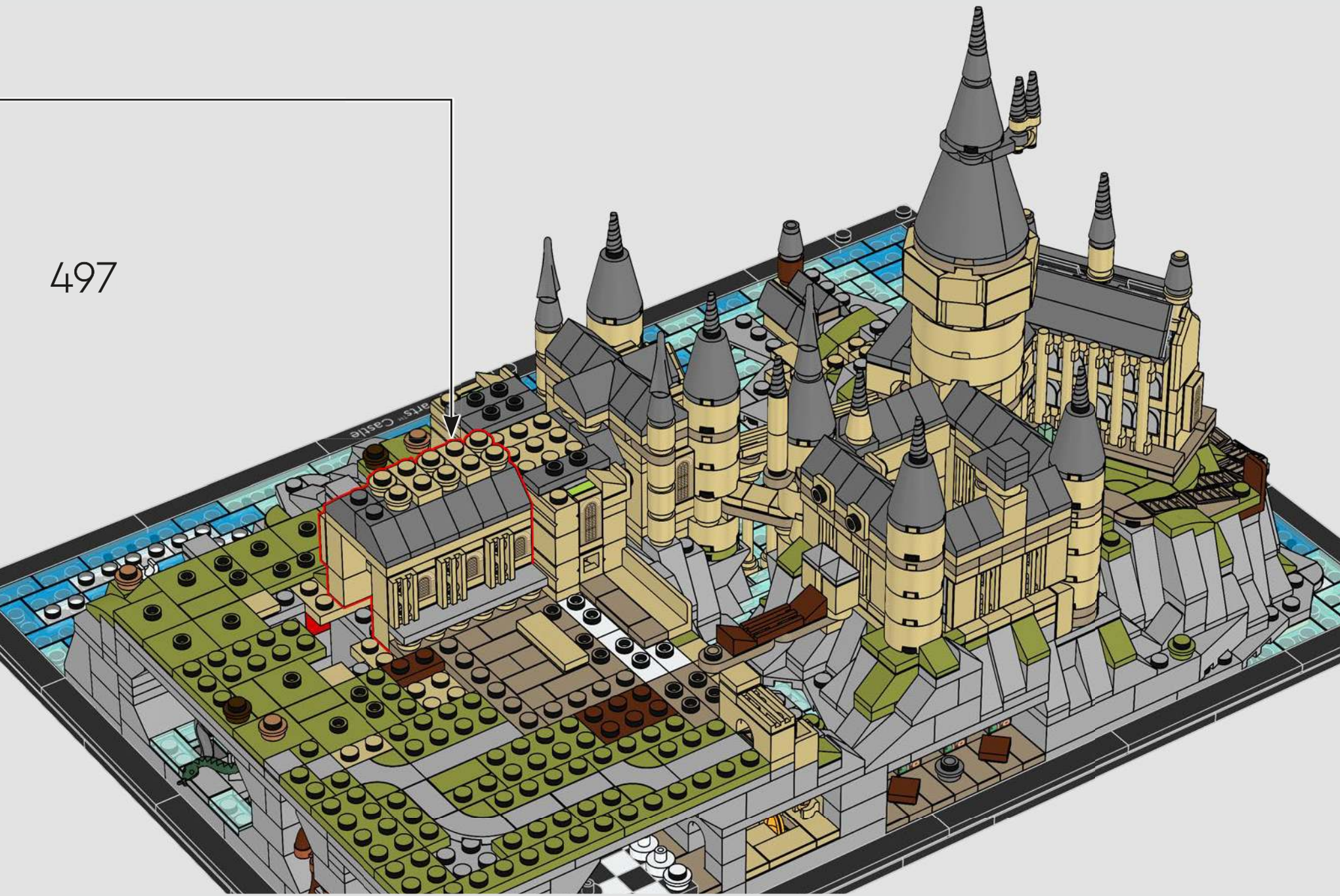

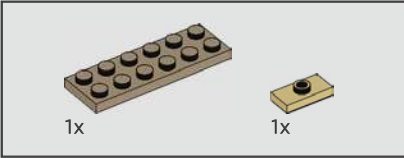
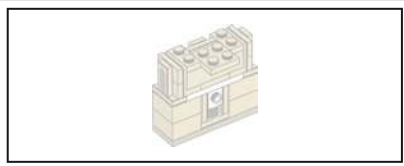

498

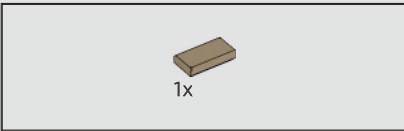
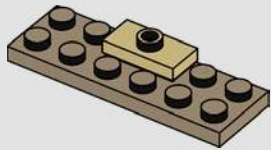

499

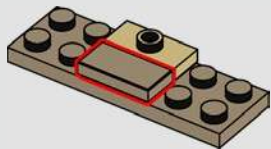

500

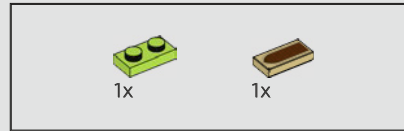
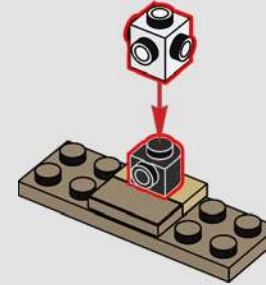

501

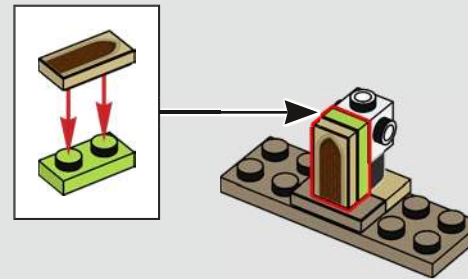

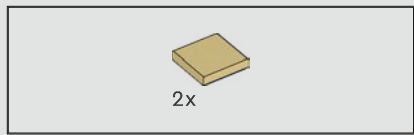

502

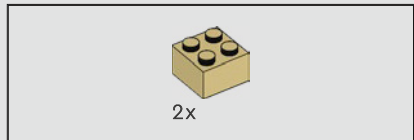
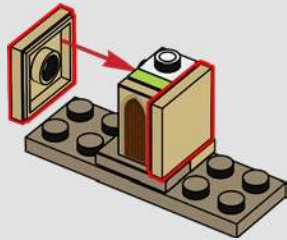

503

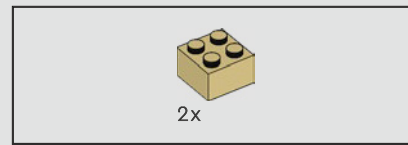
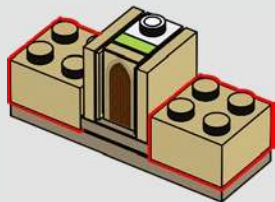

504

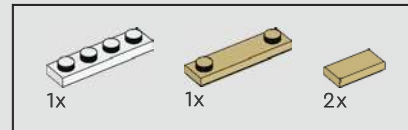
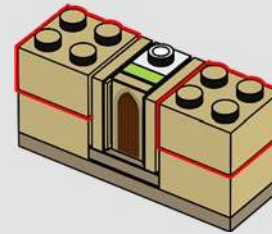

505

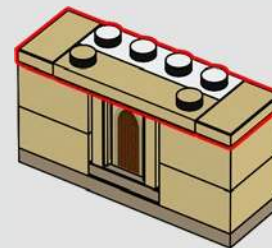

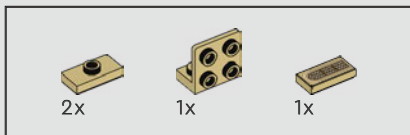

506

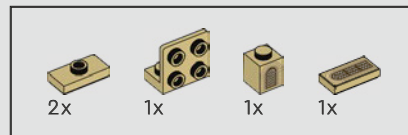
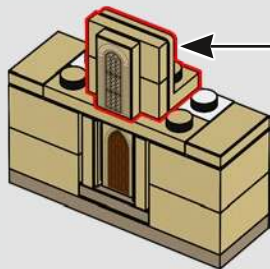
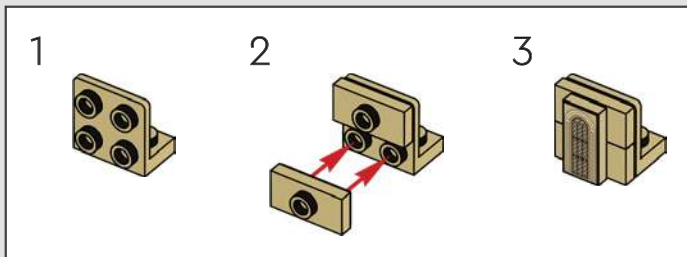

507

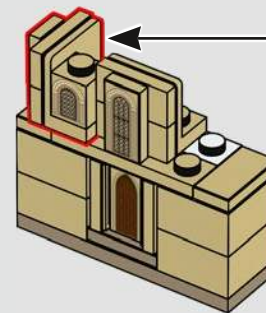
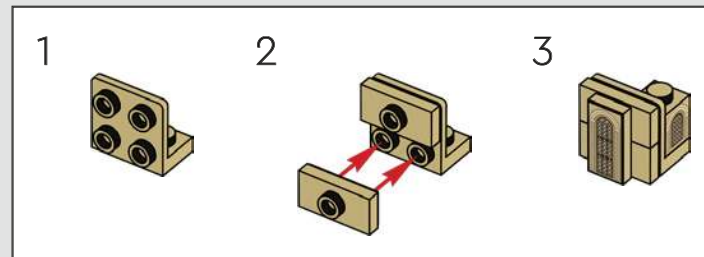

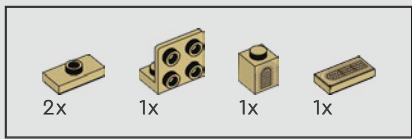

508

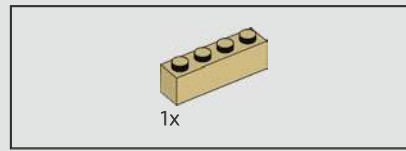
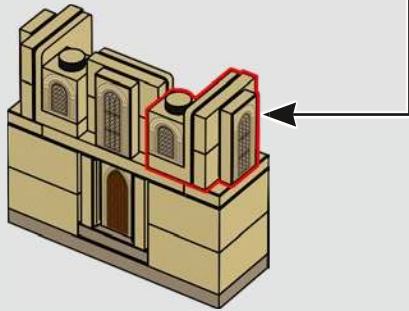
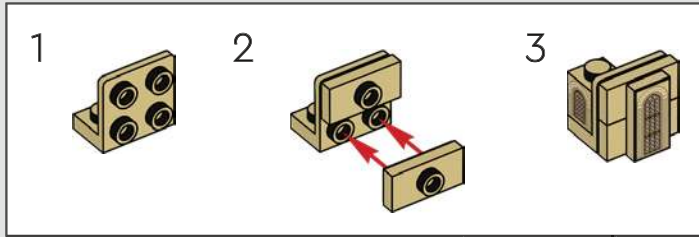

509

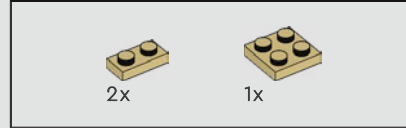
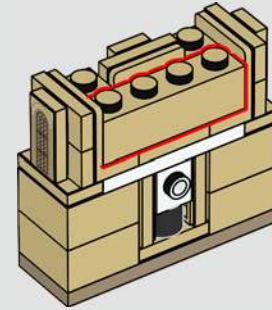

510

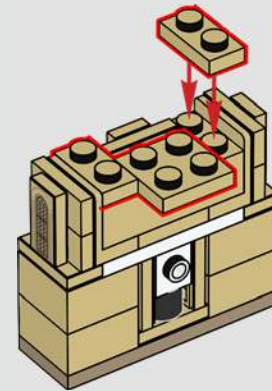

511





2x

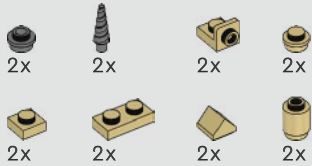

512

1



2



3



4

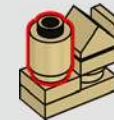

5

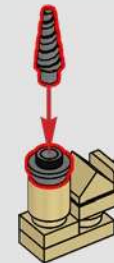

2x



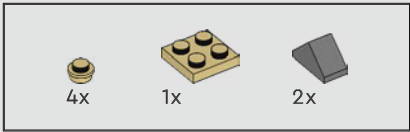

513

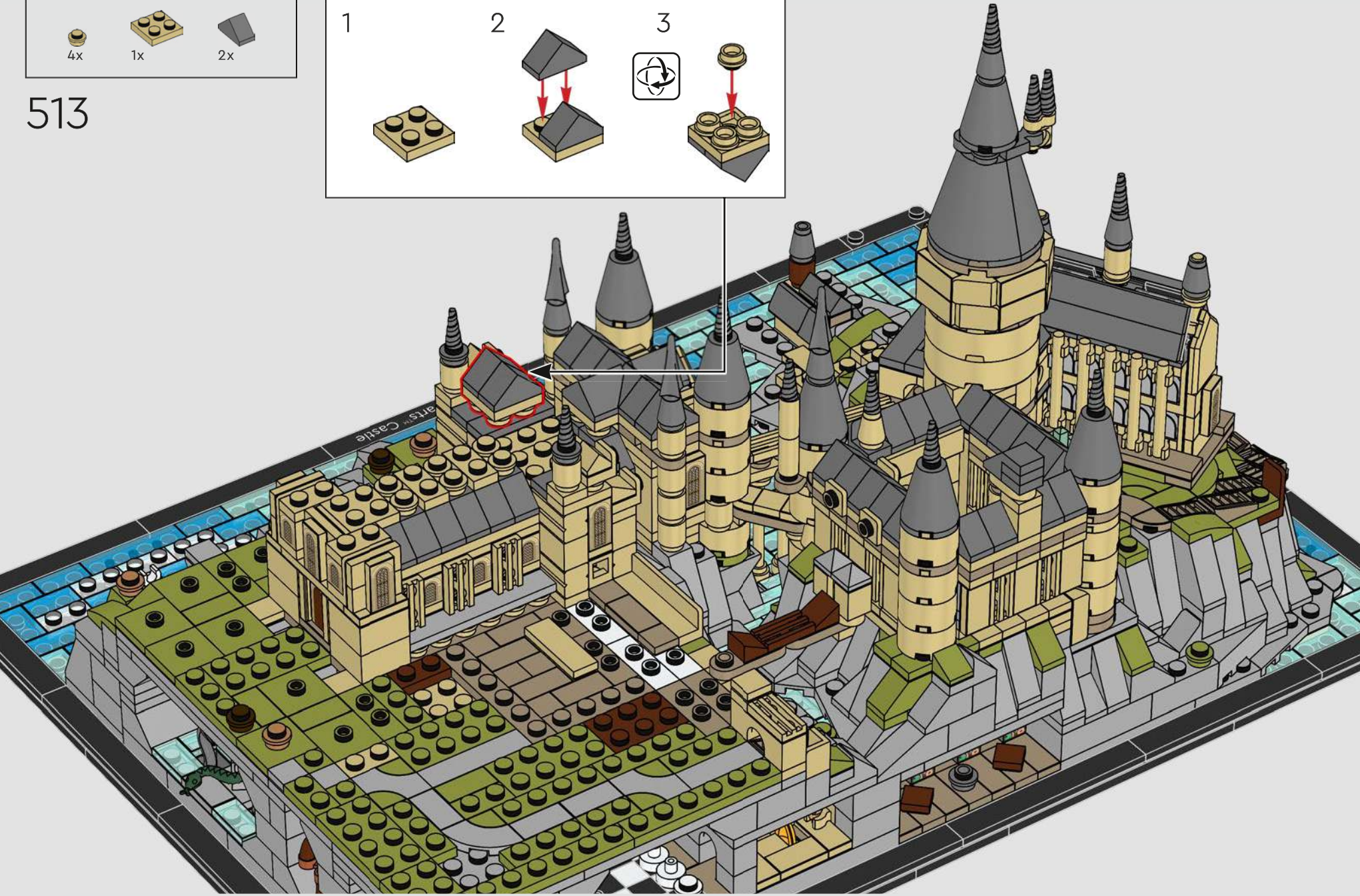
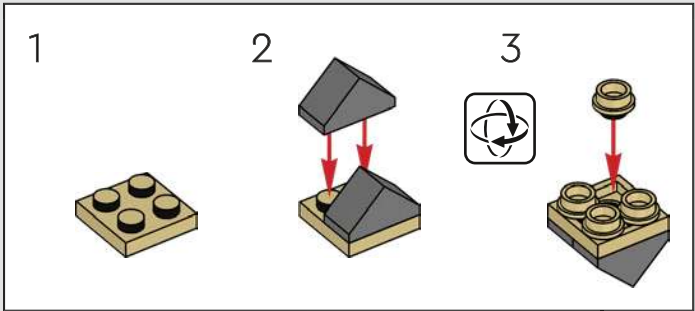

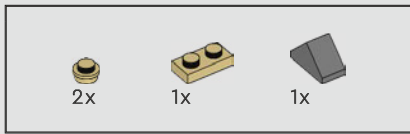

514

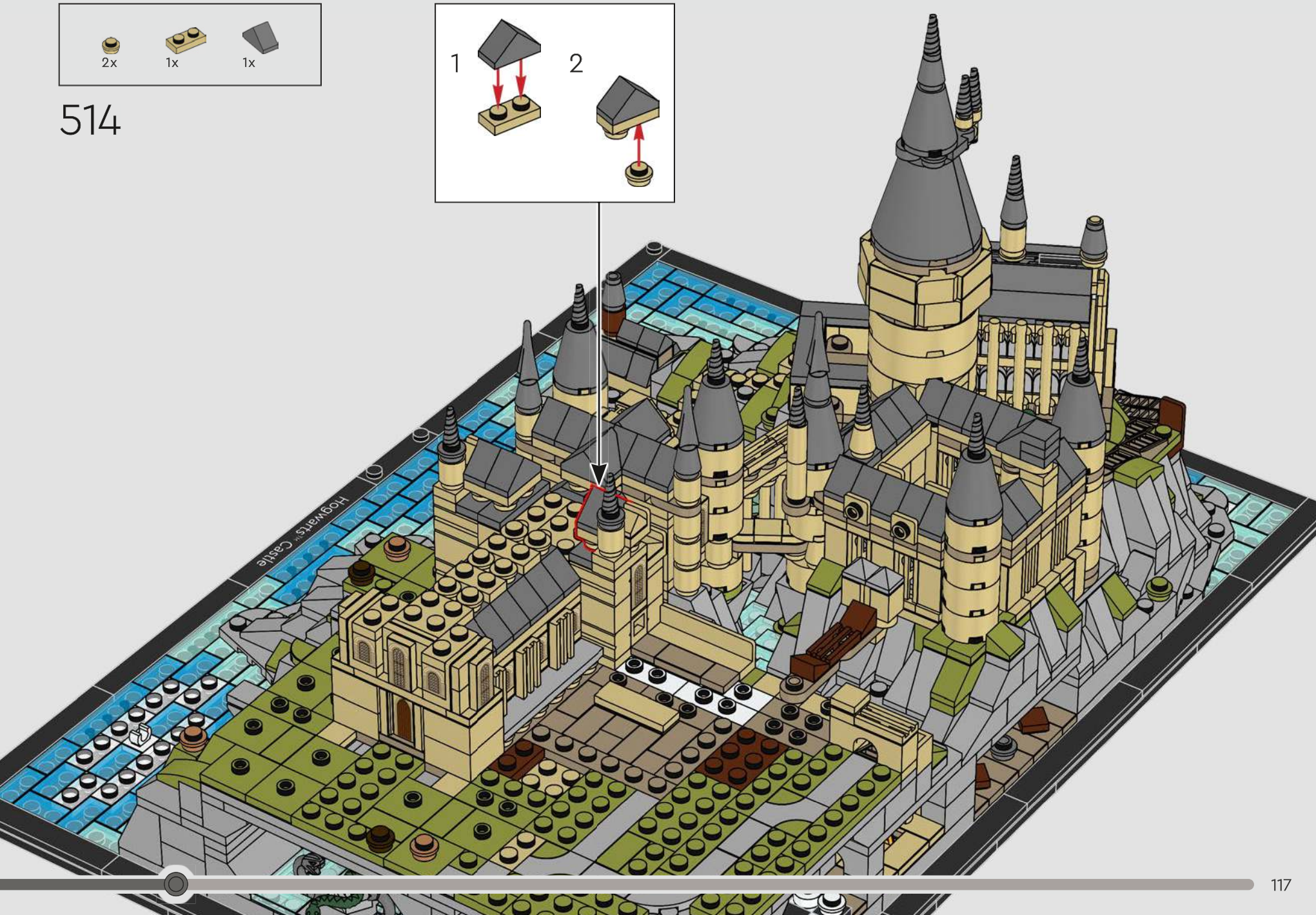
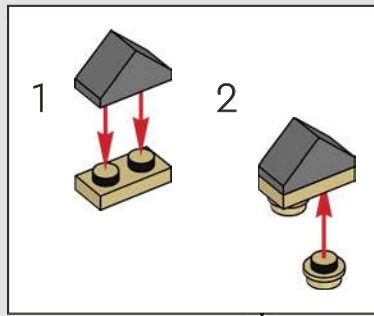

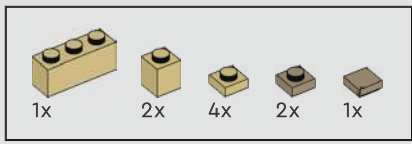

515

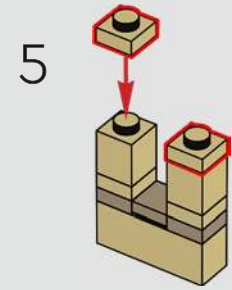
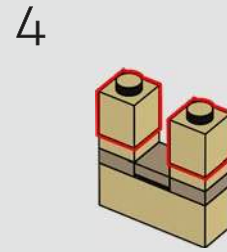
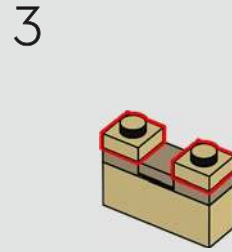
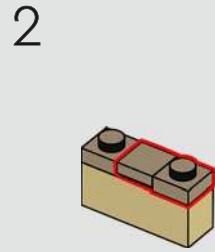
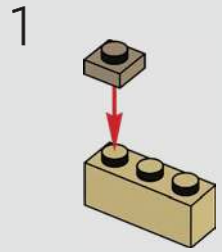

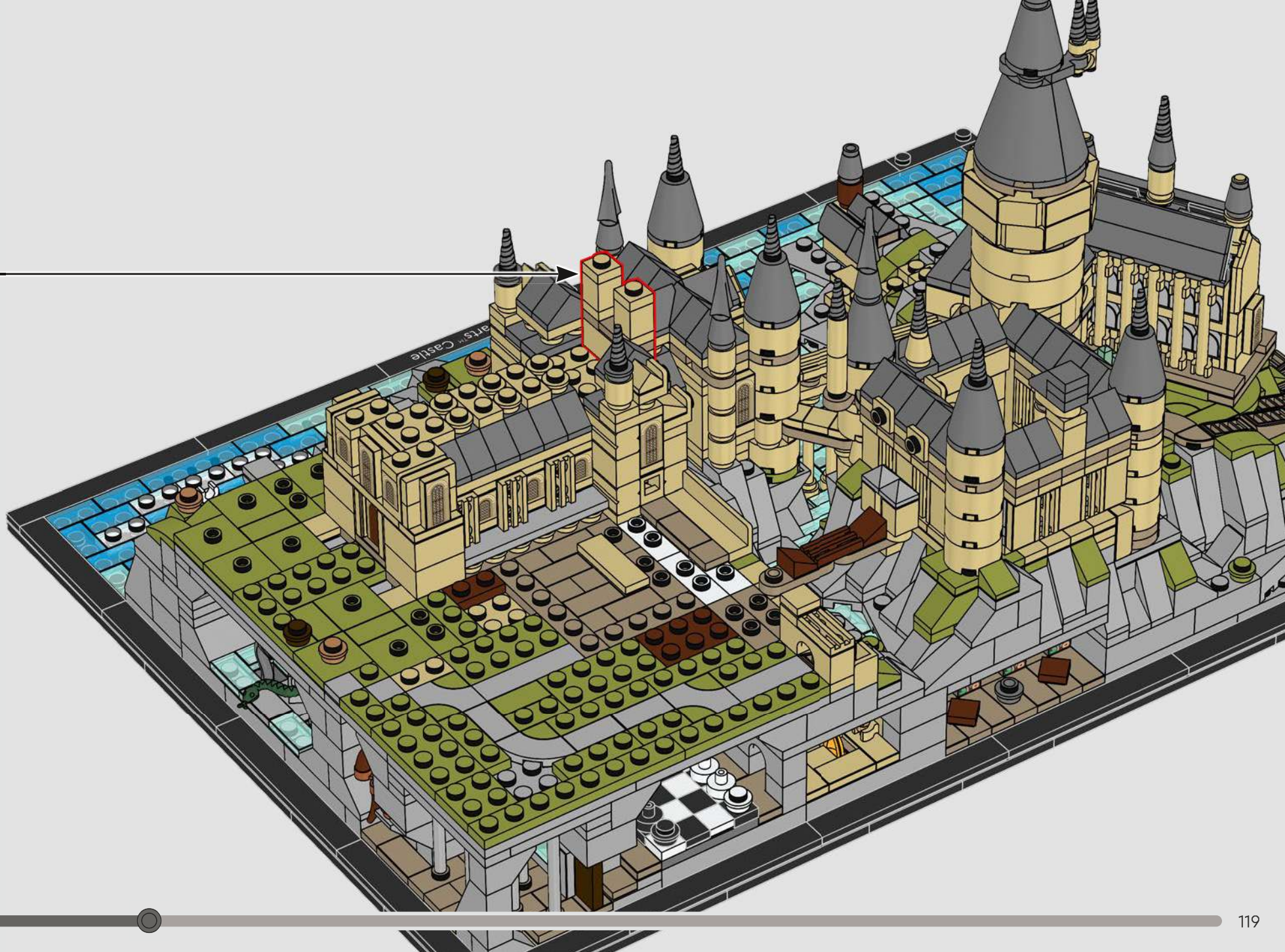

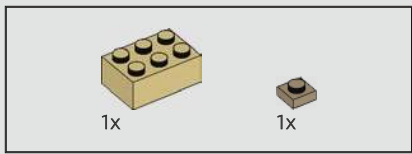

516

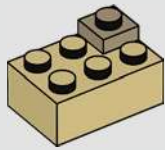

517

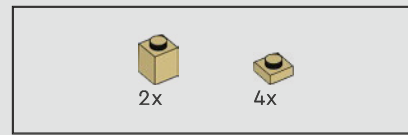
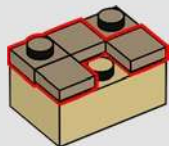

518

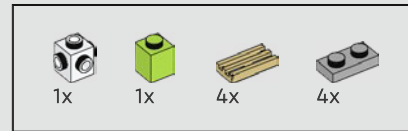
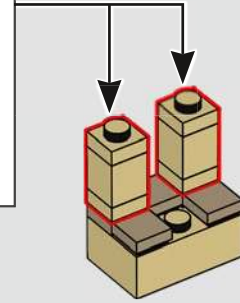
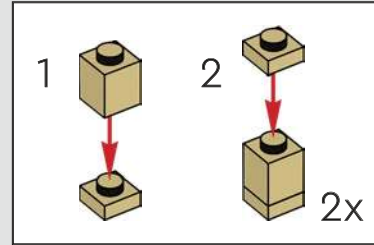

519

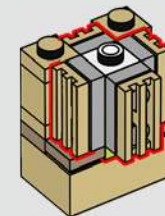
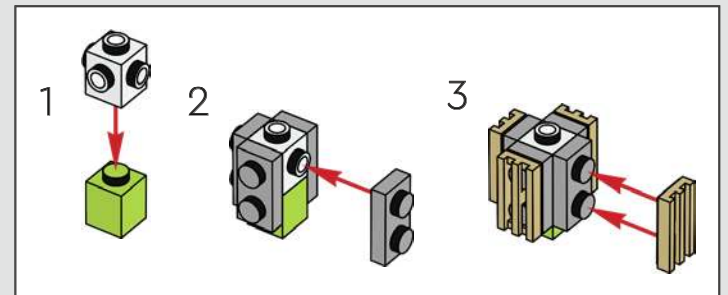

520

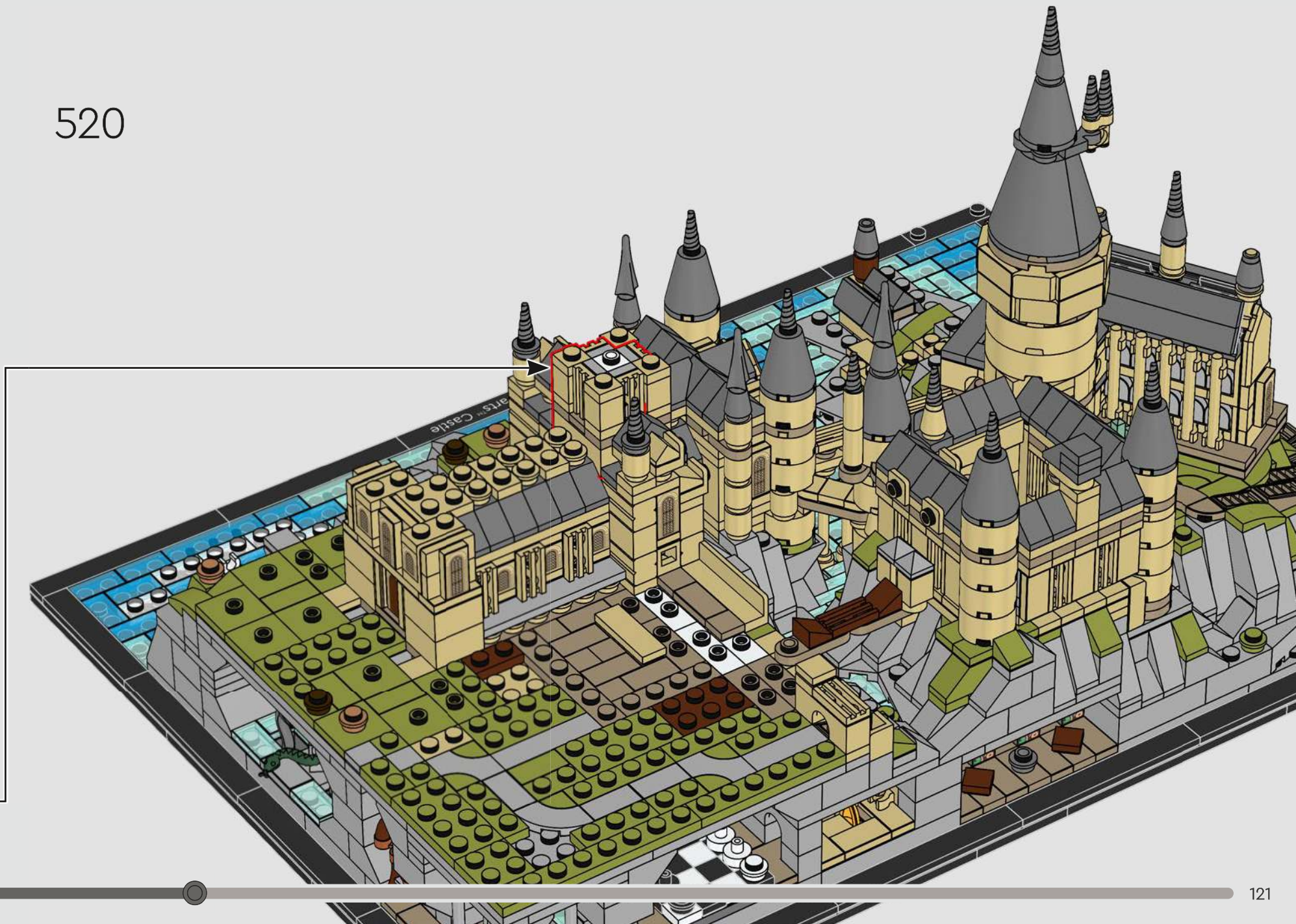

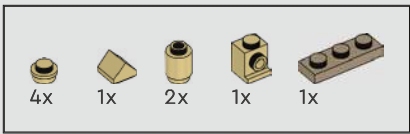

521

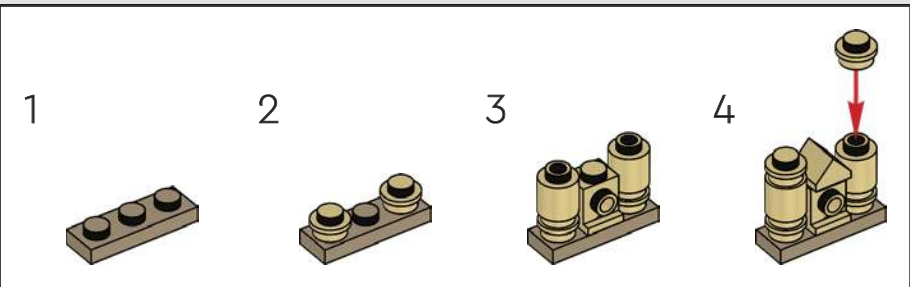

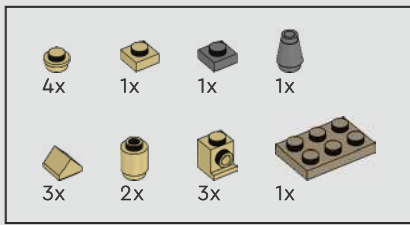

522

1



2

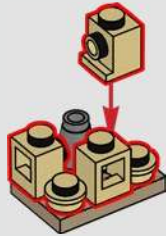

3



4



5

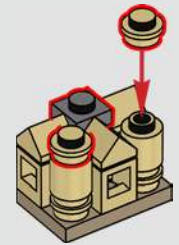

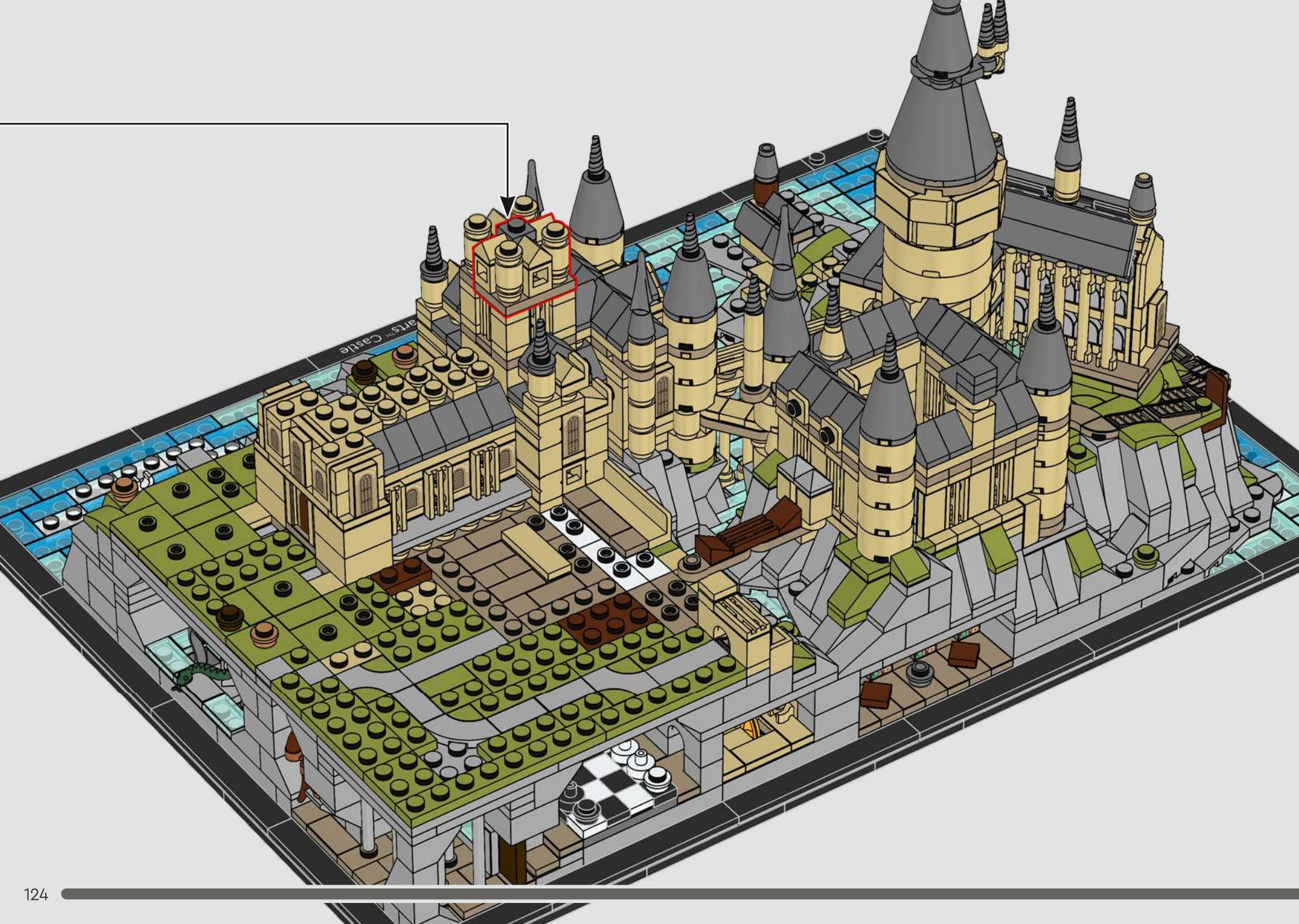



523



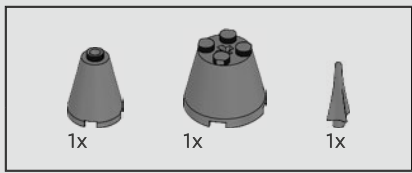

524

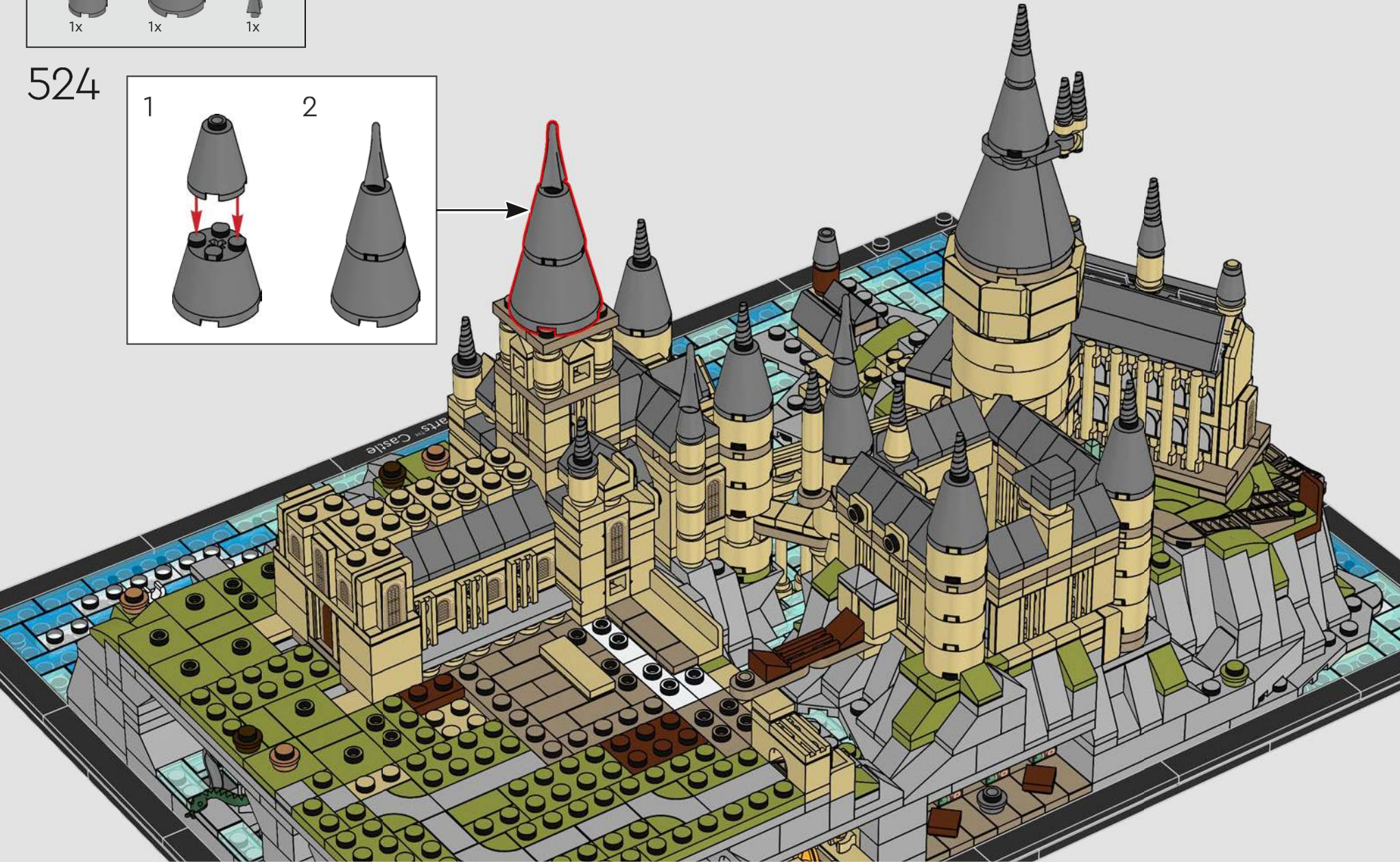
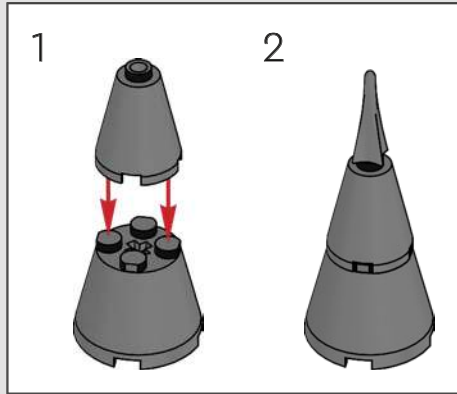

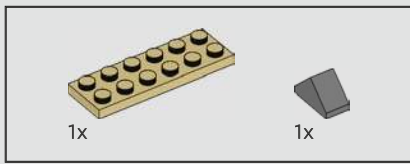

525

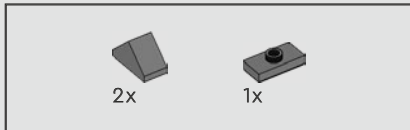
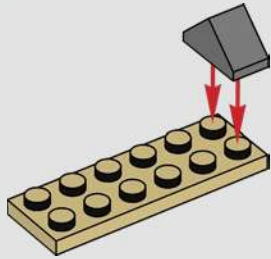

526

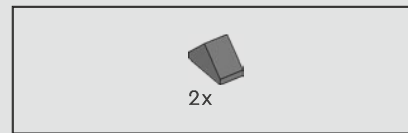
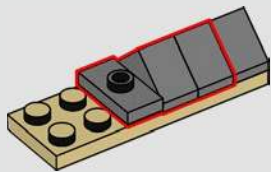

527

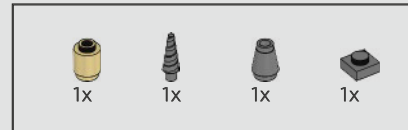
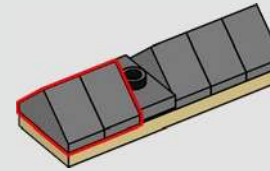

528

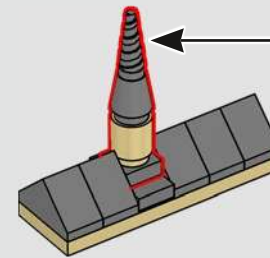
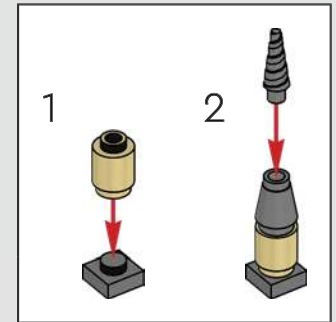

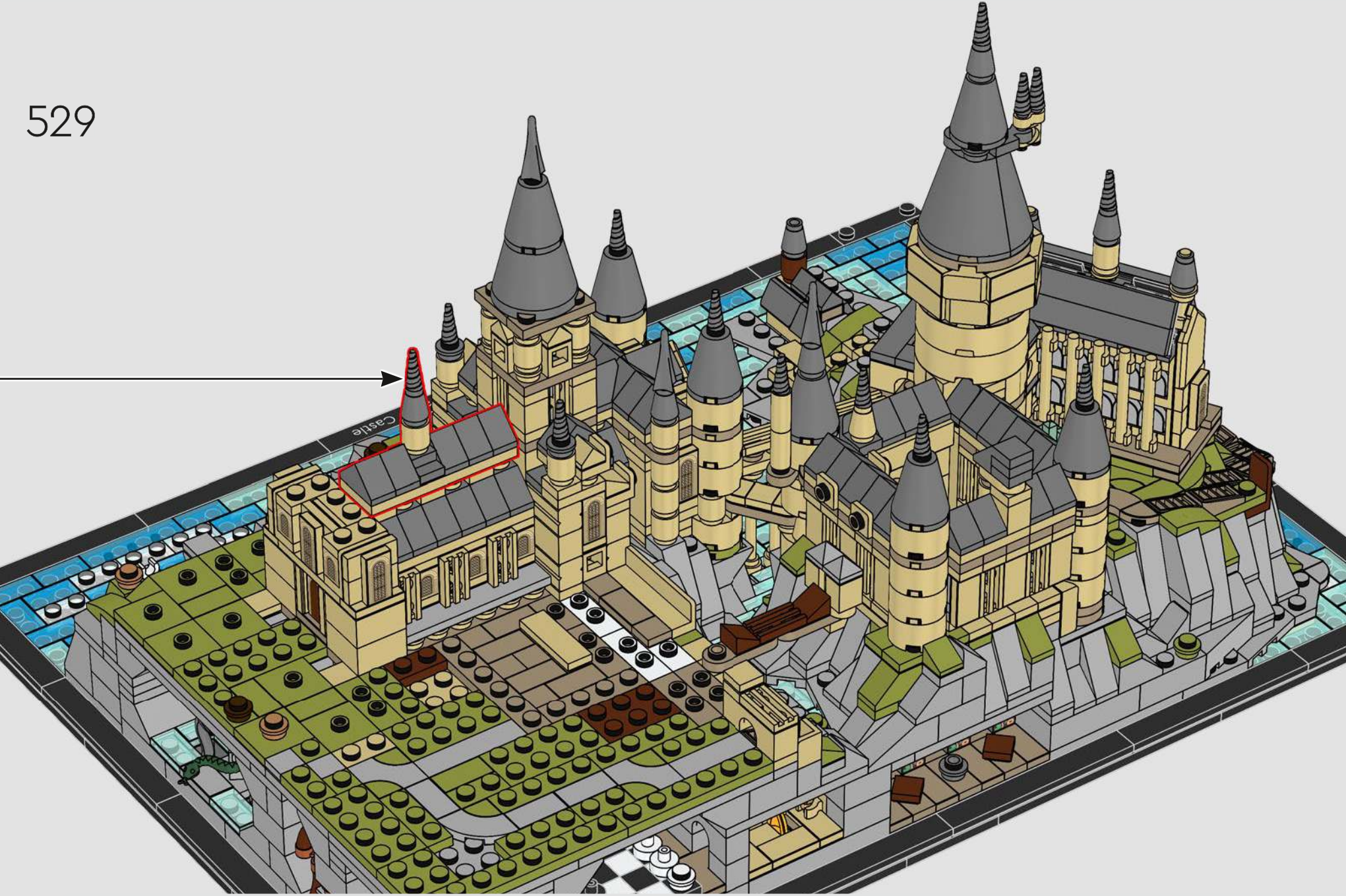

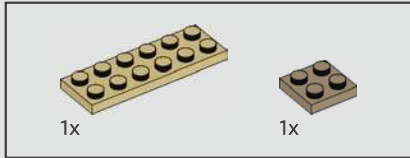
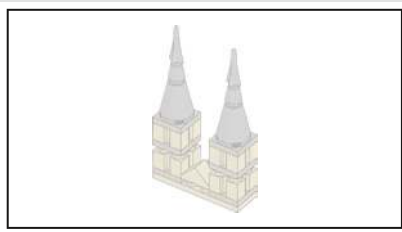

530

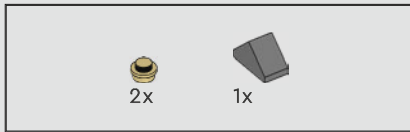
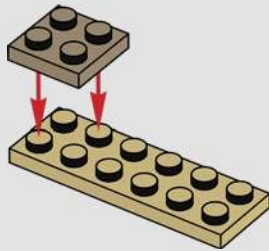

531

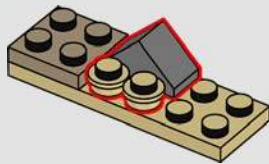

532

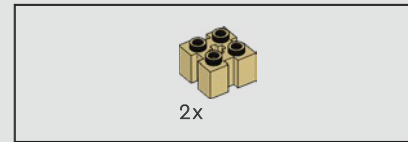
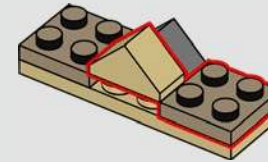

533

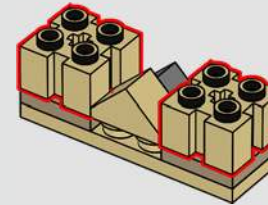



8x

534

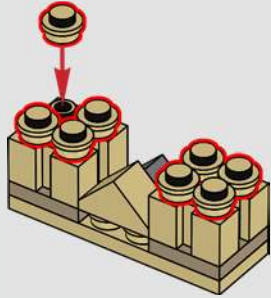

2x

535

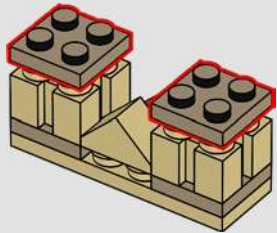

2x

536

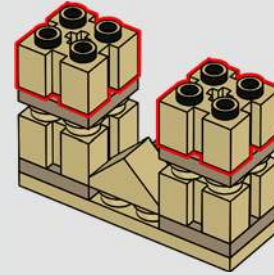

2x

537

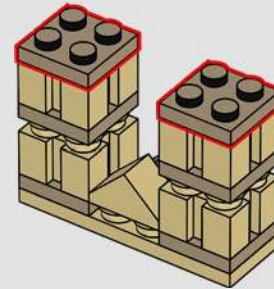

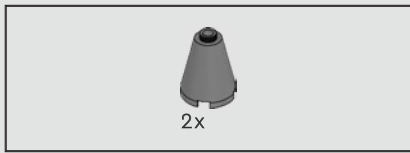

538

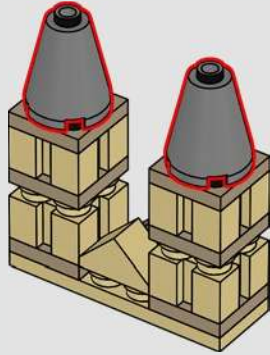

539

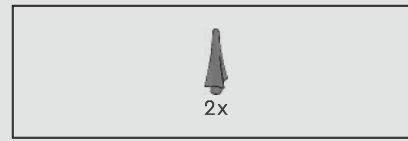
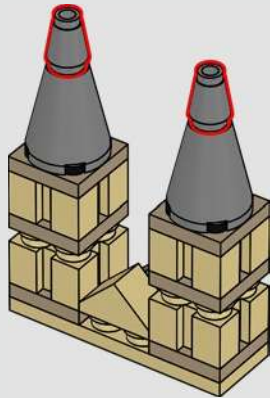

540

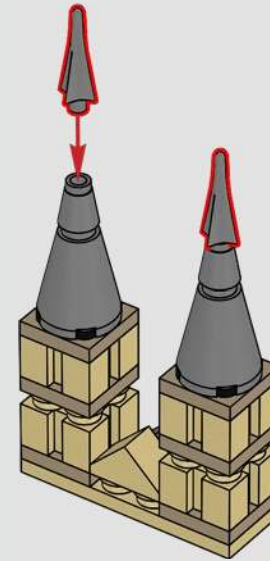

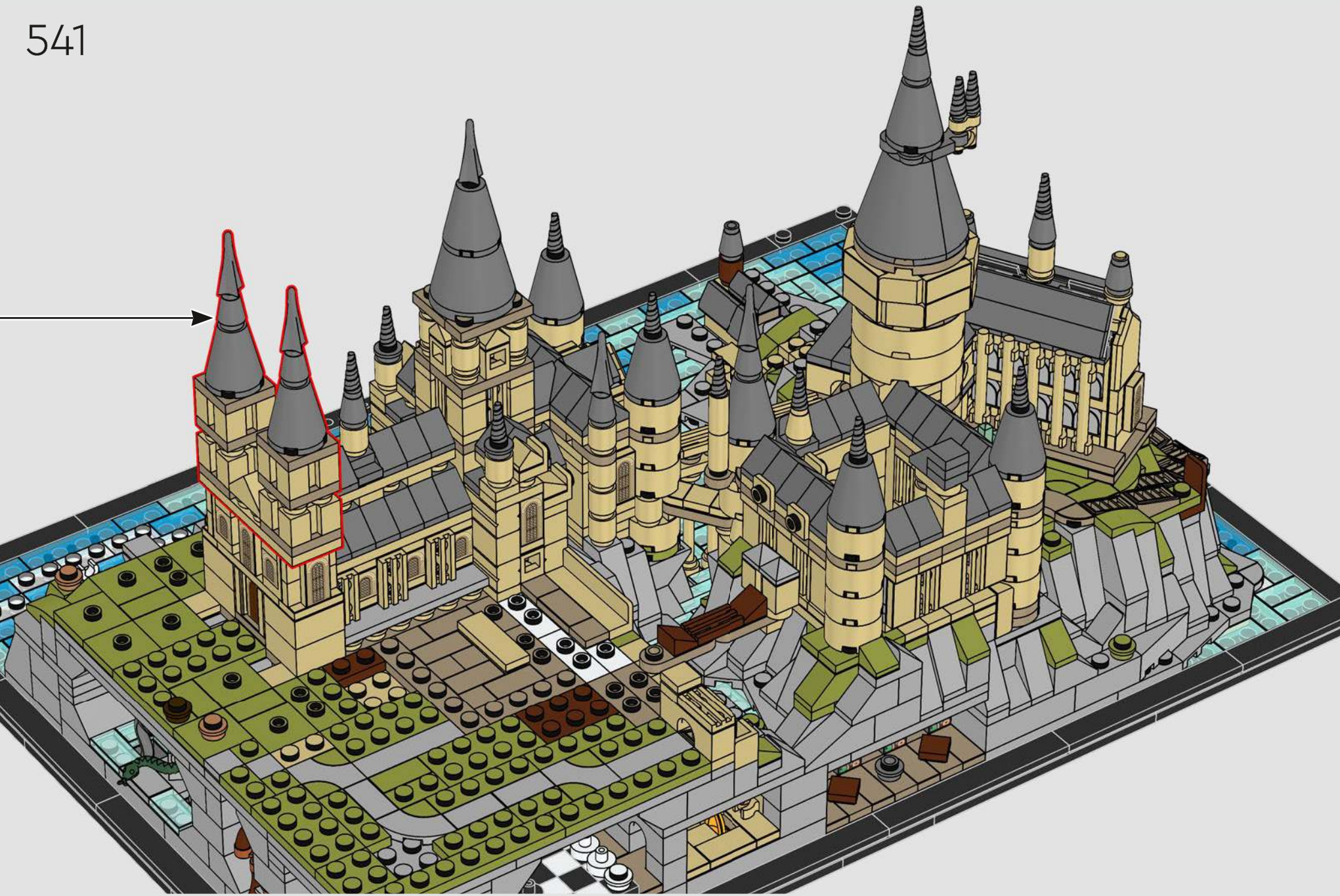

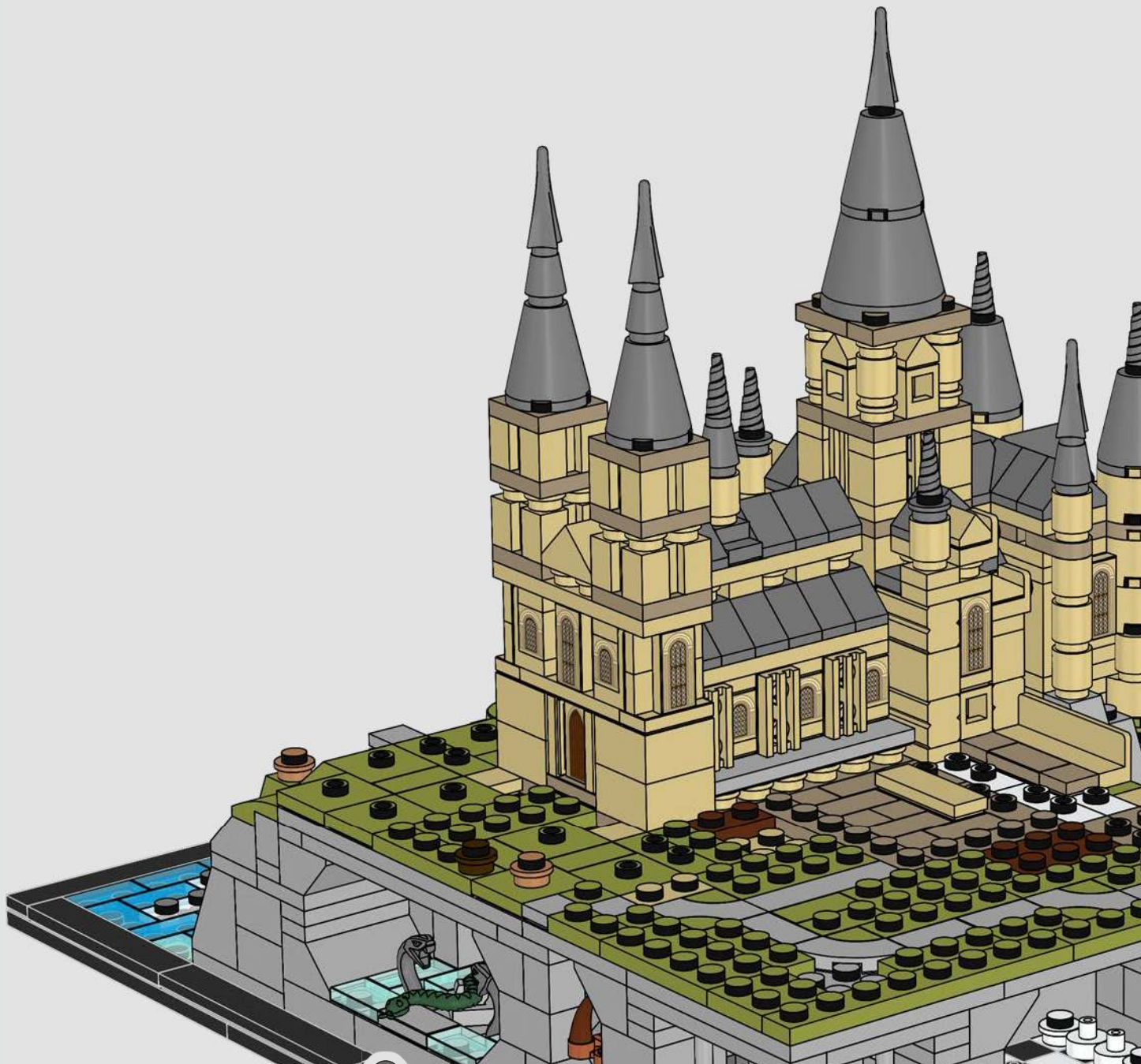

No matter what a Hogwarts™ student's favourite subjects are, they will likely spend a great deal of their time in the East Wing, where many of the classrooms are located.



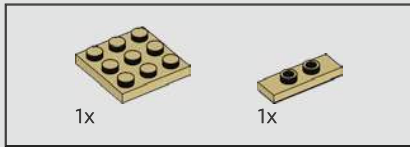
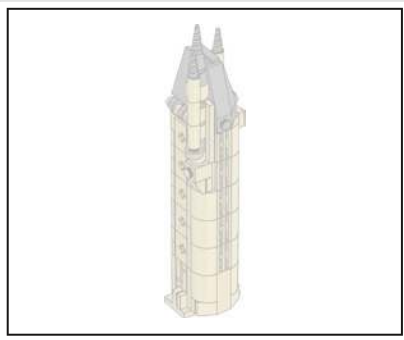

542

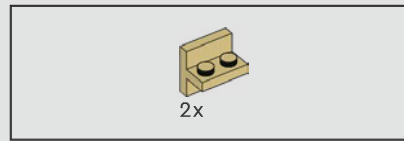
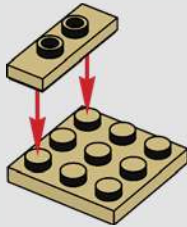

543

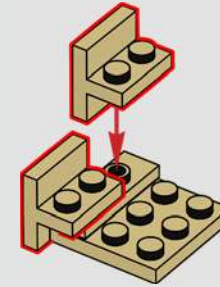

544

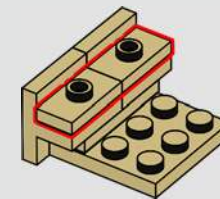



2x

545

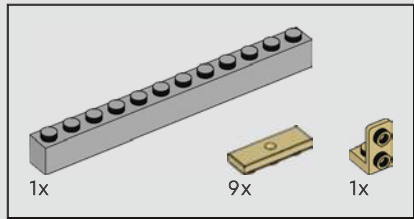
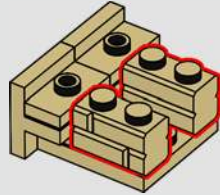

546

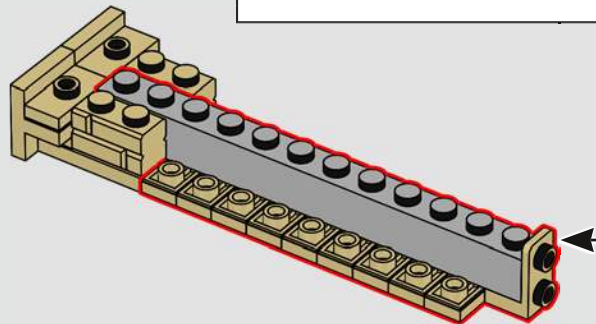
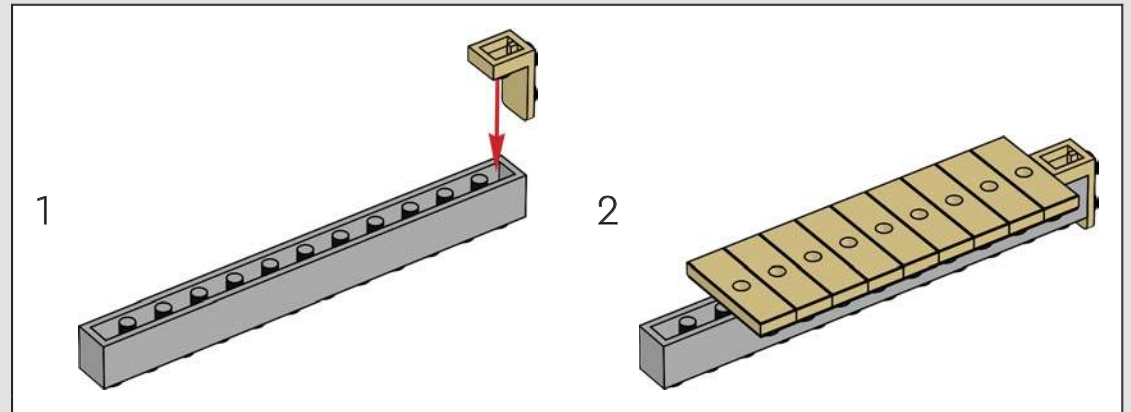

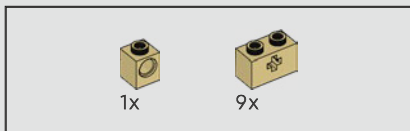

547

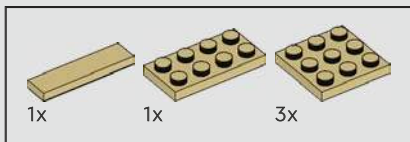
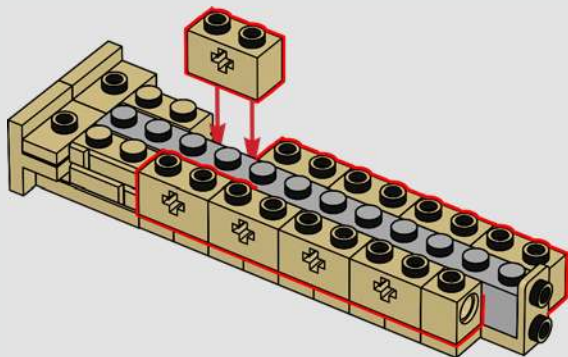

548

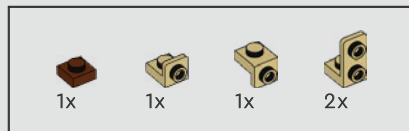
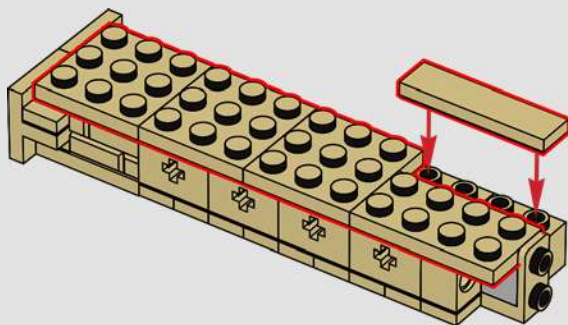

549

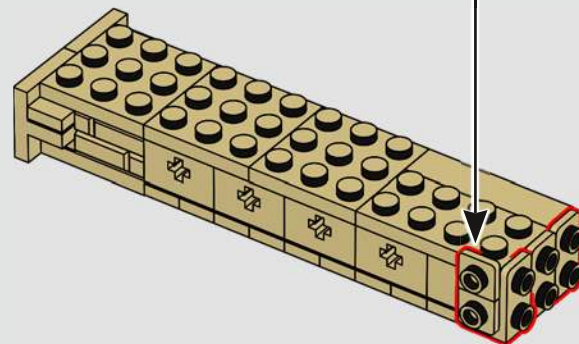
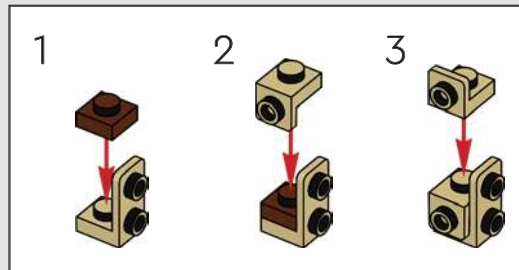

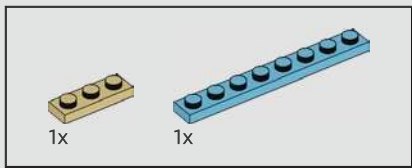

550

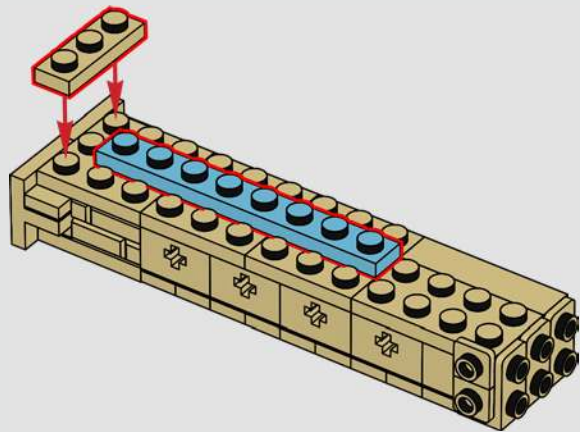

551

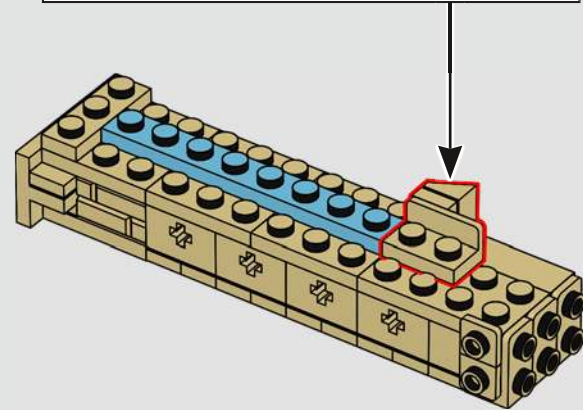
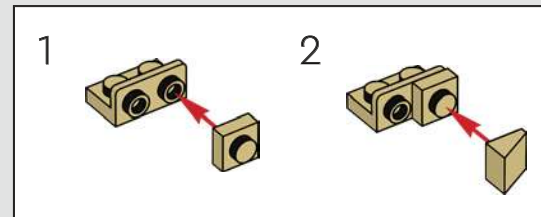

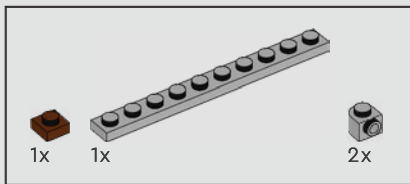

552

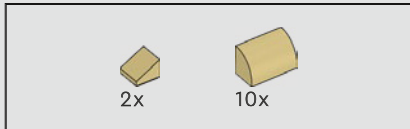
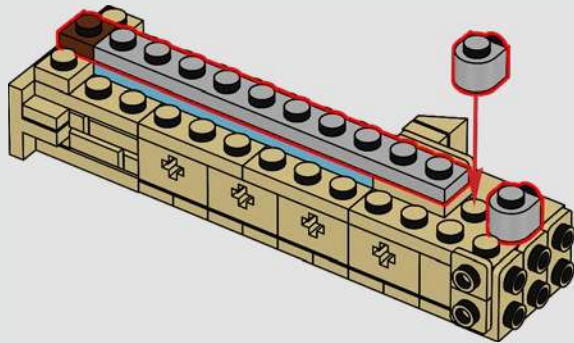

553

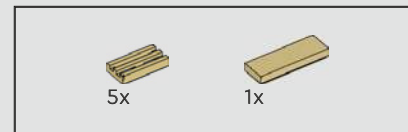
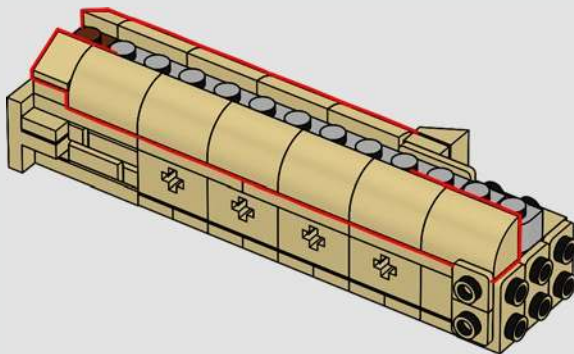

554

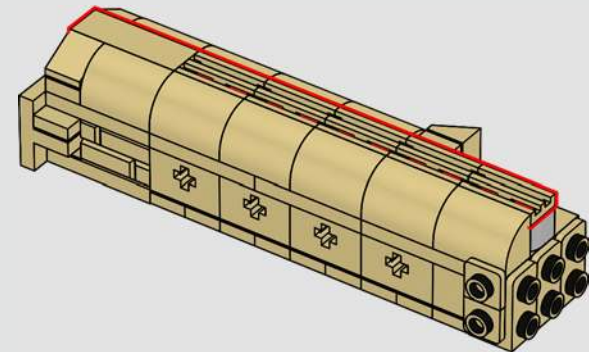



1x

555



2x

556

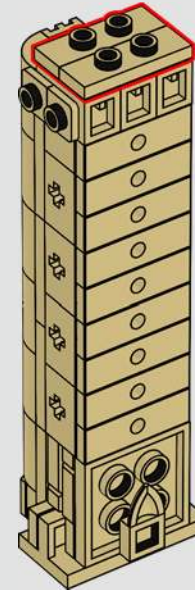

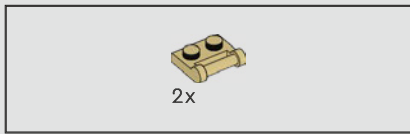

557

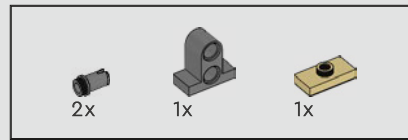
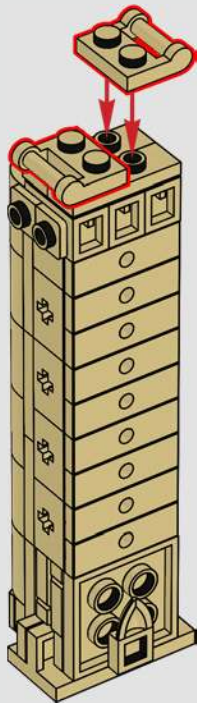

558

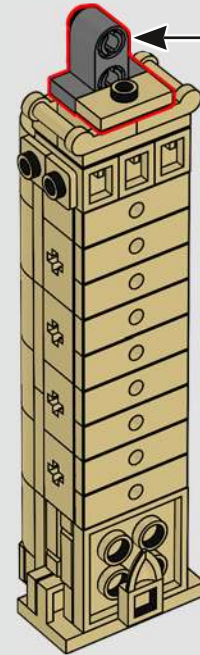
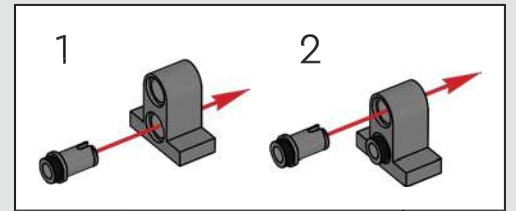



559

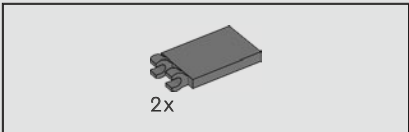

560

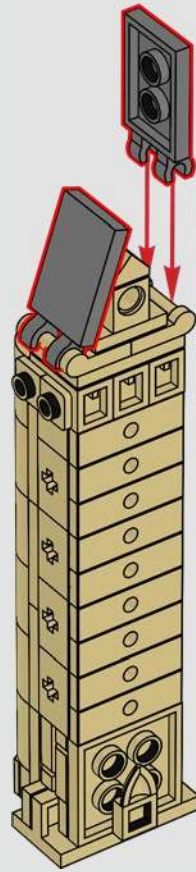



561

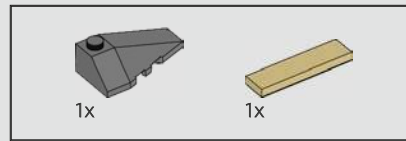
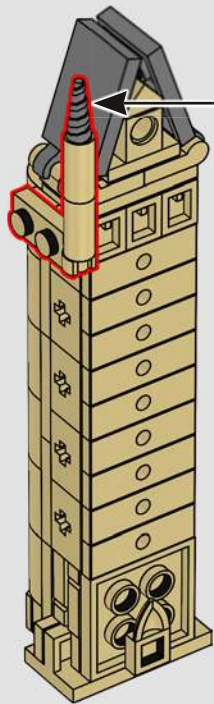
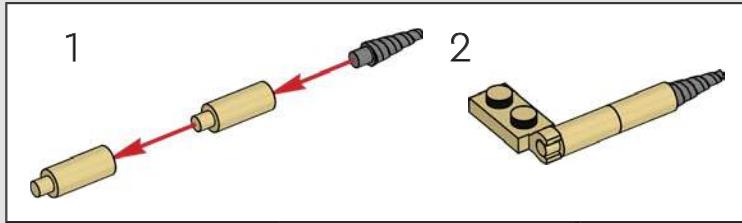

562

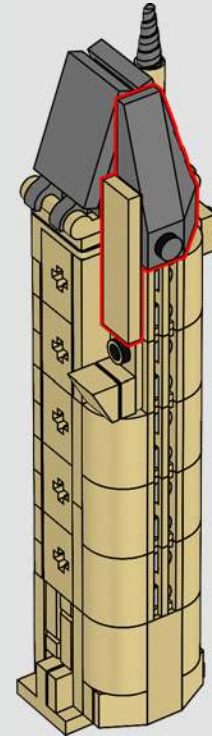

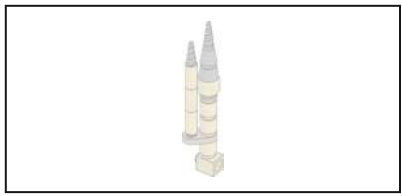

563

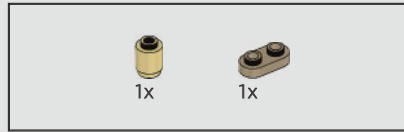

564



565





566

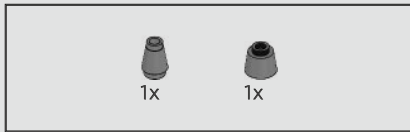

567

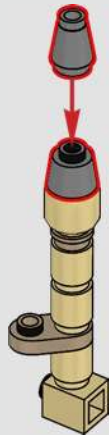

568

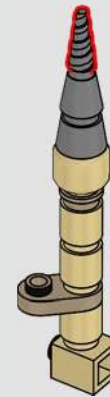

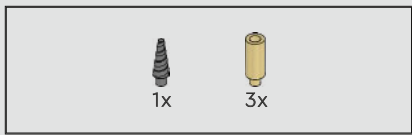

569

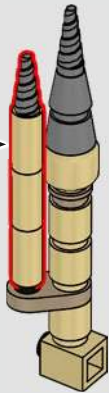
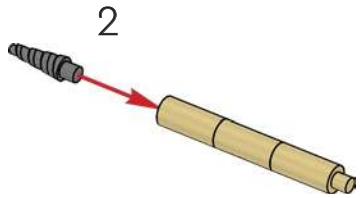
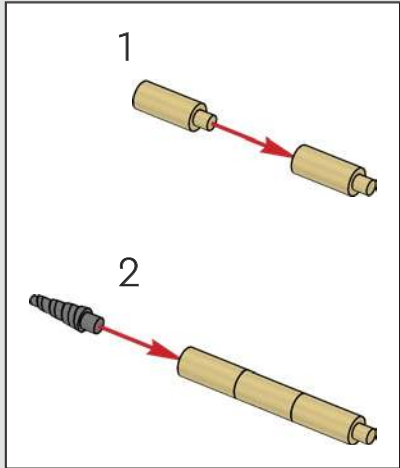

570

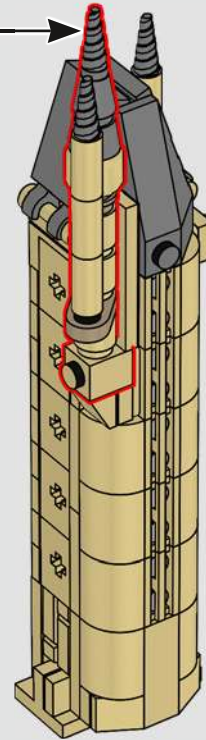

571



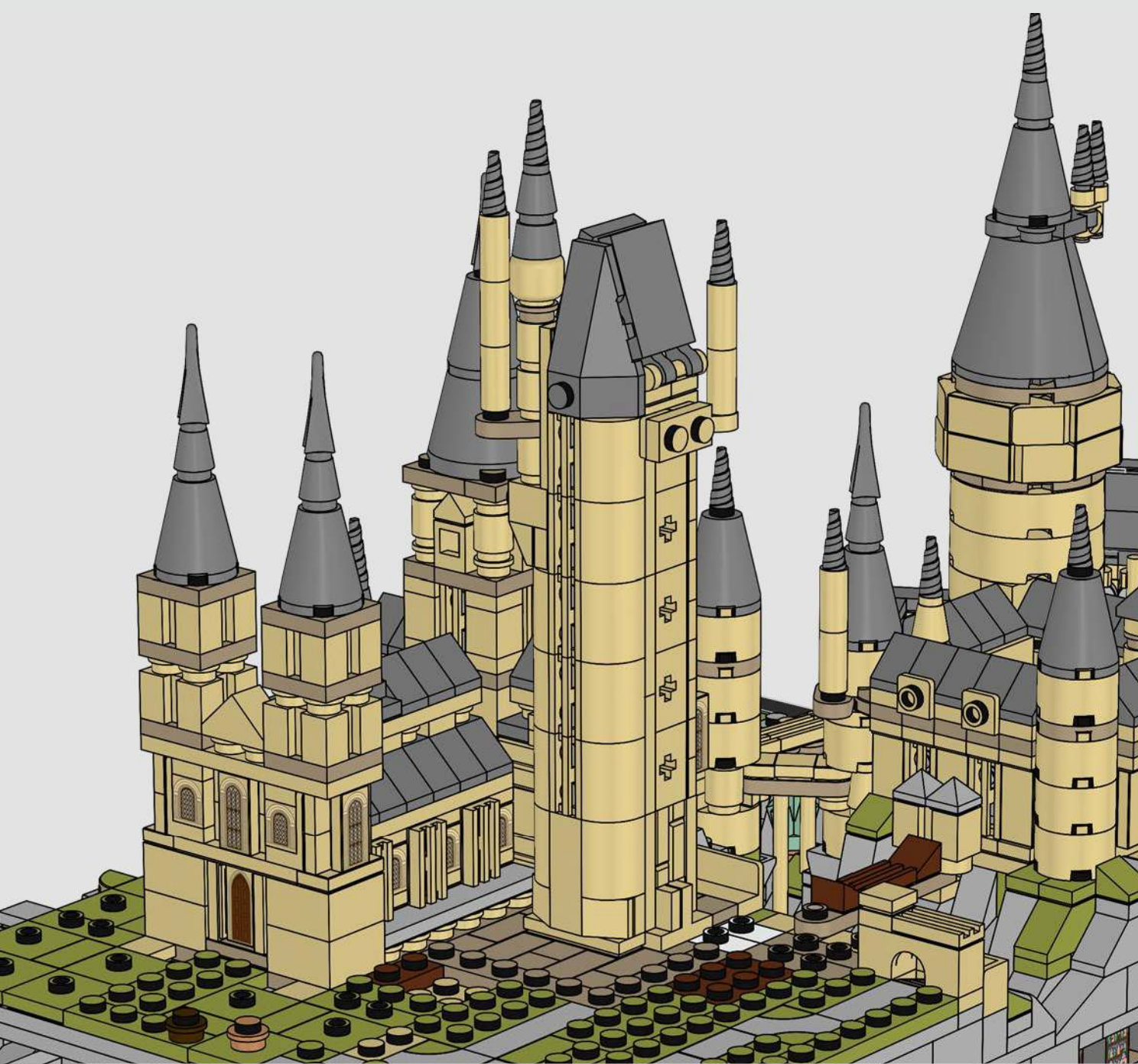

You might think the main tower would be the tallest point of the Hogwarts™ castle – but it is actually the Astronomy Tower.



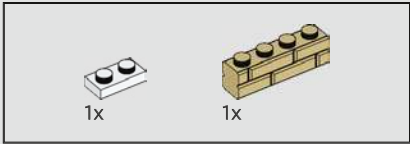

572

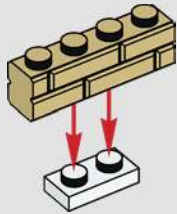

573

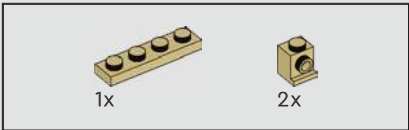
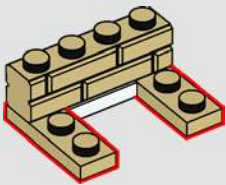

574

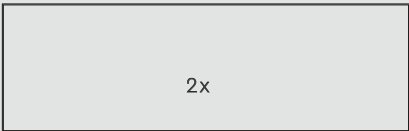
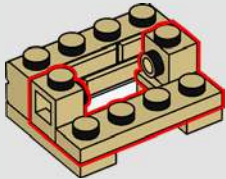

575

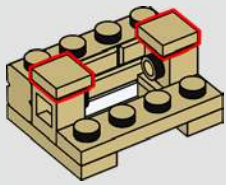

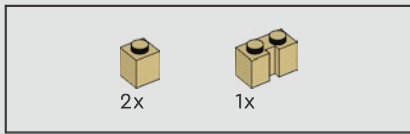

576

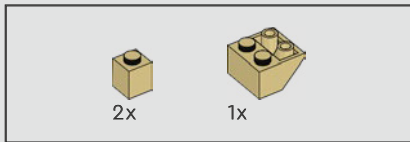
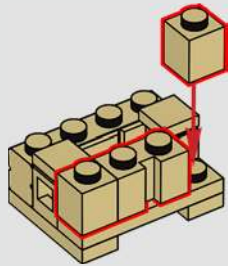

577

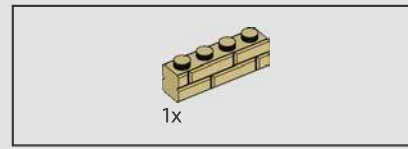
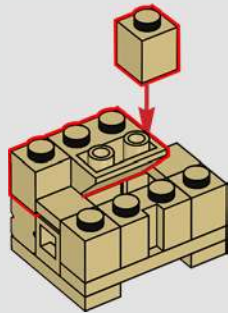

578

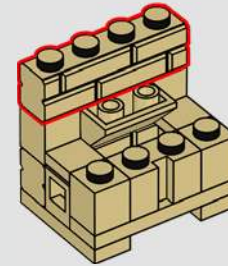

579

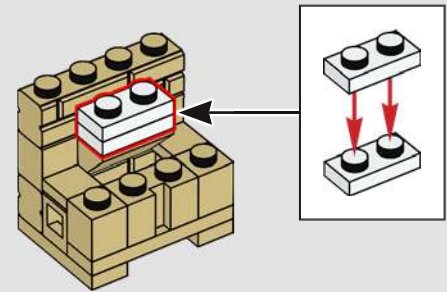

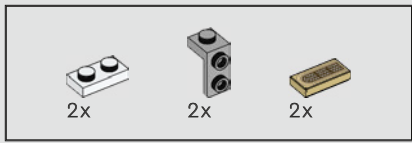

580

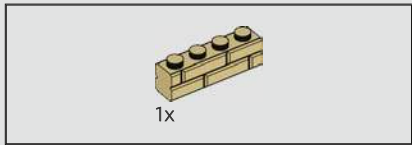
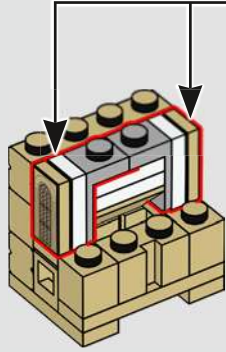
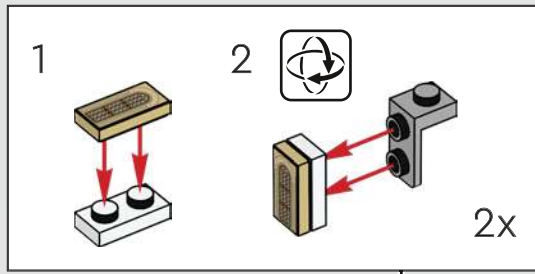

581

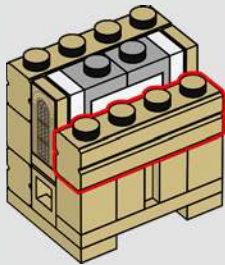

582

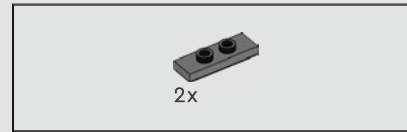
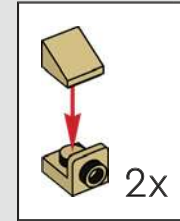
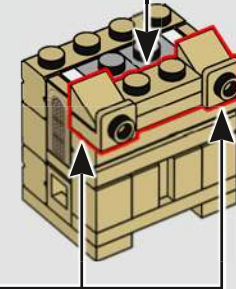
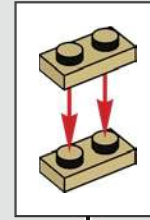

583

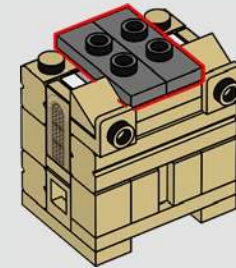

584

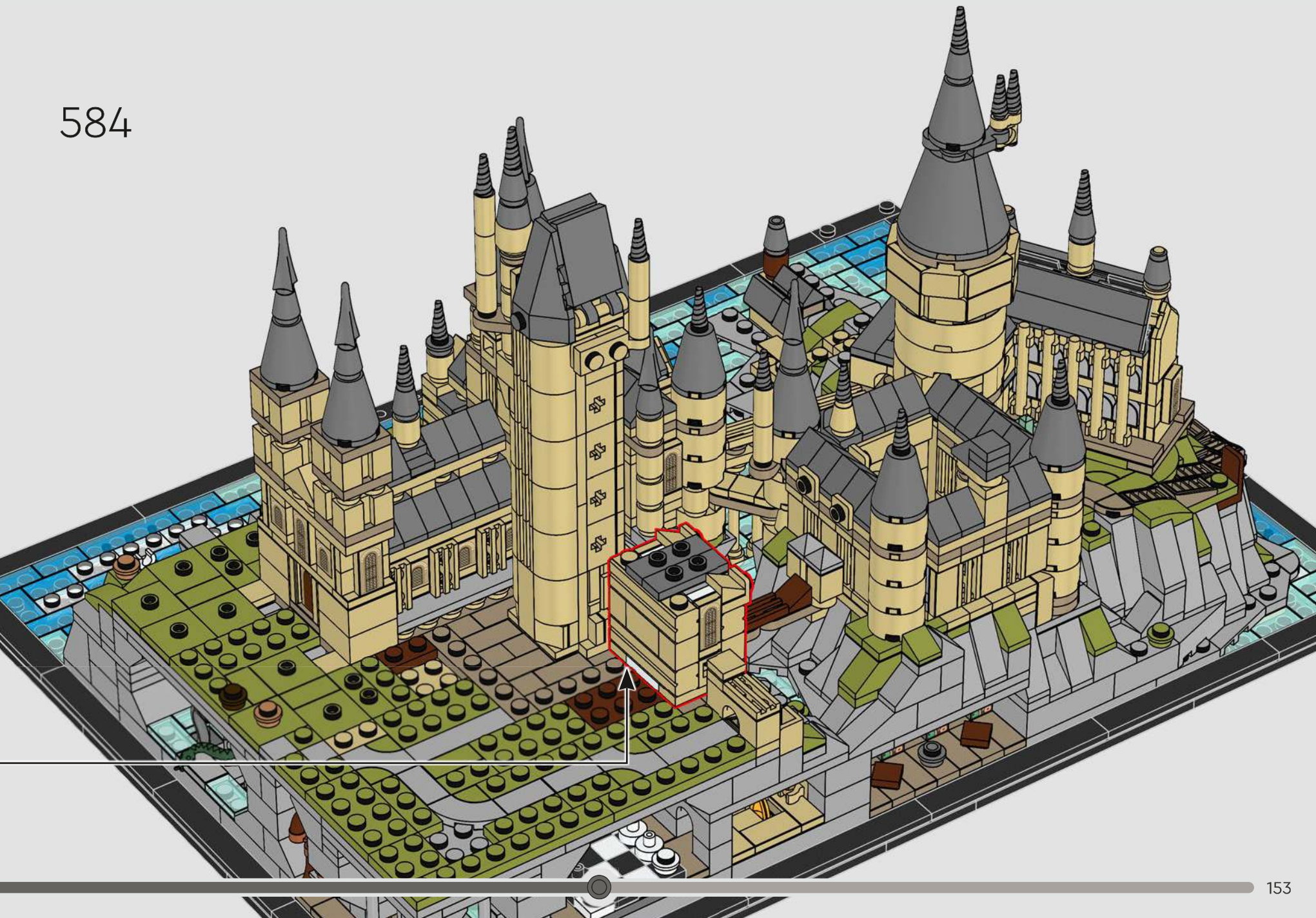

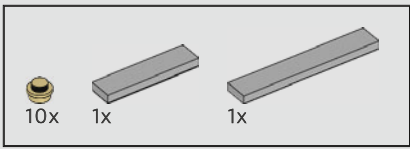

585

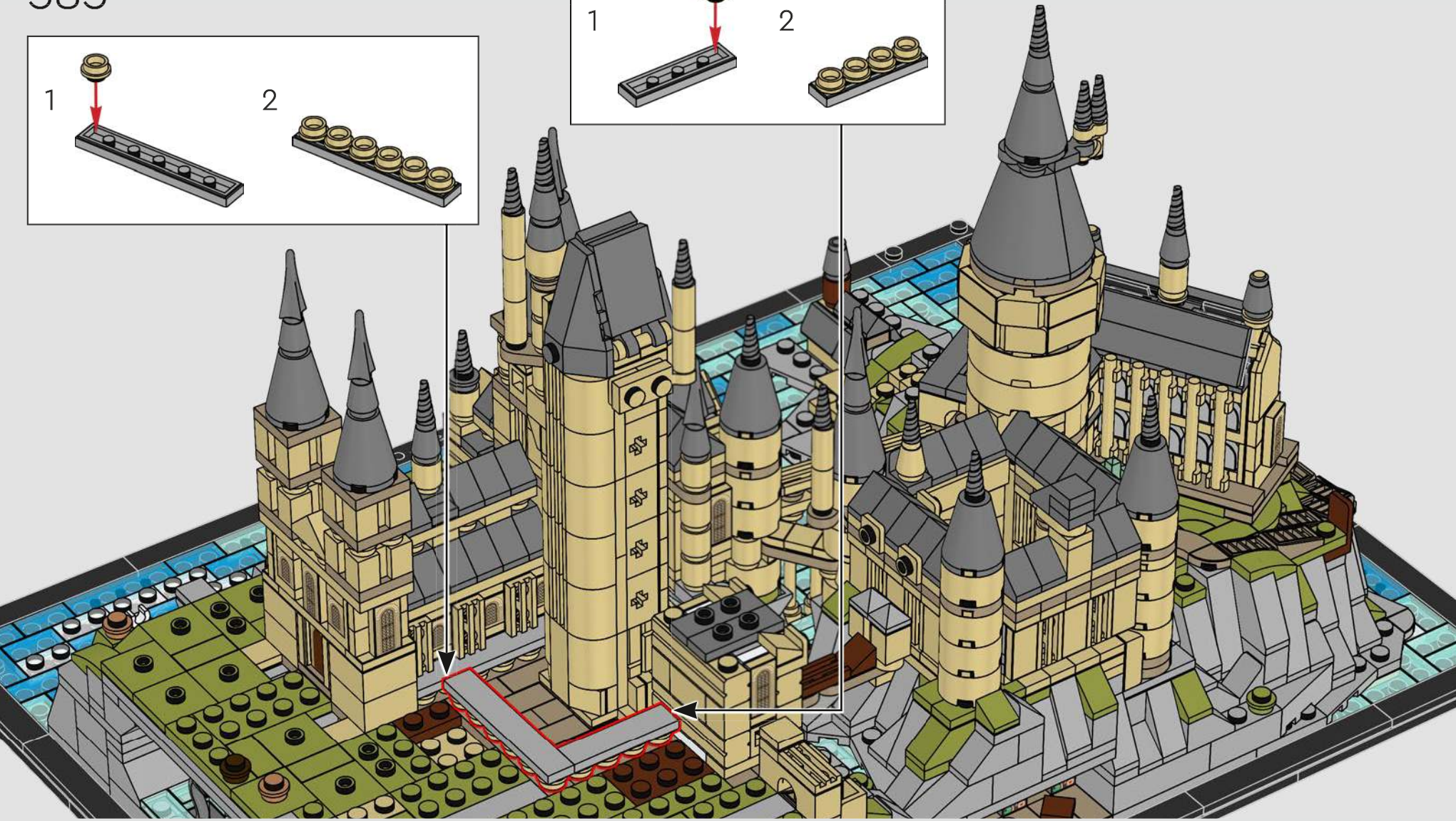
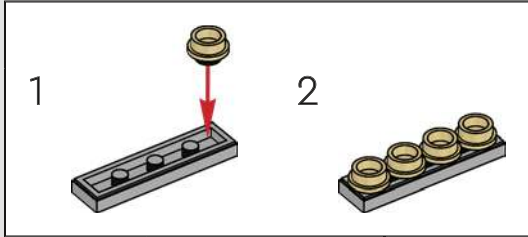
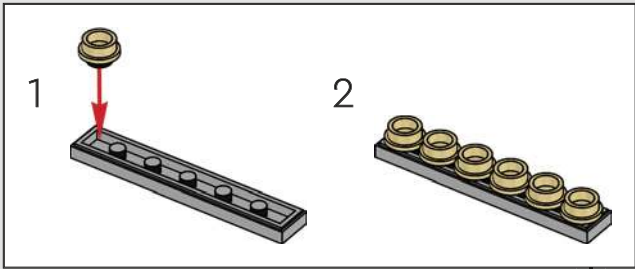

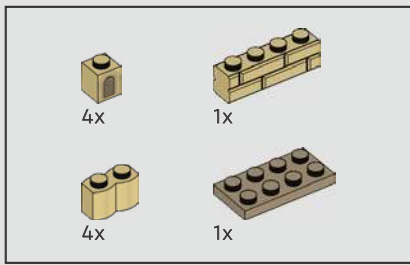

586

1

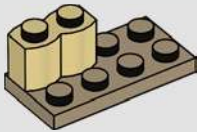

2

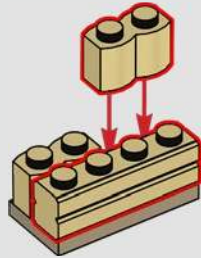

3

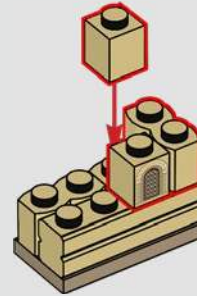

4

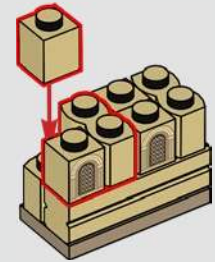





587



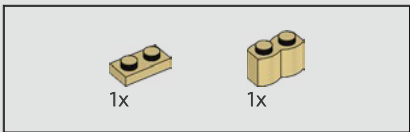

588

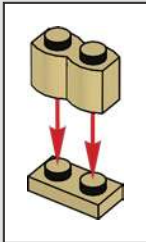

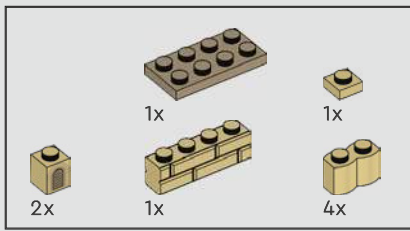

589

1

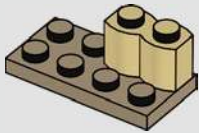

2

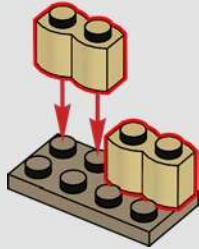

3

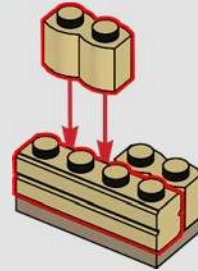

4

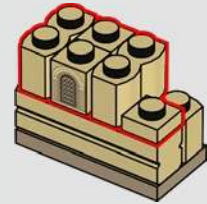

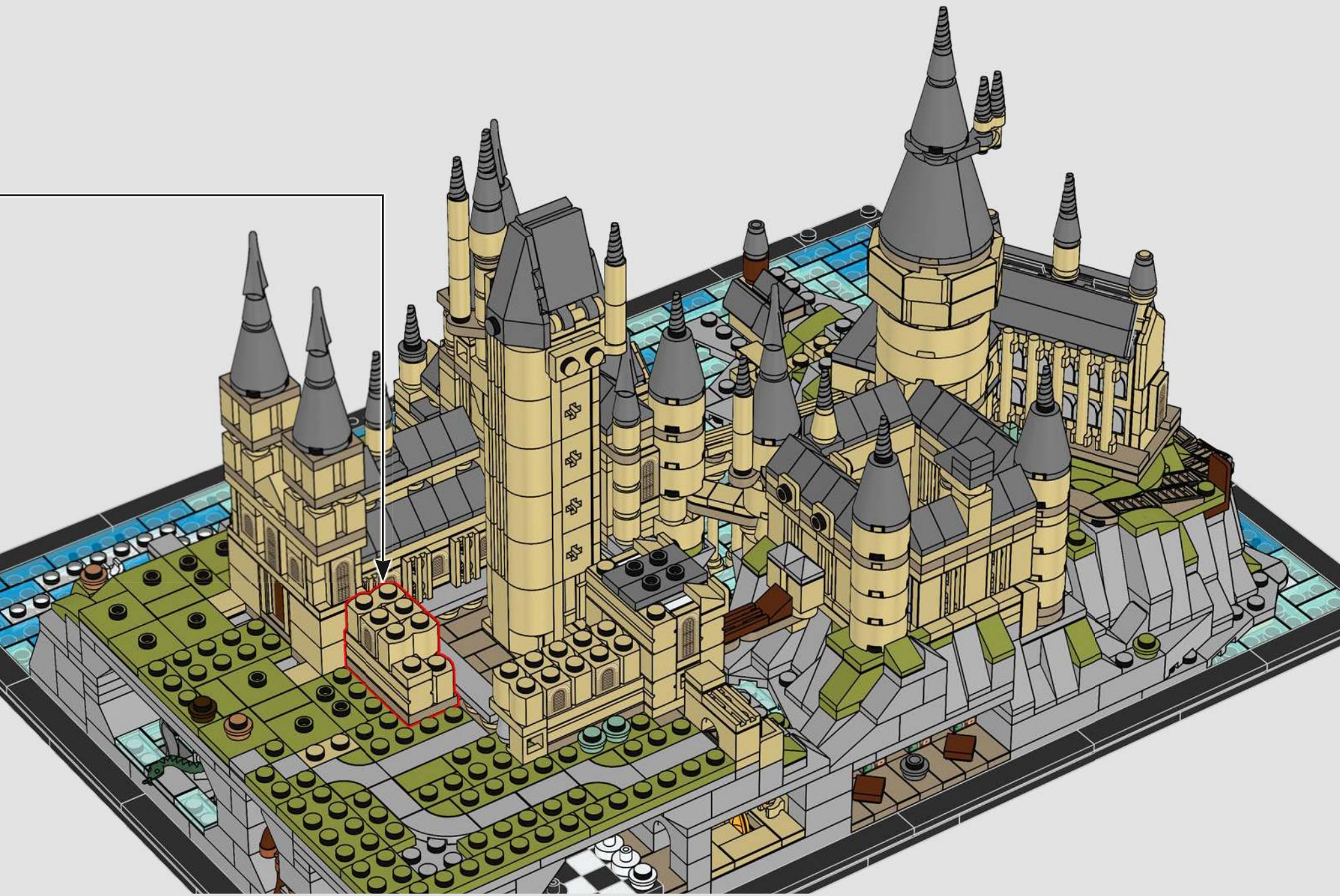

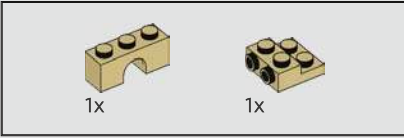
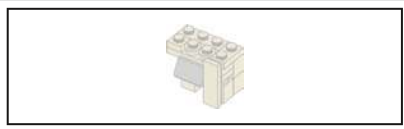

590

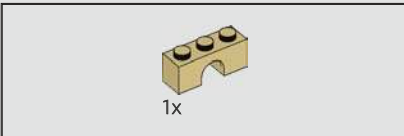
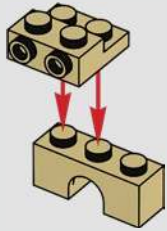

591

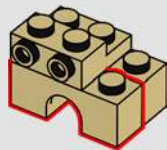

592

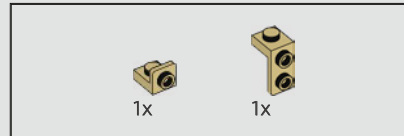
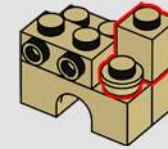

593

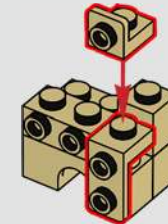

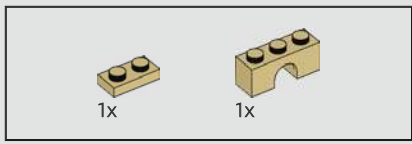

594

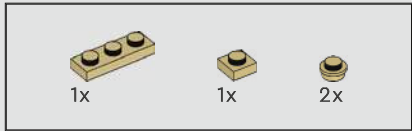
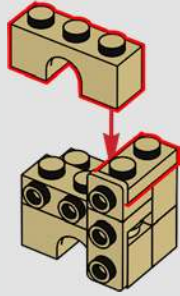

595

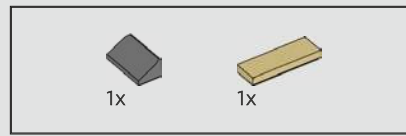
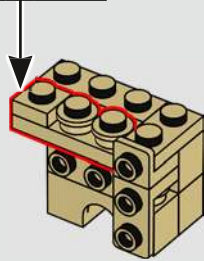
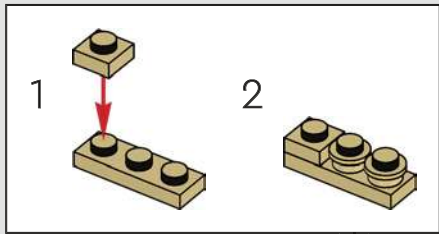

596

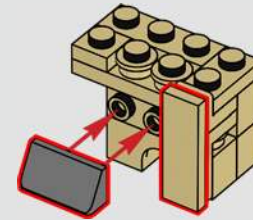

597



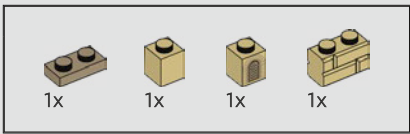

598

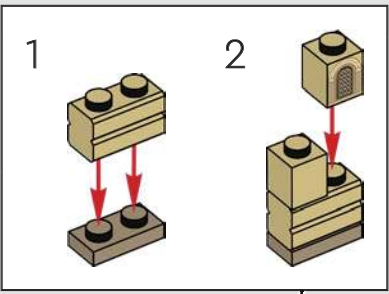

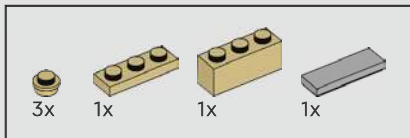

599

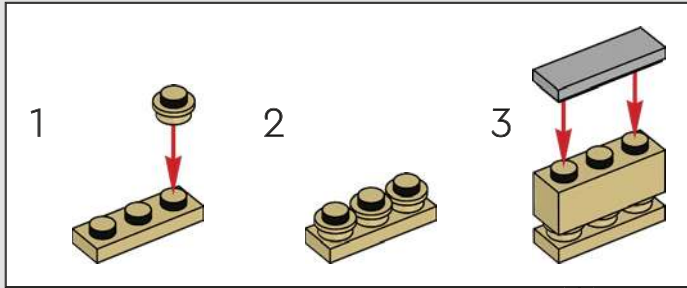

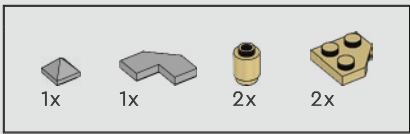

600

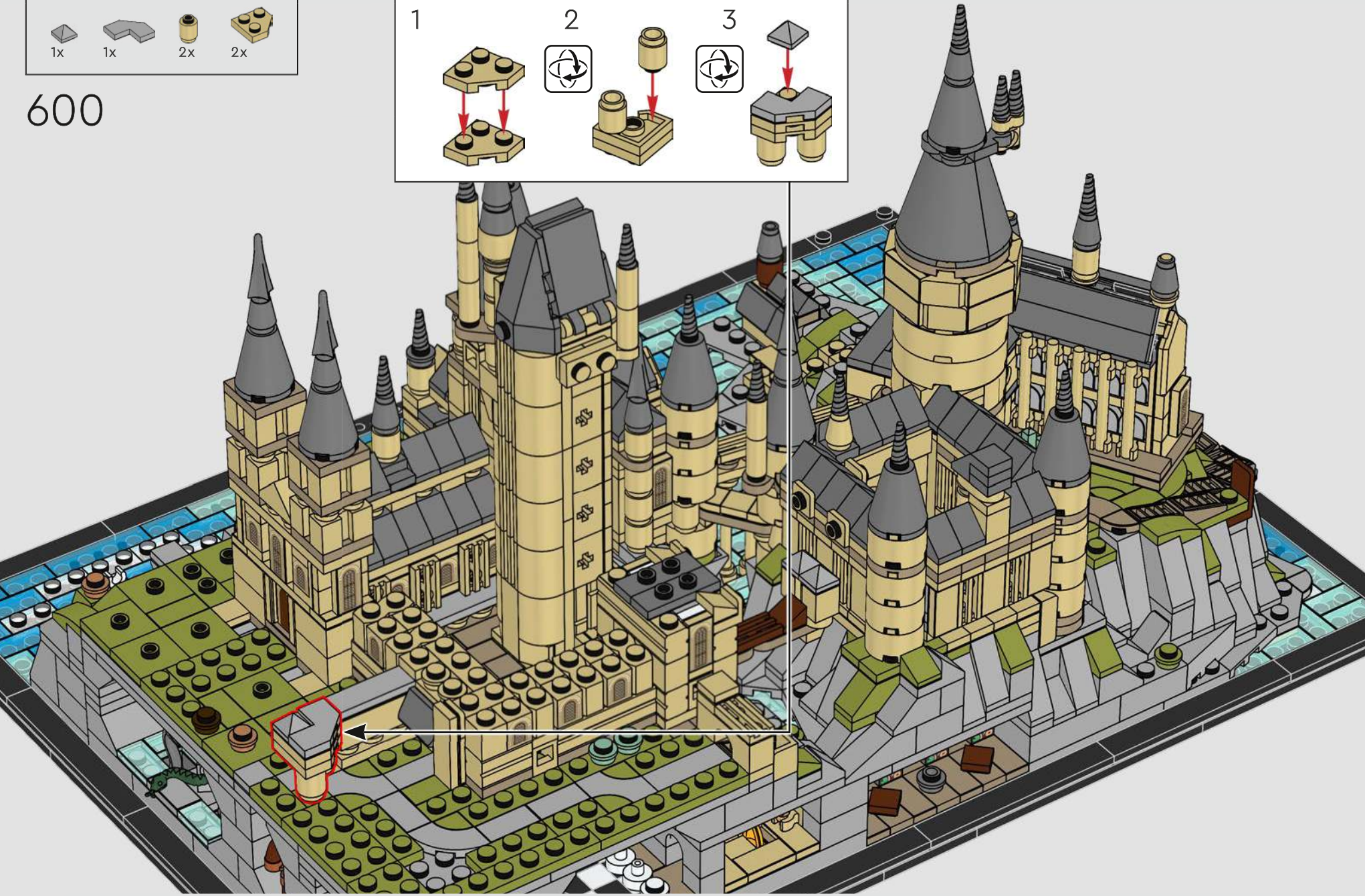
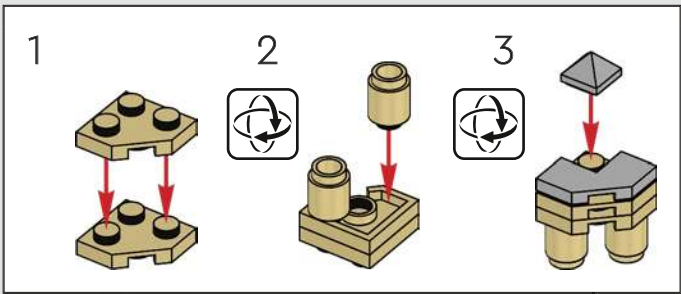

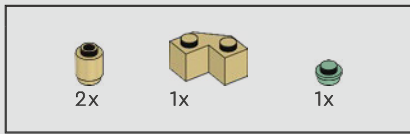

601

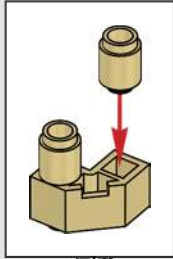



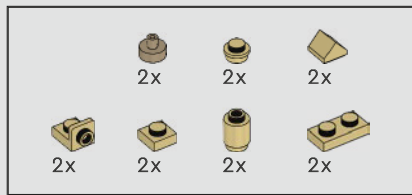

602

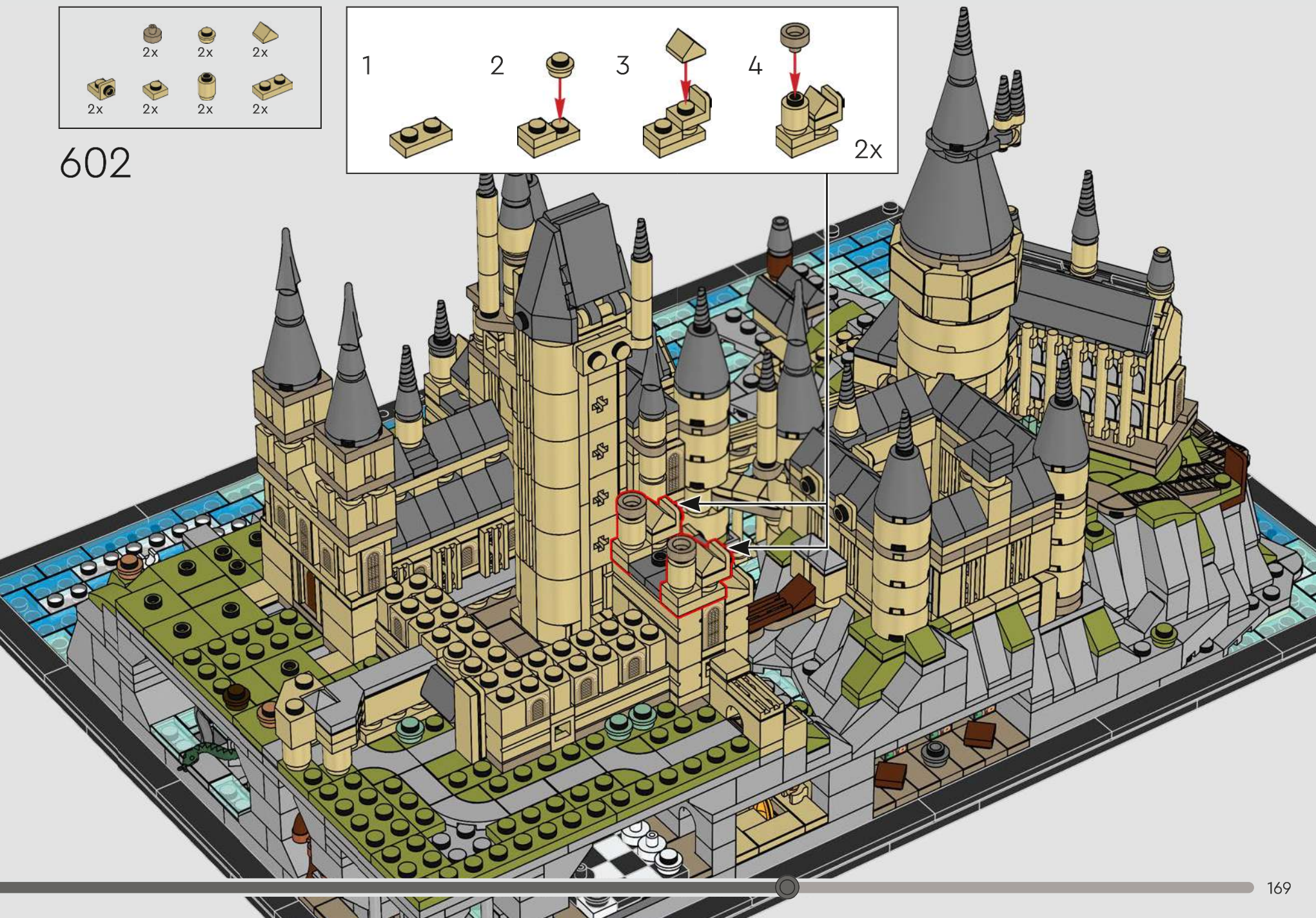
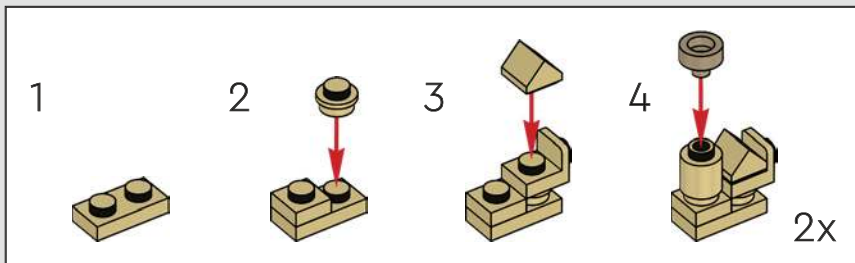

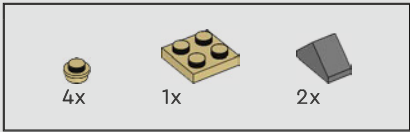

603

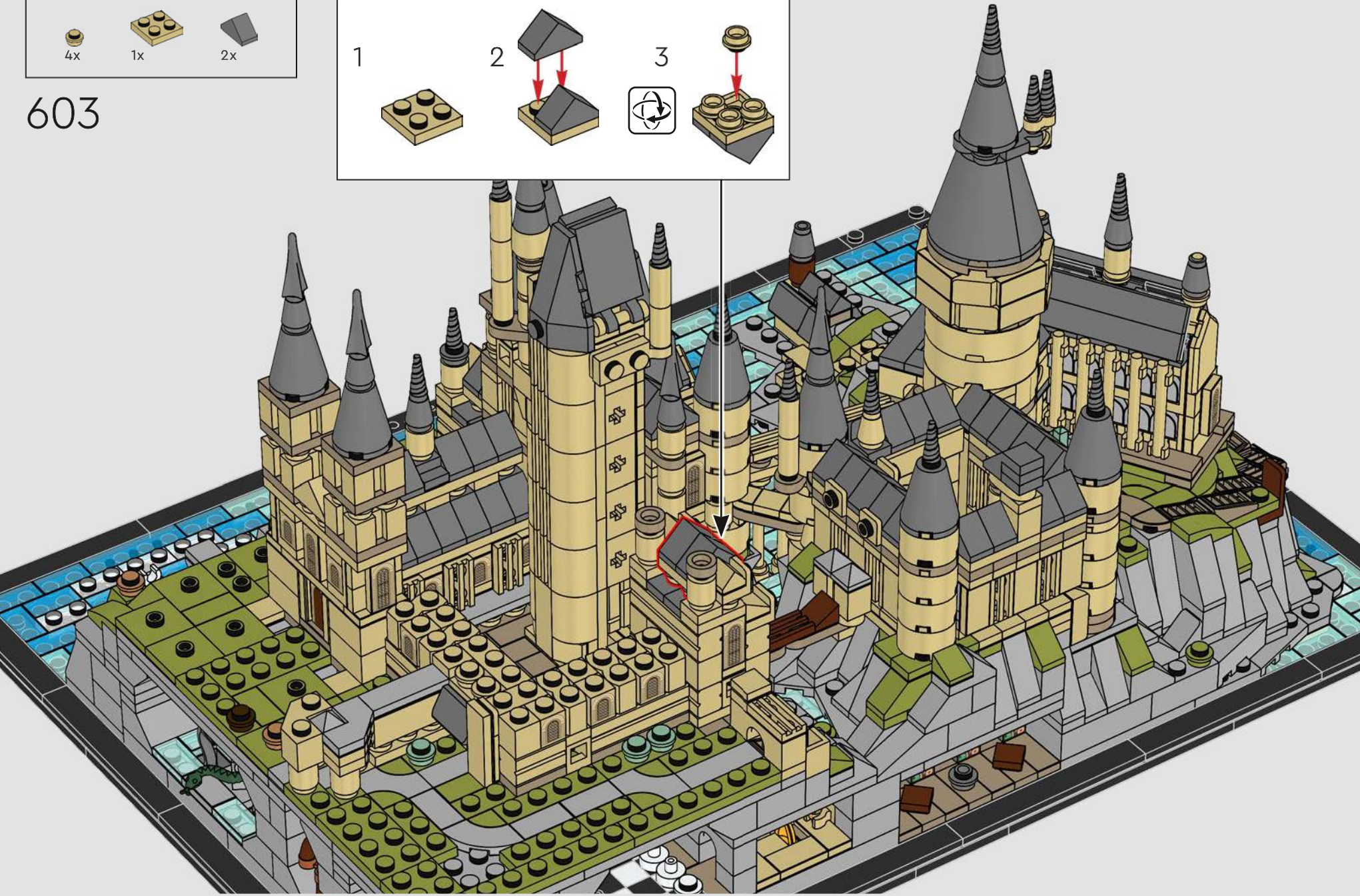
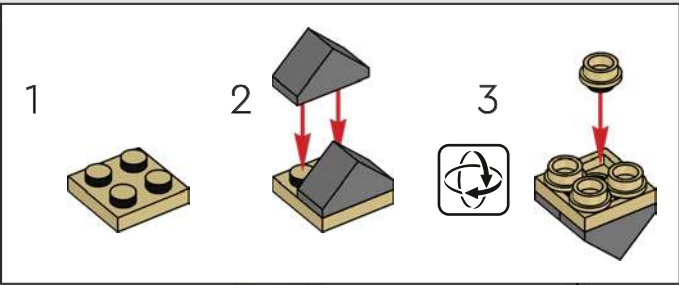

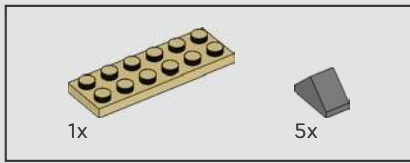

604

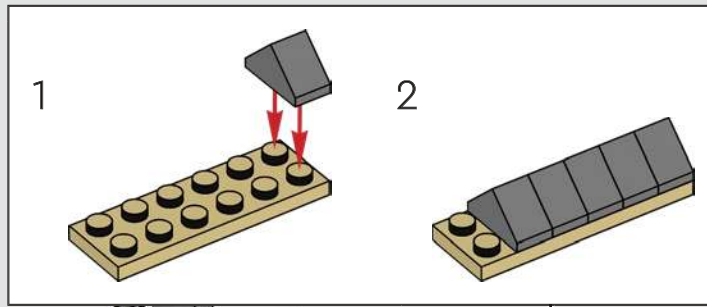

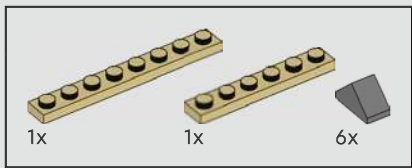

605

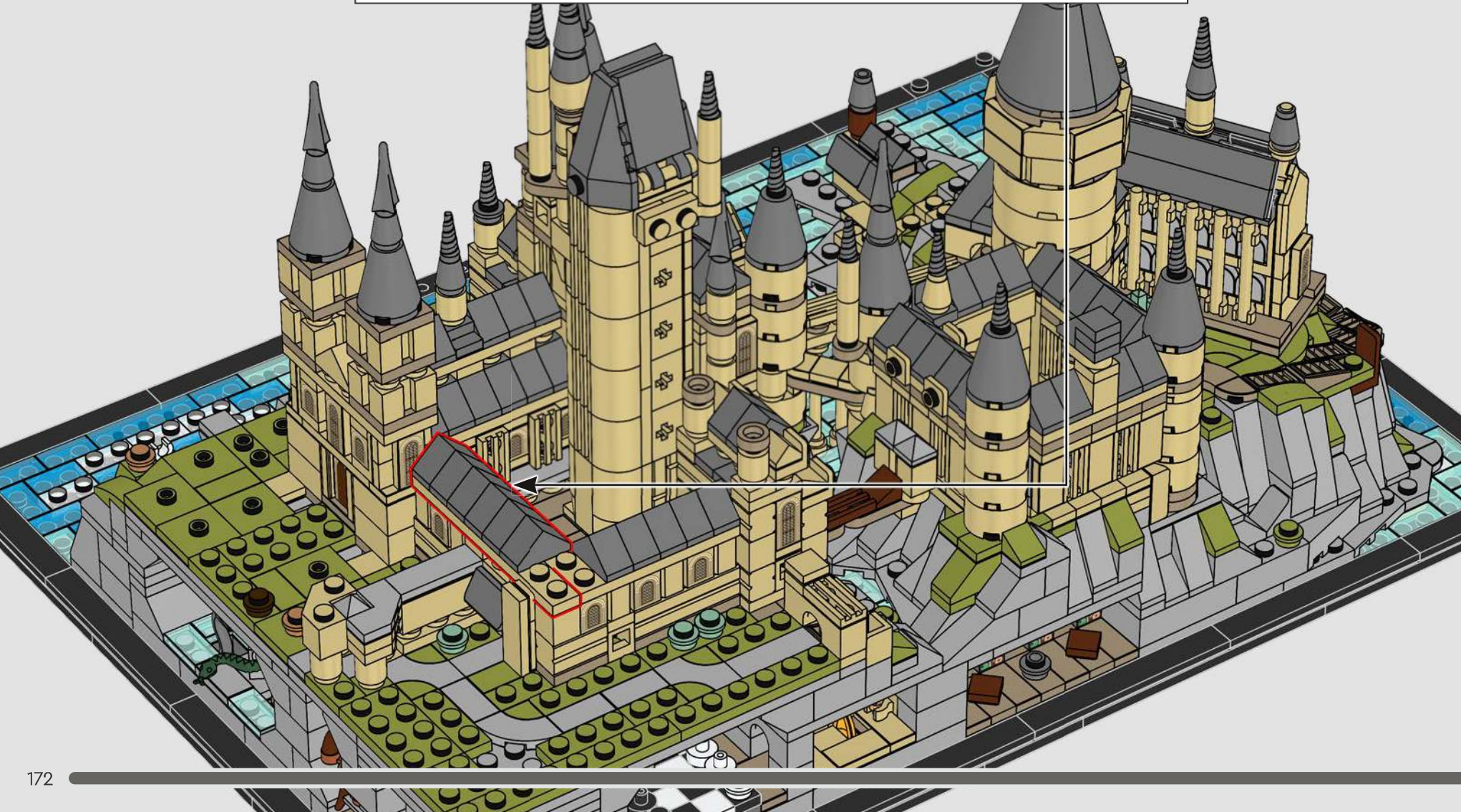
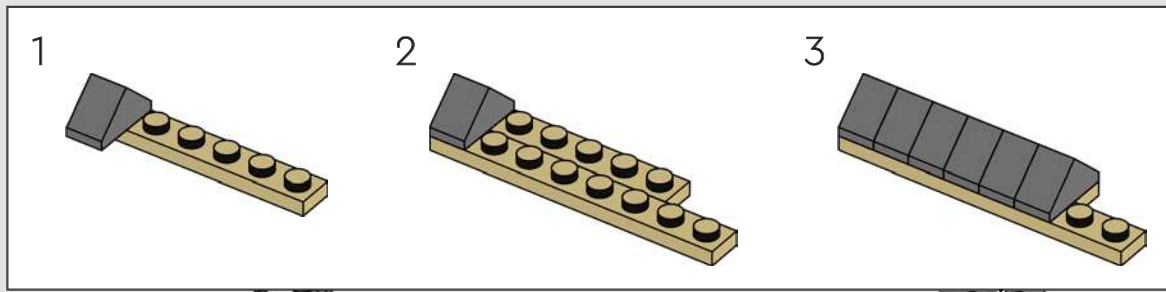

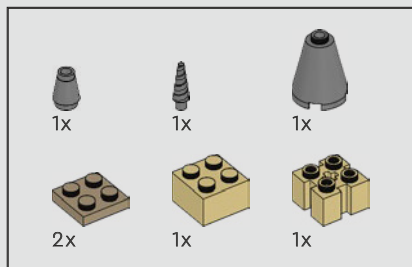

606

1

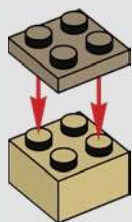

2

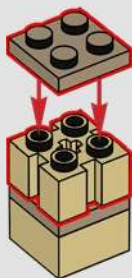

3

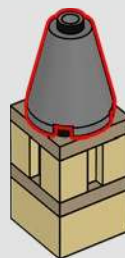

4

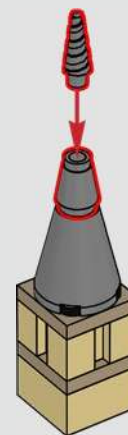



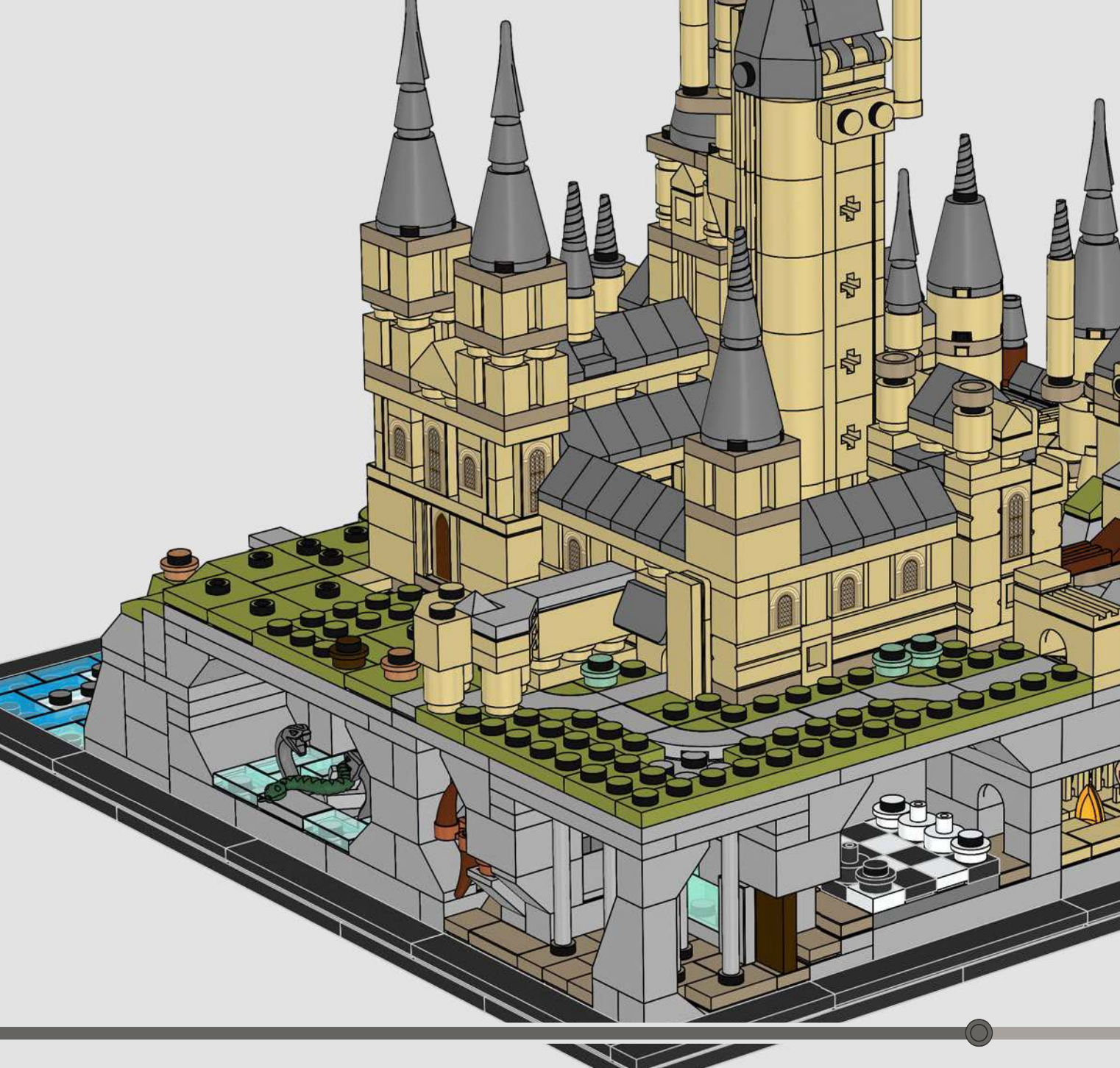

Hogwarts™ is a huge castle, where it can be tricky to find your way. But did you know that the castle has 142 staircases? With the staircases constantly changing, it doesn't make it easier finding your way around.

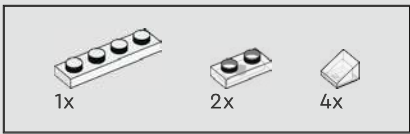

607

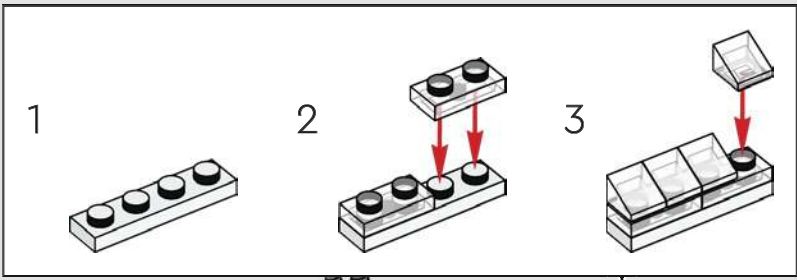

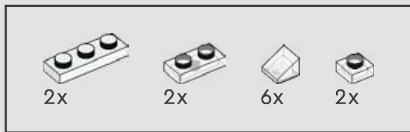

608

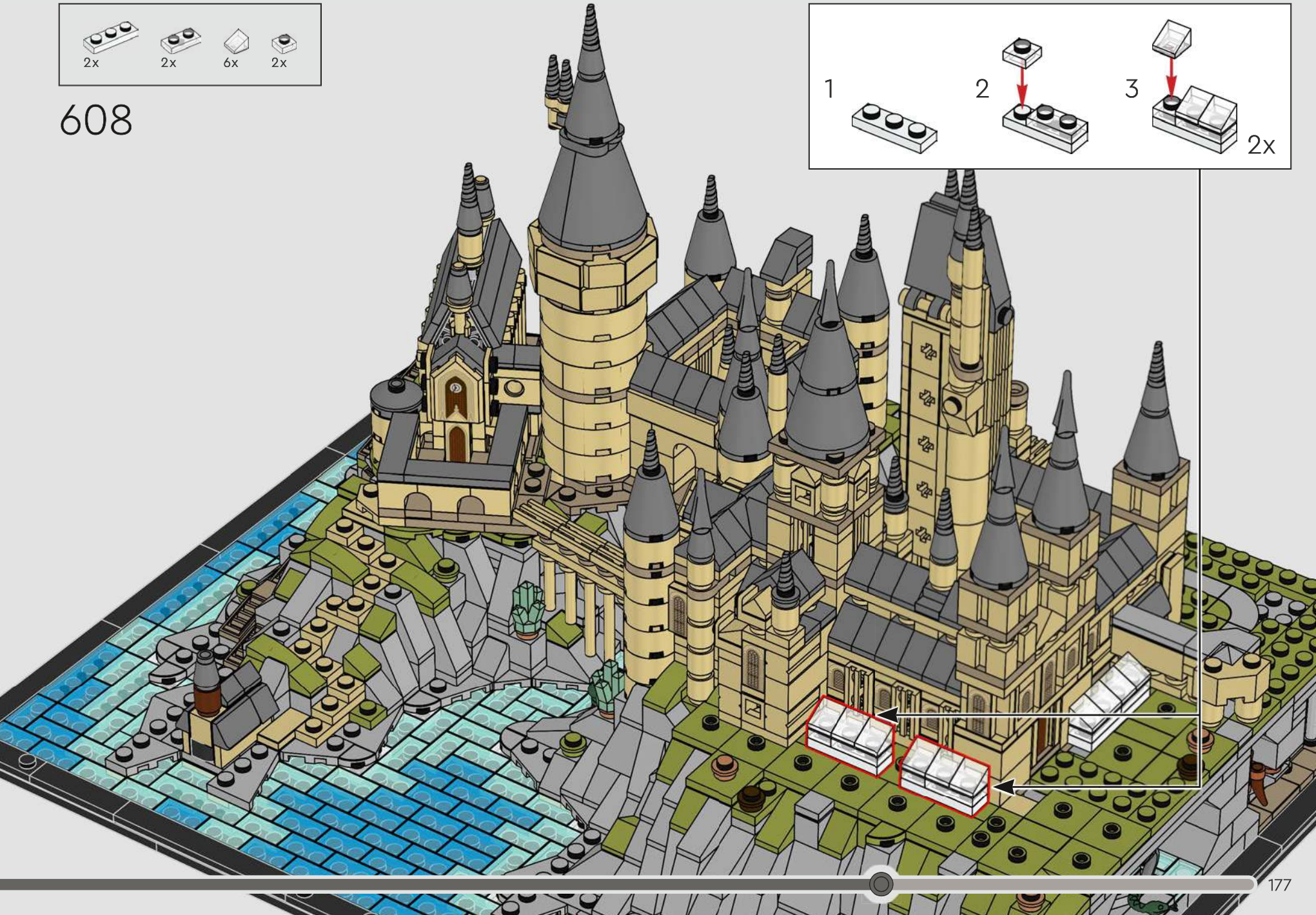
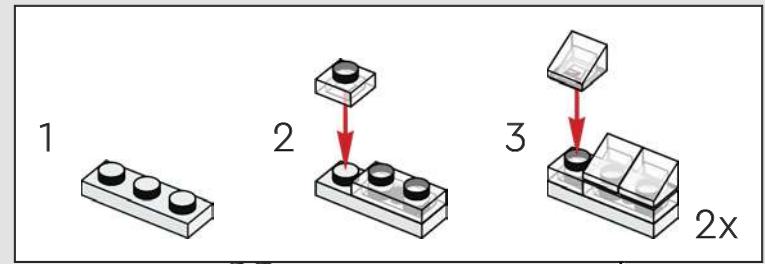

1x  1x 

609

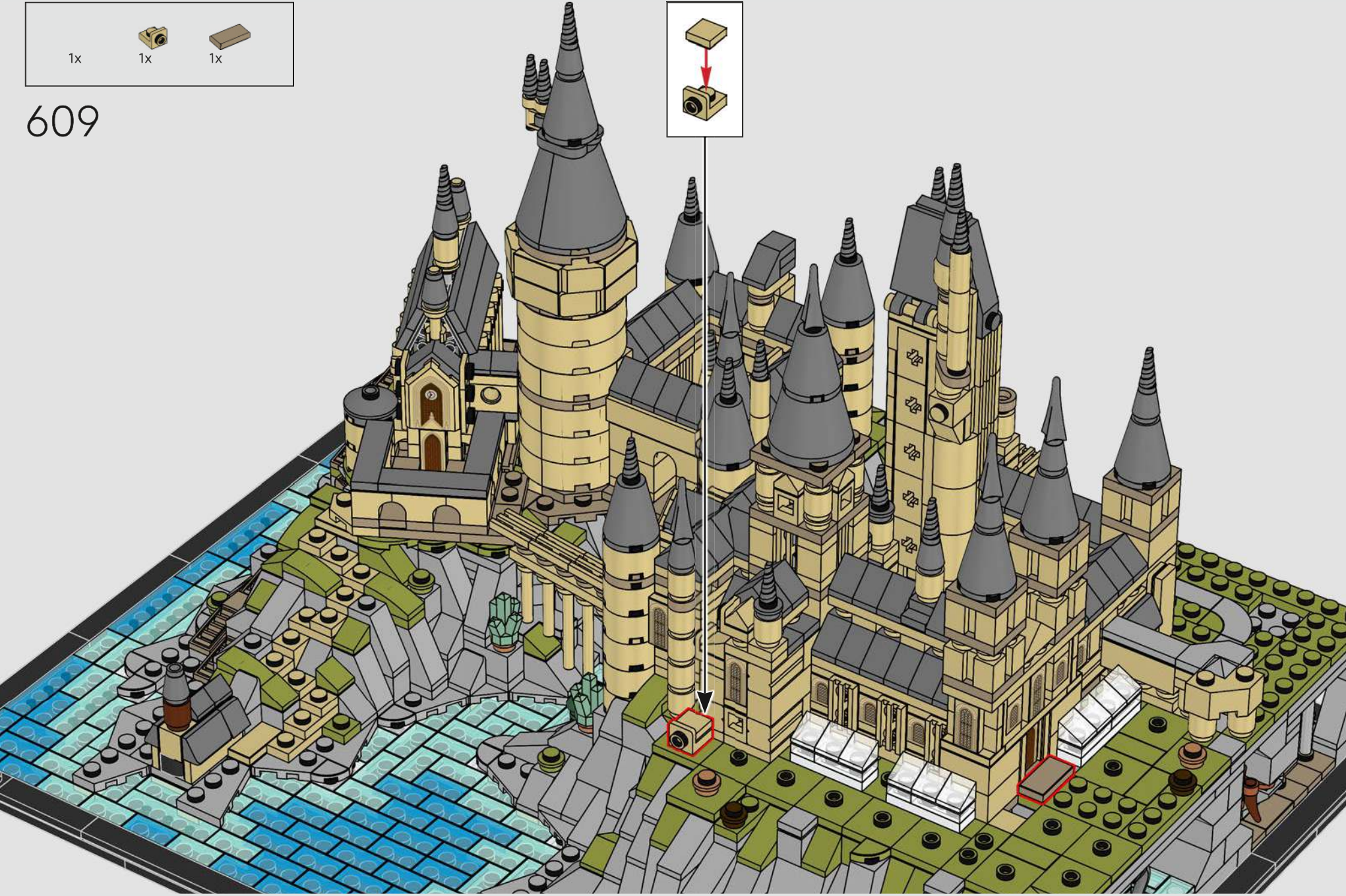
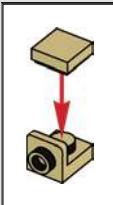



610

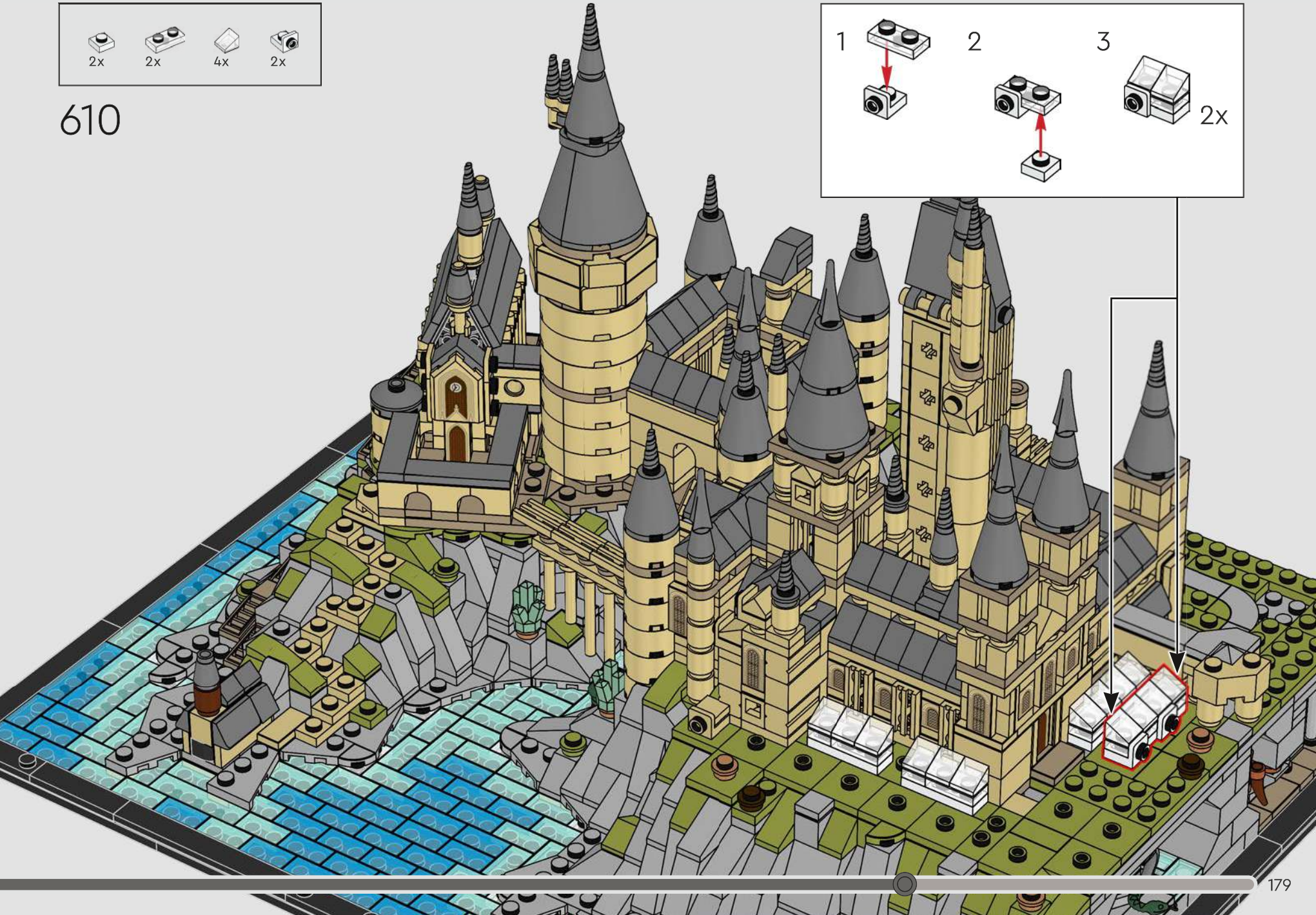
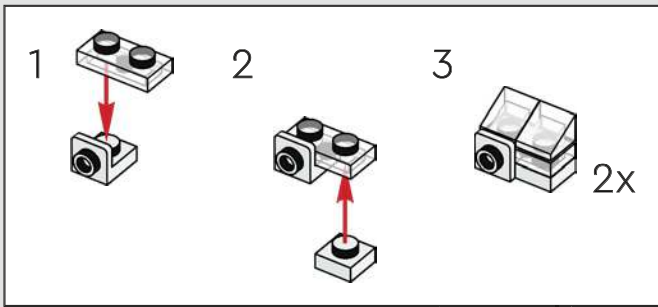

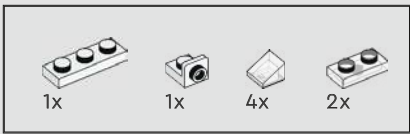



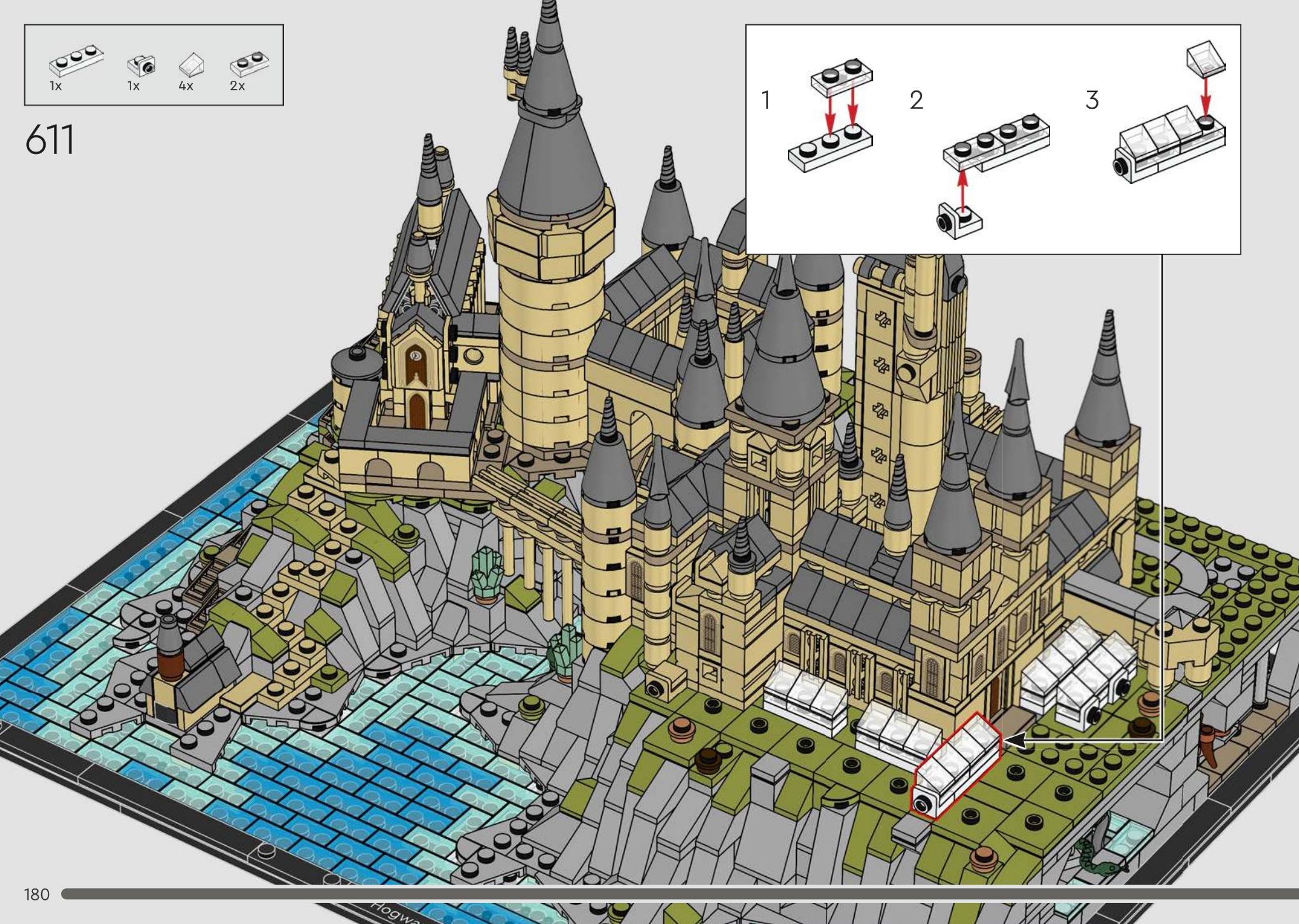
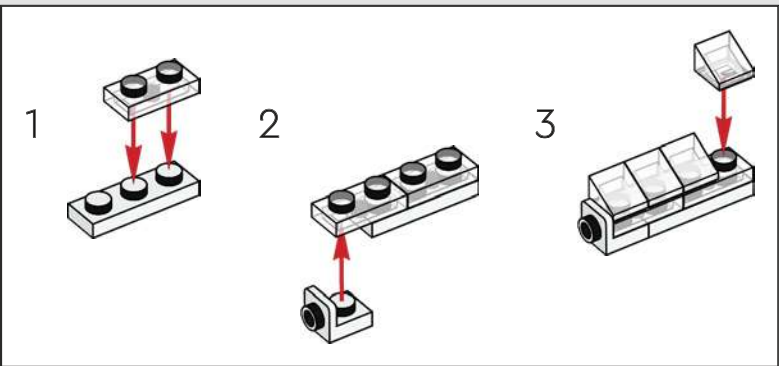

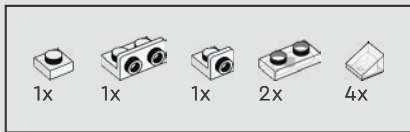
611



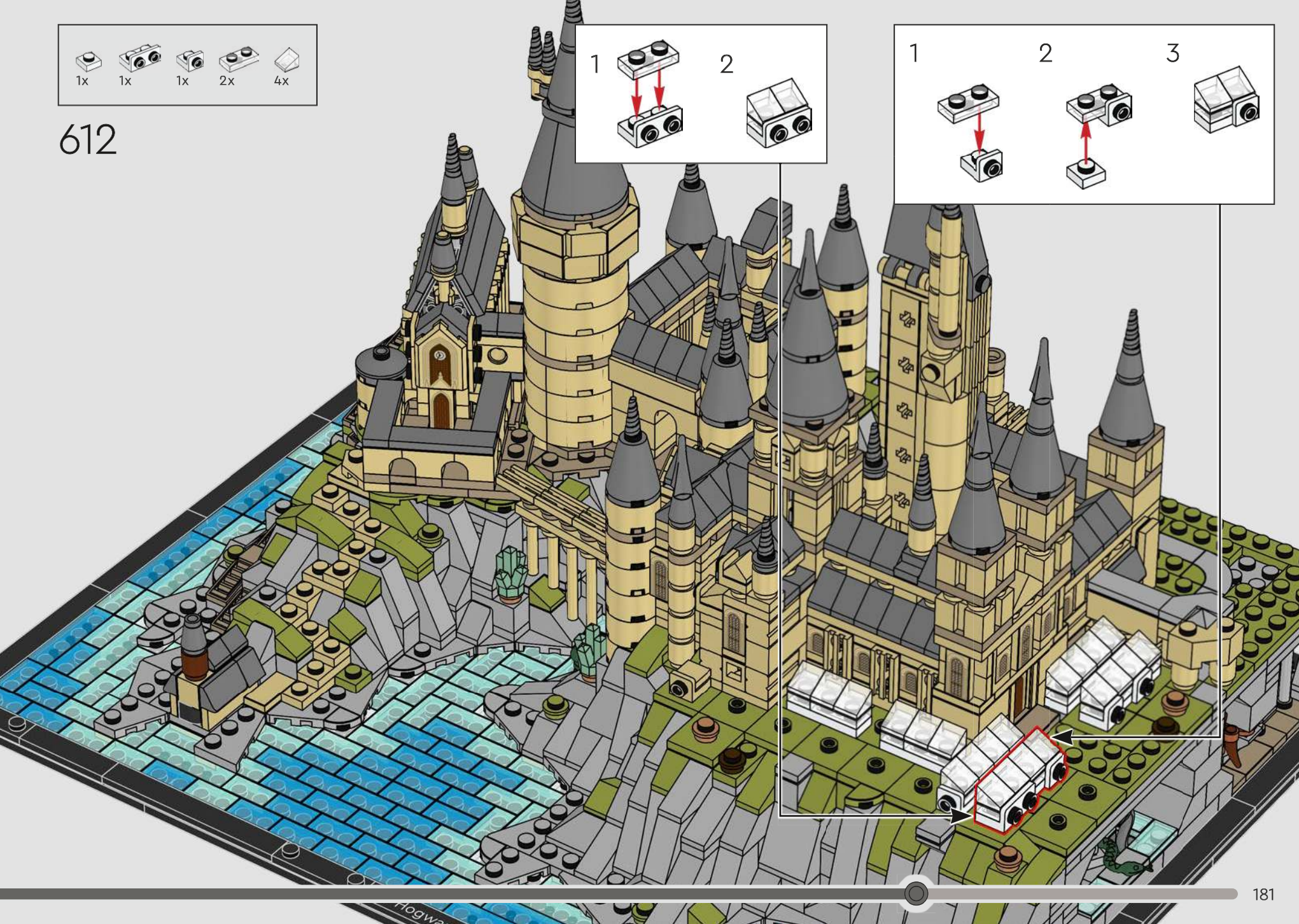
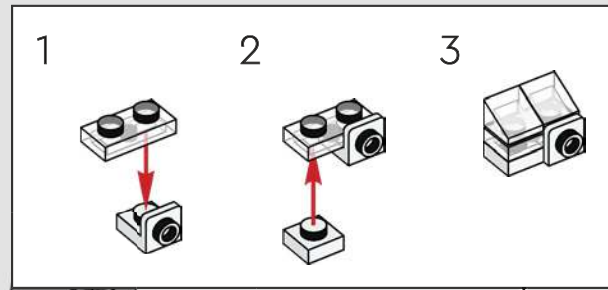
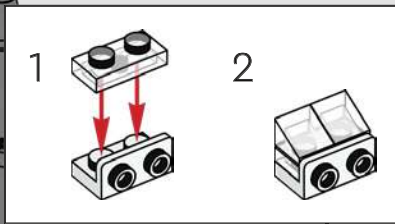



612



			
2x	2x	2x	4x

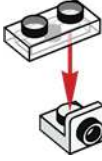
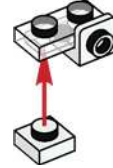

613

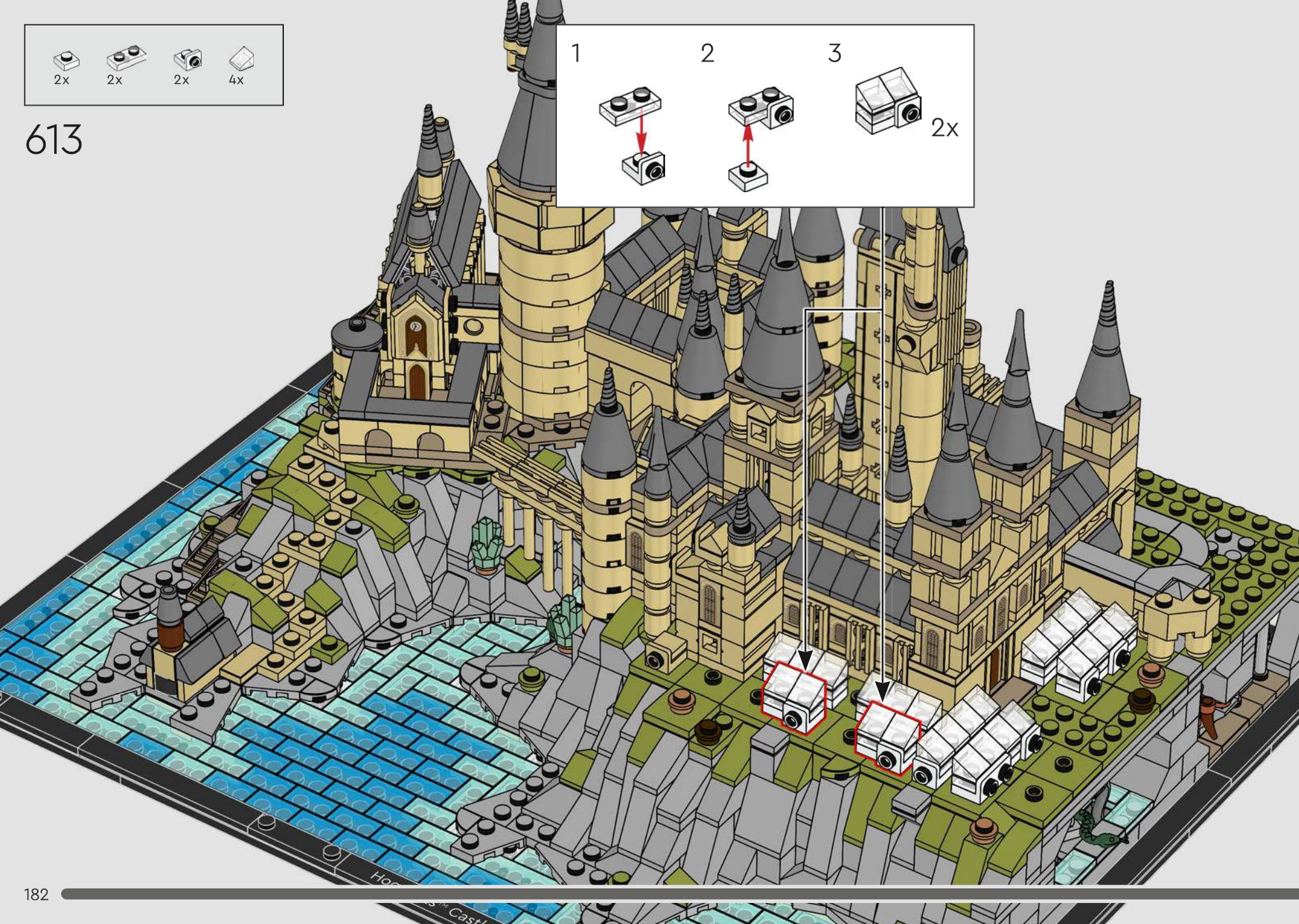
1	2	3
		



2x  2x  2x 

614

1  2  2x 

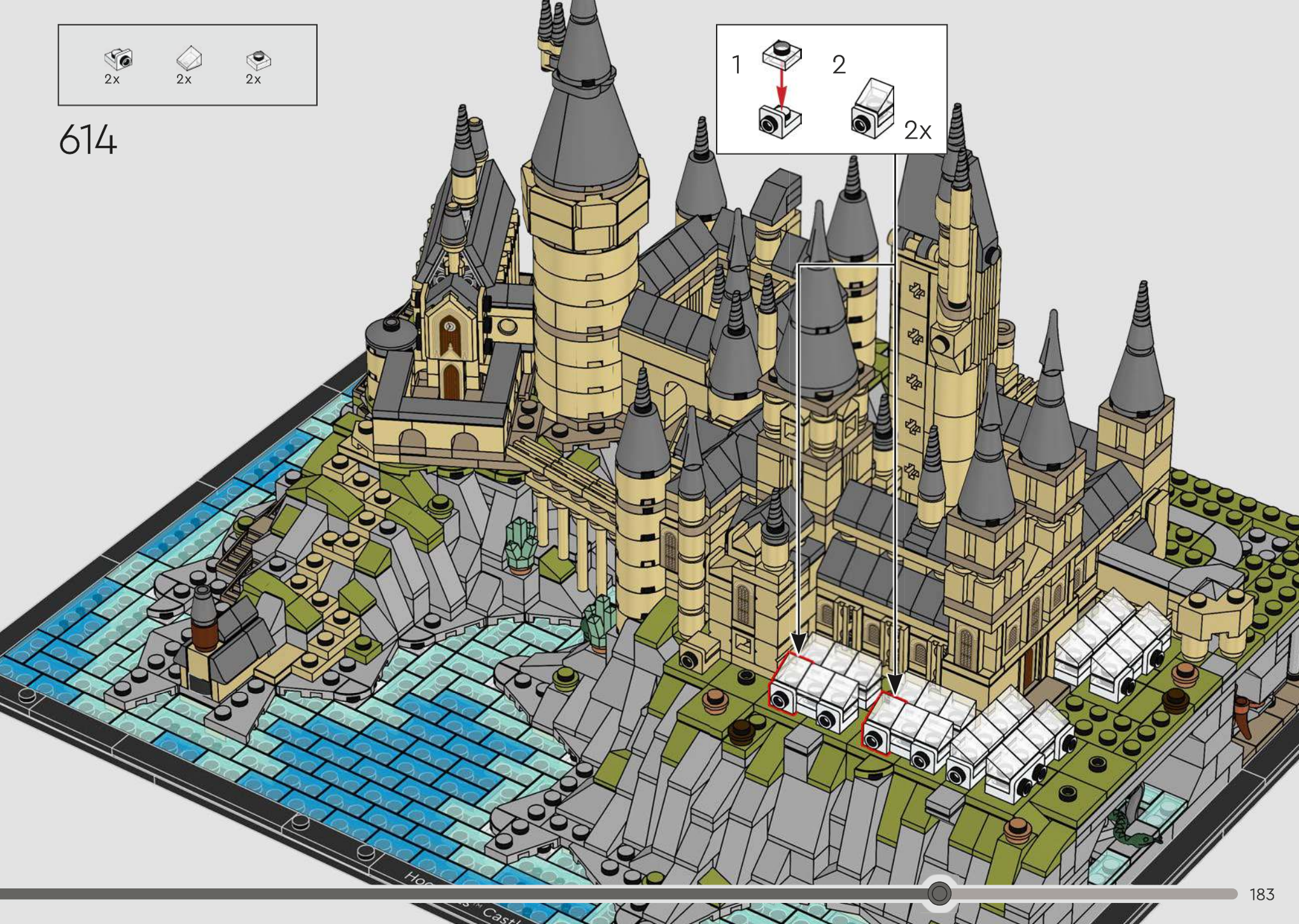
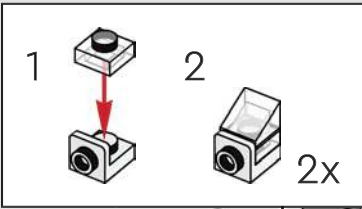

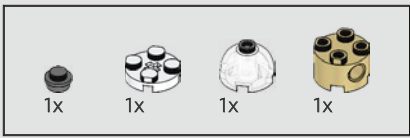

615

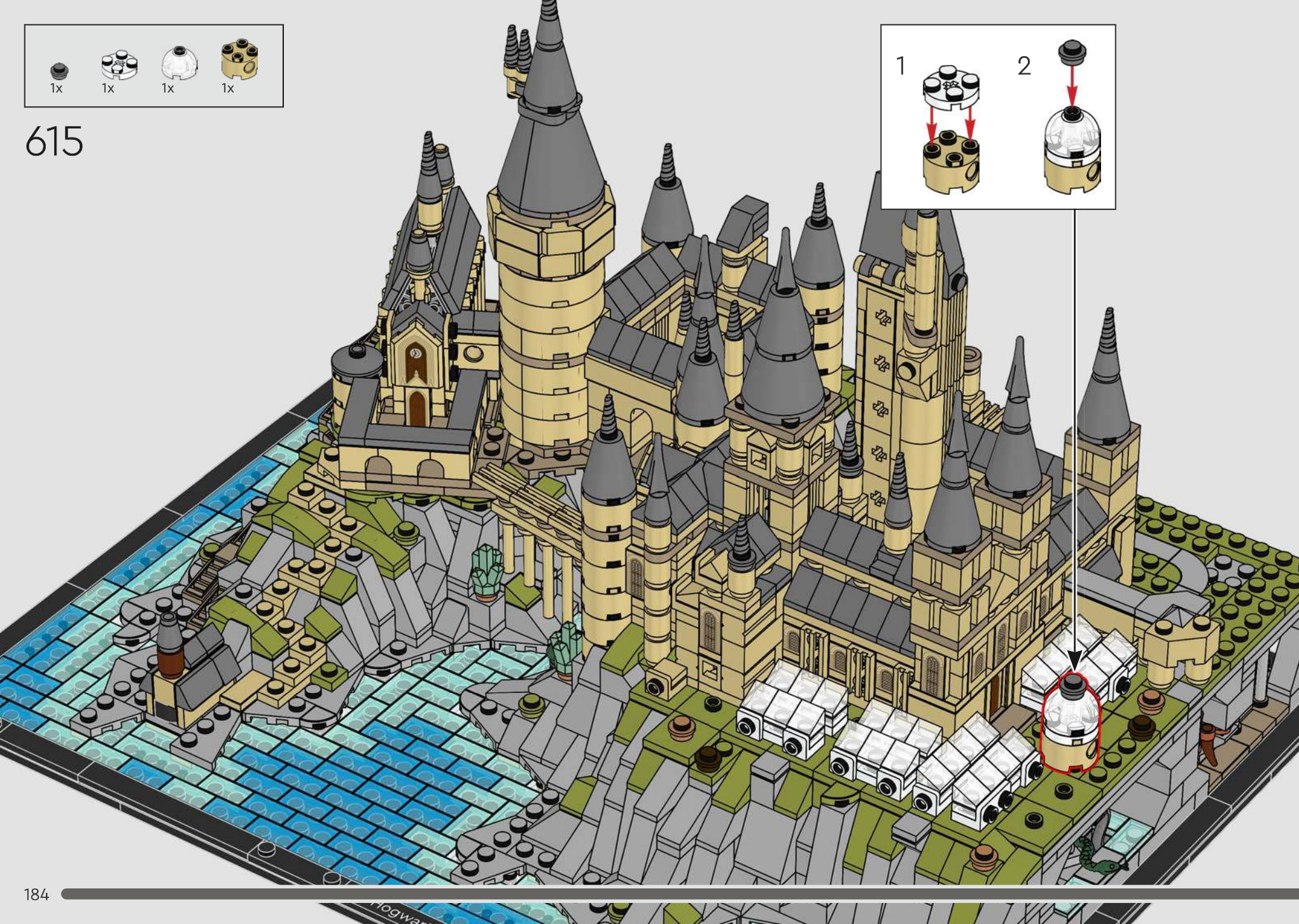
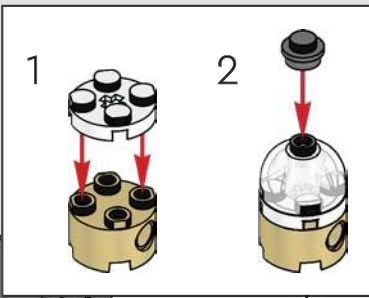

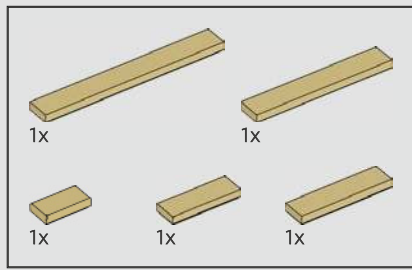

616

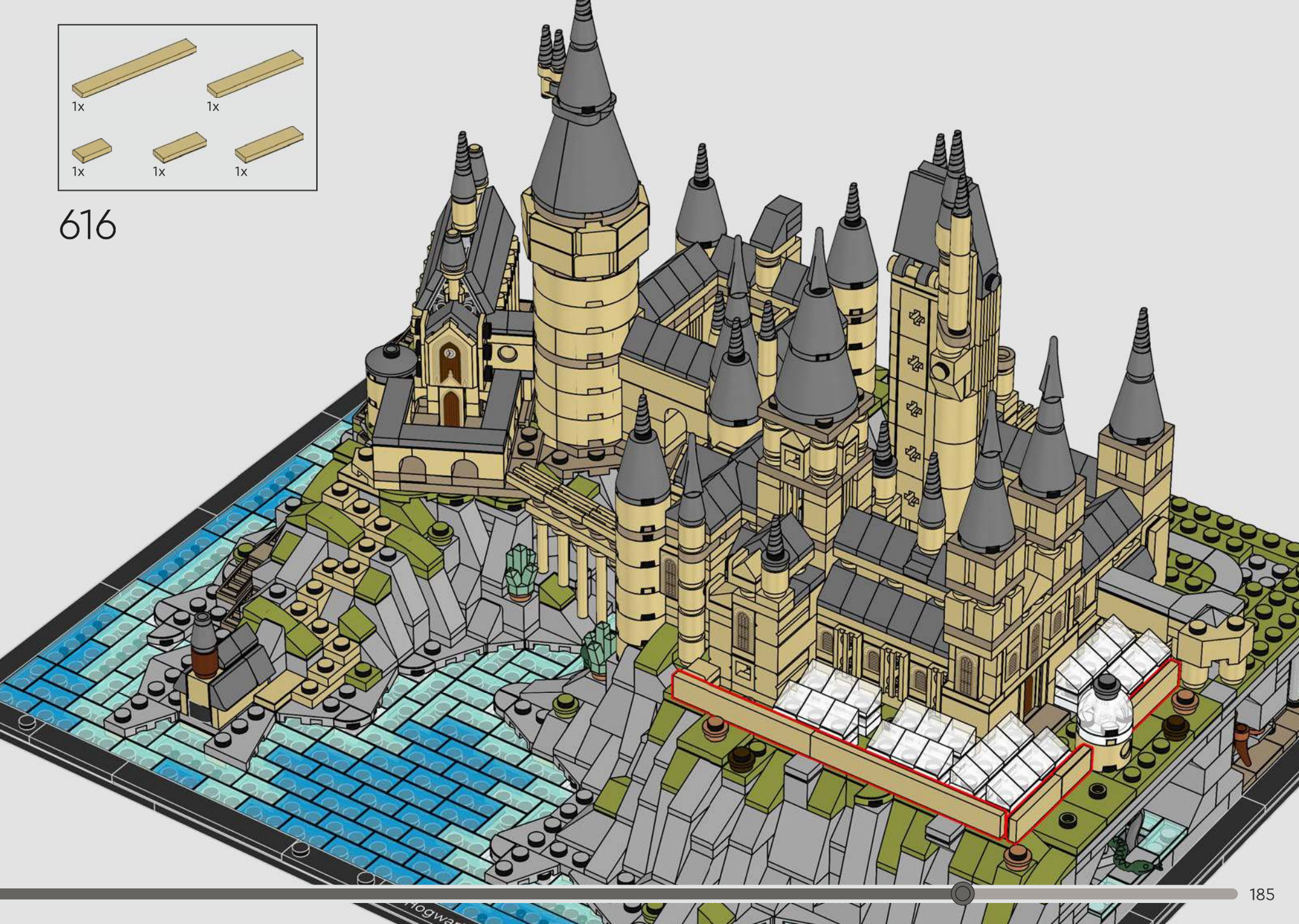

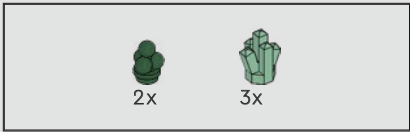

617

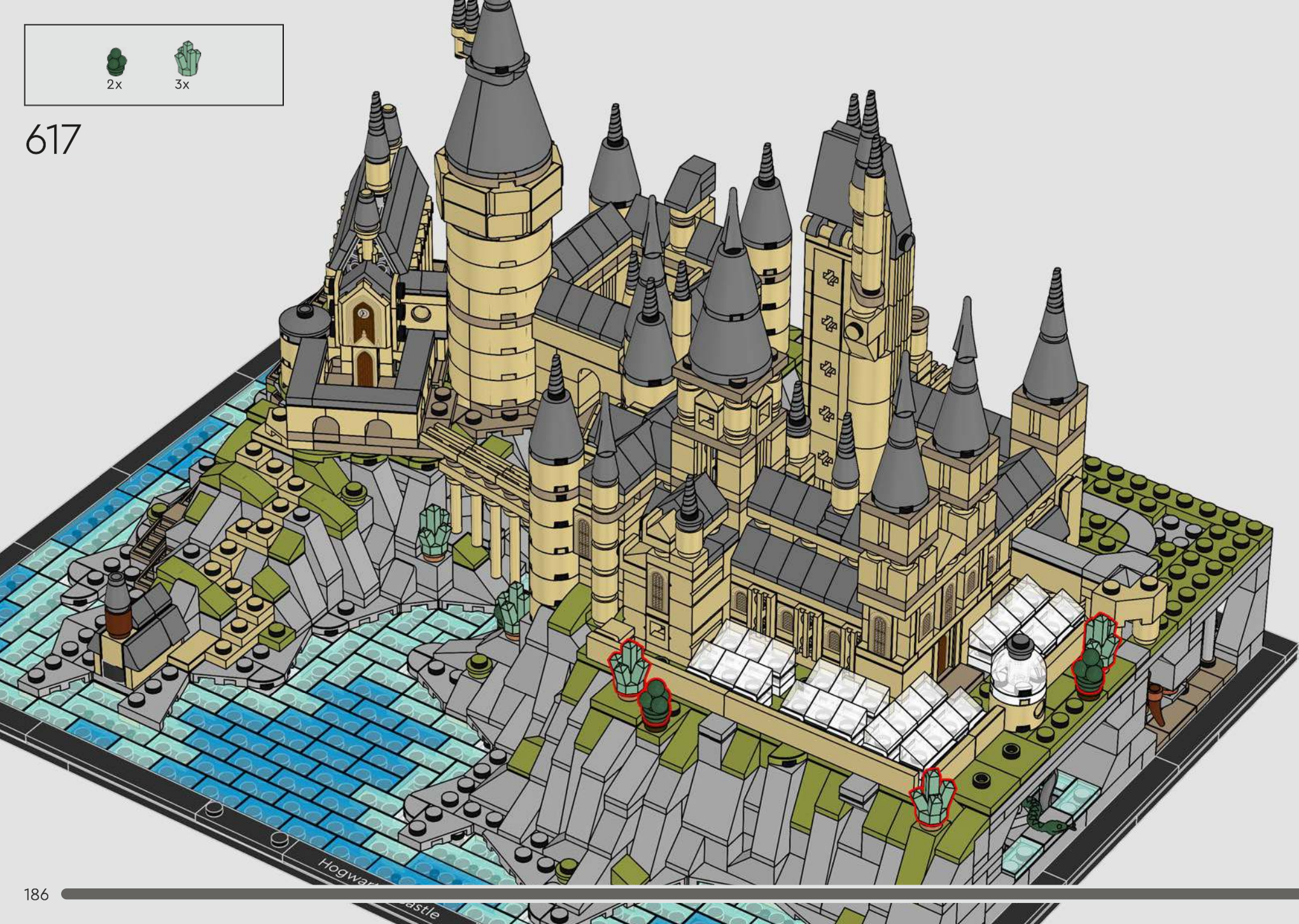

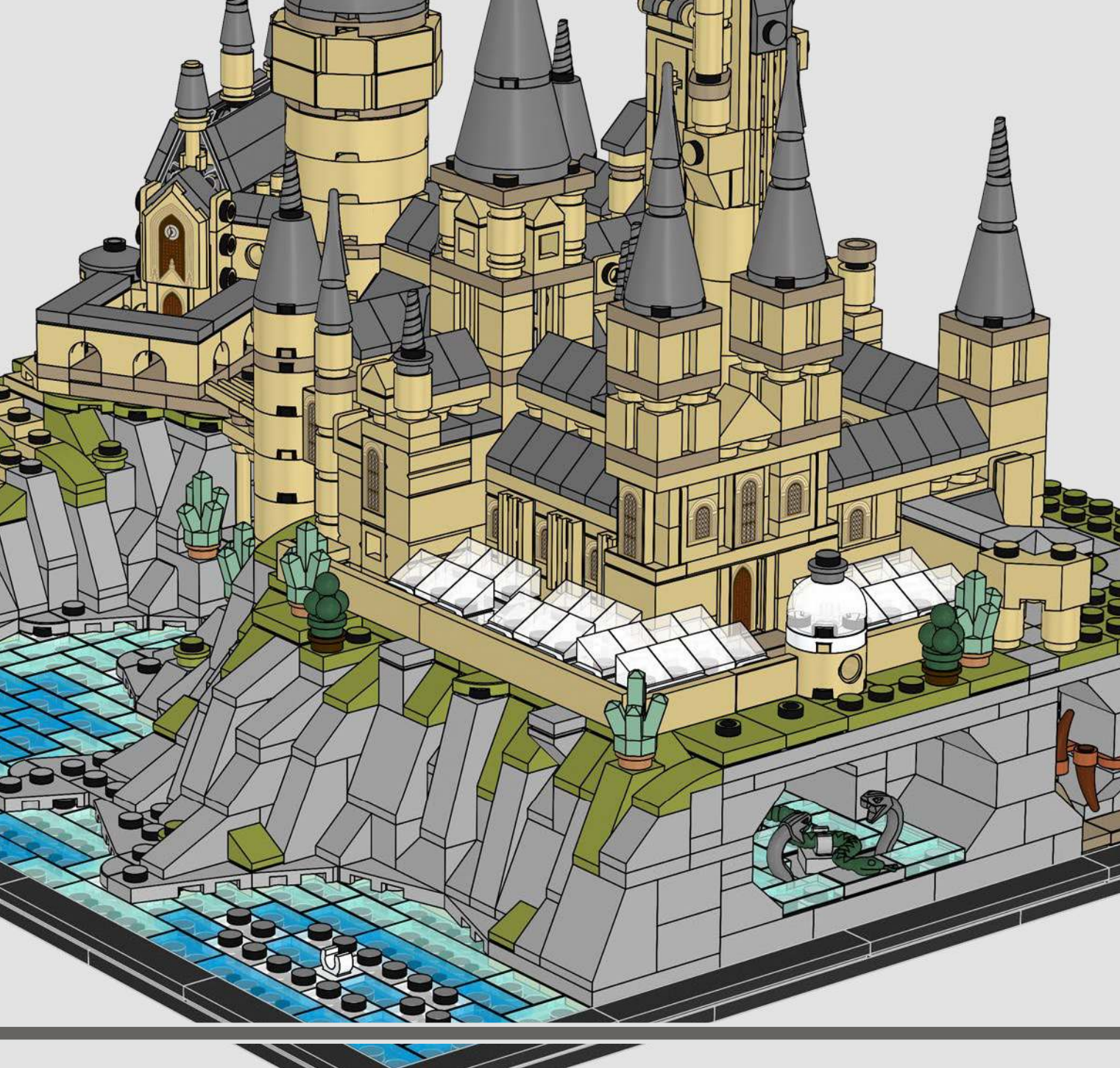

The greenhouses are where Professor Sprout, Head of the Hogwarts™ Herbology department, guides students safely through the care and use of magical plants. Now, if only everyone would use their earmuffs...



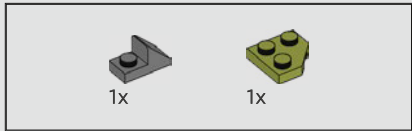

618

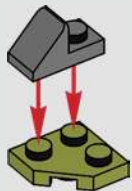

619

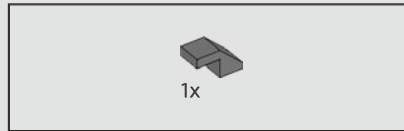

620

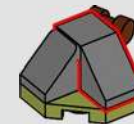

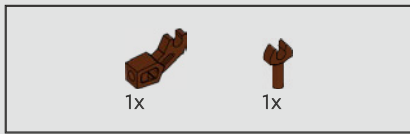

621

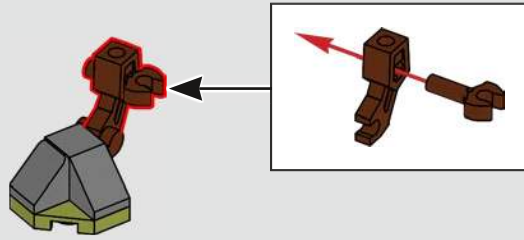

622



623

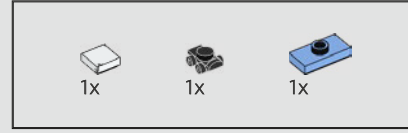

624

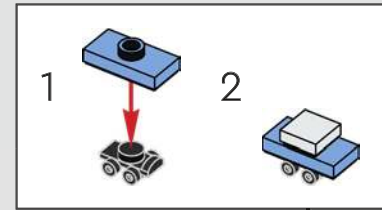



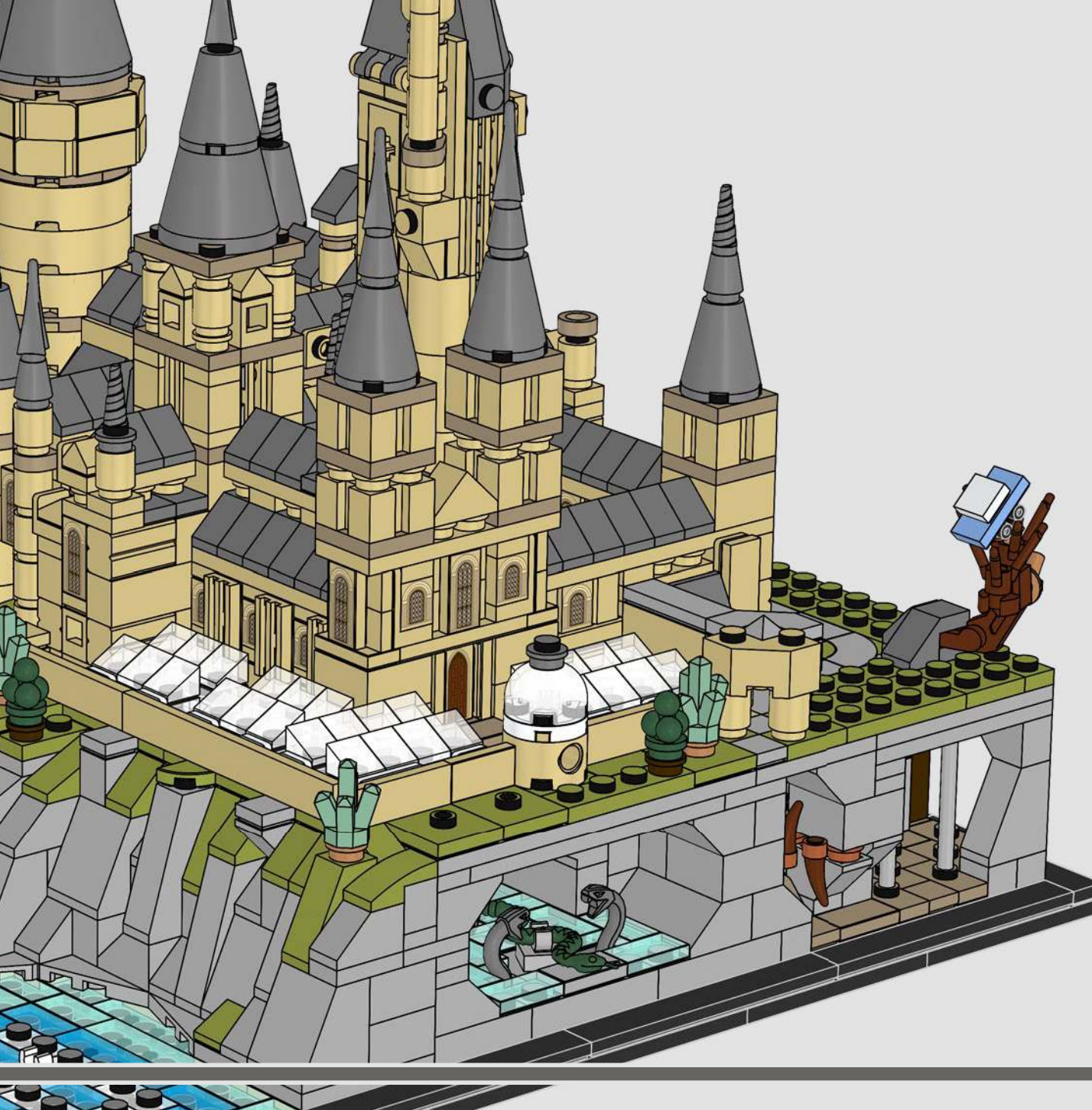

The Whomping Willow™ was planted to give Professor Lupin a safe escape during his full-moon werewolf episodes. It hides a secret tunnel leading to the Shrieking Shack where Lupin would stay until he transformed back into human form.





626

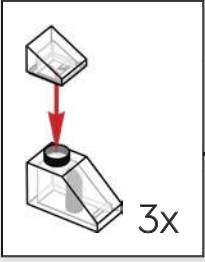
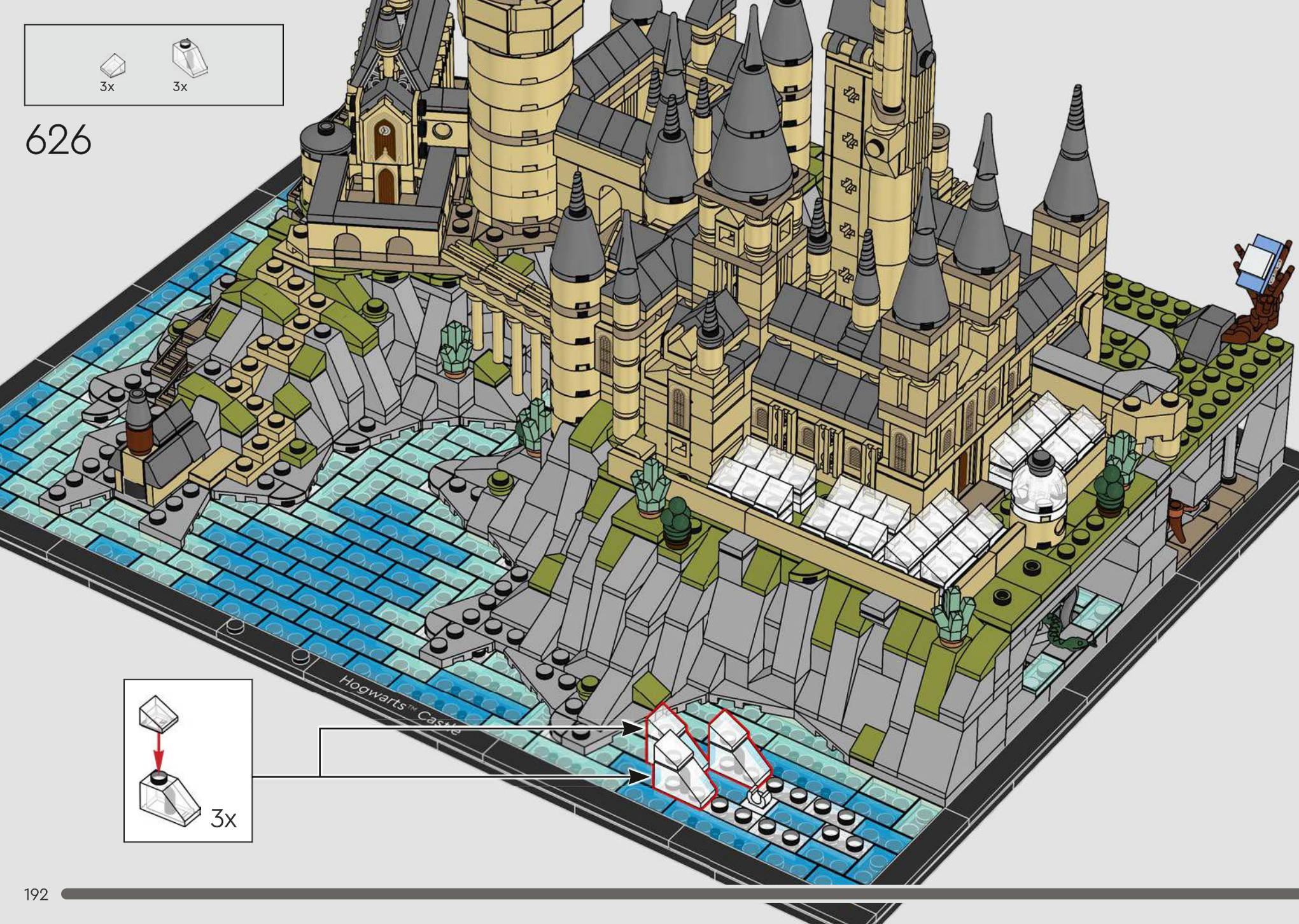



627

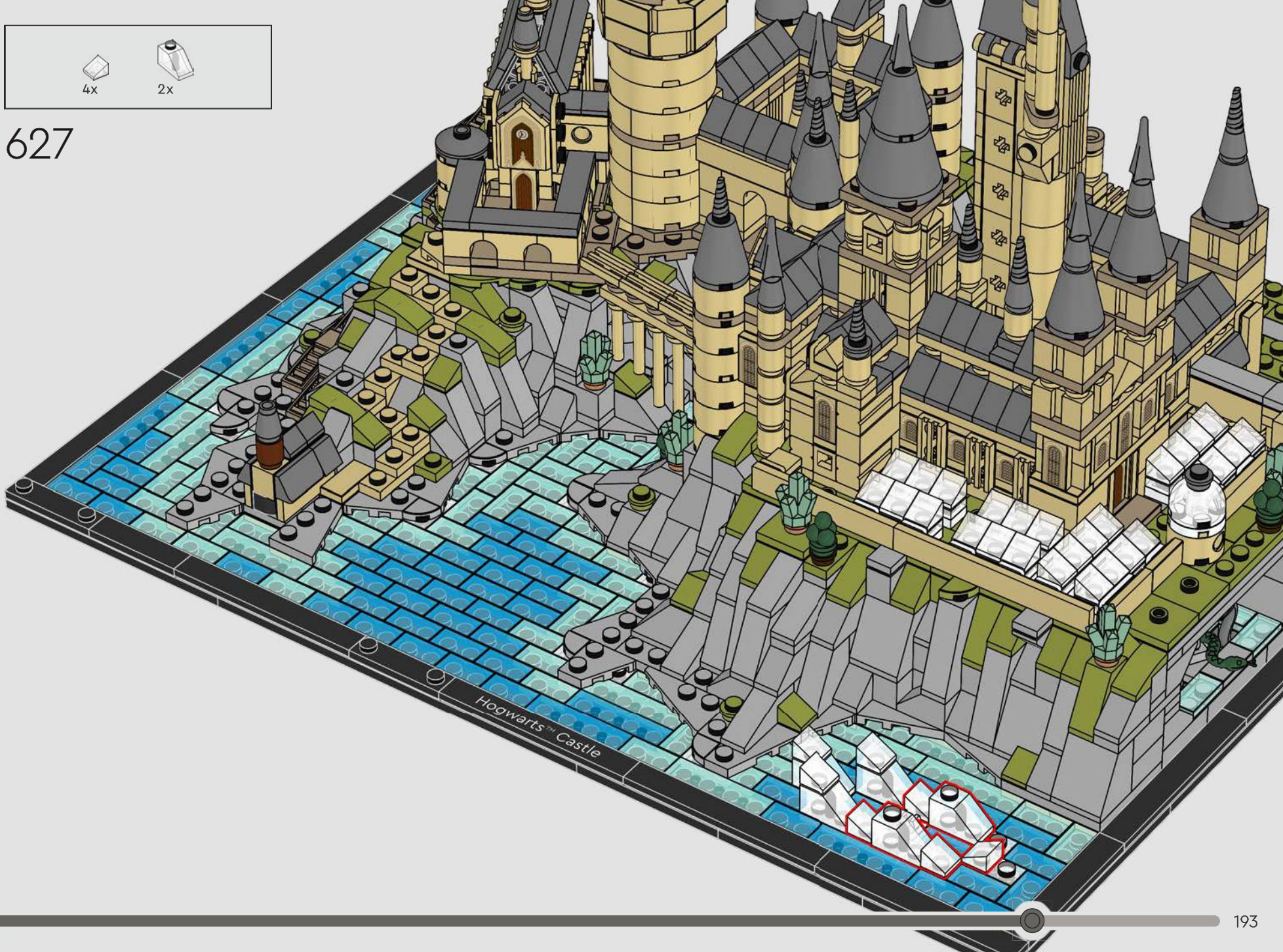

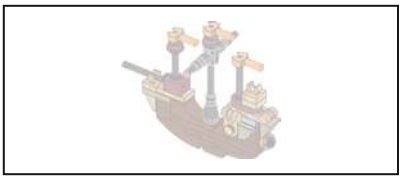

628

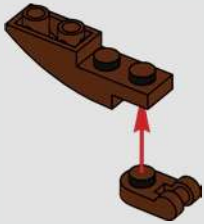

629

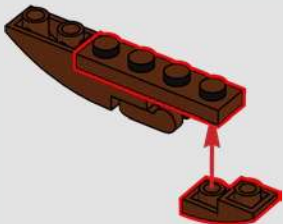

630

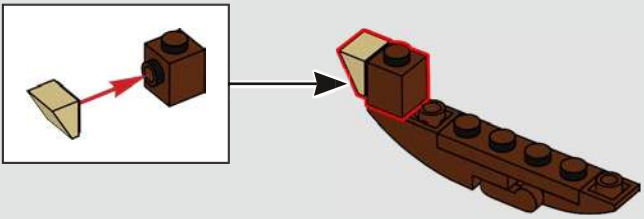

631

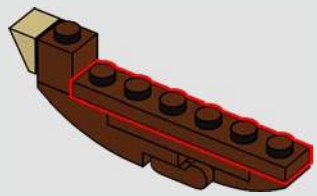

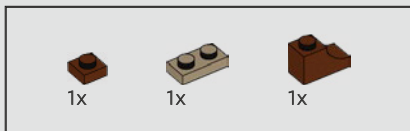

632

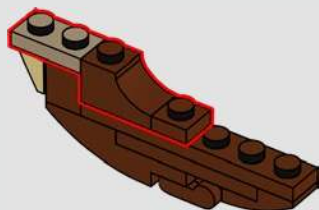

633

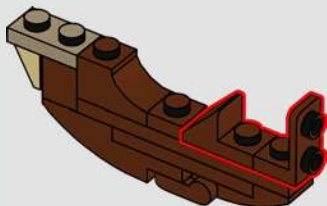

634

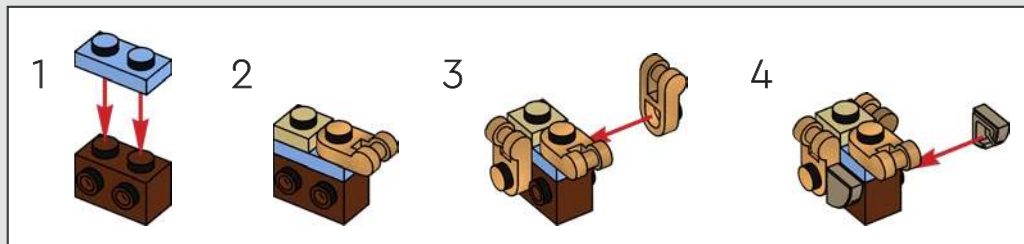

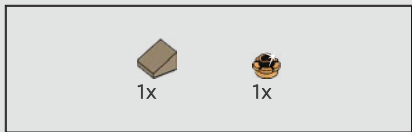

635

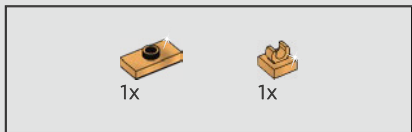
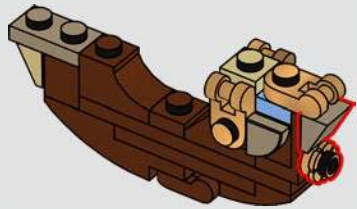

636

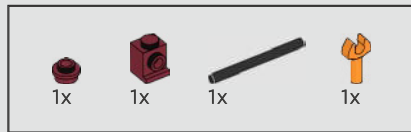

637

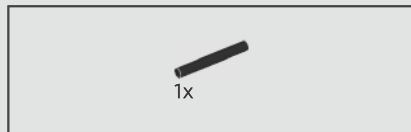
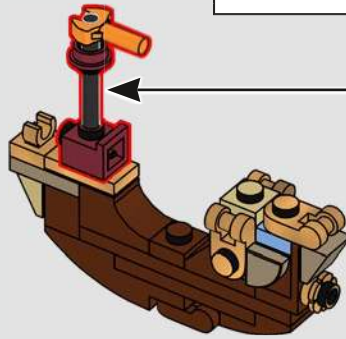
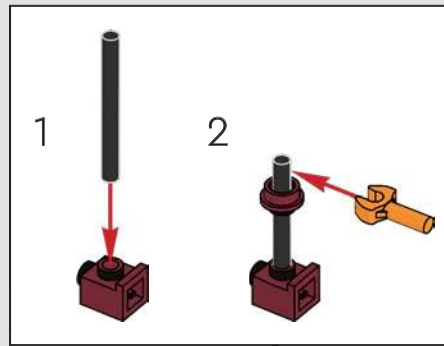

638

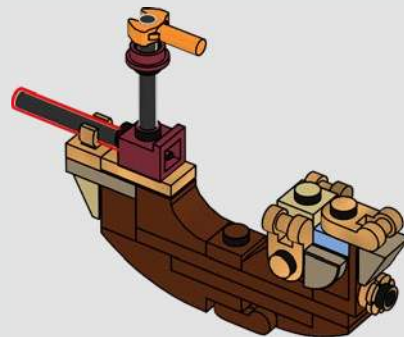

The magical Durmstrang Ship was used to travel between the Durmstrang Institute and Hogwarts™ for the Triwizard Tournament. But have you ever wondered how the ship got from the North Sea into the Black Lake?



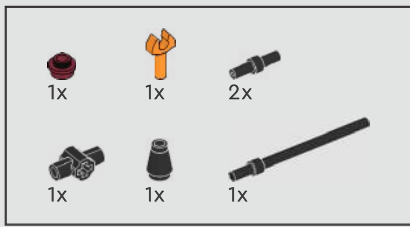

639

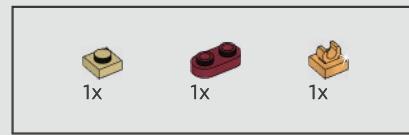
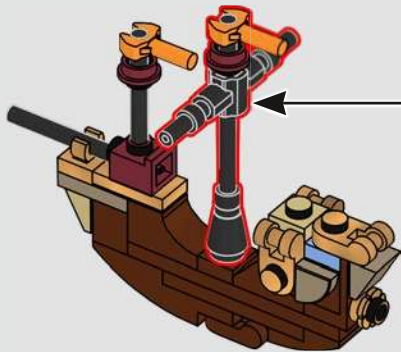
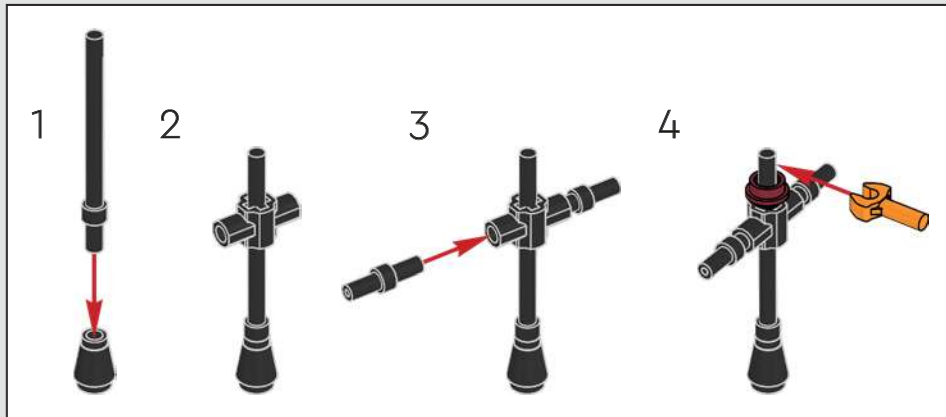

640

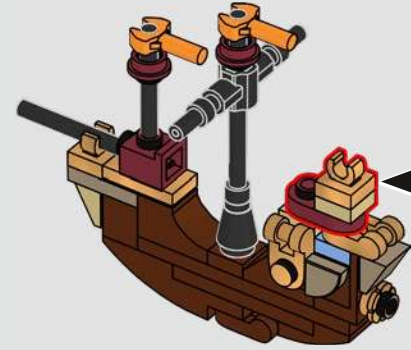
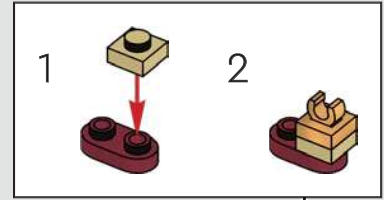

641

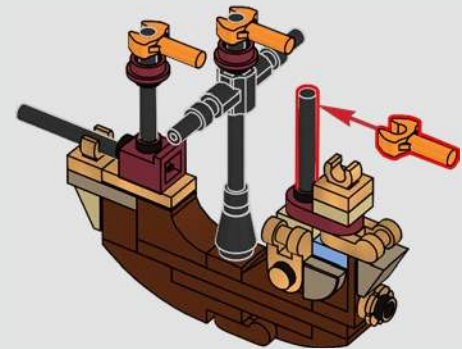





The Durmstrang Ship arrived in the lake through a magical shortcut created between the lake and other bodies of water – truly magical!

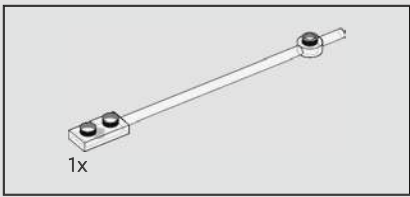

643

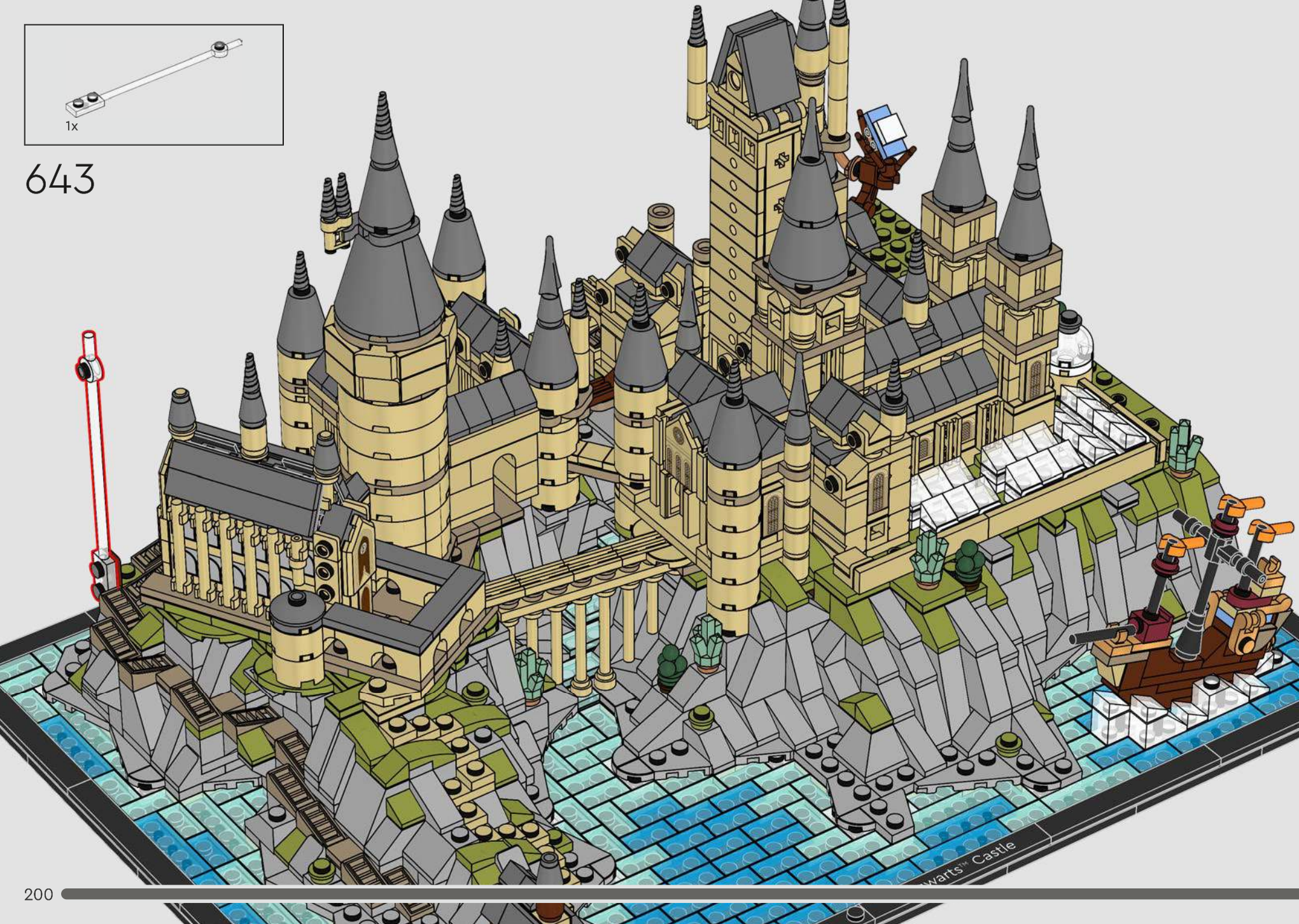

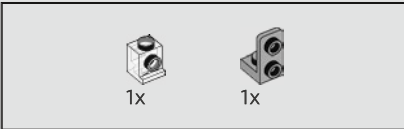

644

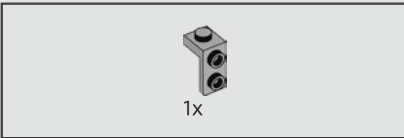

645



646

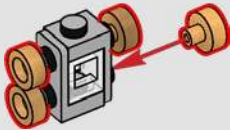



647

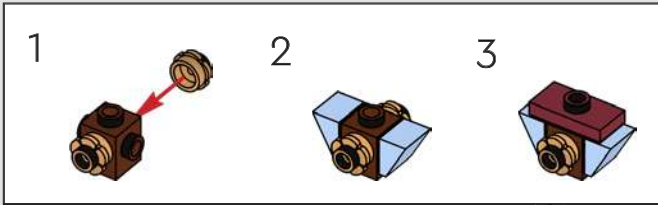

648

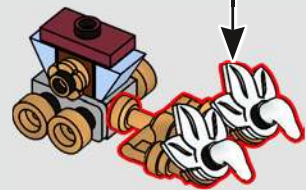
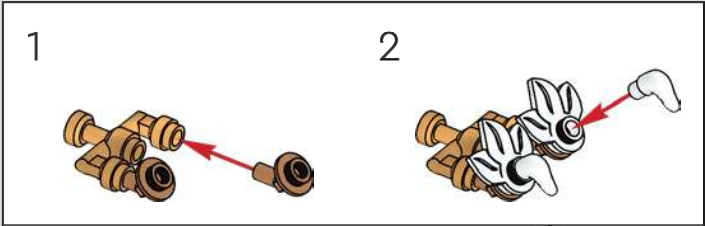

649

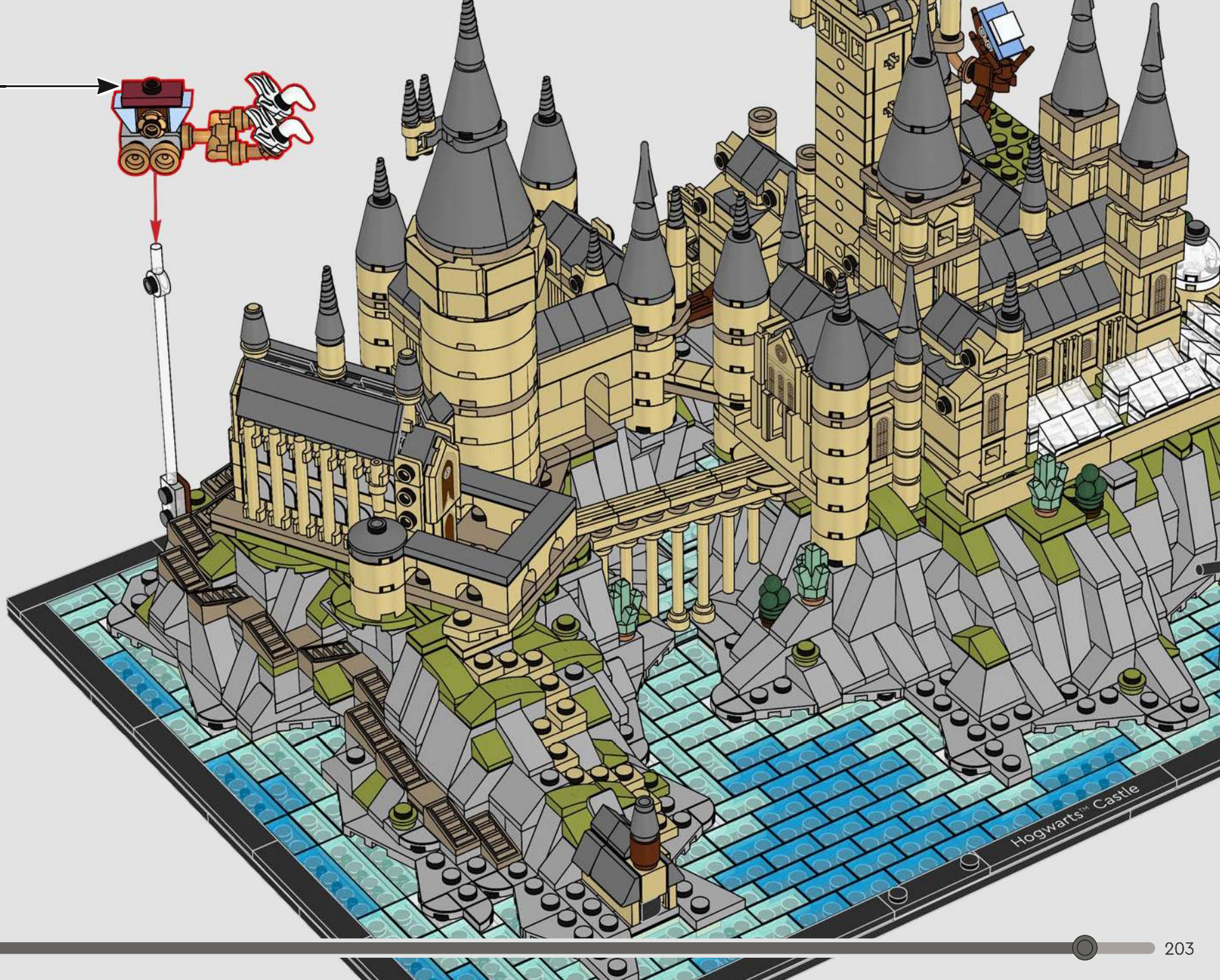

Hogwarts<sup>™</sup> Castle

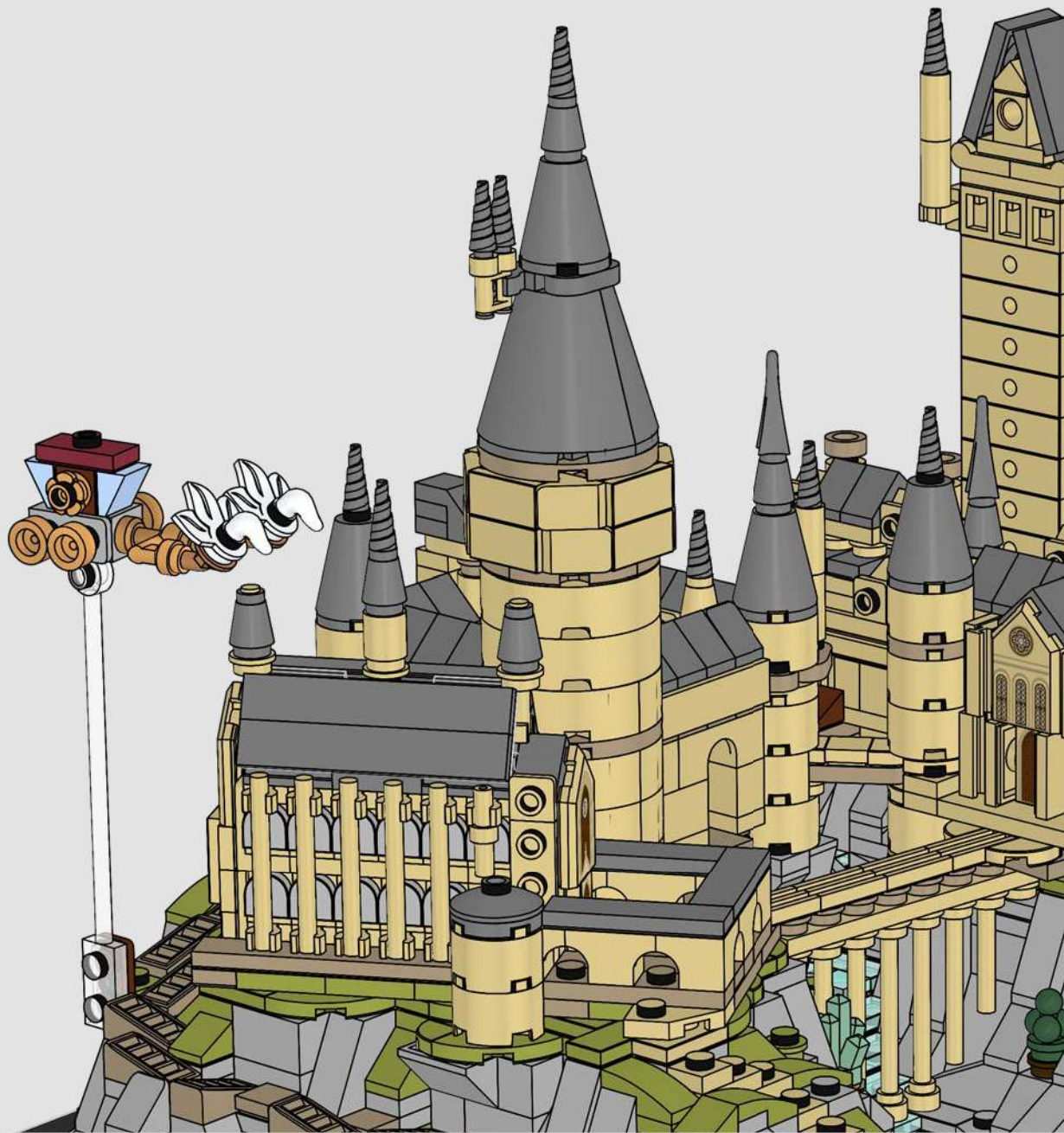

The Pegasus of the Beauxbatons' Carriage is built with white LEGO® horn and leaf elements. Notice the reins? They are actually a magically transformed candleholder!

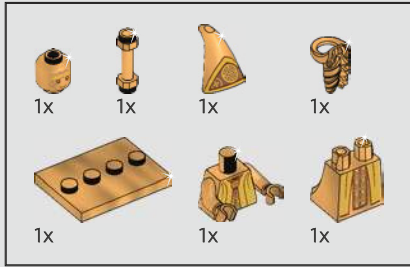

650

1

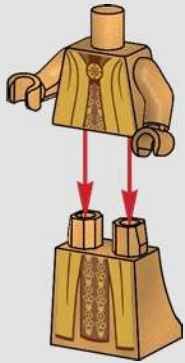

2

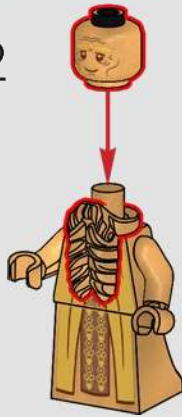

3

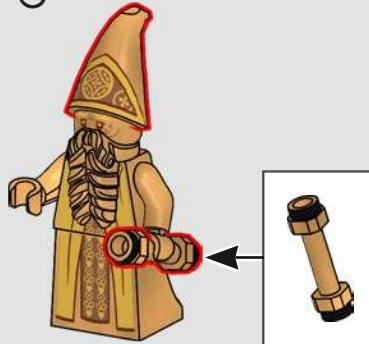

4



The Architect of Hogwarts™ Castle minifigure was created exclusively for this set, with a new beard element, and a Hogwarts model and blueprint scroll in his hand.

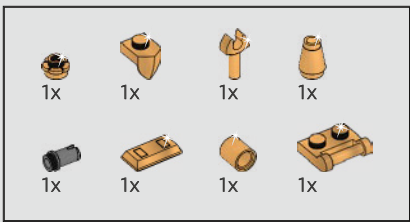

651

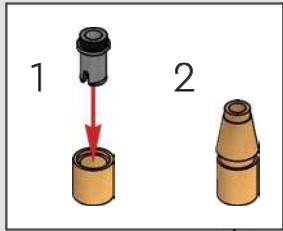

1

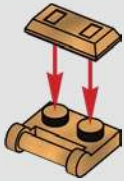

2



3



4





The Architect of  
Hogwarts™ Castle was  
active in the years  
around the turn of the  
tenth century. Not  
much is known about  
his life or other works.









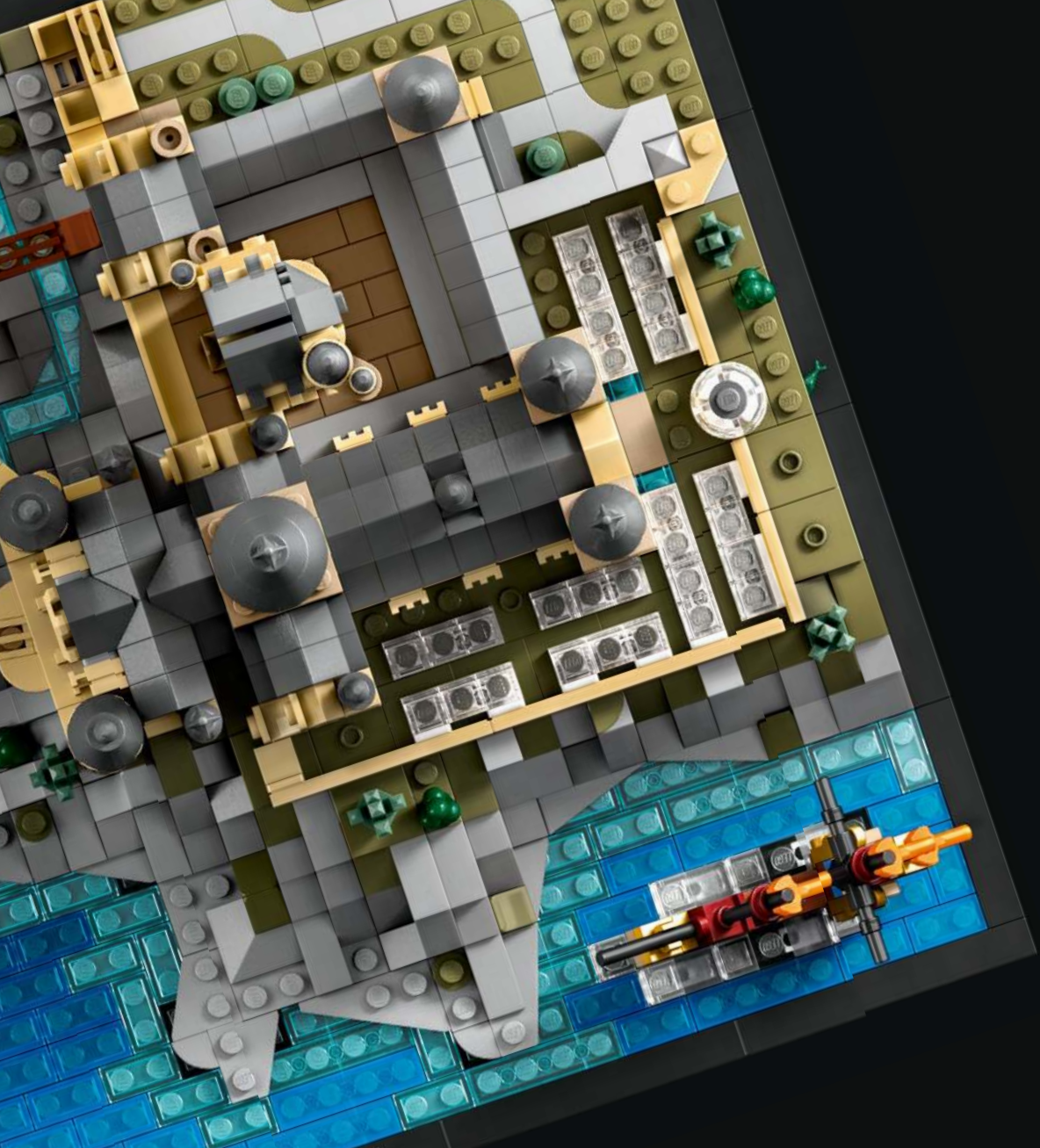

Hogwarts™ Castle



- 2x 614101
- 2x 6186681
- 2x 6328195
- 5x 307001
- 9x 302401
- 1x 6348055
- 8x 6242241
- 2x 4111971
- 2x 6382783
- 1x 6044691
- 1x 403201
- 1x 4667575
- 7x 302301
- 1x 6070698
- 3x 362301
- 11x 6195371
- 1x 4550745
- 1x 246501
- 3x 300201
- 2x 371001
- 2x 300101
- 1x 6222425
- 1x 366601
- 7x 6454936
- 27x 4117070
- 3x 4529237
- 63x 4161734
- 11x 6443061
- 2x 6353196
- 1x 4569547
- 1x 6167923
- 19x 4113915
- 20x 6454440
- 30x 4118793
- 9x 6230284
- 41x 4159553
- 16x 4125253
- 10x 4516055
- 8x 6232135
- 2x 4612603
- 3x 6145570
- 3x 4529237
- 63x 4161734
- 11x 6443061
- 2x 6353196
- 1x 4569547
- 1x 6167923
- 1x 4213568
- 1x 4224793
- 1x 6360037
- 1x 6454941
- 2x 6212758
- 5x 6351413
- 2x 6408047
- 1x 6447501
- 1x 6262018
- 1x 4624086
- 2x 4140562
- 2x 4579260
- 2x 4179771
- 4x 6175968
- 17x 6365720
- 3x 6374151
- 1x 6374192
- 1x 4213568
- 1x 4224793
- 1x 6360037
- 1x 6454941
- 2x 6212758
- 5x 6351413
- 2x 6408047
- 1x 6447501
- 1x 6262018
- 1x 4624086
- 2x 4140562
- 2x 4579260
- 2x 4179771
- 4x 6175968
- 17x 6365720
- 3x 6374151
- 6x 6236425
- 40x 4113917
- 34x 4114026
- 9x 6148262
- 43x 6092587
- 36x 4124456
- 10x 6455327
- 3x 6236914
- 8x 6069165
- 4x 4109995
- 1x 6024495
- 1x 6214334
- 2x 4159279
- 5x 6236423
- 1x 6445058
- 3x 6455326
- 10x 6391523
- 9x 6219794
- 2x 6103001
- 1x 4205107
- 7x 6174925
- 1x 6313611
- 1x 6117975
- 1x 6249809
- 2x 6253003
- 4x 4160483
- 1x 6374166
- 2x 4217562
- 5x 6443062
- 2x 4124455
- 6x 4114077
- 6x 4114306
- 2x 6221467
- 5x 6454937
- 16x 4114084
- 4x 4185177
- 1x 4188866
- 1x 6148265
- 12x 6055868
- 1x 6469454
- 1x 6458487
- 1x 6454439
- 11x 4121921
- 6x 6131896
- 2x 4162465
- 7x 4618651
- 1x 6058093
- 4x 6211966
- 9x 6410762
- 1x 6245271
- 1x 4543858
- 12x 6116614
- 9x 4118790
- 4x 4159739
- 2x 6175367
- 10x 4113233
- 5x 6232136
- 7x 6257600
- 5x 4550324
- 23x 6352222
- 2x 4113916
- 1x 6213676
- 2x 6294592
- 4x 6115031
- 2x 6454935
- 10x 4114309
- 1x 6351905
- 7x 4124067
- 6x 4112982
- 1x 4157277
- 3x 4243824
- 1x 6383728
- 7x 4113993
- 2x 4181134
- 4x 4114324
- 2x 4159774
- 1x 4544139
- 4x 4114001
- 4x 4113988
- 1x 6075179
- 1x 4624185
- 2x 447721
- 2x 611121
- 4x 614121
- 2x 362221
- 1x 302121
- 5x 371021
- 2x 6372124
- 4x 6315780
- 1x 6347604
- 5x 242023
- 5x 301023
- 2x 366623
- 17x 614124
- 6x 362224
- 3x 362324
- 1x 4188313
- 1x 6457333
- 1x 6350055
- 1x 6454443
- 3x 6212377
- 1x 6207933
- 1x 6092594
- 1x 6326425
- 1x 6454437
- 1x 4585493
- 1x 6378168
- 4x 6209691
- 1x 4529247
- 1x 6186672
- 1x 6453281
- 1x 6454435
- 1x 6256803
- 2x 6262138
- 1x 6415995
- 1x 6083975

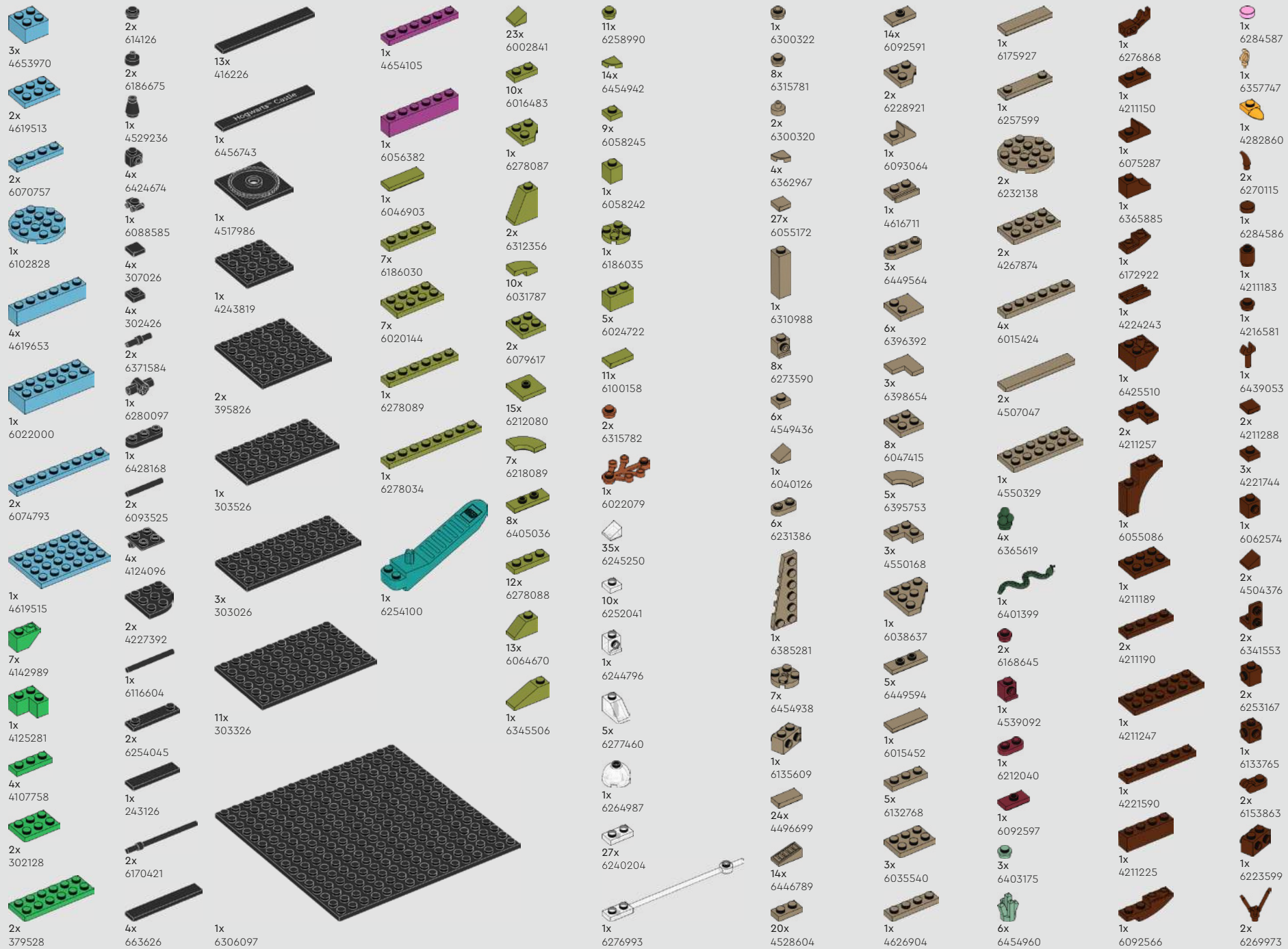

- 1x 4210763
- 2x 6168776
- 4x 4211066
- 2x 6331866
- 3x 4211094
- 1x 6126083
- 1x 6201630
- 10x 6092666
- 1x 6115080
- 1x 4211010
- 2x 6174938
- 17x 6445056
- 6x 6269969
- 15x 4529240
- 2x 6331689
- 1x 4210867
- 2x 4211100
- 8x 4210719
- 1x 4243831
- 1x 6186635
- 2x 4211103
- 3x 6231765
- 2x 4210633
- 1x 6431826
- 3x 6395635
- 4x 6454438
- 1x 4211098
- 5x 6343852
- 4x 4210651
- 4x 6262021
- 2x 4504378
- 2x 6234583
- 2x 6235153
- 7x 6167641
- 4x 6400315
- 51x 6251289
- 8x 6252050
- 1x 4179825
- 1x 6092601
- 1x 6221607
- 1x 6296892
- 45x 4226221
- 3x 4567887
- 14x 4211135
- 1x 4211088
- 3x 6069164
- 2x 6092572
- 3x 4211053
- 1x 4526932
- 9x 4211394
- 1x 4529241
- 1x 6284071
- 3x 6448793
- 21x 6250597
- 1x 6455328
- 5x 4521921
- 23x 4211389
- 5x 6362975
- 12x 6176433
- 3x 6345639
- 2x 6433942
- 12x 6163478
- 6x 4211415
- 2x 4211489
- 1x 4526932
- 9x 4211394
- 1x 6420741
- 6x 4211791
- 5x 4211794
- 1x 6234738
- 18x 4211399
- 1x 6225242
- 46x 4211614
- 1x 6347715
- 3x 6258381
- 2x 4568637
- 2x 6075075
- 15x 4211488
- 2x 6211969
- 12x 4211428
- 7x 6116608
- 4x 6066097
- 5x 6186657
- 1x 4216248
- 3x 6308012
- 4x 6065824
- 1x 4651063
- 1x 6469440
- 1x 6269049
- 40x 4515374
- 12x 4211437
- 20x 4211388
- 6x 4657459
- 2x 4211773
- 10x 4211445
- 13x 6093859
- 11x 4211494
- 46x 4211398
- 9x 4211414
- 2x 6170387
- 1x 4211564
- 2x 6123809
- 5x 4234535
- 8x 4211353
- 2x 4211410
- 1x 6163990
- 11x 4211396
- 1x 6306729
- 4x 6163477
- 1x 6213378
- 13x 6435857
- 14x 4211349
- 11x 4211387
- 1x 4216250
- 3x 4211397
- 1x 6177078
- 1x 6126082
- 18x 4211429
- 8x 4211386
- 2x 6435930
- 2x 6435930
- 1x 6306729
- 4x 6163477
- 1x 4645397
- 3x 4558169
- 1x 6075066
- 3x 4211438
- 2x 4211393
- 1x 4618874
- 2x 4243797
- 2x 4211549
- 1x 6015347
- 7x 4211385
- 2x 4211395
- 1x 6372029
- 1x 4211392
- 6x 4211404
- 1x 6037399
- 1x 4211474
- 3x 4251149
- 2x 4211521
- 2x 4211407
- 3x 6059033
- 3x 4211452
- 1x 4211795
- 2x 4211425
- 6x 4157103
- 3x 6439042
- 3x 4173805
- 16x 4121739
- 17x 4220634
- 23x 4164037
- 10x 6254256
- 85x 6251295
- 3x 6343877
- 11x 6252049
- 1x 4211522
- 1x 4211402
- 1x 4211405



[LEGO.com/service](https://www.LEGO.com/service)



# YOU COULD WIN



## YOU COULD WIN

Your feedback will help shape the future development of this product series.

Visit:

## DU KÖNNTEST GEWINNEN

Dein Feedback trägt zur Weiterentwicklung dieser Produktreihe bei.

Geh auf:

## VOUS POURRIEZ GAGNER

Vos commentaires nous aideront à concevoir les futurs produits de cette gamme.

Visitez :

## POTRESTI VINCERE TU

La tua opinione ci aiuterà a migliorare la creazione futura di questa linea di prodotti.

Visita:

## PUEDES GANAR

Tu opinión contribuirá al futuro de esta serie de productos.

Visita:

## 轻松获奖

您的反馈将有助于我们在今后改进本产品系列。

请访问:

---

**[LEGO.com/productfeedback](https://www.lego.com/productfeedback)**

---

You also have the chance to win a LEGO® set.

Terms and conditions apply.\*

Außerdem hast du die Chance, ein LEGO® Set zu gewinnen.

Es gelten die Teilnahmebedingungen.\*

Vous pourriez également gagner un ensemble LEGO®.

Des conditions s'appliquent.\*

Hai anche la possibilità di vincere un set LEGO®.

Termini e condizioni sono applicabili.\*

También tienes la oportunidad de ganar un set LEGO®.

Aplican términos y condiciones.\*

您还有机会赢取乐高®套装。

条款和条件适用。\*

\*[LEGO.com/productfeedback-terms](https://www.lego.com/productfeedback-terms)

# II

LEGO and the LEGO logo are trademarks of the LEGO Group. ©2023 The LEGO Group. 6502946

WIZARDING WORLD and all related trademarks, characters, names, and indicia are  
© & ™ Warner Bros. Entertainment Inc. Publishing Rights © JKR. (s23)