





## ARID PLANTS

▣ Arid or desert plants are some of the toughest species you will find. They have evolved to survive in climate zones with harsh winds, intense heat and only very sporadic precipitation. They typically store what little moisture they can attract in plump pods and save it for... well, not a rainy day, but long dry spells instead. Radiant flowers help them attract pollinators, giving them an edge over any competition in their surroundings.



*(Dudleya brittonii)*

**BRITTON'S LIVEFOREVER**

A succulent native only to Baja California, Mexico.



*(Opuntia humifusa)*

**EASTERN PRICKLY PEAR**

A cactus native to large parts of the eastern United States and north-eastern Mexico.



*(Mammillaria crinita  
f. zeilmanniana)*

**PINCUSHION CACTUS**

Native to Mexico, and areas in the south-western United States, the Caribbean and South America.



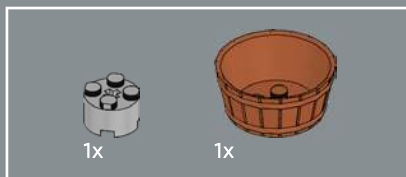

1

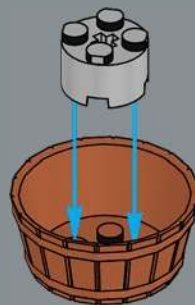



2

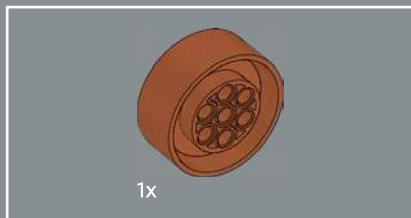
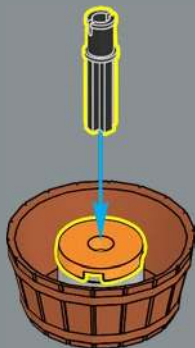

3

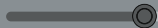
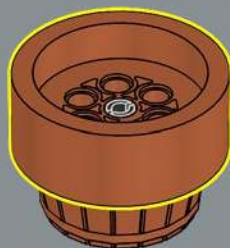



4

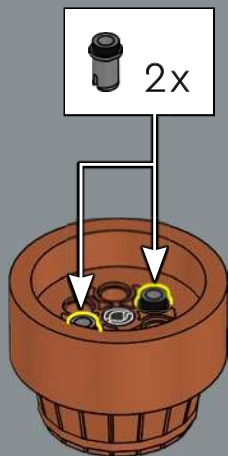

5





This colourful succulent was named after Nathaniel Lord Britton, an American botanist who first categorised the *Dudleya* genus.

6



To capture a nice gradient of spiky leaves, we added a new colour for the 1x1 plate with a tooth. So, if you have any LEGO® animals in your house, you could always give them lovely light lavender teeth.



7

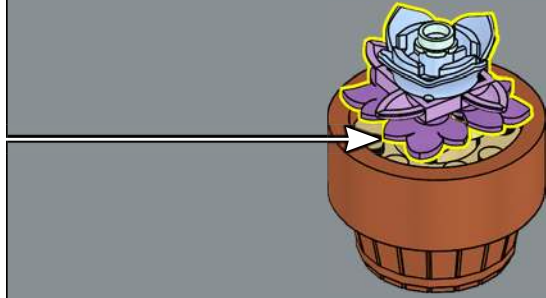
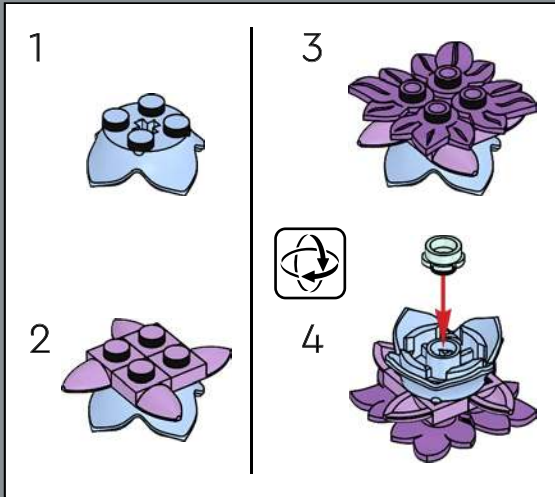

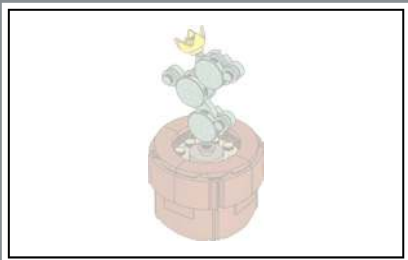

1

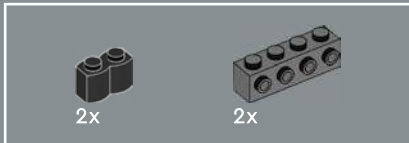
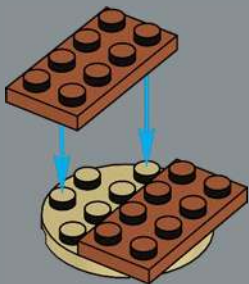

2

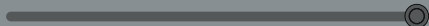
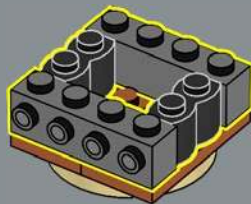

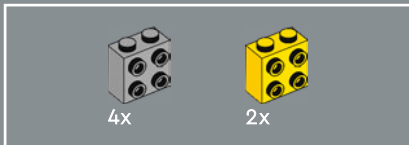

3

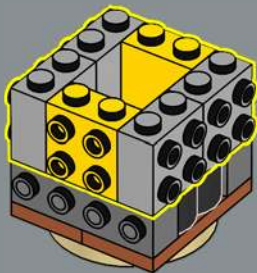

4

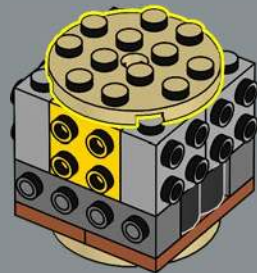

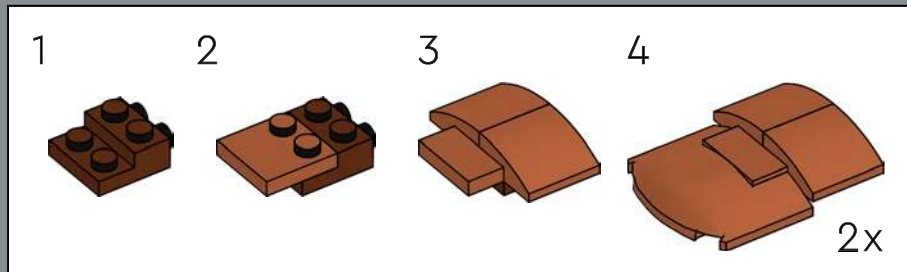
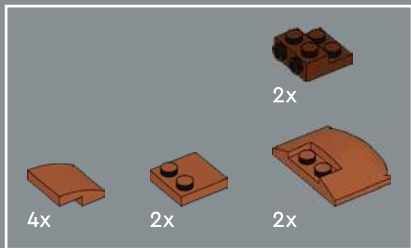

5

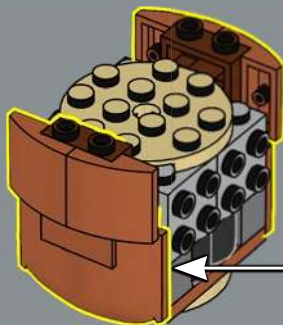

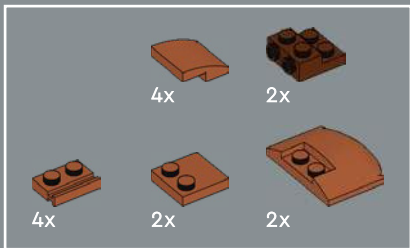

6

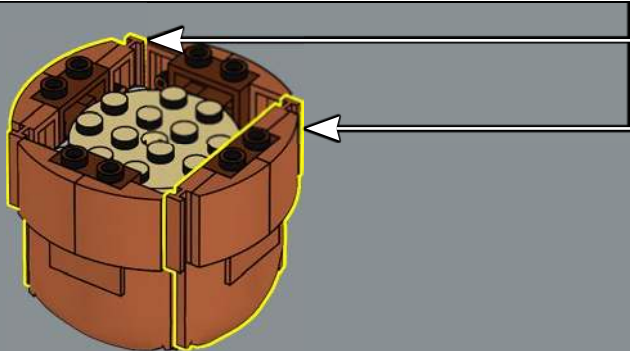
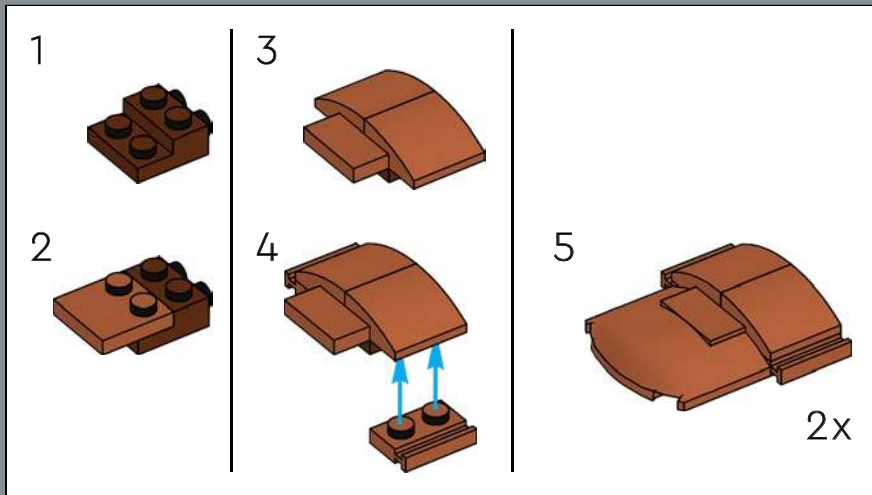

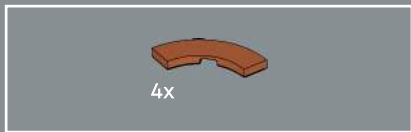

7

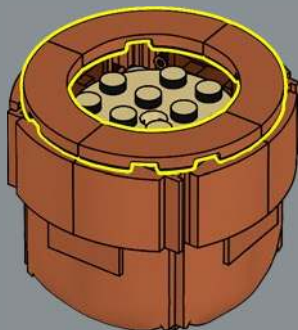

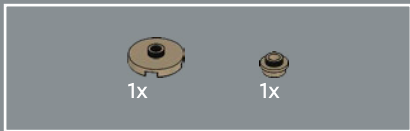

8

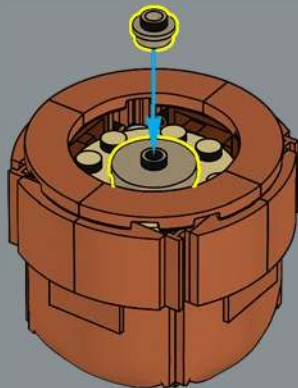

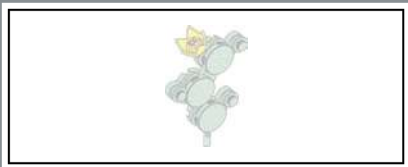

9



10

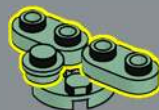

11

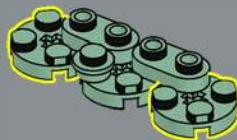

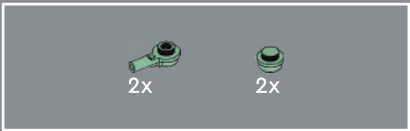

12

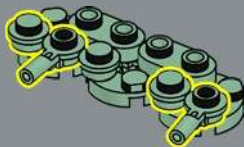

13

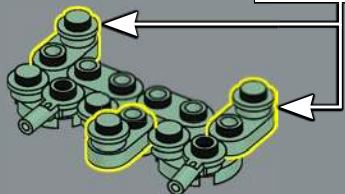
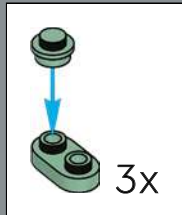



14

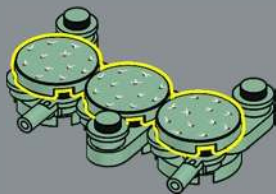

The round printed 2x2 LEGO® tiles are in a new sandy green colour and feature a fun new spiky deco to capture the look of an Eastern prickly pear.

15

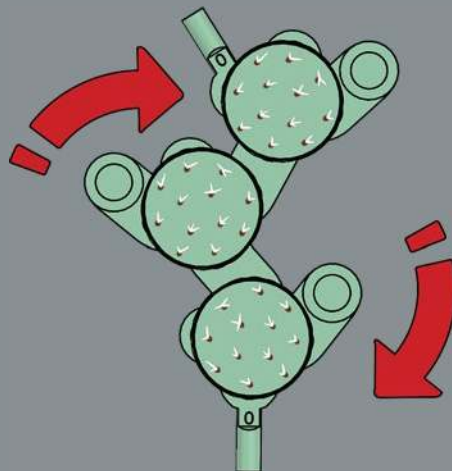

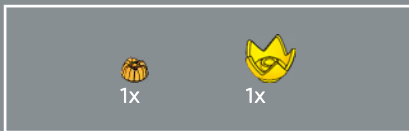

16

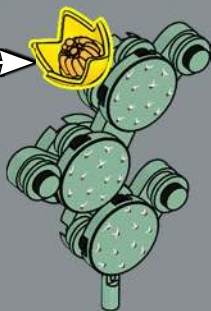
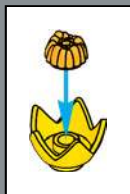

17

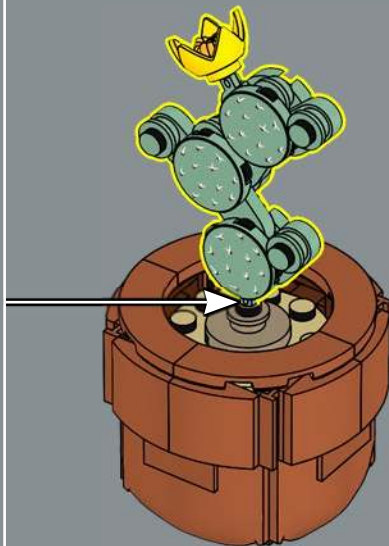

Did you know that prickly pear fruit is edible?  
And so are the big green 'pads'. Just be sure to  
remove the spines before eating!

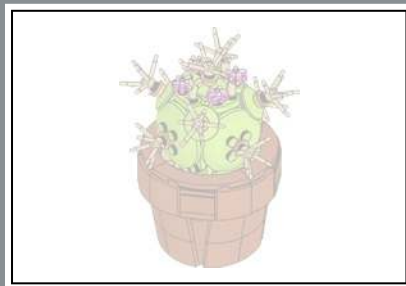

1

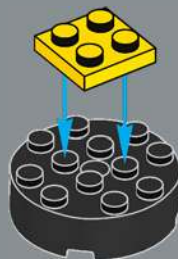

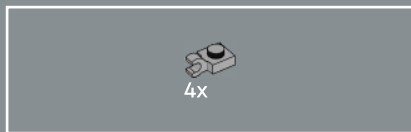

2

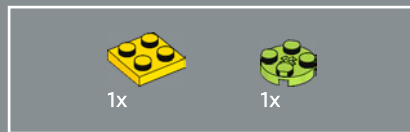

3





4



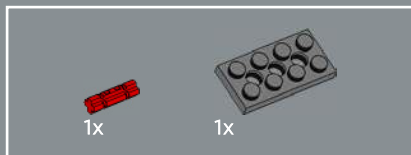

5



6





7

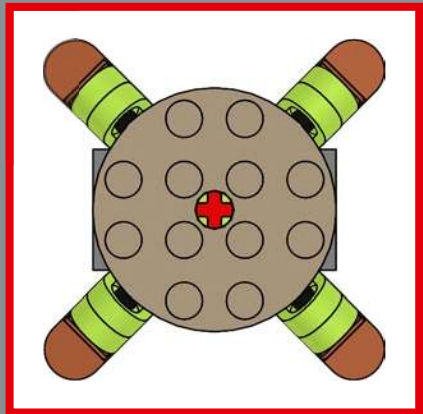
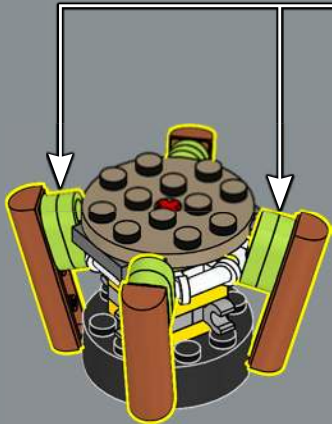
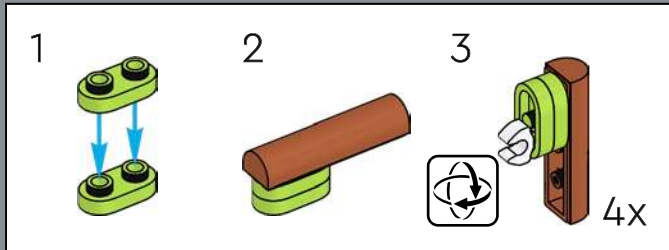

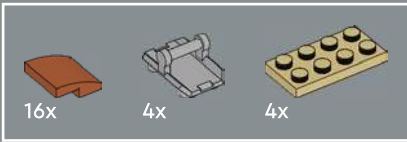

8

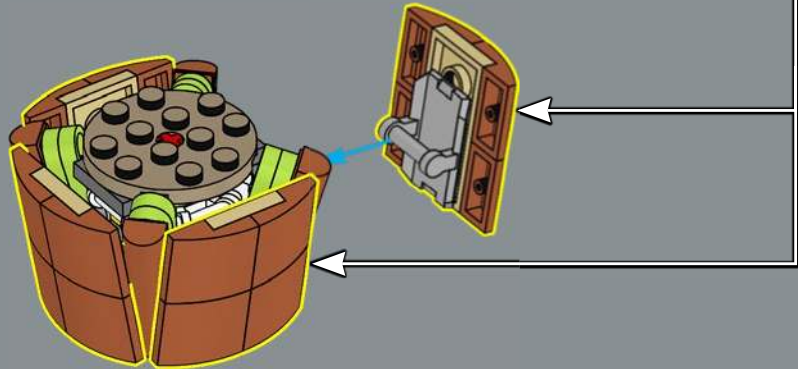
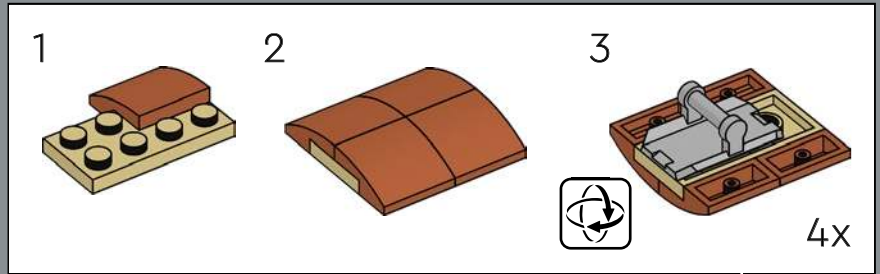

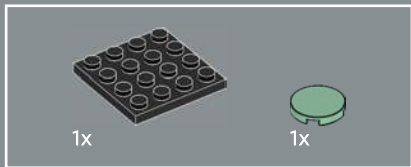
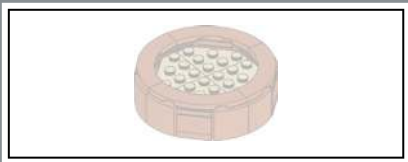

9

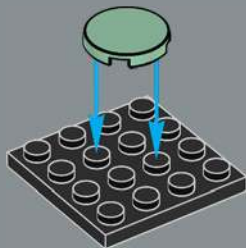

10

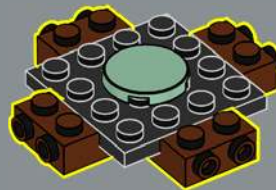



4x

11

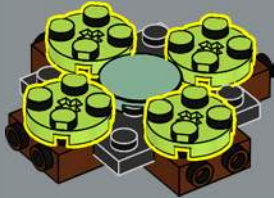

4x

12

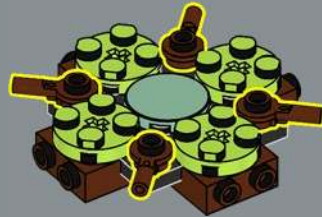

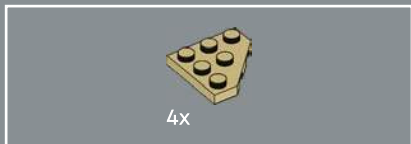

13

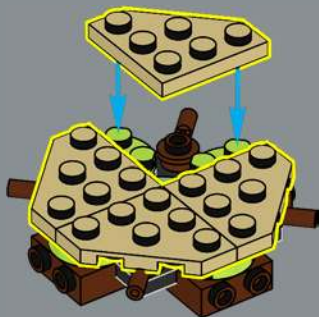

14

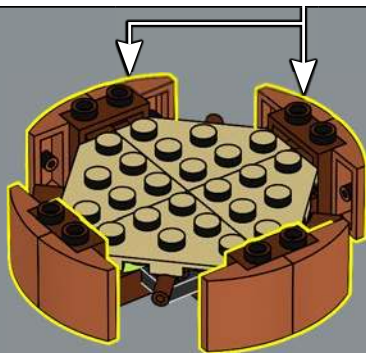
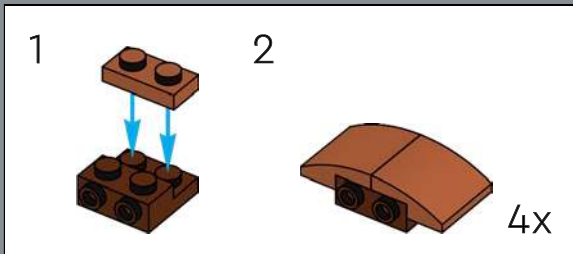

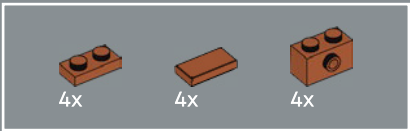

15

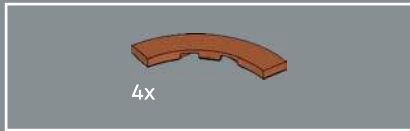
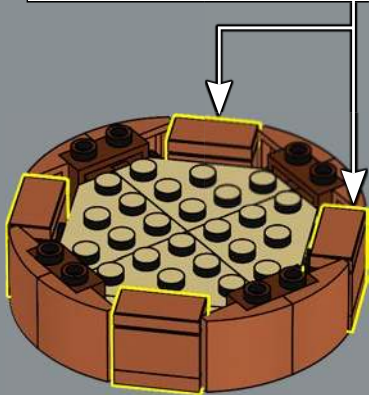
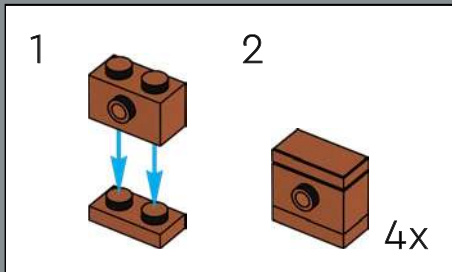

16

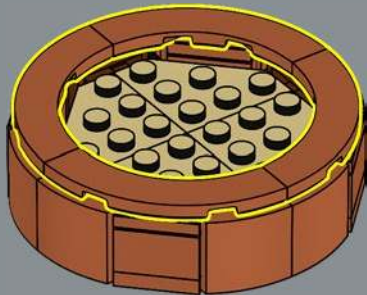

17

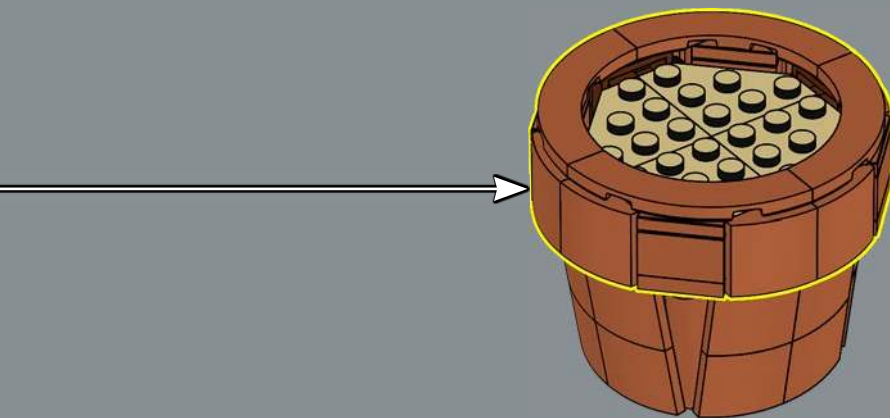

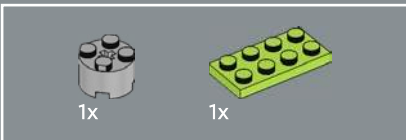
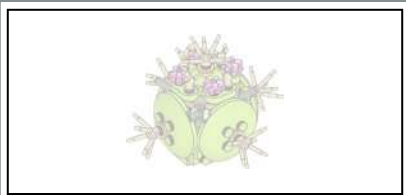

18

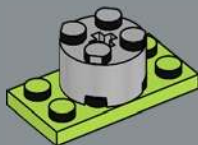

19

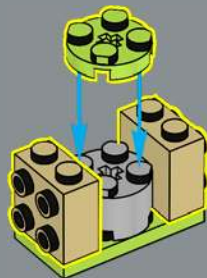



20

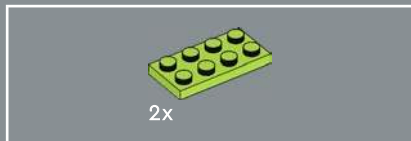
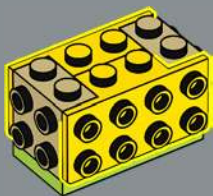

21

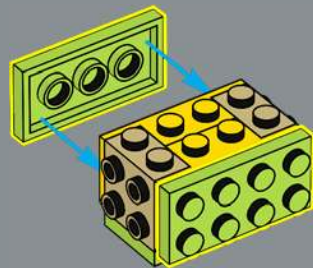



22

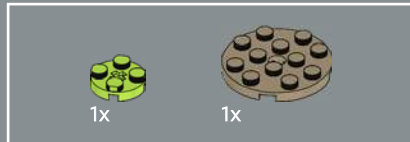
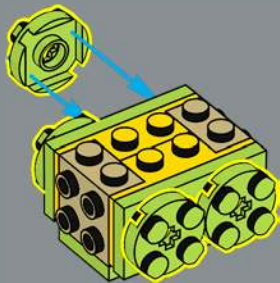

23

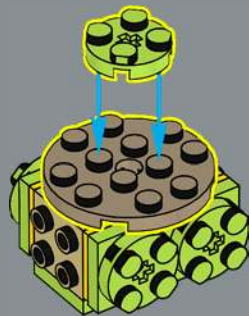



8x

24

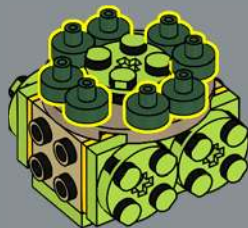



25

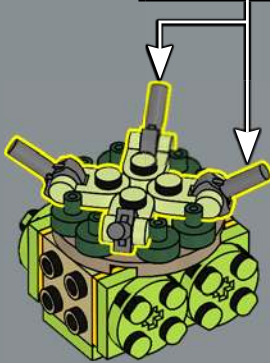
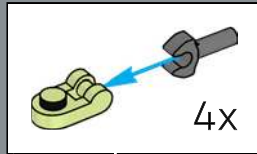

26

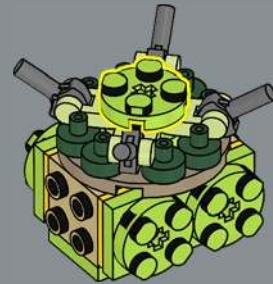

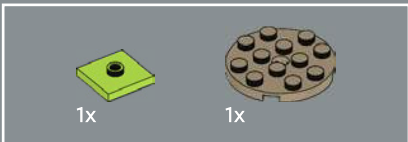

27

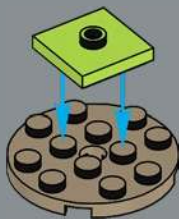

28





1x



4x

29



4x

30





4x

31



4x

32





33



34

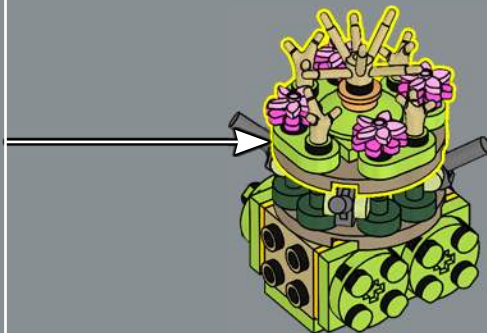

Several species of pincushion cactus grow a lovely crown of flowers in vivid colours.



35

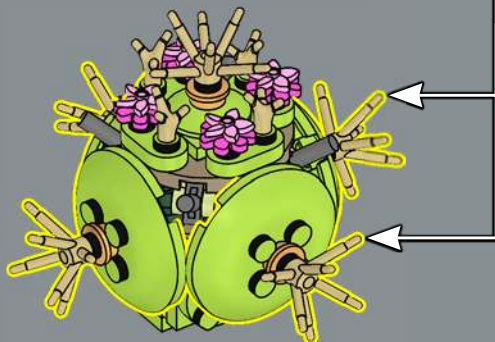
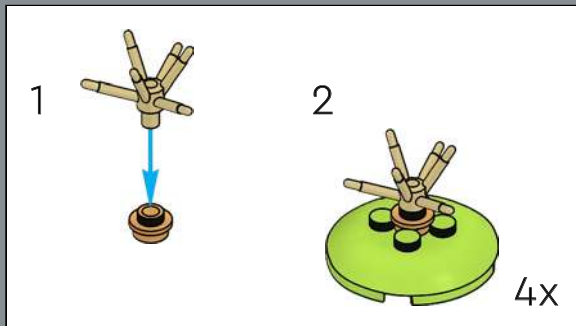

After being catalogued for the first time in the late 1920s, *Mammillaria crinata* f. *zeilmanniana* was largely unknown, until it was rediscovered in 1988 within a specific canyon area in Mexico.

36

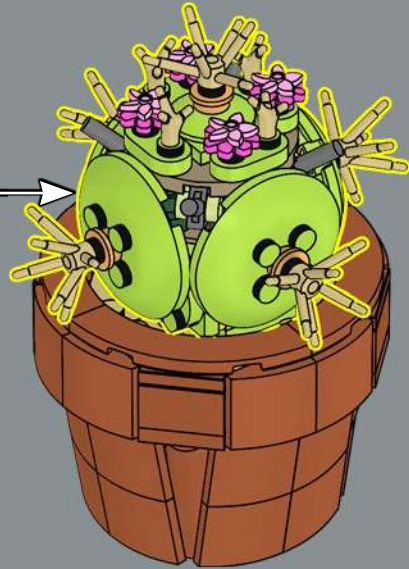



4x



8x



4x



4x

37

1



2



3



4x

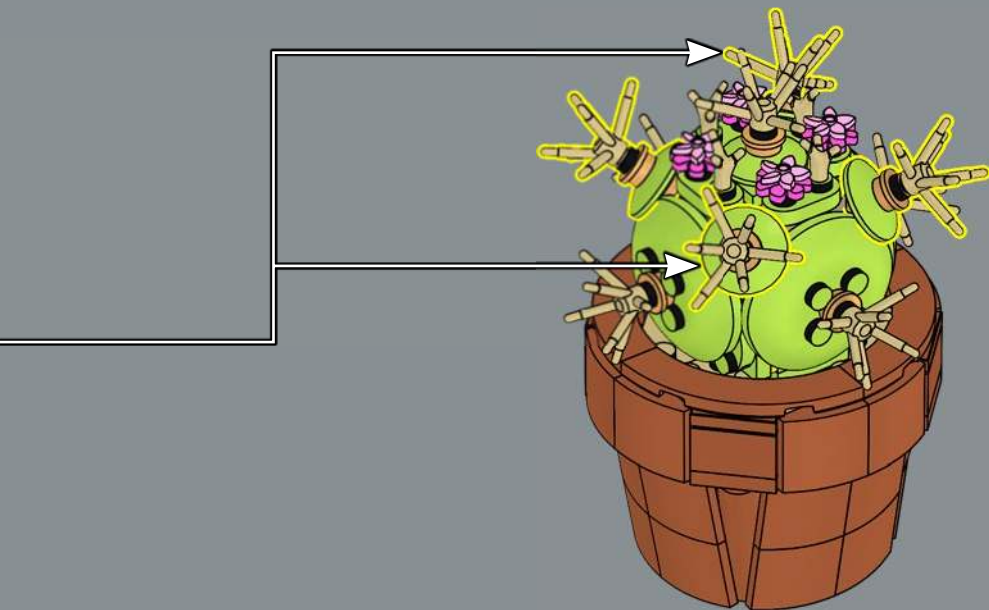



12x  
6439046



3x  
6302268



8x  
6210269



2x  
6468074



6x  
4644456



1x  
6074954



3x  
6009016



12x  
4114309



3x  
4142865



1x  
6170487



3x  
6089119



2x  
6399780



4x  
6324176



1x  
6449709



1x  
6132541



1x  
6168644



3x  
4558957



2x  
302228



13x  
4140562



2x  
6439048



1x  
6102138



1x  
6365630



3x  
4243819



4x  
6451597



2x  
6214334



4x  
6368619



2x  
6135130



2x  
6313592



5x  
6382575



4x  
6328327



10x  
6463564



4x  
6348058



4x  
6370686



2x  
302224



10x  
6210271



4x  
6468078



4x  
4208072



2x  
6400110



2x  
302221



2x  
6118828



2x  
6253140



8x  
6400649



2x  
6138624



2x  
4119479



3x  
6161772



24x  
4570877



12x  
6468067



12x  
4614158



12x  
6228839



96x  
6104344



12x  
6394948



12x  
6439724



12x  
6468066



12x  
6468071



3x  
6462459



6x  
4535928



3x  
6462460



12x  
6468069



4x  
6240030



1x  
6147052

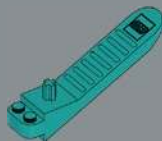

1x  
6254100



6x  
6211875



13x  
6264062



2x  
6190251



4x  
6468391



13x  
6314224



2x  
6438450



5x  
6121816



2x  
6468075



1x  
6056291



4x  
6468077



3x  
4537936



2x  
6143445



13x  
6300322



5x  
6132767

2x  
6092591

4x  
6038637

6x  
6232138

13x  
6190252



8x  
6454462

5x  
6397157

8x  
6392975

6x  
6403175

5x  
6303004

2x  
6357616

3x  
6468072

3x  
6467694

3x  
6223237

8x  
6468343

4x  
6360079

1x  
6448317

1x  
6456642

1x  
4211183

3x  
6133765

20x  
6306775

6x  
6102360

1x  
6349130

36x  
6470170

1x  
6313506

4x  
6075207

1x  
6170468

12x  
6335378

4x  
4211526

12x  
6123809

12x  
6195471

1x  
6420921

4x  
6439040

7x  
6395635

6x  
4210725

3x  
4227398

1x  
6230582

4x  
6206151

4x  
6096990

3x  
6468345

8x  
6426463

6x  
6468346

5x  
6005030

1x  
6251854

4x  
6210460

4x  
6468342

1x  
6275487

4x  
6223506

12x  
6468504

4x  
6468079

 [LEGO.com/service](https://www.LEGO.com/service)



# YOU COULD WIN



## YOU COULD WIN

Your feedback will help shape the future development of this product series.

Visit:

## DU KÖNNTEST GEWINNEN

Dein Feedback trägt zur Weiterentwicklung dieser Produktreihe bei.

Geh auf:

## VOUS POURRIEZ GAGNER

Vos commentaires nous aideront à concevoir les futurs produits de cette gamme.

Visitez :

## POTRESTI VINCERE TU

La tua opinione ci aiuterà a migliorare la creazione futura di questa linea di prodotti.

Visita:

## PUEDES GANAR

Tu opinión contribuirá al futuro de esta serie de productos.

Visita:

## 轻松获奖

您的反馈将有助于我们在今后改进本产品系列。

请访问:

[LEGO.com/productfeedback](https://LEGO.com/productfeedback)

You also have the chance to win a LEGO® set.

Terms and conditions apply.\*

Außerdem hast du die Chance, ein LEGO® Set zu gewinnen.

Es gelten die Teilnahmebedingungen.\*

Vous pourriez également gagner un ensemble LEGO®.

Des conditions s'appliquent.\*

Hai anche la possibilità di vincere un set LEGO®.

Termini e condizioni sono applicabili.\*

También tienes la oportunidad de ganar un set LEGO®.

Aplican términos y condiciones.\*

您还有机会赢取乐高®套装。

条款和条件适用。\*

\*[LEGO.com/productfeedback-terms](https://LEGO.com/productfeedback-terms)

