



Friends

42610



LEGO® Builder



LEGO.com/sustainable-packaging



FR
DONNEZ
OU
RECYCLEZ

 OU  OU 

ASSOCIATION MAGASIN DÉCHÈTERIE

Adresses sur quefairedemesdechets.fr

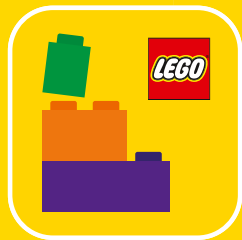

Q LEGO® Builder

BUILDER



Apple and the Apple logo are trademarks of Apple Inc., registered in the U.S. and other countries and regions. App Store is a service mark of Apple Inc. Google Play and the Google Play logo are trademarks of Google LLC. Tencent and the Tencent logo are trademarks of Tencent Inc.

Q LEGO.com/devicecheck

EN Ask parents' permission before going online | DE Eltern um Erlaubnis bitten, bevor du online gehst | FR Demande l'autorisation d'un parent avant d'aller en ligne | IT Chiedi il permesso ai tuoi genitori prima di andare online | ES Pídeles permiso a tus papás antes de conectarte a Internet | PT Pede autorização aos pais antes de acederes online | ZH 上网前应先征得父母的同意 | PL Poproś rodziców o zgodę, zanim wejdiesz do Internetu | CS Než půjdeš na internet, požádej rodiče o svolení | SK Skôr než pôjdeš na internet, vypýtaj si povolenie od rodičov | HU Kérj szülői engedélyt, mielőtt online csatlakoznál! | RO Cere permisiunea părinților înainte de a te conecta online | BG Поискайте разрешение от родител, преди да влезете онлайн | LV Pirms došanās tiešsaistē palūdz atļauju vecākiem | ET Enne Interneti kasutamist küsi vanematelt luba | LT Prieš prisijungdami prie interneto, atsiklauskite tėvų



LIANN

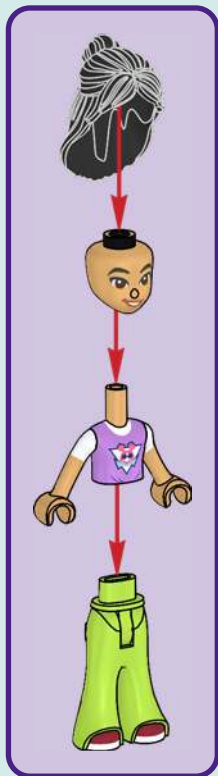

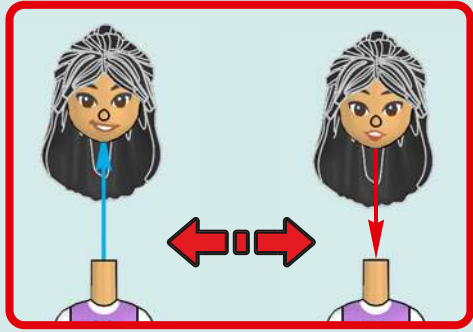
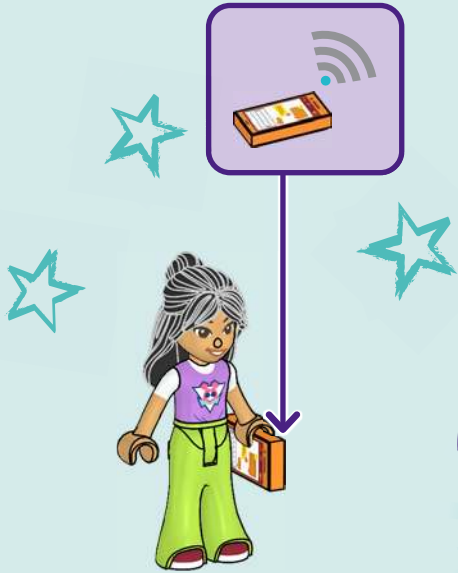

POPCORN



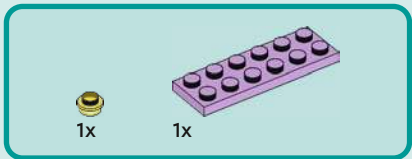
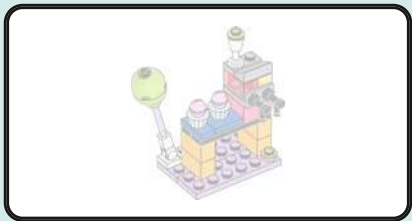

1

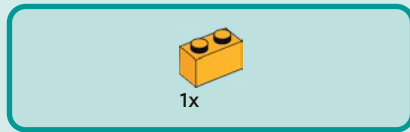
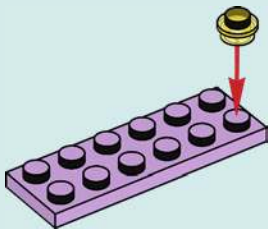

2

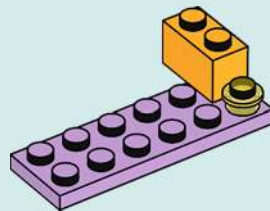



1x

3

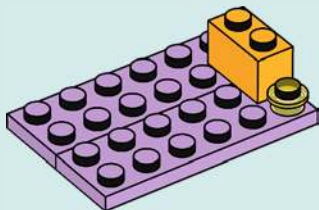

1x

4

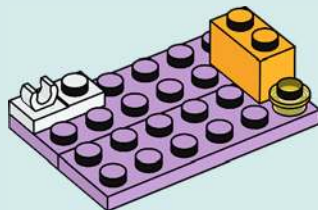



1x

5

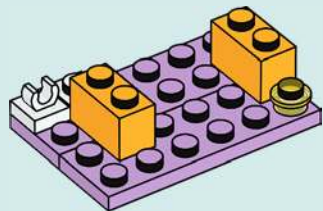

2x

6

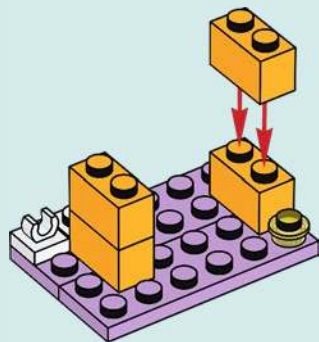



2x

7

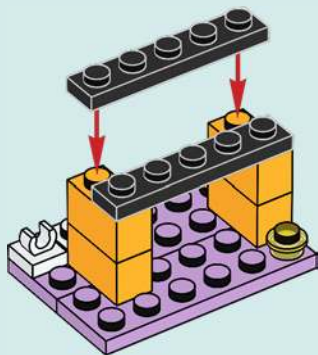

1x



1x



1x

8

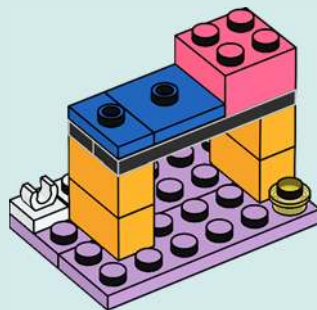



1x



1x

9

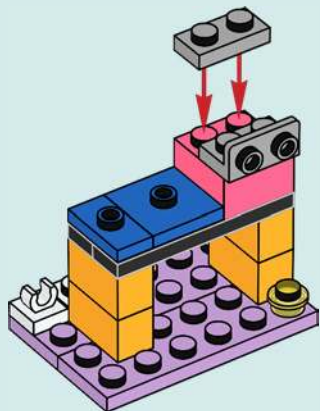

1x



1x

10

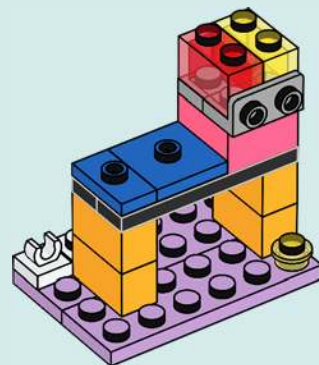



2x

11

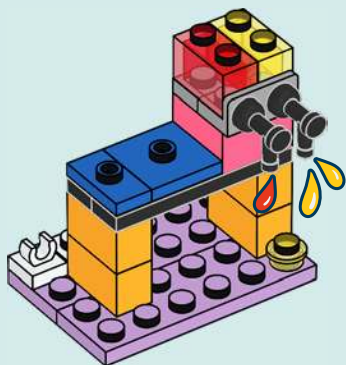

1x



1x

12

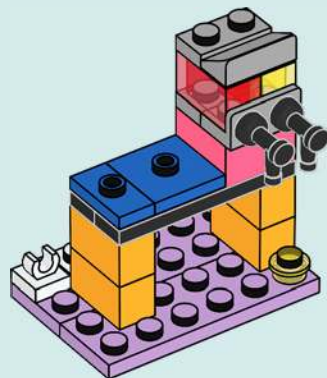



2x



2x

13

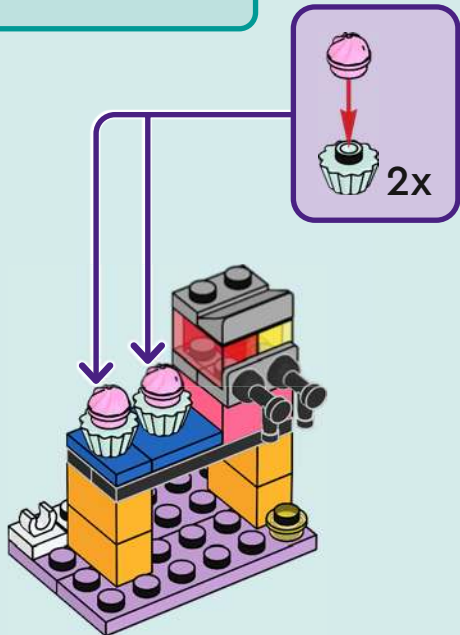

1x



1x

14

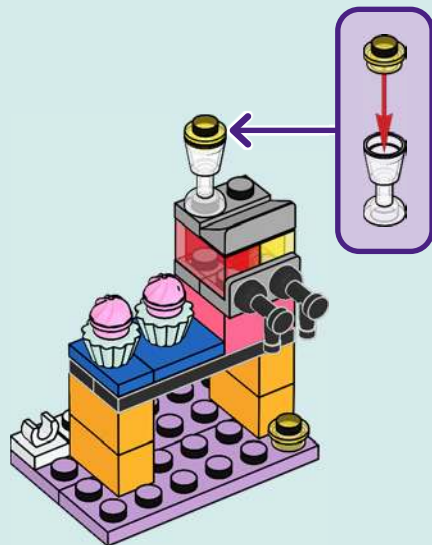

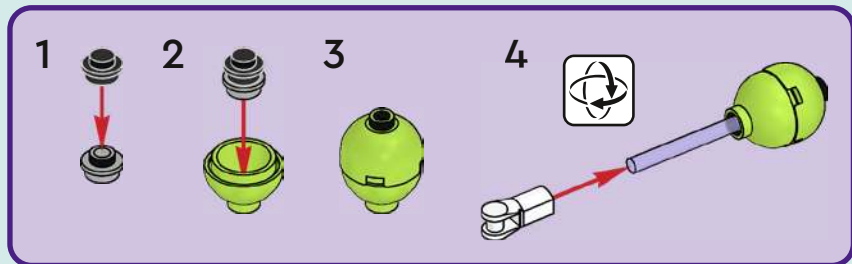
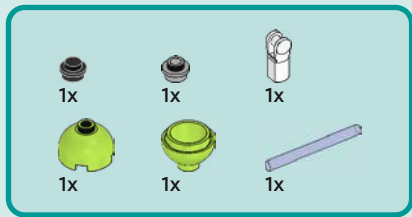

15

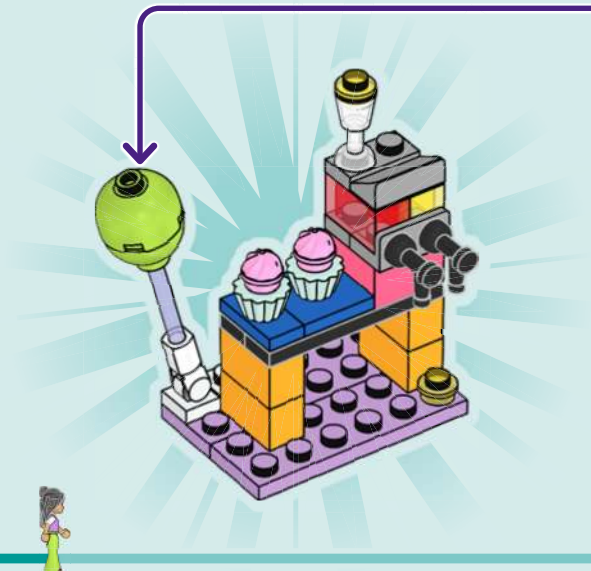

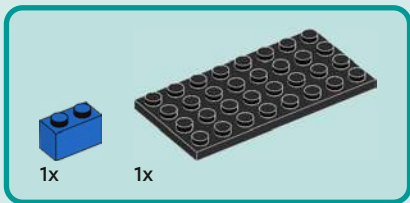
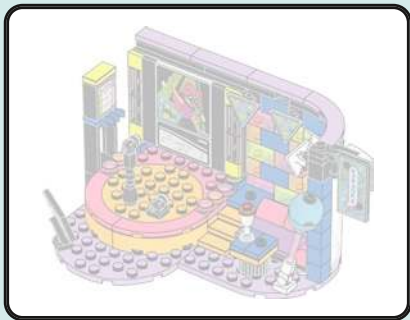

1

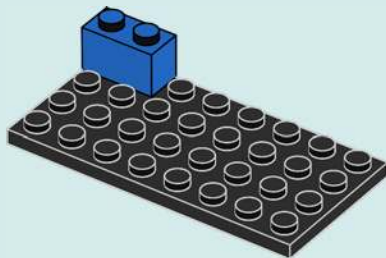



1x



1x

2

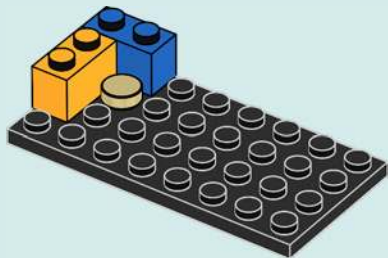

2x



1x



1x

3

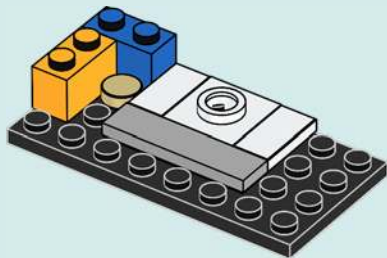

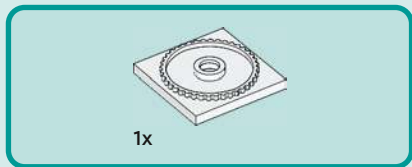

4

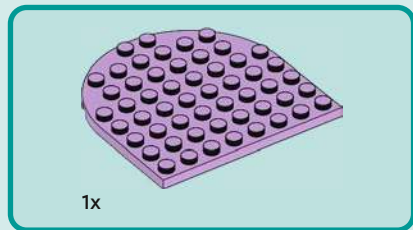
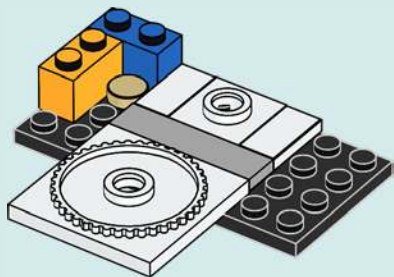

5

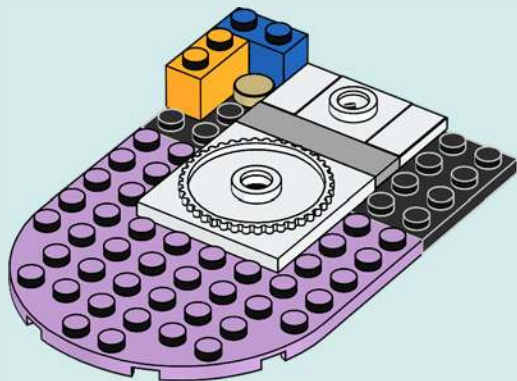

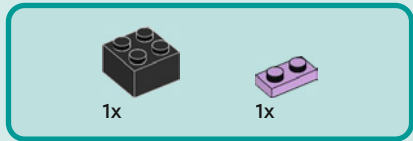

6

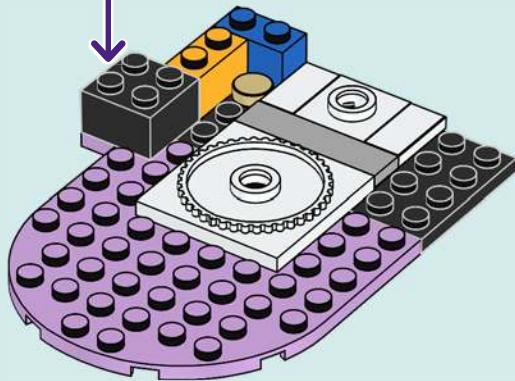
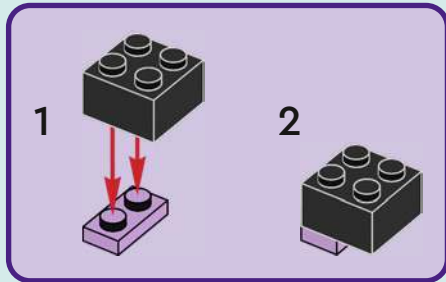

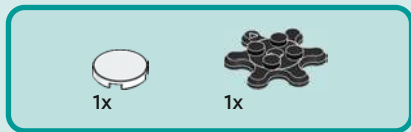

7

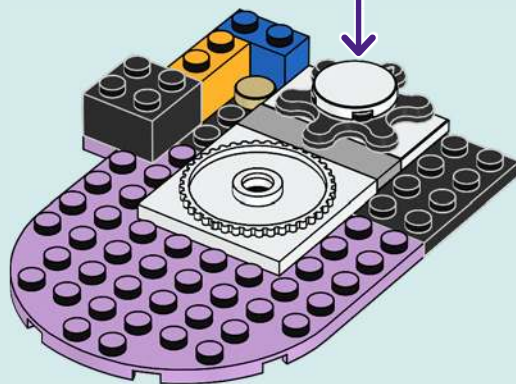
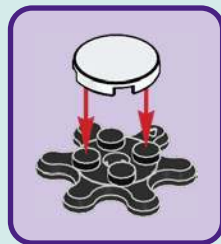

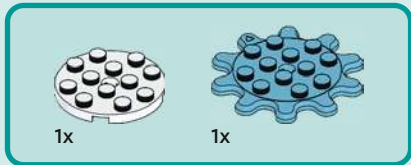

8

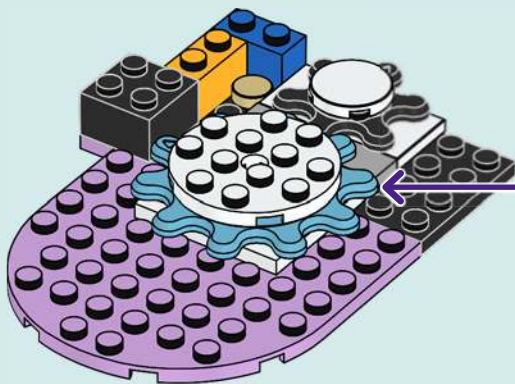
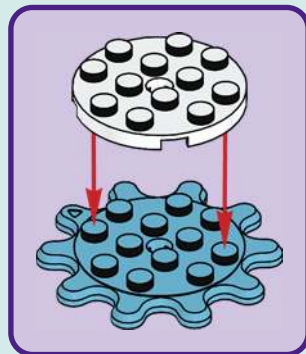

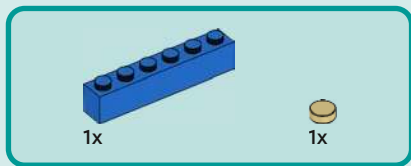

9

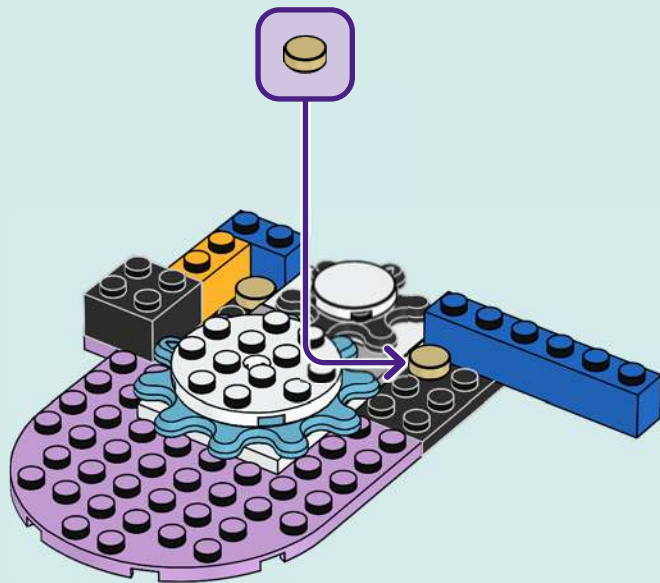

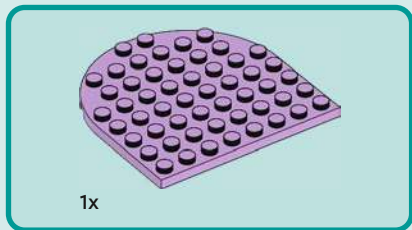

10

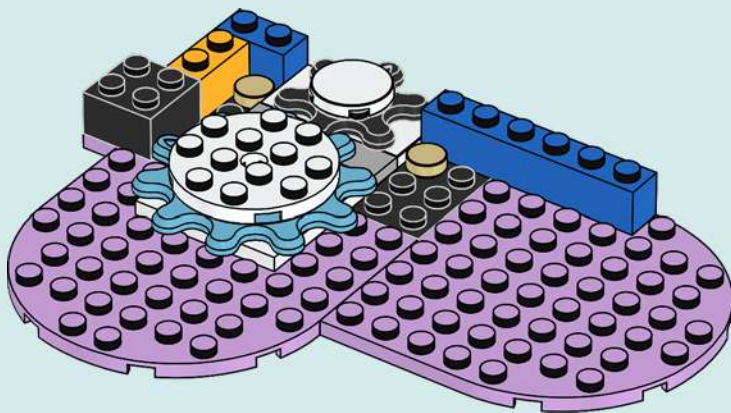



2x

11

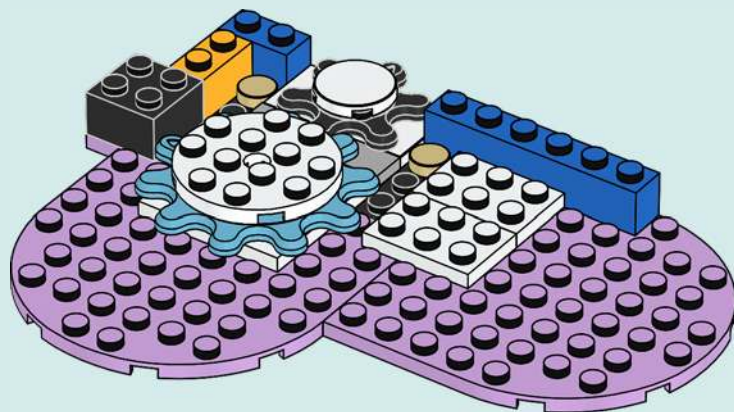



2x

12

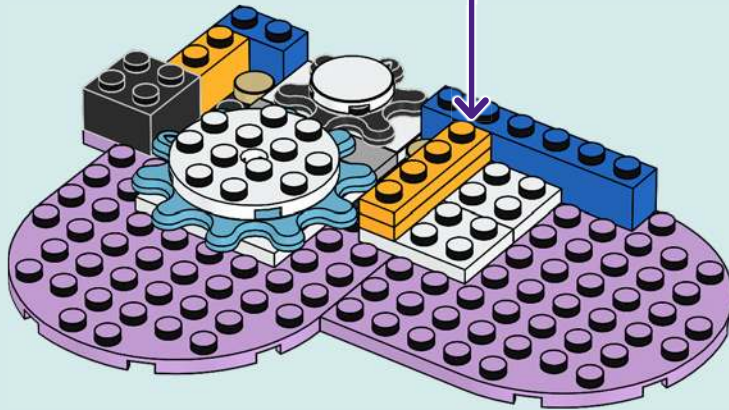
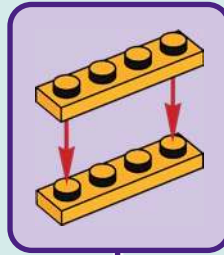



2x



1x

13

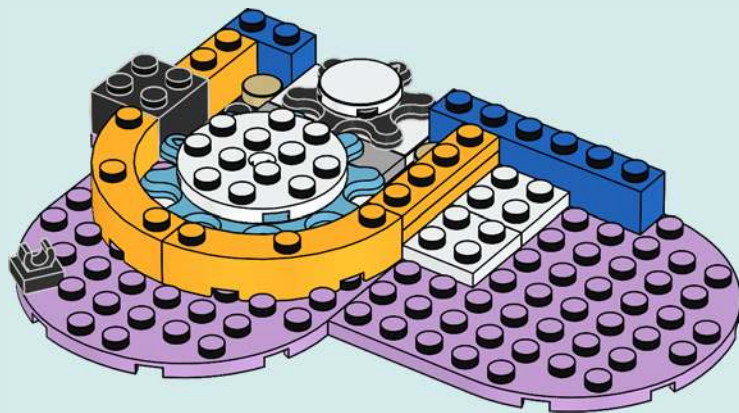



14

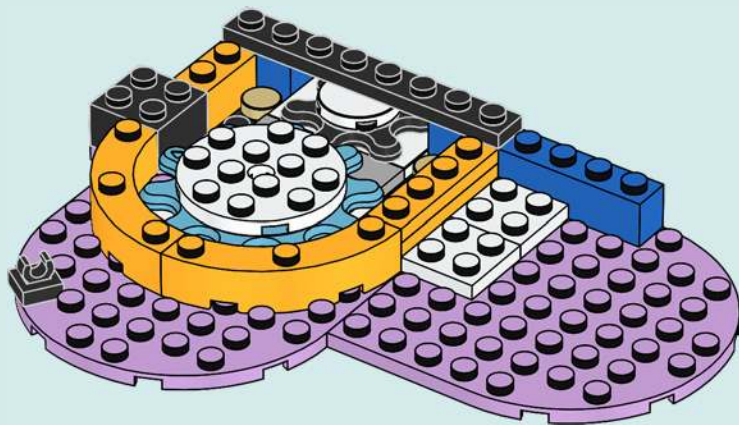



2x

15

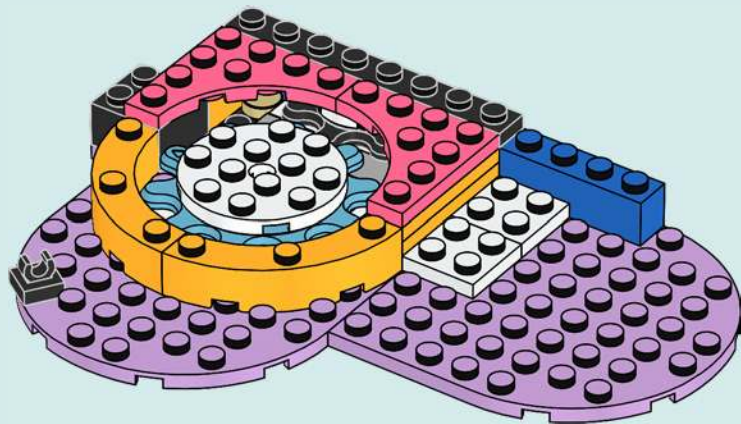

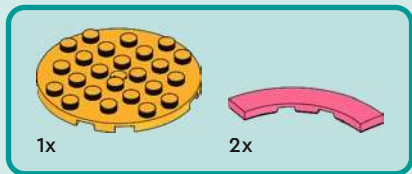

16

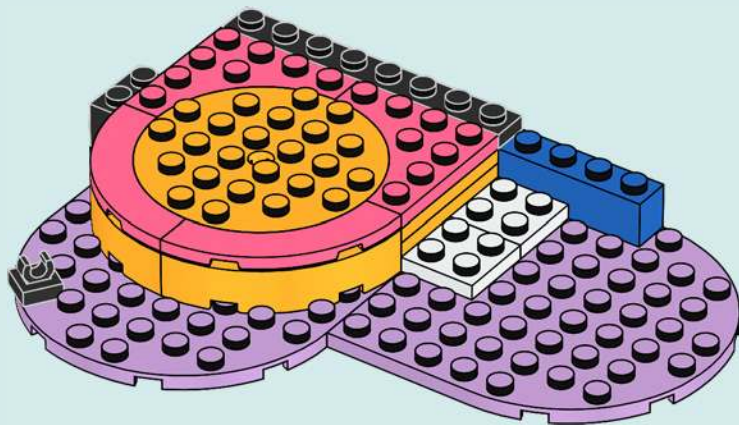



17

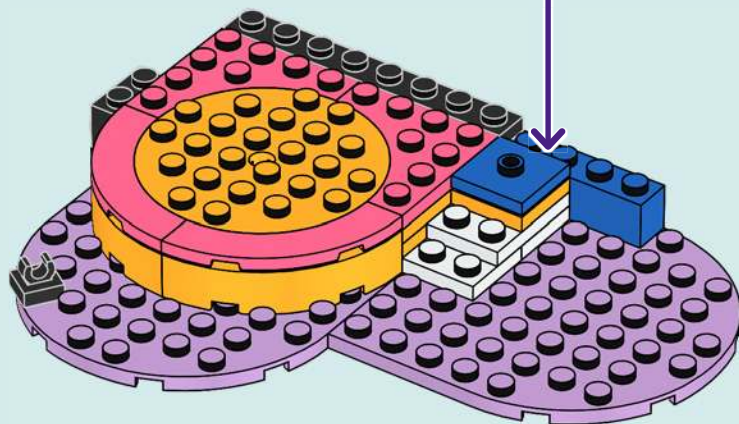
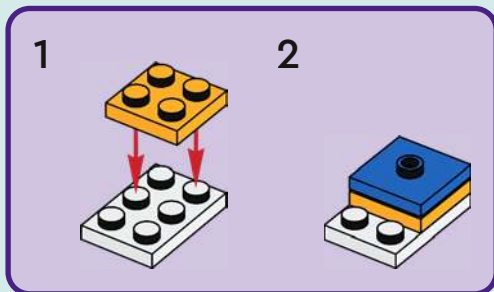



3x

18

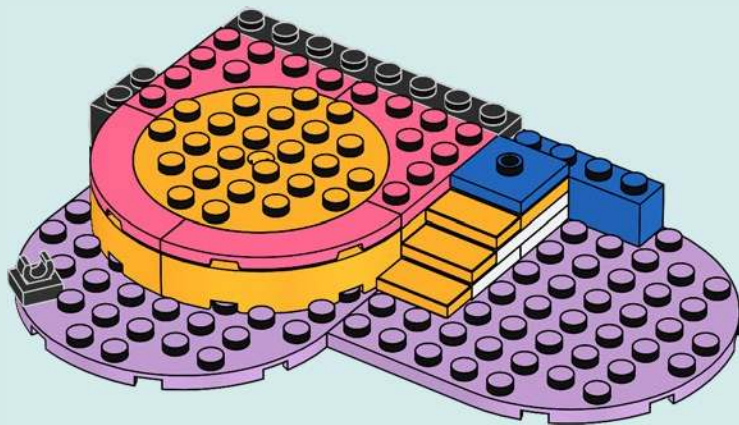

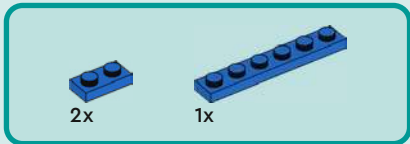

19

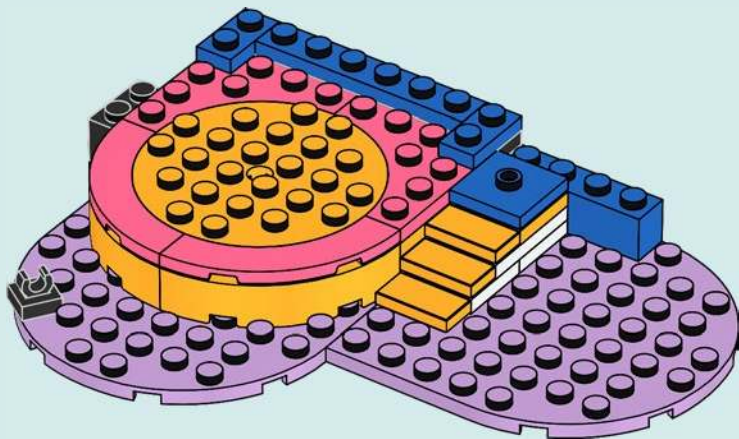



4x



2x

21

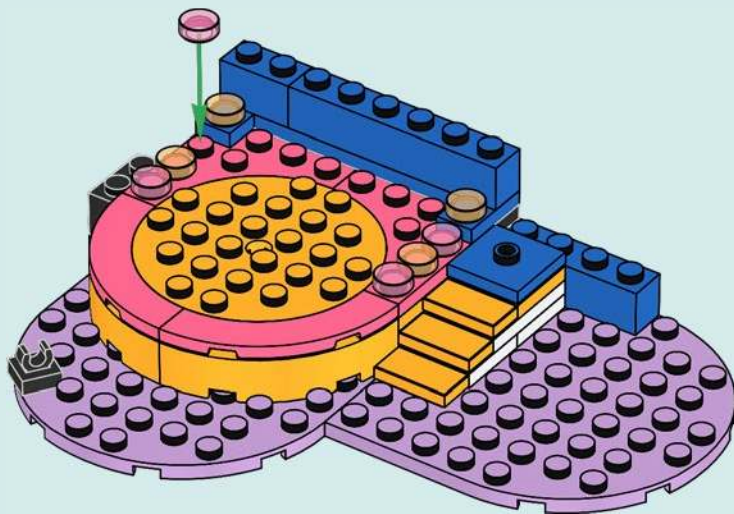



22





2x

23

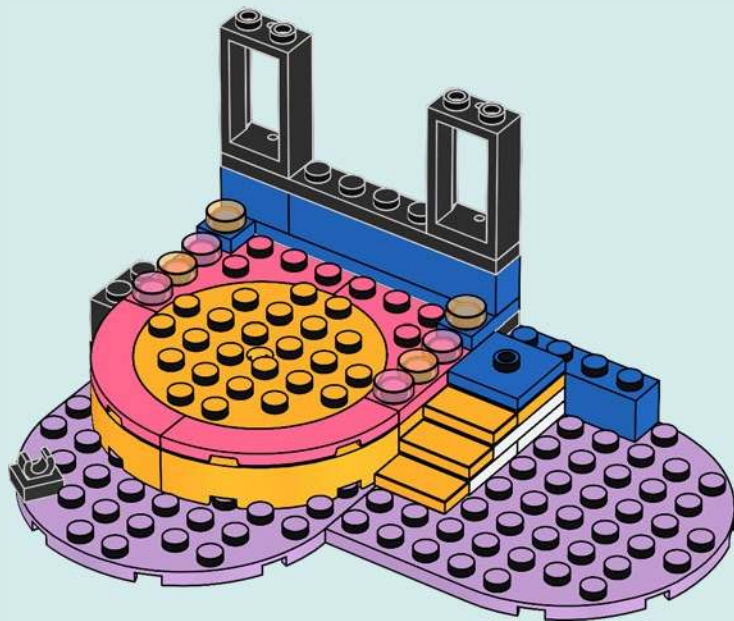

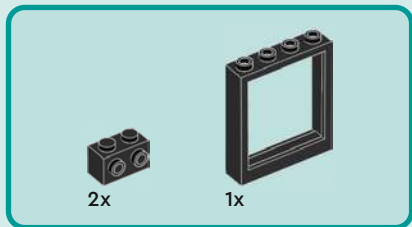

24

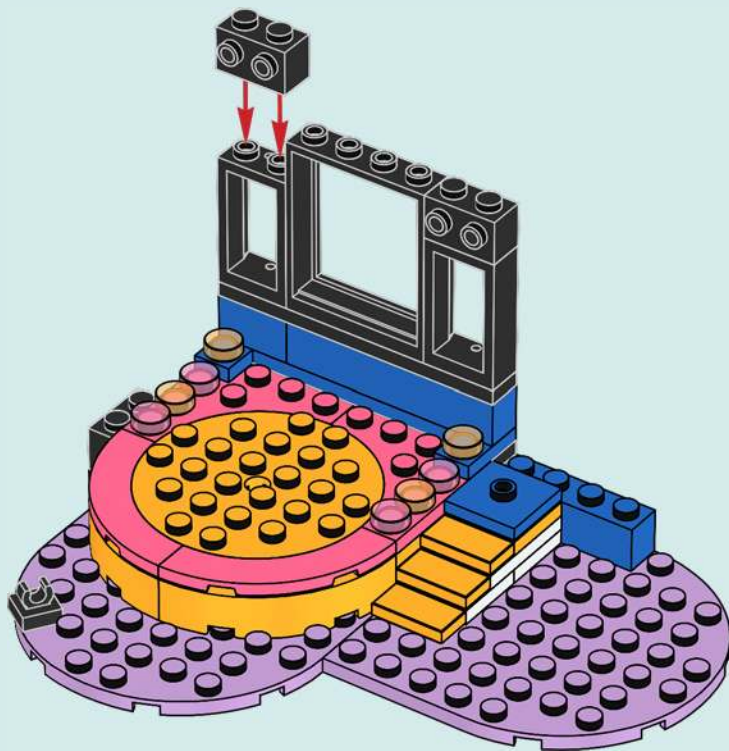



1x



1x

25

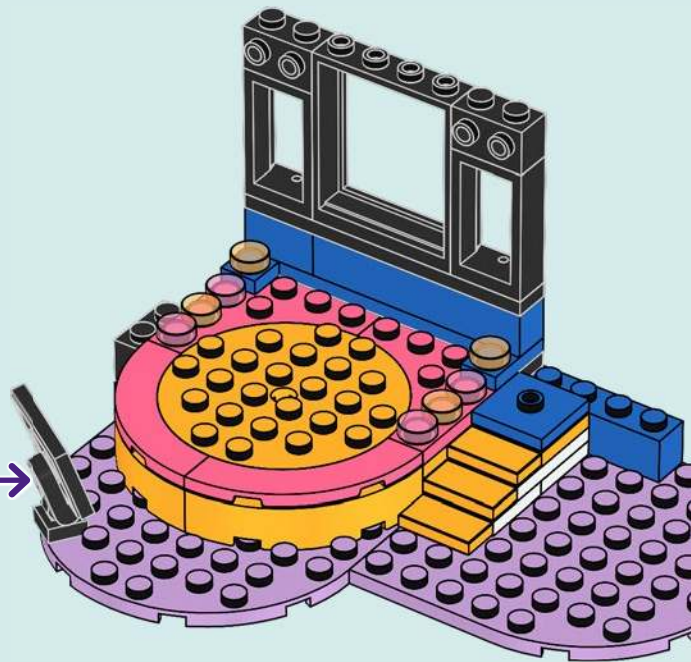
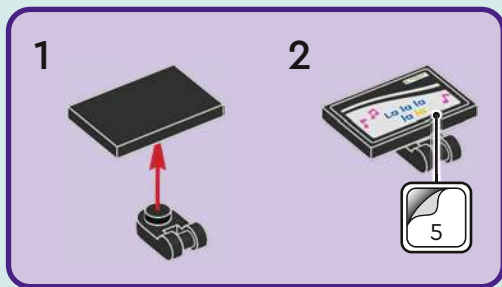

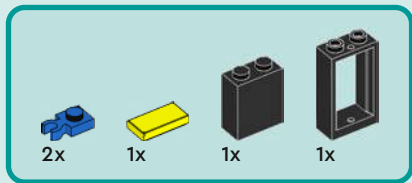

26



1



2

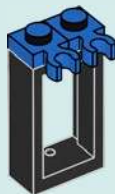

3



4

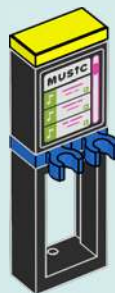

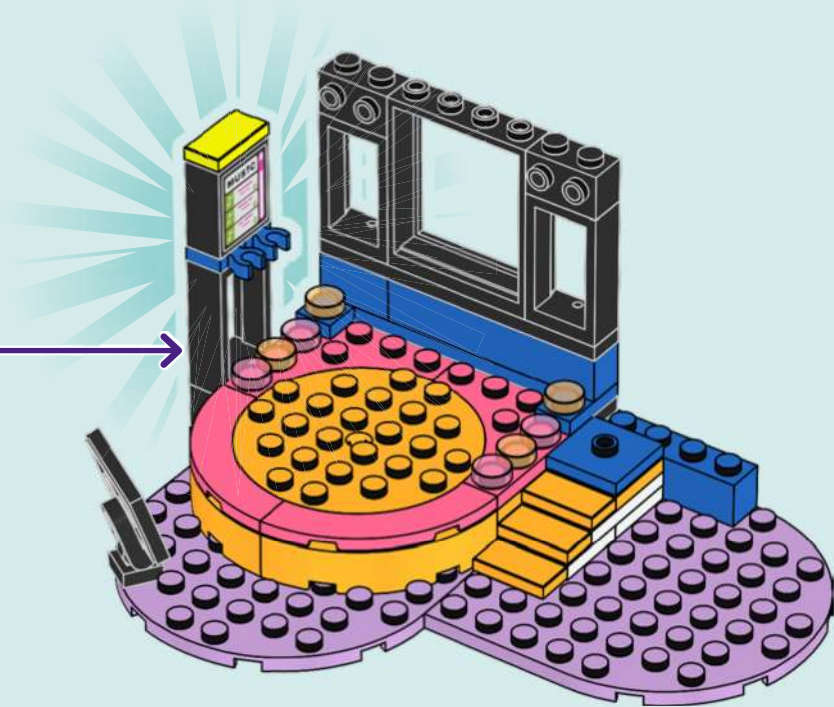



NOVA

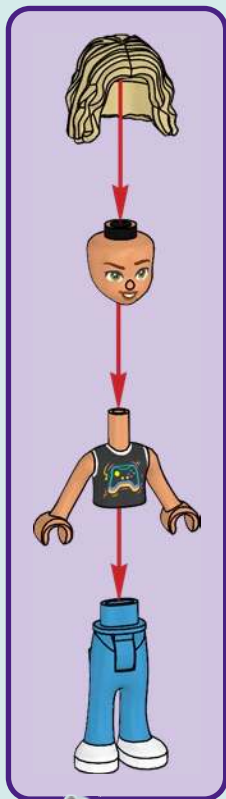

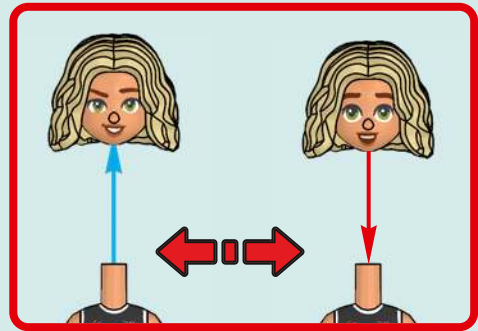



1x



1x



1x



1x



1x

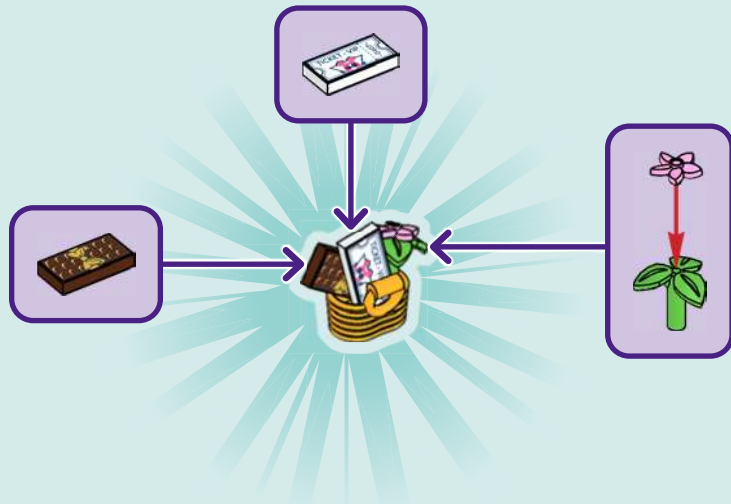



1x



1x

27

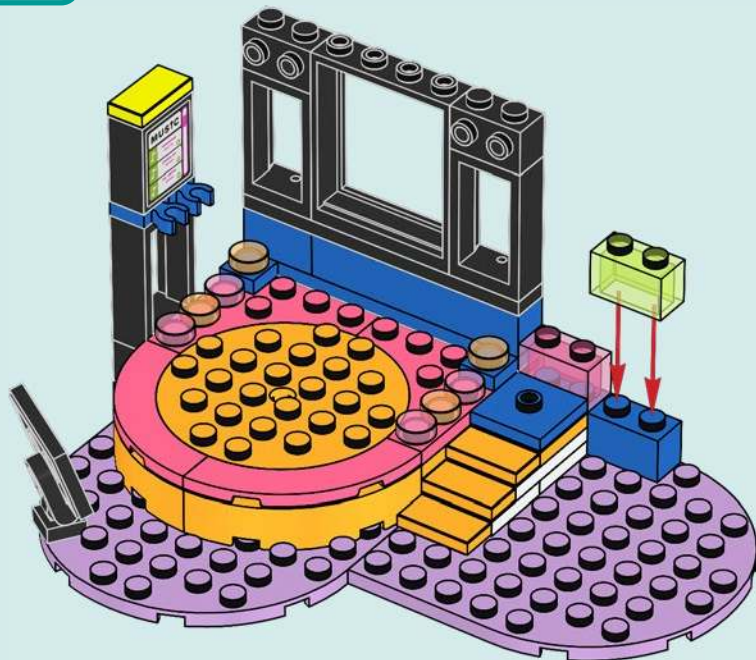



1x



2x

28

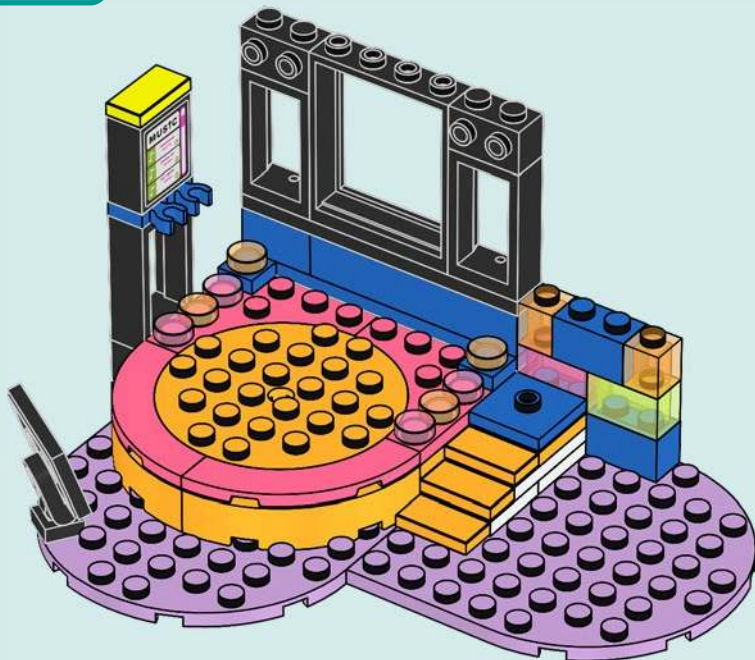



1x



1x

29

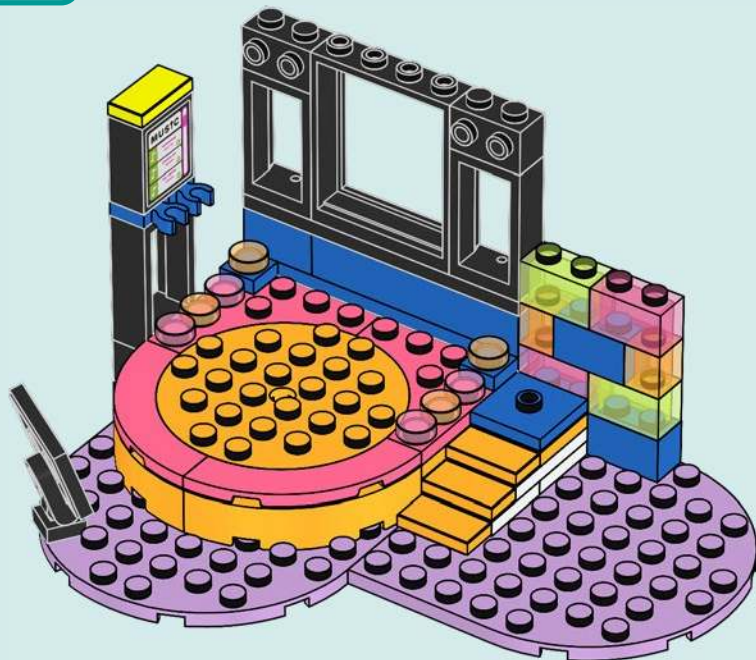



1x



2x

30

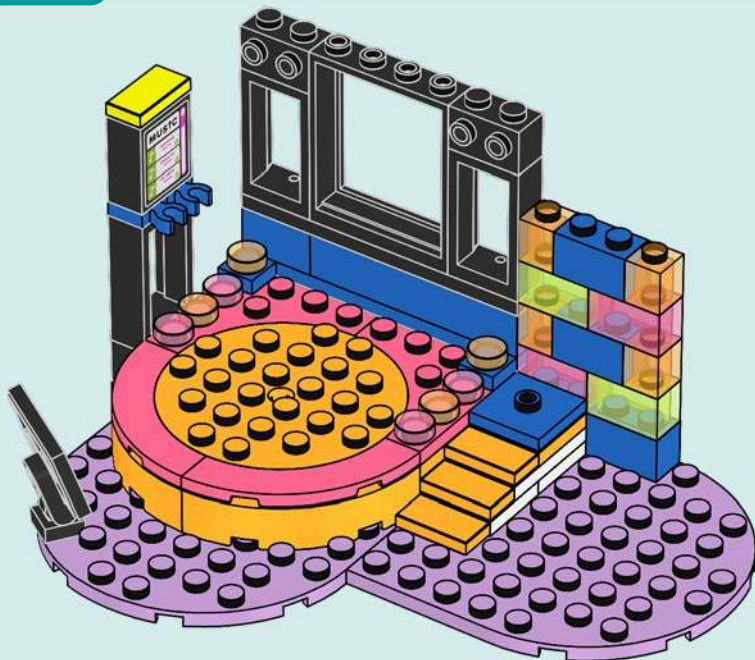



1x



1x

31

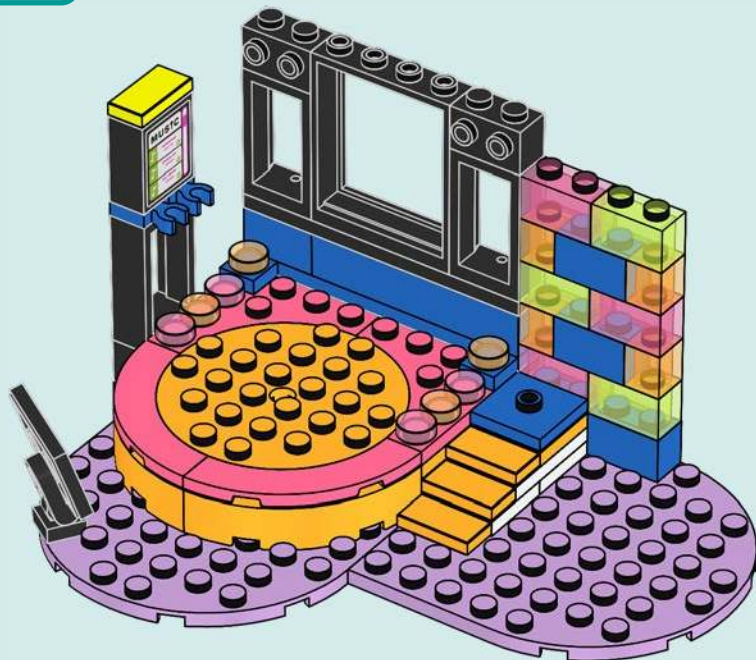

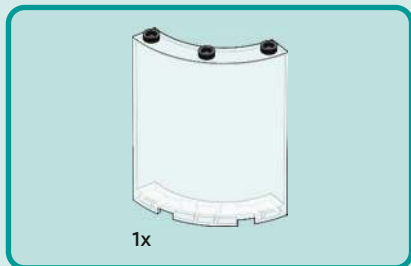

32

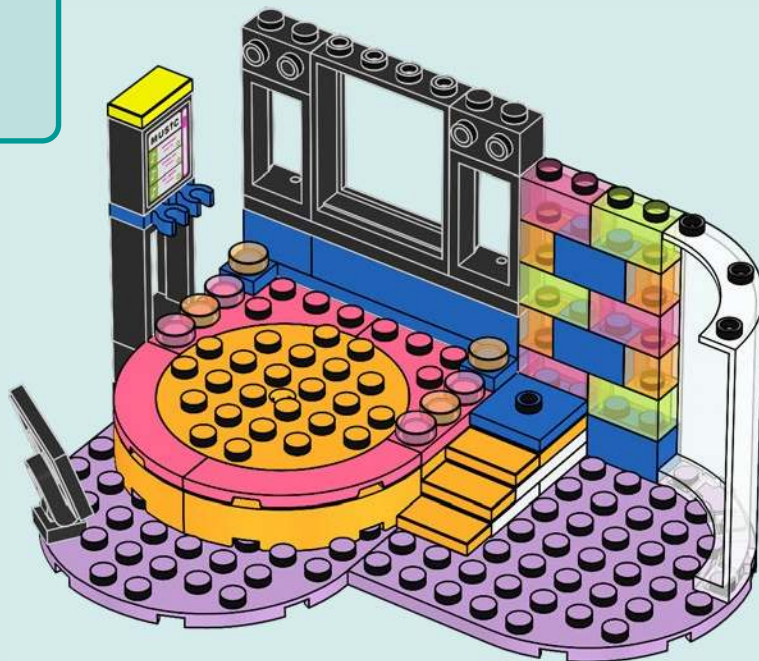

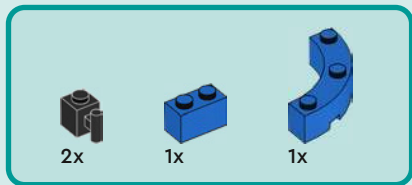

33

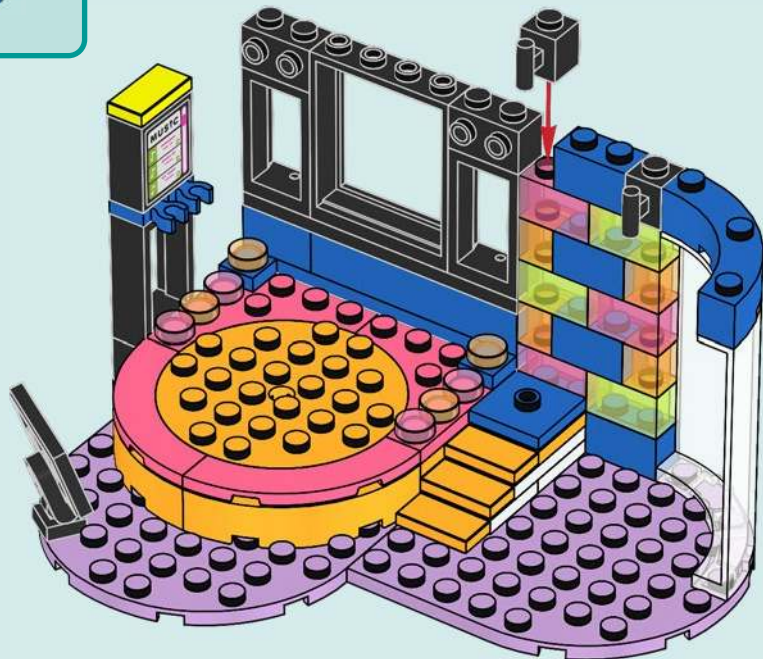



6x



1x

34

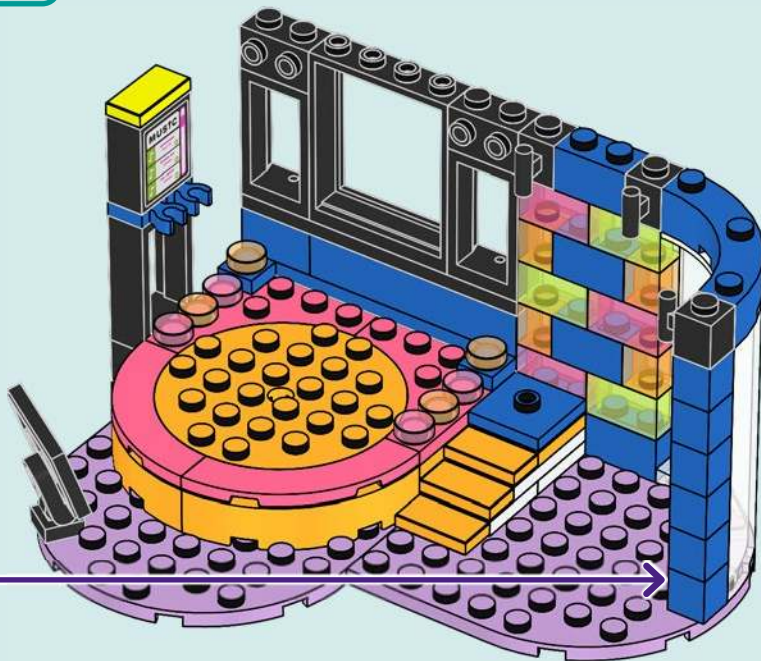
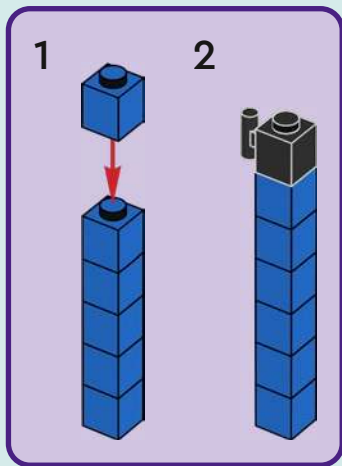

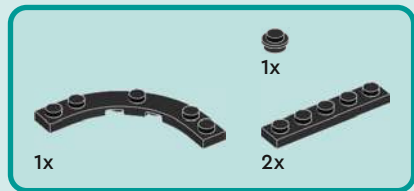

35

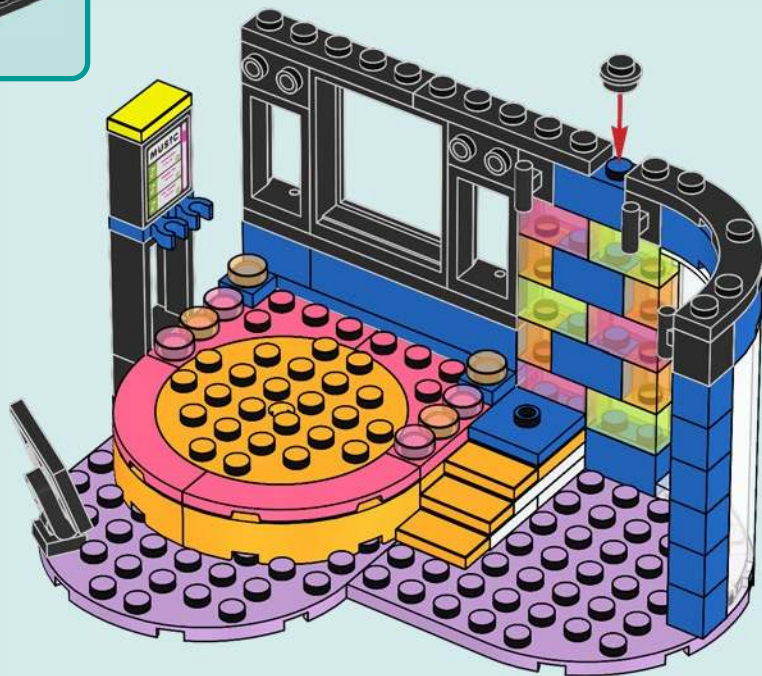

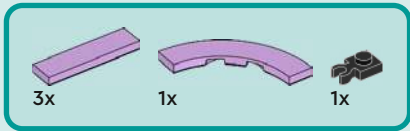

36

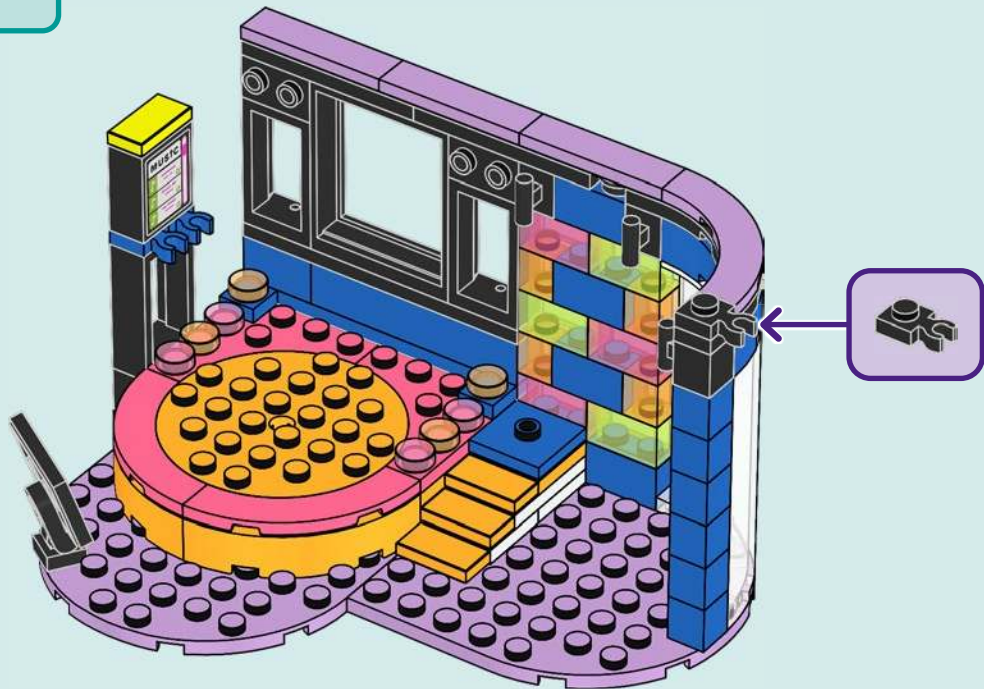

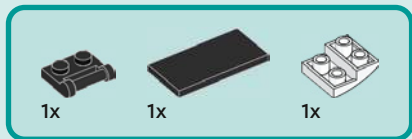

37

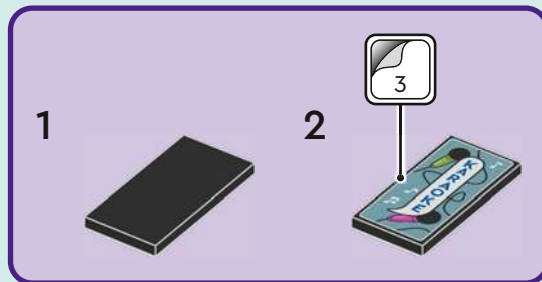
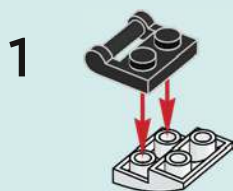

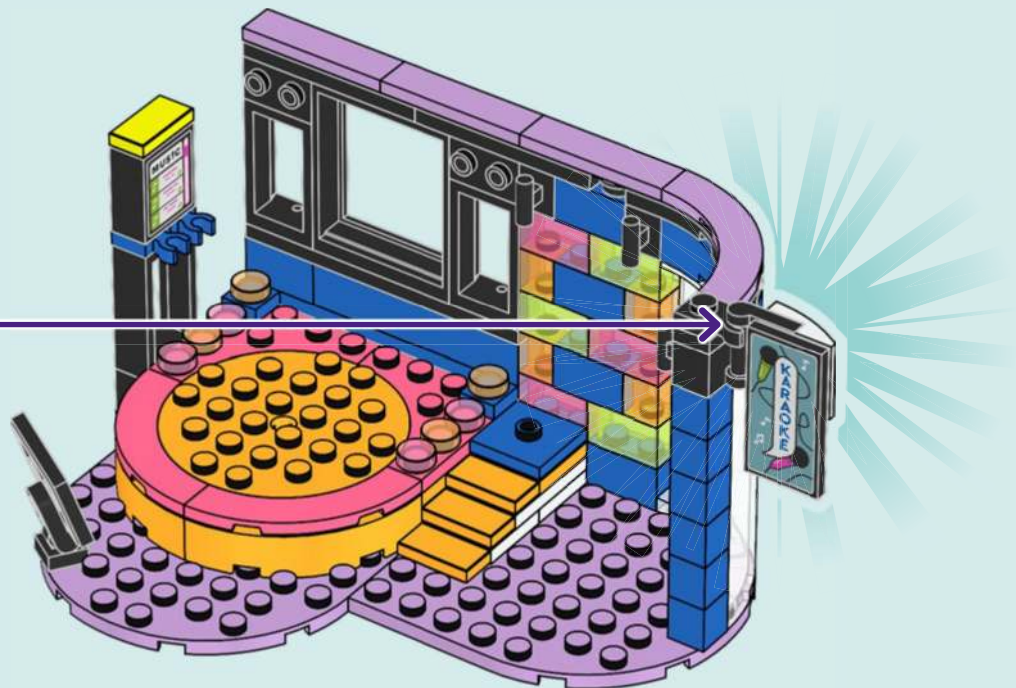



38

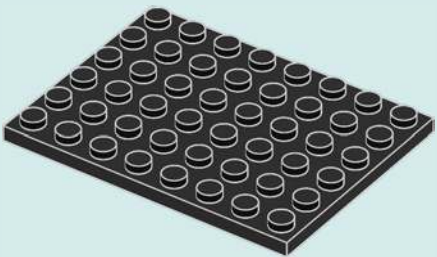



4x



4x

39

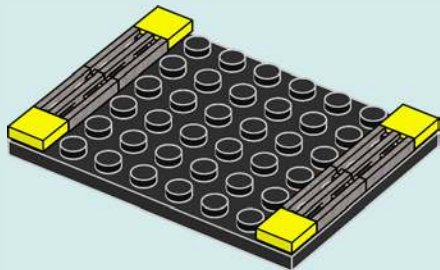

2x

40

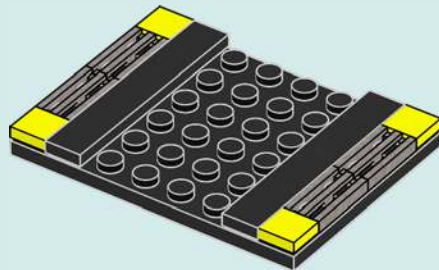

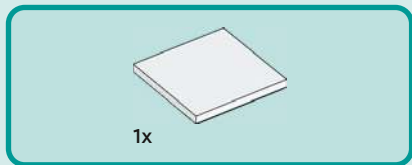

41

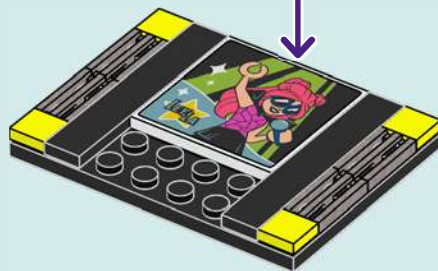
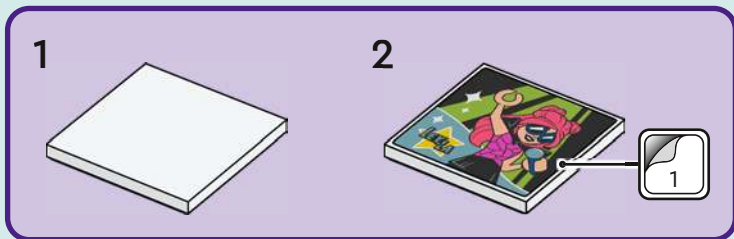

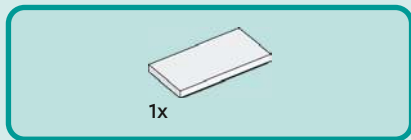

42

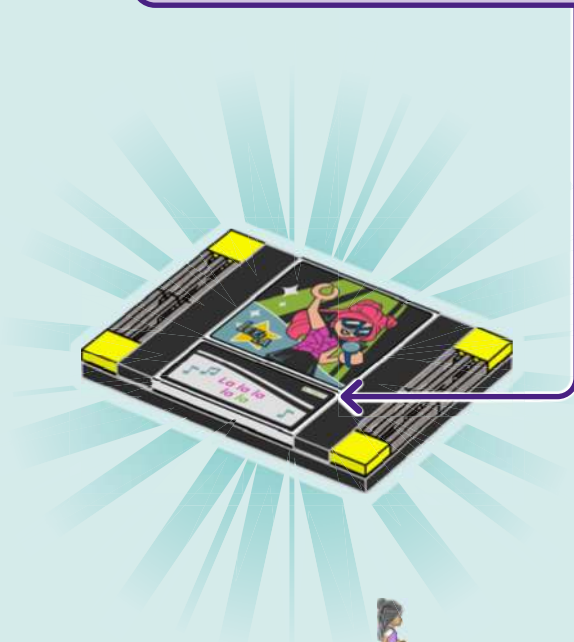
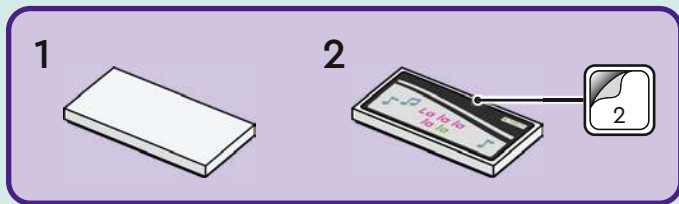

43

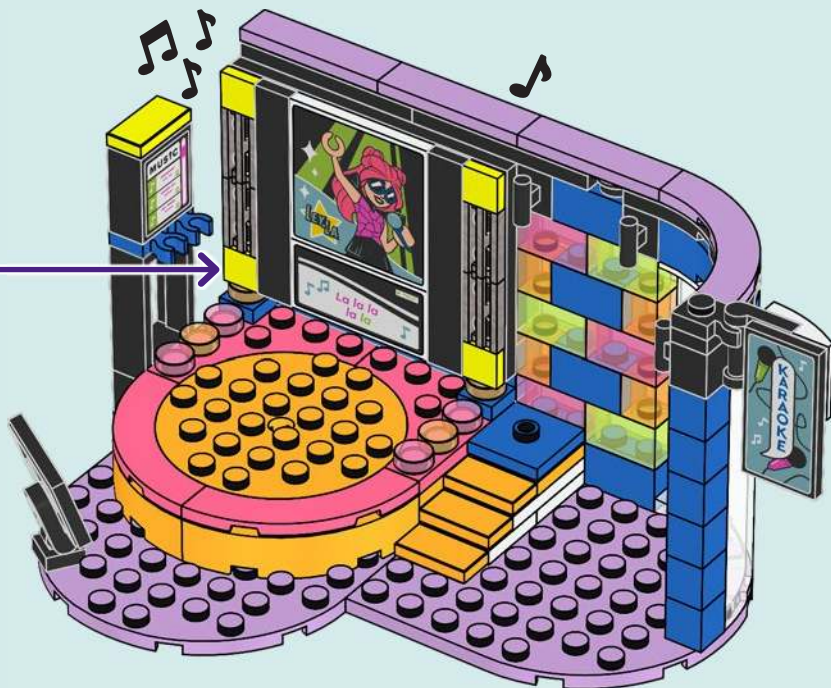



44

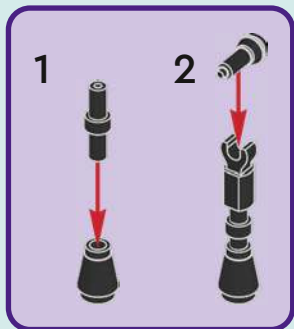



1x



1x

45



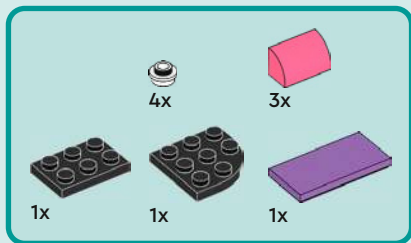

46

1

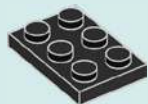

2

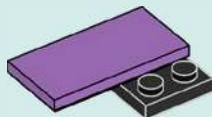

3



4



5

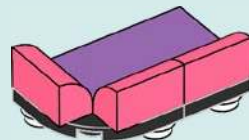





1x

47



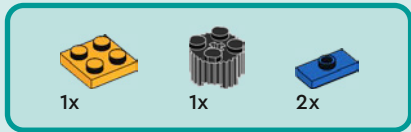

48

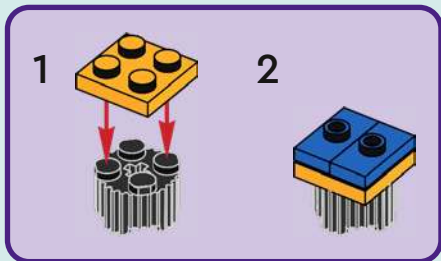



1x



1x

49

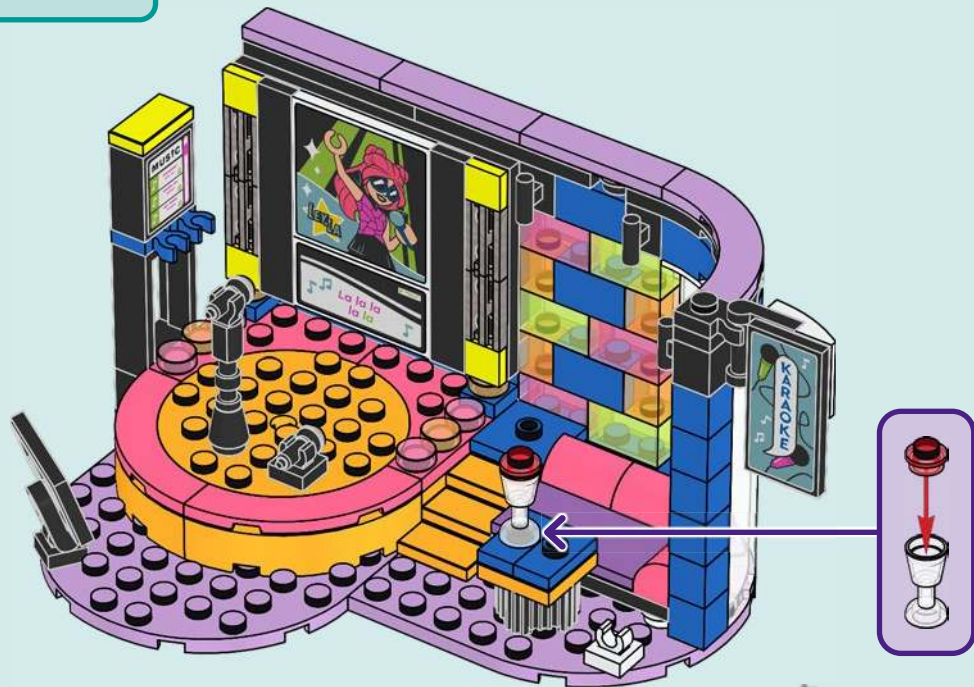

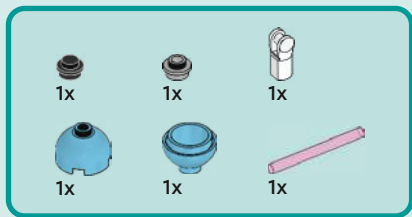

50

1



2



3



4

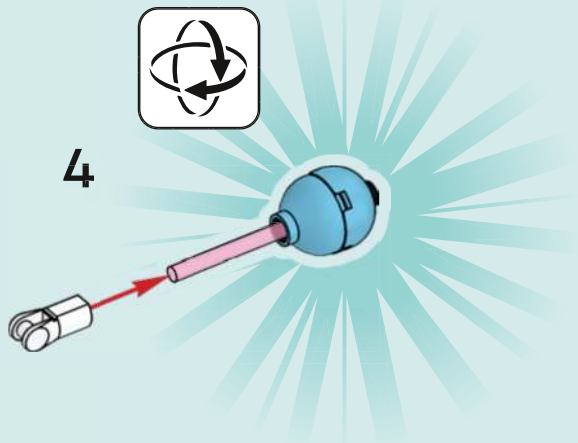





3x

51

1



2



3x

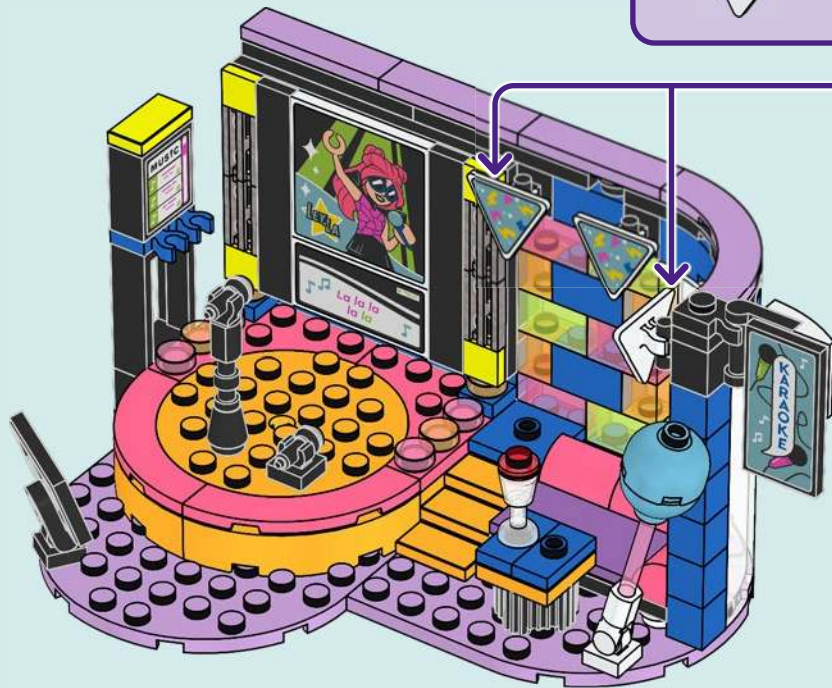

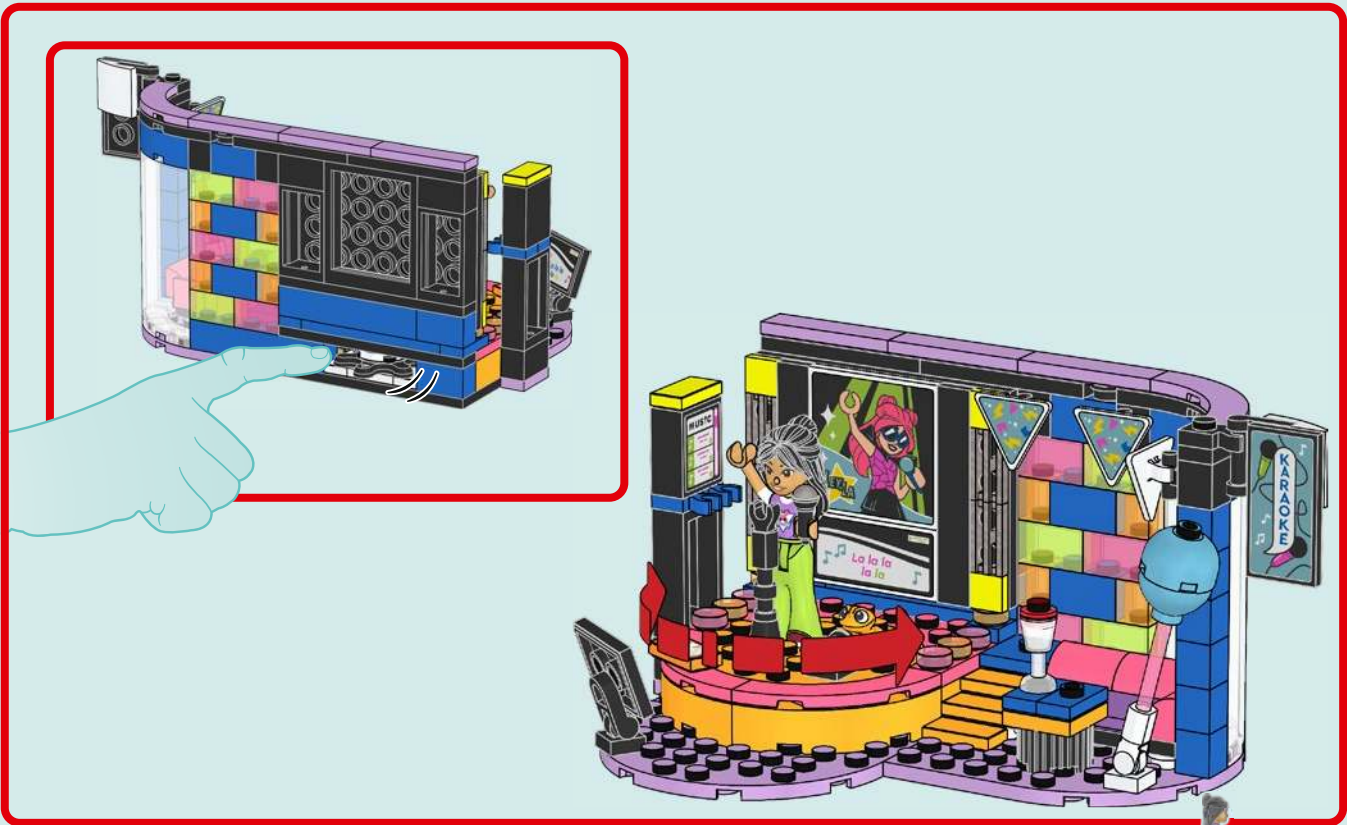





















































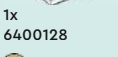



























LEGO Friends

WATCH
SERIES
ONLINE



WATCH SERIES ONLINE / SCHAU DIR DIE SERIE ONLINE AN / REGARDE LA SÉRIE EN LIGNE / GUARDA LA SERIE ONLINE / MIRA LA SERIE EN INTERNET / ASSISTIR À SÉRIE ONLINE / 在线观看 /
OGLADAJ SERIAL W INTERNECIE / SLEDUJ SERIAL ONLINE / POZRI SI SERIAL ONLINE / NÉZD A SOROZATOT ONLINE / VIZIONEAZĂ SERIALUL ONLINE / ГЛЕДАЙТЕ СЕРИАЛА ОНЛАЙН /
SKATIES SĒRIĀLU TIĒŠSAISTĒ / VAATA SARJA VEEBIST / ŽIŪRĒK SĒRIALĀ INTERNETU



| | | | | | | | |
|--|--|--|--|--|--|--|--|
|  2x 6322489 |  3x 302101 |  1x 6429738 |  1x 366623 |  1x 6024730 |  1x 6162892 |  2x 346026 |  1x 6244905 |
|  4x 6168642 |  1x 4515347 |  6x 300523 |  2x 6327722 |  1x 6409763 |  1x 302126 |  1x 303526 |  2x 6240216 |
|  1x 6348055 |  1x 4560178 |  2x 6352221 |  1x 6315887 |  2x 6138173 |  1x 6306064 |  1x 303626 |  1x 6244907 |
|  3x 6317569 |  1x 4611927 |  3x 6092582 |  3x 614126 |  3x 6468344 |  1x 6254519 |  1x 303626 |  1x 6329699 |
|  1x 6044691 |  1x 4611927 |  5x 300423 |  1x 4529236 |  2x 459926 |  1x 4560182 |  1x 6235080 |  4x 6274745 |
|  1x 6347309 |  1x 6400128 |  2x 302323 |  2x 459926 |  1x 4618852 |  1x 4560182 |  2x 6166107 |  3x 6244913 |
|  2x 306901 |  2x 6284573 |  1x 6469255 |  2x 6335388 |  1x 4225201 |  4x 6350415 |  1x 6236111 |  1x 6291400 |
|  1x 6466347 |  1x 6409761 |  2x 6126049 |  3x 6170566 |  1x 4225201 |  2x 663626 |  1x 6236111 |  1x 6466199 |
|  1x 6238334 |  1x 6416619 |  2x 6126049 |  1x 6157554 |  1x 300326 |  2x 663626 |  1x 6236111 |  1x 6214557 |
|  1x 6210385 |  1x 6466332 |  2x 300923 |  1x 6371584 |  1x 4227392 |  1x 6372045 |  1x 6208450 |  1x 6429057 |

1x
6170191

4x
6274747

4x
6240550

1x
6096091

5x
6003003

3x
4622062

1x
6416784

2x
6310615

2x
6003033

2x
6020073

1x
6131694

1x
6139435

2x
6168647

1x
4568637

2x
4211398

1x
6004990

1x
4211356

2x
6424008

1x
6096990

3x
6244911

1x
6430979

1x
6132411

1x
6429058

1x
6238331

2x
6361352

1x
4651902

1x
6099190

3x
6101169

1x
6391756

2x
6334047

2x
6273856

4x
6051422

3x
6261293

1x
6422920

2x
6400075

2x
6458179

4x
6376232

1x
6392235

1x
6416546

1x
6466195

1x
6471316

 [LEGO.com/service](https://www.LEGO.com/service)



YOU COULD
WIN



Scan this QR code or go to
LEGO.COM/PRODUCTFEEDBACK and give
us your short feedback about this LEGO® set
for a chance to win a cool LEGO prize.

Terms and Conditions apply*

EN: YOU COULD WIN. Terms and Conditions apply* **DE: Du könntest GEWINNEN.** Es gelten die Teilnahmebedingungen* **FR: Tu pourrais GAGNER.** Des conditions s'appliquent* **IT: Potresti VINCERE tu.** Termini e condizioni sono applicabili* **ES: Puedes GANAR.** Aplican términos y condiciones* **PT: Poderá GANHAR.** Aplicam-se termos e condições* **ZH: 轻松获奖. 条款和条件适用*** **PL: Szansa na WYGRANĄ.** Obowiązują warunki korzystania* **CS: Máte šanci VYHRÁT.** Platí všeobecné smluvní podmínky* **SK: Máte šancu VYHRAŤ.** Platia všeobecné zmluvné podmienky* **HU: TE IS NYERHETSZ.** Felhasználási feltételek érvényesek* **RO: Ai putea CÂȘTIGA.** Se aplică termenii și condiții* **BG: Можете да СПЕЧЕЛИТЕ.** Има определени правила и условия* **LV: Tu vari LAIMĒT.** Ir spēkā noteikumi un nosacījumi.* **ET: Sul on võimalus VÕITA.** Kehtivad tingimused* **LT: Jūs galite LAIMĖTI.** Taikomos sąlygos*

*[LEGO.com/productfeedback-terms](https://www.lego.com/productfeedback/terms)

LEGO, the LEGO logo and the FRIENDS logo are trademarks of the LEGO Group.

©2024 The LEGO Group.

6493314