



SONIC™

THE HEDGEHOG

76995





LEGO® Builder



[LEGO.com/sustainable-packaging](https://www.lego.com/sustainable-packaging)



FR
DONNEZ
OU
RECYCLEZ

 OU  OU 

ASSOCIATION MAGASIN DÉCHÈTERIE

Adresses sur [quefairedemesdechets.fr](https://www.quefairedemesdechets.fr)

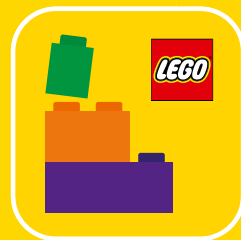

BUILDER



Apple and the Apple logo are trademarks of Apple Inc., registered in the U.S. and other countries and regions. App Store is a service mark of Apple Inc. Google Play and the Google Play logo are trademarks of Google LLC. Tencent and the Tencent logo are trademarks of Tencent Inc.

Q [LEGO.com/devicecheck](https://www.lego.com/devicecheck)

EN Ask parents' permission before going online | **DE** Eltern um Erlaubnis bitten, bevor du online gehst | **FR** Demande l'autorisation d'un parent avant d'aller en ligne | **IT** Chiedi il permesso ai tuoi genitori prima di andare online | **ES** Pídeles permiso a tus papás antes de conectarte a Internet | **PT** Pede autorização aos pais antes de acederes online | **ZH** 上网前应先征得父母的同意 | **PL** Poproś rodziców o zgodę, zanim wejdiesz do Internetu | **CS** Než půjdeš na internet, požádej rodiče o svolení | **SK** Skôr než pôjdeš na internet, vypýtaj si povolenie od rodičov | **HU** Kérj szülői engedélyt, mielőtt online csatlakoznál! | **RO** Cere permisiunea părinților înainte de a te conecta online | **BG** Поискайте разрешение от родител, преди да влезете онлайн | **LV** Pirms došanās tiešsaistē palūdz atļauju vecākiem | **ET** Enne Interneti kasutamist küsi vanematelt luba | **LT** Prieš prisijungdami prie interneto, atsiklauskite tėvų



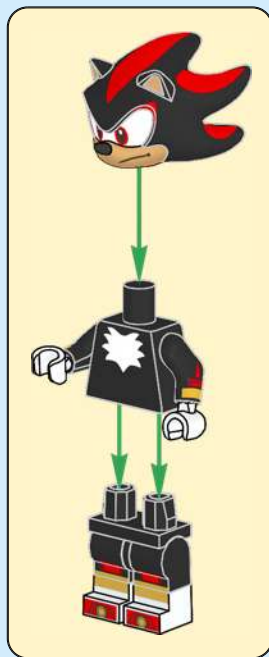

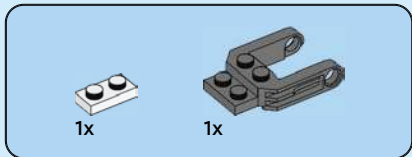
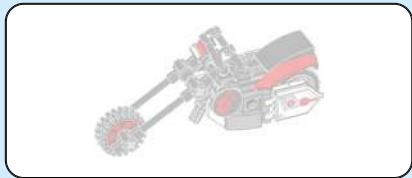

1

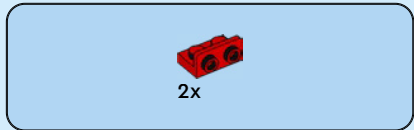
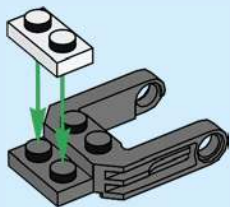

2





1x



1x

3

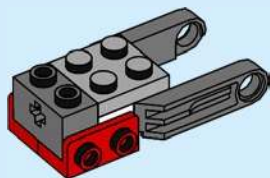

2x

4

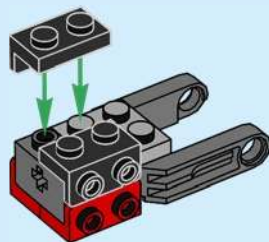

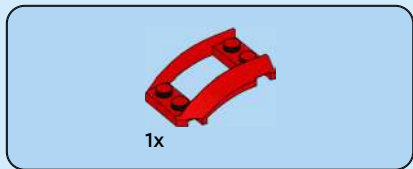

5

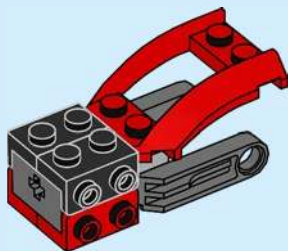

6

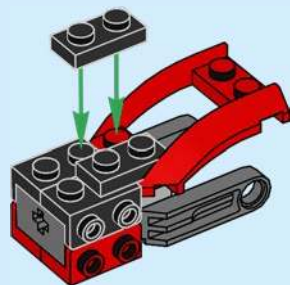



2x



2x

7

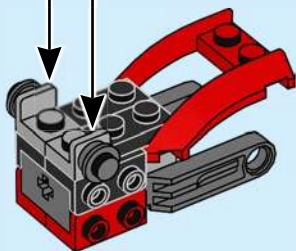
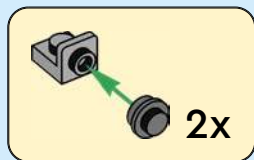

1x



1x

8

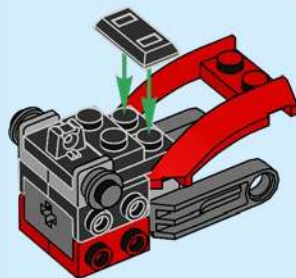

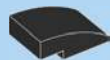

1x

9

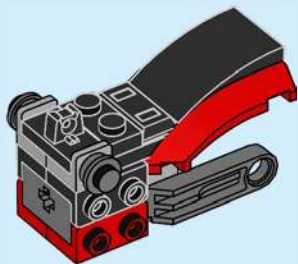

1x



1x

10

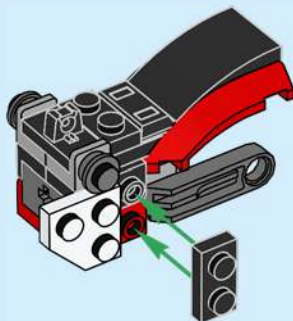



1x

11

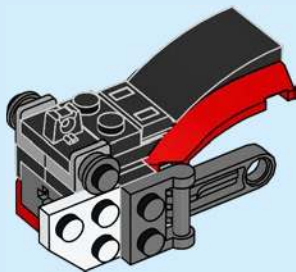

1x



1x

12

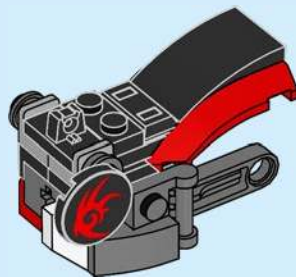



1x

13

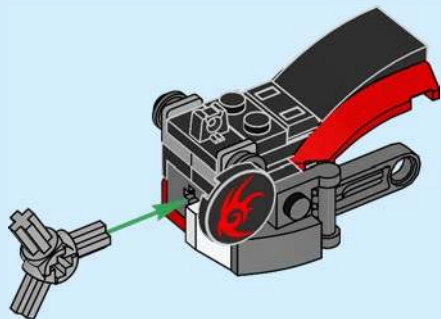

12



1x

14

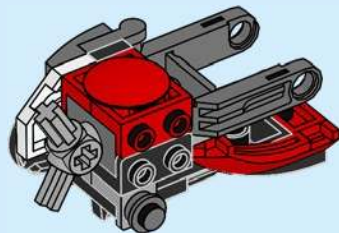
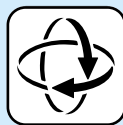



1x



1x

15

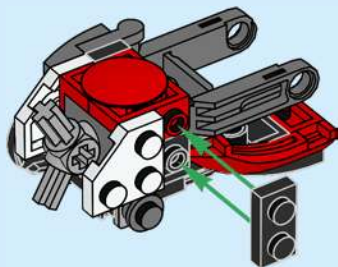

1x

16

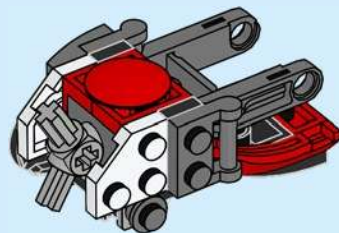



1x



1x

17

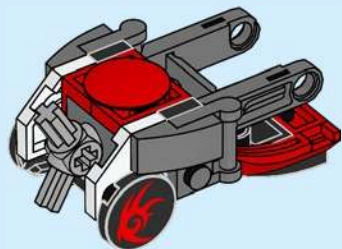

1x

18

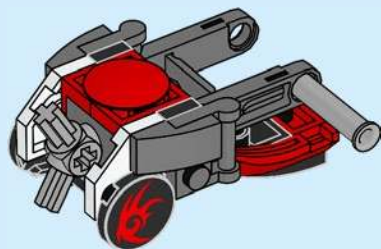

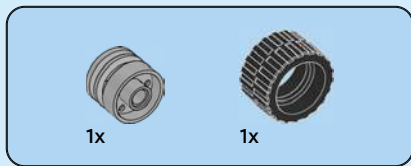

19

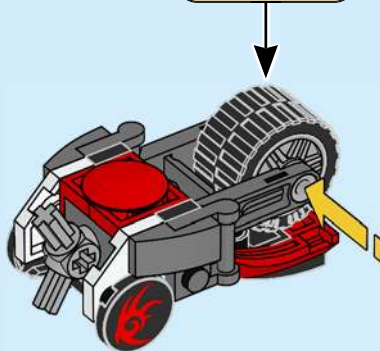
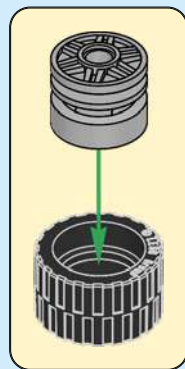



2x



2x



2x

20

1

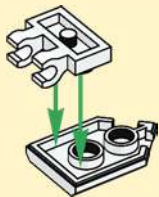

2

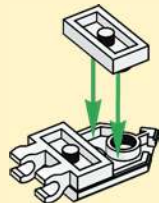

3



2x

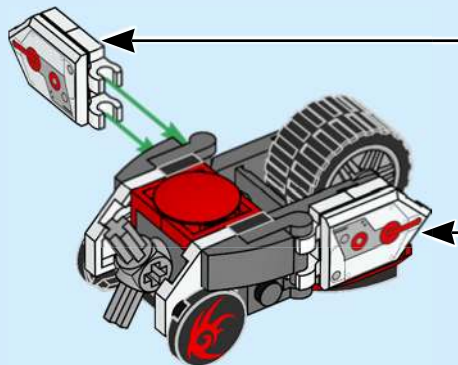



21

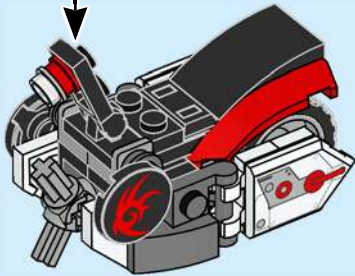
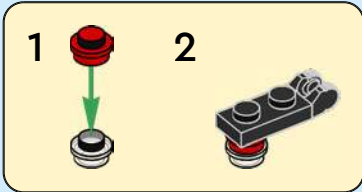



22

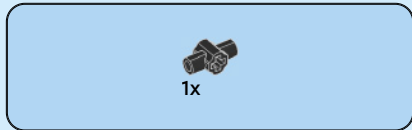

23



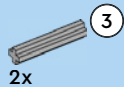

24

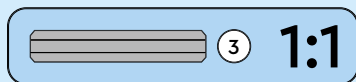
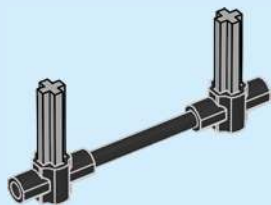

25

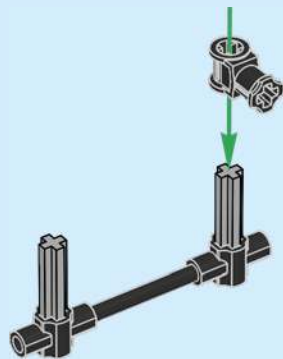



26

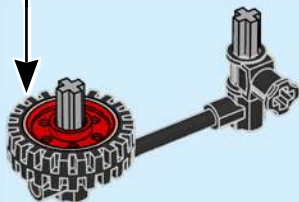
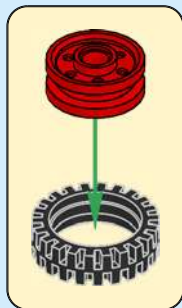



27

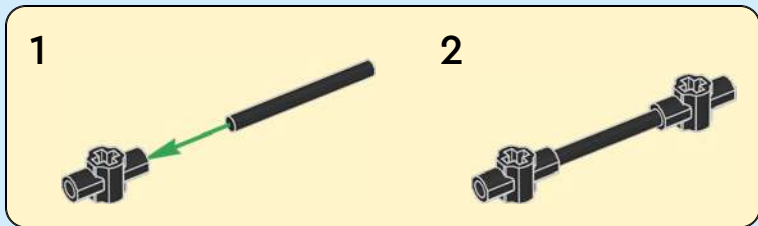

2

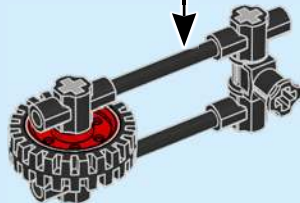



2x

28

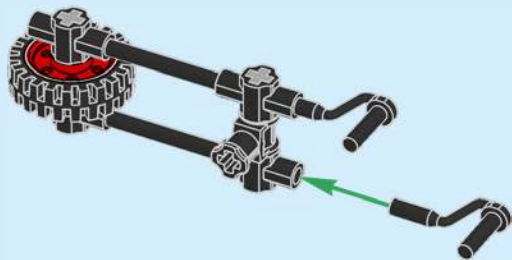

29

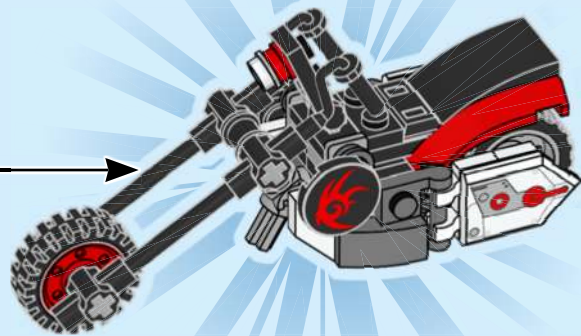

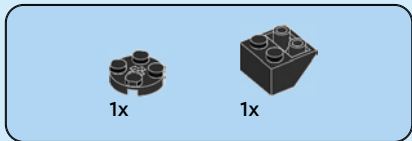
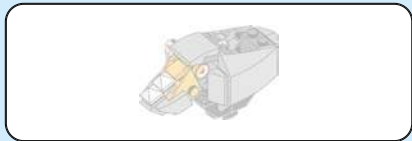

1

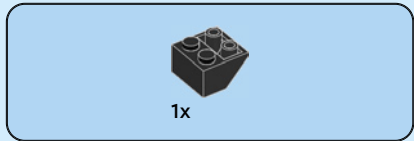

2





3

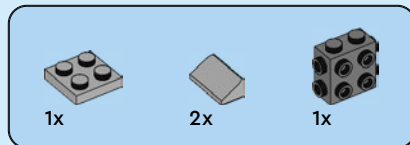

4

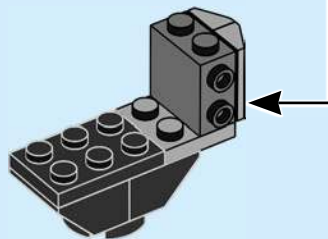
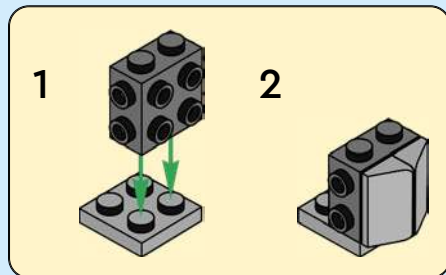



1x

5

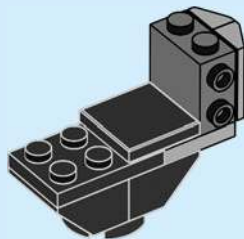

2x



1x



1x



2x

6

1

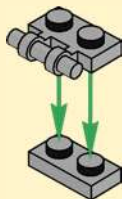

2

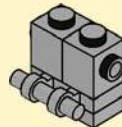

3

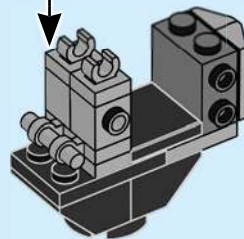
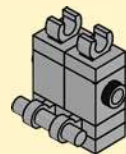

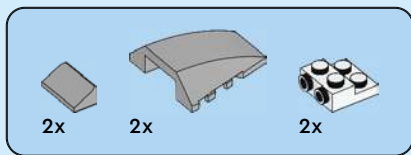

7

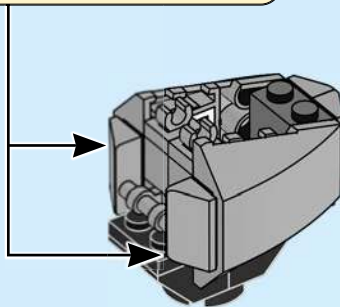
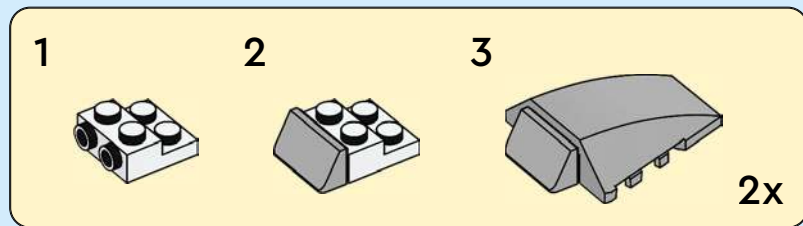



1x



1x

8

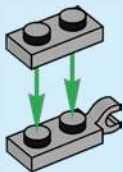

1x

9



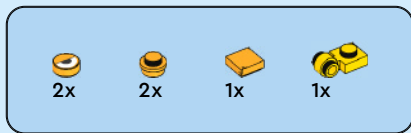

10

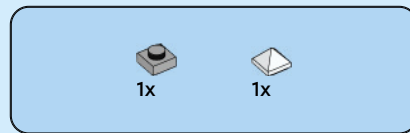
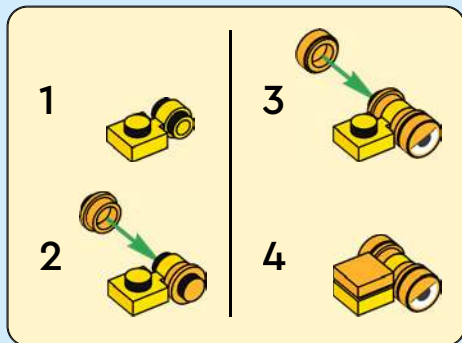

11

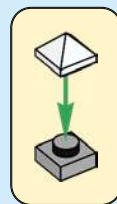

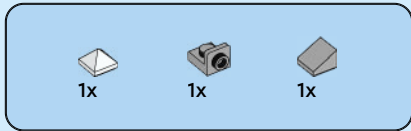

12

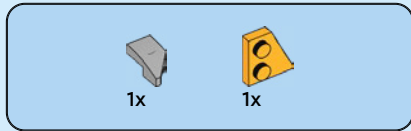
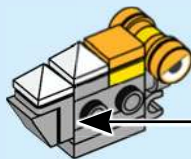
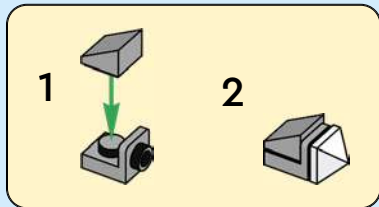

13

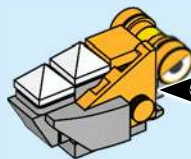
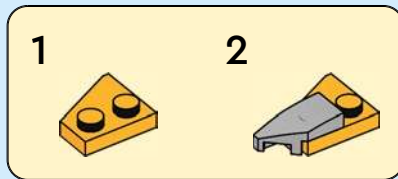

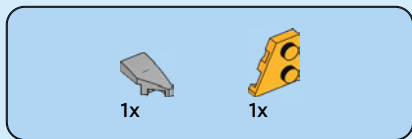

14

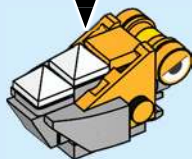
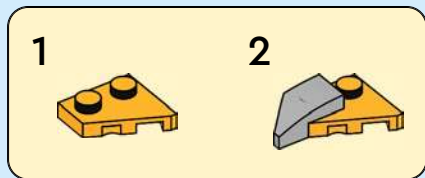

15

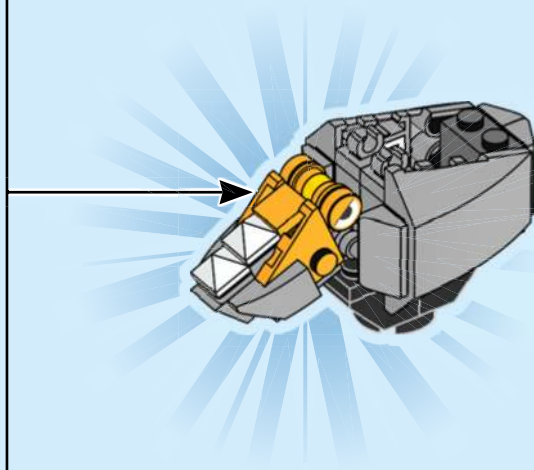

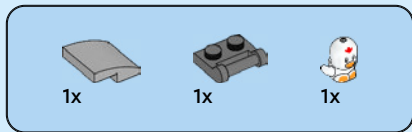

16

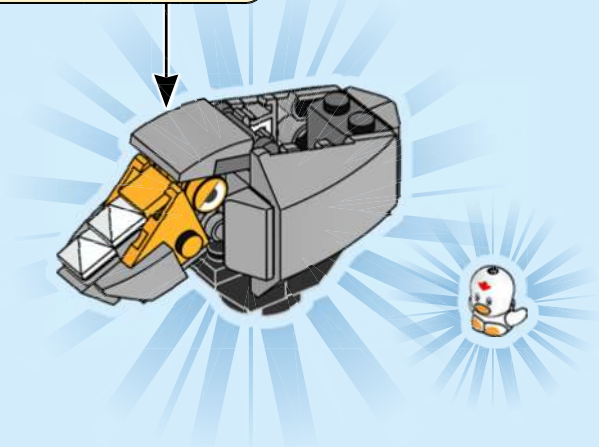
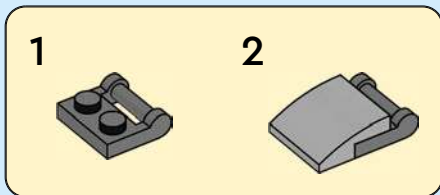



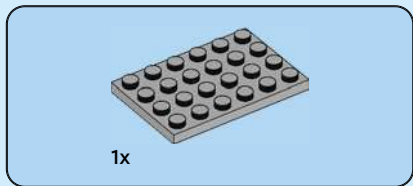
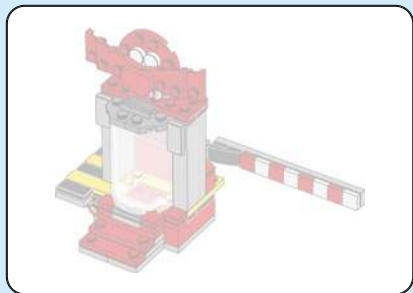

1

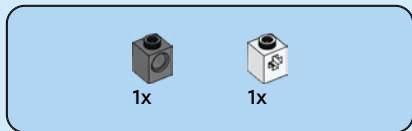
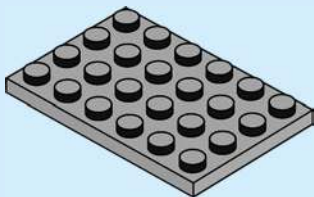

2

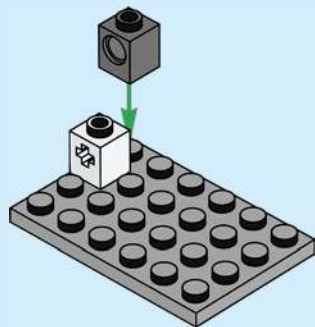



1x

3

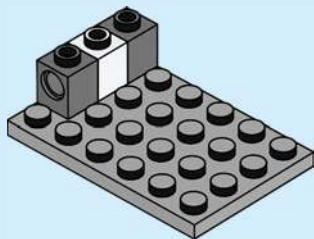

2x

4

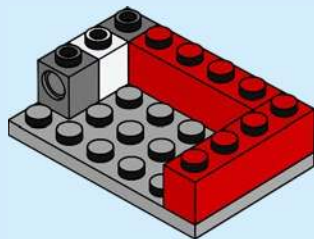

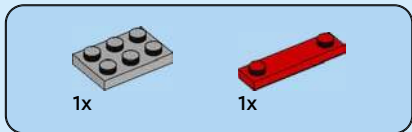

5

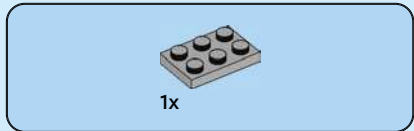
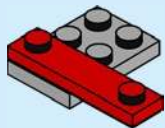

6

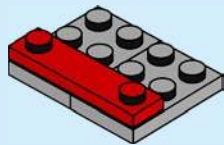



7

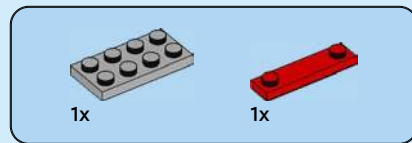
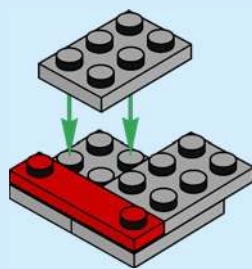

8

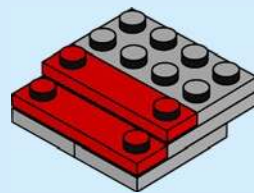

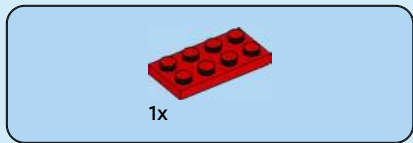

9

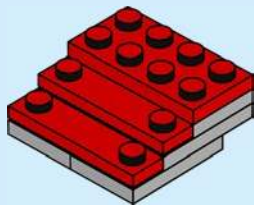

10

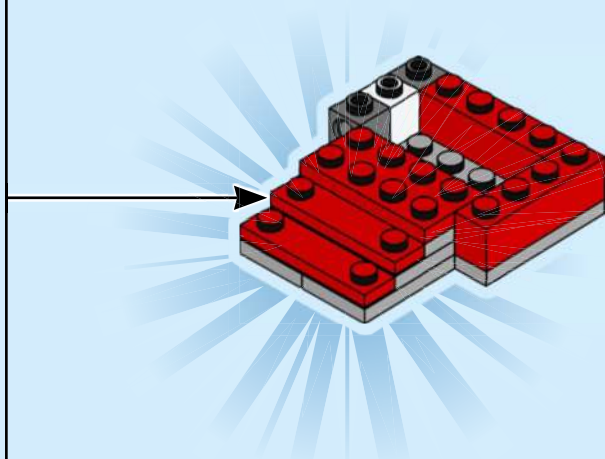

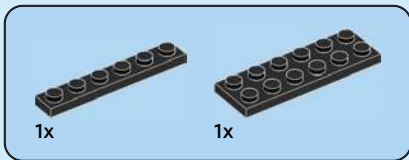

11

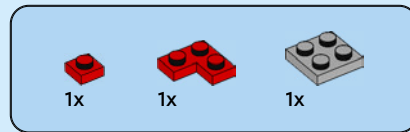
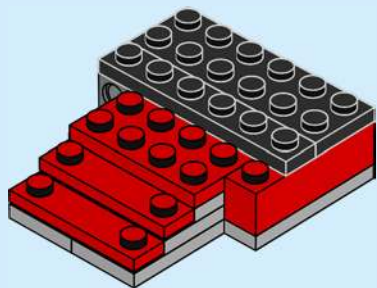

12

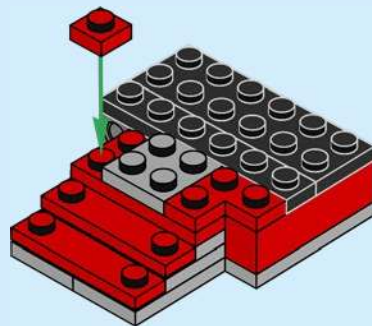

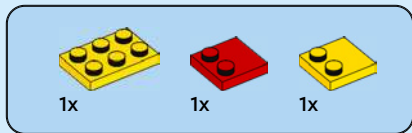

13

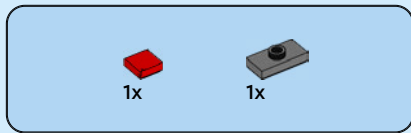
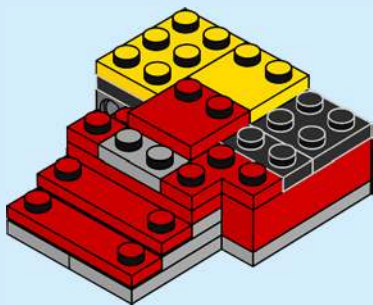

14

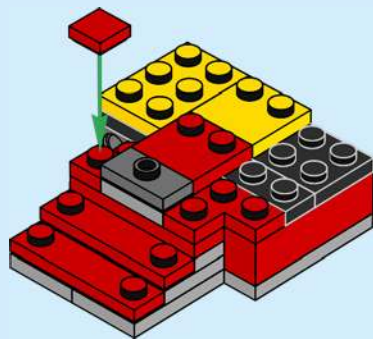

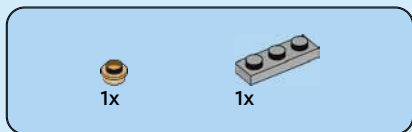

15

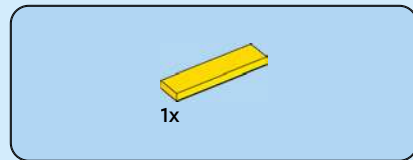
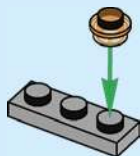

16

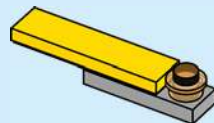

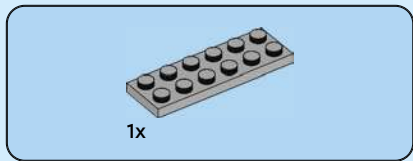

17

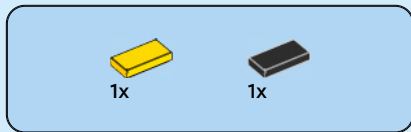

18

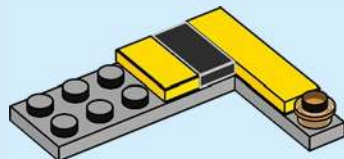

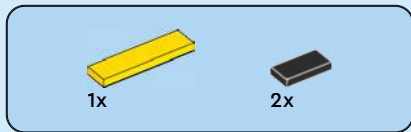

19

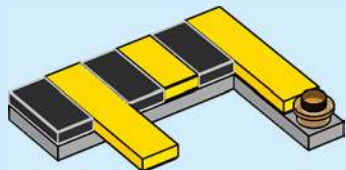

20

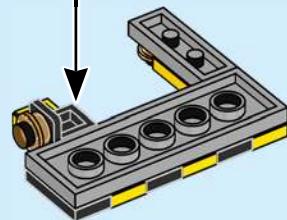
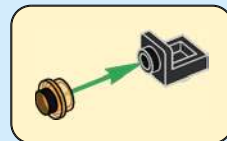
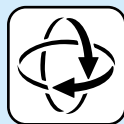



2x



2x

21

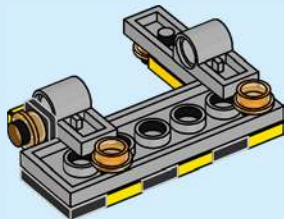

22



2x

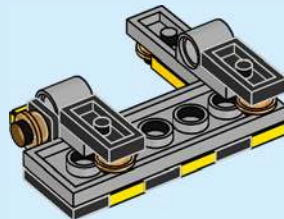

23

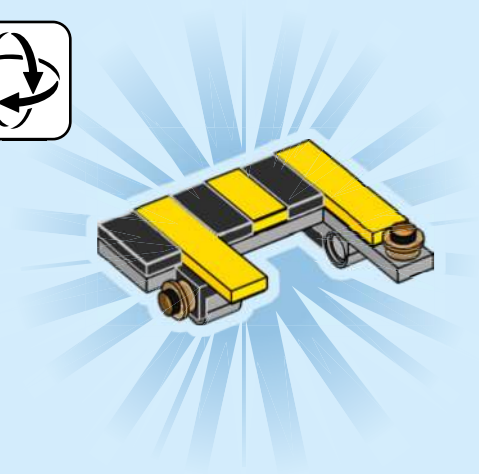

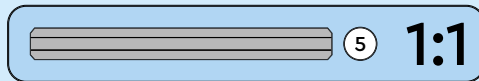
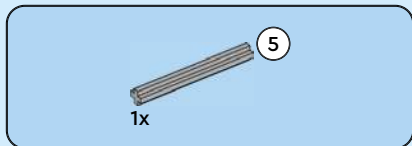

24

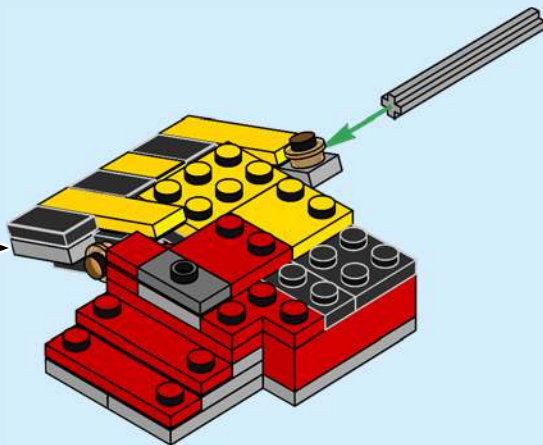

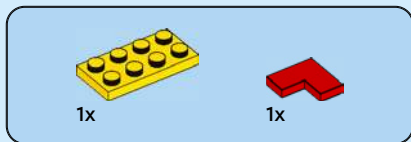

25

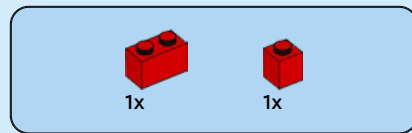
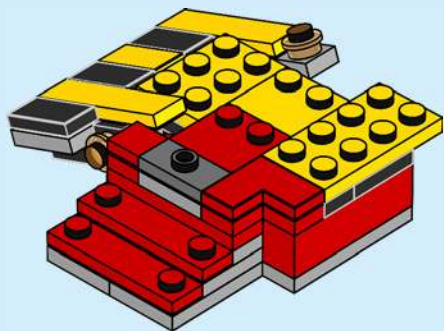

26

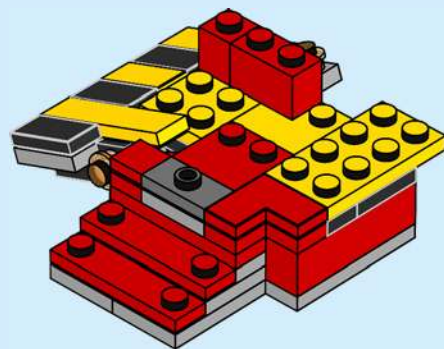



1x



1x

27

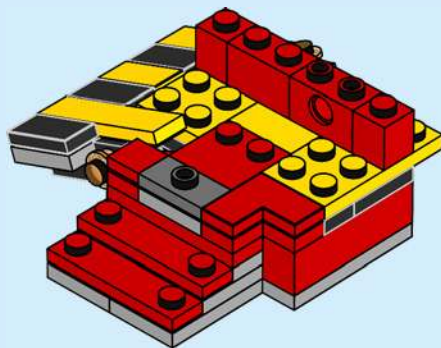

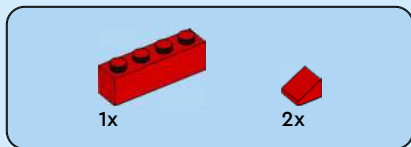

28

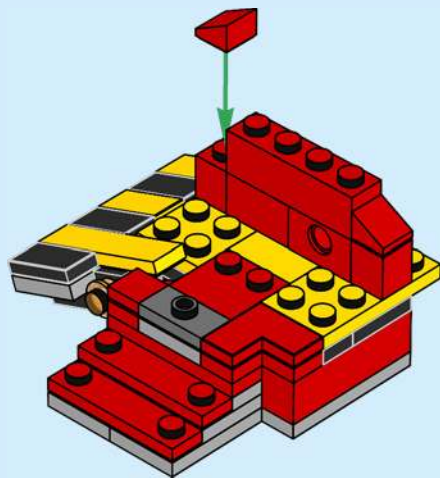



1x

29

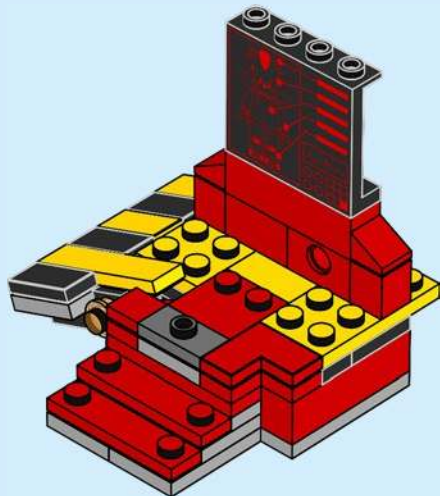

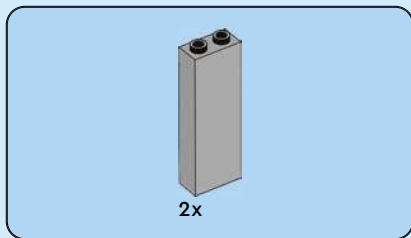

30

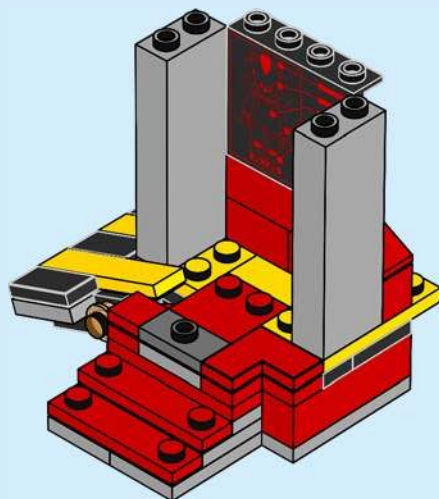



1x



2x

31

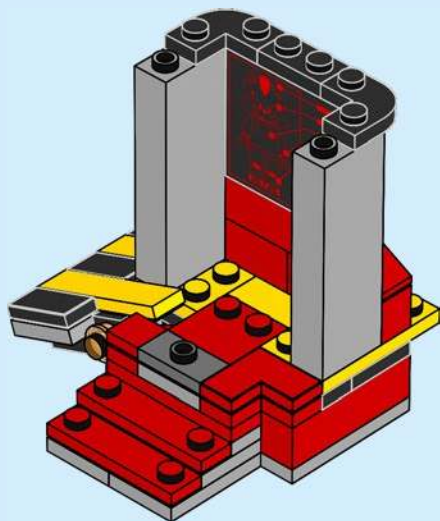

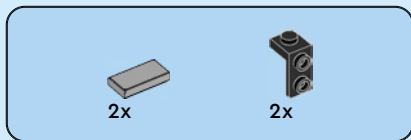

32

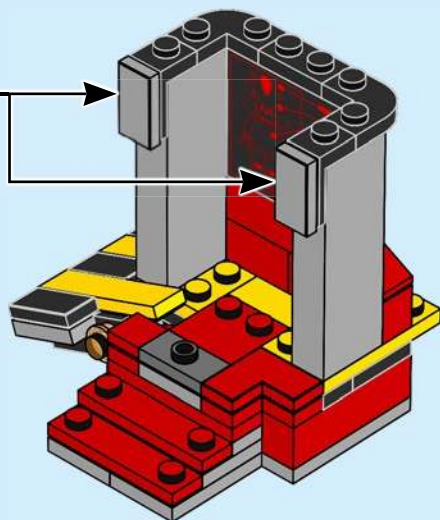
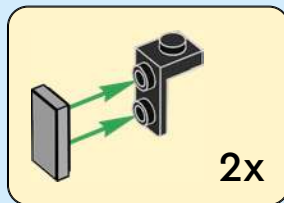

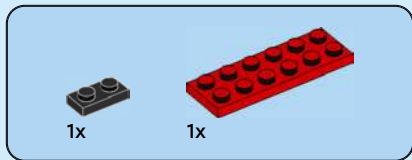

33

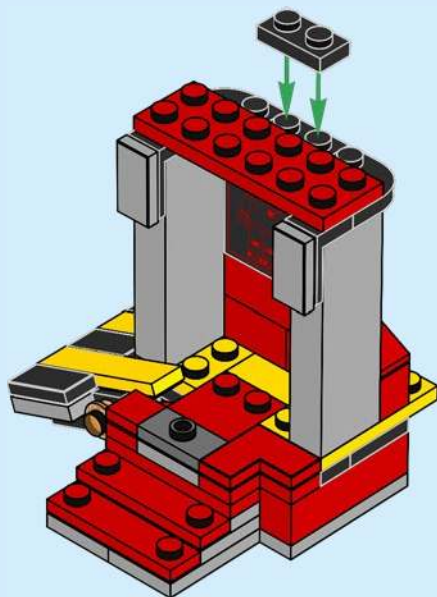



1x



1x

34

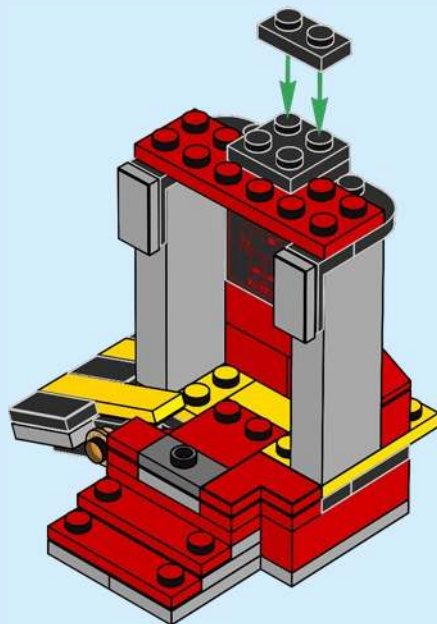

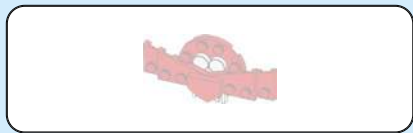

35

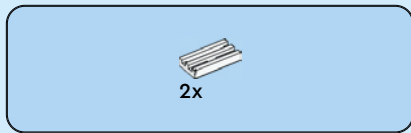

36





2x

37



1x



1x

38



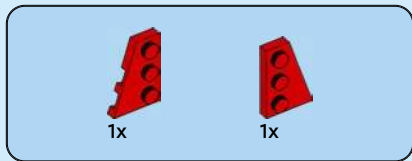

39

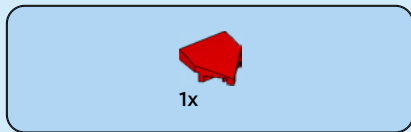

40





1x

41

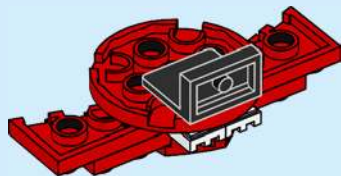

42

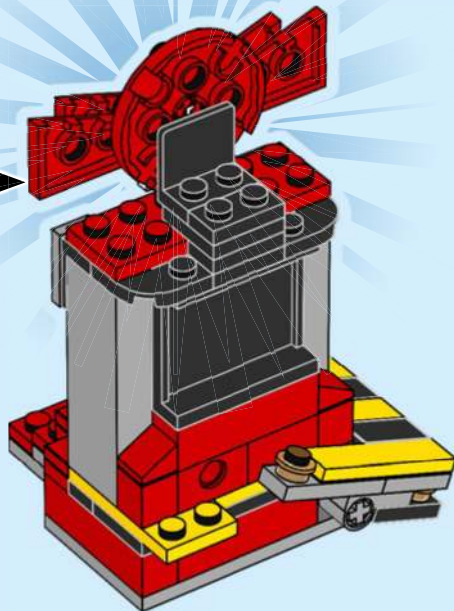



1x

43

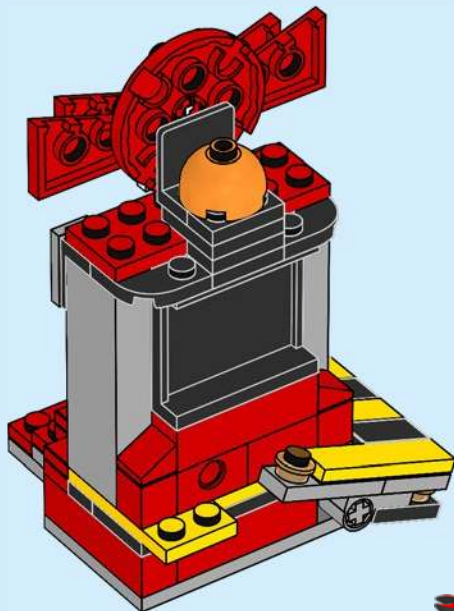

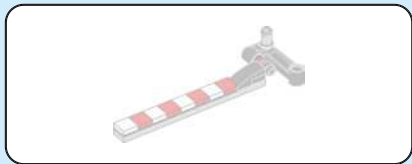

44

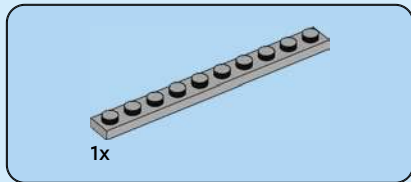
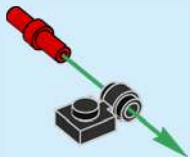

45

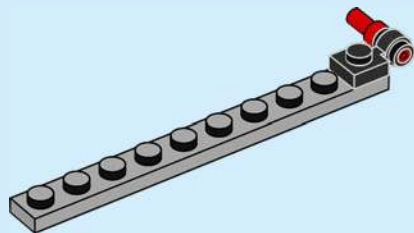



1x

46

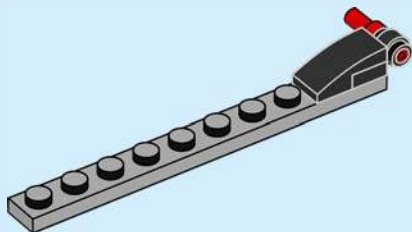

4x



4x

47

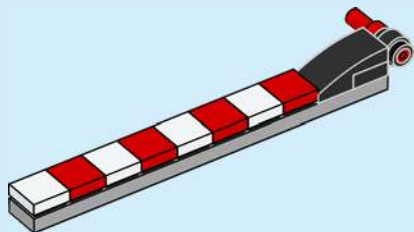

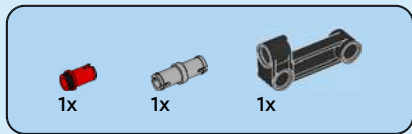

48

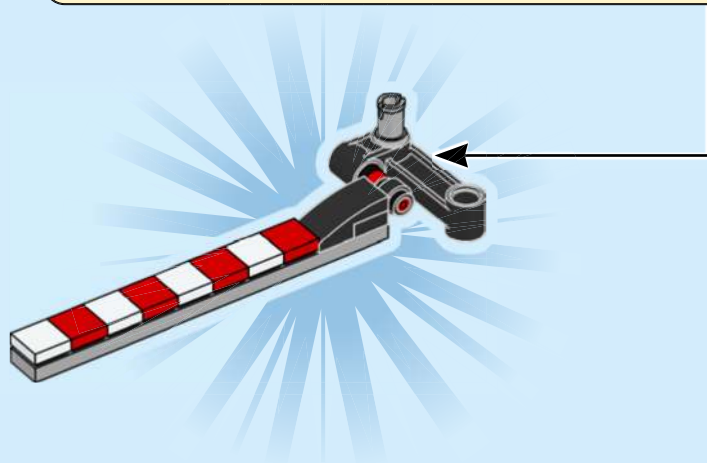
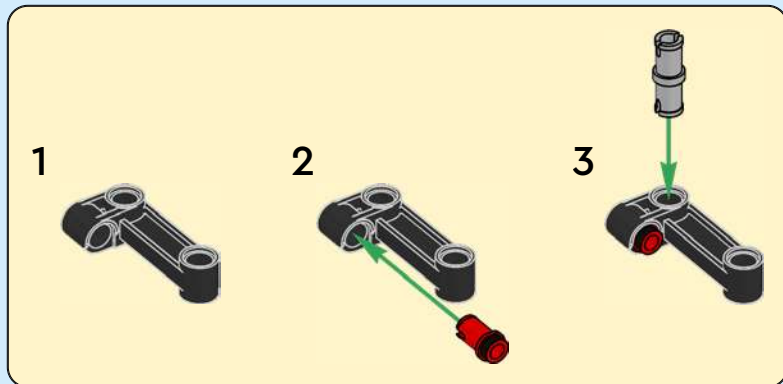

49

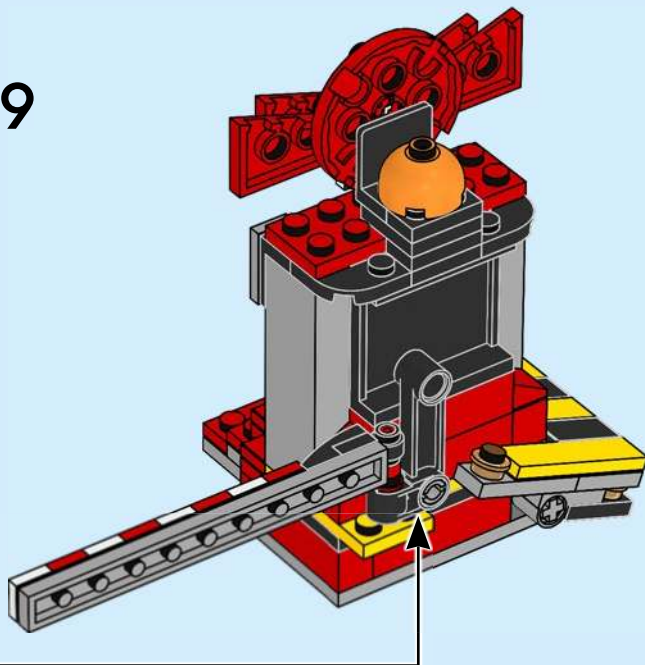

50

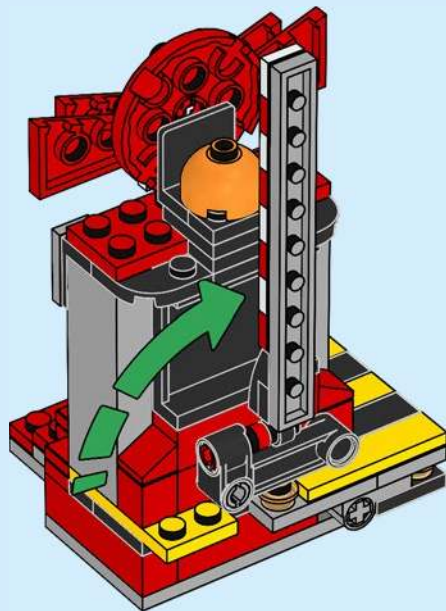

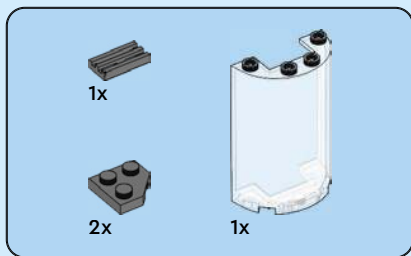

51

1

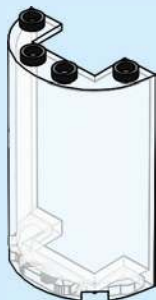

2

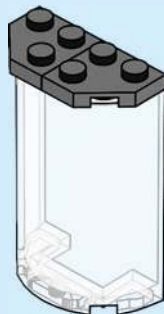

3



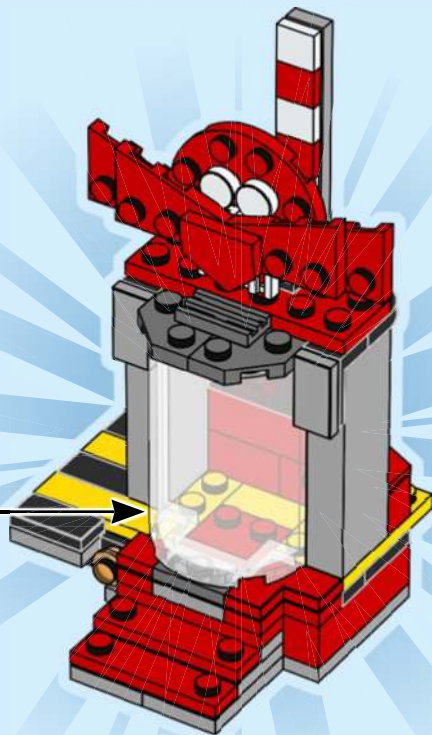
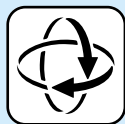

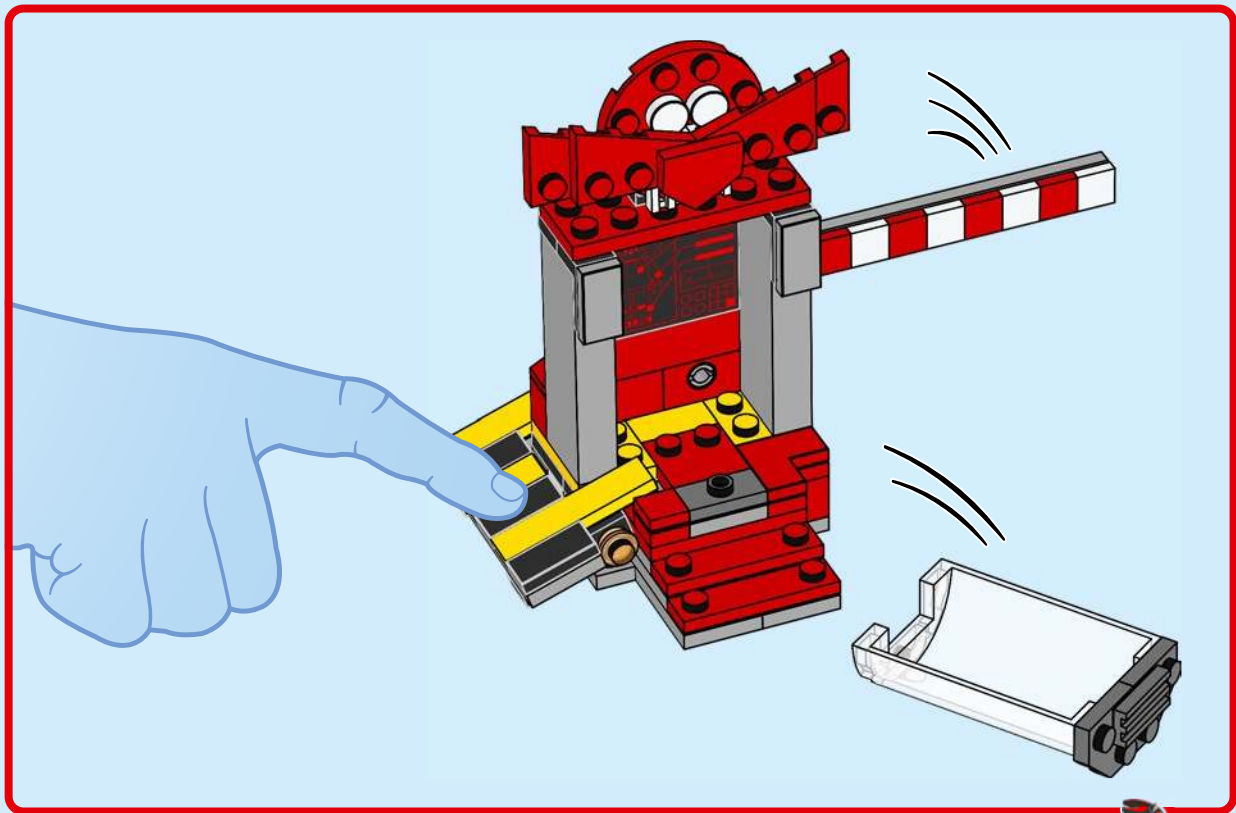

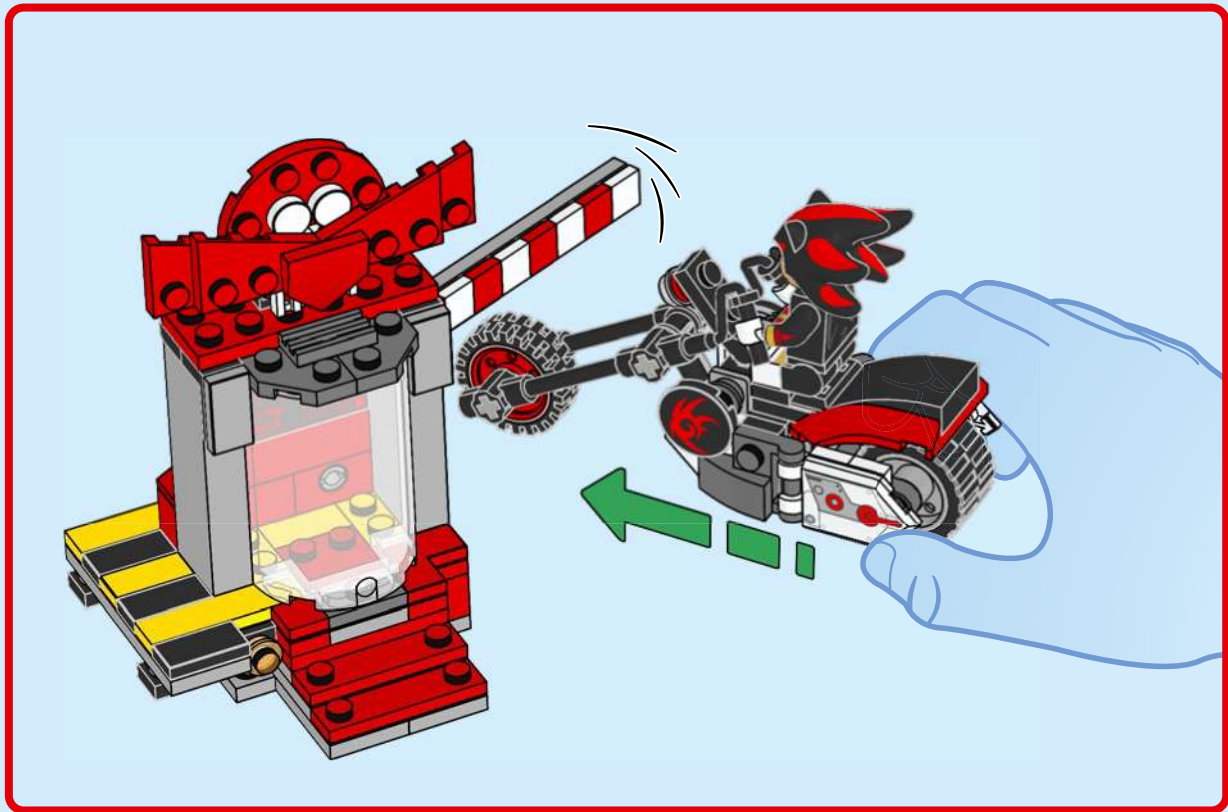

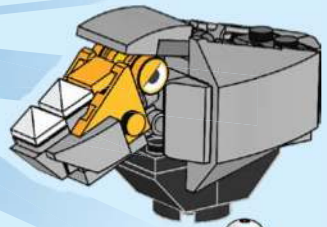
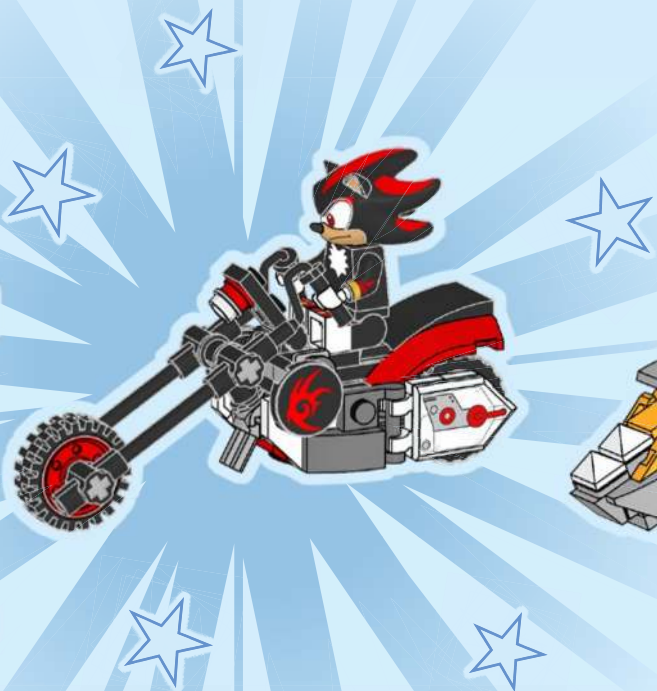
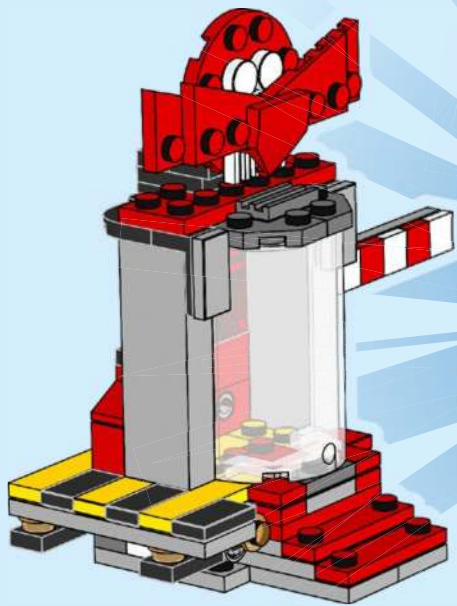



SONIC™

THE HEDGEHOG

Explore more
Mehr entdecken
En savoir plus
Esplora di più
Explora más
Explorar mais
了解更多
Zobacz więcej

Objev více
Objav viac
Tudj meg többet!
Descoperă mai multe
Разгледайте още
Izpēti vairāk
Uuri lähemalt
Atraskite daugiau

EXPLORE MORE



 LEGO.com/sonic



©SEGA. All rights reserved. SEGA is registered in the U.S. Patent and Trademark Office. SEGA and SONIC THE HEDGEHOG are either registered trademarks or trademarks of SEGA CORPORATION.



76990



76991



76992



76993



76994

 2x 6284572	 1x 614121	 1x 370021	 2x 6256923	 2x 243124	 1x 6474304	 1x 302226	 1x 6172966
 1x 6443188	 1x 6378120	 1x 300421	 1x 4515348	 1x 302024	 9x 302326	 2x 6430580	 1x 6474293
 2x 6314487	 2x 4504379	 1x 6305047	 1x 302021	 2x 6380236	 1x 6156991	 1x 6267045	
 1x 6345886	 5x 307021	 2x 6089698	 1x 6133554	 1x 6299338	 3x 306926	 1x 4541455	 1x 366626
 4x 307001	 1x 302421	 1x 6048859	 1x 379521	 2x 6192778	 1x 6047276	 1x 6474420	 1x 379526
 3x 302301	 1x 6399645	 1x 6219819	 1x 6281992	 2x 6474295	 2x 6016172	 1x 6132299	 1x 6420227
 2x 6176240	 1x 4278275	 1x 242021	 1x 306924	 1x 6281993	 1x 6000650	 2x 6116604	 1x 6240030
 2x 241201	 2x 300521	 1x 6078641	 1x 6224666	 4x 6280097	 2x 6425507	 1x 302126	
 2x 6347287	 2x 4180533	 2x 6078641	 1x 6224666	 1x 6331716	 1x 306826	 1x 6147790	
 2x 6469441	 2x 4180504	 3x 301021	 1x 302124		 1x 6265730	 1x 647790	 1x 6246876



1x
6225139



1x
4211399



2x
4558953



3x
6335328



1x
4521921



1x
6225142



4x
4568637



1x
4211807



2x
4211398



2x
4211414



2x
6168633



1x
4502595



1x
4211632



2x
6308012



1x
6319336



1x
6102357



2x
6335830



2x
4211363



4x
4211396



3x
4211397



1x
4211395



2x
4211815



1x
4211639



1x
4211452



1x
4211404



1x
4251149



1x
6109684



1x
6338962



1x
4211502



1x
4211429



2x
6331261



2x
6474296



1x
6065504



1x
6296241



1x
6328059



2x
4210633



2x
4210639



1x
6178919



2x
6029948



1x
6092572



2x
6164073



1x
4210631



1x
6314192



3x
6146321



1x
6338470



1x
6474303



 [LEGO.com/service](https://www.LEGO.com/service)

YOU COULD
WIN



Scan this QR code or go to
LEGO.COM/PRODUCTFEEDBACK and give
us your short feedback about this LEGO® set
for a chance to win a cool LEGO prize.

Terms and Conditions apply*



EN: YOU COULD WIN. Terms and Conditions apply* **DE: Du könntest GEWINNEN.** Es gelten die Teilnahmebedingungen* **FR: Tu pourrais GAGNER.** Des conditions s'appliquent* **IT: Potresti VINCERE tu.** Termini e condizioni sono applicabili* **ES: Puedes GANAR.** Aplican términos y condiciones* **PT: Poderá GANHAR.** Aplicam-se termos e condições* **ZH: 轻松获奖. 条款和条件适用*** **PL: Szansa na WYGRANĄ.** Obowiązują warunki korzystania* **CS: Máte šanci VYHRÁT.** Platí všeobecné smluvní podmínky* **SK: Máte šancu VYHRÁŤ.** Platia všeobecné zmluvné podmienky* **HU: TE IS NYERHETSZ.** Felhasználási feltételek érvényesek* **RO: Ai putea CÂȘTIGA.** Se aplică termenii și condiții* **BG: Можете да СПЕЧЕЛИТЕ.** Има определени правила и условия* **LV: Tu vari LAIMĒT.** Ir spēkā noteikumi un nosacījumi.* **ET: Sul on võimalus VÕITA.** Kehtivad tingimused* **LT: Jūs galite LAIMĖTI.** Taikomos sąlygos*

*[LEGO.com/productfeedback/terms](https://www.lego.com/productfeedback/terms)

LEGO and the LEGO logo are trademarks of the LEGO Group. ©2024 The LEGO Group.

©SEGA. All rights reserved. SEGA is registered in the U.S. Patent and Trademark Office.

SEGA and SONIC THE HEDGEHOG are either registered trademarks or trademarks of SEGA CORPORATION.

6494373