



**MARVEL**

76298



Q LEGO® Builder



[LEGO.com/sustainable-packaging](https://LEGO.com/sustainable-packaging)



**FR**  
**DONNEZ**  
OU  
**RECYCLEZ**

 OU  OU 

ASSOCIATION    MAGASIN    DÉCHÈTERIE

Adresses sur [quefairedemesdechets.fr](https://quefairedemesdechets.fr)

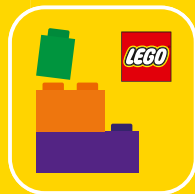

LEGO® Builder

# BUILDER



Apple and the Apple logo are trademarks of Apple Inc., registered in the U.S. and other countries and regions. App Store is a service mark of Apple Inc. Google Play and the Google Play logo are trademarks of Google LLC. Tencent and the Tencent logo are trademarks of Tencent Inc.

LEGO.com/devicecheck

**EN** Ask parents' permission before going online | **DE** Eltern um Erlaubnis bitten, bevor du online gehst | **FR** Demande l'autorisation d'un parent avant d'aller en ligne | **IT** Chiedi il permesso ai tuoi genitori prima di andare online | **ES** Pídeles permiso a tus papás antes de conectarte a Internet | **PT** Peça autorização aos pais antes de acederes online | **ZH** 上网前应先征得父母的同意 | **PL** Poproś rodziców o zgodę, zanim wejdiesz do Internetu | **CS** Než půjdeš na internet, požádej rodiče o svolení | **SK** Skôr než pôjdeš na internet, vypýtaj si povolenie od rodičov | **HU** Kérj szülői engedélyt, mielőtt online csatlakoznál! | **RO** Cere permisiunea părinților înainte de a te conecta online | **BG** Поискайте разрешение от родител, преди да влезете онлайн | **LV** Pirms došanās tiešsaistē palūdz atļauju vecākiem | **ET** Enne Interneti kasutamist küsi vanematelt luba | **LT** Prieš prisijungdami prie interneto, atsiklauskite tėvų





2x

2

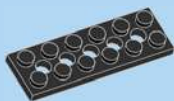
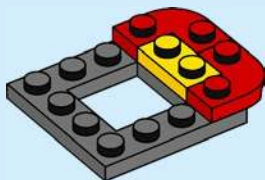

1x

3



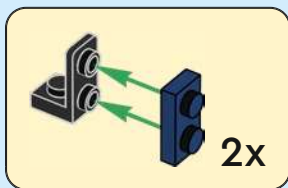
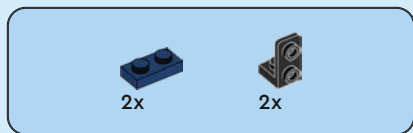

4

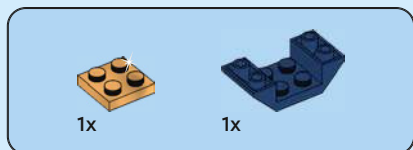
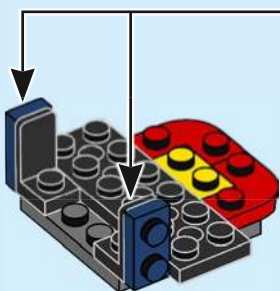

5

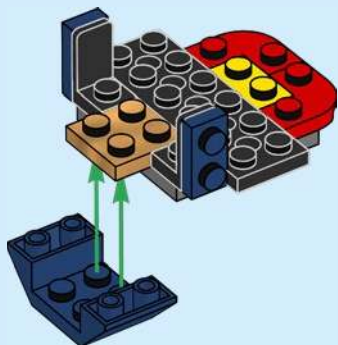



2x



1x

6



2x

7





4x

8

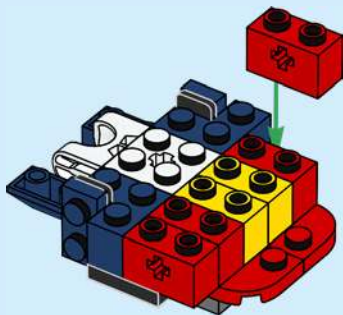



1x



4x

9

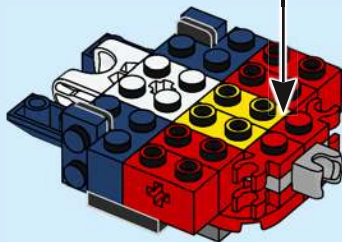
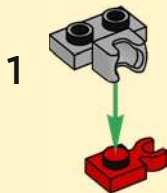

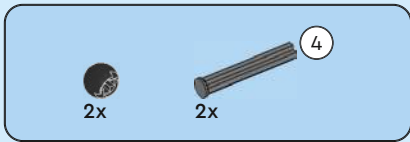

10

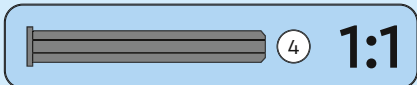
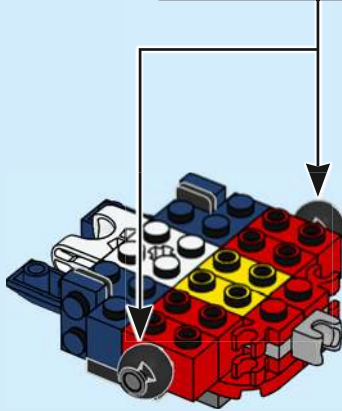
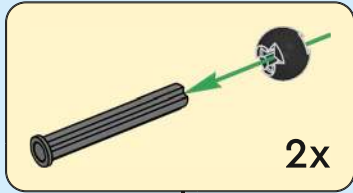



2x

# 11



1x



1x



2x



1x

# 12

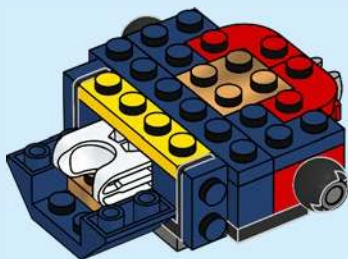



2x

13

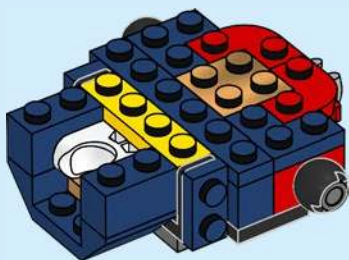

1x

14

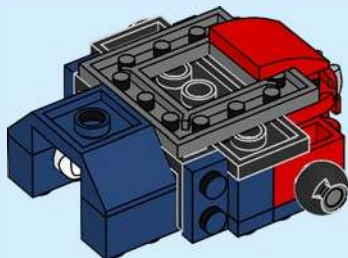



2x

# 15

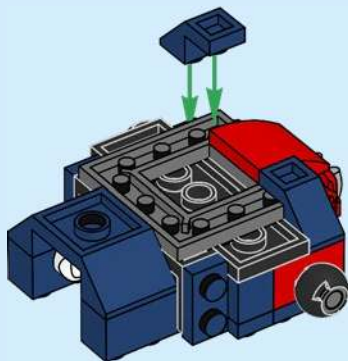

1x



2x

# 16

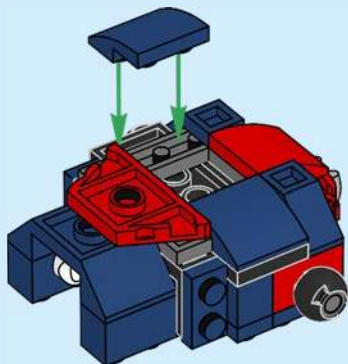



1x

17

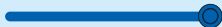
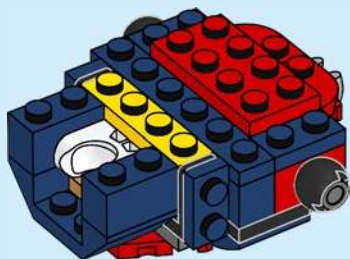



1x



1x

# 18

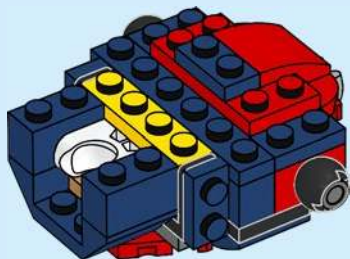

1x



1x

# 19

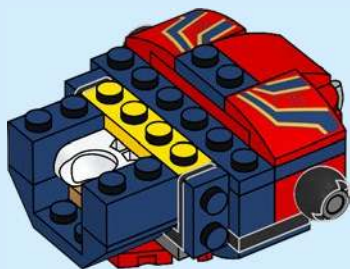

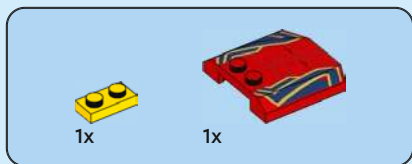

20

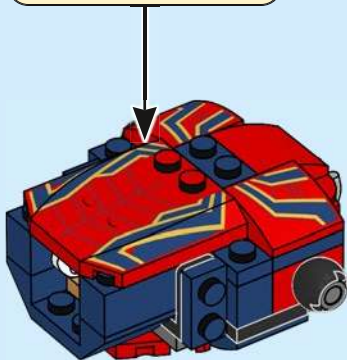
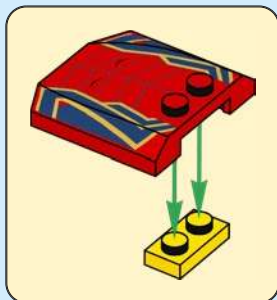



2x

21

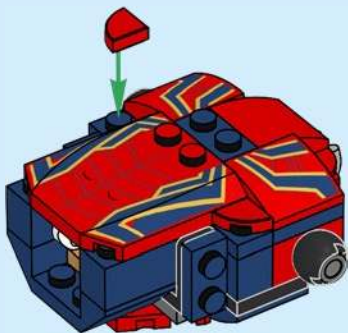



1x



1x

# 22





1x



1x

23

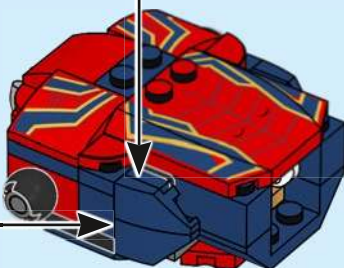

1x

24



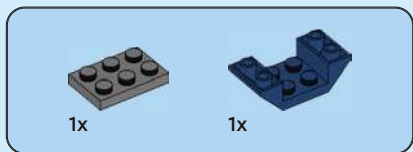

# 25

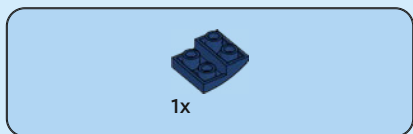
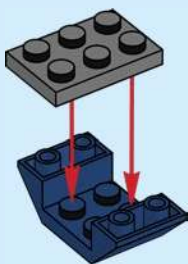

# 26

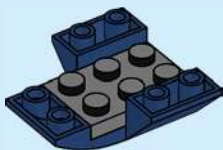



2x

# 27

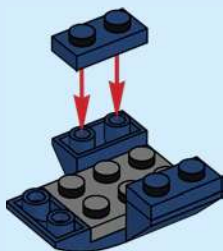

1x

# 28

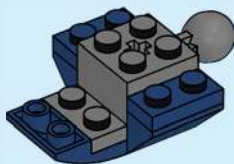



2x

# 29

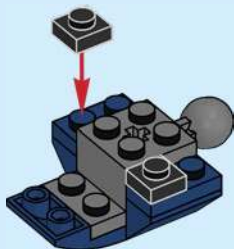

2x

# 30

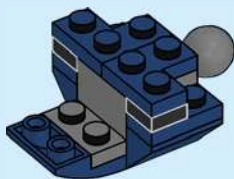



2x

# 31

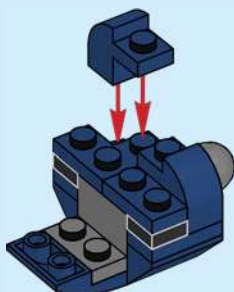

2x

# 32

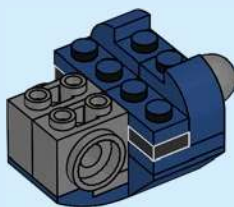



1x

# 33

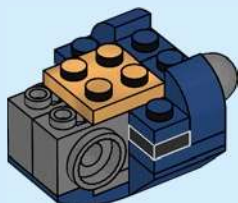

1x



1x



1x



1x

# 34

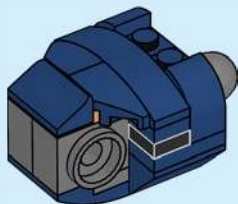



1x

35

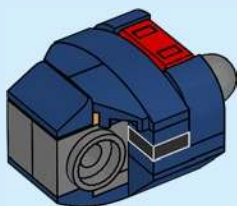

36

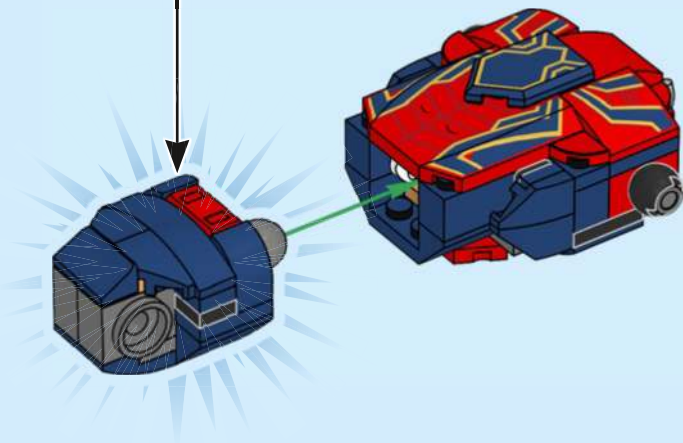

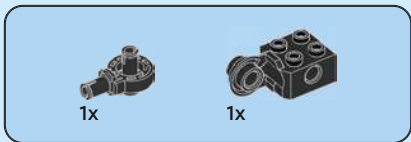

37

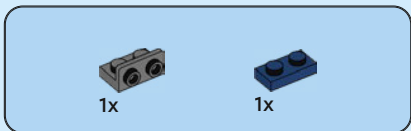
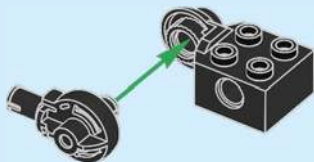

38

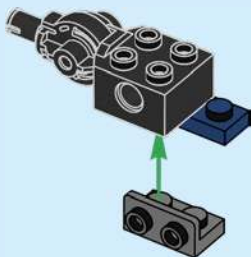





2x

41

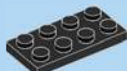
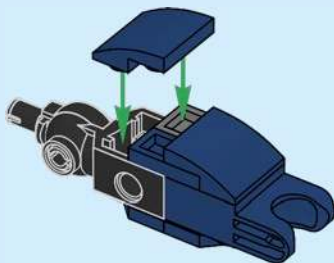

1x



1x



2x



2x

42

1



2

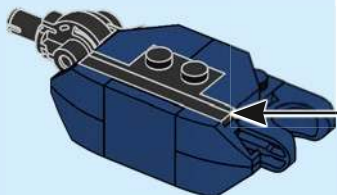
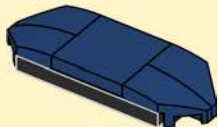



43

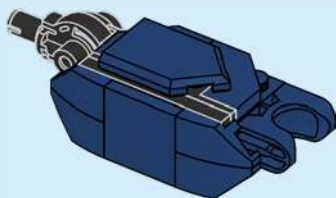

44

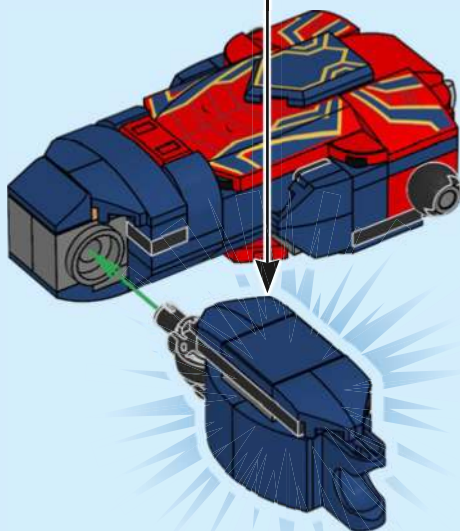



45

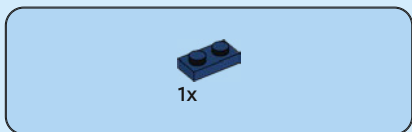
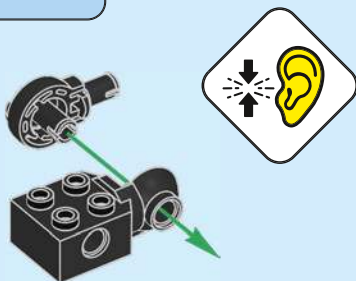

46

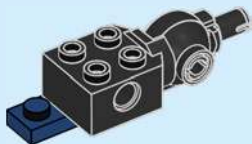



1x

47

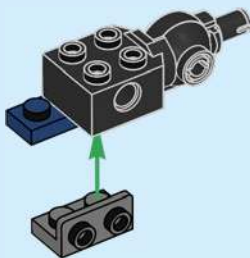

1x

48

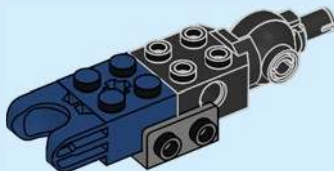



2x

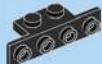

1x

# 49

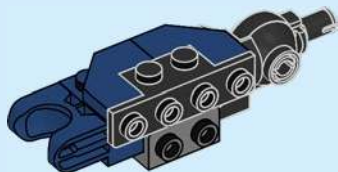

2x

# 50

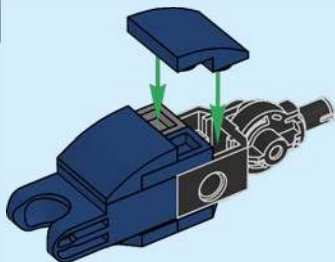

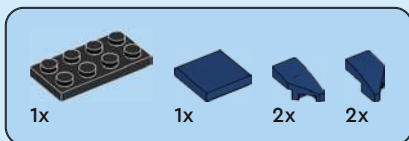

# 51

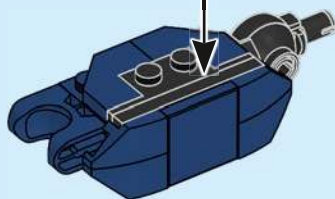
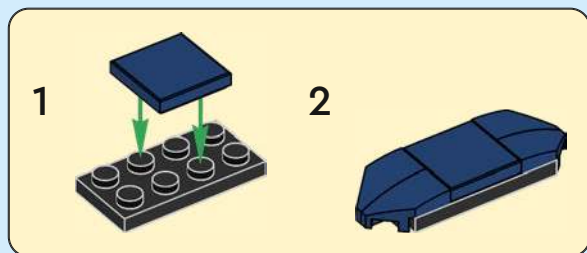



1x

52

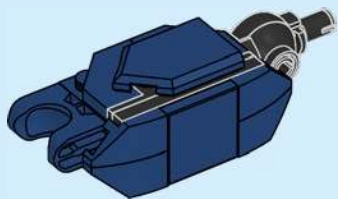

53

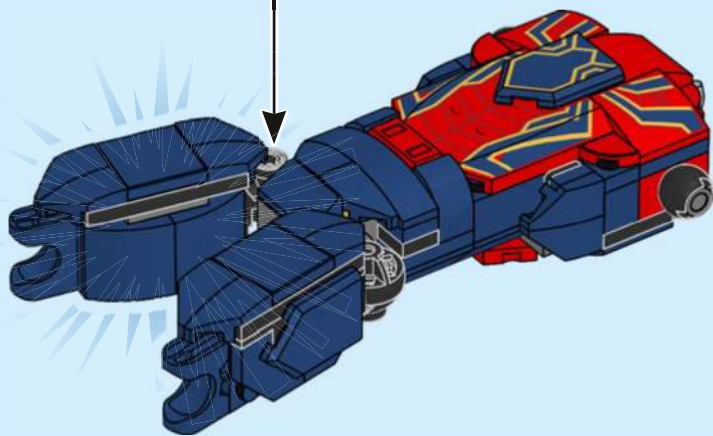



2x



1x



1x

54

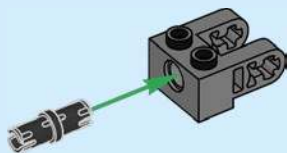

1x

55





2x

# 56

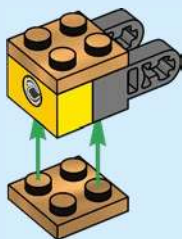

1x

# 57





1x

58



2x

59



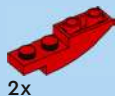

2x



1x

# 60

1

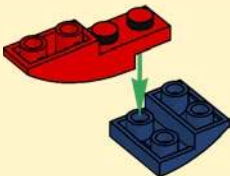

2



2x



1x

# 61

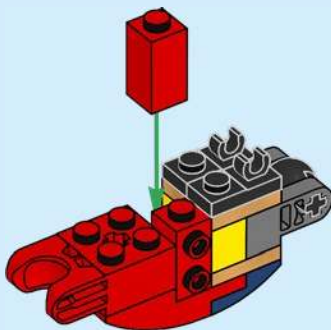



1x

62

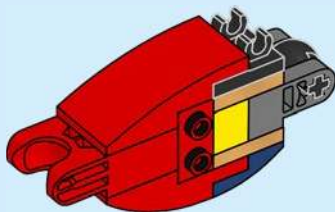

2x

63

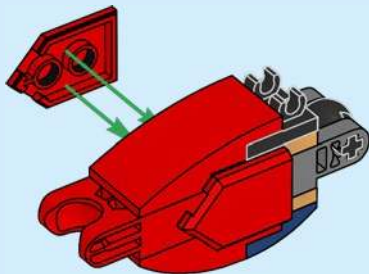

2x

64

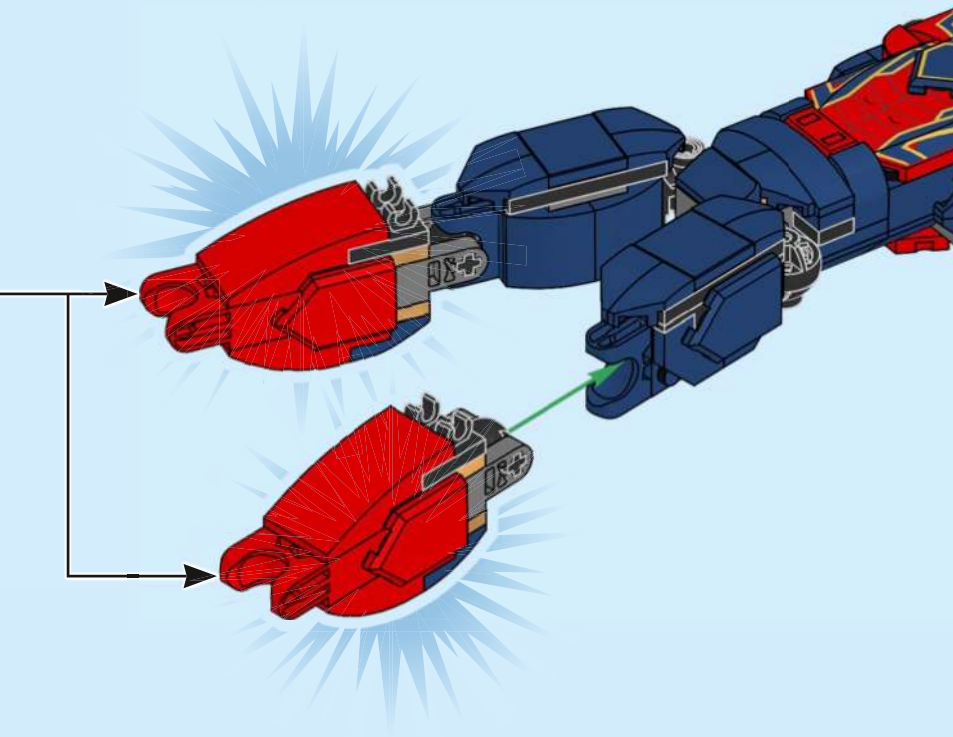

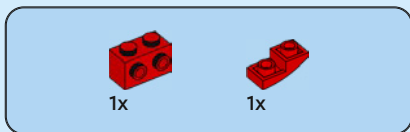

65

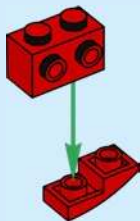



1x

66

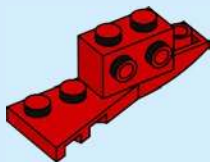

1x



1x



1x

67

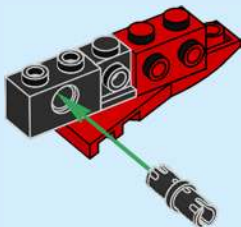

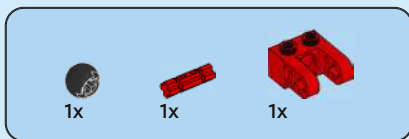

68

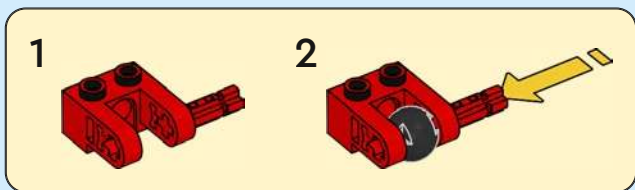



1x

69

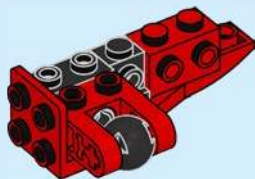

1x



1x

70

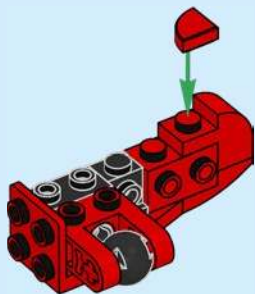

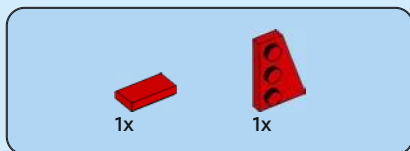

71

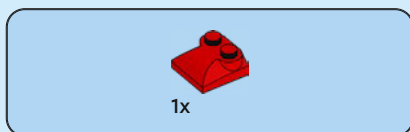
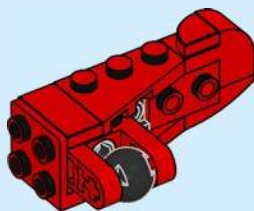

72

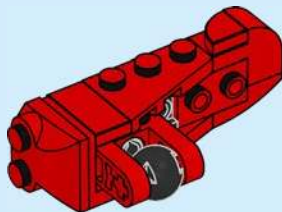



1x



1x

# 73

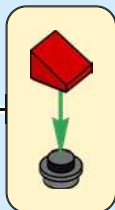
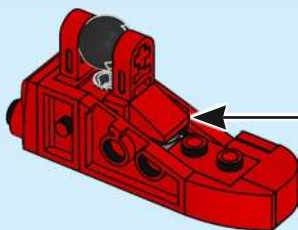

1x



1x

# 74

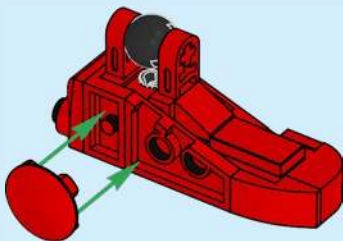

75

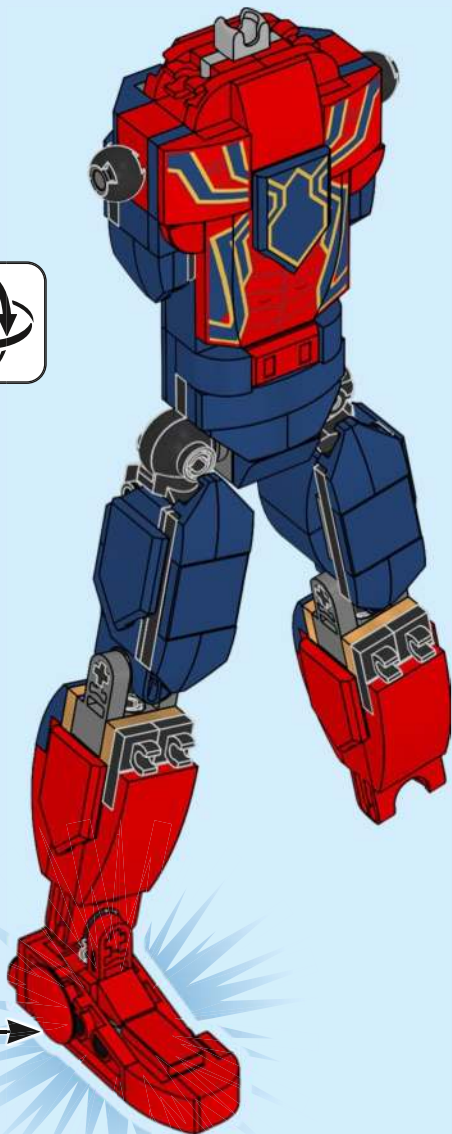



1x



1x

# 76

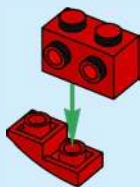

1x

# 77

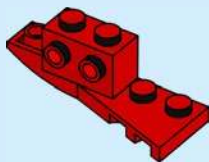



1x



1x



1x

# 78

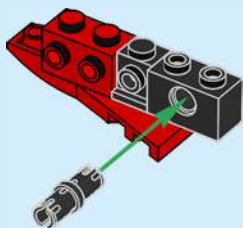

1x



1x



1x

# 79

1

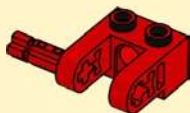

2

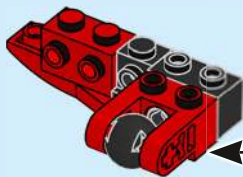



1x

# 80

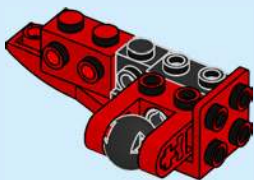

1x



1x

# 81

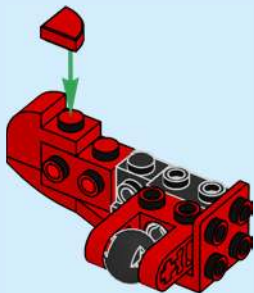

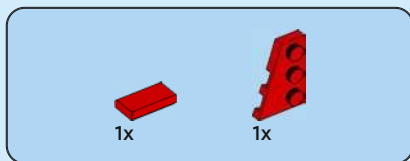

82

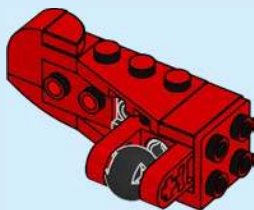

83

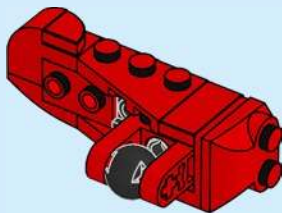

1x



1x

84

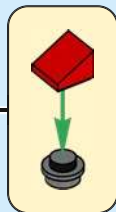
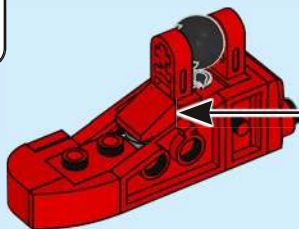

1x



1x

85

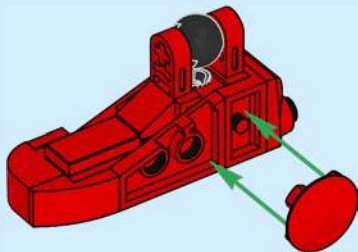

86

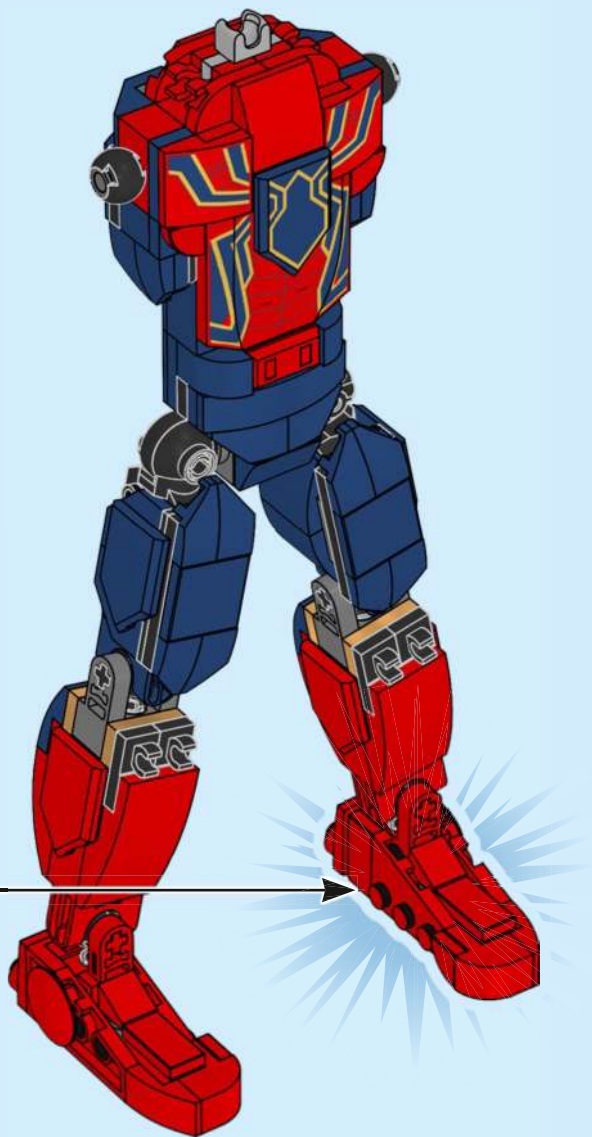



2x



2x



4x

# 87

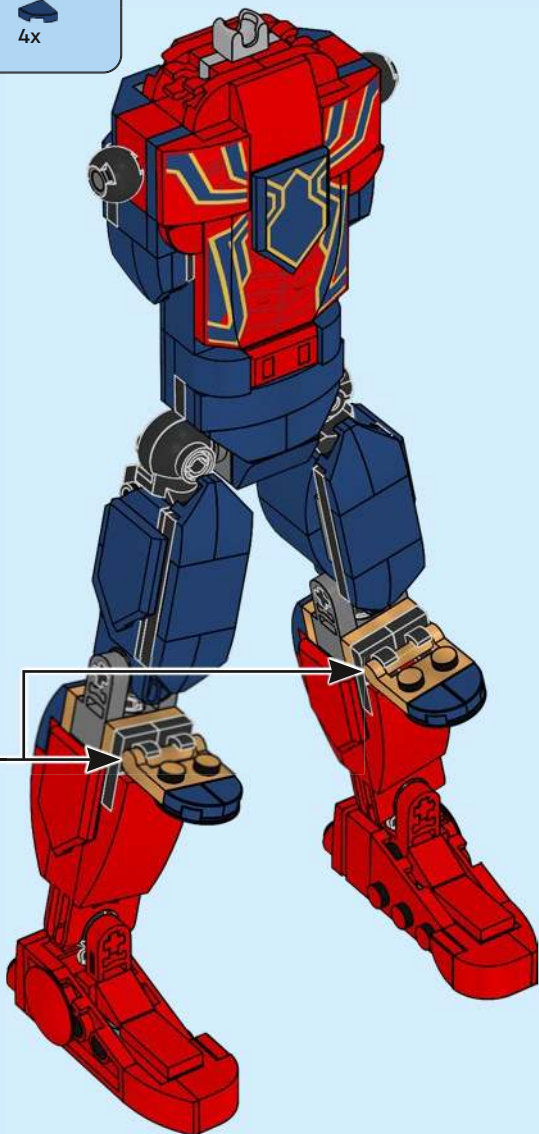
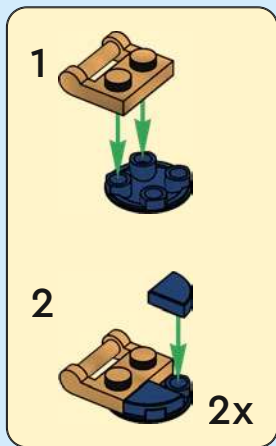



88

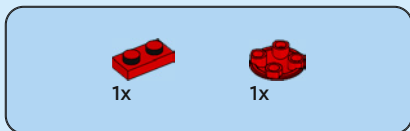

89

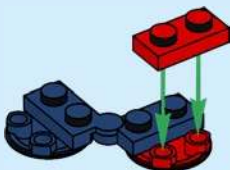



1x



1x

# 90



1x

# 91

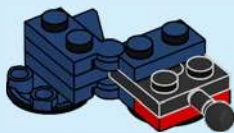



1x

92



1x

93

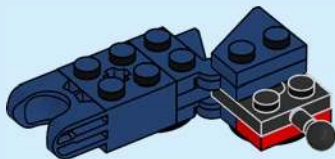



1x



1x

# 94

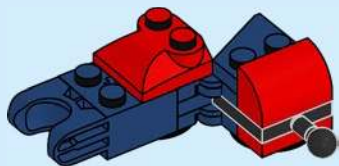

1x



1x

# 95

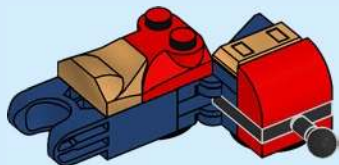

96

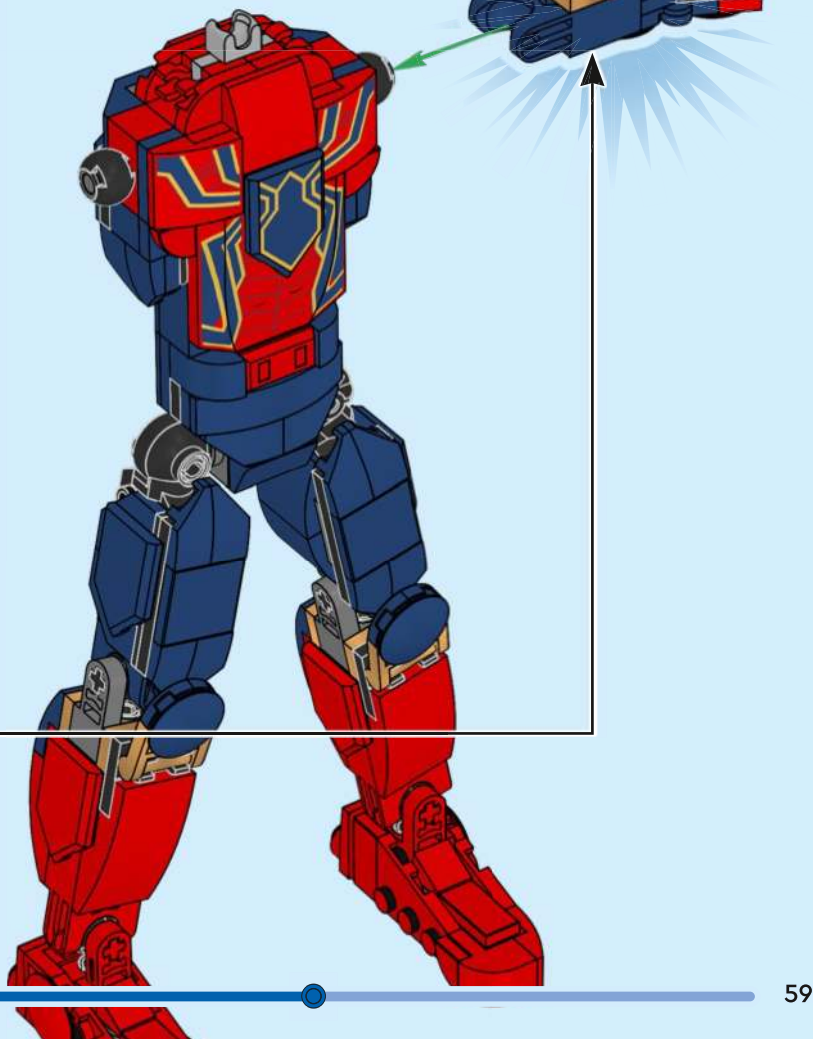

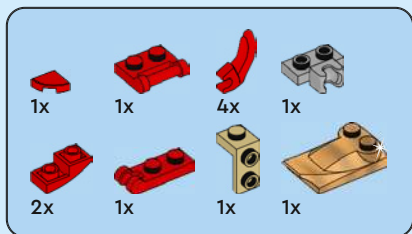

97

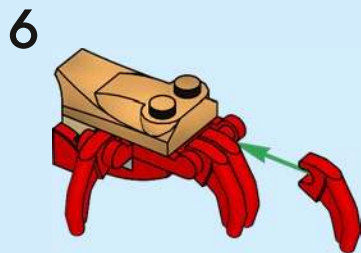
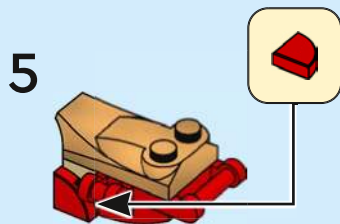
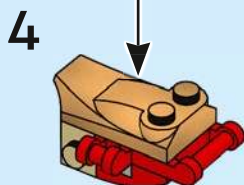
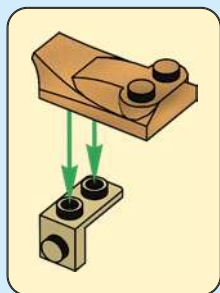
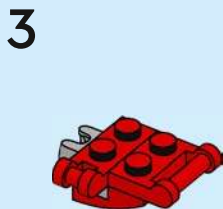
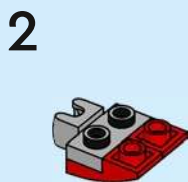
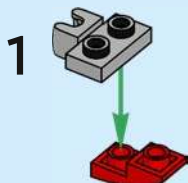

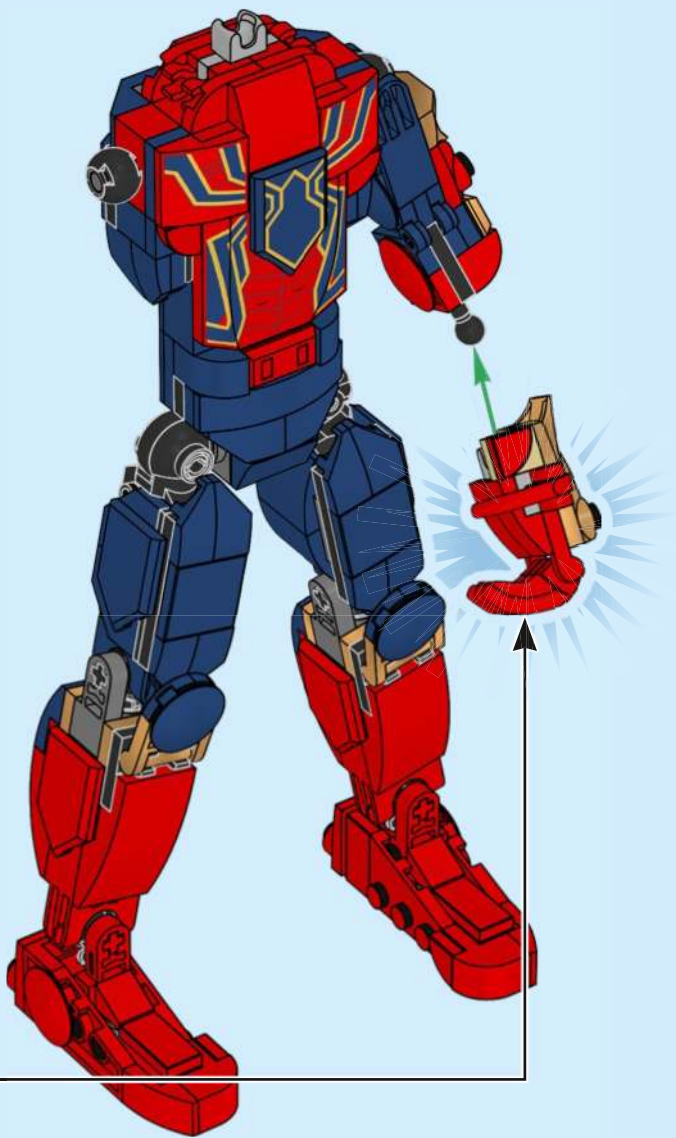



1x



1x

# 98

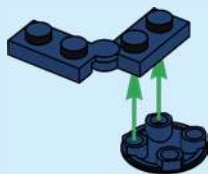

1x



1x

# 99

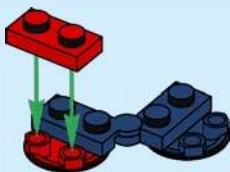



1x



1x

# 100



1x

# 101





1x

# 102

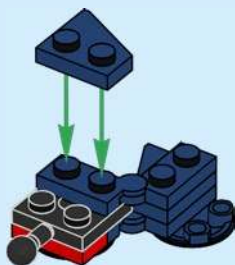

1x

# 103

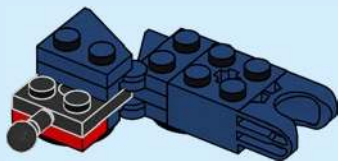



1x



1x

# 104

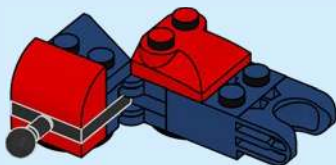

1x



1x

# 105

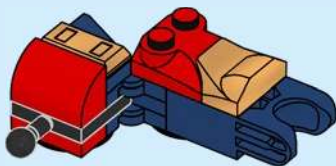

106



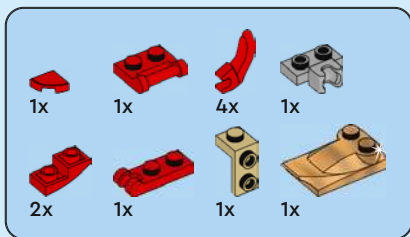

# 107

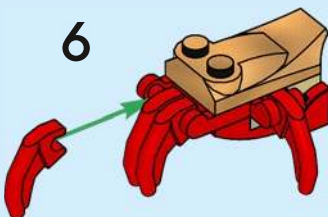
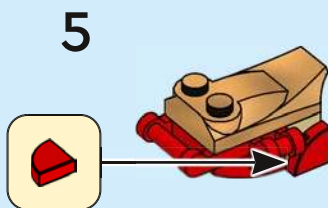
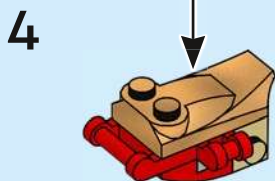
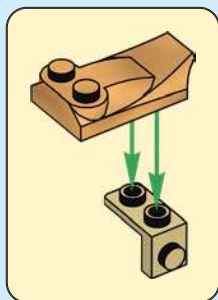
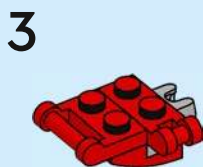
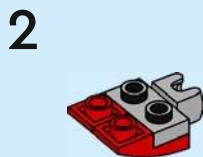
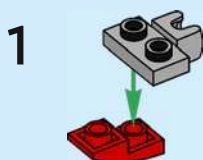

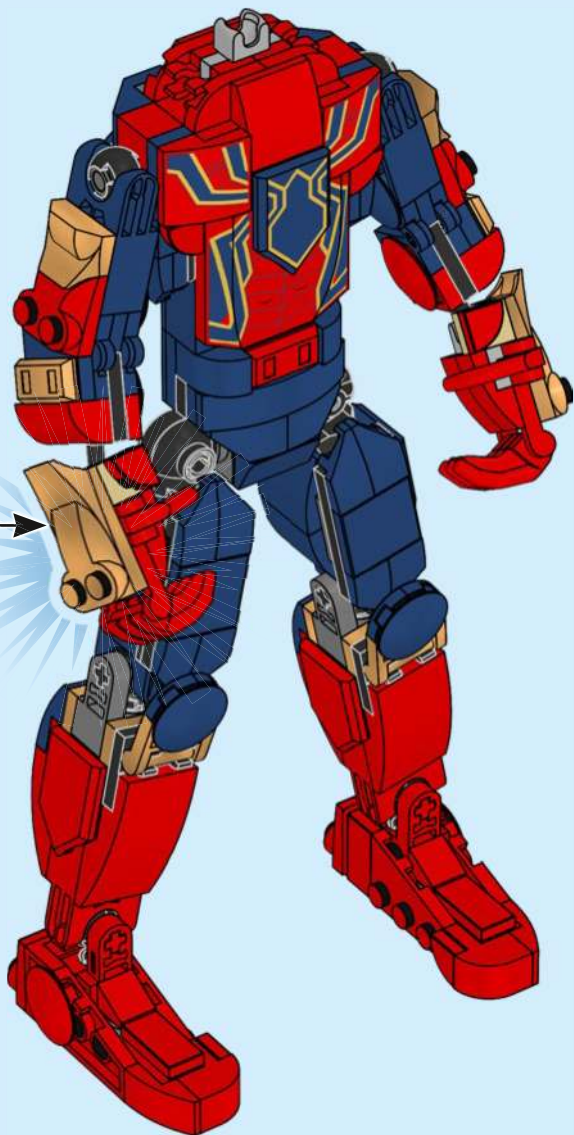



2x

108

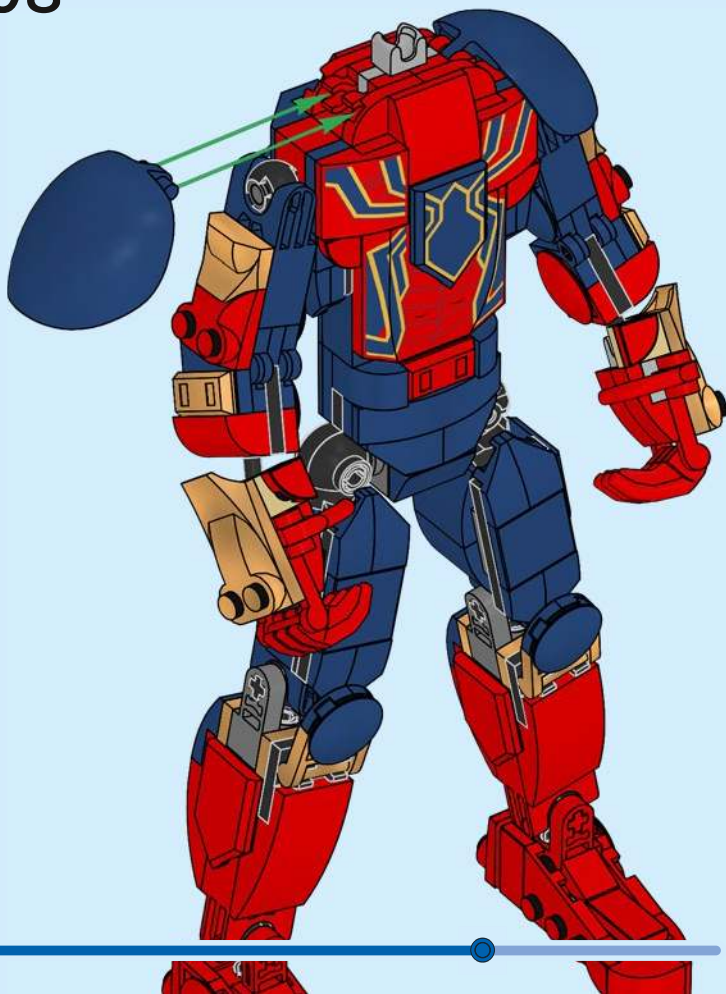

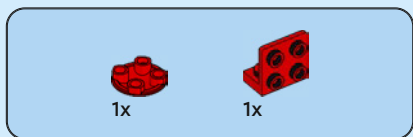

109

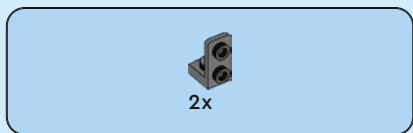
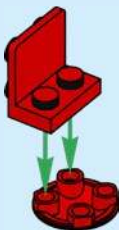

110





1x



1x

# 111

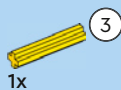
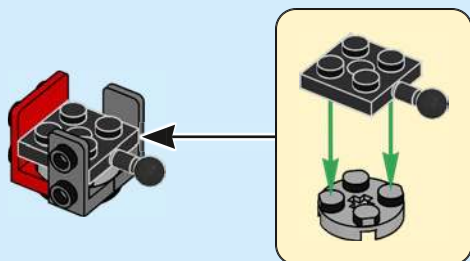

1x



1x



3

1:1

# 112

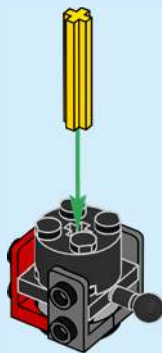



# 113

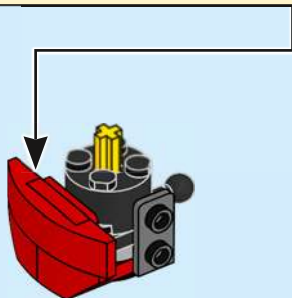
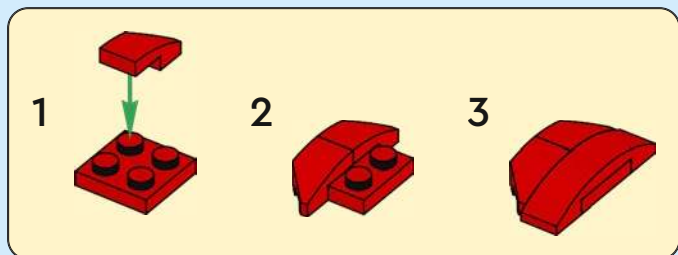

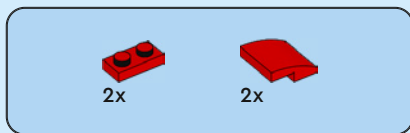

114

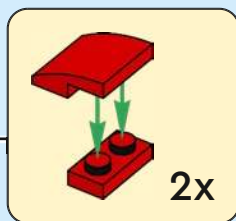
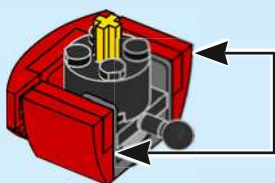

115



116



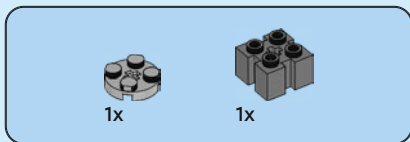

117

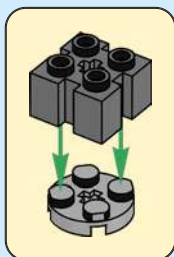



1x



1x

# 118

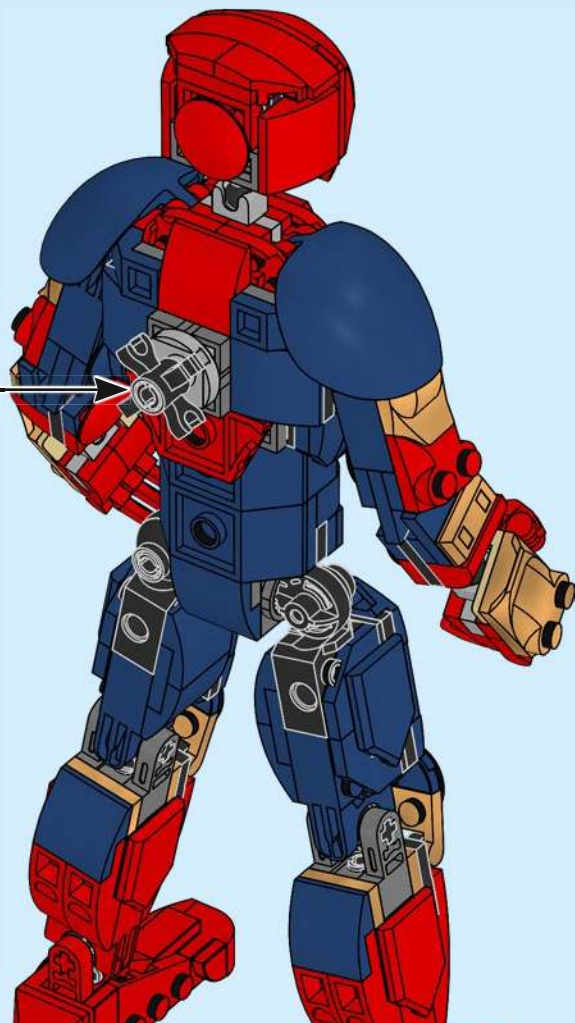
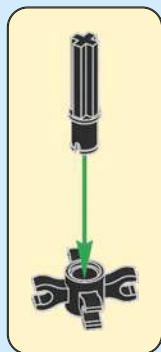

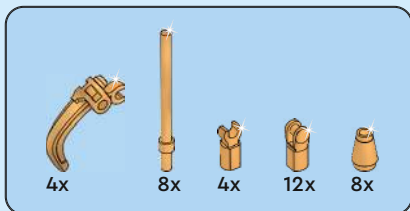

119

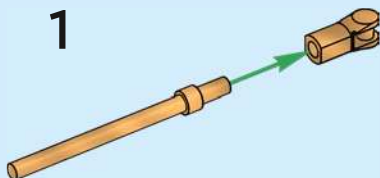

3

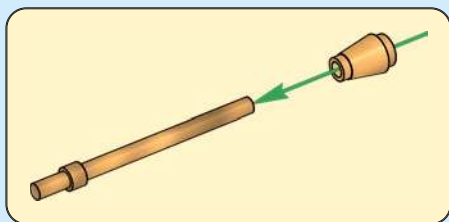
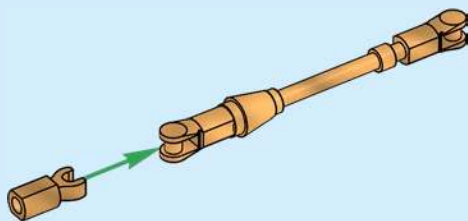

4

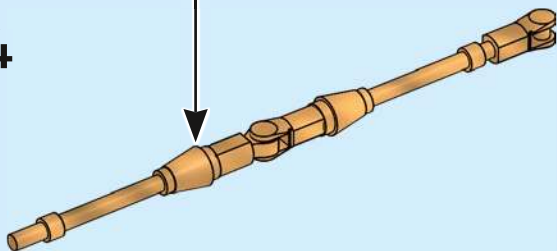

5

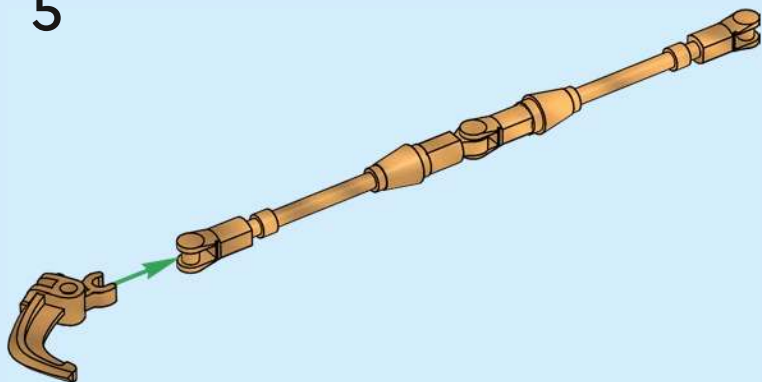

4x

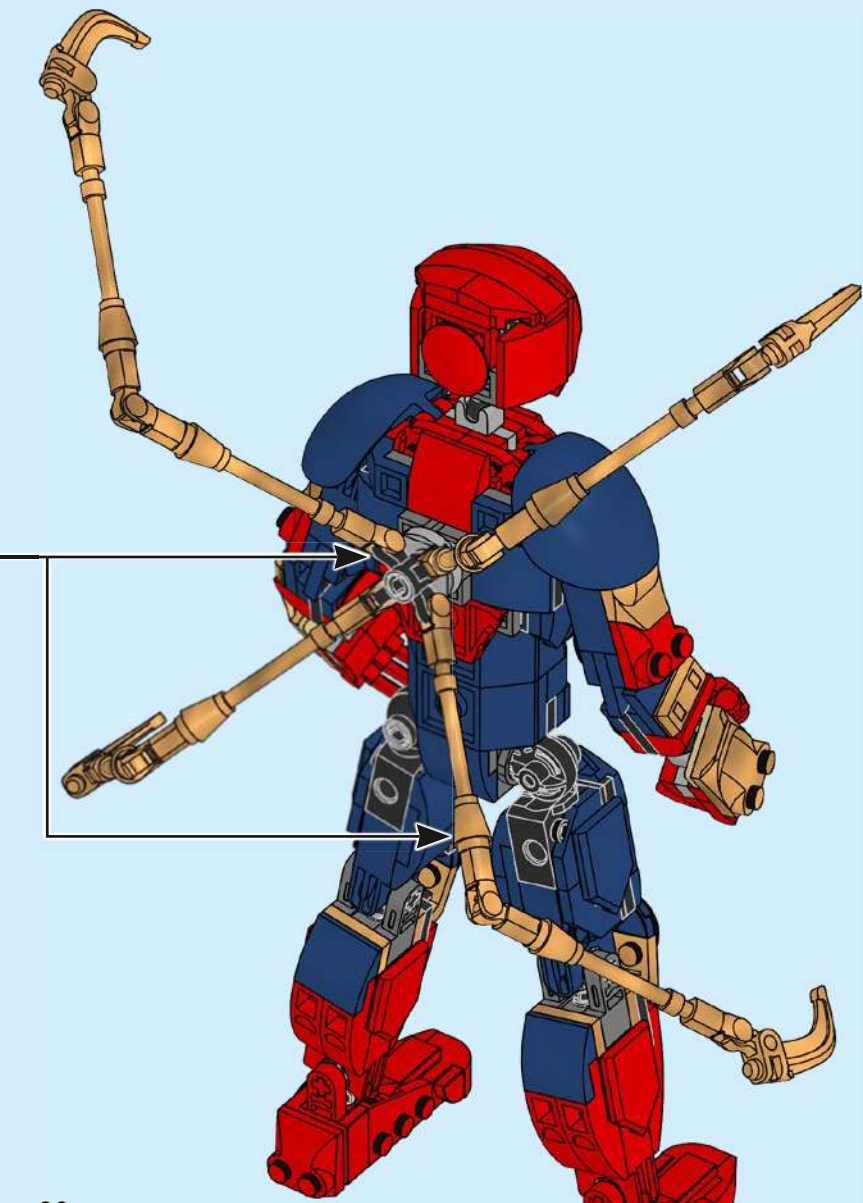





1x  
6360826



2x  
6374151



6x  
6170390



1x  
6177505



8x  
6438566



4x  
6187620



2x  
4504379



4x  
6337002



1x  
6177507



2x  
4180533



2x  
4180504



5x  
4278275



2x  
4142865



1x  
6394880



4x  
6196217



4x  
302321



2x  
6252037



6x  
6186398



4x  
306921



2x  
6019155



2x  
6184782



3x  
6001806



2x  
4226876



3x  
6105976



1x  
6482951



1x  
6482950



4x  
6384910



1x  
302221



4x  
4220515



1x  
6442314



2x  
4515365



4x  
6294045



2x  
6371957



1x  
6023770



1x  
4633914



4x  
6057432



2x  
6406930



2x  
4613174



1x  
302021



1x  
6482949



1x  
6482953



2x  
302324



4x  
370024



1x  
6130007



1x  
371024



6x  
4286267



2x  
302426



2x  
407026



2x  
6335317



4x  
6279875



2x  
4109810



1x  
614326



4x  
6347310



2x  
370026



1x  
6320293



2x  
4213374



1x  
6089119



3x  
6448318



2x  
6168620



2x  
6302828



2x  
302026



1x  
3200126



2x  
4211475



3x  
6043656



7x  
6214811



4x  
6199890

2x  
6224385

7x  
6214812

1x  
6216905

4x  
6440476

7x  
4528981

2x  
6411363

2x  
4249891

2x  
6470262

9x  
6470263

4x  
4528482

2x  
6228123

2x  
4205004

4x  
6166854

1x  
6482952

2x  
6224384

2x  
6245268

2x  
6438560

1x  
6037886

4x  
6479467

4x  
6416530

2x  
6475225

1x  
4508313

2x  
4210633

2x  
6336390

2x  
6398662

2x  
6000606

1x  
6236949

2x  
6324639

1x  
4211043

1x  
4497253

2x  
6083620

1x  
6186825

8x  
6170470

4x  
6252838

12x  
6296657

8x  
4529247

2x  
6375715

2x  
6207933

2x  
4585493

7x  
6347982

4x  
6253900

2x  
6357918

4

 [LEGO.com/service](https://www.LEGO.com/service)



YOU COULD  
**WIN**



Scan this QR code or go to  
**LEGO.COM/PRODUCTFEEDBACK**  
and give us your short feedback  
about this LEGO® set for a chance  
to win a cool LEGO prize.

Terms and Conditions apply\*



**EN: YOU COULD WIN.** Terms and Conditions apply\* **DE: Du könntest GEWINNEN.** Es gelten die Teilnahmebedingungen\* **FR: Tu pourrais GAGNER.** Des conditions s'appliquent\* **IT: Potresti VINCERE tu.** Termini e condizioni sono applicabili\* **ES: Puedes GANAR.** Aplican términos y condiciones\* **PT: Poderá GANHAR.** Aplicam-se termos e condições\* **ZH: 轻松获奖. 条款和条件适用\*** **PL: Szansa na WYGRANĄ.** Obowiązują warunki korzystania\* **CS: Máte šanci VYHRÁT.** Platí všeobecné smluvní podmínky\* **SK: Máte šancu VYHRAŤ.** Platia všeobecné zmluvné podmienky\* **HU: TE IS NYERHETSZ.** Felhasználási feltételek érvényesek\* **RO: Ai putea CÂȘTIGA.** Se aplică termeni și condiții\* **BG: Можете да СПЕЧЕЛИТЕ.** Има определени правила и условия\* **LV: Tu vari LAIMĒT.** Ir spēkā noteikumi un nosacījumi.\* **ET: Sul on võimalus VÕITA.** Kehtivad tingimused\* **LT: Jūs galite LAIMĖTI.** Taikomos sąlygos\*

\*[LEGO.com/productfeedback-terms](https://www.lego.com/productfeedback-terms)

LEGO and the LEGO logo are trademarks of the LEGO Group. ©2024 The LEGO Group.

© Marvel © CPH