



MARVEL

76292





LEGO® Builder



LEGO.com/sustainable-packaging



FR
DONNEZ
OU
RECYCLEZ

 OU  OU 

ASSOCIATION MAGASIN DÉCHÈTERIE

Adresses sur quefairedemesdechets.fr

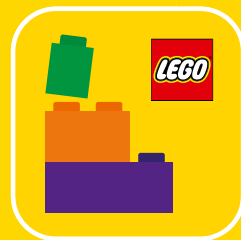

Q LEGO® Builder

BUILDER



Apple and the Apple logo are trademarks of Apple Inc., registered in the U.S. and other countries and regions. App Store is a service mark of Apple Inc. Google Play and the Google Play logo are trademarks of Google LLC. Tencent and the Tencent logo are trademarks of Tencent Inc.

Q [LEGO.com/devicecheck](https://www.lego.com/devicecheck)

EN Ask parents' permission before going online | **DE** Eltern um Erlaubnis bitten, bevor du online gehst | **FR** Demande l'autorisation d'un parent avant d'aller en ligne | **IT** Chiedi il permesso ai tuoi genitori prima di andare online | **ES** Pídeles permiso a tus papás antes de conectarte a Internet | **PT** Pede autorização aos pais antes de acederes online | **ZH** 上网前应先征得父母的同意 | **PL** Poproś rodziców o zgodę, zanim wejdiesz do Internetu | **CS** Než půjdeš na internet, požádej rodiče o svolení | **SK** Skôr než pôjdeš na internet, vypýtaj si povolenie od rodičov | **HU** Kérj szülői engedélyt, mielőtt online csatlakoznál! | **RO** Cere permisiunea părinților înainte de a te conecta online | **BG** Поискайте разрешение от родител, преди да влезете онлайн | **LV** Pirms došanās tiešsaistē palūdz atļauju vecākiem | **ET** Enne Interneti kasutamist küsi vanematelt luba | **LT** Prieš prisijungdami prie interneto, atsiklauskite tėvų

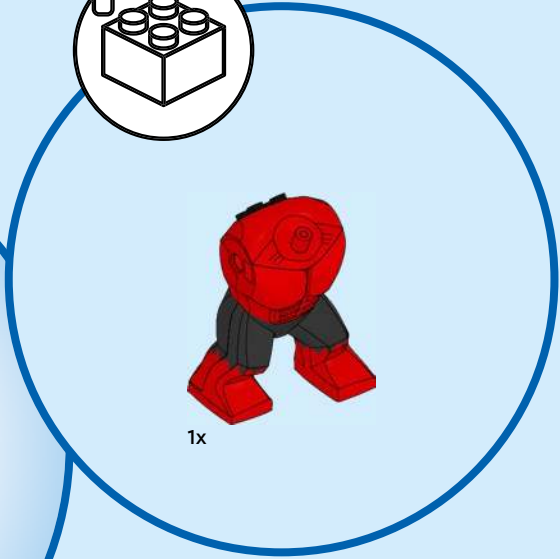
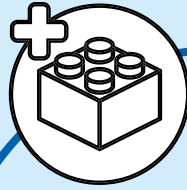

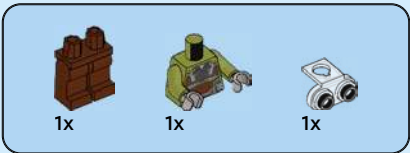

1

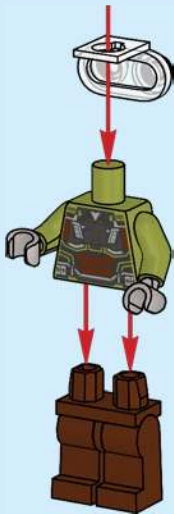

2

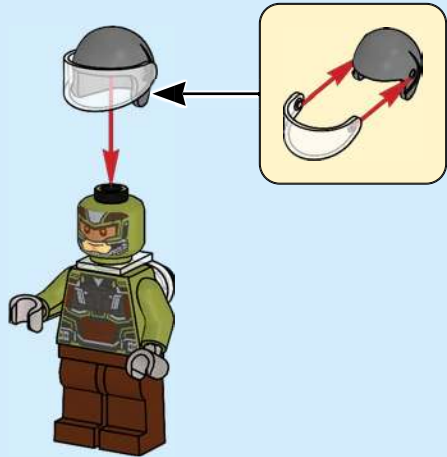



3

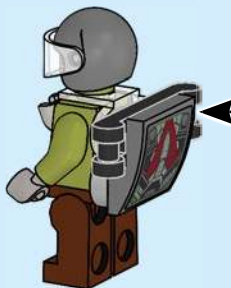
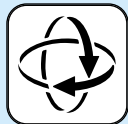
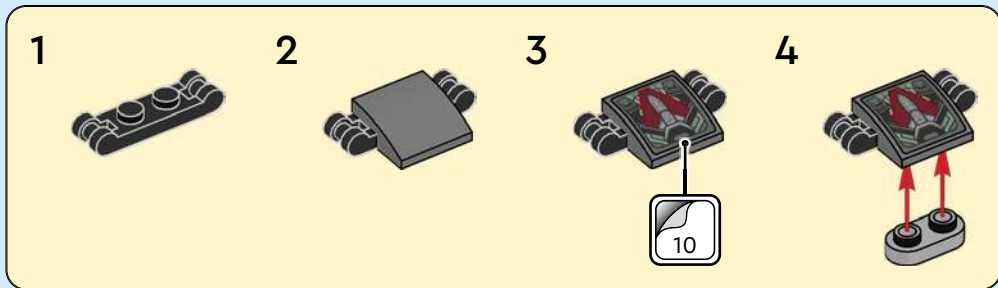

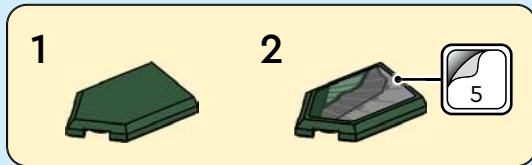
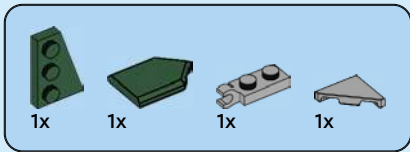

4

1



2



3



4



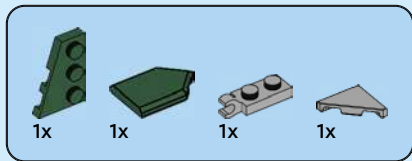

5

1

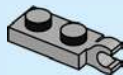

2

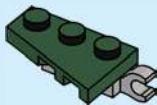

3



4

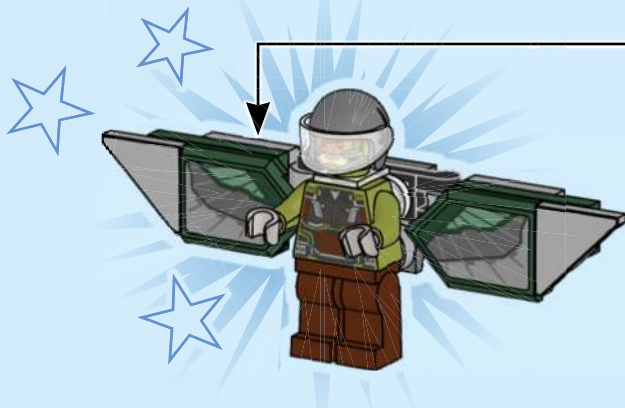

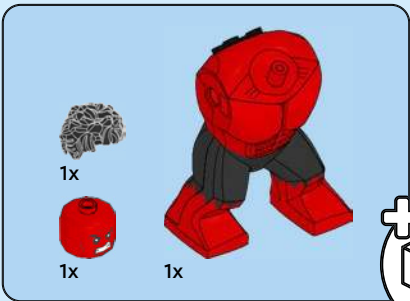

1

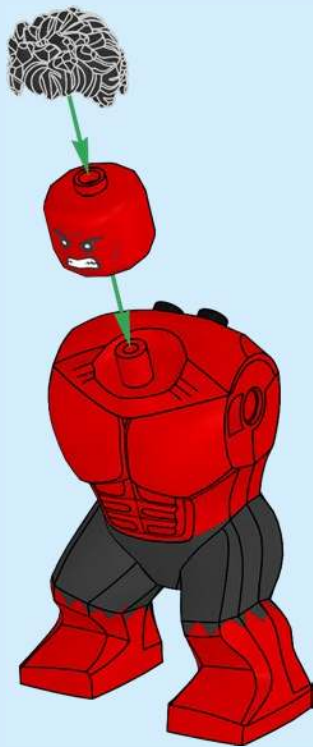

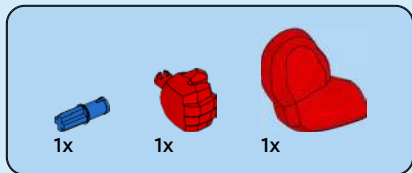

2

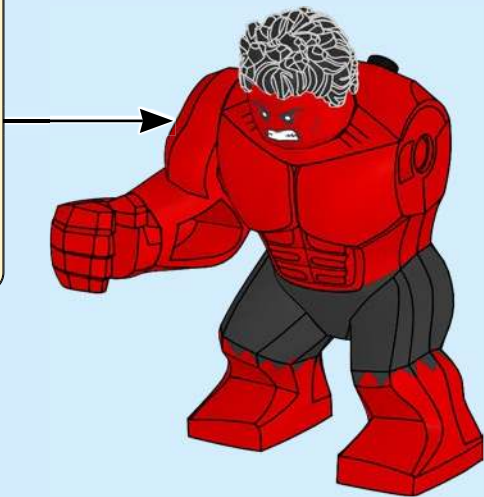
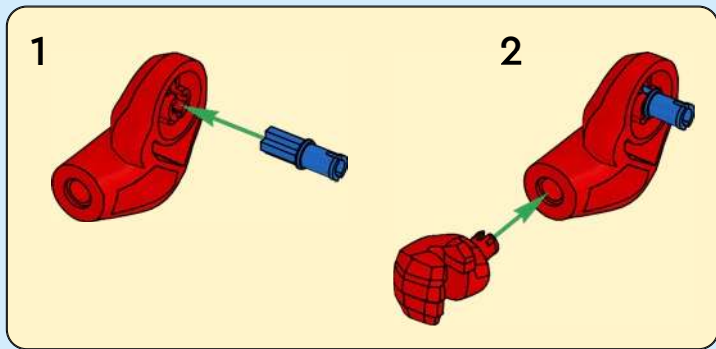

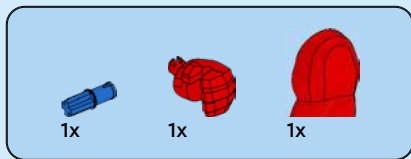

3

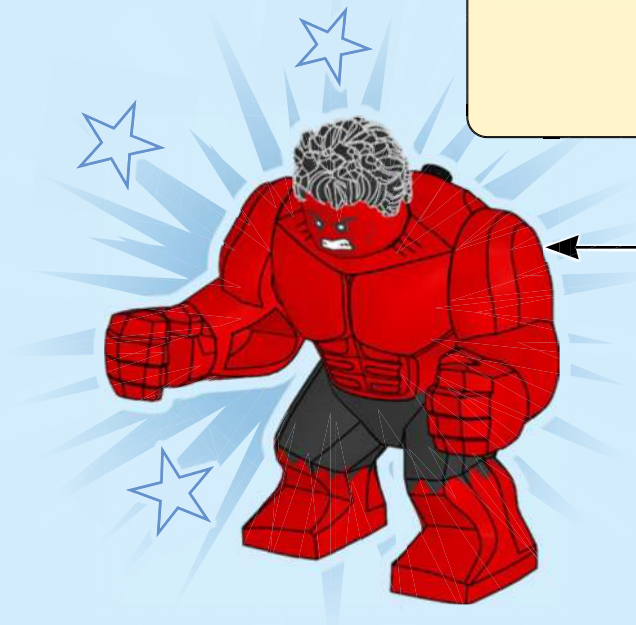
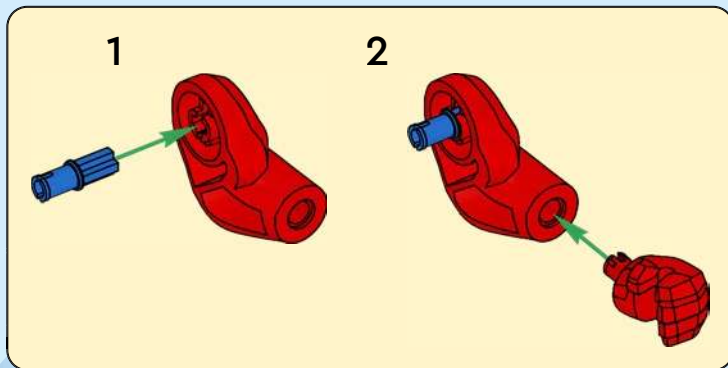

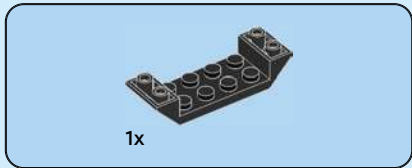
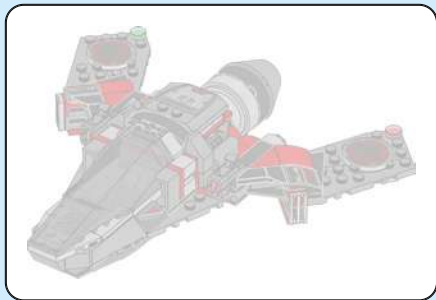

1

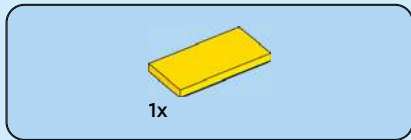
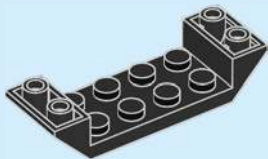

2

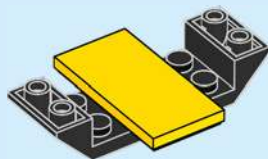

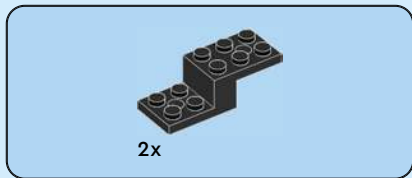

3

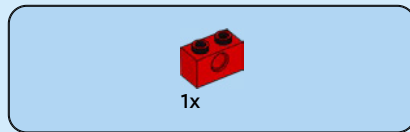
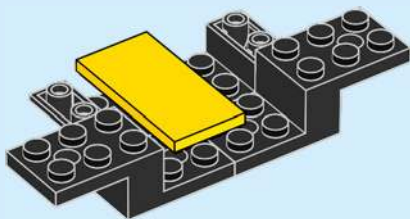

4

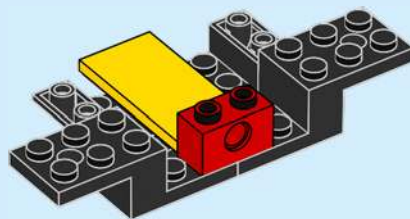

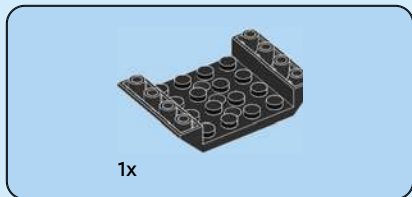

5

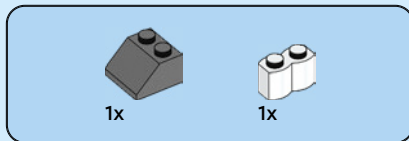
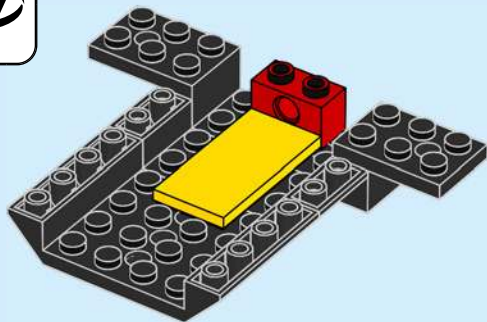

6

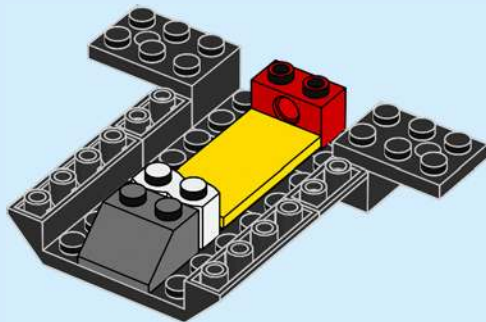

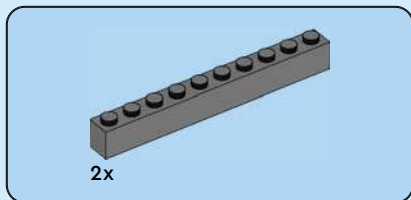

7

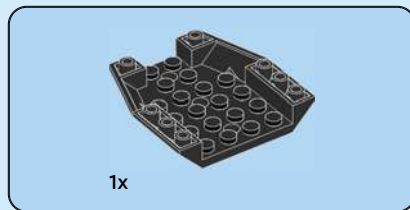
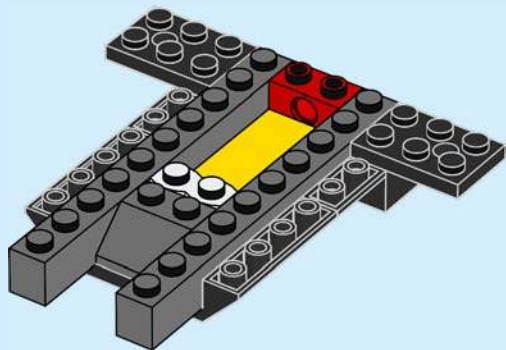

8

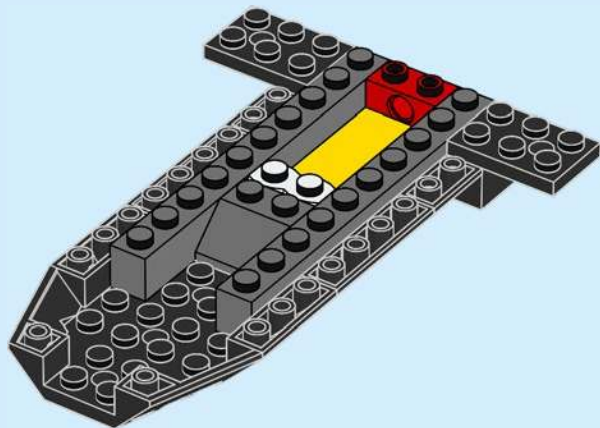



9

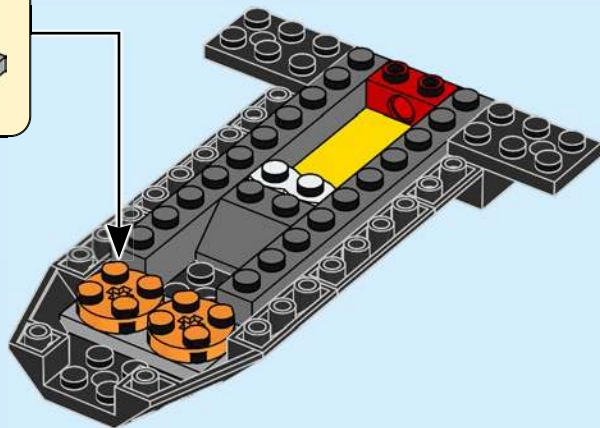
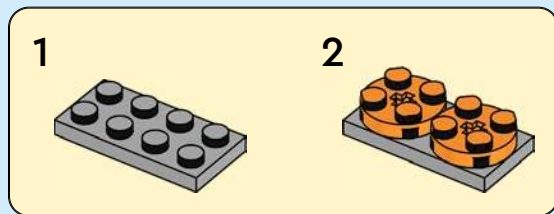

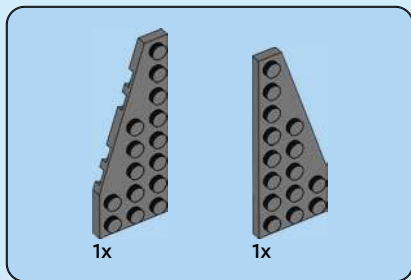

10

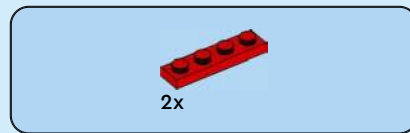

11

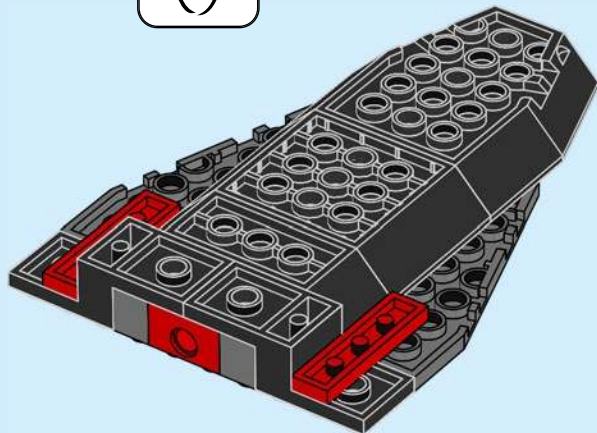

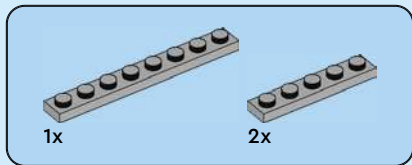

12

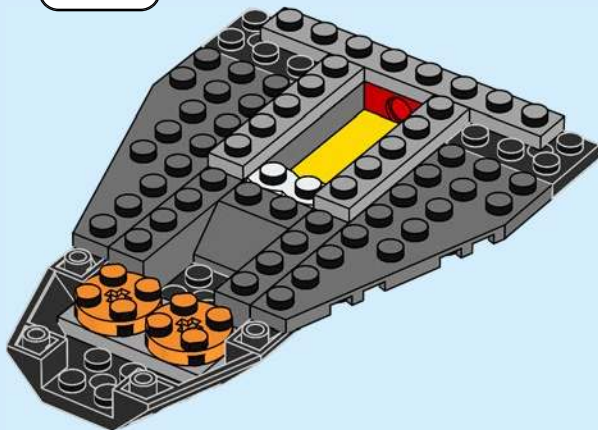
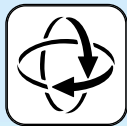



2x

13



2x

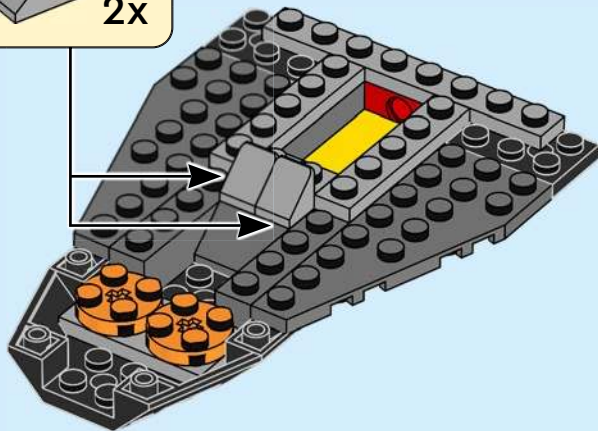

2x



2x

14

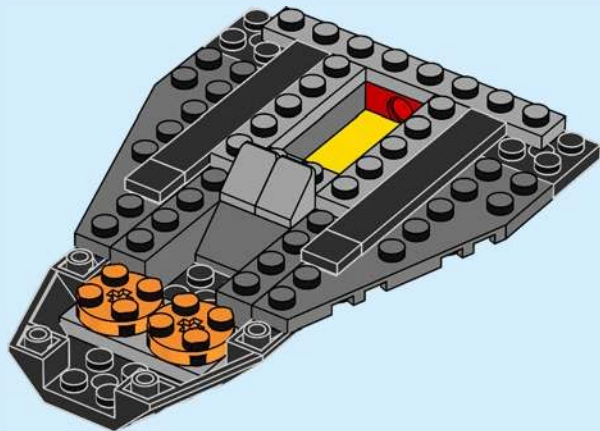

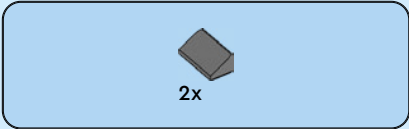

15

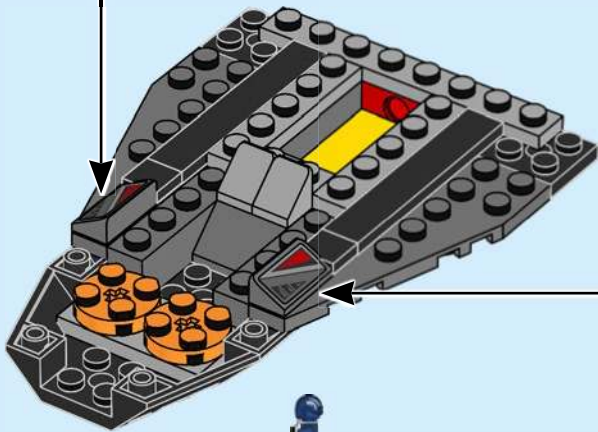
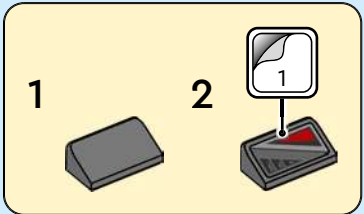
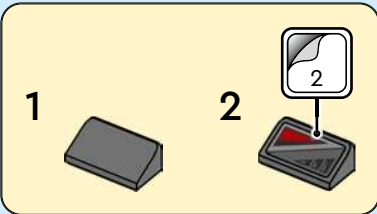

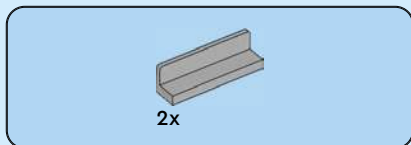

16

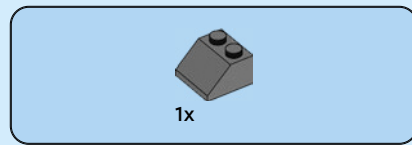
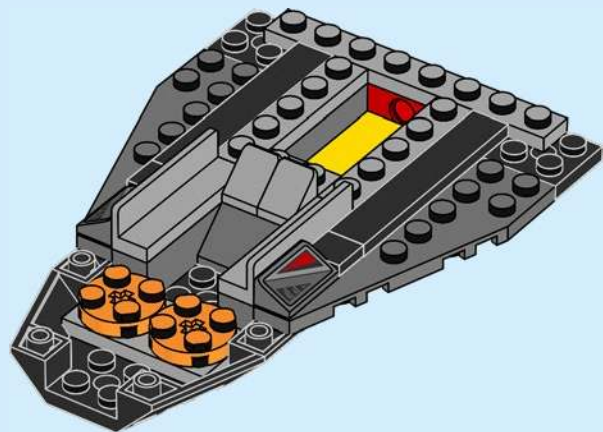

17

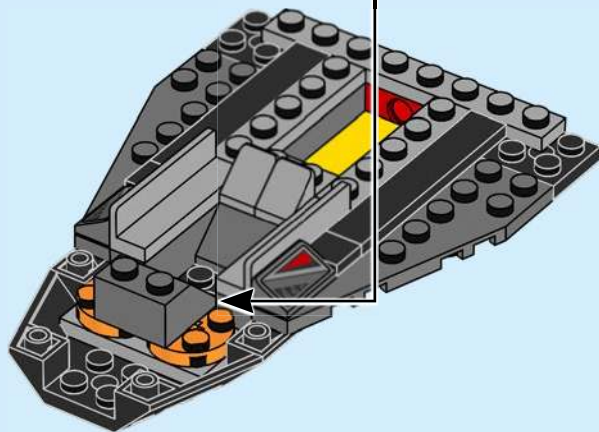
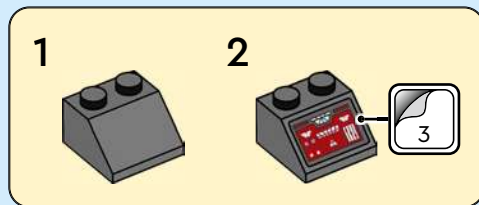

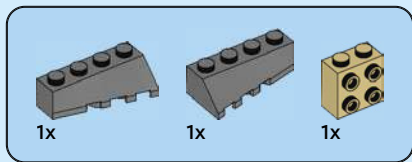

18

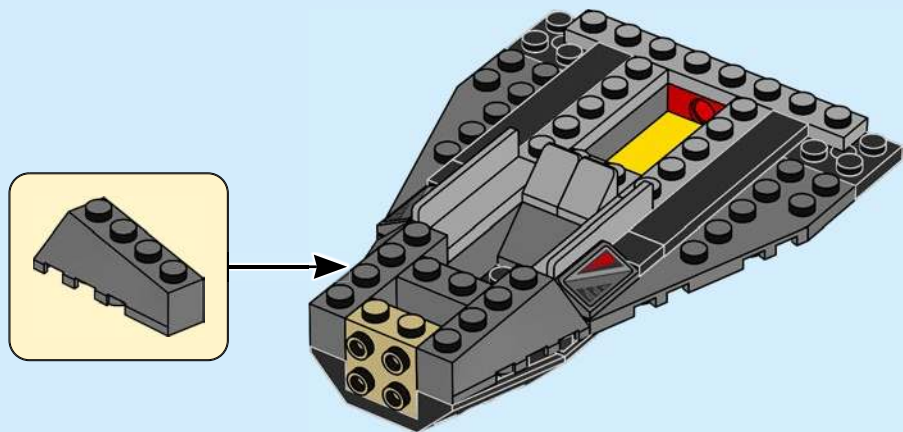



1x

19

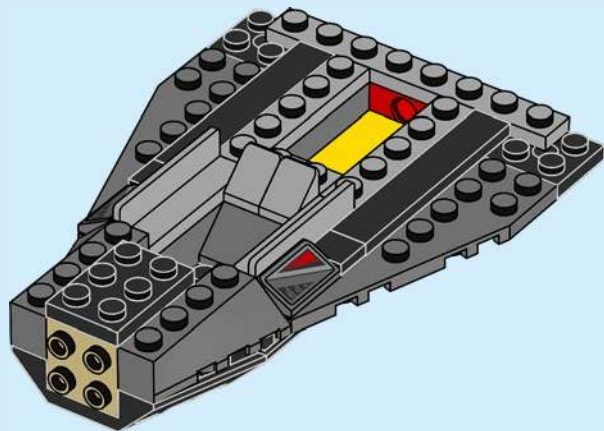

2x

20



2x

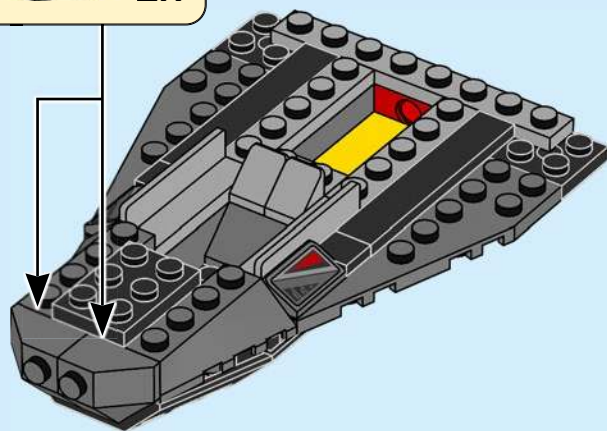



1x

21

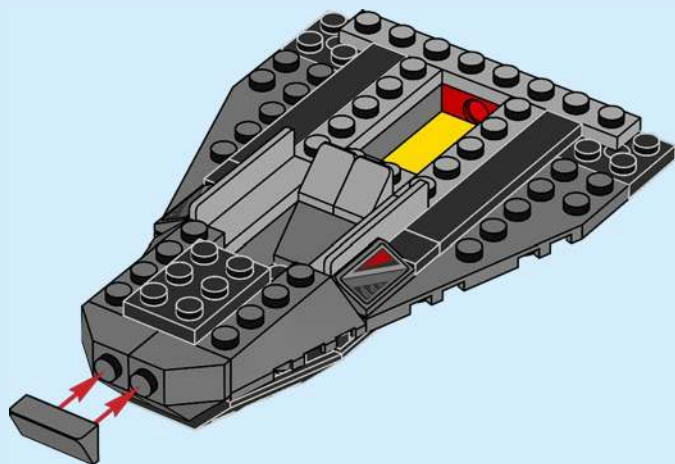

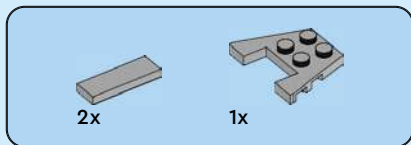

22

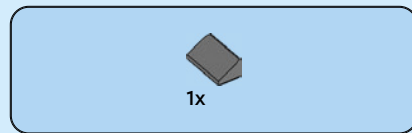
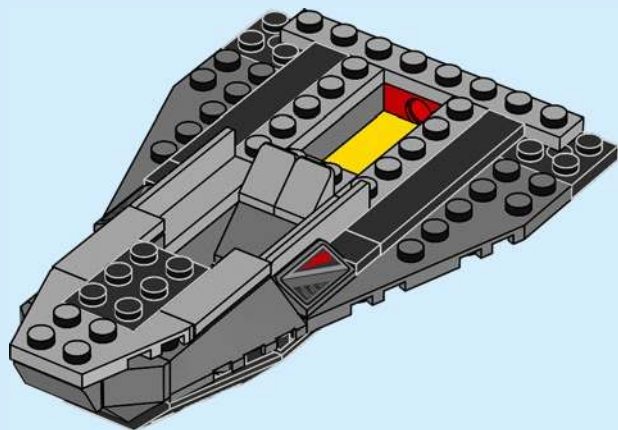

23

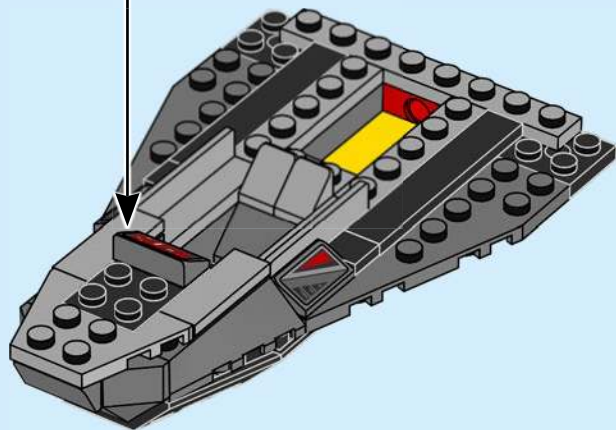
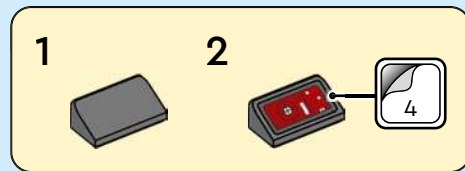

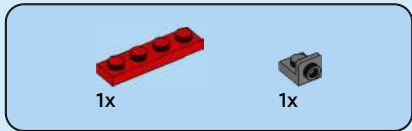

24

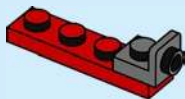

25

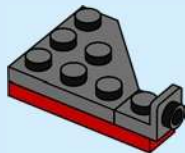

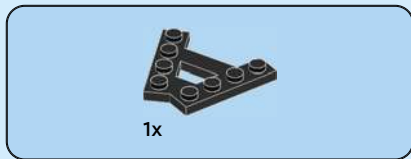

26

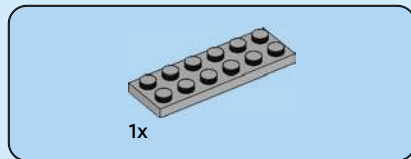
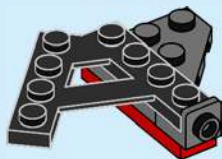

27

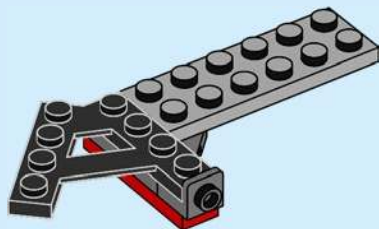

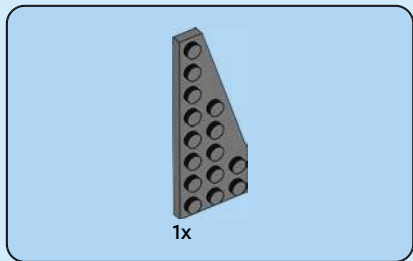

28

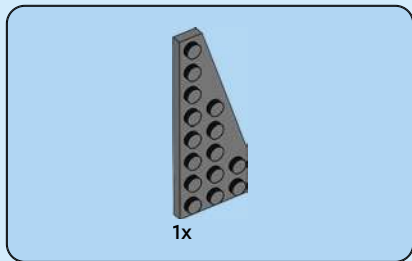
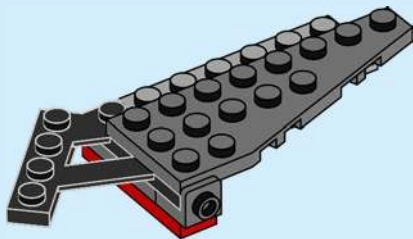

29

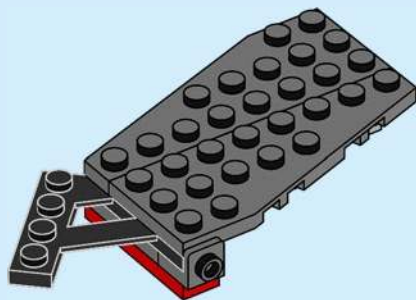

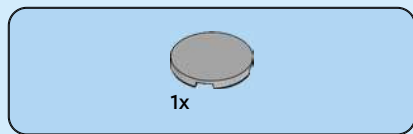

30

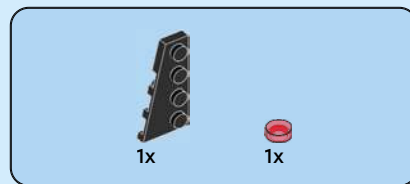
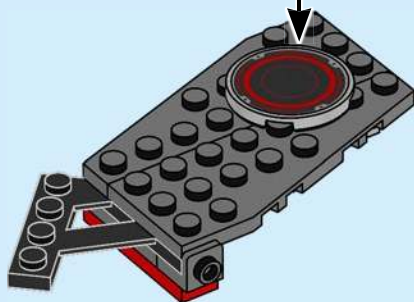
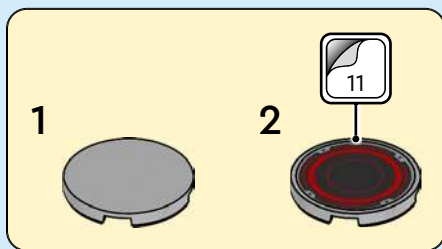

31



32

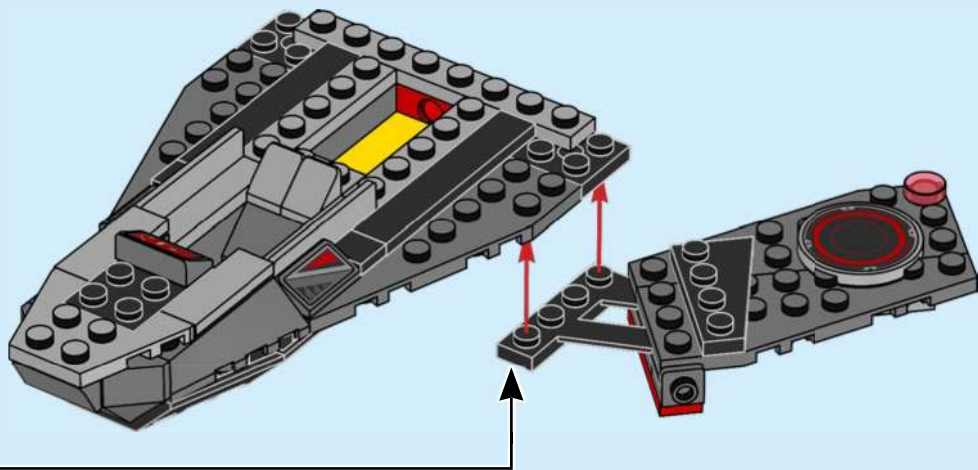

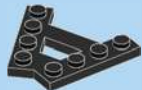

1x

33

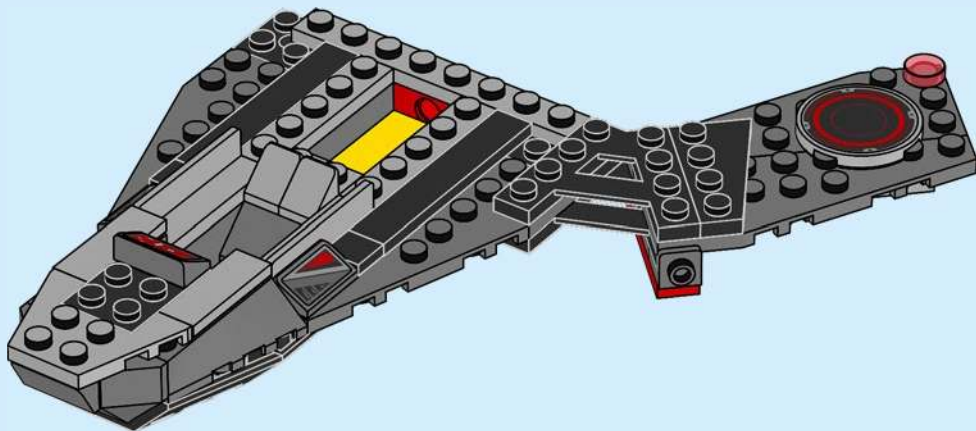



1x

34

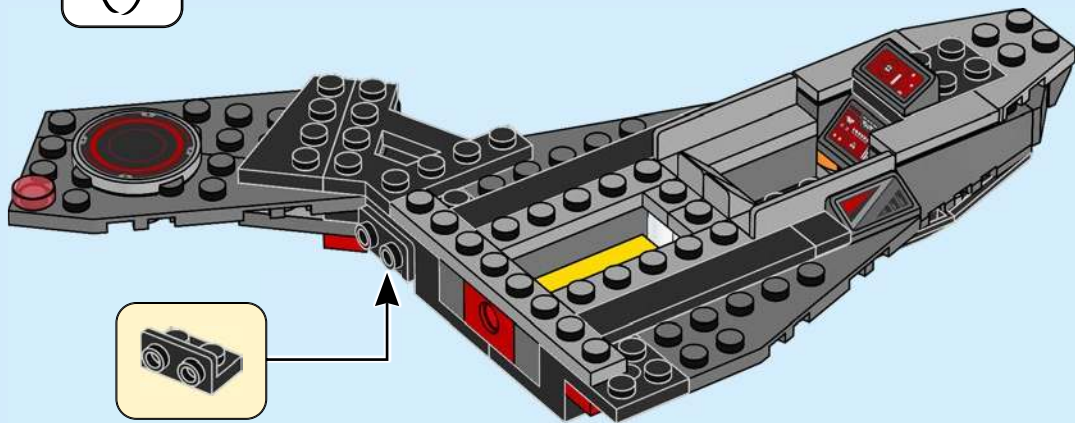



1x



1x

35

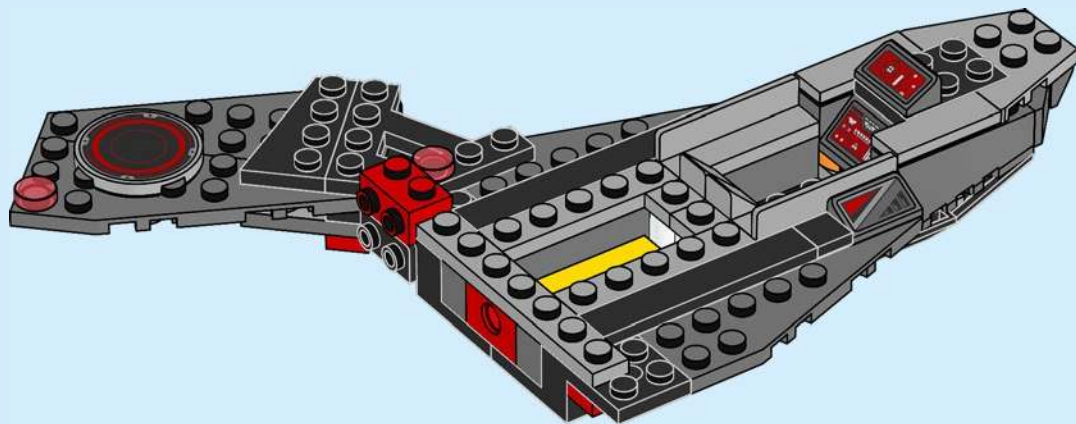



1x



1x

36

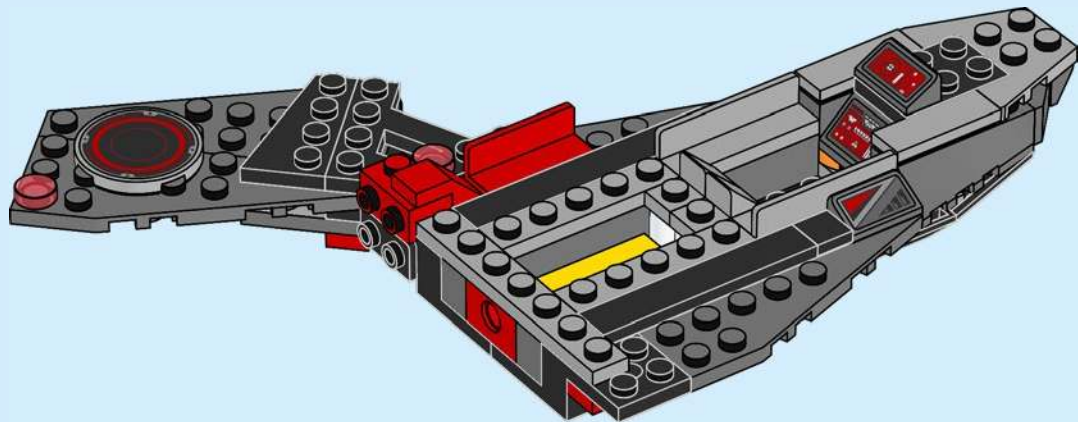



1x



1x

37

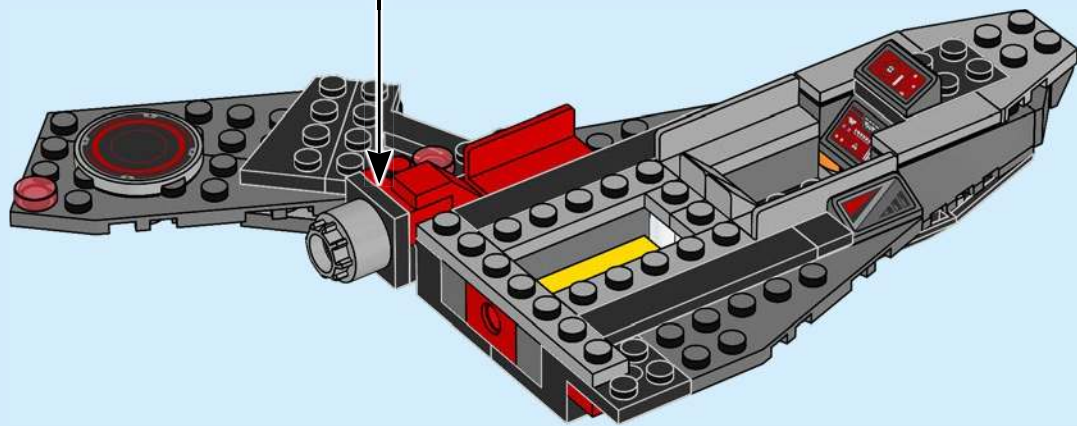
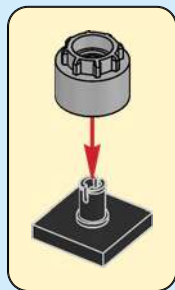

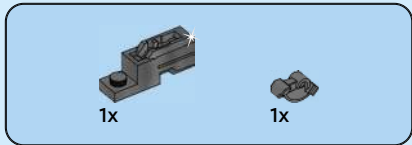

38

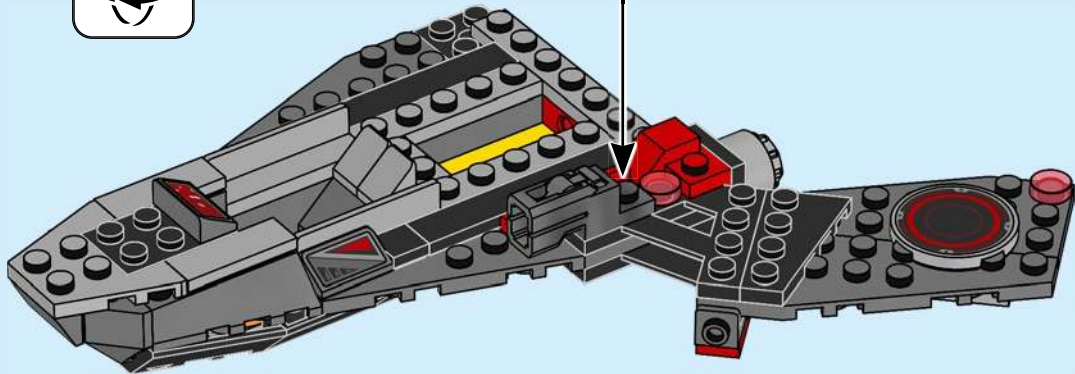
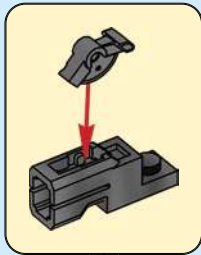
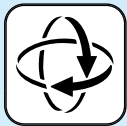



1x



1x

39

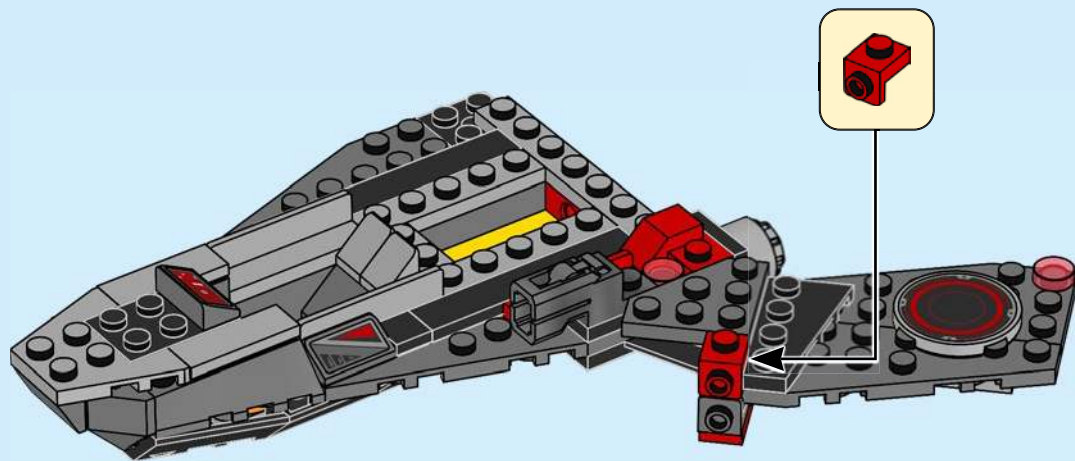

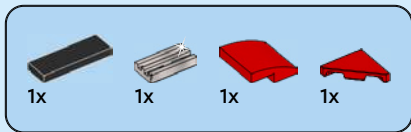

40

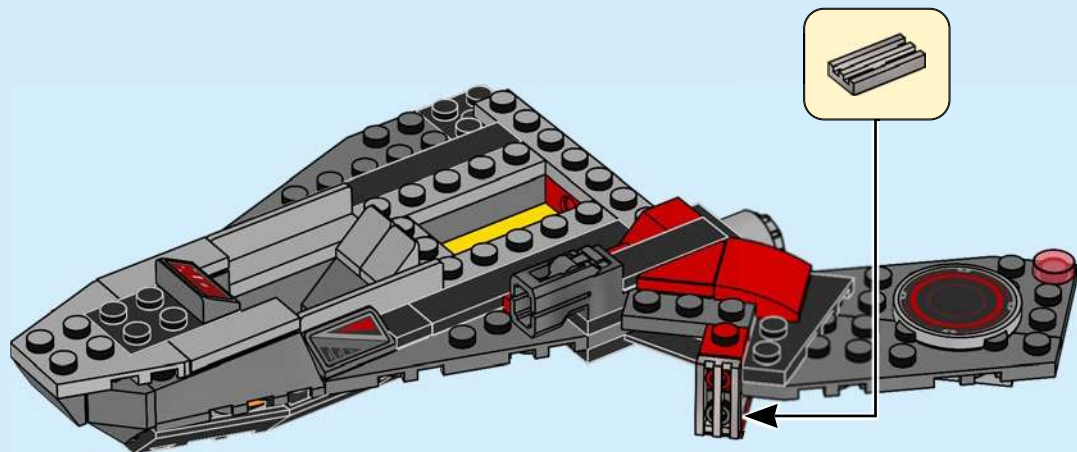

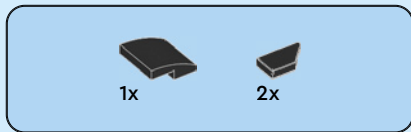

41

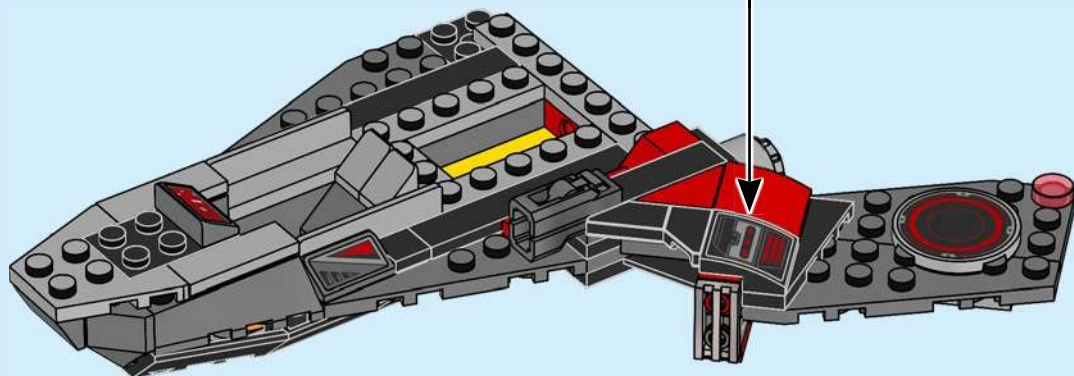

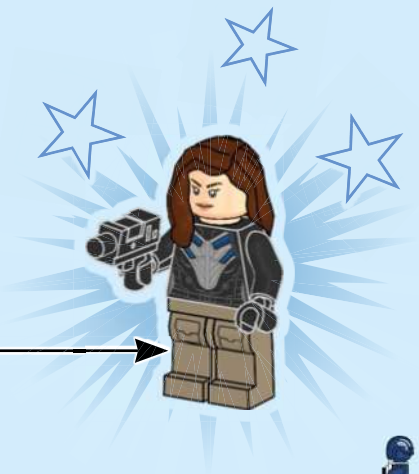
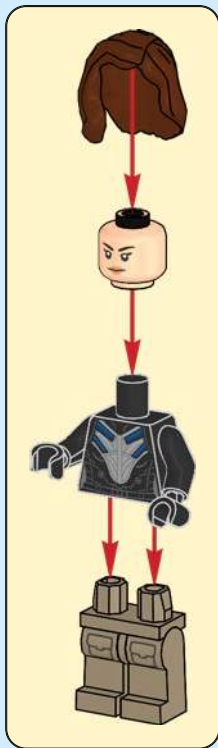

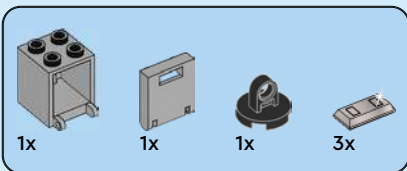

1

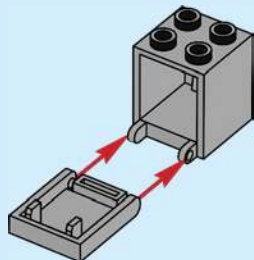

2

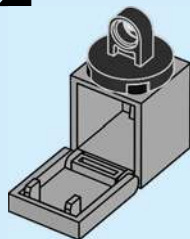

3

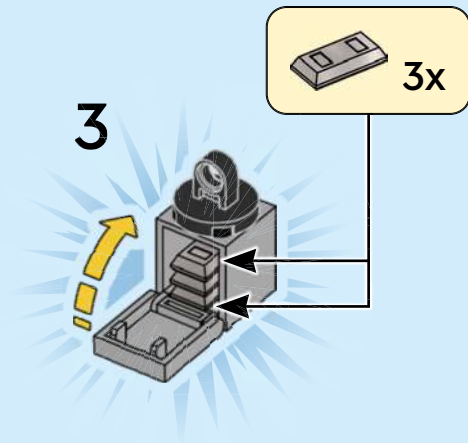

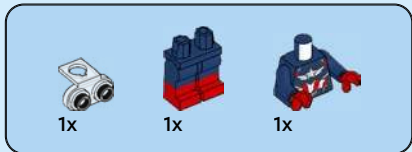

1



2



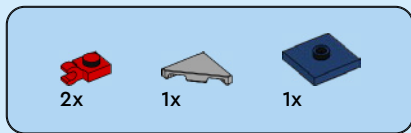

3

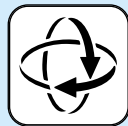
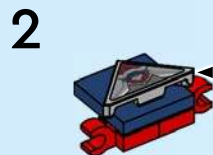
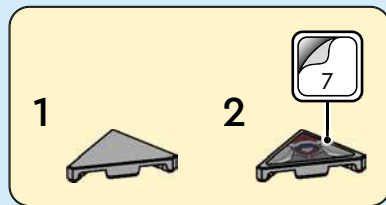
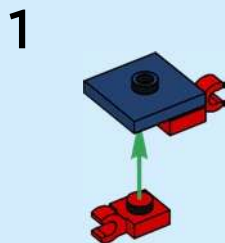

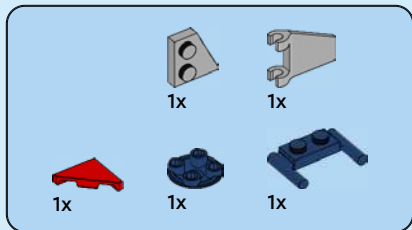

4

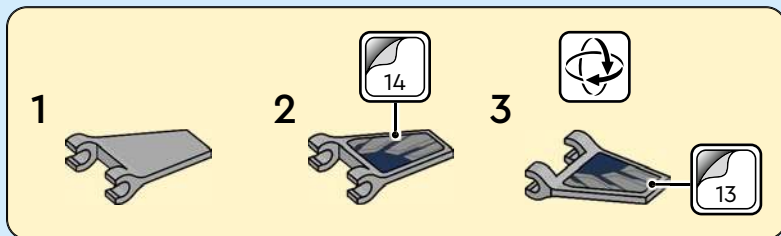

1

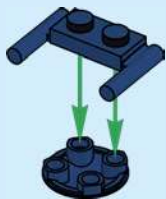

2



3



4



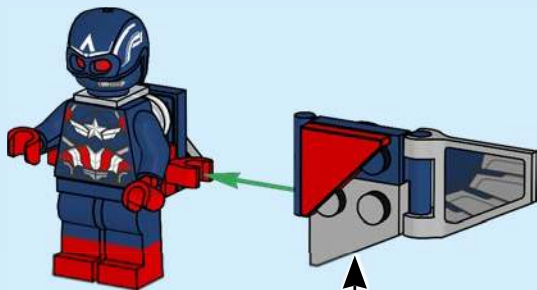

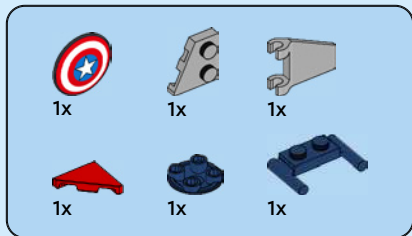

5

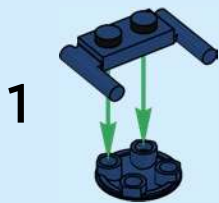
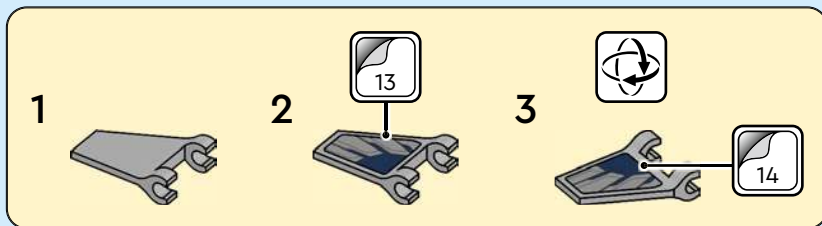

2



3



4

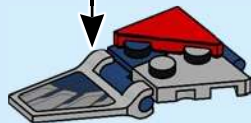



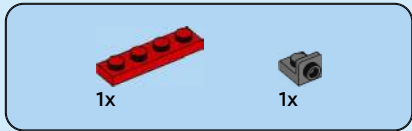

42

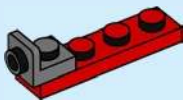

43

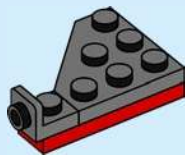

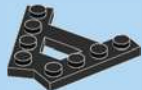

1x

44

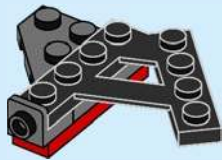

1x

45

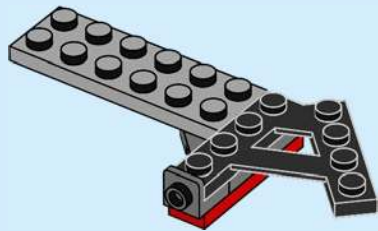

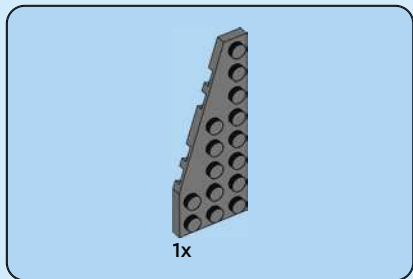

46

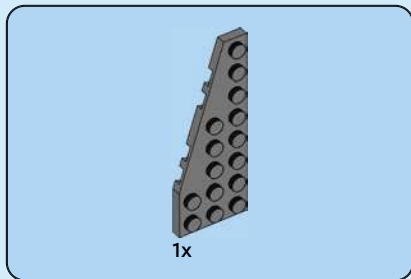
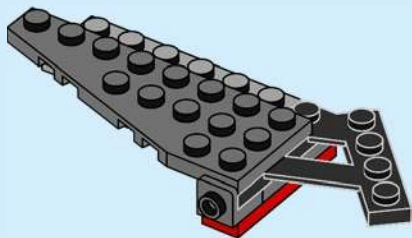

47

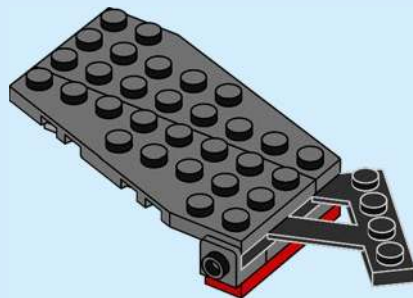

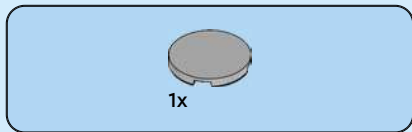

48

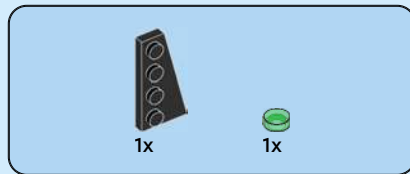
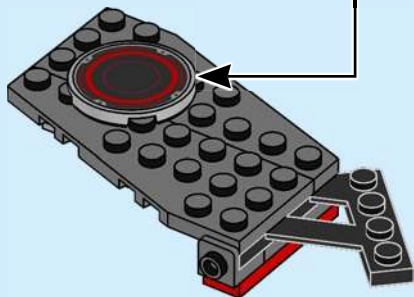
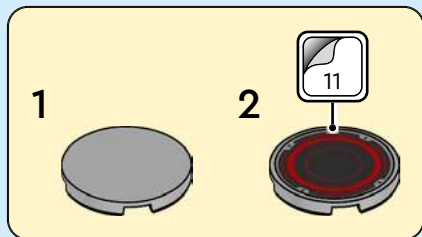

49



50

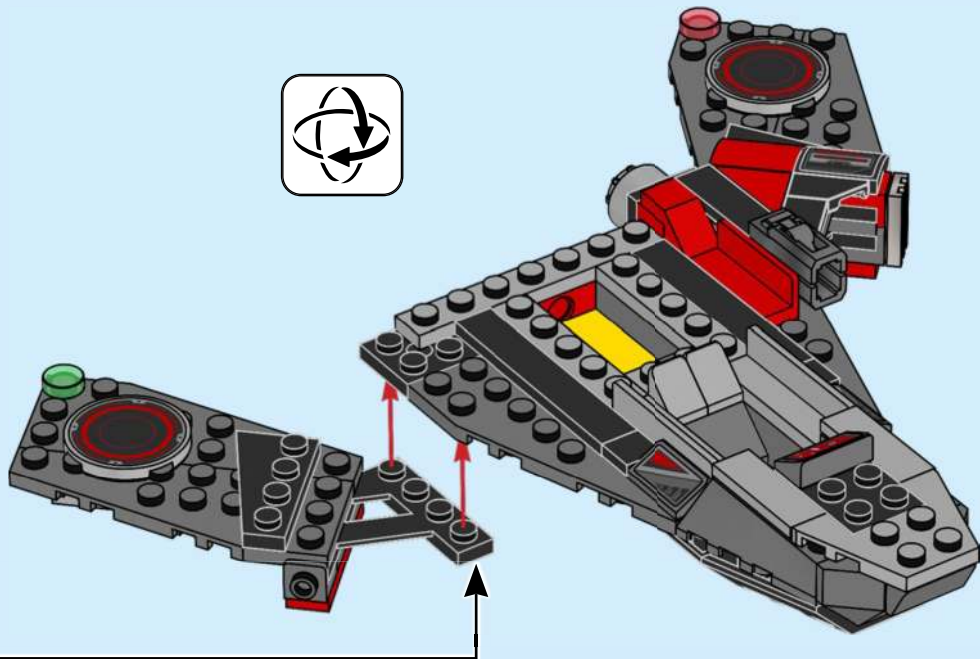
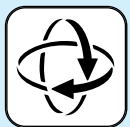

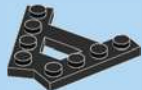

1x

51

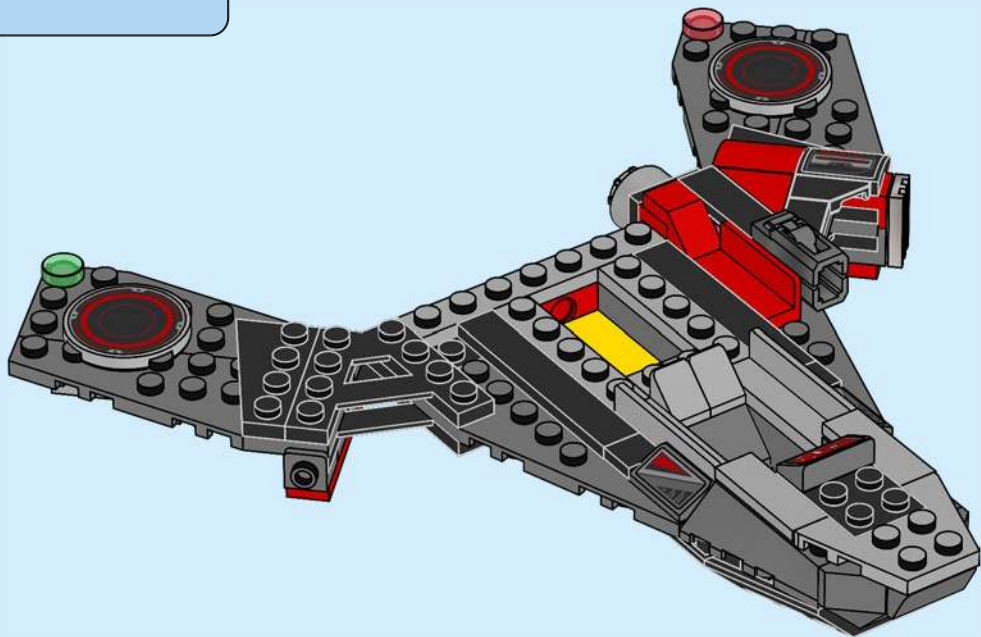



1x

52

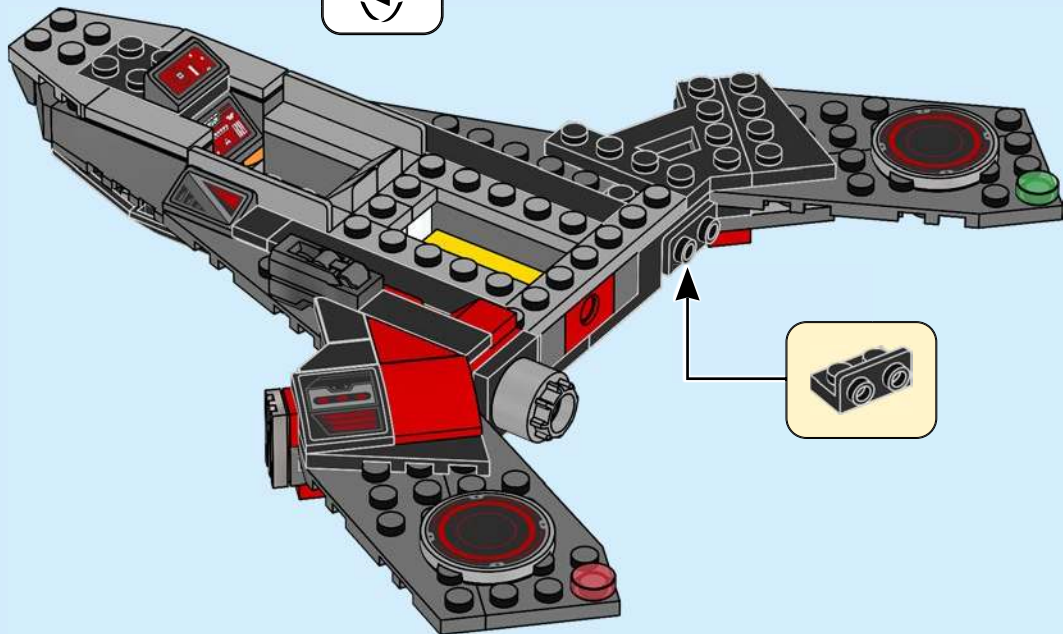



1x



1x

53

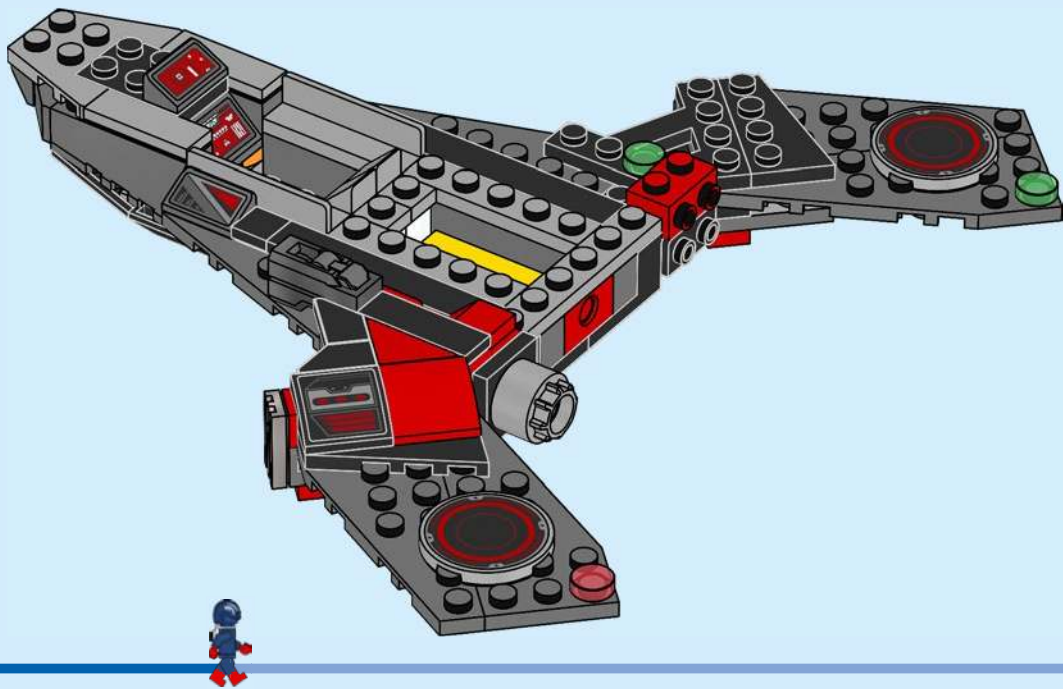



1x



1x

54

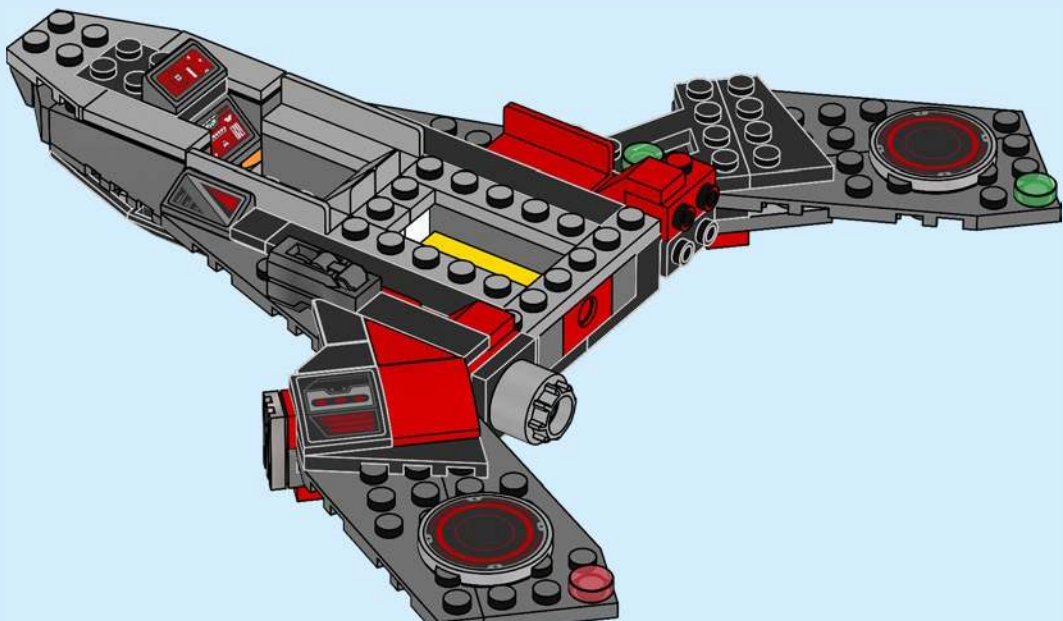



1x



1x

55

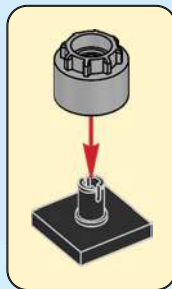



56

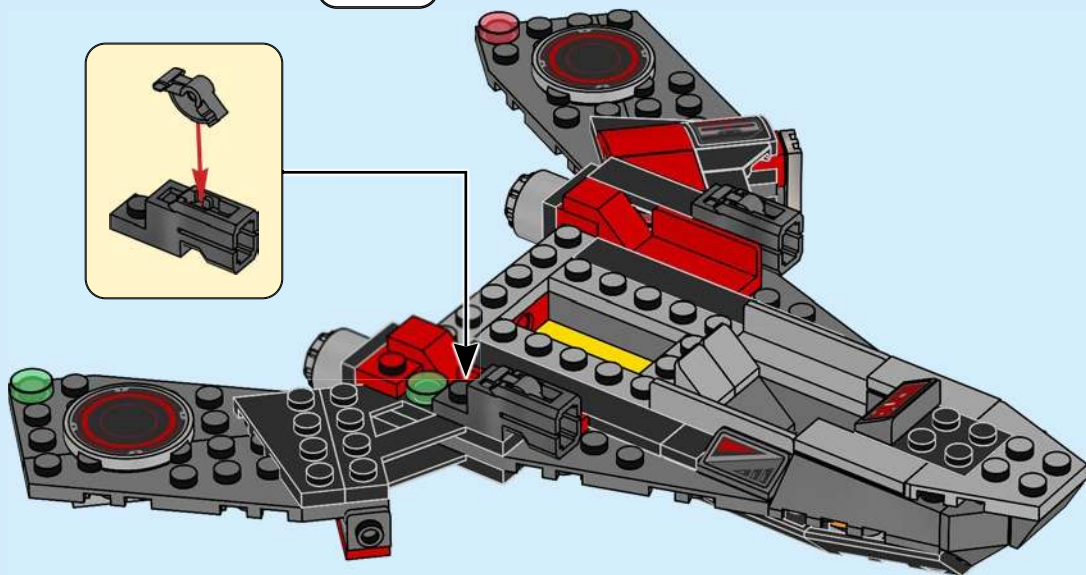
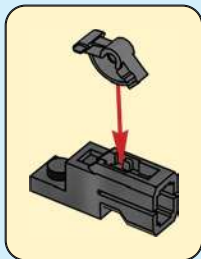



1x



1x

57

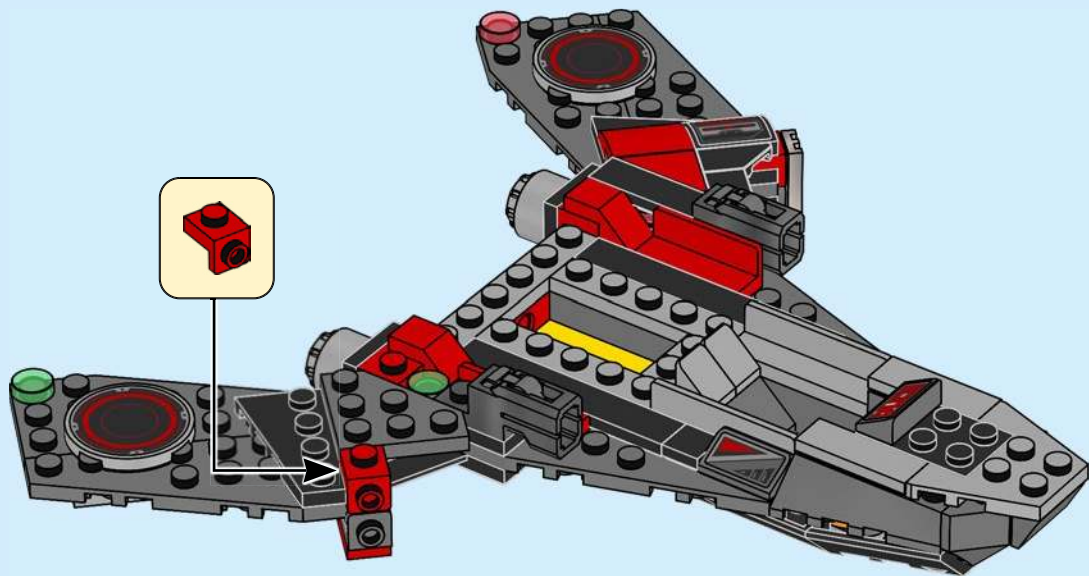

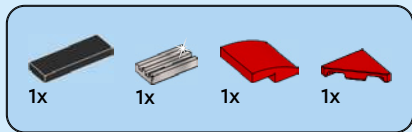

58

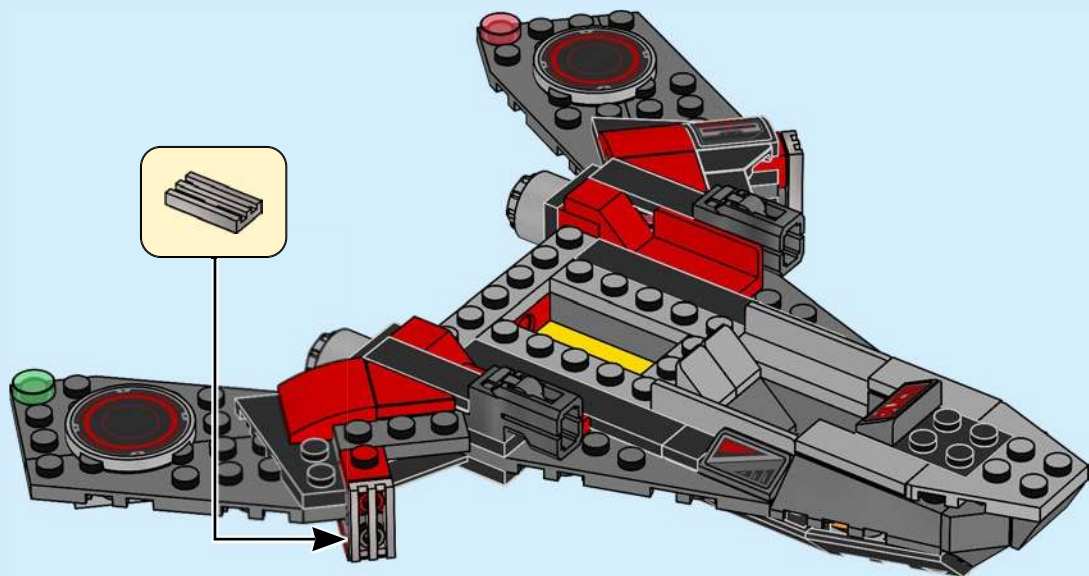

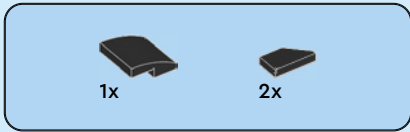

59

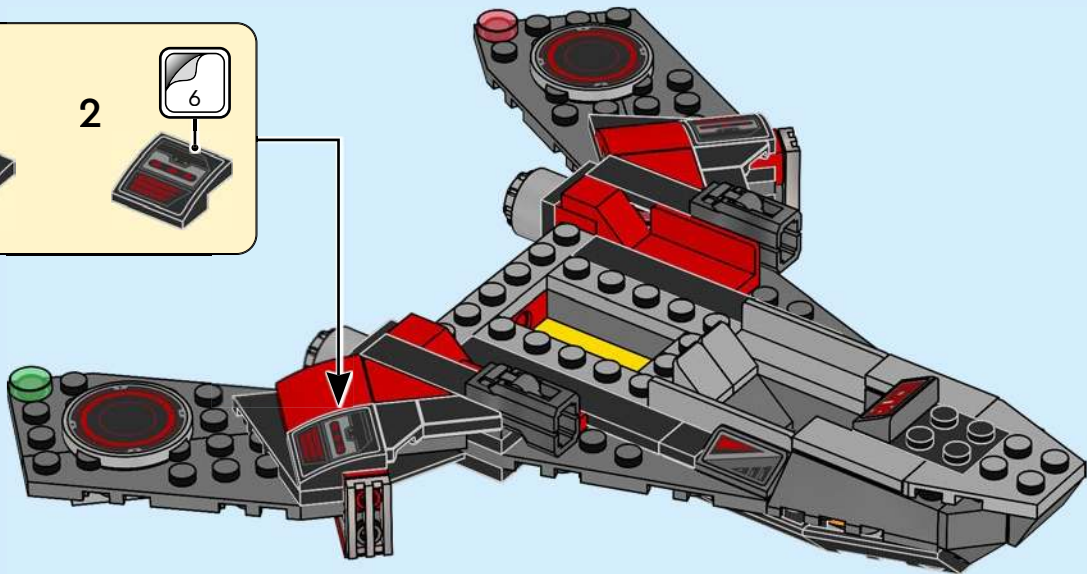
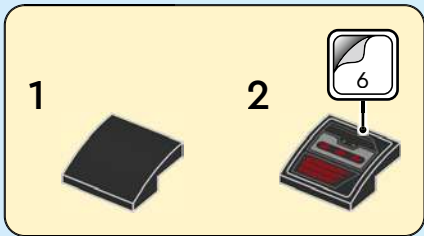

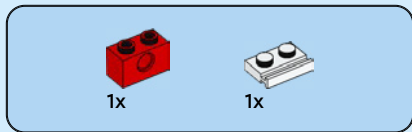

60

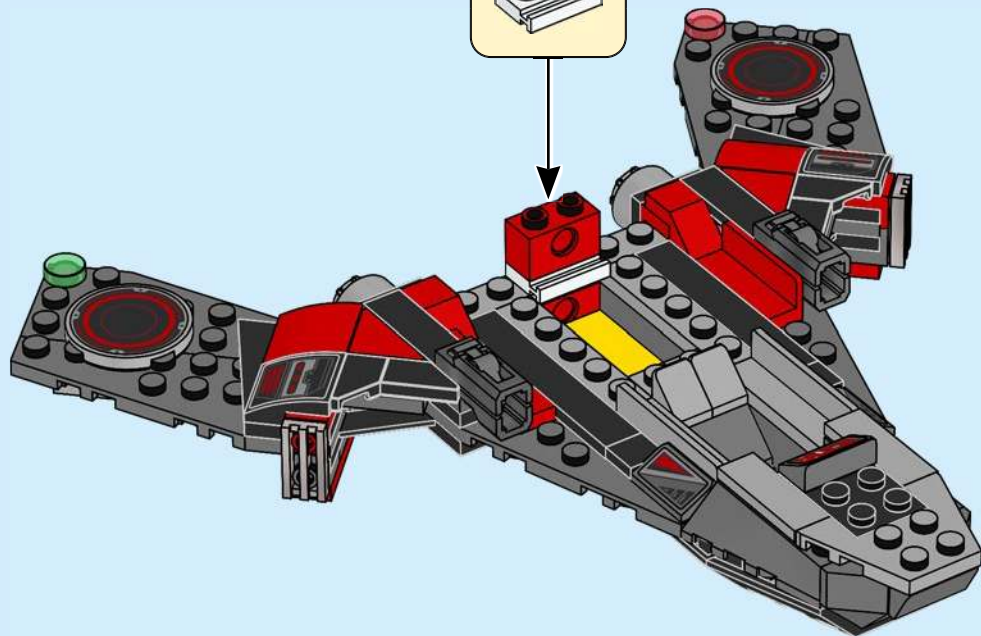

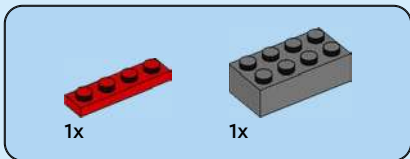

1x

1x

61

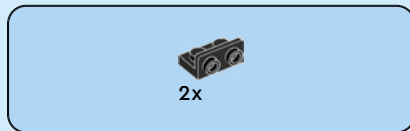
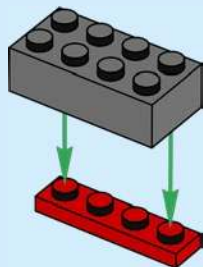

2x

62

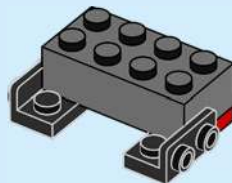



2x

63

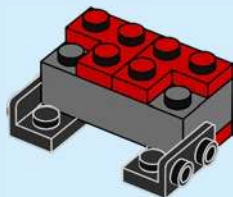

2x

64

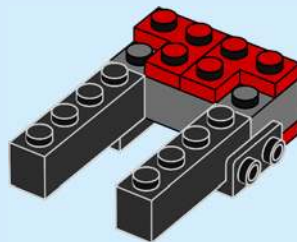



2x

65

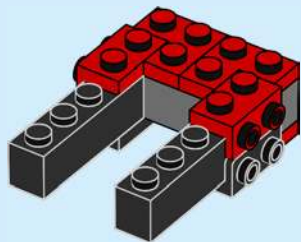

2x

66

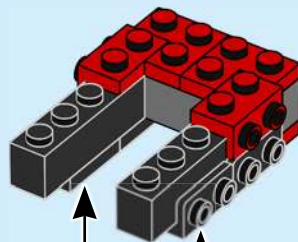

2x





2x

67

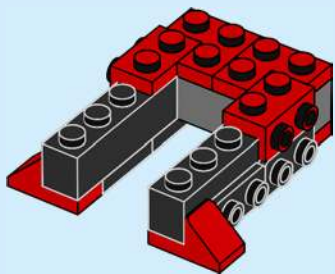

1x



2x

68

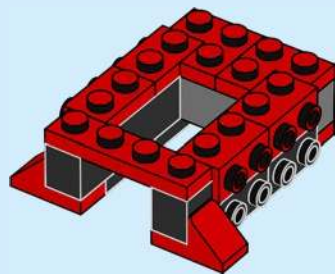



2x



2x

69

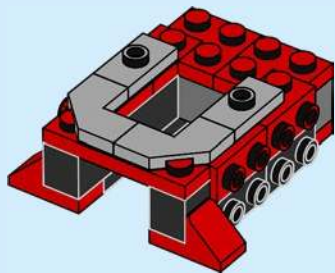

2x

70

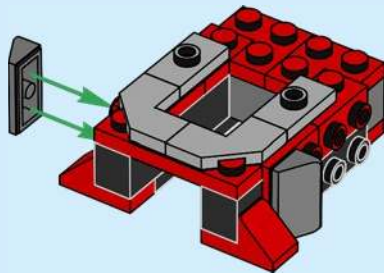



2x

71

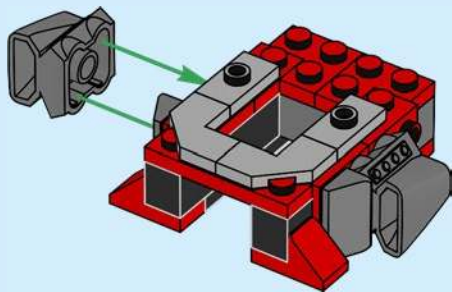

1x



2x

72

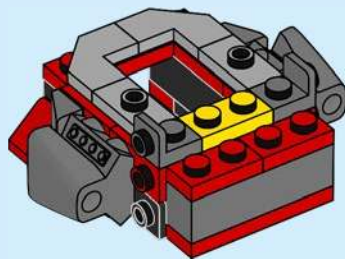



2x

73

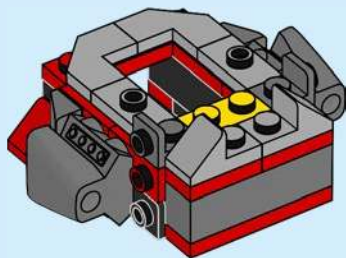

2x

74

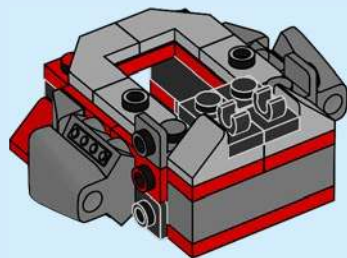



75

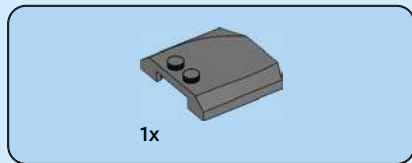
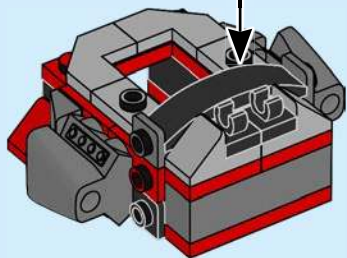

76

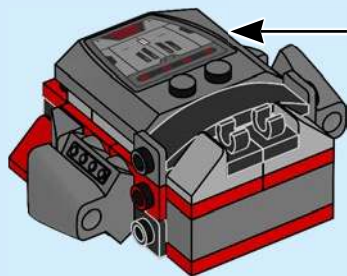
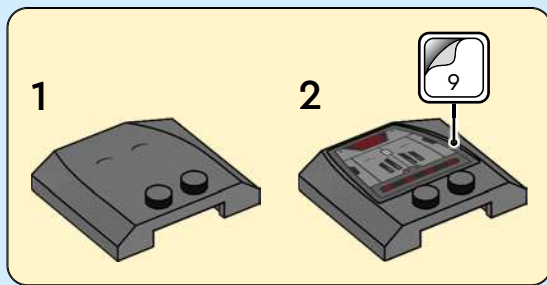



2x



2x

77

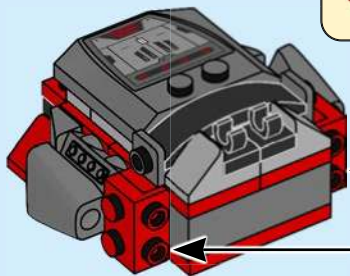
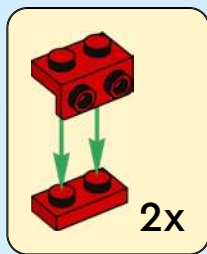

2x



2x

78

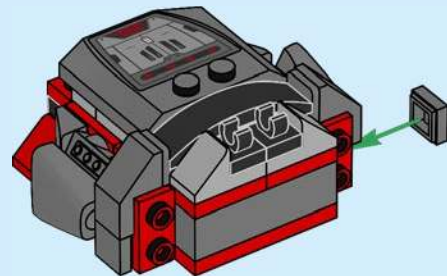

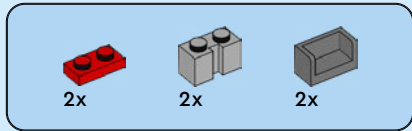

79

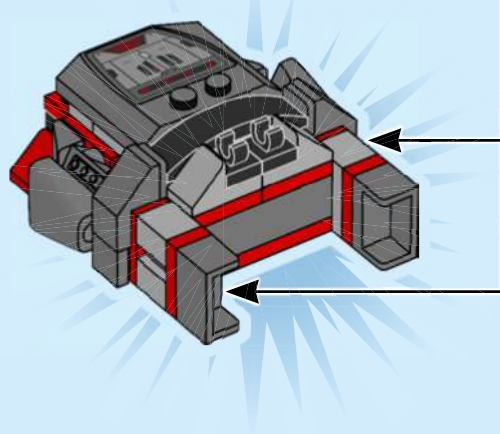
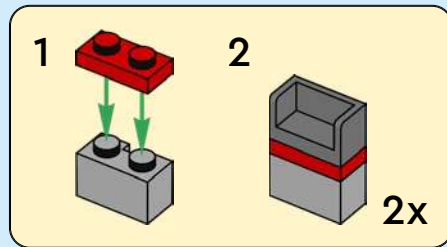

80

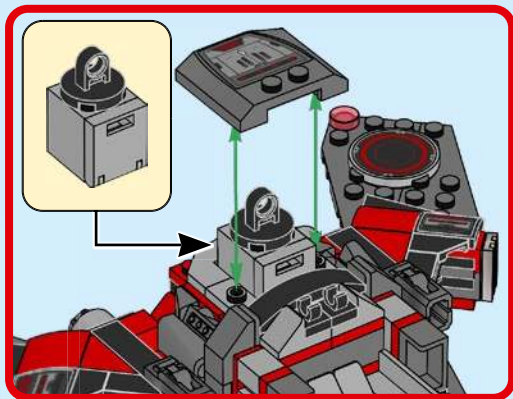
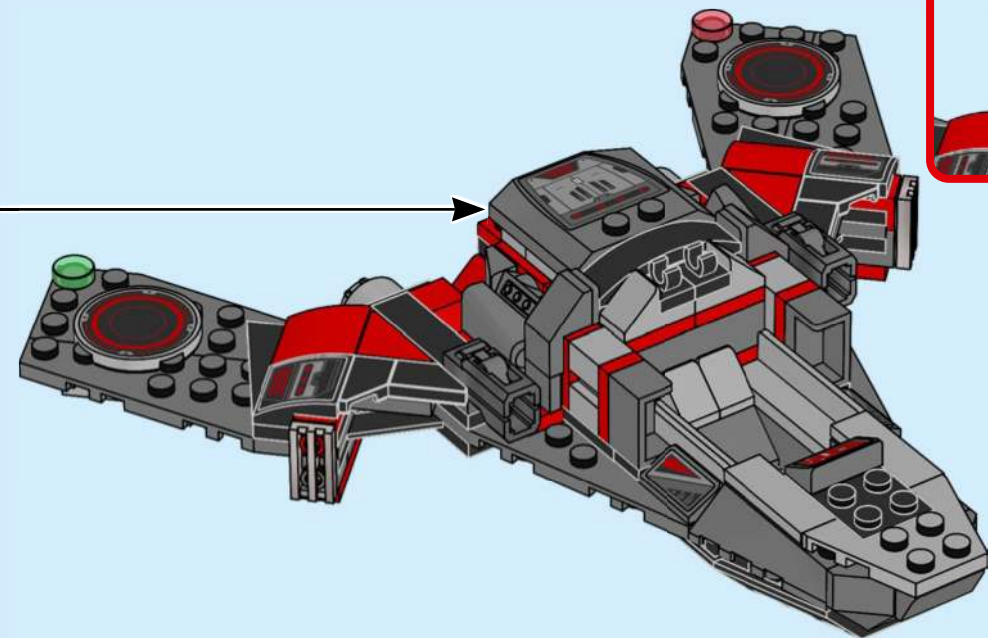

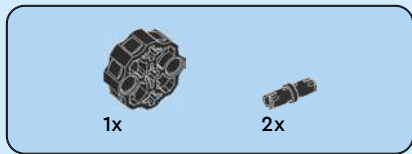

81

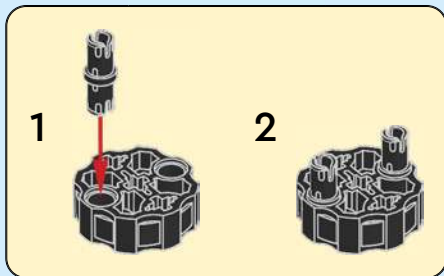
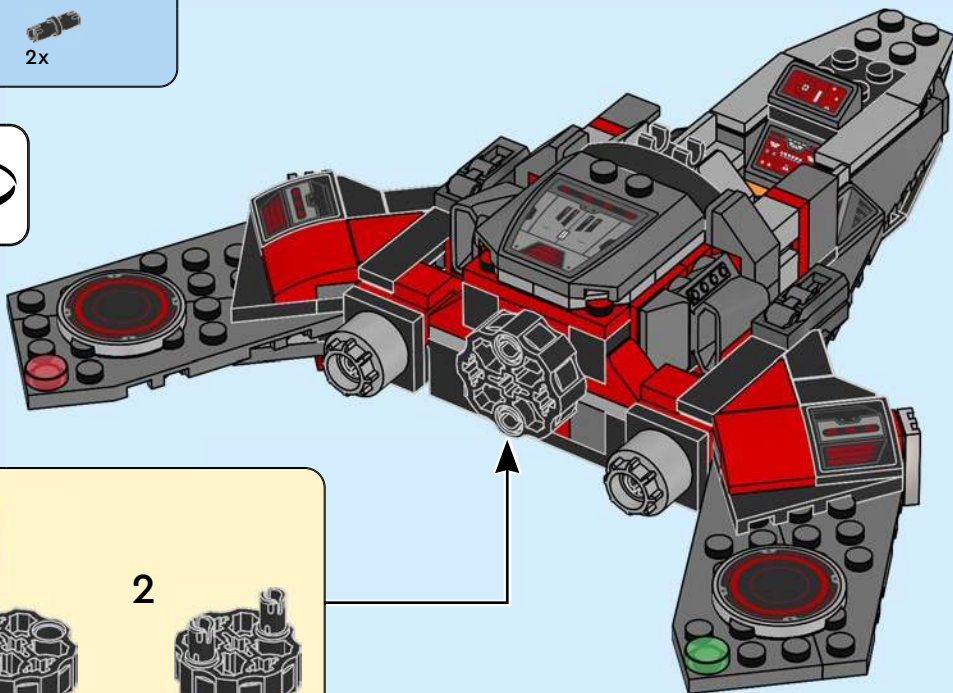
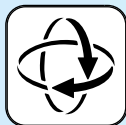

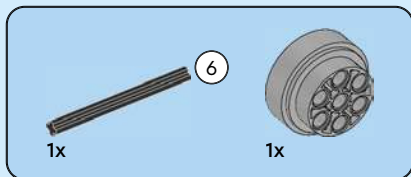

82

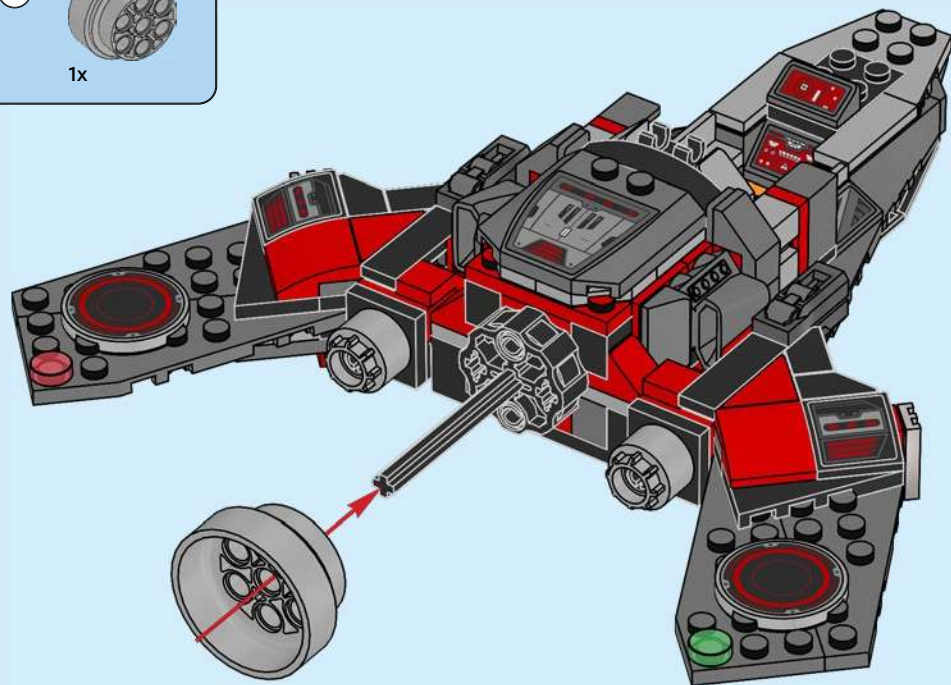

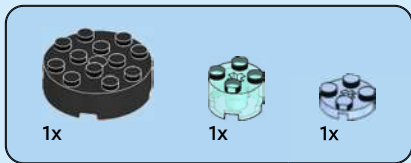

83

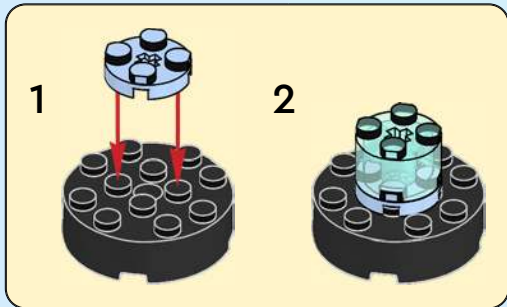
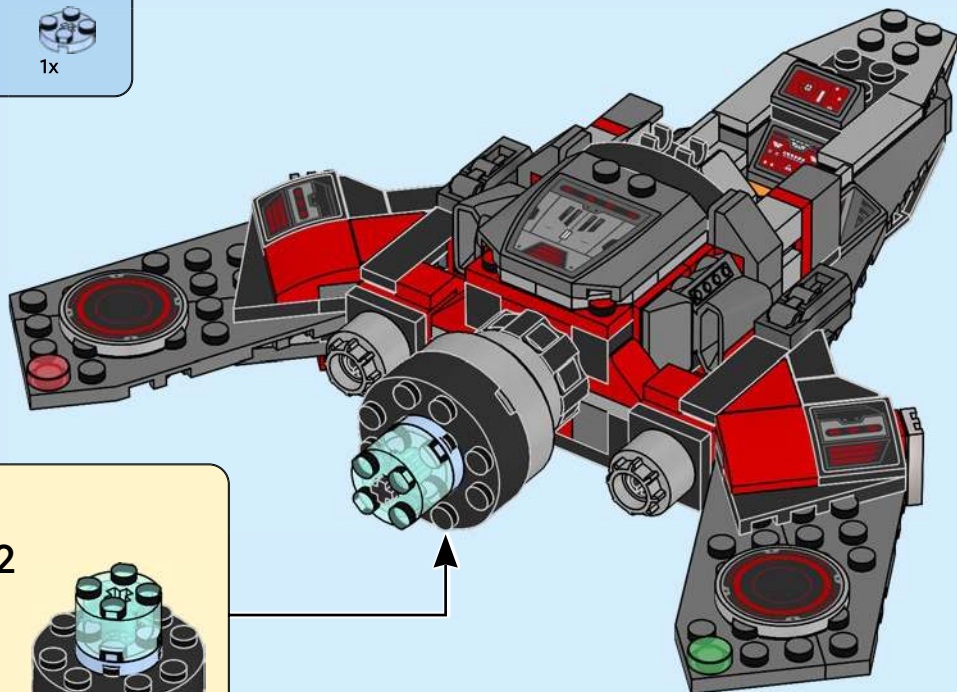

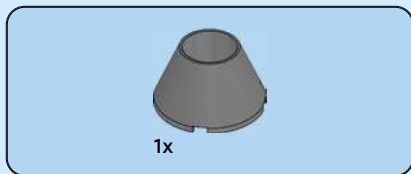

84

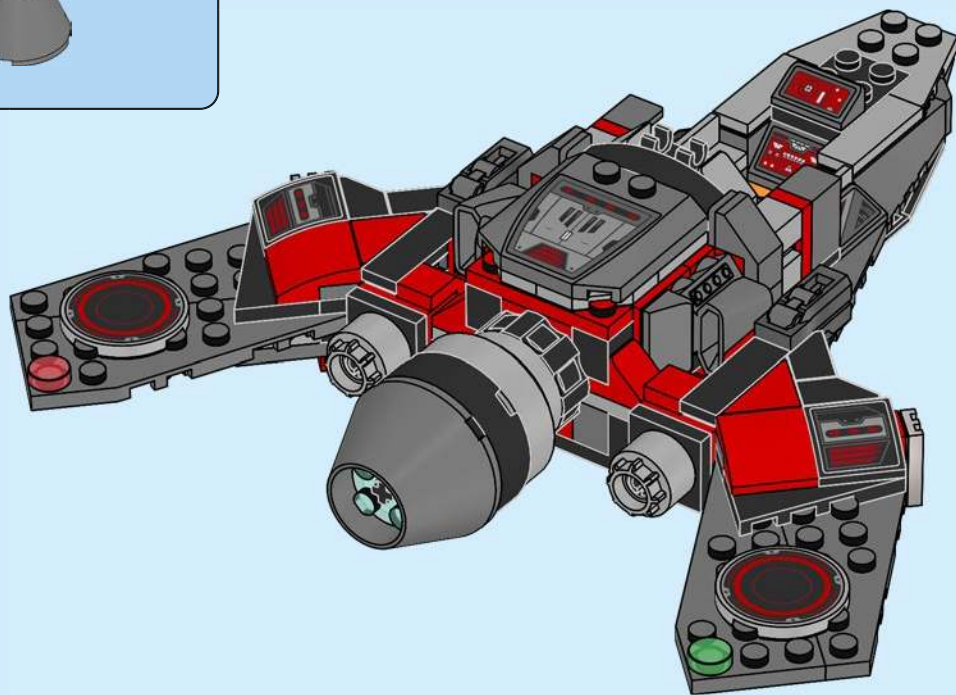

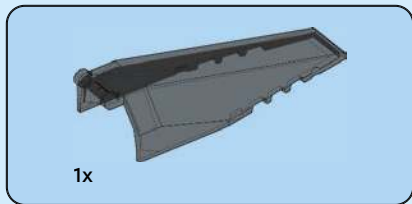

85

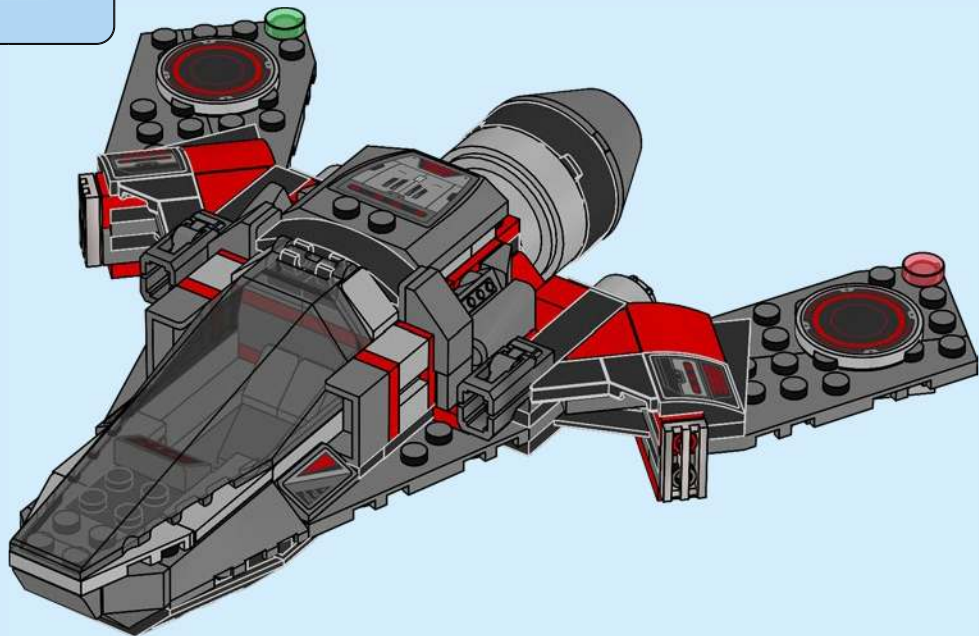

4x

86

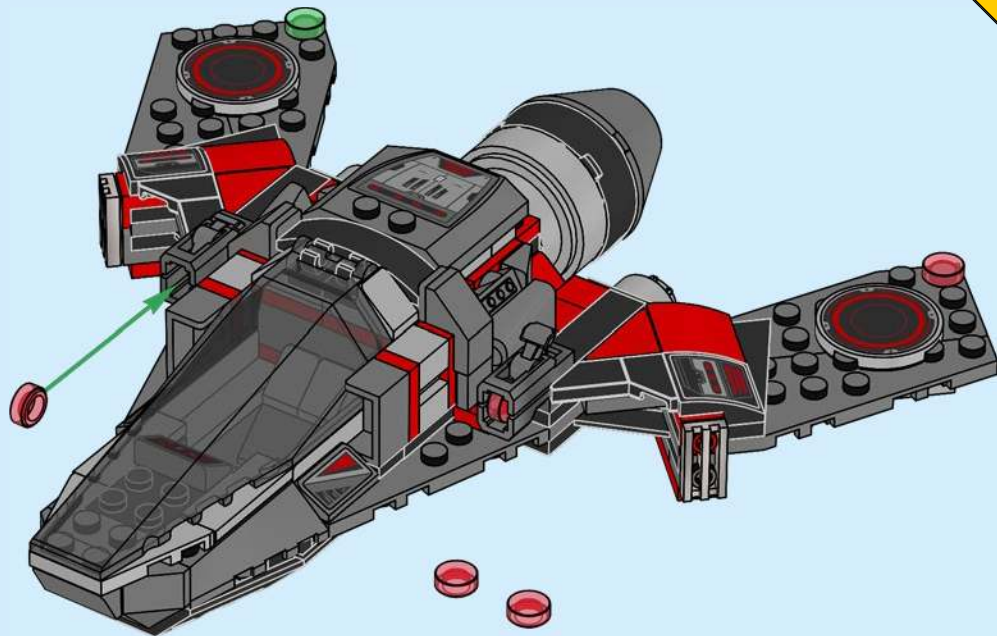

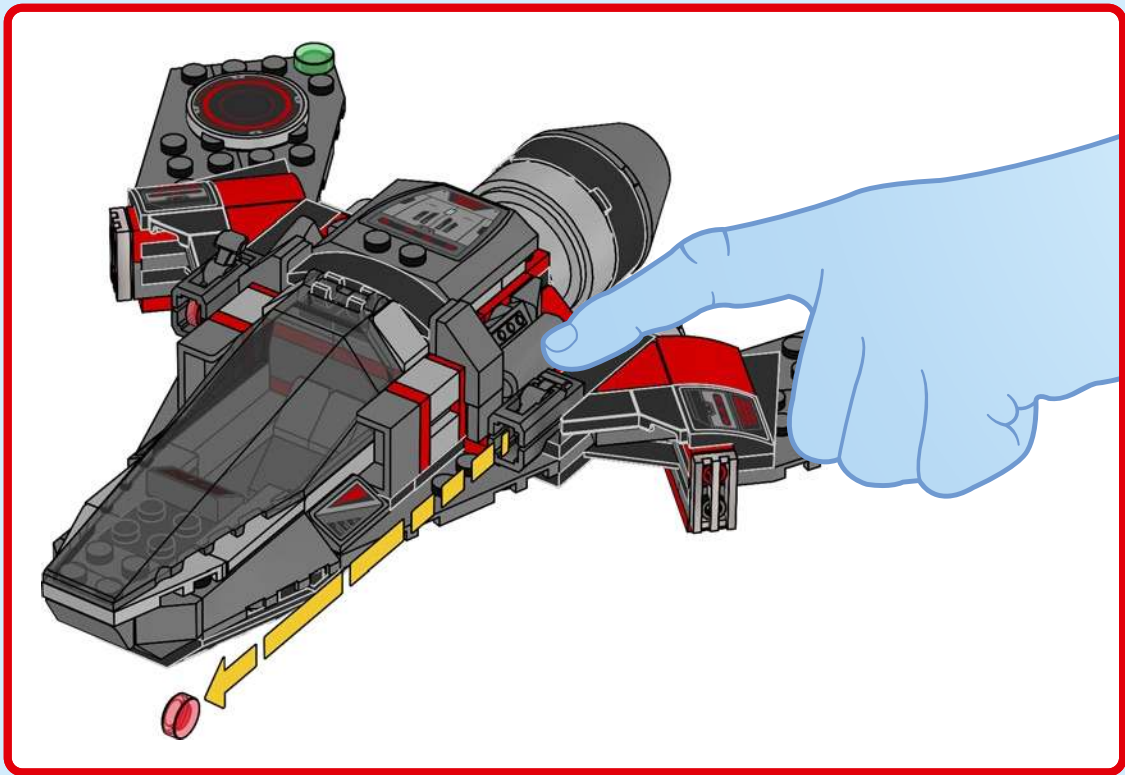

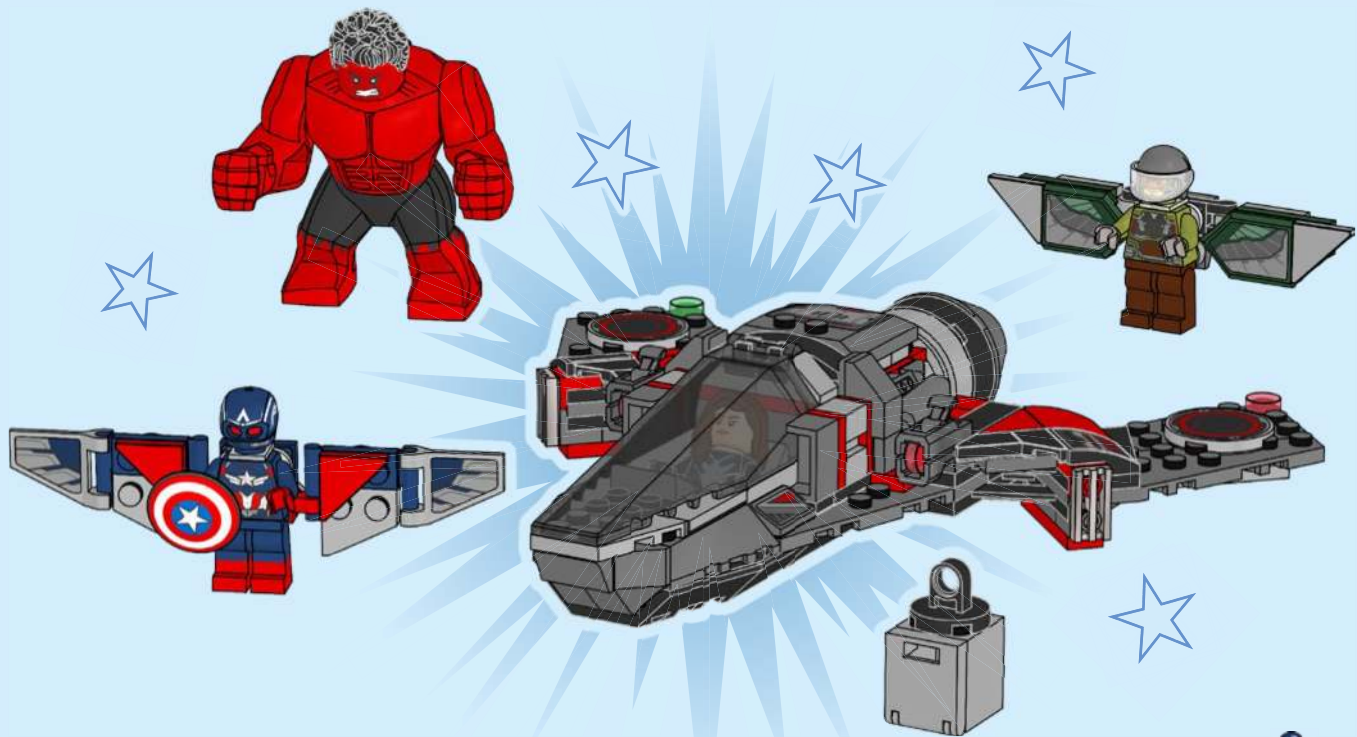



1x
6059185



1x
4249563



1x
6214334



2x
6372478



2x
6335377



1x
6476670



2x
370021



2x
6053011



4x
302321



2x
6275178

82



1x
6486008



8x
6319330



1x
6486015



4x
6351892



1x
6486017



2x
6105976



2x
242021



2x
6211447



1x
6486018

1x
6486018



6x
371021



1x
6476680



2x
4206482



1x
302324



1x
4560181



2x
307026



2x
6458188



1x
4161332

1x
4161332



1x
4160869



1x
6103643



2x
6279875



1x
6010831



2x
6458187



2x
6347310



6x
6020193



1x
6430626



2x
6053077



2x
6313191



1x
6186133



2x
4558170



1x
6487153



1x
6099483



1x
302126



2x
301026



1x
4613153



1x
4558957



1x
6195436



1x
6195436

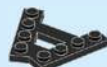

4x
6054852



2x
6039194

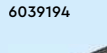

1x
370626



2x
663626



1x
6131571



1x
4541984



1x
6195436

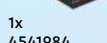

1x
6195436



1x
6195436

1x
6195436



1x
6244787



2x
6166106



6x
6258607



1x
6273153



2x
6274742



2x
6030521



1x
6343796



1x
6491727



1x
6486001



2x
6440476

2x
6440476



1x
6458400



1x
6389696



1x
6487137



2x
6486505



1x
6167130



1x
6167129



2x
6285134



1x
4550736



1x
4550736

1x
4550736

1x
4550736

6



1x
6163478



1x
6163477



1x
6248890



1x
4211492



2x
6307931



4x
6093859



2x
4617170



2x
6066097



2x
6365505



3x
6217876



2x
6319336



2x
6177078



1x
4211491



2x
6306721



2x
4558169



2x
6071299



1x
4511007



1x
6170521



1x
4211395



2x
6372029



2x
4211452



1x
4211425



1x
4221886



1x
6383134



1x
6420370



3x
6208446



2x
4619636



2x
4210848



4x
6225494



1x
6488037



2x
6360675



6x
4567887



1x
6261471



3x
4529727



3x
4529728



2x
6168776



2x
6275131



2x
4211054



2x
6227909



2x
4502068



1x
6071261



4x
4210897



1x
4298583



1x
4222113



1x
4298580



1x
4211085



1x
4210940



2x
4211107



2x
6345952



1x
6476665



1x
6488184

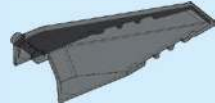

1x
6440101



LEGO.com/service



YOU COULD **WIN**

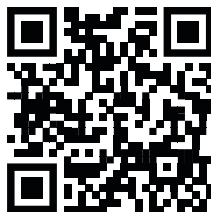

Scan this QR code or go to **LEGO.COM/PRODUCTFEEDBACK** and give us your short feedback about this LEGO® set for a chance to win a cool LEGO prize.

Terms and Conditions apply*



EN: YOU COULD WIN. Terms and Conditions apply* **DE: Du könntest GEWINNEN.** Es gelten die Teilnahmebedingungen* **FR: Tu pourrais GAGNER.** Des conditions s'appliquent* **IT: Potresti VINCERE tu.** Termini e condizioni sono applicabili* **ES: Puedes GANAR.** Aplican términos y condiciones* **PT: Poderá GANHAR.** Aplicam-se termos e condições* **ZH: 轻松获奖. 条款和条件适用*** **PL: Szansa na WYGRANĄ.** Obowiązują warunki korzystania* **CS: Máte šanci VYHRÁT.** Platí všeobecné smluvní podmínky* **SK: Máte šancu VYHRAŤ.** Platia všeobecné zmluvné podmienky* **HU: TE IS NYERHETSZ.** Felhasználási feltételek érvényesek* **RO: Ai putea CÂȘTIGA.** Se aplică termenii și condiții* **BG: Можете да СПЕЧЕЛИТЕ.** Има определени правила и условия* **LV: Tu vari LAIMĒT.** Ir spēkā noteikumi un nosacījumi.* **ET: Sul on võimalus VÕITA.** Kehtivad tingimused* **LT: Jūs galite LAIMĖTI.** Taikomos sąlygos*

*[LEGO.com/productfeedback-terms](https://www.lego.com/productfeedback-terms)

LEGO and the LEGO logo are trademarks of the LEGO Group. ©2024 The LEGO Group.

© 2024 MARVEL

6512865