



PIXIE



NESPRESSO

EN CLICK AND CHOOSE YOUR LANGUAGE
FR CLIQUEZ ET CHOISISSEZ VOTRE LANGUE
ES-LATAM CLIC Y ELIJA SU LENGUAJE
BR CLIQUE E ESCOLHA SUA LÍNGUA
IL לחץ ובחר את השפה שלך



HOW TO NAVIGATE IN THE USER MANUAL

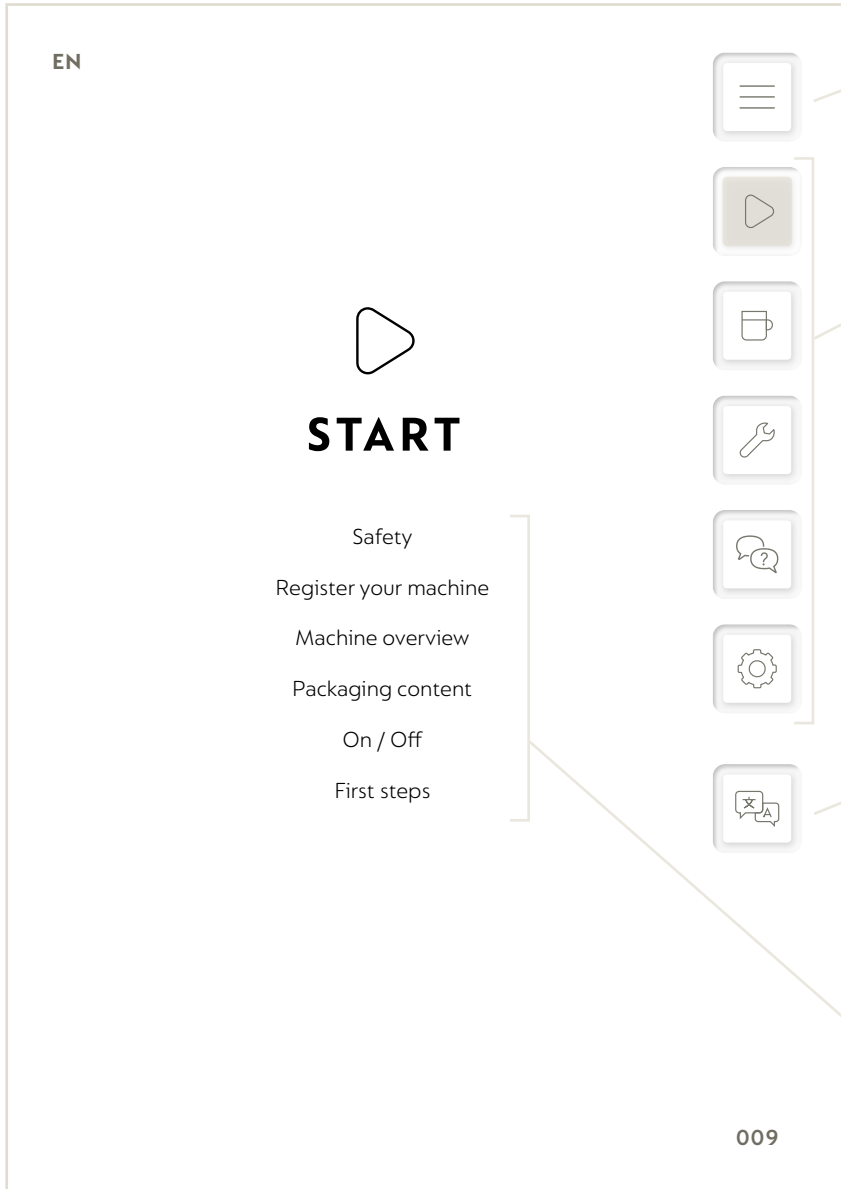

Click here to go back to the table of contents

Click here to go directly to a specific chapter

Click here to choose your favorite language

All the subchapters are clickable, click on them to go directly where you need

TABLE OF CONTENTS



START

- Safety
 - Register your machine
 - Machine overview
 - Packaging content
 - On / Off
 - First steps
-



COFFEE PREPARATION



MAINTENANCE

- Cleaning
 - Descaling
 - Preparing for repair or storage
-



TROUBLESHOOTING



SETTINGS

- Specifications
- Personalize your coffee size
- Reset to factory settings
- Water hardness settings
- Energy saving mode
- Disposal and environmental protection



START

Safety

Register your machine

Machine overview

Packaging content

On / Off

First steps



SAFETY

CAUTION: Before operating your coffee machine, please refer to the safety instructions leaflet to avoid possible harm and damage.

www.nespresso.com



**DISCOVER HOW TO USE
YOUR NESPRESSO MACHINE ON**

www.youtube.com

REGISTER YOUR MACHINE

As a **Nespresso** Member, you benefit from lifetime support from our Coffee specialists including machine troubleshooting services. Please provide the serial number of your new machine when you first register, to help us provide personalized customer assistance. This 19-digit code is found on **the drip tray or bottom of your machine.**

www.nespresso.com

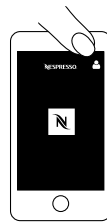

01. Connect on nespresso.com

02. Log in your account.



03. Add a machine and follow the steps.



The serial number, which contains 19 characters, is located under the barcode. This number is written on a label, which represents the identity of your machine. The information is helping us to check your model and to have the best tracking if your machine needs to be sent to our repair center. The label with the serial number can be found as follows:

- On the drip tray
- Under the machine
- On the packaging of your machine



MACHINE OVERVIEW

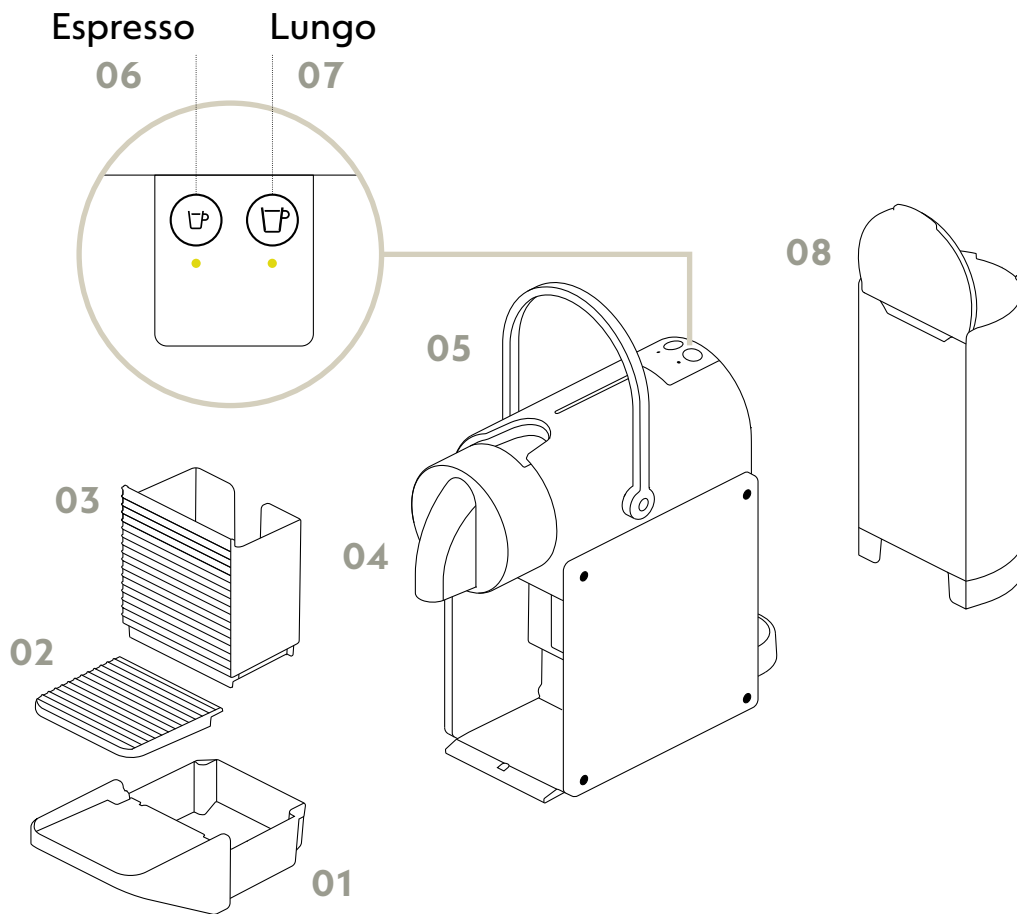

01. Drip Tray

02. Drip grid

03. Used capsule container

04. Coffee outlet

05. Lever

06. Espresso button

07. Lungo button

08. Water Tank



PACKAGING CONTENT



-
- 01. Coffee machine
 - 02. Nespresso welcome booklet
 - 03. Nespresso capsules set
 - 04. Safety instructions
 - 05. Quick Start Guide
 - 06. Warranty

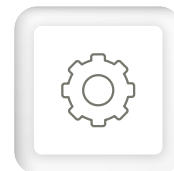
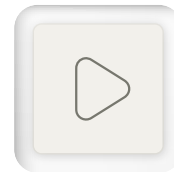

ON / OFF

ON

🕒 ~30"

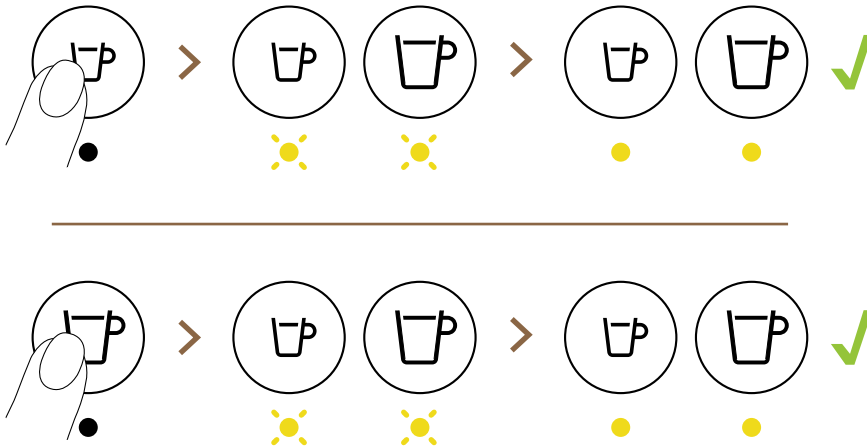

Turn on your machine by pressing any button. The machine will heat up in approximately 30 seconds. Lights will blink while the machine is heating up. The light becomes steady, the machine is ready.

OFF

🕒 <1"

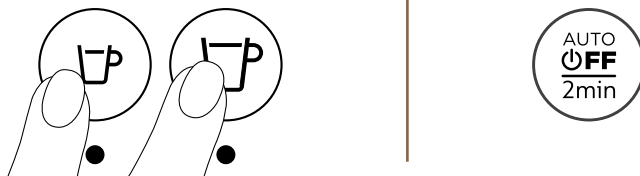

Turn off your machine by pressing both the Espresso and Lungo buttons simultaneously for less than a second. Alternatively, the machine will turn off automatically after 2 minutes of non-use.



FIRST STEPS

i Unboxing: Some dust may be present on the surface of the machine due to the recycled materials used in the packaging. This is not dangerous, simply clean with a soft tissue.

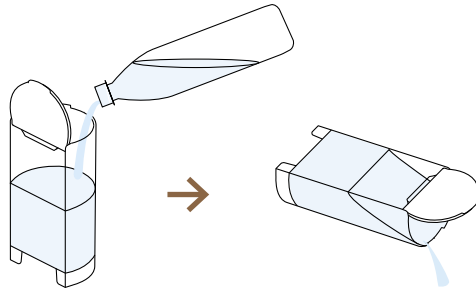

01. Rinse to clean the water tank.

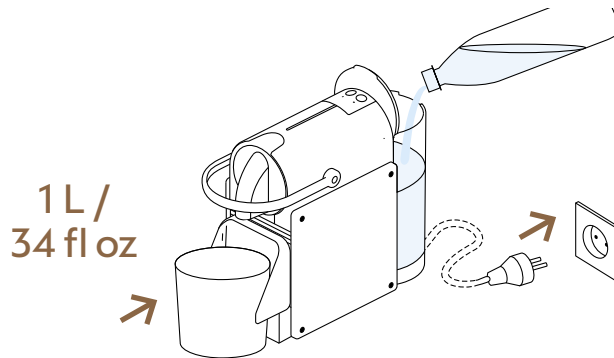

02. Fill the water tank with fresh portable water and put it back into position. Place a container of at least one litre / 34 fl oz under the coffee outlet and plug the machine to a power outlet.



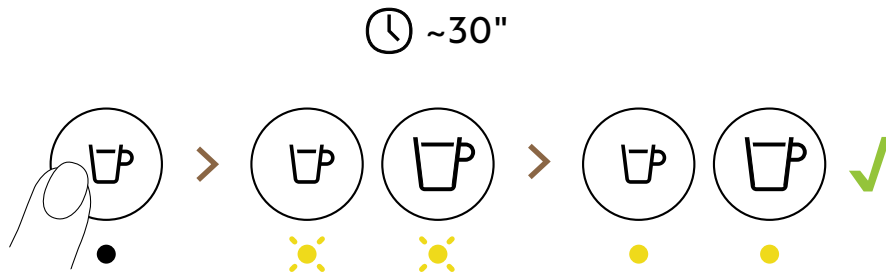

- 03.** Turn on your machine by pressing any button. The machine will heat up in approximately 30 seconds. Lights will blink while the machine is heating up. When the light becomes steady, the machine is ready.

Lungo

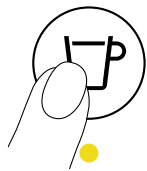

3 x

- 04.** To rinse your machine, press the Lungo button. Repeat three times. Your machine is now ready to use.



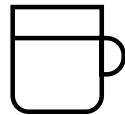

COFFEE PREPARATION

BUILD THE COFFEE CORNER OF YOUR DREAMS



Choose your favourite coffee or subscription plan that suits you, we'll take care of the rest.



Discover the **Pixie** Collection.

Discover more at www.nespresso.com

COFFEE PREPARATION

🕒 ~30"

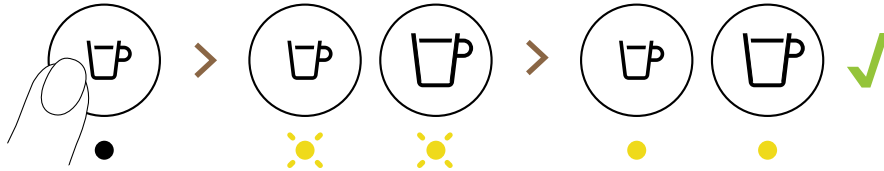

- 01.** Turn on your machine by pressing any button. The machine will heat up in approximately 30 seconds. Lights will blink while the machine is heating up. When the light becomes steady, the machine is ready.

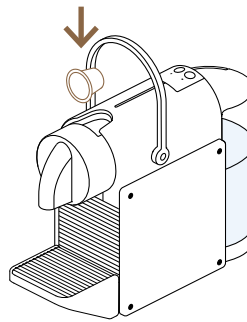
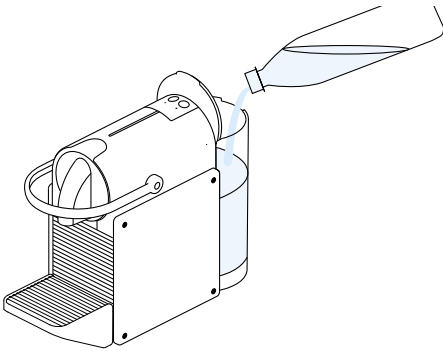

- 02.** Fill the water tank with fresh potable water and put it back in position.

- 03.** Open the machine by lifting the lever completely. Insert a capsule.

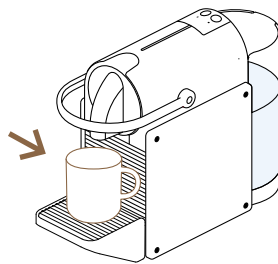

- 04.** Close the lever. Place a cup with sufficient capacity.

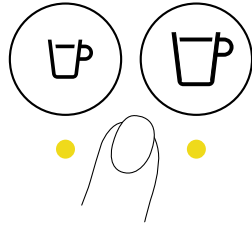

Espresso40 ml /
1.35 fl oz**Lungo**110 ml /
3.75 fl oz

- 05.** Press on the corresponding coffee button. The brewing process starts and will stop automatically. If you wish to stop the flow or top up your coffee, press again.

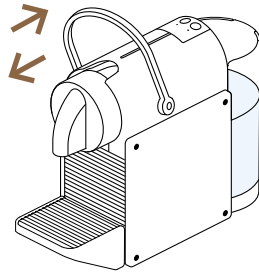

- 06.** To eject the capsule into the used capsule container, lift and close the machine lever.



Upgrade your coffee experience and prepare indulgent milk recipes with your **Aeroccino** milk frother. Discover the range on www.nespresso.com



MAINTENANCE

Cleaning

Descaling

Preparing for repair or storage

CLEANING

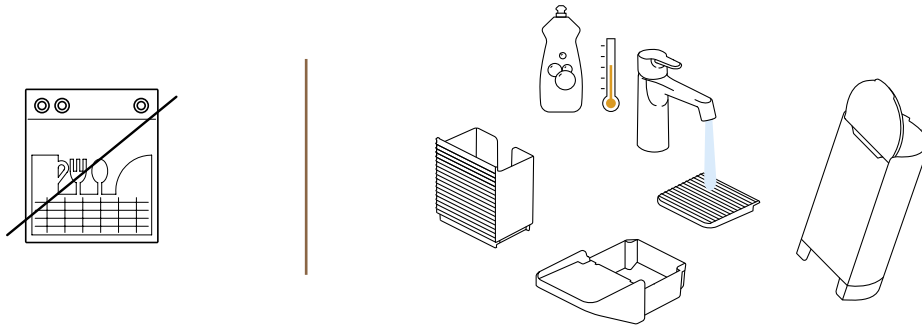

- 01.** Do not put any part of the machine into the dishwasher. Be sure to unplug the machine before cleaning. We recommend emptying the drip tray and used capsule container everyday. Also remove the water tank. Clean them all with odourless detergent and rinse with warm or hot water.

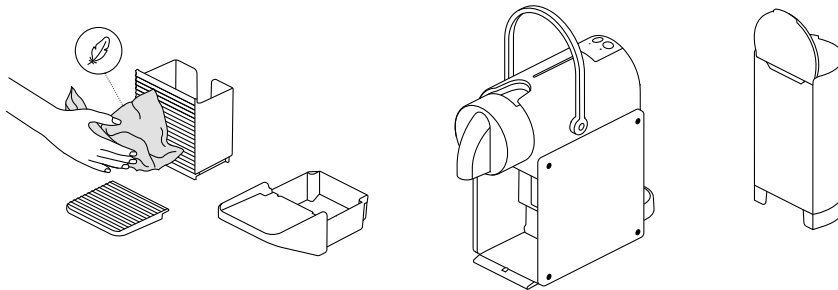

- 02.** Dry with a clean and fresh towel, cloth or paper and reassemble all parts.

i

Clean the coffee outlet and machine surfaces regularly with a damp cloth.

You should not use sharp objects, brushes or sharp abrasives, as well as strong cleaning agent or solvent cleaner.



DESCALING

MATERIAL:

- Descaling agent ( www.nespresso.com)
- 1 L / 34 fl oz container

TIME:

- The process takes approximately 15 minutes



WARNING: The descaling solution can be harmful. Avoid contact with eyes, skin and surfaces.



If you want to pause the descaling process, you can press any button.

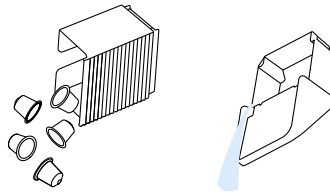
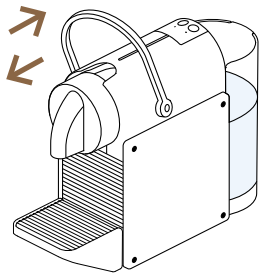

01. Lift and close the lever to eject the capsule into the used capsule container.

02. Empty the drip tray and the used capsule container before turning the machine ON.

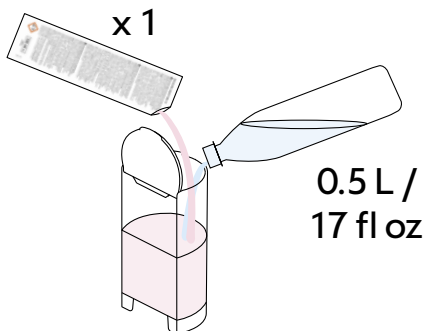

1 L /
34 fl oz

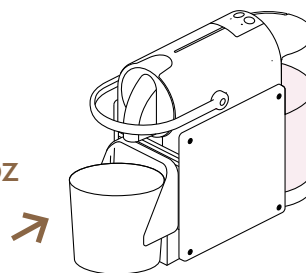

03. Fill the water tank with fresh potable water up to 0.5 litre / 17 fl oz and add one unit of **Nespresso** descaling kit.

04. Place a container under the coffee outlet with a minimum volume of 1 litre / 34 fl oz.

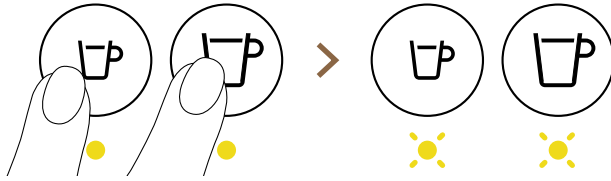

 >6"

- 05.** To enter descaling mode, simultaneously press the Espresso and Lungo buttons for more than 6 seconds until both lights start blinking.

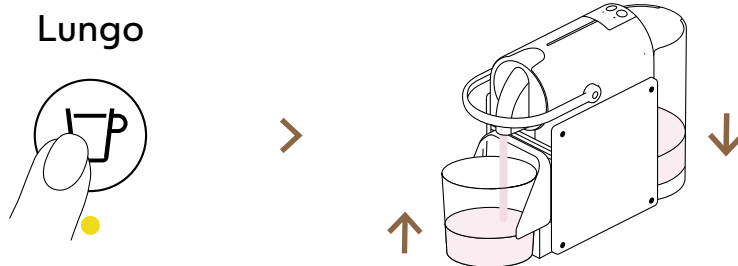

- 06.** Start the first cycle of the descaling process by pressing the Lungo button and wait until the water tank is empty.



- 07.** Refill the water tank with the liquid from the container and descale again by pressing the Lungo button.



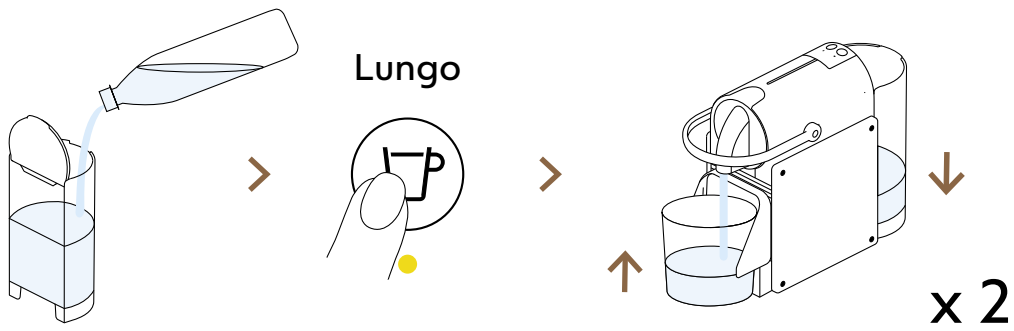

- 08.** Rinse the water tank, fill it with fresh potable water. Place a 1 L / 34 fl oz container under the coffee outlet and press the Lungo button to start rinsing. Repeat the process one again.

🕒 >5"

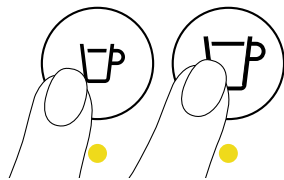

- 09.** Descaling is now complete. Exit descaling mode by pressing simultaneously Espresso and Lungo buttons for more than 5 seconds.



PREPARING FOR REPAIR OR STORAGE

BEFORE A PERIOD OF NON-USE AND FOR FROST PROTECTION, OR BEFORE A REPAIR

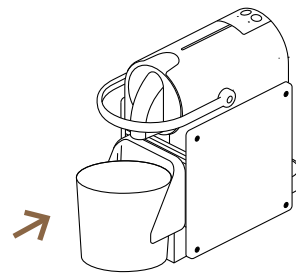
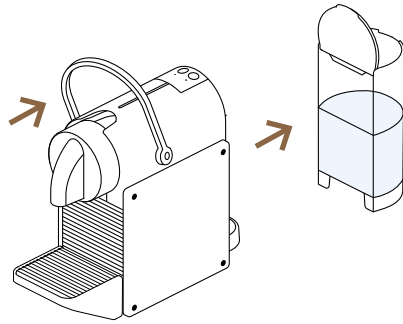

01. When the machine is switched off, remove the water tank and lift the lever to eject any capsule.

02. Place a container under the coffee outlet.

🕒 >5"

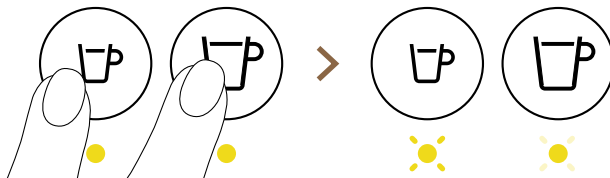

03. Press and hold simultaneously Espresso and Lungo buttons for more than 5 seconds. Buttons will blink alternatively.



Machine switches off when the procedure is finished.



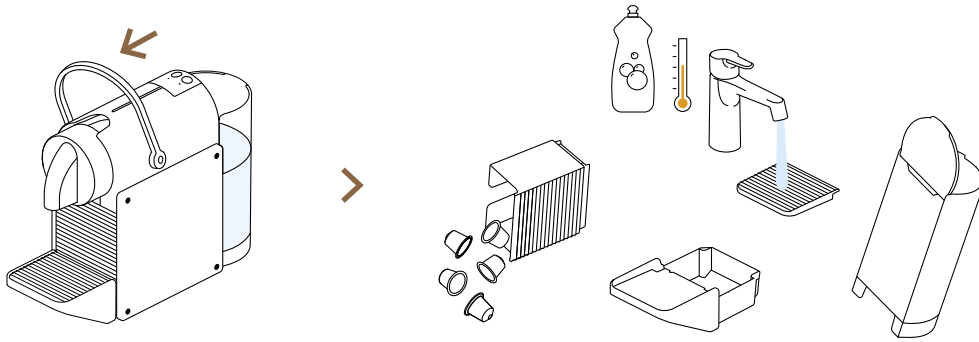

04. Be sure to unplug the machine before cleaning. Empty the drip tray, used capsule container and remove the water tank. Clean them all with odourless detergent and rinse with warm or hot water.

Do not put any part of the machine into the dishwasher.





TROUBLESHOOTING

TROUBLESHOOTING

No light indicator • Check the power outlet, plug, voltage, and fuse. In case of problems, call **Nespresso**.

No coffee, no water • First use: fill water tank with water (max. 55° C / 130° F) and run through machine according to instructions on page **11**.
• Water tank is empty. Fill water tank.
• Descale if necessary; see Descaling section on page **18**.

Coffee comes out very slowly • Flow speed depends on the coffee variety.
• Descale if necessary; see Descaling section on page **18**.

Coffee is not hot enough • Descale if necessary; see Descaling section on page **18**.

Error mode: The 2 lights flash fast together every 3 seconds • Unplug and replug the machine. If the problem persists, call **Nespresso**.

i In case of intensive use (more than 10 coffees in one go, without stop), the machine can go into overheating mode. Wait a maximum of 10 minutes before using it again. Both buttons will flash slowly, do not unplug the machine. This is a normal step after a rest period to protect the pump.



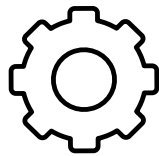

SETTINGS

Specifications

Personalize your coffee size

Reset to factory settings

Water hardness settings

Energy saving mode

Disposal and environmental protection

SPECIFICATIONS

DIMENSIONS

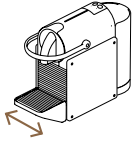

116.6 mm
4.65 inch

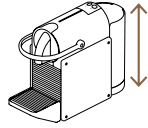

234.6 mm
9.25 inch

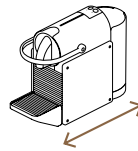

324.2 mm
12.75 inch

WEIGHT

2.47 kg / 5.47 lbs

WATER TANK CAPACITY

0.7 L / 24 fl oz

CAPSULE CONTAINER CAPACITY

9-11 capsules

POWER

220-240 V ~, 50-60 Hz, 1 260 W

BR/KR	220 V ~, 60 Hz, 1 150 W
BR/MX	127 V ~, 60 Hz, 1 350 W
CA/CO/DO/PA/US	120 V ~, 60 Hz, 1 160 W
CL/CN	220 V ~, 50 Hz, 1 150 W
DO/TW	110 V ~, 60 Hz, 1 000 W
PH	220 V ~, 60 Hz, 1 200 W

MACHINE CODE

Nespresso	C62, D62
Breville	BEC440, BEC470
DeLonghi	EN127.S, EN127.BL
Krups	XN306T, XN3067
Magimix	M113



PERSONALIZE YOUR COFFEE SIZE

YOUR PIXIE MACHINE IS PREPROGRAMMED TO OBTAIN THE BEST IN-CUP RESULT. IN ORDER TO GET AS CLOSE AS TO YOUR PERSONAL EXPECTATIONS YOU CAN REPROGRAM THE VOLUME OF YOUR COFFEE ACCORDING TO YOUR TASTES.

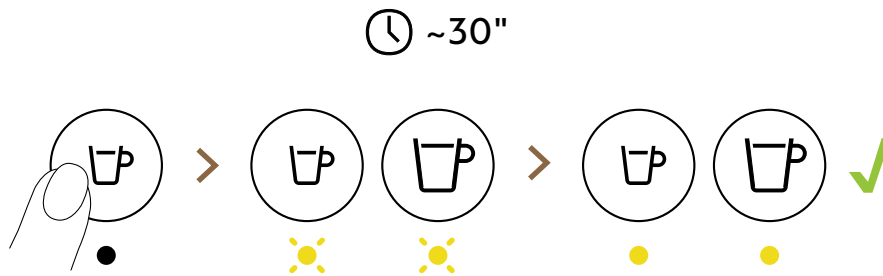

01. Turn on your machine by pressing any button. The machine will head up in approximately 30 seconds. Lights will blink while the machine is heading up. When the light becomes steady, the machine is ready.

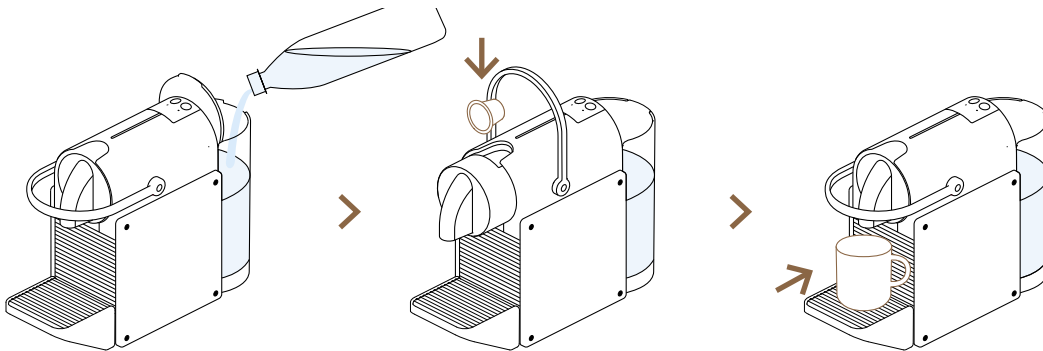

02. Fill the water tank with fresh potable water and insert a capsule. Place a cup under the coffee outlet.



Espresso

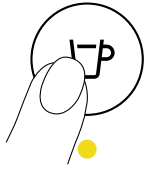

Lungo

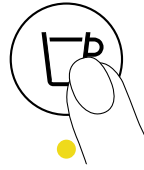

03. To programm the desired volume for any Espresso or Lungo press and hold the Espresso or Lungo buttons until the machine starts brewing.

Espresso

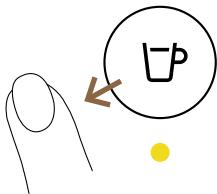

Lungo

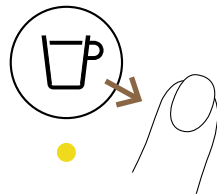

04. Release the button one the desired volume is served.

3 x

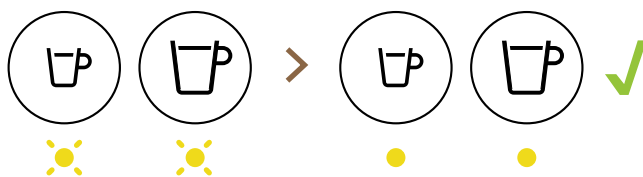

05. Lights will blink fast 3 times to confirm new setting.



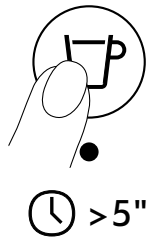

RESET TO FACTORY SETTINGS

Lungo



- 01.** When the machine is switched off, press and hold the Lungo button for more than 5 seconds.

FACTORY SETTINGS

 Espresso 40 ml / 1.35 fl oz	 Lungo 110 ml / 3.75 fl oz	 AUTO OFF 2min
--	--	--

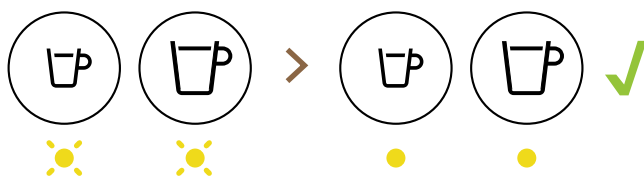

- 02.** Lights will blink fast 3 times to confirm that the factory settings are restored.



WATER HARDNESS SETTINGS

Water hardness	High	Medium	Low
CaCO ₃ Calcium Carbonate	360 mg/l	180 mg/l	0 mg/l
We invite you to descale your machine after:			
 40 ml / 1.35 fl oz	1,000 coffees	2,000 coffees	4,000 coffees



ENERGY SAVING MODE

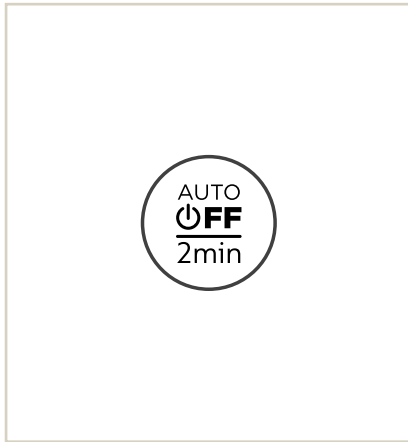

The machine will turn off automatically after 2 minutes of non-use.

TO CHANGE THIS SETTING

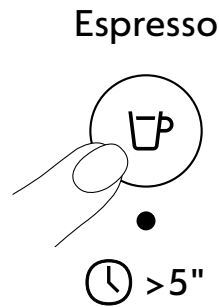

01. When the machine is switched off, press and hold the Espresso button more than 5 seconds.

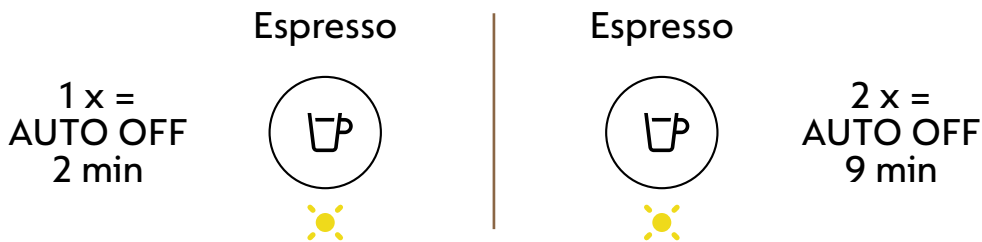

02. Choose your saving mode by pressing the Espresso button.



03. To exit - press and hold the Lungo button for more than 5 seconds.



DISPOSAL AND ENVIRONMENTAL PROTECTION

This appliance complies with the EU Directive 2012/19/EC. Packaging materials and appliance contain recyclable materials. Your appliance contains valuable materials that can be recovered or can be recycled. Separation of the remaining waste materials into different types facilitates the recycling of valuable raw materials. Leave the appliance at a collection point. You can obtain information on disposal from your local authorities.



Discover more about sustainability: www.nespresso.com

EN HOW TO NAVIGATE IN THE USER MANUAL FR COMMENT NAVIGUER DANS LE MODE D'EMPLOI

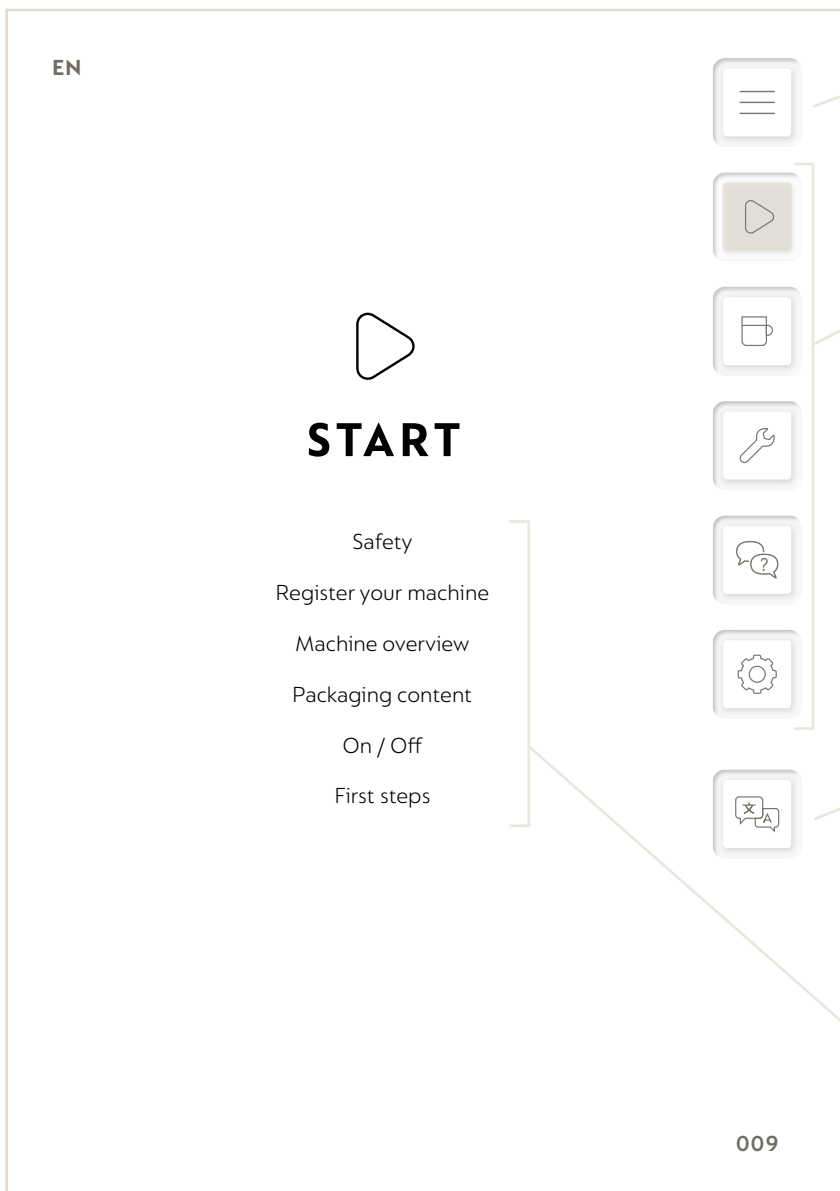

EN Click here to go back to the table of content
FR Cliquez ici pour revenir à la table des matières

EN Click here to go directly to a specific chapter
FR Cliquez ici pour accéder directement à un chapitre spécifique

EN Click here to choose your favorite language
FR Cliquez ici pour choisir votre langue de préférence

EN All the subchapters are clickable, click on them to go directly where you need
FR Tous les sous-chapitres sont cliquables, cliquez dessus pour vous rendre directement là où vous le souhaitez

EN TABLE OF CONTENTS

FR TABLE DES MATIÈRES



EN START FR DÉMARRER

- **EN** Safety
FR Sécurité
- **EN** Register your machine
FR Enregistrez votre machine
- **EN** Machine overview
FR Présentation de la machine
- **EN** Packaging content
FR Contenu de l'emballage
- **EN** On / Off
FR Allumer / Éteindre
- **EN** First steps
FR Premières étapes



EN COFFEE PREPARATION FR PRÉPARATION DU CAFÉ



EN MAINTENANCE FR ENTRETIEN

- **EN** Cleaning
FR Nettoyage
- **EN** Descaling
FR Détartrage
- **EN** Preparing for repair or storage
FR Préparation à la réparation ou au stockage



EN TROUBLESHOOTING FR DÉPANNAGE

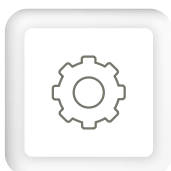

EN SETTINGS FR PARAMÈTRES

- **EN** Specifications
FR Spécifications
- **EN** Personalize your coffee size
FR Personnalisez la taille de votre café
- **EN** Reset to factory settings
FR Réinitialisation des paramètres d'usine
- **EN** Water hardness settings
FR Paramètres de dureté de l'eau
- **EN** Energy saving mode
FR Mode d'économie d'énergie
- **EN** Disposal and environmental protection
FR Élimination et protection de l'environnement



EN START FR DÉMARRER

EN Safety
FR Sécurité

EN Register your machine
FR Enregistrez votre machine

EN Machine overview
FR Présentation de la machine

EN Packaging content
FR Contenu de l'emballage

EN On / Off
FR Allumer / Éteindre

EN First steps
FR Premières étapes

EN SAFETY

FR SÉCURITÉ

EN CAUTION: Before operating your coffee machine, please refer to the safety instructions leaflet to avoid possible harm and damage.

FR ATTENTION : Avant d'utiliser votre machine à café, veuillez vous référer aux consignes de sécurité afin d'éviter tout risque de blessure ou de dommage.

www.nespresso.com



EN DISCOVER HOW TO USE YOUR NESPRESSO MACHINE ON
FR DÉCOUVREZ COMMENT UTILISER VOTRE MACHINE
NESPRESSO SUR

www.youtube.com

EN REGISTER YOUR MACHINE FR ENREGISTREZ VOTRE MACHINE

EN As a **Nespresso** Member, you benefit from lifetime support from our Coffee specialists including machine troubleshooting services. Please provide the serial number of your new machine when you first register, to help us provide personalized customer assistance. This 19-digit code is found on **the drip tray or bottom of your machine.**

FR En tant que Membre **Nespresso**, vous bénéficiez d'une assistance à vie de nos spécialistes du café, y compris des services de dépannage de la machine. Veuillez fournir le numéro de série de votre nouvelle machine lors de votre premier enregistrement, afin de nous aider à fournir une assistance client personnalisée. Ce code à 19 chiffres se trouve sur **le bac d'égouttage ou sous votre machine.**

www.nespresso.com



01. EN Connect on nespresso.com

FR Connectez-vous sur nespresso.com

02. EN Log in your account.

FR Connectez-vous à votre compte.



03. EN Add a machine and follow the steps.

FR Ajoutez une machine et suivez les étapes.





EN The serial number, which contains 19 characters, is located under the barcode. This number is written on a label, which represents the identity of your machine. The information is helping us to check your model and to have the best tracking if your machine needs to be sent to our repair center. The label with the serial number can be find as follows:

- On the drip tray
- Under the machine
- On the packaging of your machine

FR Le numéro de série, qui contient 19 caractères, est situé sous le code-barres. Ce numéro est inscrit sur une étiquette, qui représente l'identité de votre machine. Cette information nous aide à vérifier votre modèle et à avoir le meilleur suivi si votre machine doit être envoyée à notre centre de réparation. L'étiquette avec le numéro de série peut être trouvée comme suit :

- Sur le bac d'égouttage
- Sous la machine
- Sur l'emballage de votre machine



EN MACHINE OVERVIEW

FR PRÉSENTATION DE LA MACHINE

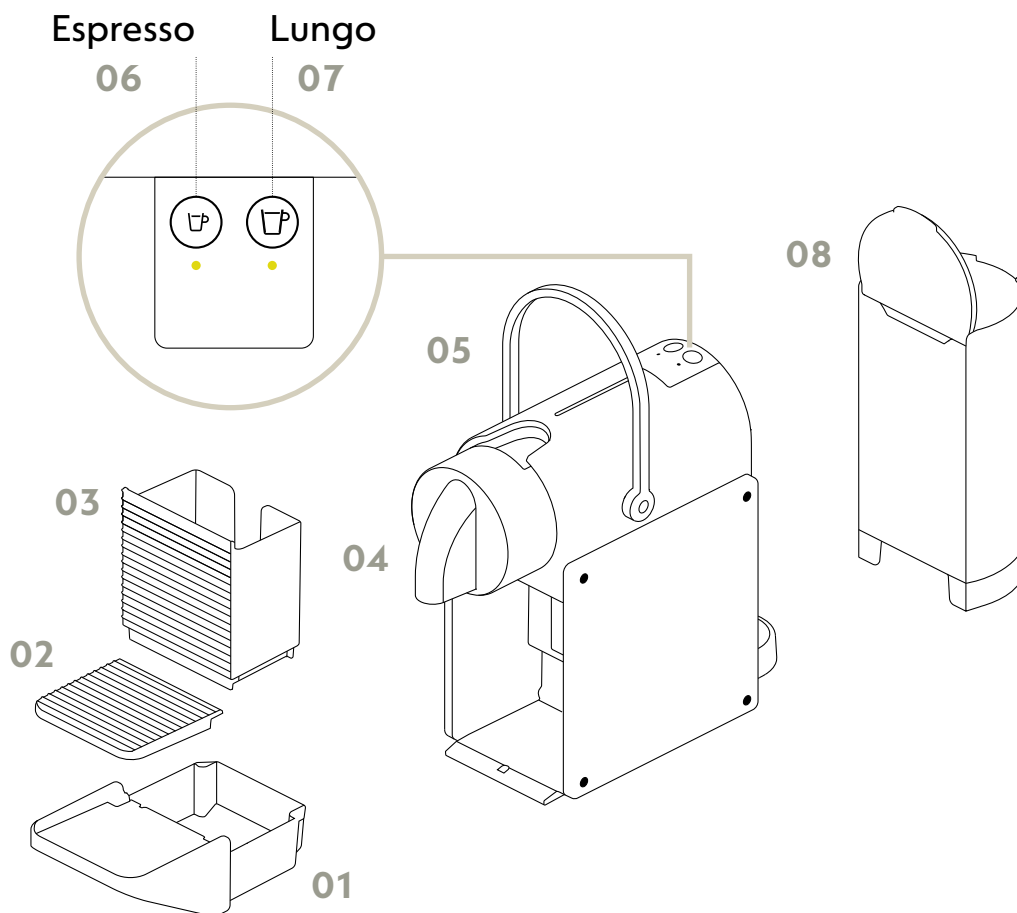

01. EN Drip Tray
FR Bac d'égouttage

02. EN Drip grid
FR Grille d'égouttage

03. EN Used capsule container
FR Collecteur de capsules usagées

04. EN Coffee outlet
FR Orifice de sortie du café

05. EN Lever
FR Levier

06. EN Espresso button
FR Bouton Espresso

07. EN Lungo button
FR Bouton Lungo

08. EN Water Tank
FR Réservoir d'eau



EN PACKAGING CONTENT FR CONTENU DE L'EMBALLAGE



-
- 01. **EN** Coffee machine
FR Machine à café
 - 02. **EN** Nespresso welcome booklet
FR Livret de bienvenue Nespresso
 - 03. **EN** Nespresso capsules set
FR Boîte de dégustation Nespresso
 - 04. **EN** Safety instructions
FR Consignes de sécurité
 - 05. **EN** Quick Start Guide
FR Guide de démarrage rapide
 - 06. **EN** Warranty
FR Garantie



EN ON / OFF

FR ALLUMER / ÉTEINDRE

EN ON FR ALLUMER

🕒 ~30"

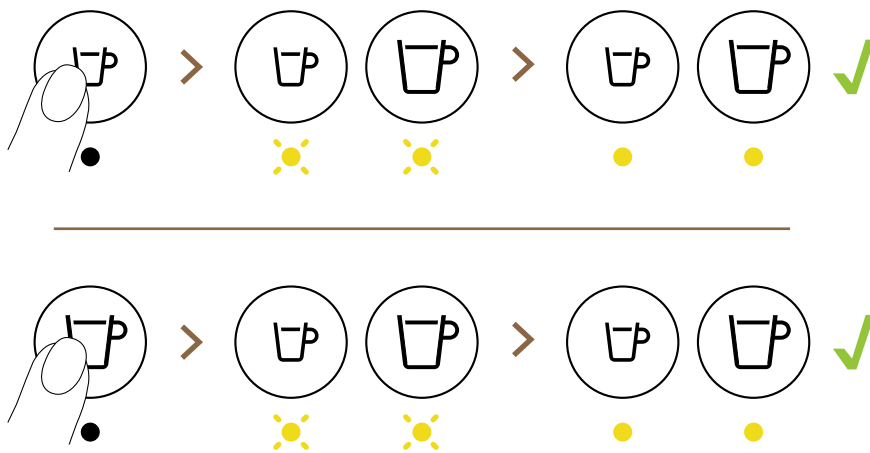

EN Turn on your machine by pressing any button. The machine will heat up in approximately 30 seconds. Lights will blink while the machine is heating up. the light becomes steady, the machine is ready.

FR Mettez votre machine en marche en appuyant sur n'importe quel bouton. La machine se réchauffera en 30 secondes environ. Les lumières clignoteront pendant que la machine se réchauffe. Si la lumière devient fixe, la machine est prête.

EN OFF FR ÉTEINDRE

🕒 <1"

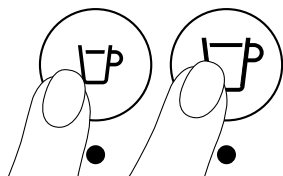

AUTO OFF /
ARRÊT AUTOMATIQUE
2 min

EN Turn off your machine by pressing both the Espresso and Lungo buttons simultaneously for less than a second. Alternatively, the machine will turn off automatically after 2 minutes of non-use.

FR Éteignez votre machine en appuyant simultanément sur les boutons Espresso et Lungo pendant moins d'une seconde. Sinon, la machine s'éteint automatiquement après 2 minutes de non-utilisation.



EN FIRST STEPS

FR PREMIÈRES ÉTAPES

- i** **EN** Unboxing: Some dust may be present on the surface of the machine due to the recycled materials used in the packaging. This is not dangerous, simply clean with a soft tissue.
- FR** Déballage : Il est possible que de la poussière soit présente sur la surface de la machine en raison des matériaux recyclés utilisés dans l'emballage. Ce n'est pas dangereux, il suffit de nettoyer avec un tissu doux.

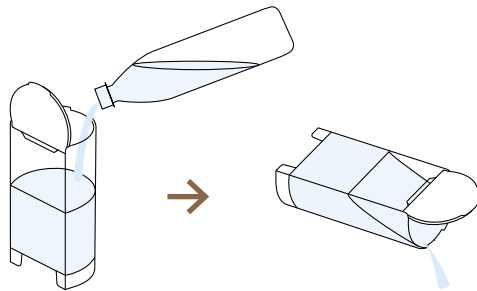

- 01. EN** Rinse to clean the water tank.
FR Rincez pour nettoyer le réservoir d'eau.

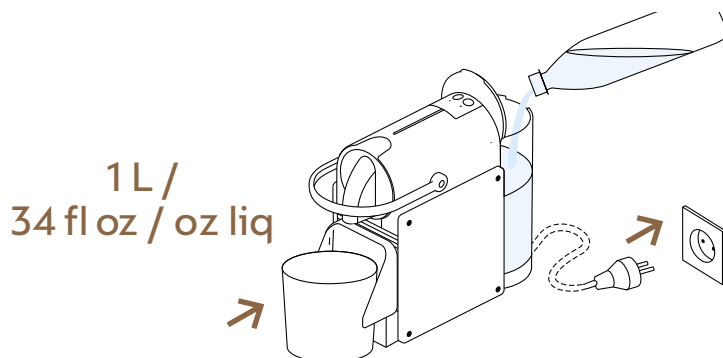

- 02. EN** Fill the water tank with fresh potable water and put it back into position. Place a container of at least one liter under the coffee outlet and plug the machine to a power outlet.
- FR** Remplissez le réservoir d'eau avec de l'eau potable fraîche et remettez-le en place. Placez un récipient d'au moins un litre sous la sortie du café et branchez la machine sur une prise de courant.



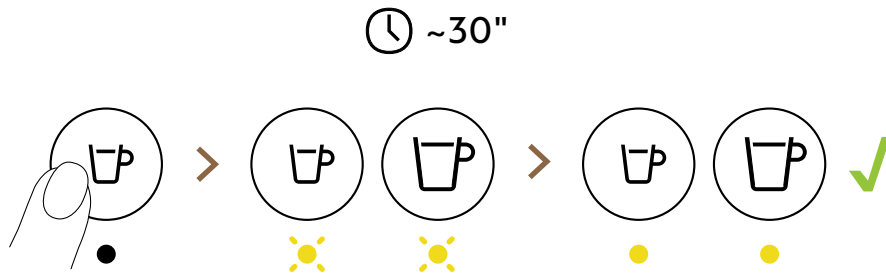

03. EN Turn on your machine by pressing any button. The machine will heat up in approximately 30 seconds. Lights will blink while the machine is heating up. When the light becomes steady, the machine is ready.

FR Mettez votre machine en marche en appuyant sur n'importe quel bouton. L'appareil se réchauffera en 30 secondes environ. Les lumières clignoteront pendant que la machine se réchauffe. Lorsque le voyant devient fixe, la machine est prête.

Lungo

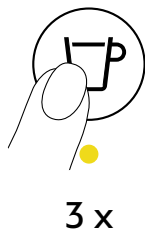

04. EN To rinse your machine, press the Lungo button. Repeat three times. Your machine is now ready to use.

FR Pour rincer votre machine, appuyez sur le bouton Lungo. Répétez l'opération trois fois. Votre machine est maintenant prête à être utilisée.



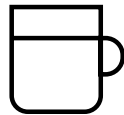

EN COFFEE PREPARATION FR PRÉPARATION DU CAFÉ

EN BUILD THE COFFEE CORNER OF YOUR DREAMS FR CRÉEZ LE COIN CAFÉ DE VOS RÊVES



EN Choose your favourite coffee or subscription plan that suits you, we'll take care of the rest.

FR Choisissez votre café préféré ou le plan d'abonnement qui vous convient, nous nous occupons du reste.



EN Discover the **Pixie** Collection.

FR Découvrez la collection **Pixie**.

EN Discover more at www.nespresso.com

FR Découvrez-en plus sur www.nespresso.com

EN COFFEE PREPARATION FR PRÉPARATION DU CAFÉ

🕒 ~30"

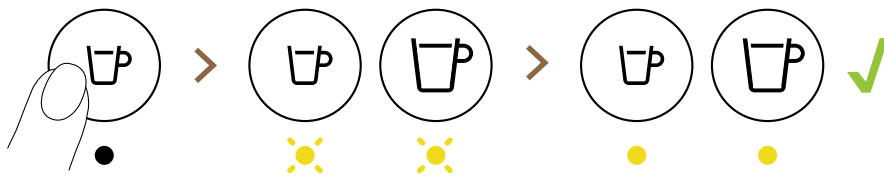

01. EN Turn on your machine by pressing any button. The machine will heat up in approximately 30 seconds. Lights will blink while the machine is heating up. When the light becomes steady, the machine is ready.

FR Mettez votre machine en marche en appuyant sur n'importe quel bouton. L'appareil se réchauffera en 30 secondes environ. Les lumières clignoteront pendant que la machine se réchauffe. Lorsque le voyant devient fixe, la machine est prête.

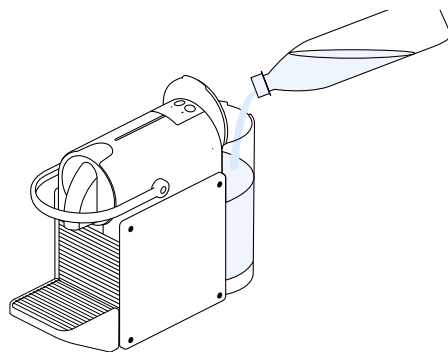

02. EN Fill the water tank with fresh potable water and put it back into position.

FR Remplissez le réservoir d'eau avec de l'eau potable fraîche et remettez-le en place.



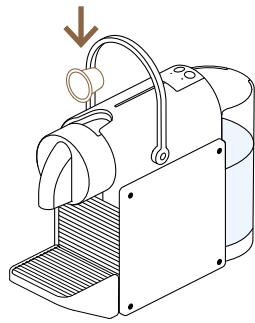

03. EN Open the machine by lifting the lever completely.
Insert a capsule.

FR Ouvrez la machine en soulevant complètement le levier.
Insérez une capsule.

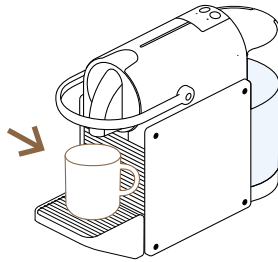

04. EN Close the lever. Place a cup with sufficient capacity.

FR Fermez le levier. Placez une tasse à capacité suffisante.

Espresso

40 ml /
1.35 fl oz / oz liq

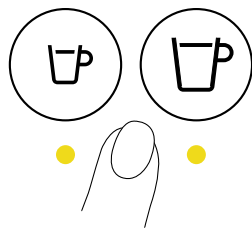

Lungo

110 ml /
3.75 fl oz / oz liq

05. EN Press on the corresponding coffee button. The brewing process starts and will stop automatically. If you wish to stop the flow or top up your coffee, press again.

FR Appuyez sur le bouton café correspondant. Le processus d'infusion commence et s'arrête automatiquement. Si vous souhaitez arrêter l'écoulement ou remplir votre café, appuyez à nouveau sur la touche.



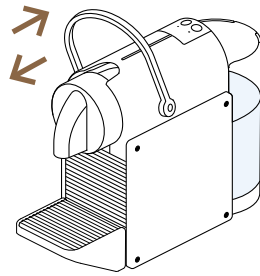

06. EN To eject the capsule into the used capsule container, lift and close the machine lever.

FR Pour éjecter la capsule dans le conteneur de capsules usagées, soulevez et fermez le levier de la machine.



EN Upgrade your coffee experience and prepare indulgent milk recipes with your **Aeroccino** milk frother. Discover the range on www.nespresso.com

FR Améliorez votre expérience du café et préparez de délicieuses recettes au lait avec votre mousser à lait **Aeroccino**. Découvrez la gamme sur www.nespresso.com

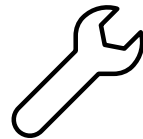

EN MAINTENANCE

FR ENTRETIEN

EN Cleaning
FR Nettoyage

EN Descaling
FR D etartrage

EN Preparing for repair or storage
FR Pr paration   la r paration ou au stockage

EN CLEANING

FR NETTOYAGE

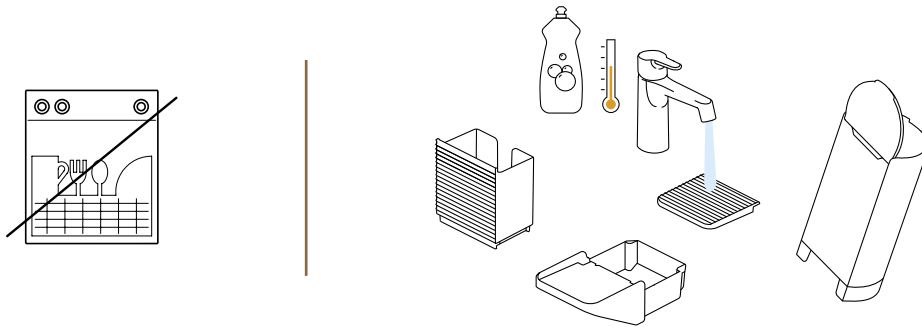

01. EN Do not put any part of the machine into the dishwasher. Be sure to unplug the machine before cleaning. We recommend emptying the drip tray and used capsule container everyday. Also remove the water tank. Clean them all with odourless detergent and rinse with warm or hot water.

FR Ne mettez aucune partie de la machine dans le lave-vaisselle. Veillez à débrancher la machine avant de la nettoyer. Nous vous recommandons de vider le bac d'égouttage et le récipient à capsules usagées tous les jours. Retirez également le réservoir d'eau. Nettoyez-les tous avec un détergent inodore et rincez-les à l'eau tiède ou chaude.

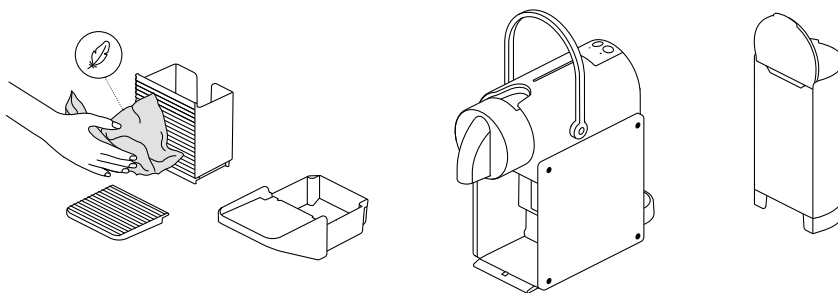

02. EN Dry with a clean and fresh towel, cloth or paper and reassemble all parts.

FR Séchez avec une serviette, un tissu ou du papier propre et frais et réassemblez toutes les pièces.





EN Clean the coffee outlet and machine surfaces regularly with a damp cloth.

FR Nettoyez régulièrement la sortie du café et les surfaces de la machine à l'aide d'un chiffon humide.

EN You should not use sharp objects, brushes or sharp abrasives, as well as strong cleaning agent or solvent cleaner.

FR Vous ne devez pas utiliser d'objets tranchants, de brosses ou de matériaux abrasifs pointus, ni de produits de nettoyage puissants ou de solvants.





EN DESCALING

FR DÉTARTRAGE

EN MATERIALS:

FR MATÉRIAUX :

- EN Descaling agent ( www.nespresso.com)
- FR Détartrant ( www.nespresso.com)
- EN 1 L container (34 fl oz)
- FR Réservoir de 1 L (34 oz liq)

EN TIME:

FR TEMPS :

- EN The process takes approximately 15 minutes
- FR Le processus prend environ 15 minutes



EN WARNING: The descaling solution can be harmful.

Avoid contact with eyes, skin and surfaces.

FR ATTENTION : La solution détartrante peut être nocive.

Éviter tout contact avec les yeux, la peau et les surfaces.



EN If you want to pause the descaling process, you can press any button.

FR Si vous voulez interrompre le processus de détartrage, vous pouvez appuyer sur n'importe quel bouton.

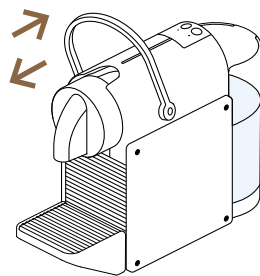

01. EN Lift and close the lever to eject the capsule into the used capsule container.

FR Soulevez et fermez le levier pour éjecter la capsule dans le conteneur de capsules usagées.



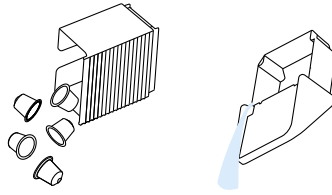

02. EN Empty the drip tray and the used capsule container before turning the machine ON.

FR Vider le support de tasse, le collecteur de capsules usagées avant de mettre la machine en marche.

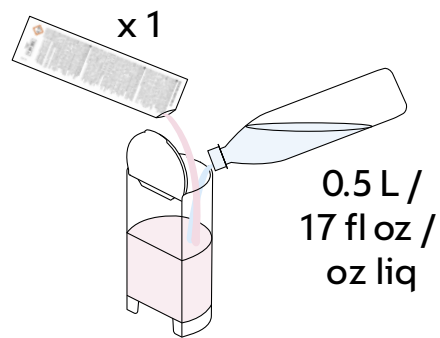

EN Fill the water tank with fresh potable water up to 0.5 liter (17 fl oz) and add one unit of **Nespresso** descaling kit.

FR Remplissez le réservoir d'eau avec de l'eau potable fraîche jusqu'à 0,5 litre (17 oz liq) et ajoutez une unité de kit de détartrage **Nespresso**.

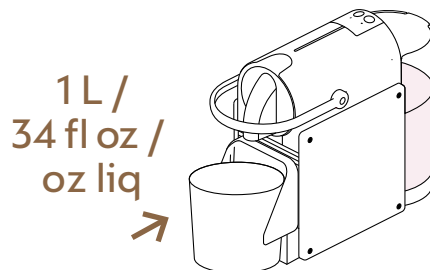

04. EN Place a container under the coffee outlet with a minimum volume of 1 liter (34 fl oz).

FR Placez un récipient (minimum 34 oz liq / 1 L) sous la sortie du café.

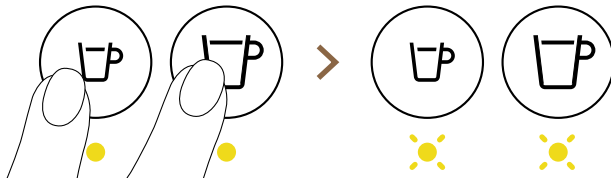

 >6"

05. EN To enter descaling mode, simultaneously press the Espresso and Lungo buttons for more than 6 seconds until both lights start blinking.

FR Pour entrer en mode détartrage, appuyez simultanément sur les boutons Espresso et Lungo pendant plus de 6 secondes jusqu'à ce que les deux voyants commencent à clignoter.

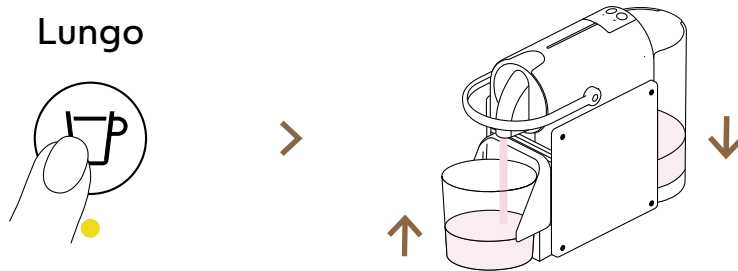

06. EN Start the first cycle of the descaling process by pressing the Lungo button and wait until the water tank is empty.

FR Lancez le premier cycle du processus de détartrage en appuyant sur le bouton Lungo et attendez que le réservoir d'eau soit vide.



07. EN Refill the water tank with the liquid from the container and descale again by pressing the Lungo button.

FR Remplissez le réservoir d'eau avec le liquide du récipient et détartré à nouveau en appuyant sur le bouton Lungo.



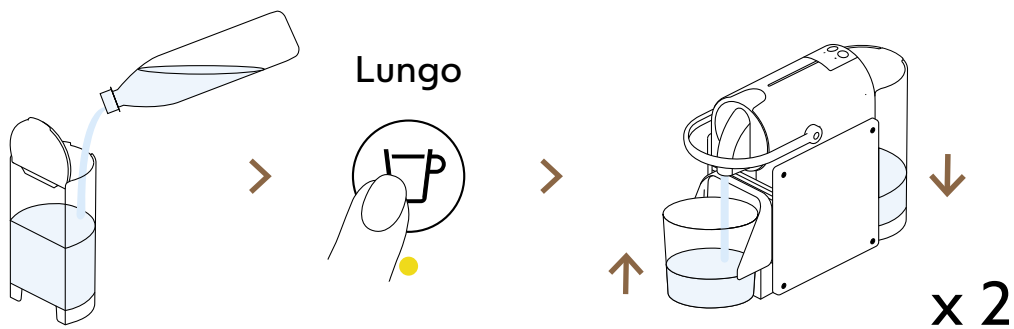

- 08. EN** Rinse the water tank, fill it with fresh potable water. Place a 1 L (34 fl oz) container under the coffee outlet and press the Lungo button to start rinsing. Repeat the process one again.
- FR** Rincez le réservoir d'eau, remplissez-le d'eau potable fraîche. Placez un récipient de 1 L (34 oz liq) sous la sortie du café et appuyez sur le bouton Lungo pour commencer le rinçage. Répétez le processus une fois de plus.

🕒 >5"

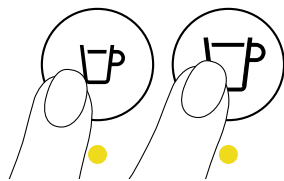

- 09. EN** Descaling is now complete. Exit descaling mode by pressing simultaneously Espresso and Lungo buttons for more than 5 seconds.

FR Le détartrage est maintenant terminé. Sortez du mode détartrage en appuyant simultanément sur les boutons Espresso et Lungo pendant plus de 5 secondes.



EN PREPARING FOR REPAIR OR STORAGE FR PRÉPARATION À LA RÉPARATION OU AU STOCKAGE

**EN BEFORE A PERIOD OF NON-USE AND FOR FROST PROTECTION, OR BEFORE A REPAIR
FR AVANT UNE PÉRIODE DE NON-UTILISATION ET POUR LA PROTECTION CONTRE LE GEL, OU AVANT UNE RÉPARATION**

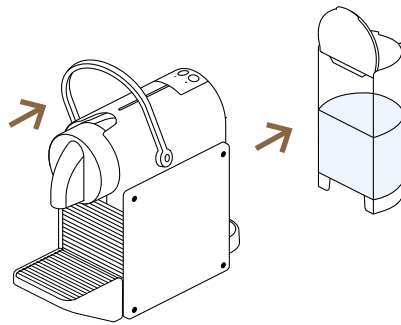

- 01. EN** When the machine is switched off, remove the water tank and lift the lever to eject any capsule.
FR Lorsque la machine est éteinte, retirez le réservoir d'eau et soulevez le levier pour éjecter toute capsule.

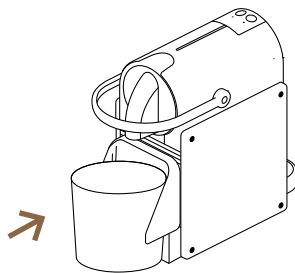

- 02. EN** Place a container under the coffee outlet.
FR Placez un récipient sous la sortie du café.

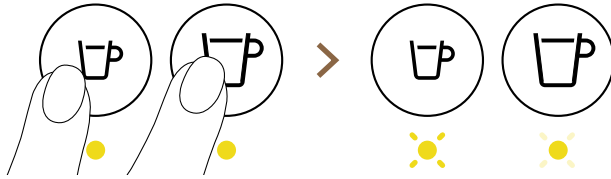

 >5"

- 03. EN** Press and hold simultaneously Espresso and Lungo buttons for more than 5 seconds. Buttons will blink alternatively.
FR Appuyez et maintenez simultanément les boutons Espresso et Lungo pendant plus de 5 secondes. Les boutons clignoteront en alternance.

i **EN** Machine switches off when the procedure is finished.
FR La machine s'éteint lorsque la procédure est terminée.

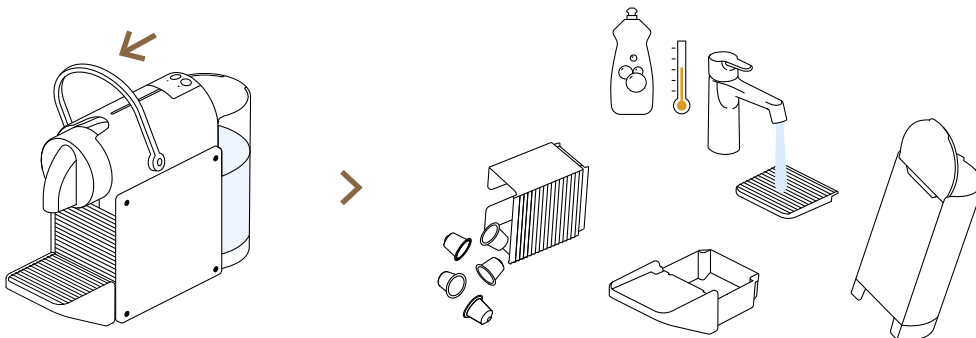

- 04. EN** Be sure to unplug the machine before cleaning. Empty the drip tray, used capsule container and remove the water tank. Clean them all with odourless detergent and rinse with warm or hot water.

Do not put any part of the machine into the dishwasher.

FR Veillez à débrancher la machine avant de la nettoyer. Videz le plateau d'égouttage, le collecteur de capsules usagées et retirez le réservoir d'eau. Nettoyez-les tous avec un détergent inodore et rincez-les à l'eau tiède ou chaude.

Ne mettez aucune pièce de la machine dans le lave-vaisselle.





EN TROUBLESHOOTING FR DÉPANNAGE

EN TROUBLESHOOTING

FR DÉPANNAGE

EN No light indicator

FR Pas d'indicateur lumineux

- **EN** Check the power outlet, plug, voltage, and fuse. In case of problems, call **Nespresso**.
- **FR** Vérifiez la prise de courant, la fiche, la tension et le fusible. En cas de problème, appelez **Nespresso**.

EN No coffee, no water

FR Pas de café, pas d'eau

- **EN** First use: fill water tank with water (max. 55° C / 130° F) and run through machine according to instructions on page **42**.
- **FR** Première utilisation : remplissez le réservoir d'eau (max. 55° C / 130° F) et faites fonctionner la machine selon les instructions de la page **42**.
- **EN** Water tank is empty. Fill water tank.
- **FR** Le réservoir d'eau est vide. Remplissez le réservoir d'eau.
- **EN** Descale if necessary; see Descaling section on page **51**.
- **FR** Détartrez si nécessaire ; voir la section Détartrage à la page **51**.

EN Coffee comes out very slowly

FR Le café s'écoule très lentement

- **EN** Flow speed depends on the coffee variety.
- **FR** La vitesse d'écoulement dépend de la variété de café.
- **EN** Descale if necessary; see Descaling section on page **51**.
- **FR** Détartrez si nécessaire ; voir la section Détartrage à la page **51**.



EN Coffee is not hot enough
FR Le café n'est pas assez chaud

- **EN** Descale if necessary; see Descaling section on page **51**.
FR Détartrez si nécessaire ; voir la section Détartrage à la page **51**.

EN Error mode:
 The 2 lights flash fast together every 3 seconds
FR Mode d'erreur :
 Les 2 lumières clignotent rapidement ensemble toutes les 3 secondes

- **EN** Unplug and replug the machine. If the problem persists, call **Nespresso**.
FR Débranchez et rebranchez la machine. Si le problème persiste, appelez **Nespresso**.

i **EN** In case of intensive use (more than 10 coffees in one go, without stop), the machine can go into overheating mode. Wait a maximum of 10 minutes before using it again. Both buttons will flash slowly, do not unplug the machine. This is a normal step after a rest period to protect the pump.
FR En cas d'utilisation intensive (plus de 10 cafés en une seule fois, sans arrêt), la machine peut se mettre en mode surchauffe. Attendez un maximum de 10 minutes avant de la réutiliser. Les deux boutons vont clignoter lentement, ne débranchez pas la machine. Il s'agit d'une étape normale après une période de repos pour protéger la pompe.



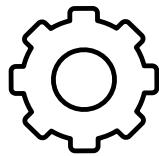

EN SETTINGS FR PARAMÈTRES

EN Specifications
FR Spécifications

EN Personalize your coffee size
FR Personnalisez la taille de votre café

EN Reset to factory settings
FR Réinitialisation des paramètres d'usine

EN Water hardness settings
FR Paramètres de dureté de l'eau

EN Energy saving mode
FR Mode d'économie d'énergie

EN Disposal and environmental protection
FR Élimination et protection de l'environnement

EN SPECIFICATIONS

FR SPÉCIFICATIONS

EN DIMENSIONS

FR DIMENSIONS

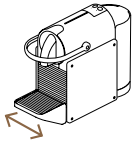

EN 116.6 mm / 4.65 inch
FR 116,6 mm / 4,65 pouces

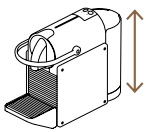

EN 234.6 mm / 9.25 inch
FR 234,6 mm / 9,25 pouces

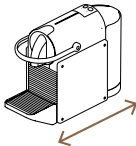

EN 324.2 mm / 12.75 inch
FR 324,2 mm / 12,75 pouces

EN WEIGHT

FR POIDS

2.47 kg / 5.47 lbs
 2,47 kg / 5,47 lbs

EN WATER TANK CAPACITY

FR CAPACITÉ DU RÉSERVOIR D'EAU

0.7 L / 24 fl oz
 24 oz liq / 0,7 L

EN CAPSULE CONTAINER CAPACITY

FR CAPACITÉ DU RÉCIPIENT À CAPSULES

9-11 capsules



EN POWER
FR ALIMENTATION

220-240 V ~, 50-60 Hz, 1 260 W

BR/KR	220 V ~, 60 Hz, 1 150 W
BR/MX	127 V ~, 60 Hz, 1 350 W
CA/CO/DO/PA/US	120 V ~, 60 Hz, 1 160 W
CL/CN	220 V ~, 50 Hz, 1 150 W
DO/TW	110 V ~, 60 Hz, 1 000 W
PH	220 V ~, 60 Hz, 1 200 W

EN MACHINE CODE
FR CODE MACHINE

Nespresso	C62, D62
Breville	BEC440, BEC470
DeLonghi	EN127.S, EN127.BL
Krups	XN306T, XN3067
Magimix	M113



EN PERSONALIZE YOUR COFFEE SIZE

FR PERSONNALISEZ LA TAILLE DE VOTRE CAFÉ

EN YOUR PIXIE MACHINE IS PREPROGRAMMED TO OBTAIN THE BEST IN-CUP RESULT. IN ORDER TO GET AS CLOSE AS TO YOUR PERSONAL EXPECTATIONS YOU CAN REPROGRAM THE VOLUME OF YOUR COFFEE ACCORDING TO YOUR TASTES. FR VOTRE MACHINE PIXIE EST PRÉPROGRAMMÉE POUR OBTENIR LE MEILLEUR RÉSULTAT DANS LA TASSE. AFIN DE VOUS RAPPROCHER LE PLUS POSSIBLE DE VOS ATTENTES PERSONNELLES, VOUS POUVEZ REPROGRAMMER LE VOLUME DE VOTRE CAFÉ EN FONCTION DE VOS GOÛTS.

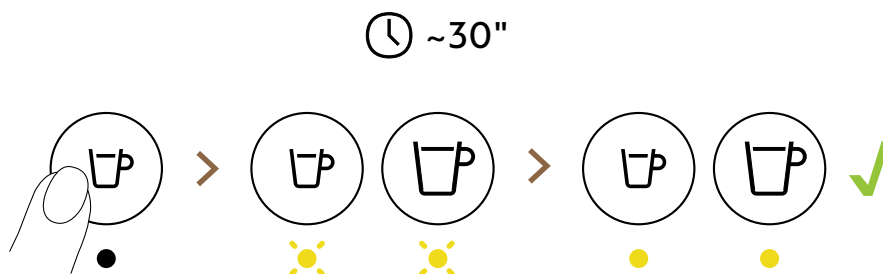

01. EN Turn on your machine by pressing any button. The machine will head up in approximately 30 seconds. Lights will blink while the machine is heading up. When the light becomes steady, the machine is ready.

FR Mettez votre machine en marche en appuyant sur n'importe quel bouton. La machine se met en marche en 30 secondes environ. Les lumières clignoteront pendant que la machine se met en marche. Lorsque le voyant devient fixe, la machine est prête.



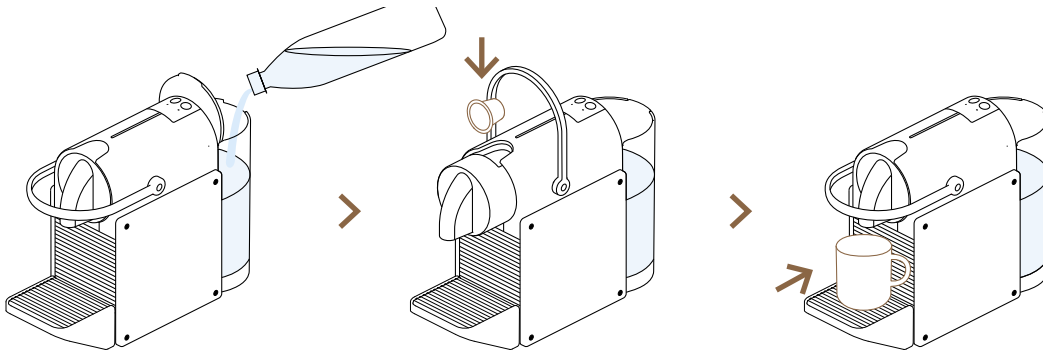

- 02. EN** Fill the water tank with fresh potable water and insert a capsule. Place a cup under the coffee outlet.
FR Remplissez le réservoir d'eau avec de l'eau potable fraîche et insérez une capsule. Placez une tasse sous la sortie du café.

Espresso

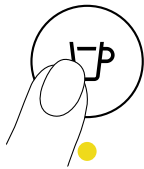

Lungo

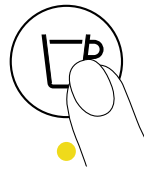

- 03. EN** To programm the desired volume for any Espresso or Lungo press and hold the Espresso or Lungo buttons until the machine starts brewing.
FR Pour programmer le volume désiré pour un Espresso ou un Lungo, appuyez et maintenez les boutons Espresso ou Lungo jusqu'à ce que la machine commence à infuser.

Espresso

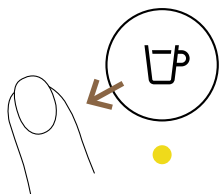

Lungo

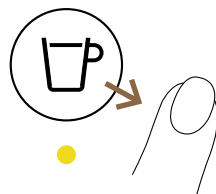

- 04. EN** Release the button once the desired volume is served.
FR Relâchez le bouton une fois que le volume souhaité est servi.





3 x

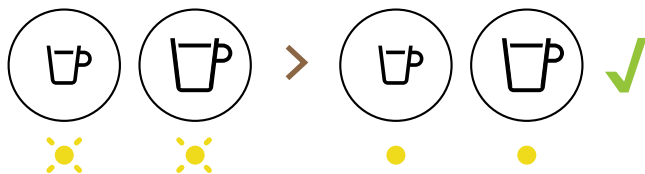

-
- 05. EN** Lights will blink fast 3 times to confirm new setting.
FR Les lumières clignoteront rapidement 3 fois pour confirmer le nouveau réglage.



EN RESET TO FACTORY SETTINGS FR RÉINITIALISATION DES PARAMÈTRES D'USINE

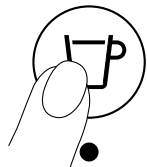

Lungo



🕒 >5"

- 01. EN** When the machine is switched off, press and hold the Lungo button for more than 5 seconds.
FR Lorsque la machine est éteinte, appuyez sur le bouton Lungo et maintenez-le enfoncé pendant plus de 5 secondes.

EN FACTORY SETTINGS FR PARAMÈTRES D'USINE

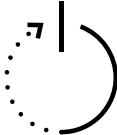
 <p>Espresso 40 ml / 1.35 fl oz 1,35 oz liq / 40 ml</p>	 <p>Lungo 110 ml / 3.75 fl oz 3,75 oz liq / 110 ml</p>	 <p>AUTO OFF / ARRÊT AUTOMATIQUE 2 min</p>
---	--	---



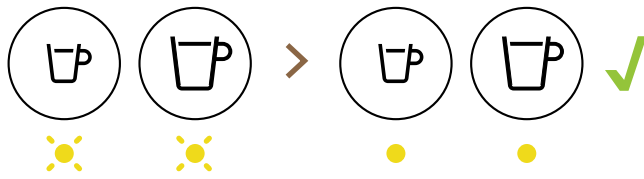

02. EN Lights will blink fast 3 times to confirm that the factory settings are restored.

FR Les lumières clignoteront rapidement 3 fois pour confirmer que les paramètres d'usine sont restaurés.



EN WATER HARDNESS SETTINGS

FR PARAMÈTRES DE DURETÉ DE L'EAU

EN Water hardness FR Dureté de l'eau	EN High FR Haut	EN Medium FR Medium	EN Low FR Faible
CaCO ₃ EN Calcium Carbonate FR Calcium Carbonate	360 mg/l	180 mg/l	0 mg/l

EN We invite you to descale your machine after:
FR Nous vous invitons à détartrer votre machine après :

	40 ml / 1.35 fl oz 1,35 oz liq / 40 ml	EN 1 000 coffees FR 1 000 cafés	2 000 coffees 2 000 cafés	4 000 coffees 4 000 cafés
--	---	------------------------------------	------------------------------	------------------------------



EN ENERGY SAVING MODE FR MODE D'ÉCONOMIE D'ÉNERGIE

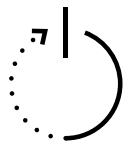

AUTO OFF /
ARRÊT
AUTOMATIQUE
2 min

EN The machine will turn off automatically after 2 minutes of non-use.

FR La machine s'éteint automatiquement après 2 minutes de non-utilisation.

EN TO CHANGE THIS SETTING FR POUR MODIFIER CE PARAMÈTRE

Espresso

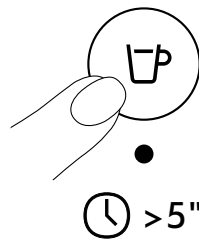

01. EN When the machine is switched off, press and hold the Espresso button more than 5 seconds.

FR Lorsque la machine est éteinte, appuyez sur le bouton Espresso pendant plus de 5 secondes.

EN 1 x =
AUTO OFF
2 min
FR 1 X =
ARRÊT
AUTOMATIQUE
2 min

Espresso



Espresso



EN 2 x =
AUTO OFF
9 min
FR 2 X =
ARRÊT
AUTOMATIQUE
9 min

02. EN Choose your saving mode by pressing the Espresso button.
FR Choisissez votre mode d'économie en appuyant sur le bouton Espresso.





Lungo

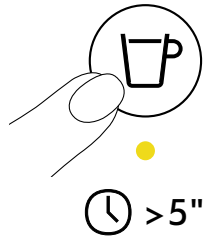

03. EN To exit - press and hold the Lungo button for more than 5 seconds.

FR Pour sortir - appuyez sur le bouton Lungo et maintenez-le enfoncé pendant plus de 5 secondes.



EN DISPOSAL AND ENVIRONMENTAL PROTECTION FR ÉLIMINATION ET PROTECTION DE L'ENVIRONNEMENT

EN This appliance complies with the EU Directive 2012/19/EC. Packaging materials and appliance contain recyclable materials. Your appliance contains valuable materials that can be recovered or can be recycled. Separation of the remaining waste materials into different types facilitates the recycling of valuable raw materials. Leave the appliance at a collection point. You can obtain information on disposal from your local authorities.

FR Cette machine est conforme à la directive européenne 2012/19/CE. Les matériaux d'emballage et la machine contiennent des matériaux recyclables. Votre machine contient des matériaux de valeur pouvant être récupérés ou recyclés. La séparation des déchets restants en différentes catégories facilite le recyclage de ces matières premières. Déposez votre machine dans un point de collecte. Renseignez-vous auprès de vos institutions locales sur les méthodes de collecte.



EN Discover more about sustainability:

FR Pour en savoir plus sur la durabilité :

www.nespresso.com

¿CÓMO NAVEGAR EN EL MANUAL DE USUARIO?

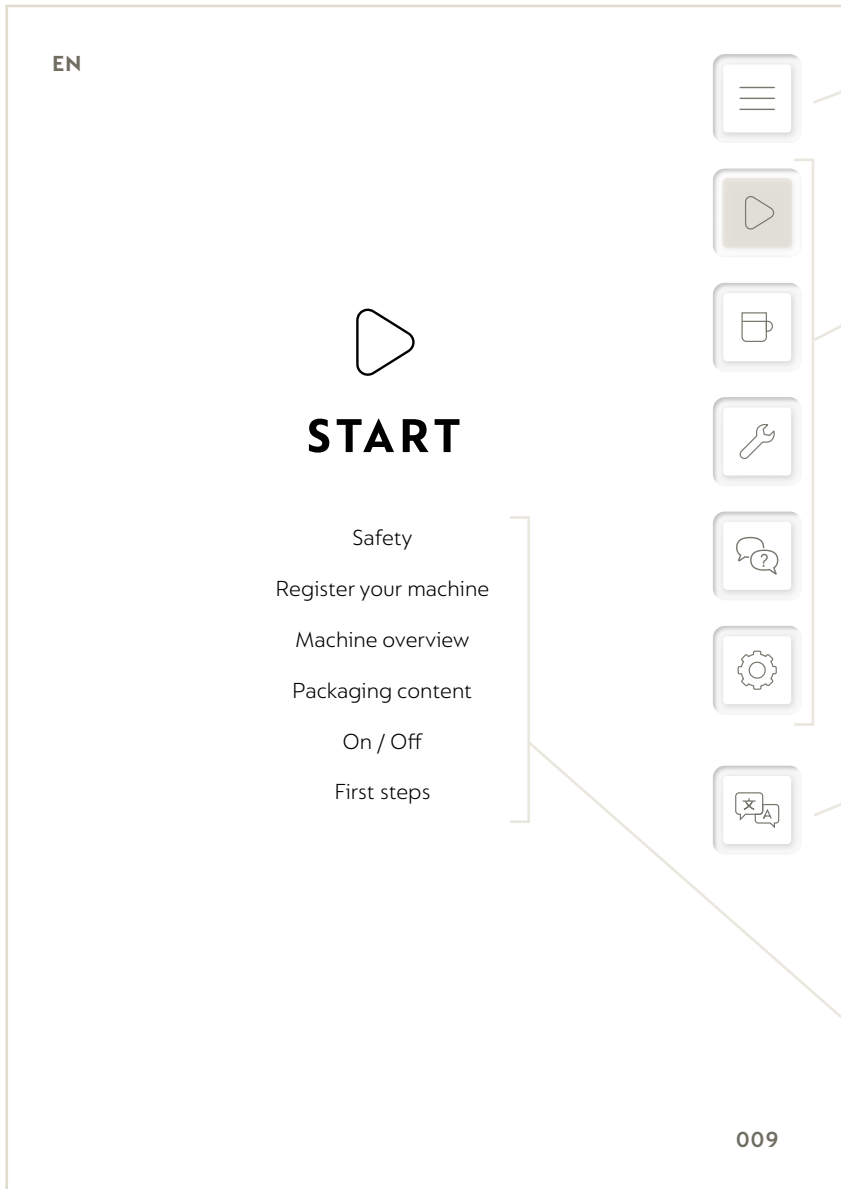

Haga clic aquí para volver a la tabla de contenido

Haga clic aquí para ir directamente a un capítulo específico

Haga clic aquí para elegir su idioma preferido

Se puede hacer clic en todos los módulos, haga clic en ellos para ir directamente a donde necesite

CONTENIDO



INICIO

- Seguridad
 - Registre su máquina
 - Descripción de la máquina
 - Contenido del empaque
 - Encendido / Apagado
 - Primeros pasos
-



PREPARACIÓN DE CAFÉ



MANTENIMIENTO

- Limpieza
 - Descalcificación
 - Preparación para reparación o almacenaje
-



SOLUCIÓN DE PROBLEMAS



AJUSTES

- Especificaciones
- Personalice el tamaño de su café
- Resetear los valores de fábrica
- Ajuste de la dureza del agua
- Modo de ahorro de energía
- Disposición y protección ambiental



INICIO

Seguridad

Registre su máquina

Descripción de la máquina

Contenido del empaque

Encendido / Apagado

Primeros pasos

SEGURIDAD

PRECAUCIÓN: Antes de utilizar su máquina de café, consulte las instrucciones de seguridad para evitar posibles daños y perjuicios.

www.nespresso.com

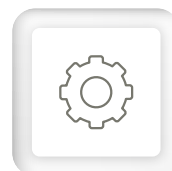

**DESCUBRA CÓMO USAR
SU MÁQUINA DE CAFÉ NESPRESSO EN**

www.youtube.com

REGISTRE SU MÁQUINA

Como Socio **Nespresso**, se beneficia del soporte de por vida de nuestros Especialistas en Café, incluidos los servicios de asistencia en máquinas. Ingrese el número de serie de su nueva máquina cuando se registre por primera vez, para ayudarnos a proporcionarle asistencia personalizada. Este código de 19 dígitos se encuentra en la bandeja de goteo o debajo de su máquina.

www.nespresso.com

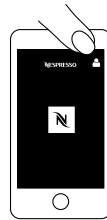

01. Conéctese en nespresso.com **02.** Inicie sesión en su cuenta.



03. Agregue una máquina y siga los pasos.



El número de serie, que contiene 19 caracteres, se encuentra debajo del código de barras. Este número está escrito en una etiqueta, que representa la identidad de su máquina. La información nos ayuda a verificar su modelo y a tener el mejor seguimiento si su máquina necesita ser enviada a nuestro centro de reparación. La etiqueta con el número de serie se puede encontrar de la siguiente manera:

- En la bandeja de goteo
- Debajo de la máquina
- En el empaque de la máquina



DESCRIPCIÓN DE LA MÁQUINA

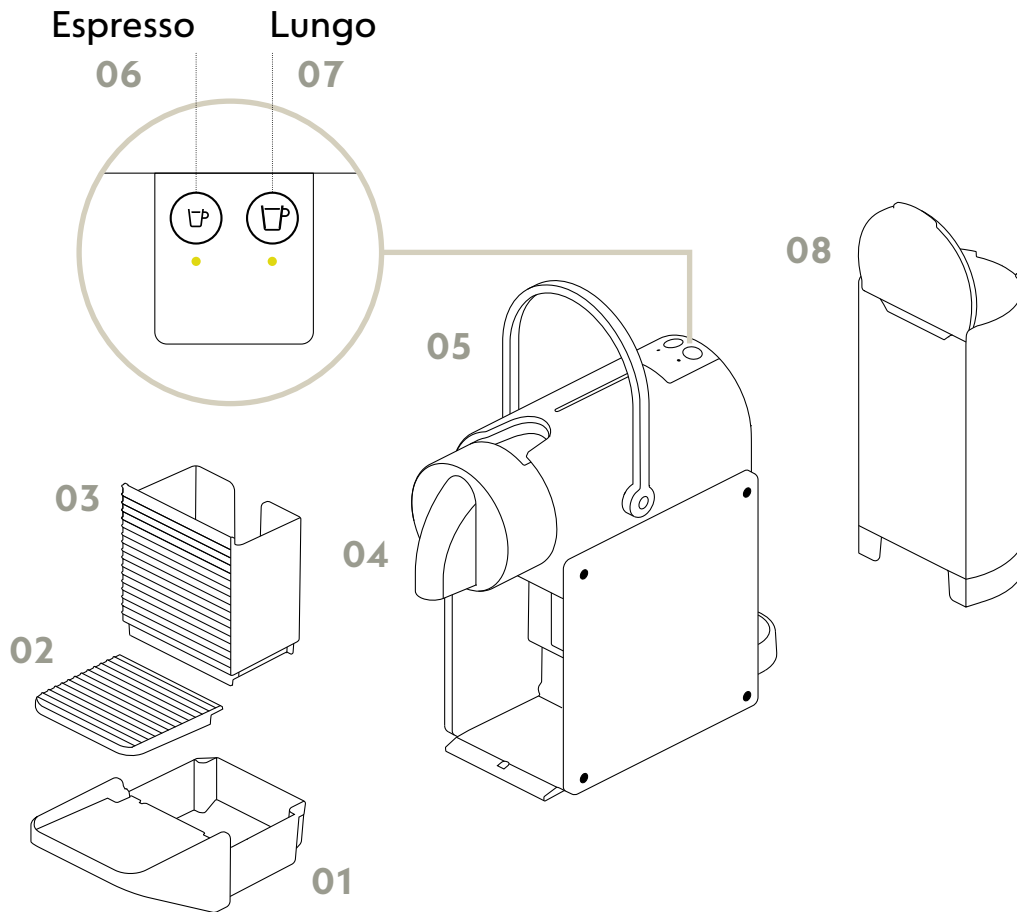

01. Bandeja de goteo

02. Rejilla de goteo

03. Contenedor de cápsulas usadas

04. Salida de café

05. Manija

06. Botón Espresso

07. Botón Lungo

08. Tanque de agua



CONTENIDO DEL EMPAQUE



-
- 01. Máquina de café
 - 02. Brochure de Bienvenida a Nespresso
 - 03. Set de cápsulas Nespresso
 - 04. Instructivo de seguridad
 - 05. Guía de inicio rápido
 - 06. Garantía



ENCENDIDO / APAGADO

ENCENDIDO

🕒 ~30"

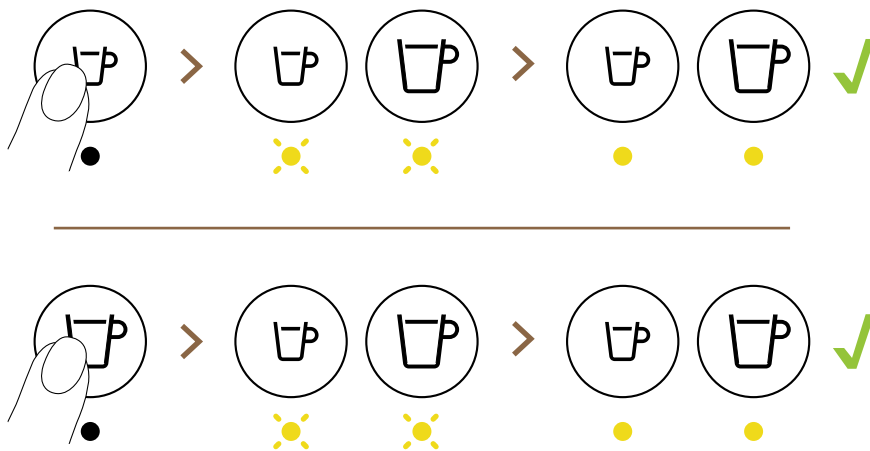

Encienda su máquina presionando cualquier botón. La máquina se calentará en aproximadamente 30 segundos. Las luces parpadearán mientras la máquina se está calentando. Cuando la luz se vuelve estática, la máquina está lista.

APAGADO

🕒 <1"

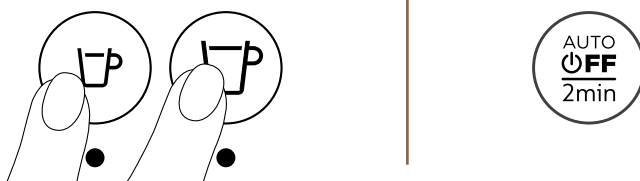

Apague su máquina presionando simultáneamente los botones Espresso y Lungo durante menos de un segundo. Adicionalmente, la máquina se apagará automáticamente después de 2 minutos sin uso.



PRIMEROS PASOS

i Desembalaje: Es posible que haya algo de polvo en la superficie de la máquina debido a los materiales reciclados utilizados en el empaque. Esto no es peligroso, simplemente límpielo con un paño suave.

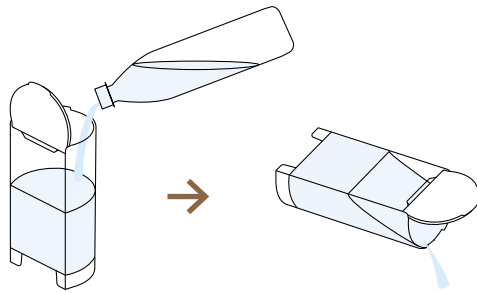

01. Enjuague para limpiar el tanque de agua.

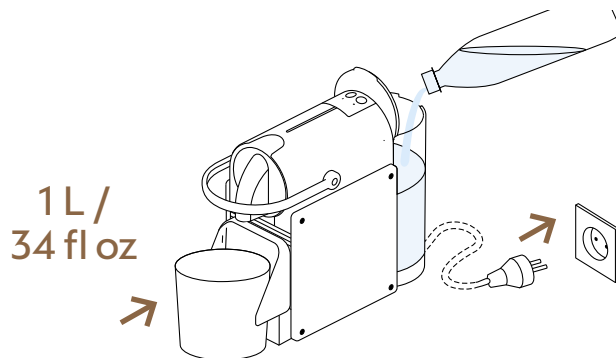

02. Llene el tanque de agua con agua potable fresca y póngalo de nuevo en su posición. Coloque el contenedor con al menos un litro de capacidad debajo de la salida de café y conecte la máquina a la corriente eléctrica.





🕒 ~30"

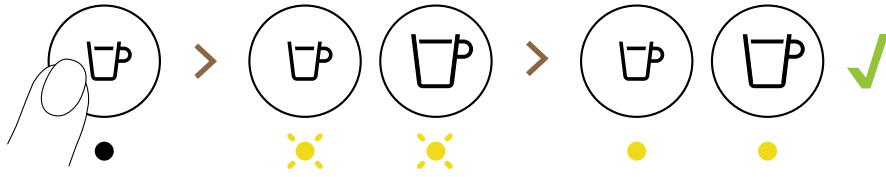

03. Encienda su máquina al presionar cualquier botón. La máquina se calentará en aproximadamente 30 segundos. Las luces parpadearán cuando la máquina se esté calentando. Cuando la luz se vuelva estática, la máquina está lista.

Lungo

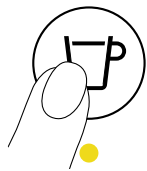

3 x

04. Para enjuagar su máquina, presione el botón Lungo. Repita tres veces. Su máquina está lista para uso.



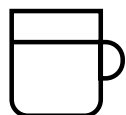
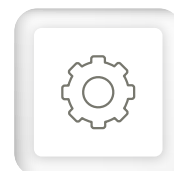

PREPARACIÓN DE CAFÉ

CONSTRUYA SU ESPACIO DE CAFÉ IDEAL



Elija su café favorito o plan de suscripción que mejor se adecue a Ud. Nosotros nos encargamos del resto.



Descubra la colección **Pixie**.

Descubra más en www.nespresso.com

PREPARACIÓN DE CAFÉ

🕒 ~30"

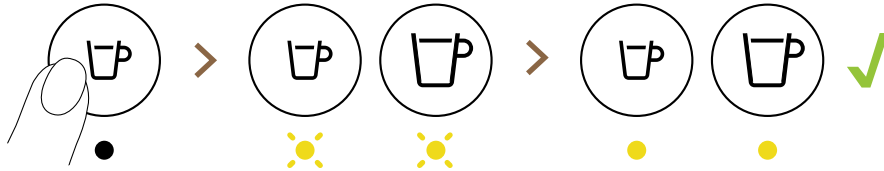

- 01.** Encienda su máquina al presionar cualquier botón. La máquina se calentará en aproximadamente 30 segundos. Las luces parpadearán cuando la máquina se esté calentando. Cuando la luz se vuelva estática, la máquina está lista.

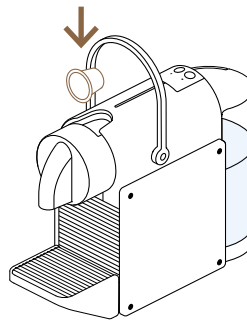
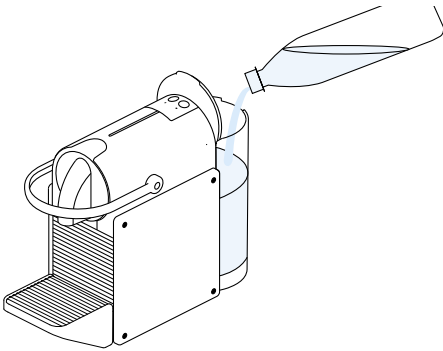

- 02.** Llene el tanque de agua con agua potable fresca y póngalo de nuevo en su posición.

- 03.** Abra la máquina levantando la palanca completamente. Inserte una cápsula.

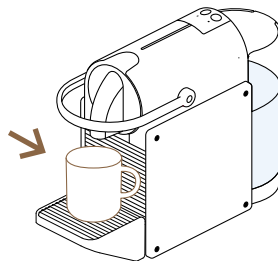

- 04.** Cierre la palanca. Coloque una taza con capacidad suficiente.



Espresso

40 ml /
1.35 fl oz

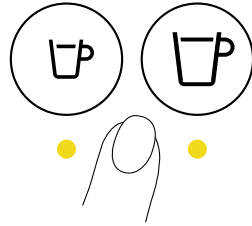

Lungo

110 ml /
3.75 fl oz

- 05.** Presione el botón que corresponda. La extracción del café inicia y se detiene automáticamente. Si desea detener el flujo de café, presione nuevamente.

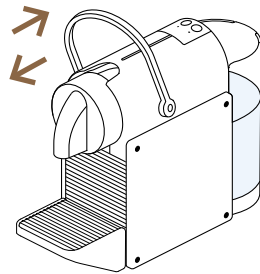

- 06.** Para expulsar la cápsula en el contenedor de cápsulas usadas, levante y cierre la palanca de la máquina.



Mejore su experiencia de café y prepare indulgentes recetas de café con su espumador de leche **Aeroccino**. Descúbralo en www.nespresso.com



MANTENIMIENTO

Limpieza

Descalcificación

Preparación para reparación o almacenaje

LIMPIEZA

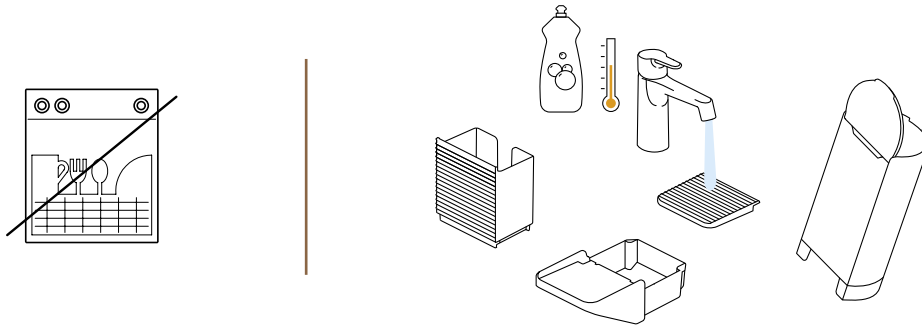

- 01.** No coloque ninguna parte de la máquina en el lavavajillas. Asegúrese de desconectar la máquina de la conexión eléctrica previo a cualquier limpieza. Recomendamos vaciar la charola de goteo y el contenedor de cápsulas usadas todos los días. También, retire el tanque de agua. Límpielos con detergente sin aroma y enjuáguelos con agua tibia o caliente.

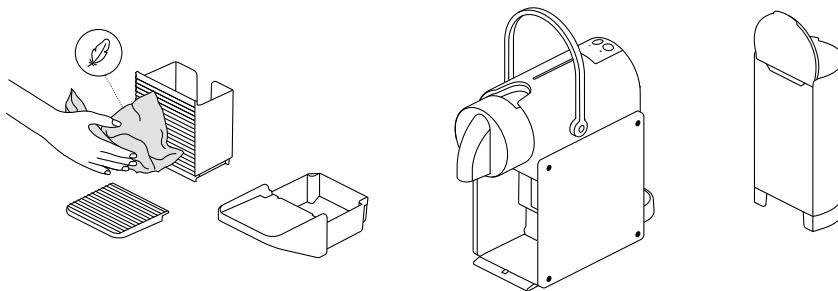

- 02.** Séquelos con una toalla o paño seco y limpio. Coloque nuevamente todas las partes.

- i** Limpie la salida de café y las superficies de la máquina de forma regular con un paño húmedo. No utilice objetos filosos, cepillos o abrasivos, agentes abrasivos de limpieza o solventes.



DESCALCIFICACIÓN

MATERIAL:

- Agente descalcificante ( disponible en www.nespresso.com)
- Contenedor de 1 L

TIEMPO:

- El proceso toma aproximadamente 15 minutos



PRECAUCIÓN: La solución descalcificante puede ser dañina. Evite el contacto con los ojos, la piel y las superficies.



Si desea pausar el proceso de descalcificación, presione cualquier botón.

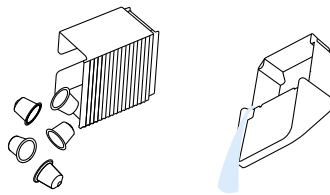
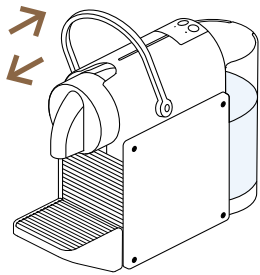

01. Levante y cierre la palanca para expulsar la cápsula al contenedor de cápsulas usadas.

02. Vacíe la charola de goteo y las cápsulas usadas antes de encender la máquina.



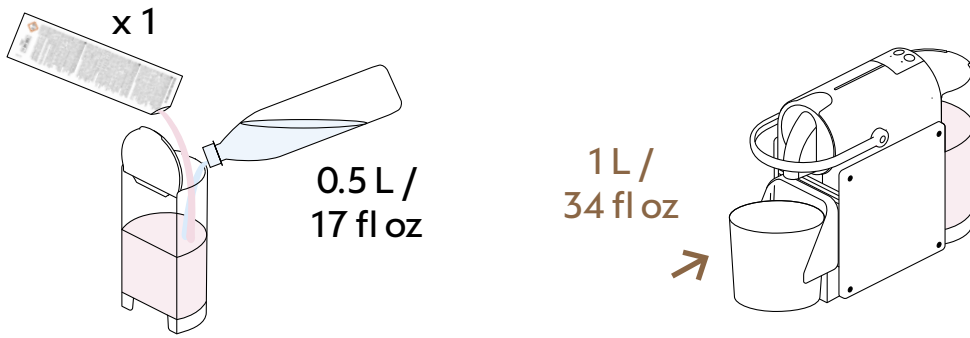

03. Llene el tanque de agua con agua potable hasta 0,5 L y agregue una unidad del kit de descalcificación **Nespresso**.

04. Coloque un contenedor debajo de la salida de café con al menos 1 litro de capacidad.

🕒 >6"

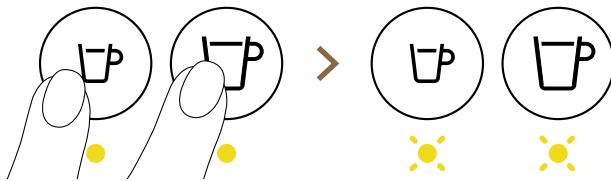

05. Para entrar al modo de descalcificación, presione simultáneamente por más de 6 segundos los botones Espresso y Lungo hasta que los dos empiecen a parpadear.

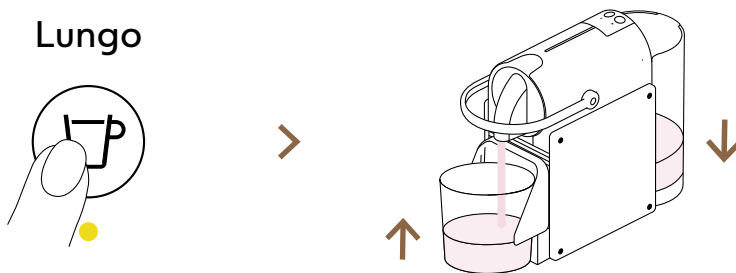

06. Inicie el primer ciclo de descalcificación presionando el botón Lungo y espere hasta que el tanque de agua esté vacío.





07. Llene nuevamente el tanque con el líquido del contenedor y descalcifique nuevamente al presionar el botón Lungo.



08. Enjuague el tanque de agua y llénelo con agua potable. Coloque un contenedor de al menos 1 L de capacidad debajo de la salida de café y presione el botón Lungo para iniciar el enjuague. Repita el proceso una vez más.

🕒 >5"

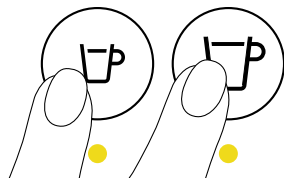

09. La descalcificación está completa. Salga del modo de descalcificación al presionar simultáneamente los botones Espresso y Lungo por más de 5 segundos.



PREPARACIÓN PARA REPARACIÓN O ALMACENAJE

ANTES DE UN PERIODO DE NO USO Y PARA PROTECCIÓN CON LAS HELADAS O ANTES DE LA REPARACIÓN

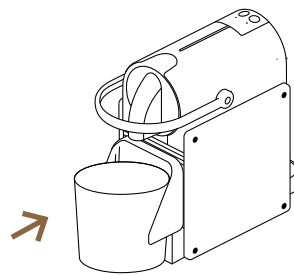
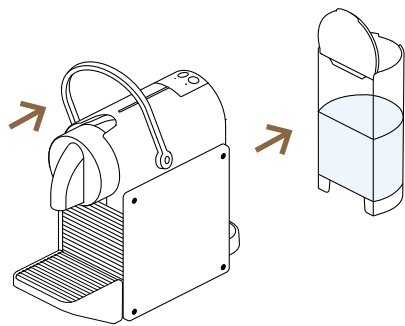

01. Cuando la máquina esté apagada, remueva el tanque de agua y levante la palanca para retirar cualquier cápsula.

02. Coloque un contenedor debajo de la salida de café.

🕒 >5"

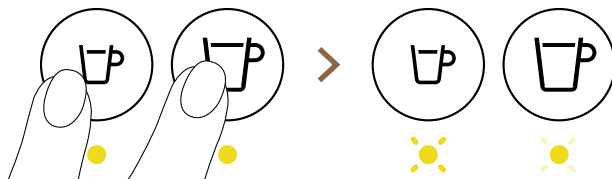

03. Presione y mantenga simultáneamente los botones Espresso y Lungo por más de 5 segundos. Los botones parpadearán simultáneamente.



La máquina se apaga cuando el proceso finalice.



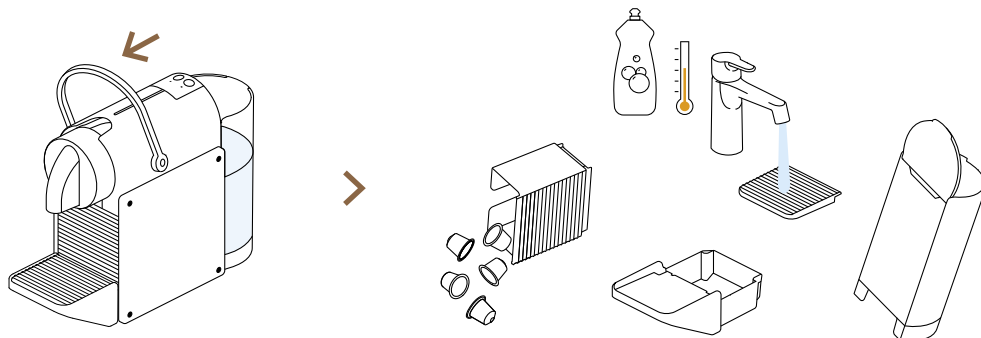

- 04.** Asegúrese de desconectar la máquina previo a la limpieza. Vacíe el contenedor de cápsulas usadas y la charola de goteo. Límpielos con detergente sin aroma y enjuáguelos con agua tibia o caliente. No coloque ninguna parte de la máquina en el lavavajillas.





SOLUCIÓN DE PROBLEMAS

SOLUCIÓN DE PROBLEMAS

No encienden las luces

- Revise la conexión eléctrica, el conector y el voltaje. En caso de problemas, comuníquese con **Nespresso**.

No hay flujo de café o agua

- Primer uso: llene el tanque de agua y realice una extracción sin cápsula de acuerdo a las instrucciones de la página **80**.
- El tanque de agua está vacío. Llene el tanque de agua.
- Descalcifique de ser necesario; referirse a la sección Descalcificación en la página **87**.

El café sale muy lentamente

- El flujo del café depende de la variedad.
- Descalcifique de ser necesario; referirse a la sección Descalcificación en la página **87**.

El café no está caliente

- Descalcifique de ser necesario; referirse a la sección Descalcificación en la página **87**.

Error: las 2 luces parpadean rápidamente cada 3 segundos

- Desconecte y reconecte la máquina. Si el problema persiste, llame a **Nespresso**.

i En caso de un uso intenso (más de 10 extracciones sin pausa), la máquina puede sobrecalentarse. Espere aproximadamente 10 minutos antes de usarla de nuevo. Los dos botones parpadearán lentamente, no desconecte la máquina. Este es un paso normal de descanso para proteger la bomba de extracción.



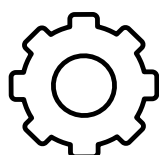

AJUSTES

Especificaciones

Personalice el tamaño de su café

Resetear los valores de fábrica

Ajuste de la dureza del agua

Modo de ahorro de energía

Disposición y protección ambiental

ESPECIFICACIONES

DIMENSIONES

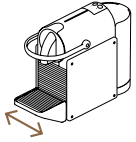

116,6 mm
4,65 inch

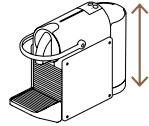

234,6 mm
9,25 inch

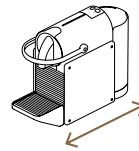

324,2 mm
12,75 inch

PESO

2,47 kg / 5,47 lbs

CAPACIDAD DEL TANQUE DE AGUA

0,7 L / 24 fl oz

CAPACIDAD DEL CONTENEDOR DE CÁPSULAS

9 a 11 cápsulas

PODER

220-240 V ~, 50-60 Hz, 1 260 W

BR/KR	220 V ~, 60 Hz, 1 150 W
BR/MX	127 V ~, 60 Hz, 1 350 W
CA/CO/DO/PA/US	120 V ~, 60 Hz, 1 160 W
CL/CN	220 V ~, 50 Hz, 1 150 W
DO/TW	110 V ~, 60 Hz, 1 000 W
PH	220 V ~, 60 Hz, 1 200 W

CÓDIGO DE LA MÁQUINA

Nespresso	C62, D62
Breville	BEC440, BEC470
DeLonghi	EN127.S, EN127.BL
Krups	XN306T, XN3067
Magimix	M113



PERSONALICE EL TAMAÑO DE SU CAFÉ

SU MÁQUINA PIXIE ESTÁ PREPROGRAMADA PARA OBTENER LA MEJOR EXTRACCIÓN EN TAZA. PARA LOGRAR SUS EXPECTATIVAS PERSONALES, PUEDE REPROGRAMAR EL VOLUMEN DE CAFÉ CON BASE EN SUS PREFERENCIAS.

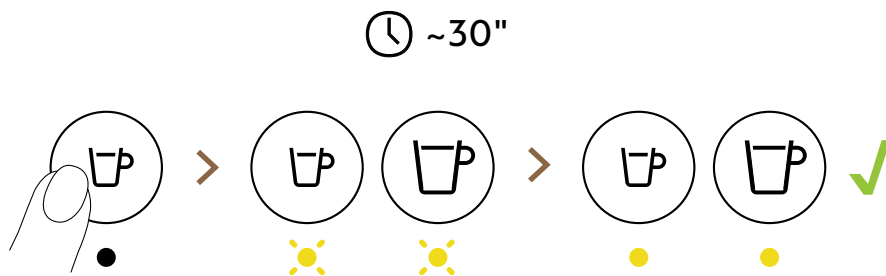

- 01.** Encienda la máquina al presionar cualquier botón. La máquina se calentará en aproximadamente 30 segundos. Las luces parpadearán mientras se calienta y se mantendrán estáticas cuando la máquina está lista.

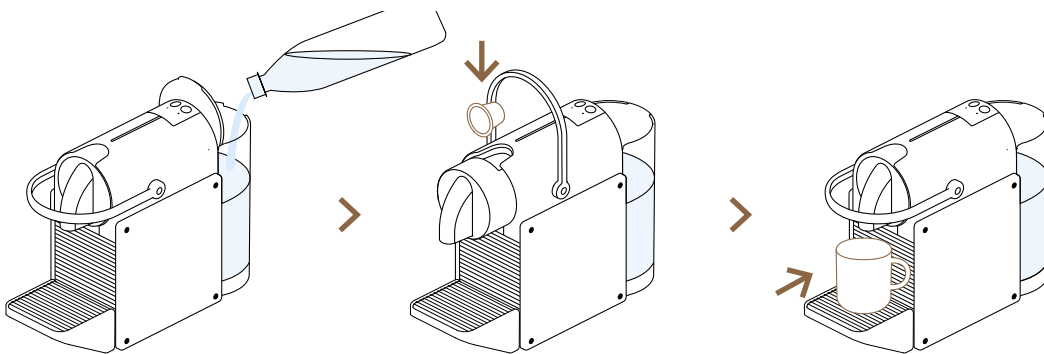

- 02.** Llene el tanque de agua con agua potable fresca e inserte una cápsula. Coloque una taza debajo de la salida de café.





Espresso

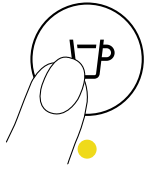

Lungo

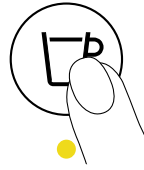

03. Para programar el volumen deseado de Espresso o Lungo, presione y mantenga los botones hasta que la máquina inicie la extracción.

Espresso

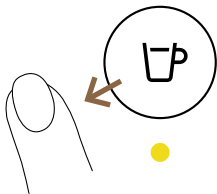

Lungo

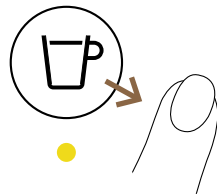

04. Deje de presionar el botón cuando el volumen deseado se haya alcanzado.

3 x

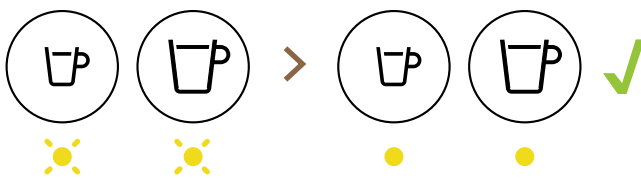

05. Las luces parpadearán rápidamente 3 veces para confirmar el nuevo volumen ajustado.



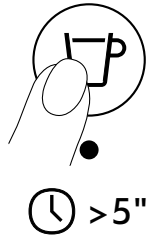

RESETEAR LOS VALORES DE FÁBRICA

Lungo



01. Cuando la máquina se apague, mantenga presionado el botón Lungo por más de 5 segundos.

VALORES DE FÁBRICA

 Espresso 40 ml / 1,35 fl oz	 Lungo 110 ml / 3,75 fl oz	
--	--	--

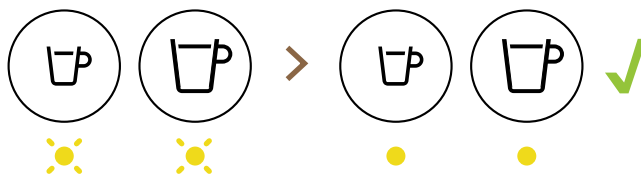

02. Las luces parpadearán rápidamente 3 veces para confirmar la restauración de los valores de fábrica.



AJUSTE DE LA DUREZA DEL AGUA

Dureza del agua	Alta	Media	Baja
CaCO ₃ Calcio Carbonato	360 mg/L	180 mg/L	0 mg/L
Sugerimos que descalcifique su máquina después de:			
 40 ml / 1,35 fl oz	1 000 cafés	2 000 cafés	4 000 cafés



MODO DE AHORRO DE ENERGÍA

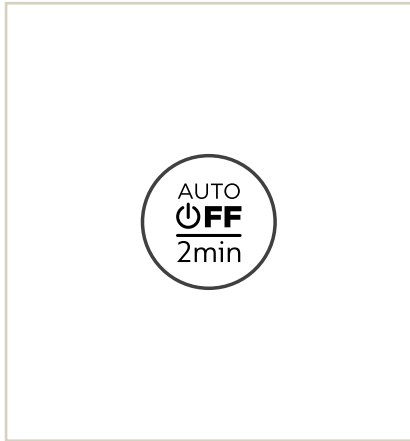

La máquina se apagará automáticamente después de 2 minutos sin uso.

PARA CAMBIAR ESTE AJUSTE

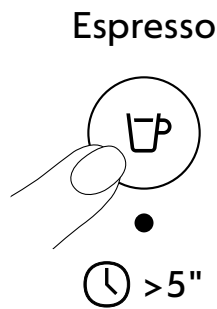

- 01.** Cuando la máquina esté apagada, presione y mantenga el botón Espresso por más de 5 segundos.



- 02.** Seleccione su preferencia al presionar el botón de Espresso.



- 03.** Para salir - mantenga presionado el botón Lungo por más de 5 segundos.



DISPOSICIÓN Y PROTECCIÓN AMBIENTAL

Este aparato cumple con lo establecido por la Dirección EU 2012/19/EC. Los materiales de empaque y el aparato contienen materiales reciclables. Su aparato contiene partes valiosas que pueden ser recuperadas o recicladas. La separación de los materiales restantes en diferentes tipos permite y facilita el reciclaje de los materiales. Deje el aparato en un centro de reciclaje. Puede obtener información sobre la disposición del aparato con las autoridades locales.



COMO NAVEGAR NO MANUAL DE USUÁRIO

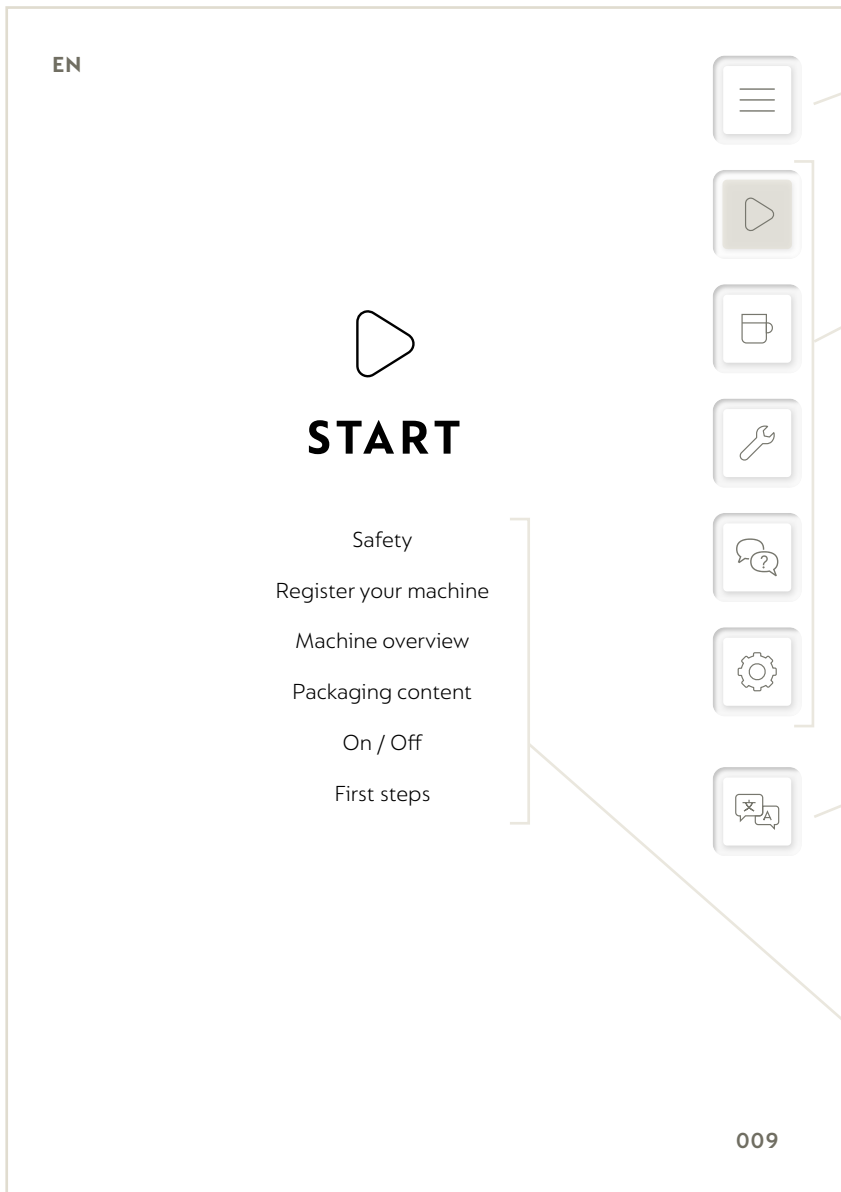

Clique aqui para retornar ao índice

Clique aqui para ir direto à um capítulo

Clique aqui para escolher sua língua favorita

Todos os capítulos são clicáveis, clique neles e vá diretamente para o que precisa

ÍNDICE



INÍCIO

- Segurança
 - Registre sua máquina
 - Visão geral da máquina
 - Conteúdo da embalagem
 - Liga / Desliga
 - Primeiros passos
-



PREPARO DO CAFÉ



MANUTENÇÃO

- Limpeza
 - Descalcificação
 - Preparando para reparo ou guardar
-



SOLUÇÃO DE PROBLEMAS

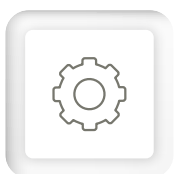

CONFIGURAÇÕES

- Especificações
- Personalize sua medida de café
- Restaurar as configurações de fábrica
- Configurações de dureza da água
- Modo de economia de energia
- Proteção de Meio Ambiente e descarte



INÍCIO

Segurança

Registre sua máquina

Visão geral da máquina

Conteúdo da embalagem

Liga / Desliga

Primeiros passos

SEGURANÇA

Atenção: antes de operar sua máquina, por favor, se atente as instruções de segurança para evitar possíveis danos e ferimentos.

www.nespresso.com

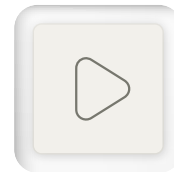

**DESCUBRA COMO USAR
SUA NESPRESSO EM**

www.youtube.com

REGISTRE SUA MÁQUINA

Como um membro **Nespresso**, você tem benefício de suporte de nossos especialistas em café incluindo serviços de diagnósticos de problemas em máquinas. Por favor forneça o número de série da sua máquina no seu registro, para nos ajudar a personalizar nosso serviço de atendimento. Este código de 19 dígitos é encontrado na bandeja de gotejamento ou embaixo da sua máquina.

www.nespresso.com

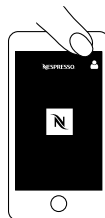

01. Conecte em nespresso.com

02. Faça login em sua conta.



03. Adicione uma máquina e siga os passos.



O número de série, que contém 19 caracteres, está localizado abaixo do código de barras. Este número é escrito em uma etiqueta e representa a identificação de sua máquina. A informação nos ajuda a checar o modelo e ter o melhor rastreamento se sua máquina precisar ser enviada ao nosso centro de reparos. A etiqueta com o número de série pode ser encontrada como a seguir:

- Na bandeja de gotejamento
- Embaixo da máquina
- Na embalagem de sua máquina



VISÃO GERAL DA MÁQUINA

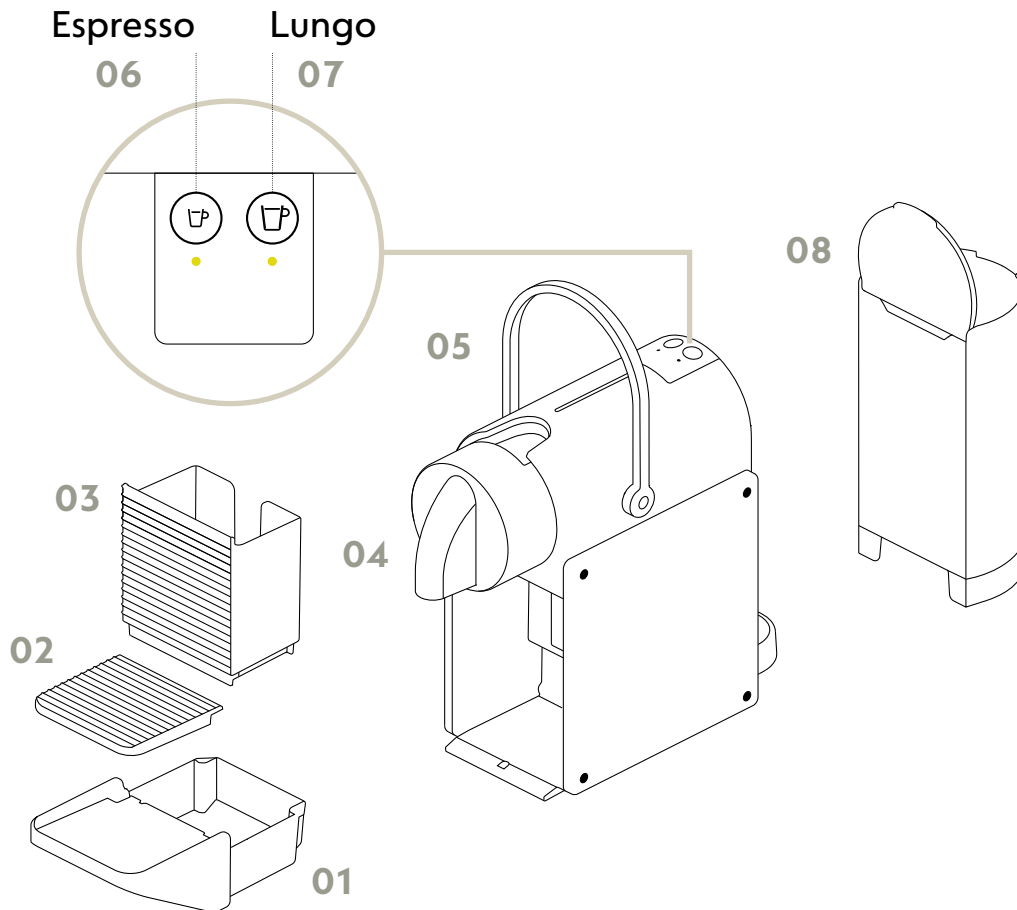

01. Bandeja de gotejamento

02. Grade de gotejamento

03. Contenedor de cápsulas usadas

04. Saída de café

05. Alavanca

06. Botão Espresso

07. Botão Lungo

08. Tanque de água



CONTEÚDO DA EMBALAGEM



-
01. Máquina de café
 02. Manual de boas vindas da Nespresso
 03. Kit de cápsulas Nespresso
 04. Instruções de segurança
 05. Guia de início rápido
 06. Garantia



LIGA / DESLIGA

LIGA

🕒 ~30"

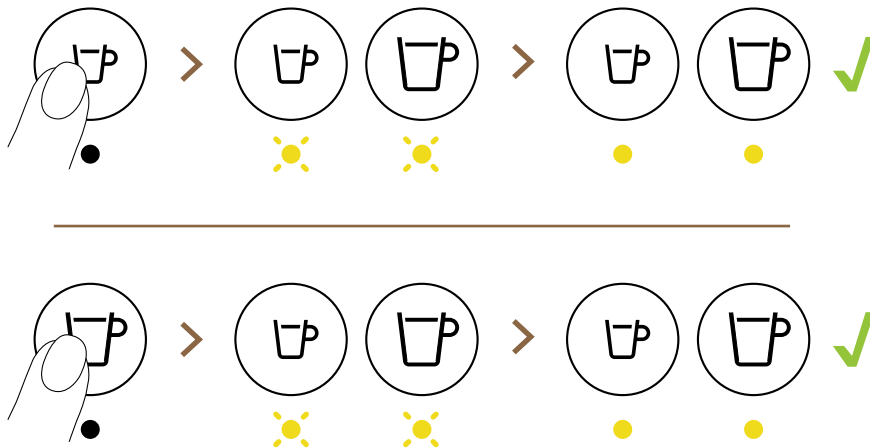

Ligue sua máquina pressionando o botão. A máquina irá aquecer em aproximadamente 30 segundos. Luzes irão piscar enquanto a máquina estiver aquecendo. Quando as luzes se tornarem estáveis, a máquina está pronta.

DESLIGA

🕒 <1"

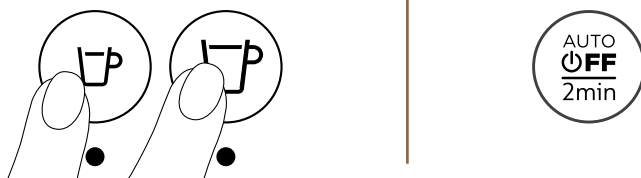

Desligue sua máquina pressionando ambos botões, Espresso e Lungo, simultaneamente por menos de um segundo. Alternativamente, a máquina irá desligar depois de 2 minutos sem uso.



PRIMEIROS PASSOS

i

Desembalar: alguma poeira pode estar presente na superfície da máquina em função de materiais recicláveis usados na embalagem. Isto não é perigoso, apenas limpe com um pano suave.

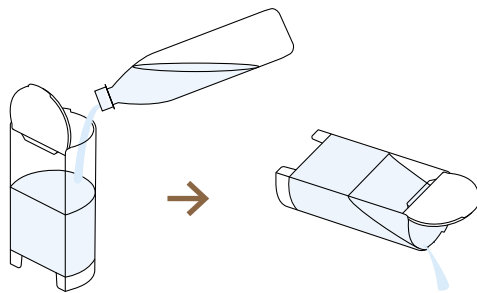

01. Enxágue para limpar o tanque de água.

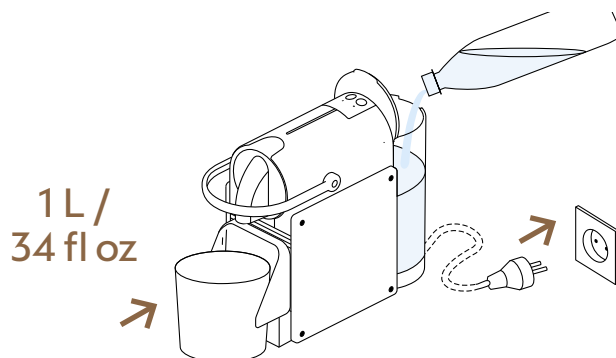

02. Abasteça o tanque de água com água potável e coloque de volta na posição. Posicione um recipiente com capacidade de pelo menos 1 litro de água na saída do café e ligue a máquina na tomada.





🕒 ~30"

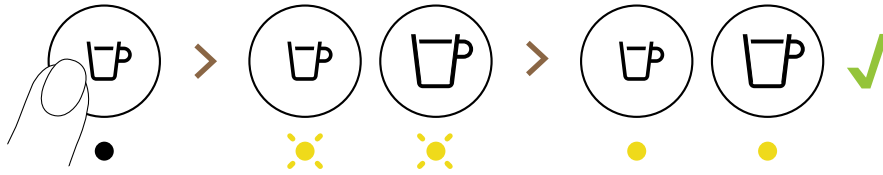

- 03.** Ligue sua máquina pressionando qualquer botão. A máquina irá esquentar em aproximadamente 30 segundos. Luzes irão piscar enquanto a máquina aquece. Quando as luzes se estabilizarem a máquina estará pronta.

Lungo



3 x

- 04.** Para enxaguar a máquina, pressione o botão Lungo. Repita 3 vezes. Sua máquina agora está pronta para ser usada.



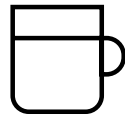

PREPARO DO CAFÉ

CONSTRUA O CANTINHO DO CAFÉ DOS SEUS SONHOS



Escolha seus cafés favoritos ou plano de assinatura que melhor lhe atender, nós cuidaremos do resto.



Descubra a coleção **Pixie**.

Descubra mais em www.nespresso.com

PREPARO DO CAFÉ

🕒 ~30"

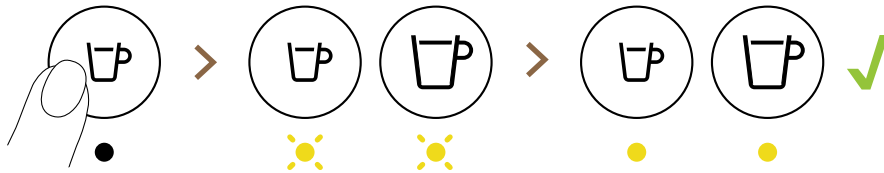

- 01.** Ligue sua máquina pressionando qualquer botão. A máquina irá esquentar em aproximadamente 30 segundos. Luzes irão piscar enquanto a máquina aquece. Quando as luzes se estabilizarem a máquina estará pronta.

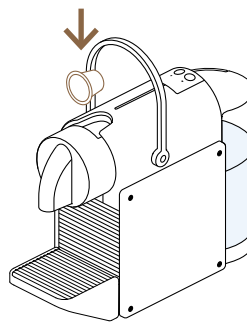
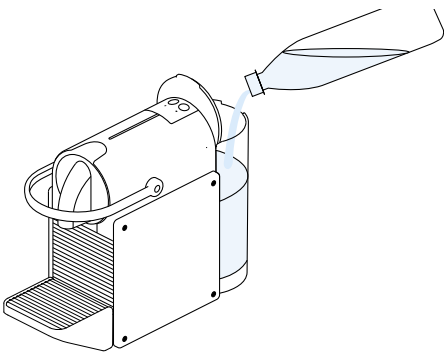

- 02.** Abasteça o tanque de água com água potável e coloque de volta na posição.

- 03.** Abra a máquina, suspendendo a alavanca completamente. Insira uma cápsula.

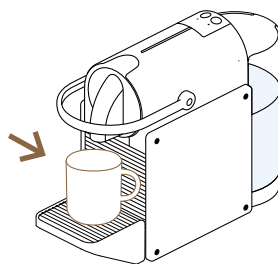

- 04.** Feche a alavanca. Coloque um copo com capacidade suficiente.

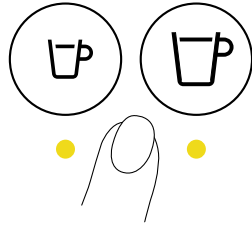

Espresso40 ml /
1.35 fl oz**Lungo**110 ml /
3.75 fl oz

- 05.** Pressione o botão do café correspondente. O processo de extração inicia e irá parar automaticamente. Se desejar parar o fluxo ou completar o café, pressione novamente.

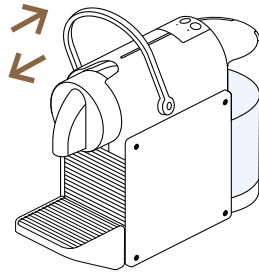

- 06.** Para ejetar a cápsula, abra e feche a alavanca da máquina.



Eleve sua experiência de café e prepare receitas indulgentes com leite com nosso **Aeroccino**. Descubra mais sobre essa linha em www.nespresso.com



MANUTENÇÃO

Limpeza

Descalcificação

Preparando para reparo ou guardar

LIMPEZA

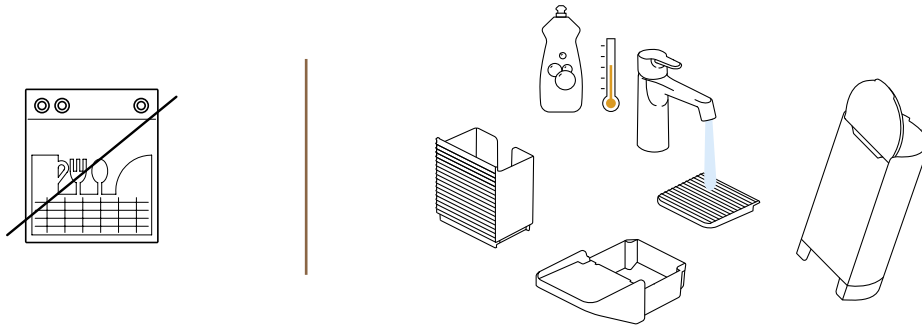

- 01.** Não coloque nenhuma parte da máquina na lava-louças. Certifique-se de desligar a máquina da tomada antes da limpeza. Nós recomendamos esvaziar a bandeja de gotejamento e o contentor de cápsulas usadas todos os dias. Também, remova o tanque de água. Limpe-os com detergente neutro e enxágue com água quente ou morna.

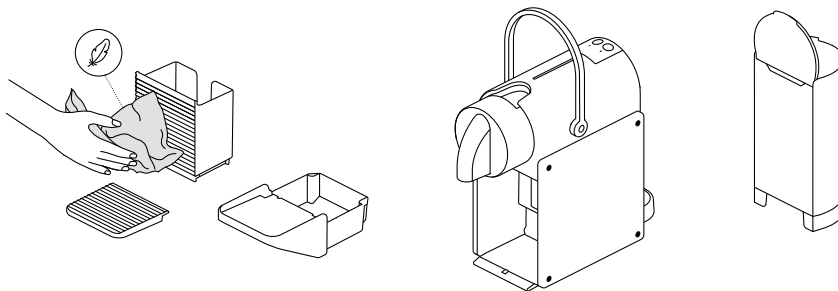

- 02.** Seque com uma toalha limpa, pano ou papel e retorne as peças aos seus lugares.

- i** Limpe a saída de café e superfície da máquina regularmente com um pano úmido. Você não deve usar objetos afiados, escovas duras ou abrasivas, agentes de limpeza fortes ou solventes.



DESCALCIFICAÇÃO

MATERIAL:

- Agente de descalcificação ( www.nespresso.com)
- 1 L recipiente

TEMPO:

- O processo leva aproximadamente 15 minutos



AVISO: A solução de descalcificação pode ser perigosa. Evite contato com olhos, pele e superfícies.



Se quiser pausar o processo de descalcificação, pressione qualquer botão.

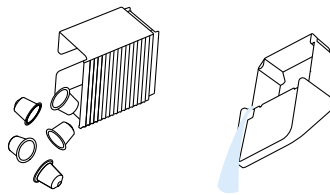
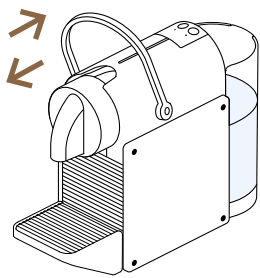

01. Abra e feche a alavanca para ejetar as cápsulas usadas no contentor de cápsulas usadas.

02. Esvazie a bandeja de gotejamento e o contentor de cápsulas usadas antes de ligar a máquina.



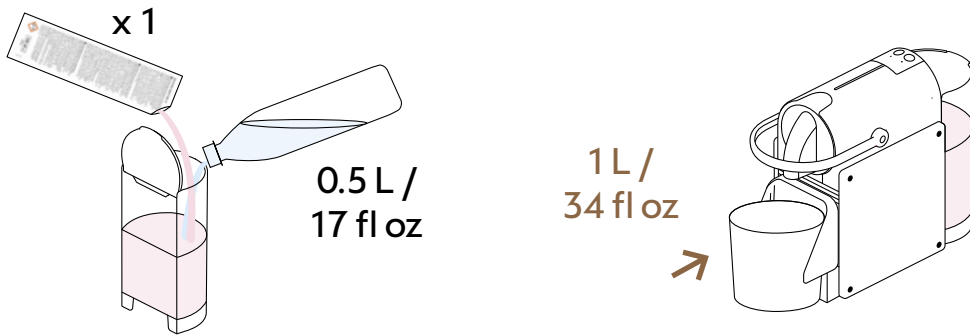

03. Abasteça o tanque de água com água potável acima de 0,5 litros e adicione uma unidade de kit descalcificante Nespresso.

04. Posicione o recipiente abaixo da saída de café, com capacidade para pelo menos 1 litro.

🕒 >6"

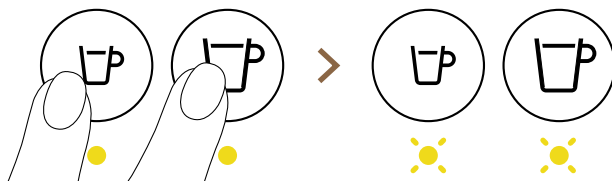

05. Para entrar no modo de descalcificação, simultaneamente pressione os botões de Espresso e Lungo por mais de 6 segundos até que ambas comecem a piscar.

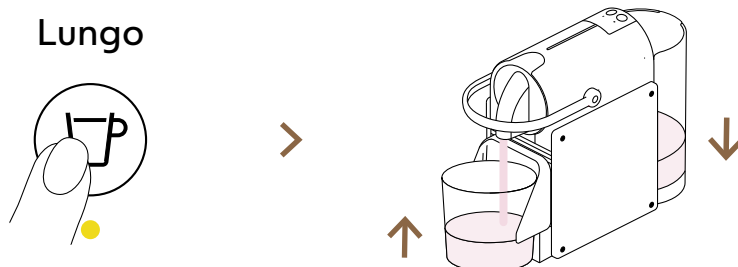

06. Inicie o primeiro ciclo do processo de descalcificação pressionando o botão Lungo e espere até que o tanque de água esteja vazio.





- 07.** Reabasteça o tanque de água com o líquido do recipiente e descalcifique de novo pressionando o botão Lungo.

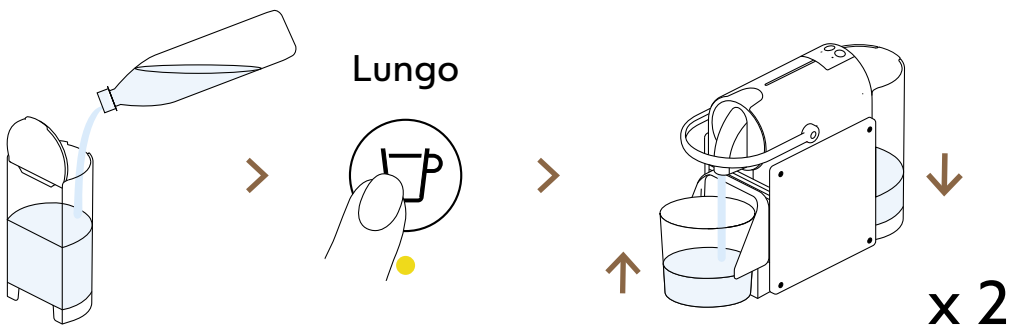

- 08.** Enxágue o tanque de água, abasteça com água potável. Posicione um recipiente com capacidade para pelo menos 1 litro abaixo da saída de café e pressione o botão Lungo para iniciar o enxágue. Repita o processo mais uma vez.

🕒 >5"

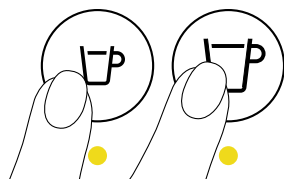

- 09.** Descalcificação agora está completa. Saia do modo descalcificação pressionando simultaneamente os botões Lungo e Espresso por mais de 5 segundos.



PREPARANDO PARA REPARO OU GUARDAR

ANTES DE UM PERÍODO FORA DE USO OU REPARO

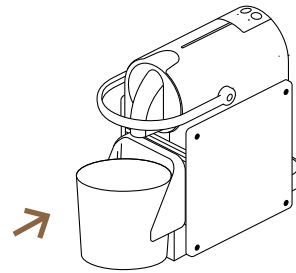
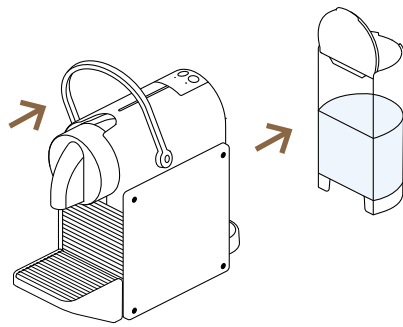

01. Quando a máquina estiver desligada, remova o tanque de água e suspenda a alavanca para ejetar qualquer cápsula.

02. Coloque um recipiente abaixo da saída de café.

🕒 >5"

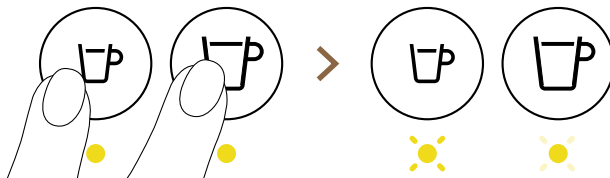

03. Pressione simultaneamente os botões Espresso e Lungo por mais de 5 segundos. Os botões irão piscar alternadamente.



A máquina desliga quando o procedimento estiver concluído.



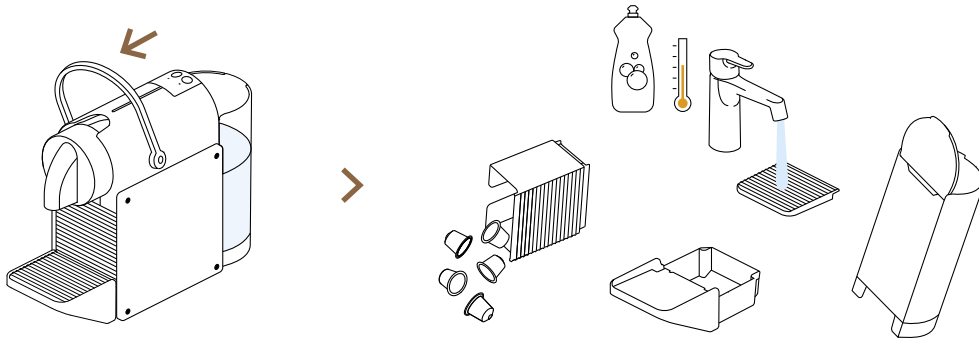

- 04.** Certifique-se de desligar a máquina da tomada antes de limpar. Esvazie a bandeja gotejadora e remova o tanque de água. Limpe os com detergente neutro e enxágue com água quente ou morna. Não coloque nenhuma parte da máquina na lava-louças.





SOLUÇÃO DE PROBLEMAS

SOLUÇÃO DE PROBLEMAS

Nenhuma indicação de luz • Verifique o cabo de energia, plugue, voltagem e fusível. No caso de problemas, ligue para a **Nespresso**.

Sem café, sem água

- Primeiro uso: abasteça o tanque com água (máx 55° C) e proceda conforme instruções da página [110](#).
- Tanque de água está vazio. Abasteça o tanque de água.
- Descalcifique se necessário; veja seção de descalcificação na página [117](#).

Café sai muito devagar

- A velocidade do fluxo depende da variedade do café.
- Descalcifique se necessário; veja seção de descalcificação na página [117](#).

Café não sai quente o suficiente • Descalcifique se necessário; veja seção de descalcificação na página [117](#).

Modo de erro: As 2 luzes piscam rapidamente juntas a cada 3 segundos

- Desligue e ligue a máquina, se o problema persistir ligue para a **Nespresso**.

i No caso de uso intensivo (mais de 10 cafés em uma vez, sem parada) a máquina pode superaquecer. Espere o máximo de 10 minutos antes de usar novamente. Ambos botões irão piscar lentamente, não desligue a máquina. Este é um processo normal depois de um período de descanso para proteger a bomba.



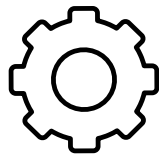

CONFIGURAÇÕES

Especificações

Personalize sua medida de café

Restaurar as configurações de fábrica

Configurações de dureza da água

Modo de economia de energia

Proteção de Meio Ambiente e descarte

ESPECIFICAÇÕES

DIMENSÕES

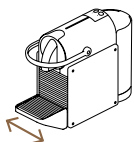

116.6 mm

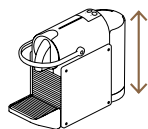

234.6 mm

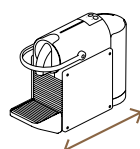

324.2 mm

PESO

2.47 kg

TANQUE DE ÁGUA

0.7 L

CONTENTOR DE CÁPSULAS USADAS

9-11 cápsulas

ENERGIA

220-240 V ~, 50-60 Hz, 1 260 W

BR/KR	220 V ~, 60 Hz, 1 150 W
BR/MX	127 V ~, 60 Hz, 1 350 W
CA/CO/DO/PA/US	120 V ~, 60 Hz, 1 160 W
CL/CN	220 V ~, 50 Hz, 1 150 W
DO/TW	110 V ~, 60 Hz, 1 000 W
PH	220 V ~, 60 Hz, 1 200 W

CÓDIGO DA MÁQUINA

Nespresso	C62, D62
Breville	BEC440, BEC470
DeLonghi	EN127.S, EN127.BL
Krups	XN306T, XN3067
Magimix	M113



PERSONALIZE SUA MEDIDA DE CAFÉ

SUA MÁQUINA PIXIE É PRÉ PROGRAMADA PARA OBTER A MELHOR XÍCARA. PARA ATENDER SUAS EXPECTATIVAS PESSOAIS VOCÊ PODE REPROGRAMAR OS VOLUMES DE SEUS CAFÉS DE ACORDO COM SEU GOSTO.

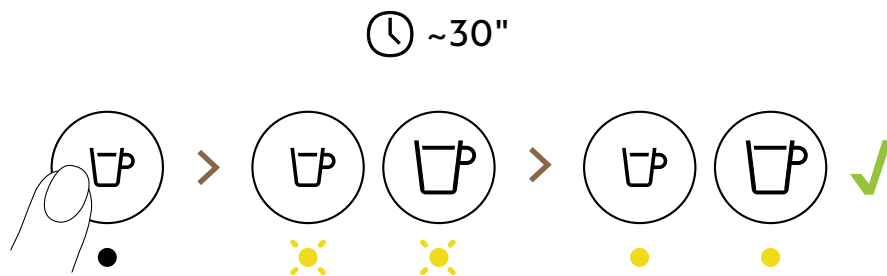

- 01.** Ligue sua máquina pressionando qualquer botão. A máquina irá esquentar em aproximadamente 30 segundos. Luzes irão piscar enquanto a máquina aquece. Quando as luzes se estabilizarem a máquina estará pronta.

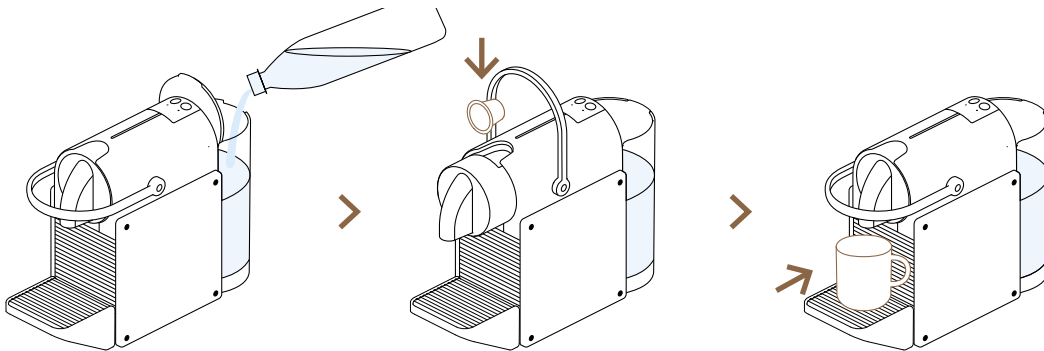

- 02.** Abasteça o tanque de água com água potável e insira uma cápsula. Posicione um copo abaixo da saída de café.



Espresso

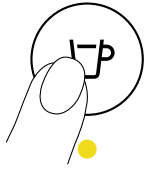

Lungo

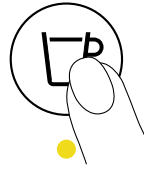

03. Para programar o volume desejado para qualquer Espresso ou Lungo, pressione e segure os botões Lungo ou Espresso até que a máquina comece a extrair.

Espresso

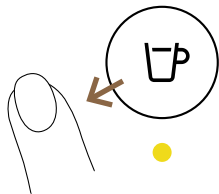

Lungo

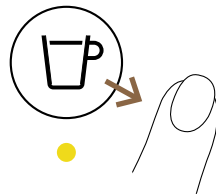

04. Solte o botão assim que o volume desejado atingido.

3 x

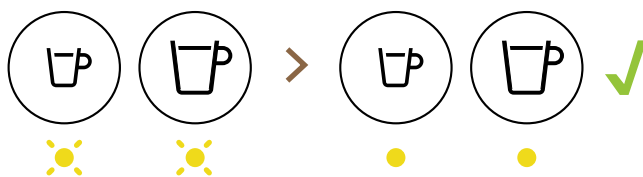

05. As luzes piscarão rapidamente 3 vezes para confirmar a nova configuração.



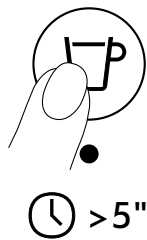

RESTAURAR AS CONFIGURAÇÕES DE FÁBRICA

Lungo



01. Quando a máquina estiver desligada, pressione e segure o botão Lungo por mais de 5 segundos.

CONFIGURAÇÕES DE FÁBRICA

 Espresso 40 ml	 Lungo 110 ml	
---	---	--

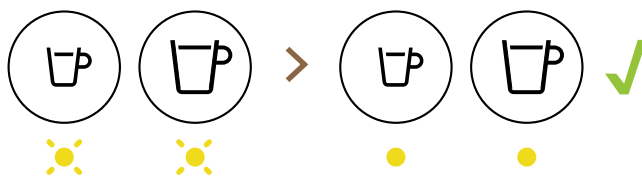

02. As luzes piscarão rapidamente 3 vezes para confirmar a nova configuração.



CONFIGURAÇÕES DE DUREZA DA ÁGUA

Dureza da água	Alta	Média	Baixa
CaCO ₃ Cálcio Carbonato	360 mg/l	180 mg/l	0 mg/l
Nós convidamos você a descalcificar sua máquina depois:			
 40 ml	1.000 cafés	2.000 cafés	4.000 cafés



MODO DE ECONOMIA DE ENERGIA

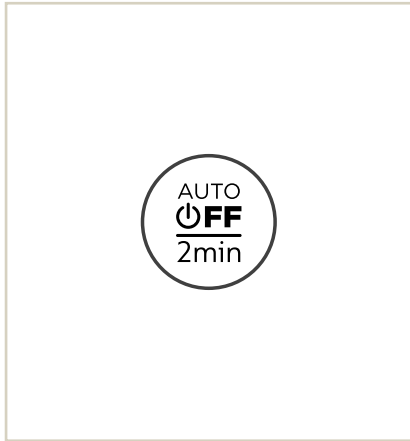

PARA MUDAR ESTA CONFIGURAÇÃO

Espresso

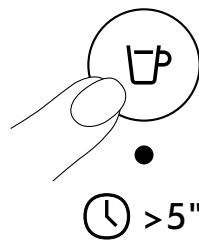

A máquina irá desligar automaticamente depois de 2 minutos sem uso.

01. Quando a máquina for desligada, pressione e segure o botão Espresso por mais de 5 segundos.

1 x =
AUTO OFF
2 min

Espresso



Espresso



2 x =
AUTO OFF
9 min

02. Escolha o modo de economia pressionando o botão Lungo.

Lungo



03. Para sair - pressione e segure o botão Lungo por mais de 5 segundos.



PROTEÇÃO DE MEIO AMBIENTE E DESCARTE

Este equipamento atende a EU Directive 2012/19/EC. Embalagens e o equipamento contém materiais recicláveis. Este equipamento contém materiais valiosos que podem ser reciclados. A separação de diferentes materiais de acordo com o tipo facilitam a reciclagem dos materiais de valor. Deixe este equipamento em um ponto de coleta disponibilizado pelas autoridades locais.



Descubra mais sobre sustentabilidade em:
www.nespresso.com

מיחזור ושמירה על הסביבה

מכשיר זה תואם להנחיית האיחוד האירופי EC/2012/19. חומרי האריזה והמכשיר מכילים חומרים הניתנים למחזור. המכשיר שלך מכיל חומרים יקרי ערך שניתן לשחזר או למחזר. הפרדת חומרי הפסולת הנותרים לסוגים שונים מקלה על מיחזור חומרי גלם יקרי ערך. השאר את המכשיר בנקודת איסוף. אתה יכול לקבל מידע על סילוק מהרשויות המקומיות שלך.



מצב חיסכון באנרגיה

כדי לשנות הגדרה זו

Espresso

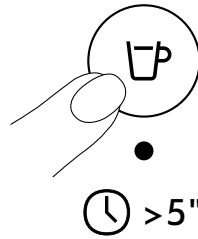

1. כשהמכונה כבויה, לחץ והחזק את לחצן האספרסו יותר מ-5 שניות.

המכונה תכבה אוטומטית לאחר 2 דקות של אי שימוש.

Espresso

= x 2
כיבוי אוטומטי
9 דקות



Espresso

= x 1
כיבוי אוטומטי
2 דקות



2. בחר את מצב השמירה שלך על ידי לחיצה על כפתור האספרסו.

Lungo



3. ליציאה - לחץ והחזק את כפתור Lungo למשך יותר מ-5 שניות.

הגדרות קשיות המים

קשיות מים	גְבוּהַ	בינוני	נמוך
CaCO ₃ סידן פחמה	360 מ"ג/ליטר	180 מ"ג/ליטר	0 מ"ג/ליטר
אנו מזמינים אותך להסיר אבנית במכונה שלך לאחר:			
קפ"מ 40 מ"ל / oz 1.35	1,000 קפה	2,000 קפה	4,000 קפה



אפס להגדרות היצרן

Lungo

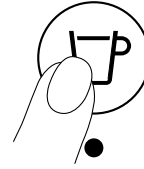

🕒 >5"

1. כשהמכונה כבויה, לחץ והחזק את לחצן Lungo למשך יותר מ-5 שניות.

הגדרות יצרן

	 <p>לונגו oz 3.75 / מ"ל 110</p>	 <p>אספרסו oz 1.35 / מ"ל 40</p>
---	---	---

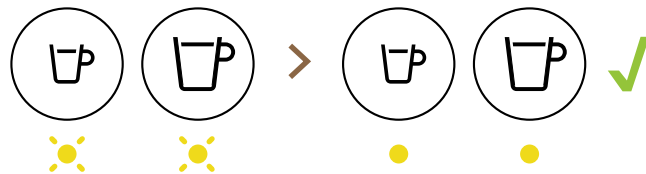

2. האורות יבהבו במהירות 3 פעמים כדי לאשר שהגדרות היצרן שוחזרו.

Espresso

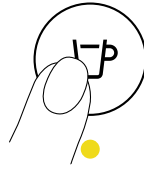

Lungo

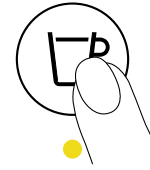

3. כדי לתכנת את כמות הקפה הרצויה עבור כל אספרסו או לונגו לחץ והחזק את לחצני האספרסו או לונגו עד שהמכונה תתחיל בחליטה.

Espresso

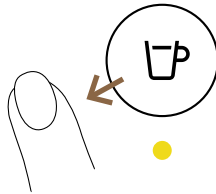

Lungo

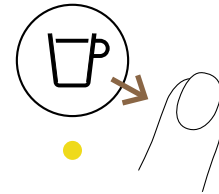

4. שחררו את הכפתור כאשר הכמות הרצויה תוגש.

3 x

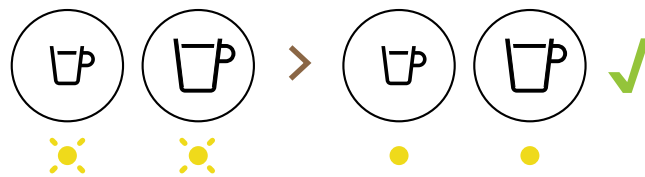

5. האורות יהבהבו במהירות 3 פעמים לאישור ההגדרה הרצויה.

התאם אישית את גודל הקפה שלך

מכונת PIXIE שלך מתוכנתת מראש כדי להשיג את התוצאה הטובה ביותר בכוס. על מנת להתקרב לציפיות האישיות שלכם תוכלו לתכנת מחדש את נפח הקפה שלכם לפי טעמכם.

~30"



1. הפעל את המכשיר שלך על ידי לחיצה על כל כפתור. המכונה תידלק תוך כ-30 שניות. האורות יהבהבו בזמן שהמכונה תידלק. כאשר האור הופך יציב, המכונה מוכנה.

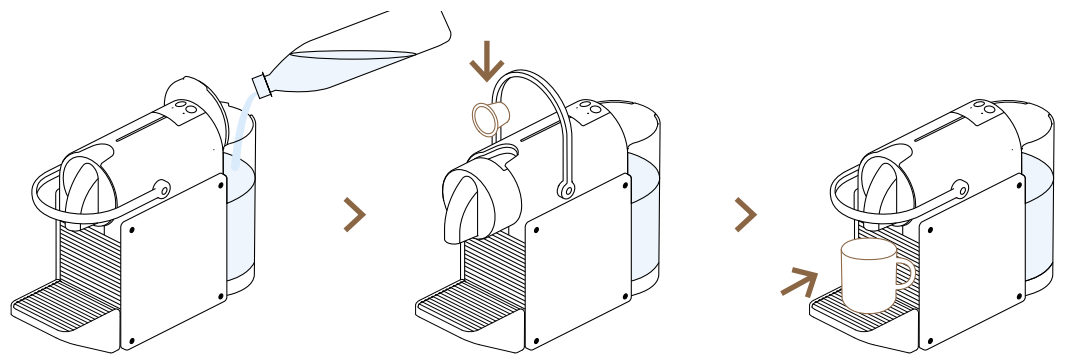

2. מלאו את מיכל המים במי שתייה טריים והכנסו קפסולה. הניחו כוס מתחת לפתח יציאת הקפה.

מפרטים

ממדים

324.2 מ"מ
12.75 אינץ'

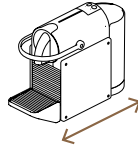

234.6 מ"מ
9.25 אינץ'

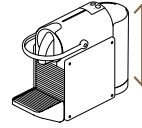

116.6 מ"מ
4.65 אינץ'

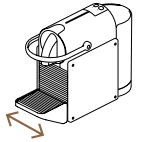

משקל

5.47 פאונד / 2.47 ק"ג

קיבולת מיכל מים

0.7 ליטר / 24 פל אונקיות

קיבולת מיכל קפסולה

9-11 כמוסות

מתח

220-240 V ~, 50-60 Hz, 1 260 W

220 V ~, 60 Hz, 1 150 W	BR/KR
127 V ~, 60 Hz, 1 350 W	BR/MX
120 V ~, 60 Hz, 1 160 W	CA/CO/DO/PA/US
220 V ~, 50 Hz, 1 150 W	CL/CN
110 V ~, 60 Hz, 1 000 W	DO/TW
220 V ~, 60 Hz, 1 200 W	PH

קוד המכונה

C62, D62	Nespresso
BEC440, BEC470	Breville
EN127.S, EN127.BL	DeLonghi
XN306T, XN3067	Krups
M113	Magimix

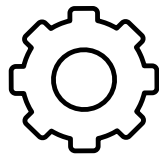

הגדרות

מפרטים

התאם אישית את גודל הקפה שלך

אפס להגדרות היצרון

הגדרות קשיות המים

מצב חיסכון באנרגיה

מיחזור ושמירה על הסביבה



פתרון תקלות

אין מחוון אור

- בדוק את שקע החשמל, התקע, המתח והנתיך. במקרה של בעיות, התקשר ל-Nespresso.

בלי קפה, בלי מים

- שימוש ראשון: מלאו את מיכל המים במים חמים (מקסימום 55°C / 130 F) והעבירו דרך המכונה לפי ההוראות בעמוד [153](#).
- מיכל המים ריק. מלא מיכל מים.
- הסרת אבנית במידת הצורך; ראה סעיף [הסרת אבנית בעמוד 146](#).

הקפה יוצא לאט מאוד

- מהירות הזרימה תלויה במגוון הקפה.
- הסרת אבנית במידת הצורך; ראה סעיף [הסרת אבנית בעמוד 146](#).

קפה לא חם מספיק

- הסרת אבנית במידת הצורך; ראה סעיף [הסרת אבנית בעמוד 146](#).

מצב שגיאה: 2 הנורות מהבהבות במהירות יחד כל 3 שניות

- נתק וחבר מחדש את המכונה. אם הבעיה נמשכת, התקשר ל-Nespresso.

במקרה של שימוש אינטנסיבי (יותר מ-10 קפה במכה אחת, ללא עצירה), המכונה יכולה לעבור למצב התחממות יתר. המתן 10 דקות לכל היותר לפני שתשתמש בו שוב. שני הכפתורים יהבהבו באיטיות, אל תנתק את המכשיר. זהו צעד נורמלי לאחר תקופת מנוחה כדי להגן על המכונה.





פתרון תקלות

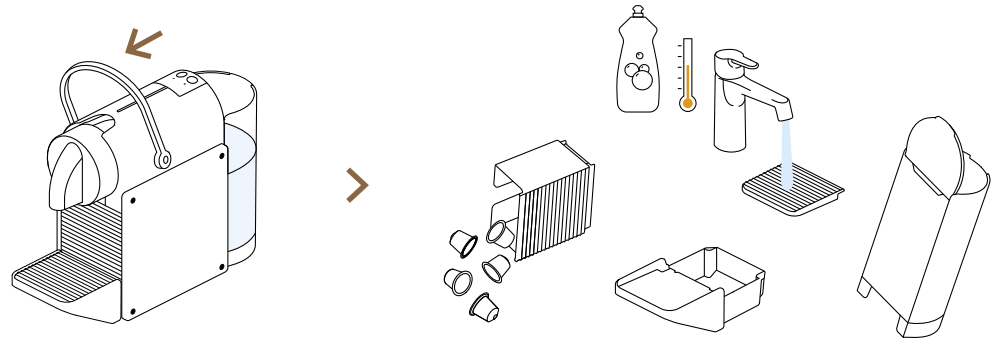

4. הקפד לנתק את המכונה לפני הניקוי. רוקן את מגש העודפים, מיכל הקפסולות המשומשות והסר את מיכל המים. נקו את כולם עם חומר ניקוי חסר ריח ושטפו במים חמים או חמים. אין להכניס אף חלק מהמכונה למדיח הכלים.



הכנה לתיקון או אחסון

לפני תקופה של אי שימוש ולהגנה מפני כפור, או לפני תיקון

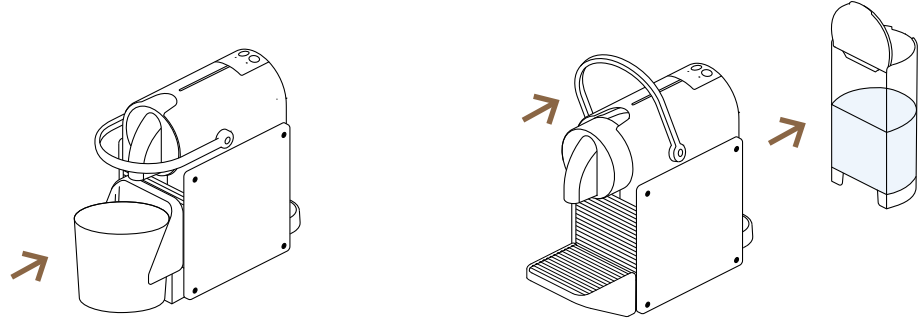

2. הנח מיכל מתחת לשקע הקפה.

1. כשהמכונה כבויה, הסר את מיכל המים והרם את הידית כדי להוציא קפסולה כלשהי.

⌚ >5"

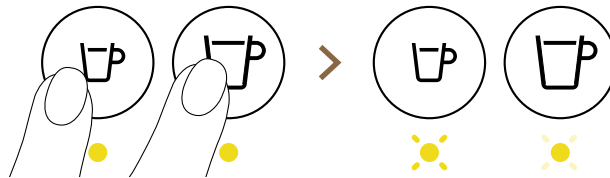

3. לחץ והחזק בו-זמנית את לחצני האספרסו והלונגו למשך יותר מ-5 שניות. לחצנים יבהבו לחלופין.

המכונה נכבית עם סיום ההליך.



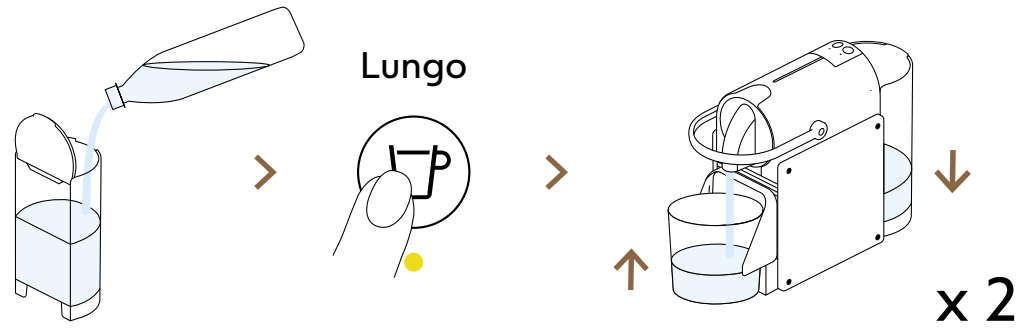

8. שטפו את מיכל המים, מלאו אותו במי שתייה טריים. הנח מיכל של 1 ליטר מתחת לשקע הקפה ולחץ על לחצן Lungo כדי להתחיל בשטיפה. חזור על תהליך אחד שוב.

🕒 >5"

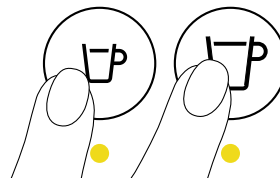

9. הסרת האבנית הושלמה כעת. צא ממצב הסרת האבנית על ידי לחיצה בו-זמנית על לחצני אספרסו ולונגו למשך יותר מ-5 שניות.



🕒 >6"

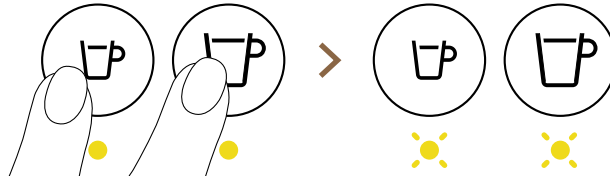

5. כדי להיכנס למצב הסרת האבנית, לחץ בו זמנית על לחצני האספרסו והלונגו למשך יותר מ-6 שניות עד ששתי הנורות יתחילו להבהב.

Lungo

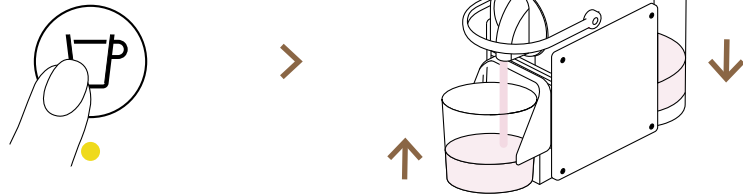

6. התחל את המחזור הראשון של תהליך הסרת האבנית על ידי לחיצה על לחצן Lungo והמתן עד שמיכל המים יתרוקן.



7. מלאו מחדש את מיכל המים בנוזל מהמיכל והסירו את האבנית שוב על ידי לחיצה על כפתור Lungo.

הסרת אבנית

חומר:

- חומר להסרת אבנית (www.nespresso.com )
- מיכל 1 ליטר

זמן:

- התהליך אורך כ-15 דקות

אזהרה: חומר הסרת האבנית יכול להזיק. הימנע ממגע עם עיניים, עור ומשטחים. 

אם ברצונך להפסיק את תהליך הסרת האבנית, תוכל ללחוץ על כל כפתור. 

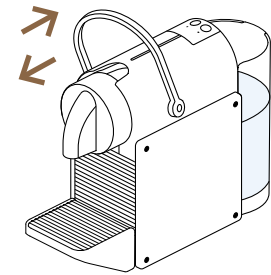
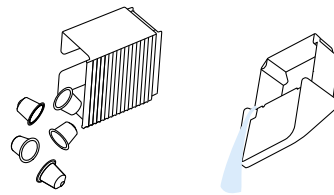

2. רוקן את מגש העודפים ואת מיכל הקפסולה המשומשת לפני הפעלת המכונה.

1. הרם וסגור את הידית כדי להוציא את הקפסולה לתוך מיכל הקפסולה המשומשת.

1 L /
34 fl oz

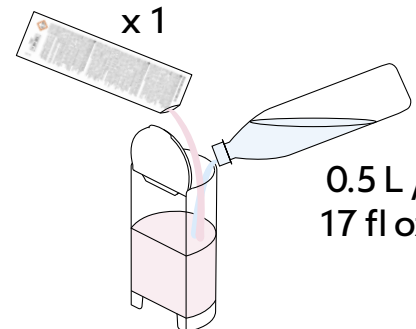
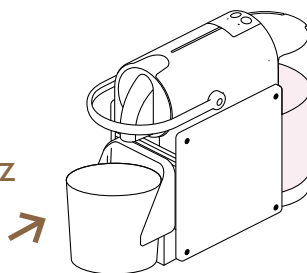

0.5 L /
17 fl oz

4. הנח מיכל מתחת לשקע הקפה בנפח מינימלי של 1 ליטר.

3. מלאו את מיכל המים במי שתייה טריים עד 0.5 ליטר והוסיפו יחידה אחת של ערכת הסרת האבנית של Nespresso.

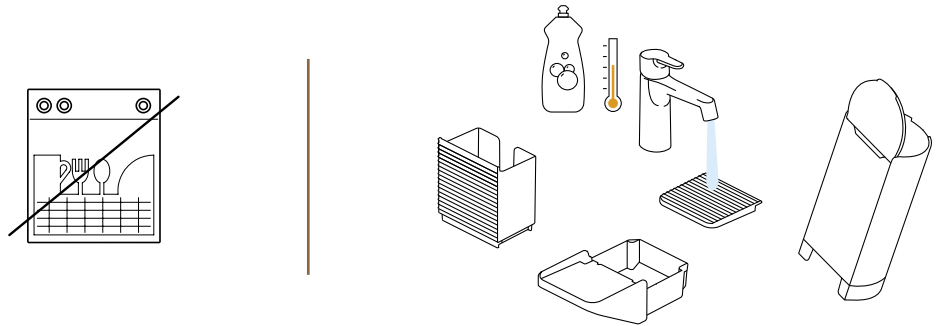

1. אין להכניס אף חלק מהמכונה למדיח הכלים. הקפד לנתק את המכונה לפני הניקוי. אנו ממליצים לרוקן את מגש הטפטוף ואת מיכל הקפסולה המשומשת מדי יום. הסר גם את מיכל המים. נקו את כולם עם חומר ניקוי חסר ריח ושטפו במים חמים או חמים.

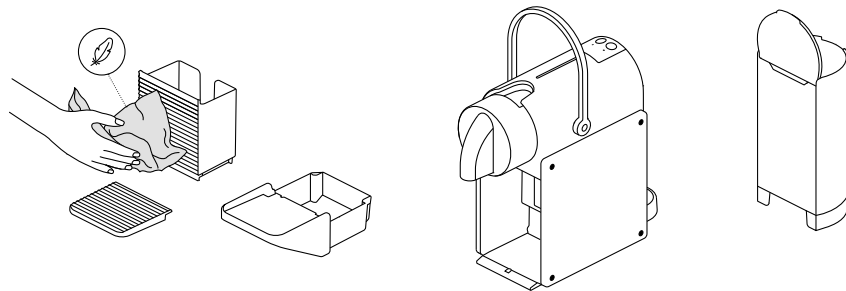

2. יבשו במגבת נקייה, מטלית או נייר והרכיבו מחדש את כל החלקים.

נקו את פתח יציאת הקפה ואת פני המכונה בקביעות באמצעות מטלית נקייה. אין להשתמש בחפצים חדים, מברשות או חומרים שוחקים חדים, כמו גם חומר ניקוי חזק או חומר ניקוי ממס.

i



תחזוקה

ניקוי

הסרת אבנית

הכנה לתיקון או אחסון

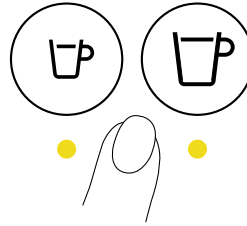

Espresso

40 ml /
1.35 fl oz

Lungo

110 ml /
3.75 fl oz

5. לחץ על כפתור הקפה המתאים. תהליך החליטה יתחיל ויעצר אוטומטית. אם ברצונך להפסיק את הזרם או למלא קפה, לחץ שוב.

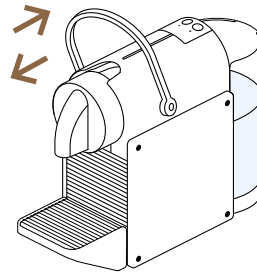

6. כדי להוציא את הקפסולה לתוך מיכל הקפסולה המשומשת, הרם וסגור את ידית המכונה.

שדרג את חווית הקפה שלך והכין מתכוני חלב מפנקים עם מקציף החלב שלך Aeroccino. גלו את המגוון באתר www.nespresso.com



הכנת קפה

⌚ ~30"

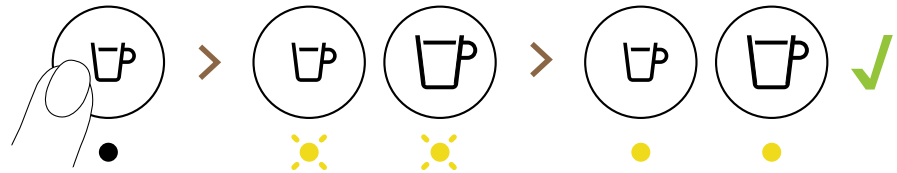

1. הפעל את המכשיר שלך על ידי לחיצה על כל כפתור. המכונה תתחמם תוך כ-30 שניות. האורות יהבהבו בזמן שהמכונה מתחממת. כאשר האור הופך יציב, המכונה מוכנה.

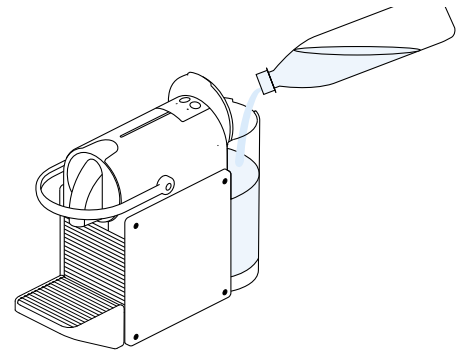
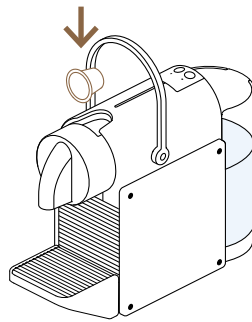

3. פתח את המכונה על ידי הרמת הידית לגמרי. הכנס קפסולה.

2. מלאו את מיכל המים במי שתייה טריים והחזירו אותו למקומו.

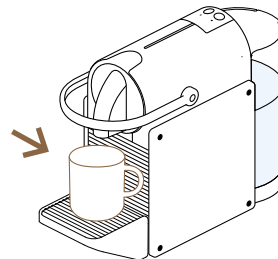

4. סגור את הידית. הניחו כוס בעלת קיבולת מספקת.



הכנת קפה

בנה את פינת הקפה של החלומות שלך

בחר את הקפה המועדף עליך או את תוכנית המנוי המתאימה לך, אנחנו נדאג לכל השאר.



גלה את קולקציית פיקסי.

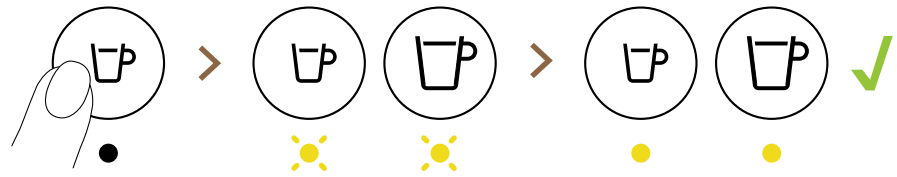

גלה עוד בכתובת www.nespresso.com

 ~30"

3. הפעל את המכשיר שלך על ידי לחיצה על כל כפתור. המכונה תתחמם תוך כ-30 שניות. האורות יהבהבו בזמן שהמכונה מתחממת. כאשר האור הופך יציב, המכונה מוכנה.

Lungo



3 x

4. כדי לשטוף את המכונה, לחץ על לחצן ה-Lungo. במשך שלוש פעמים. המכשיר שלך מוכן כעת לשימוש.

צעדים ראשונים

לאחר הוצאת המכונה מהאריזה: ייתכן שחלק מהאבק נמצא על פני המכונה עקב החומרים הממוחזרים המשמשים באריזה. זה לא מסוכן, פשוט נקה עם טישו רך.

i

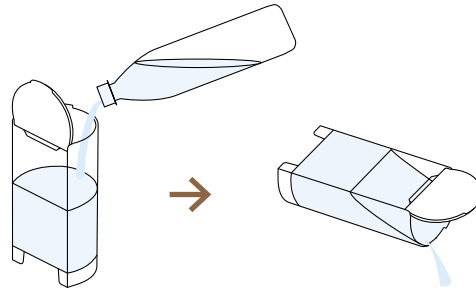

1. יש לשטוף כדי לנקות את מיכל המים.

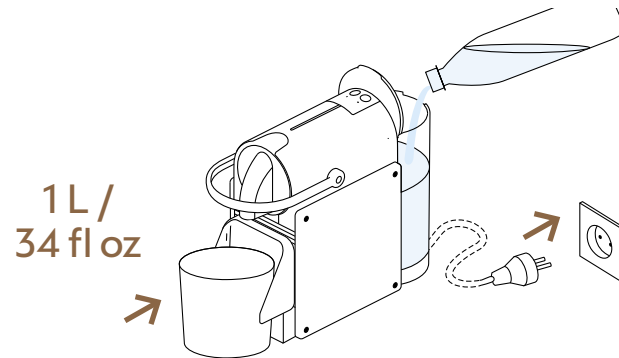

2. מלאו את מיכל המים במי שתייה טריים והחזירו אותו למקומו. הנח מיכל של ליטר אחד לפחות מתחת לשקע הקפה וחבר את המכונה לשקע חשמל.

כיבוי והדלקה

על

🕒 ~30"

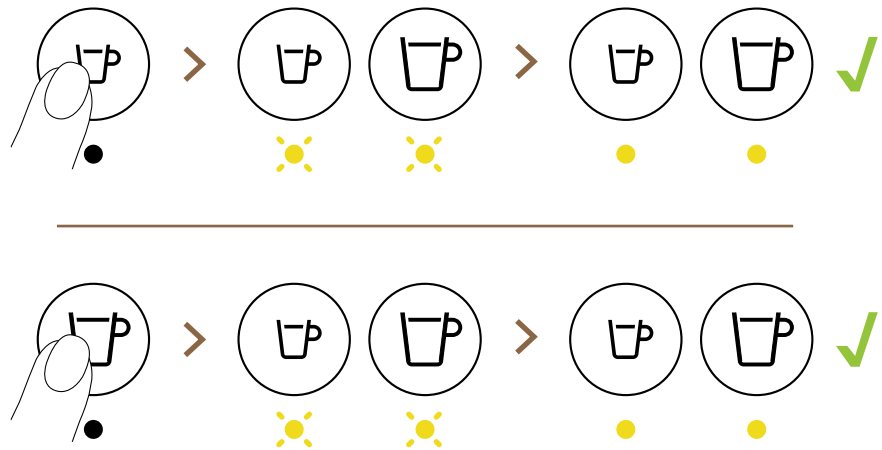

הפעל את המכשיר שלך על ידי לחיצה על כל כפתור. המכונה תתחמם תוך כ-30 שניות. האורות יהבהבו בזמן שהמכונה מתחממת. האור הופך יציב, המכונה מוכנה.

כבוי

🕒 <1"

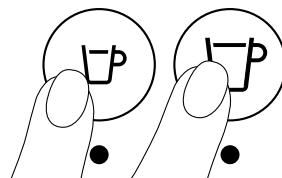

כבה את המכשיר שלך על ידי לחיצה על לחצני האספרסו והלונגו בו-זמנית למשך פחות משנייה. לחלופין, המכונה תכבה אוטומטית לאחר 2 דקות של אי שימוש.

תוכן האריזה



1. מכונת קפה
2. חוברת קבלת פנים של נספרסו
3. סט קפסולות של נספרסו
4. הוראות בטיחות
5. מדריך להתחלה מהירה
6. אֶחָרִיּוֹת

סקירת מכונה

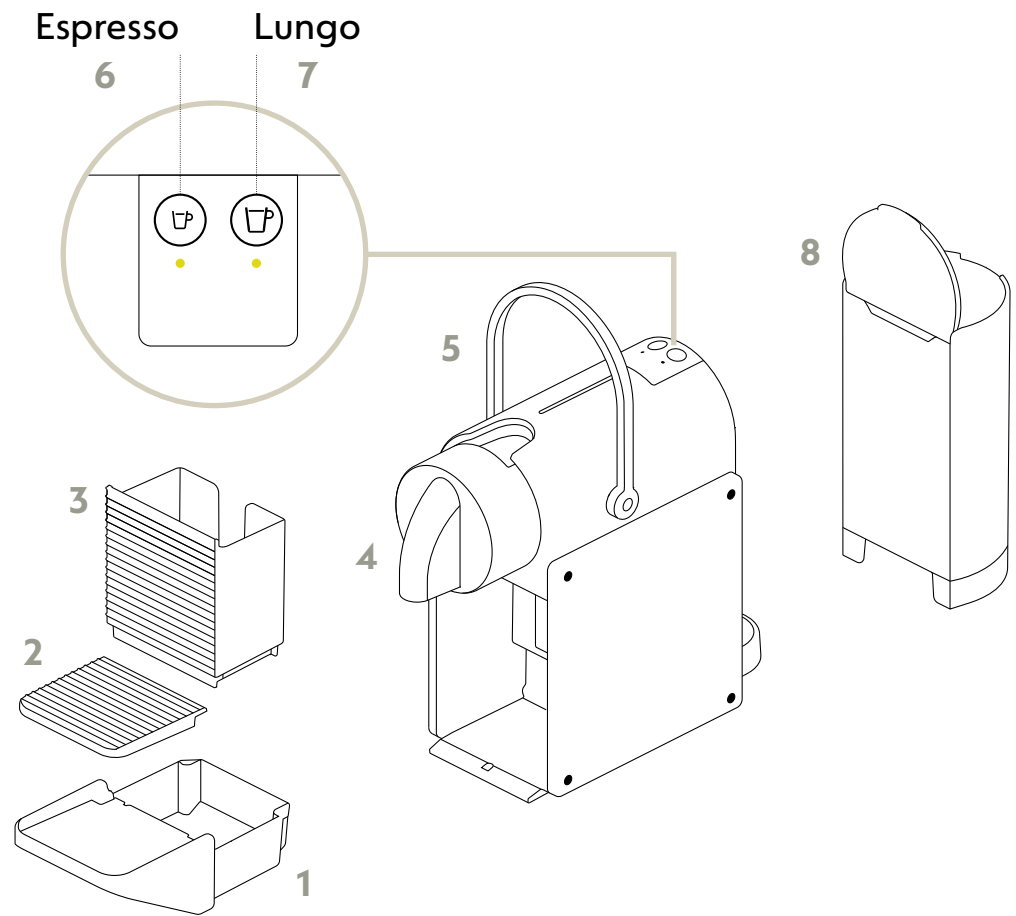

1. מגש העודפים

2. רשת טפטוף

3. מיכל קפסולה משומש

4. שקע קפה

5. מנוף

6. כפתור אספרסו

7. כפתור Lungo

8. מיכל מים

רשום את המכונה שלך

כחבר Nespresso, אתה נהנה מתמיכה לכל החיים של מומחי הקפה שלנו, כולל שירותי פתרון בעיות במכונות. אנא ספק את המספר הסידורי של המכשיר החדש שלך בעת ההרשמה הראשונה, כדי לעזור לנו לספק סיוע מותאם אישית ללקוחות. קוד בן 19 ספרות זה נמצא על גבי מגש העודפים או בגב המכשיר שלך.



www.nespresso.com

2. היכנס לחשבון שלך.

1. התחבר ב- nespresso.com



3. הוסף מכונה ובצע את השלבים.



המספר הסידורי, המכיל 19 תווים, ממוקם מתחת לברקוד. מספר זה כתוב בתווית, המייצגת את זהות המכשיר שלך. המידע עוזר לנו לבדוק את הדגם שלך ולבצע את המעקב הטוב ביותר אם יש לשלוח את המכונה שלך למרכז התיקונים שלנו. ניתן למצוא את התווית עם המספר הסידורי באופן הבא:

- על מגש העודפים
- מתחת למכונה
- על אריזת המכונה שלך

בטיחות

זהירות: לפני הפעלת מכונת הקפה שלך, אנא עיין בעלון הוראות הבטיחות כדי למנוע פגיעה ונזקים אפשריים.

www.nespresso.com





התחל

בְּטִיחוֹת

רשום את המכונה שלך

סקירת מכונה

תוכן האריזה

כיבוי והדלקה

צעדים ראשונים

תוכן העניינים

התחל



- תוכן האריזה
- בטיחות
- רשום את המכונה שלך
- כיבוי והדלקה
- סקירת מכונה
- צעדים ראשונים

הכנת קפה



- הכנה לתיקון או אחסון
- ניקוי
- הסרת אבנית

תחזוקה



פתרון תקלות



הגדרות



- מפרטים
- הגדרות קשיות המים
- התאם אישית את גודל הקפה שלך
- מצב חיסכון באנרגיה
- אפס להגדרות היצרן
- מיחזור ושמירה על הסביבה

כיצד לנווט במדריך למשתמש

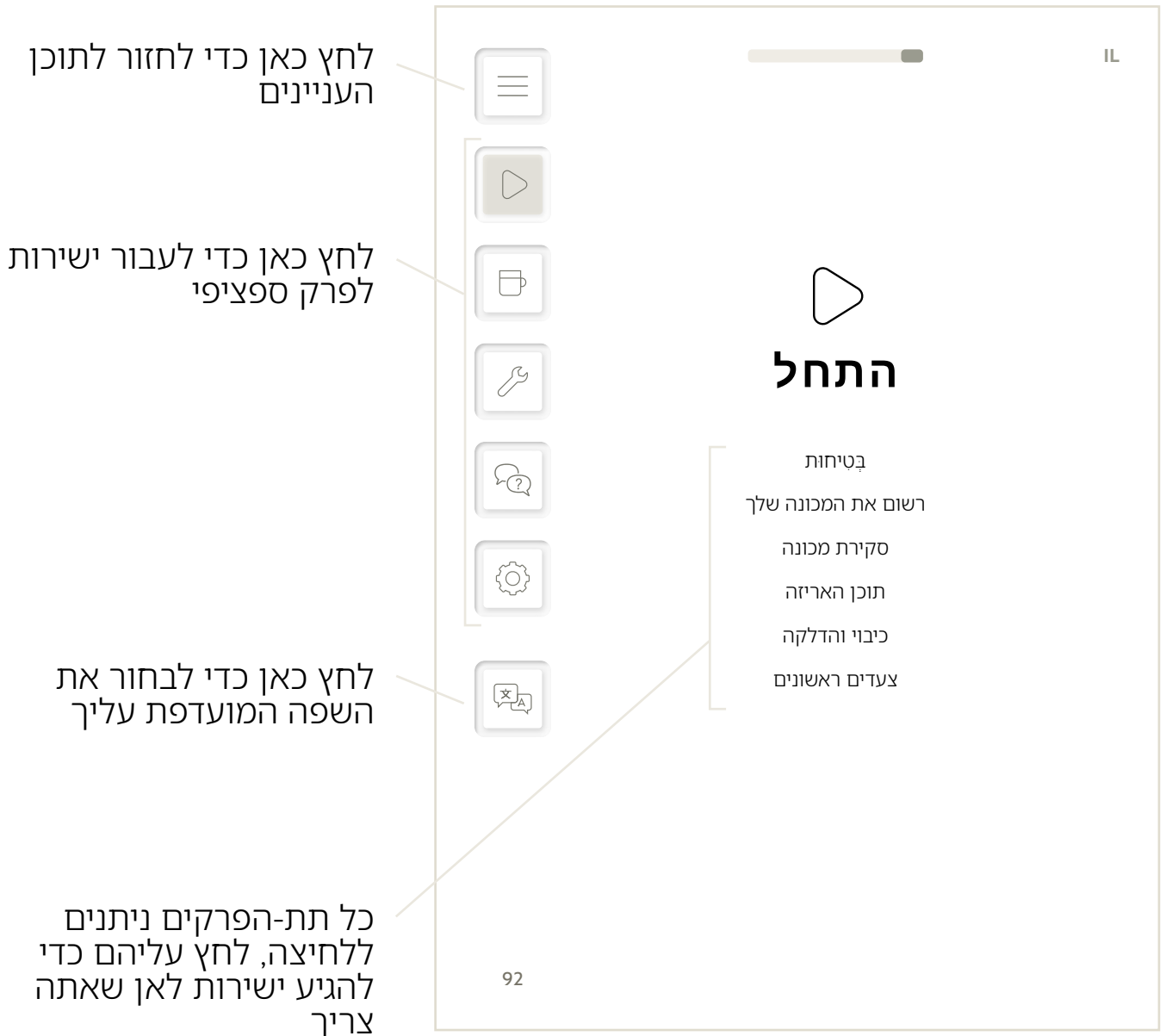



PIXIE



NESPRESSO