



NINJAGO

DRAGONS RISING

71816



Q LEGO® Builder



LEGO.com/sustainable-packaging



FR
DONNEZ
OU
RECYCLEZ

 OU  OU 

ASSOCIATION MAGASIN DÉCHÈTERIE

Adresses sur quefairedemesdechets.fr



Q LEGO® Builder

BUILDER



Apple and the Apple logo are trademarks of Apple Inc., registered in the U.S. and other countries and regions. App Store is a service mark of Apple Inc. Google Play and the Google Play logo are trademarks of Google LLC. Tencent and the Tencent logo are trademarks of Tencent Inc.

Q [LEGO.com/devicecheck](https://www.lego.com/devicecheck)

EN Ask parents' permission before going online | **DE** Eltern um Erlaubnis bitten, bevor du online gehst | **FR** Demande l'autorisation d'un parent avant d'aller en ligne | **IT** Chiedi il permesso ai tuoi genitori prima di andare online | **ES** Pídeles permiso a tus papás antes de conectarte a Internet | **PT** Pede autorização aos pais antes de acederes online | **ZH** 上网前应先征得父母的同意 | **PL** Poproś rodziców o zgodę, zanim wejdiesz do Internetu | **CS** Než půjdeš na internet, požádej rodiče o svolení | **SK** Skôr než pôjdeš na internet, vypýtaj si povolenie od rodičov | **HU** Kérj szülői engedélyt, mielőtt online csatlakoznál! | **RO** Cere permisiunea părinților înainte de a te conecta online | **BG** Поискайте разрешение от родител, преди да влезете онлайн | **LV** Pirms došanās tiešsaistē palūdz atļauju vecākiem | **ET** Enne Interneti kasutamist küsi vanematelt luba | **LT** Prieš prisijungdami prie interneto, atsiklauskite tėvų



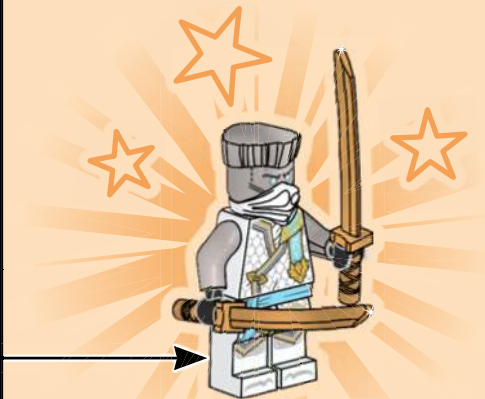
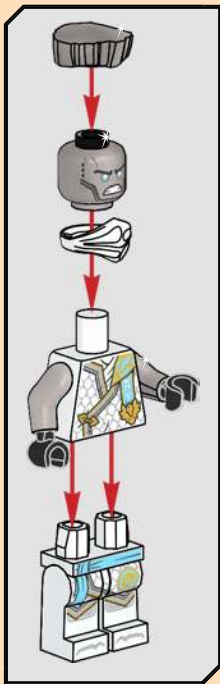



1



6



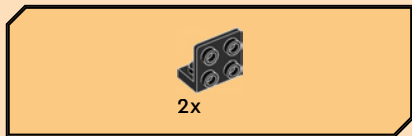

2





1x

3

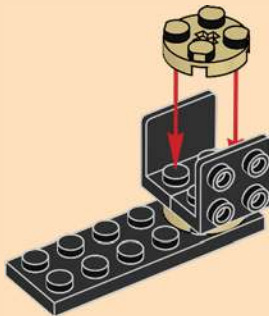

8





4



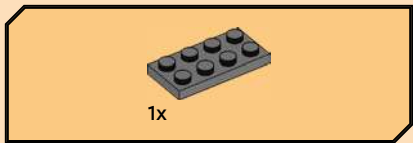

5



10



6





1x

7

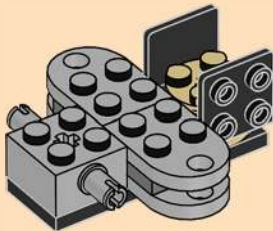



1x

8



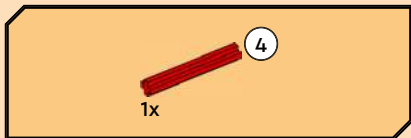

10

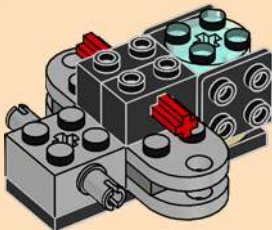



1x

11

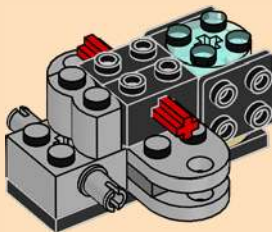

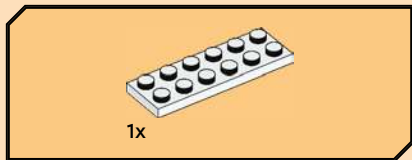

13

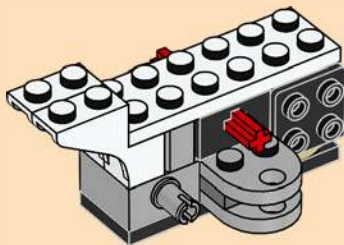

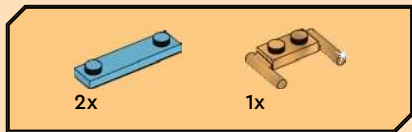

14

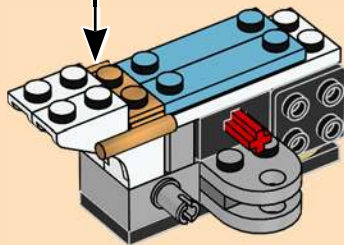
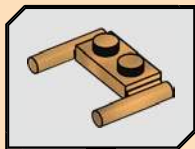



1x

15

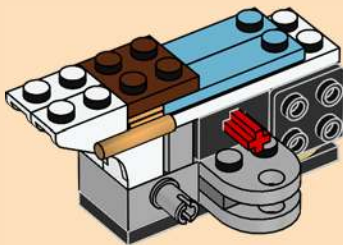

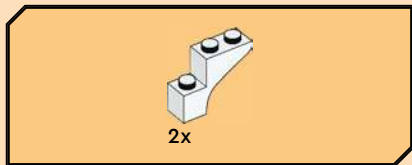

16

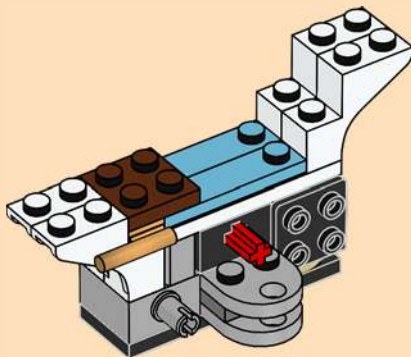



2x

19

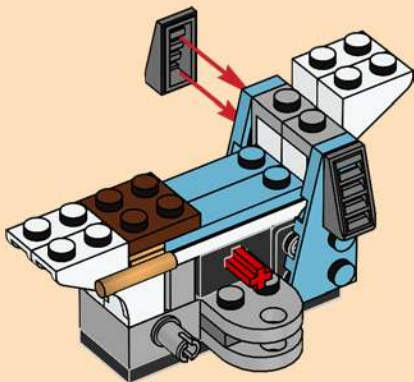



1x

21

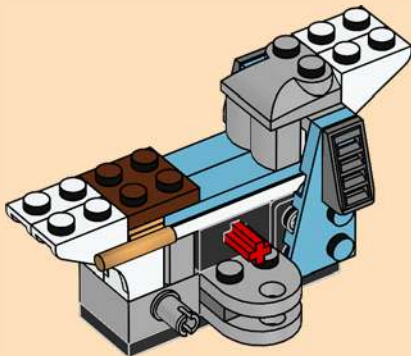



1x

22

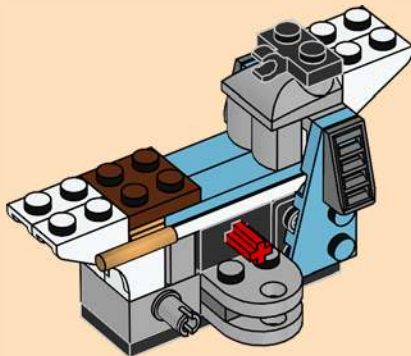

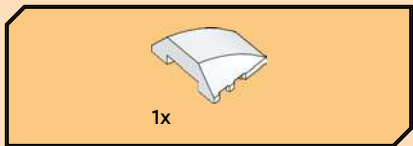

23

1

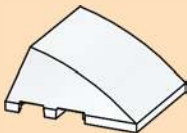

2

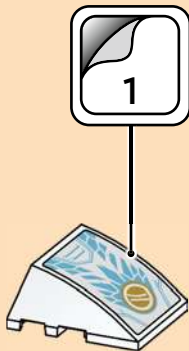

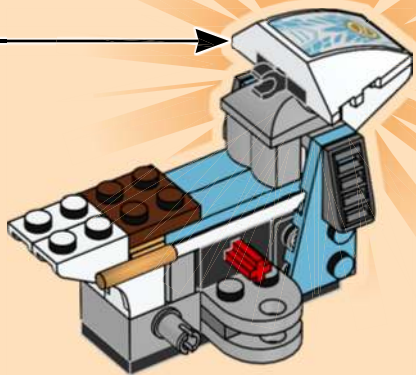



1x

24





1x



2x

25

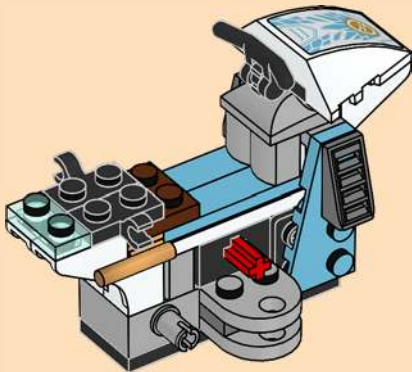



1x

26

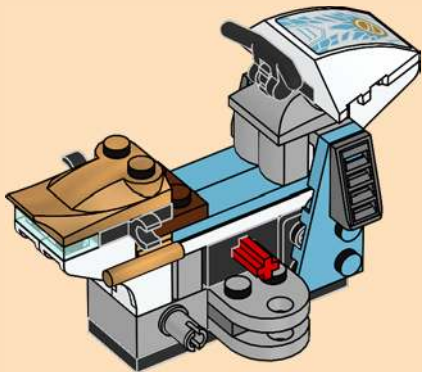

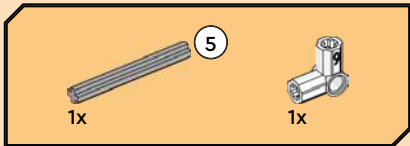

27

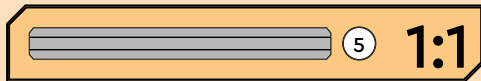
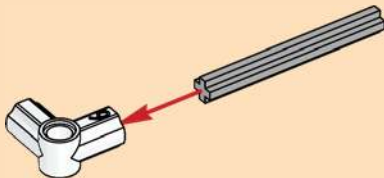

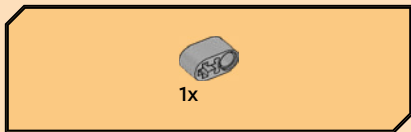

28

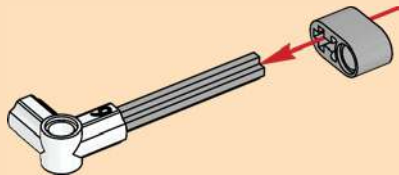

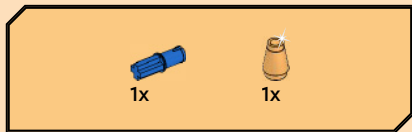

29

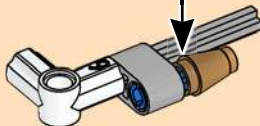
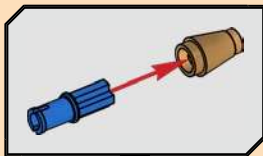



1x



1x

30

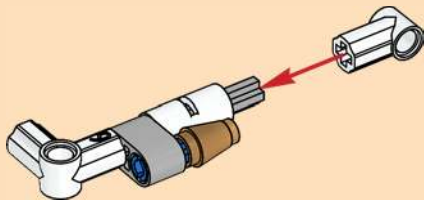

31

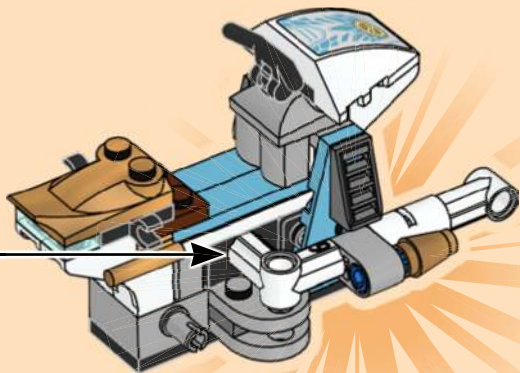

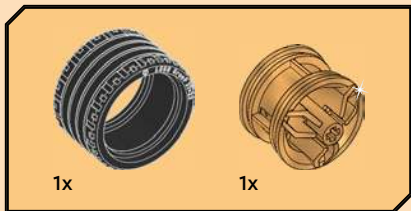

32

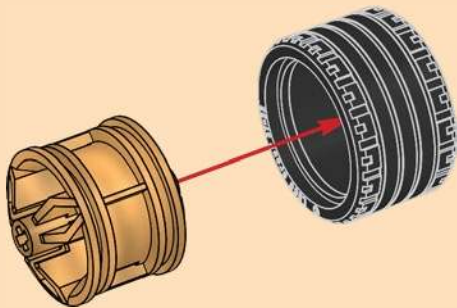



2x

33

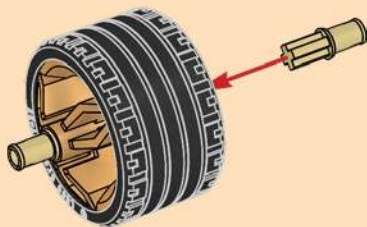

34

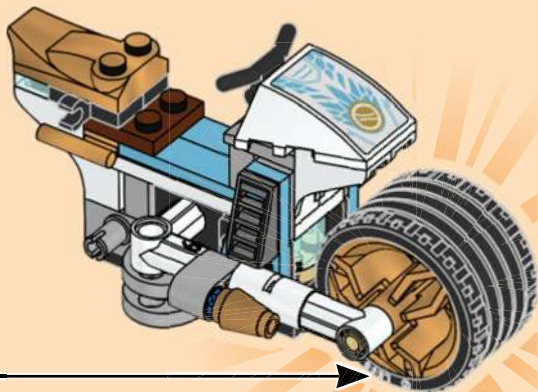

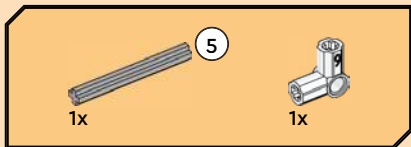

35

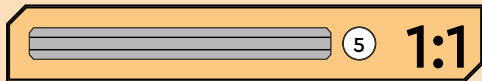
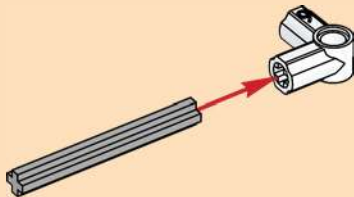

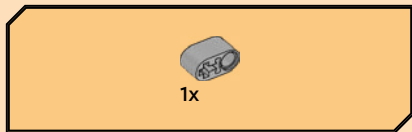

36

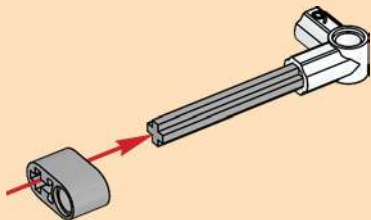

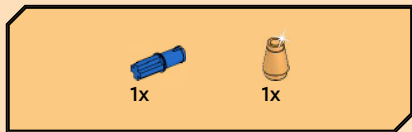

37

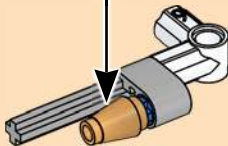
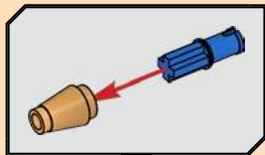



1x



1x

38

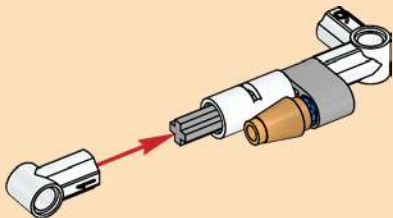

39

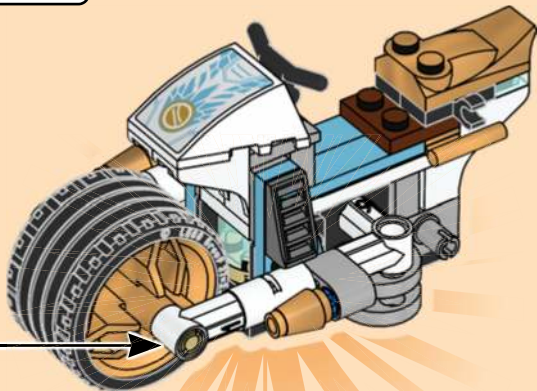

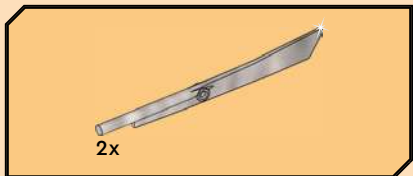

40

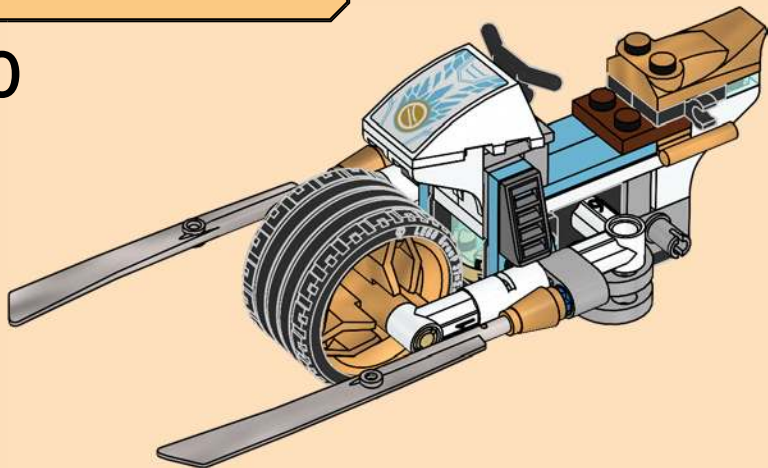



2x

41

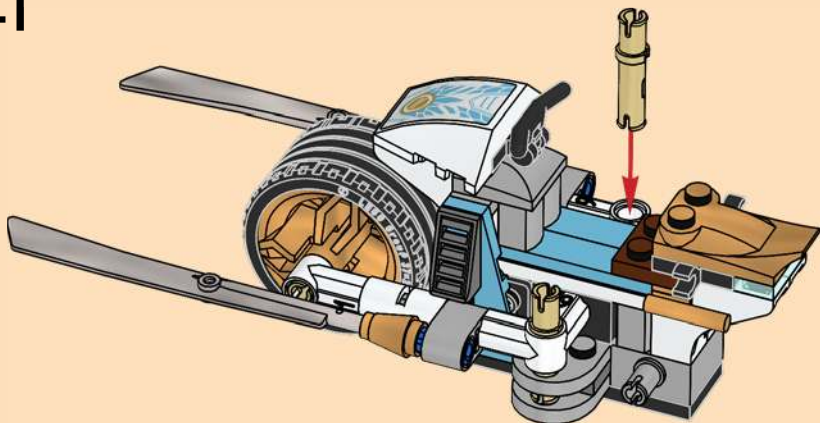

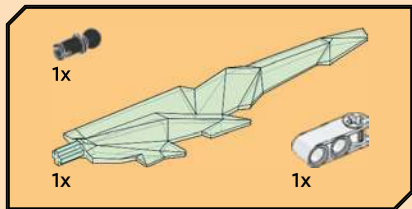

42

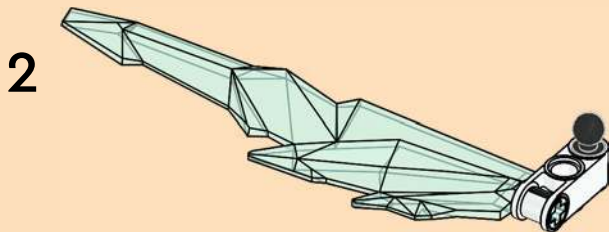

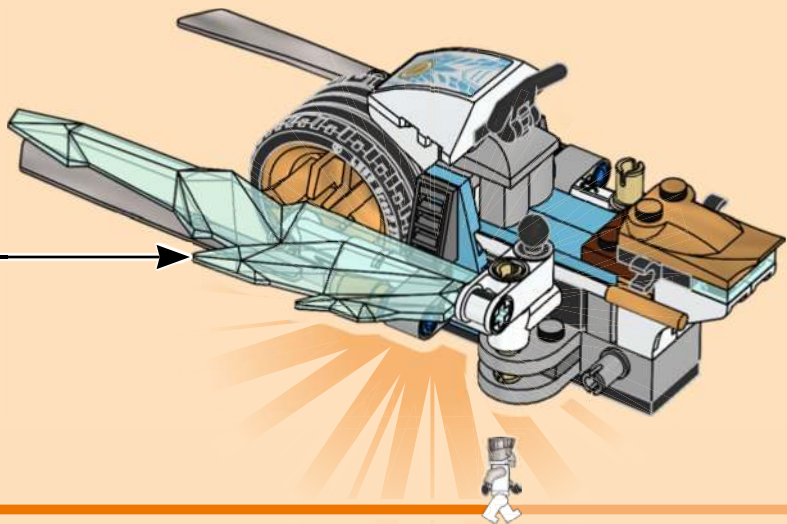

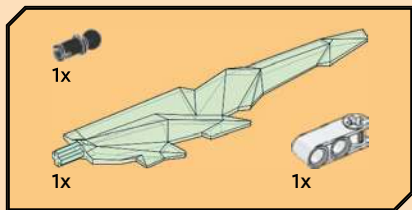

43

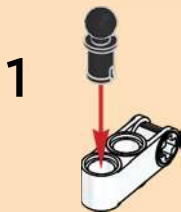

2

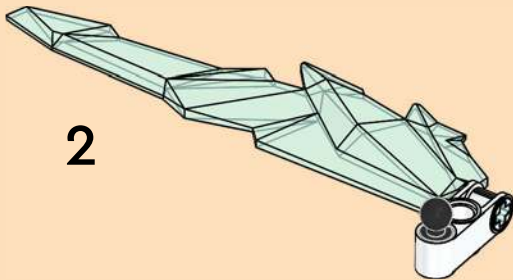

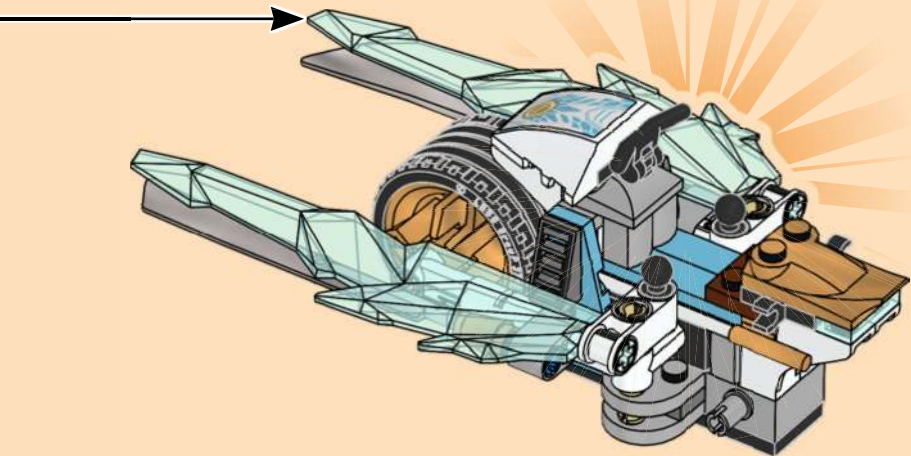

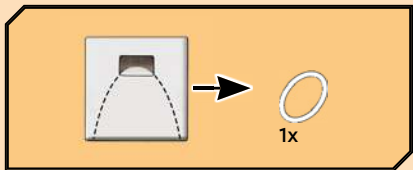

44

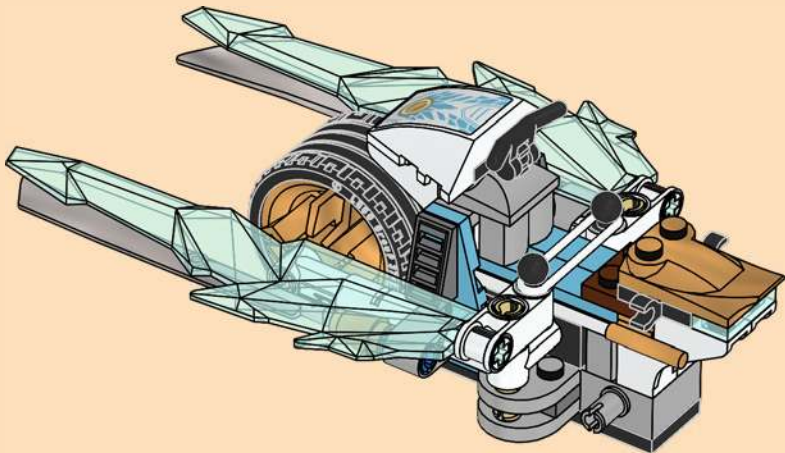

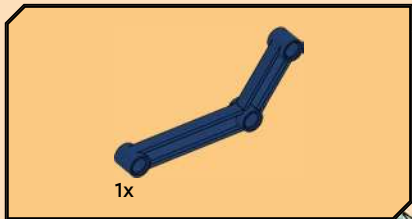

45

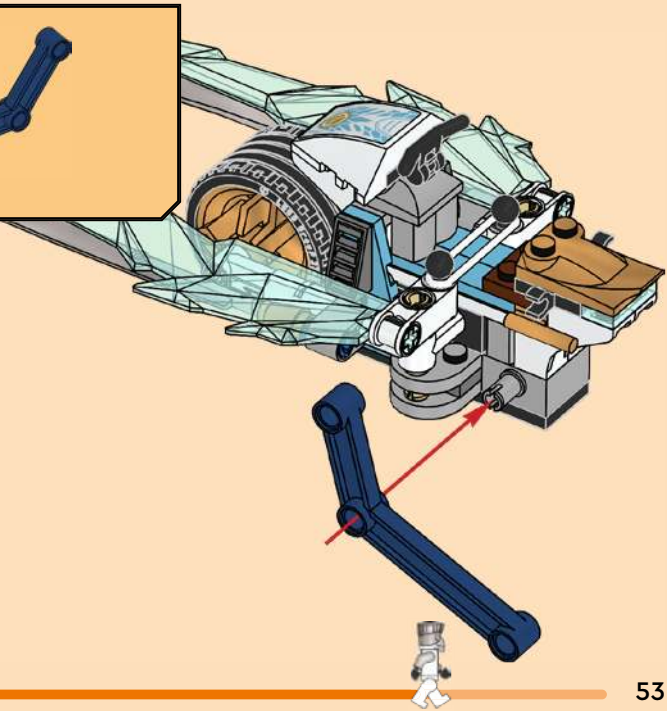

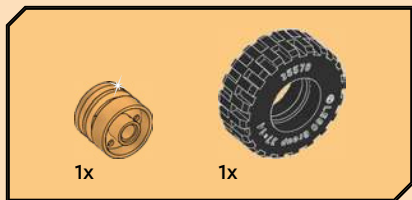

46

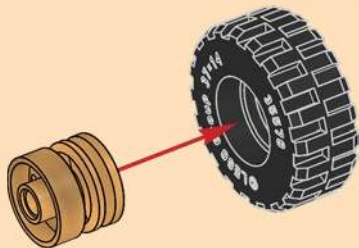

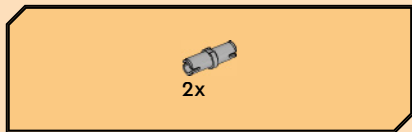

47

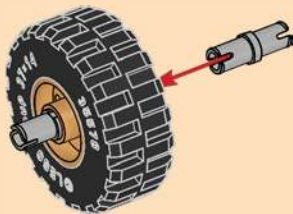

48

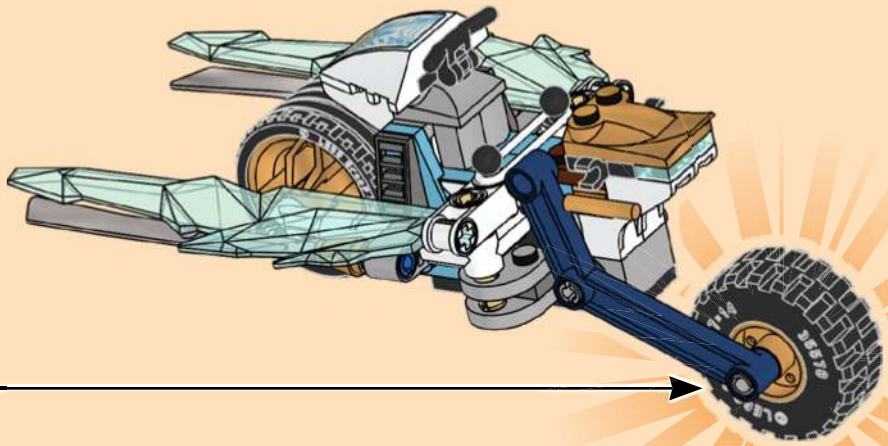

56

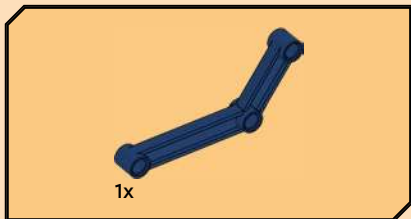

49

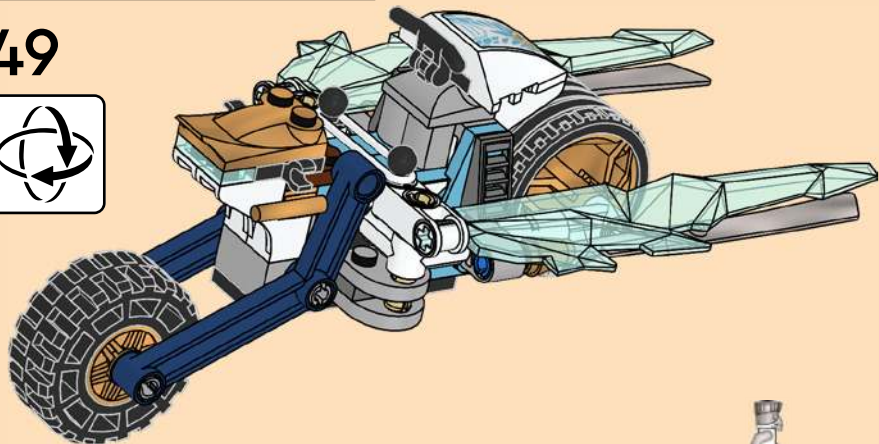



1x

50

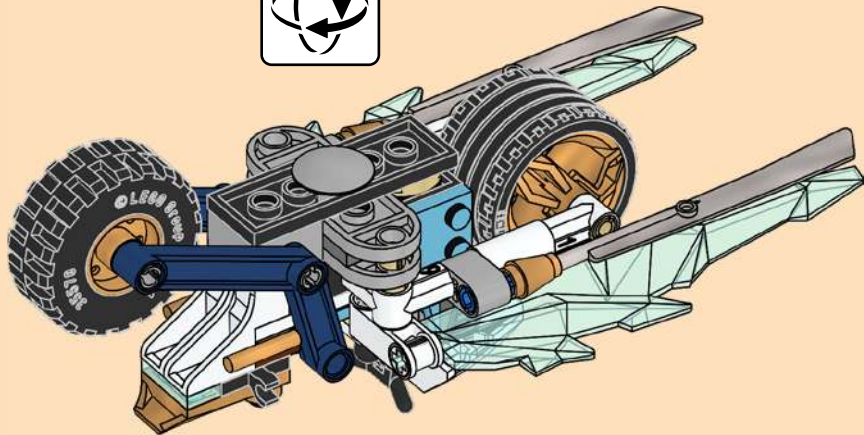

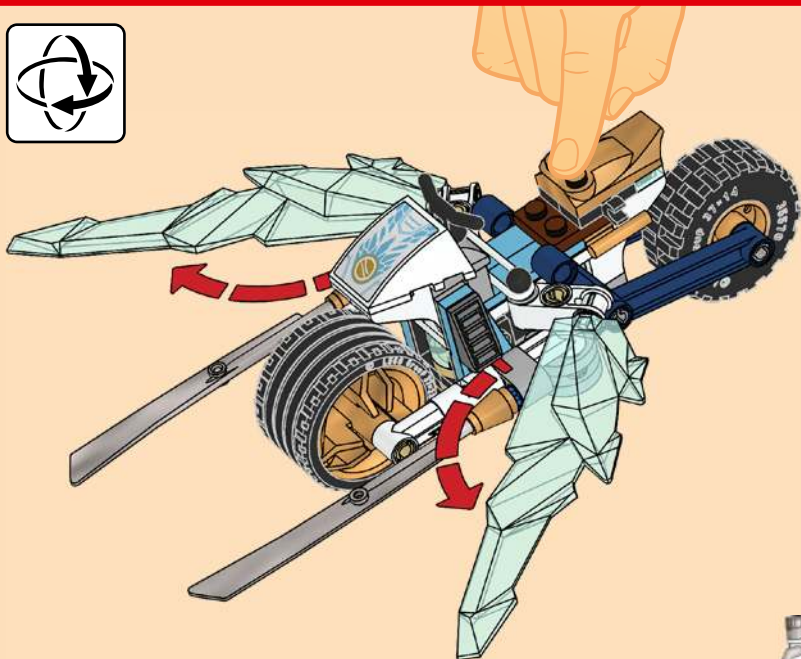

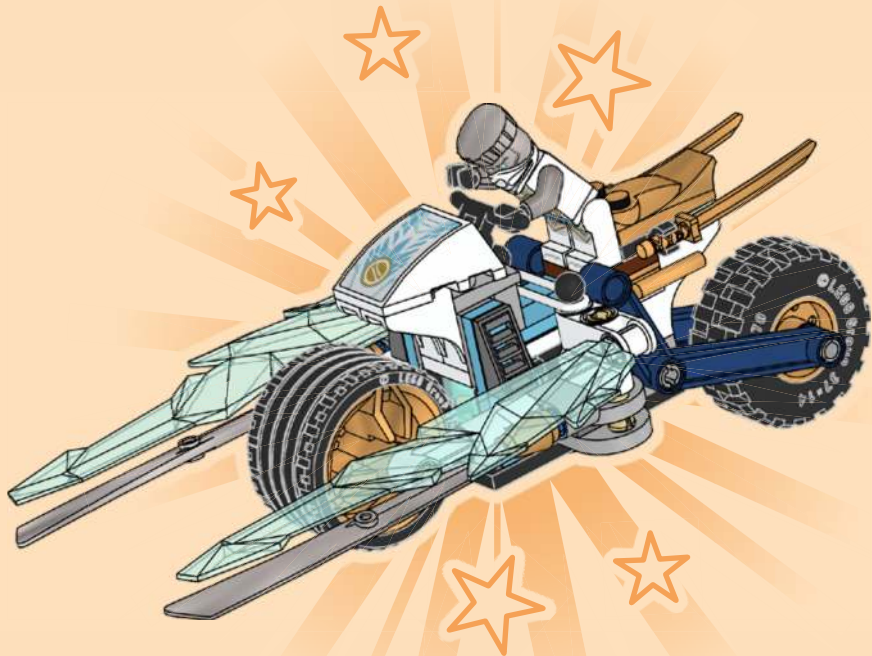

LEGO



71816



71820



71821



71818



71822



71814



2x
6332573



1x
6487241



1x
4544140



2x
6450588



1x
6484844



2x
6173116



2x
6330960

62



4x
4568956



1x
6487242



1x
4567878



1x
379501



2x
6178922



2x
6000650



1x
3003126



2x
4206482



2x
6344752



3x
6313116



1x
6248793



1x
4499234



1x
379526



1x
6273153



1x
6240222



2x
6427391



2x
6396289



2x
4666579



2x
4140562



2x
6321305



2x
6362975



1x
4278273



2x
4211807



2x
4540386



1x
4211065



1x
4216695



1x
6129995

4



2x
4550325



2x
6265089



1x
4494475



1x
6356172



4x
4211419



2x
4211639

5



2x
4529247



1x
6109685



1x
6337403



1x
6357918



1x
6305023



2x
6116596



2x
6252704



1x
6296847



1x
6296848



1x
6215718



1x
6320779



2x
6378729



[LEGO.com/service](https://www.LEGO.com/service)

FEEDBACK & REWARD



Scan this QR code or go to **LEGO.COM/PRODUCTSURVEY** and share your feedback about this LEGO® set. You will receive a free digital reward at the end of the survey via download link.

EN: FEEDBACK AND REWARD. Share your feedback and receive a free digital reward. **DE: FEEDBACK MIT BONUS.** Teile dein Feedback und erhalte einen digitalen Bonus geschenkt. **FR: AVIS ET RÉCOMPENSE.** Donnez votre avis et recevez une récompense numérique gratuite. **IT: DAI LA TUA OPINIONE E VINCI.** Condividi il tuo feedback e ricevi un premio digitale gratuito. **ES: RECOMPENSAMOS TU OPINIÓN.** Comparte tu opinión y recibe una recompensa digital gratis. **PT: DÊ O SEU FEEDBACK E GANHE RECOMPENSAS.** Partilhe o seu feedback e receba uma recompensa digital gratuita. **ZH: 反馈有奖.** 分享您的反馈意见, 获取免费数字奖励。 **PL: WYRAŻ OPINIĘ, ODBIERZ NAGRODĘ.** Podziel się swoją opinią i odbierz cyfrową nagrodę zupełnie za darmo. **CS: ODMĚNA ZA ZPĚTNOU VAZBU.** Podělte se o zpětnou vazbu a obdržíte bezplatnou digitální odměnu. **SK: ODMENA ZA SPÄTNÚ VÄZBU.** Podel'te sa o svoj názor a získajte bezplatnú digitálnu odmenu. **HU: VISSZAJELZÉS ÉS JUTALOM.** Oszd meg véleményed az ingyenes digitális jutalomért! **RO: FEEDBACK ŞI RECOMPENSĂ.** Trimite feedback şi primeşte o recompensă digitală gratuită. **BG: ОТЗИВИ И НАГРАДИ.** Споделете вашите отзиви и получите безплатна дигитална награда. **LV: ATSAUKSMES UN BALVAS.** Sniedz savu atsauksmi un saņem bezmaksas digitālo balvu. **ET: TAGASISIDE JA PREEMIA.** Jaga oma tagasisidet ja saad kingituseks digitaalse preemia. **LT: ATSLIEPIMAI IR ATLYGIS.** Bendrinkite savo atsiliepimą ir gaukite nemokamą skaitmeninį atlygį.