



STAR WARS™

75390



Q LEGO® Builder



LEGO.com/sustainable-packaging



FR
DONNEZ
OU
RECYCLEZ

 OU  OU 

ASSOCIATION MAGASIN DÉCHÈTERIE

Adresses sur quefairedemesdechets.fr



Q LEGO® Builder

BUILDER



Apple and the Apple logo are trademarks of Apple Inc., registered in the U.S. and other countries and regions. App Store is a service mark of Apple Inc. Google Play and the Google Play logo are trademarks of Google LLC. Tencent and the Tencent logo are trademarks of Tencent Inc.

Q LEGO.com/devicecheck

EN Ask parents' permission before going online | **DE** Eltern um Erlaubnis bitten, bevor du online gehst | **FR** Demande l'autorisation d'un parent avant d'aller en ligne | **IT** Chiedi il permesso ai tuoi genitori prima di andare online | **ES** Pídeles permiso a tus papás antes de conectarte a Internet | **PT** Pede autorização aos pais antes de acederes online | **ZH** 上网前应先征得父母的同意 | **PL** Poproś rodziców o zgodę, zanim wejdiesz do Internetu | **CS** Než půjdeš na internet, požádej rodiče o svolení | **SK** Skôr než pôjdeš na internet, vypýtaj si povolenie od rodičov | **HU** Kérj szülői engedélyt, mielőtt online csatlakoznál! | **RO** Cere permisiunea părinților înainte de a te conecta online | **BG** Поискайте разрешение от родител, преди да влезете онлайн | **LV** Pirms došanās tiešsaistē palūdz atļauju vecākiem | **ET** Enne Interneti kasutamist küsi vanematelt luba | **LT** Prieš prisijungdami prie interneto, atsiklauskite tėvų





STAR WARS™



Join the
25th Anniversary at
LEGO.com/SW-25

FEIERE MIT UNS DAS 25-JÄHRIGE JUBILÄUM AUF
LEGO.COM/SW-25
VENEZ CÉLÉBRER NOTRE 25^e ANNIVERSAIRE SUR
LEGO.COM/SW-25
FESTEGGIA CON NOI IL 25^o ANNIVERSARIO SU
LEGO.IT/SW-25
PARTICIPA EN EL 25 ANIVERSARIO EN
LEGO.COM/SW-25
JUNTE-SE AO 25.^o ANIVERSÁRIO EM
LEGO.COM/SW-25

访问 LEGO.COM/SW-25, 参加 25 周年庆典
ŚWIĘTUJ Z NAMI 25. ROCZNICĘ NA STRONIE
LEGO.COM/SW-25

OSLAVTE S NÁMI 25. VÝROČÍ NA LEGO.COM/SW-25
OSLÁVTE S NAMI 25. VÝROČIE NA
LEGO.COM/SW-25

CSATLAKOZZ A 25. ÉVFORDULÓHOZ A
LEGO.HU/SW-25 OLDALON!

ALĀTURĀ-TE CEĻEI DE-A-25-A ANIVERSĂRI PE
LEGO.COM/SW-25

ПРИСЪЕДИНЕТЕ СЕ КЪМ 25ТАТА ГОДИШНИНА НА
LEGO.COM/SW-25

PIEVIENOJIES 25. JUBILEJAI VIETNĒ LEGO.COM/SW-25
LITU 25.TH AASTAPÄEVAGA AADRESSIL
LEGO.COM/SW-25

ŠVĖSKIME 25-AJĄ SUKAKTĮ DRAUGE SVETAINĖJE
LEGO.COM/SW-25

25 YEARS OF LEGO® STAR WARS™
25 JAHRE LEGO® STAR WARS™
25 ANS DE LEGO® STAR WARS™
25 ANNI DI LEGO® STAR WARS™
25 AÑOS DE LEGO® STAR WARS™
25 ANOS DE LEGO® STAR WARS™
乐高® 星球大战™ 25 周年
25 LAT LEGO® STAR WARS™

25 LET LEGO® STAR WARS™
25 ROKOV LEGO® STAR WARS™
25 ÉVNŮYI LEGO® STAR WARS™
25 DE ANI DE LEGO® STAR WARS™
25 ГОДИНИ LEGO® STAR WARS™
LEGO® STAR WARS™ 25 GADI
25 AASTAT LEGO® STAR WARS™
25 METAI LEGO® STAR WARS™

© & ™ Lucasfilm Ltd.





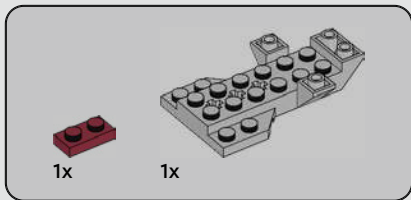

1

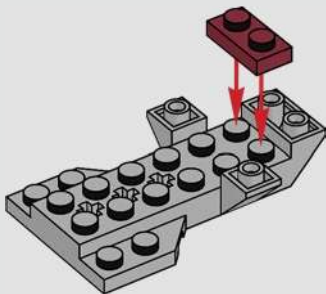



1x

2

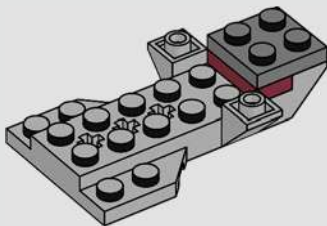



2x

3

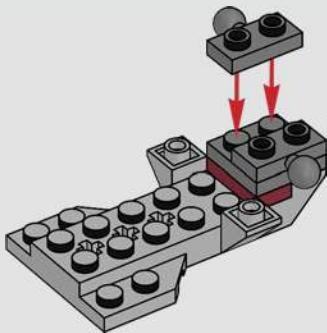

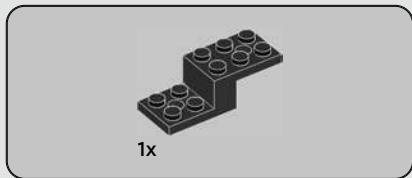

4

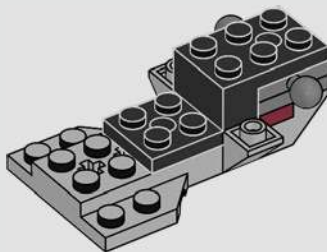



1x

5

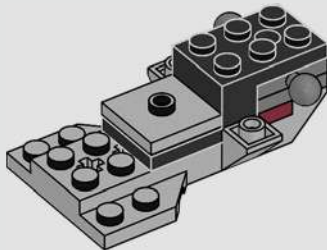

10





2x

6

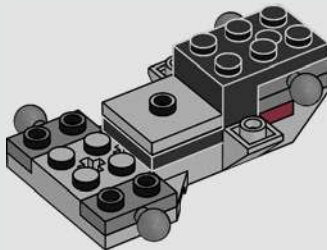



2x

7

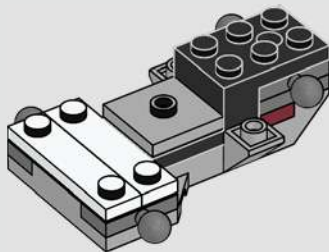



2x

8

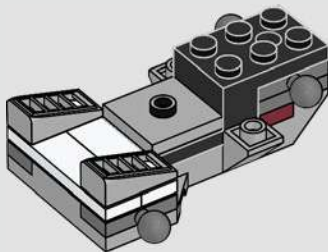



2x

9

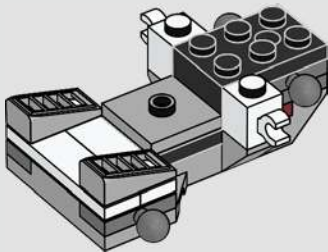



2x

10

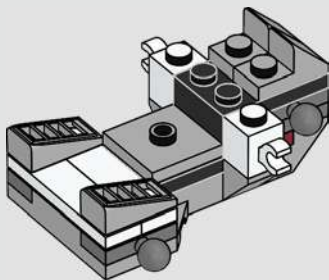

2x

11

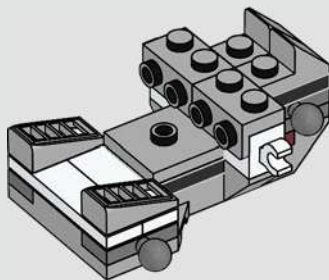



1x

12

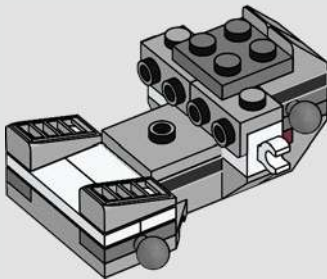



2x

13

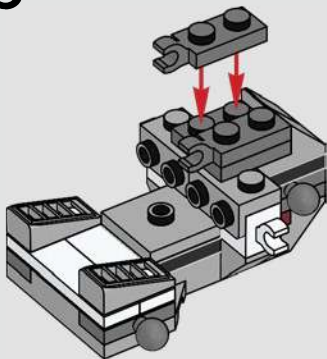

2x

14

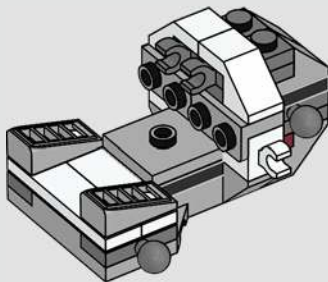



2x



1x

15

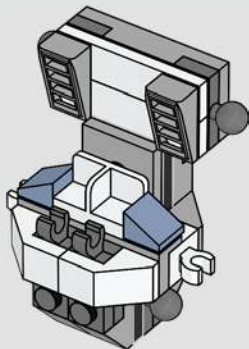

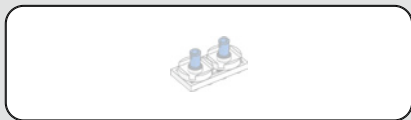

16



17





2x

18

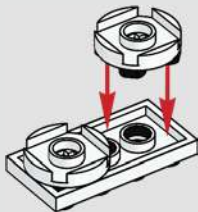

2x

19

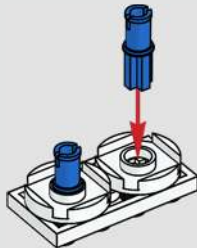

20



20

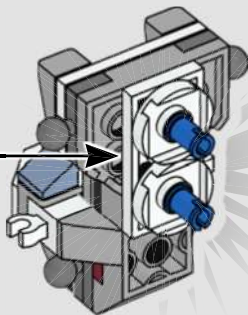



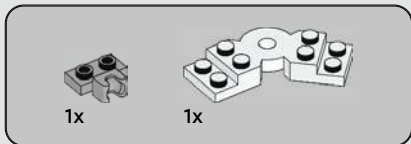

21

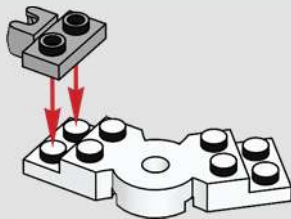



1x

22

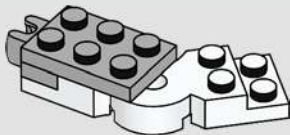



1x



1x



1x

23

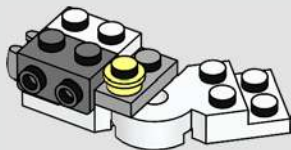

1x



1x

24

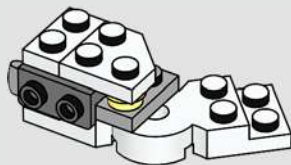



1x



1x

25

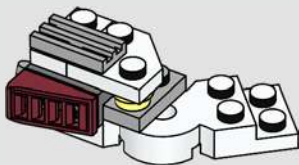



1x

26

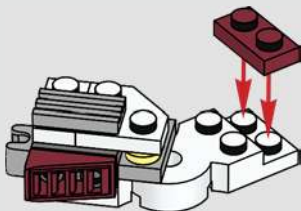

1x



1x

27





1x



1x



1x

28





1x

29



1x

30





1x

31



30





1x



1x

32

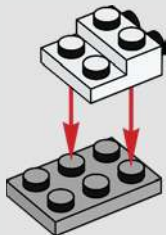

2x



1x

33



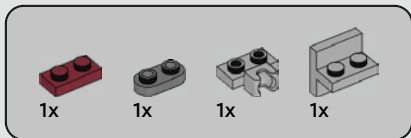

34

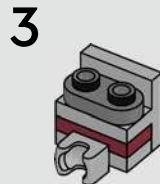
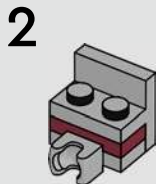
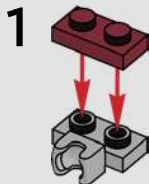

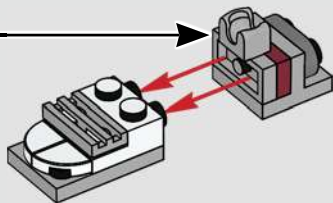

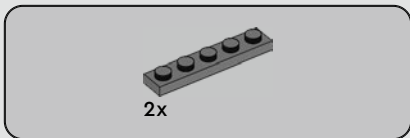

35

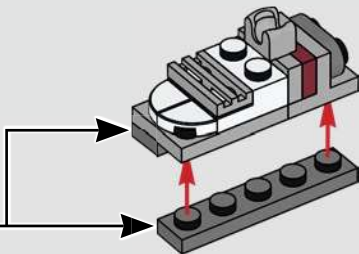
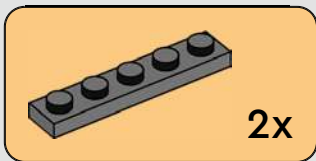

36

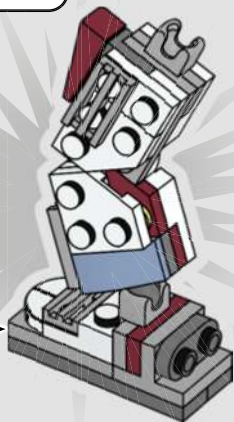

37

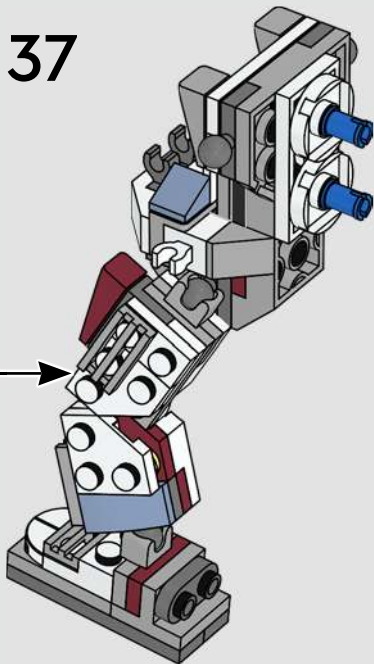



1x



1x

38

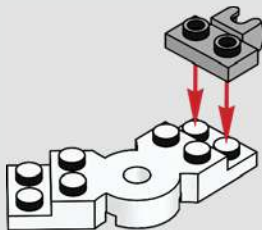



1x

39

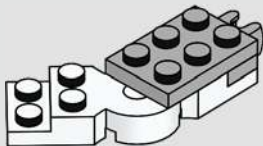

1x



1x



1x

40

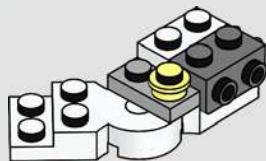



1x



1x

41

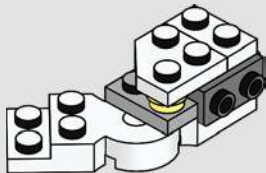



1x



1x

42

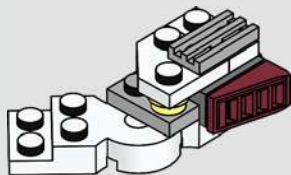

1x

43

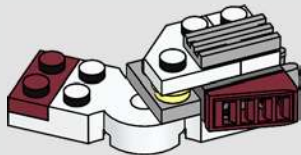



1x



1x

44

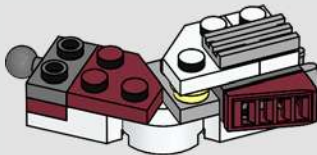



1x



1x



1x

45



1x

46





1x

47



1x

48





1x



1x

49

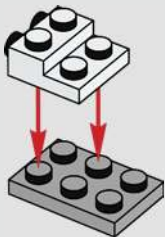

2x



1x

50

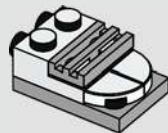

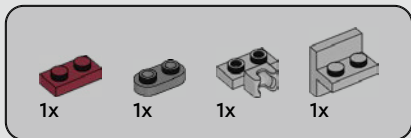

51

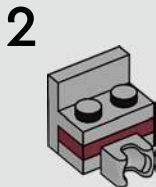
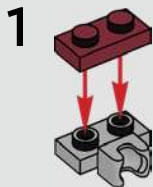

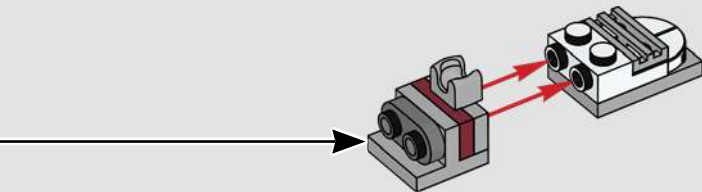

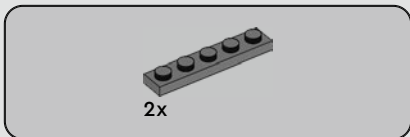

52

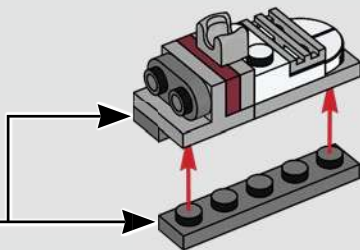
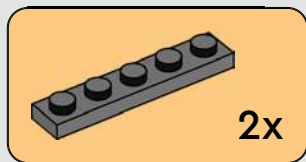

53

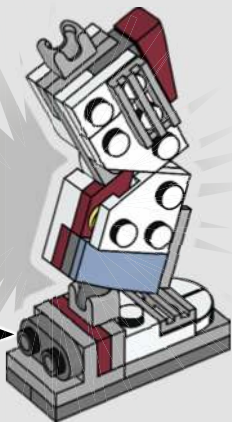

54

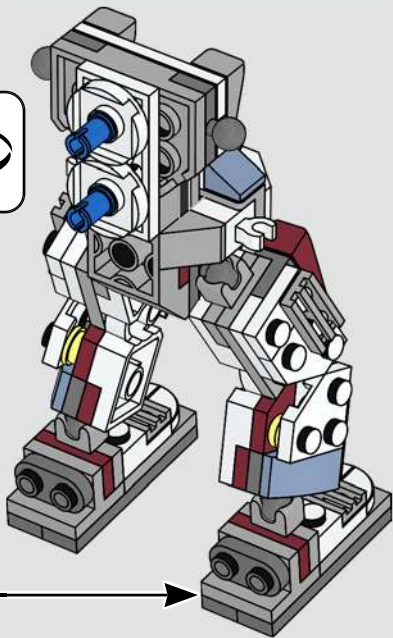
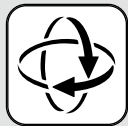



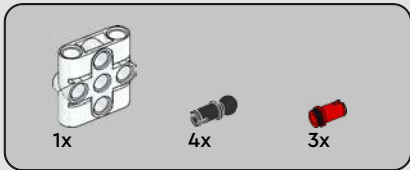

55

1



2

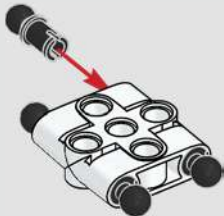

3



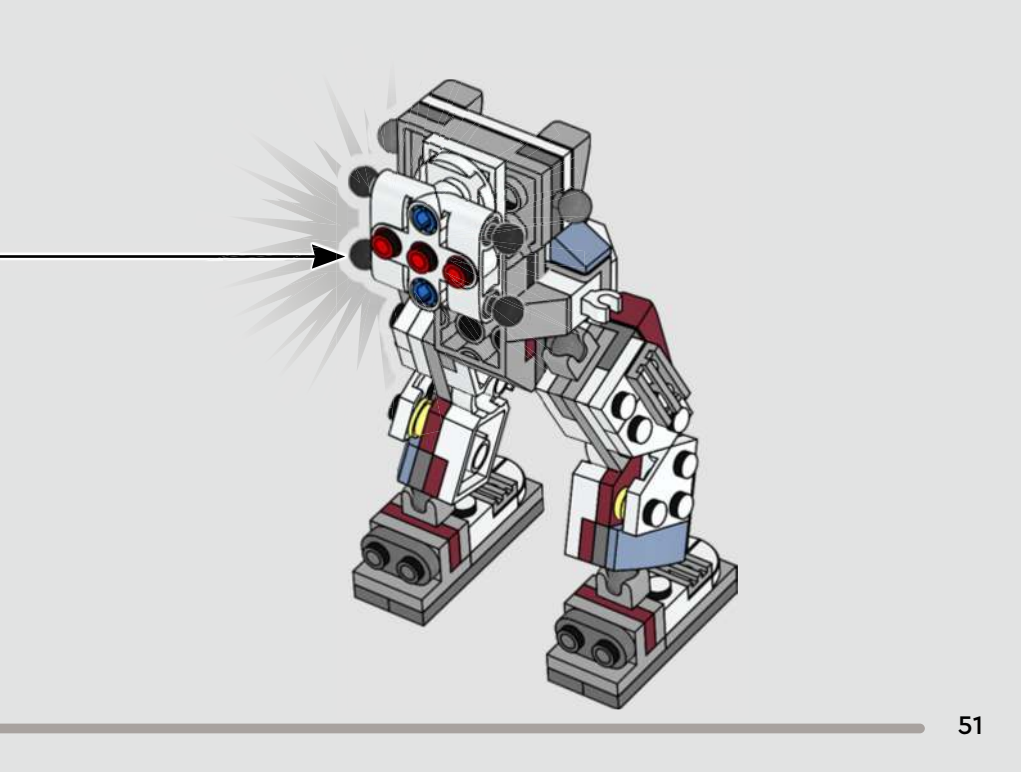



2x



1x



1x

56

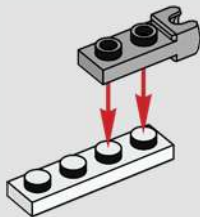



1x



1x

57

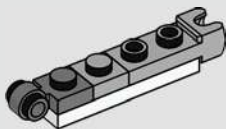

1x

58

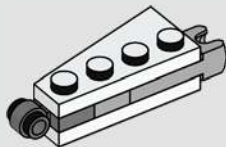



1x

59

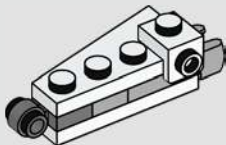



1x

60

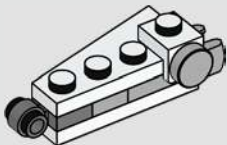

1x

61

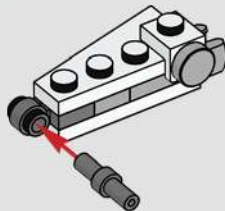

2x



62

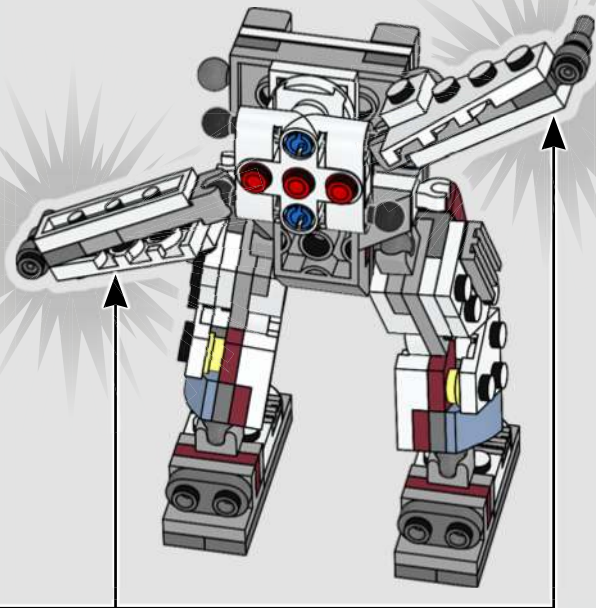



2x



1x



1x

63

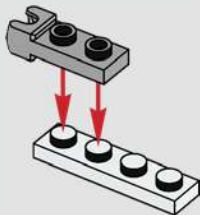



1x



1x

64

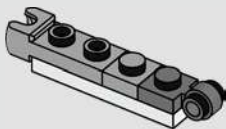



1x

65

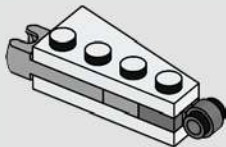

1x

66

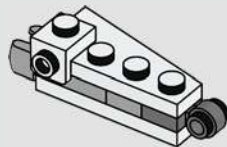



1x

67

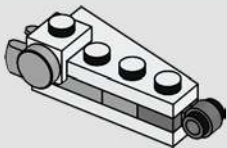

1x

68

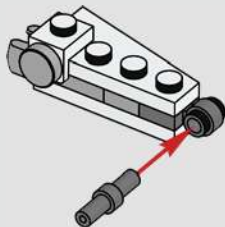

2x

69

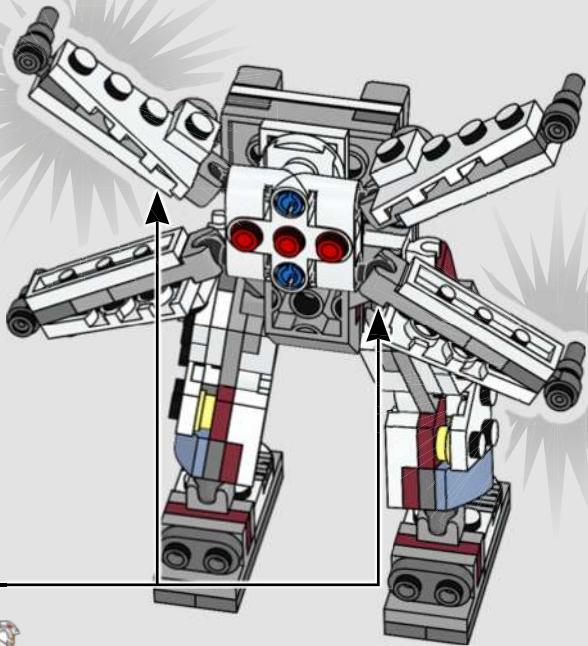

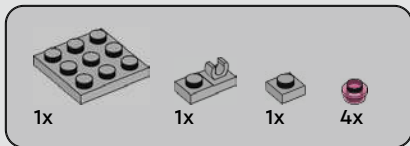

70

1

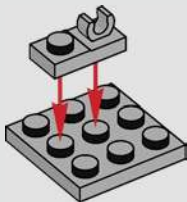

2

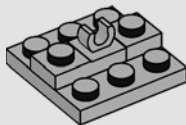

3

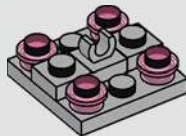

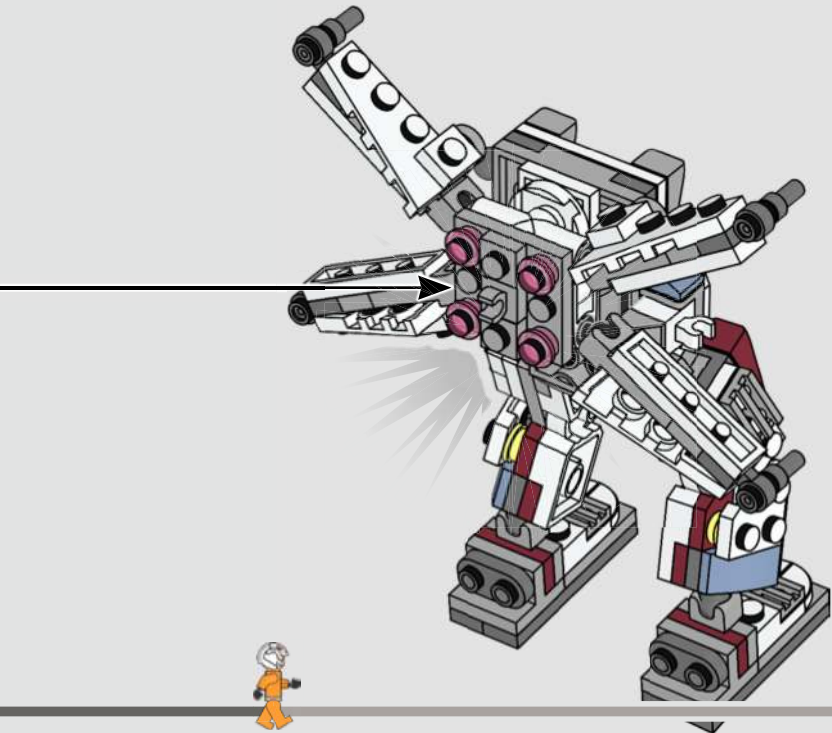

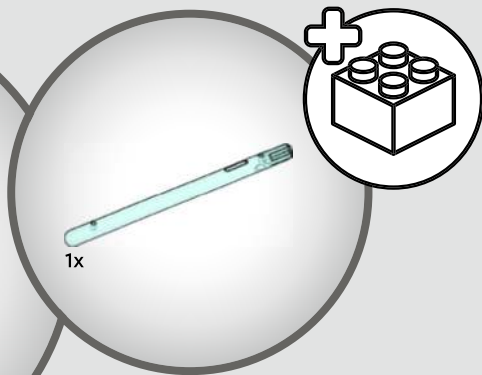
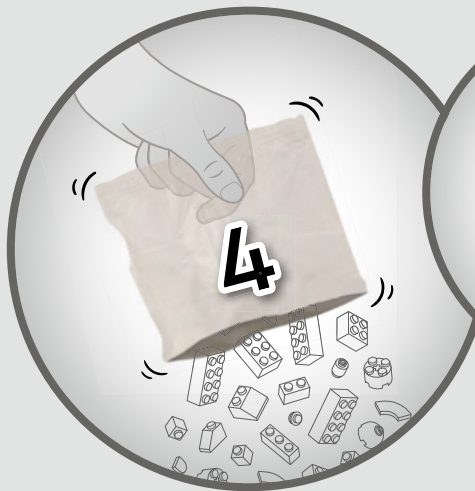

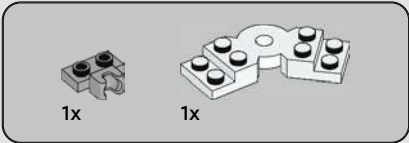
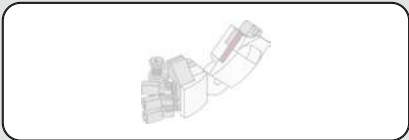

71

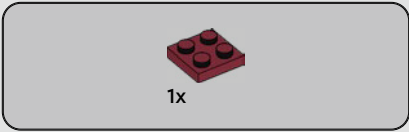
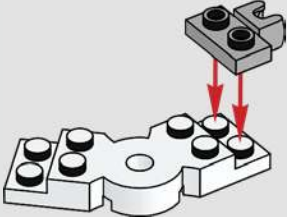

72

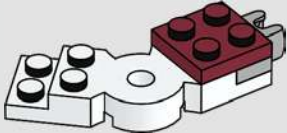



1x

73

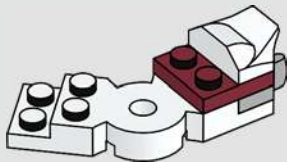

1x

74

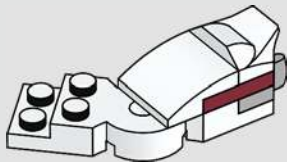



1x

75



1x



1x

76

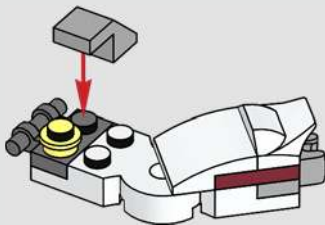



1x

77

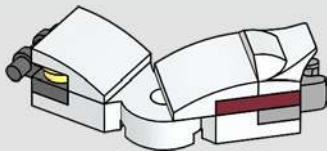



1x

78

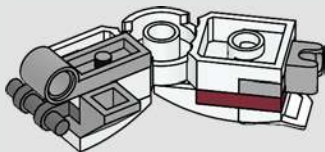

1x

79

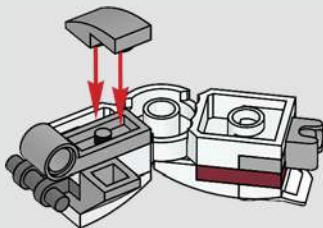



1x

80

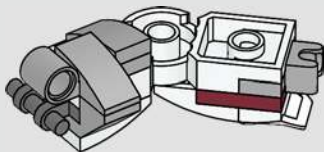



1x

81

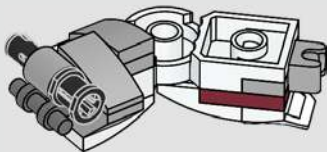

1x

82

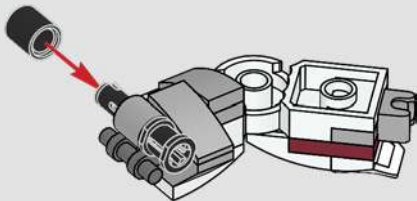



3x

83

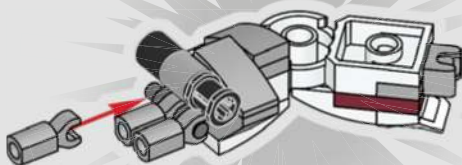

84

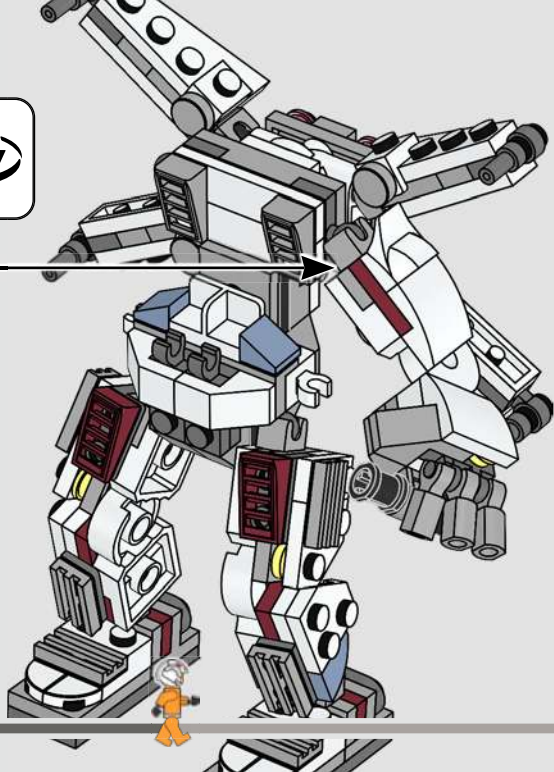

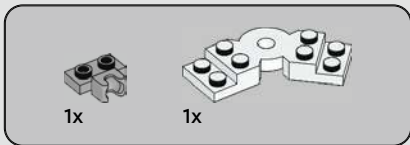

85

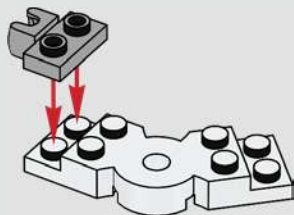



1x

86

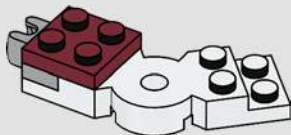

1x

87

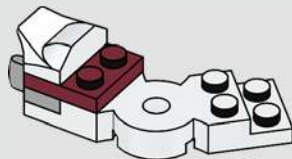



1x

88

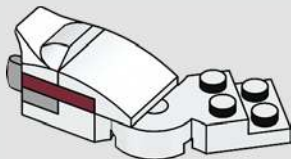



1x

89

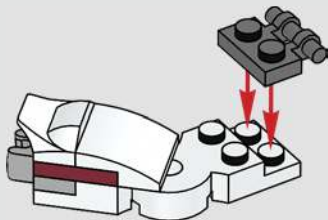

1x



1x

90

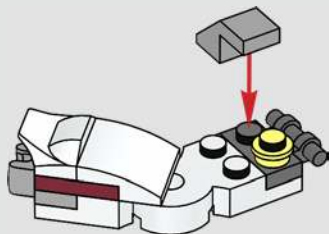



1x

91

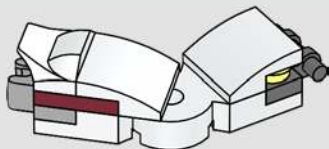



1x

92

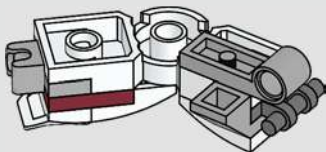

1x

93

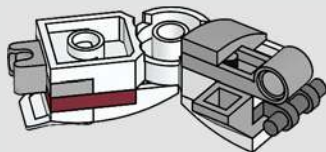



1x

94

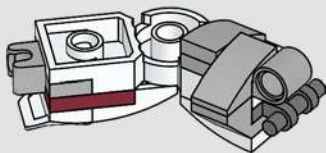



1x

95

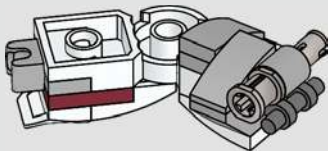

1x

96

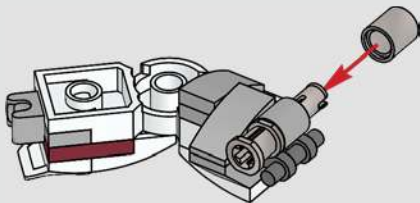



3x

97

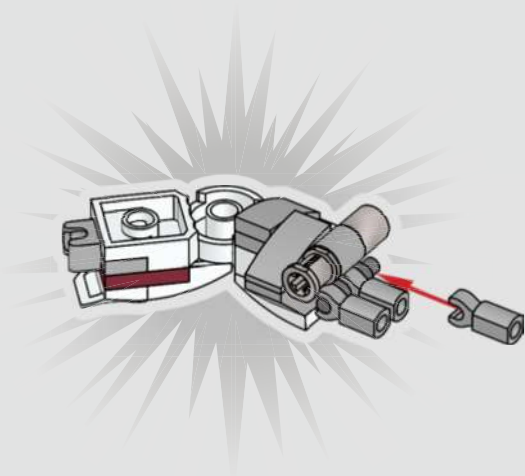

98

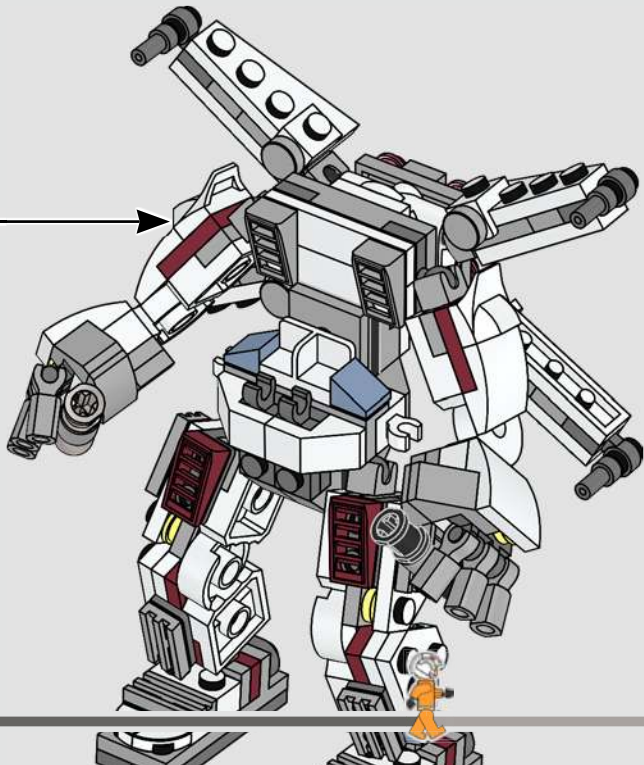



1x



1x

99

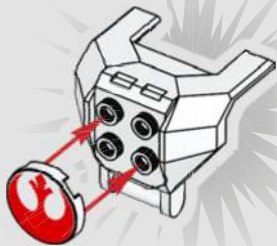

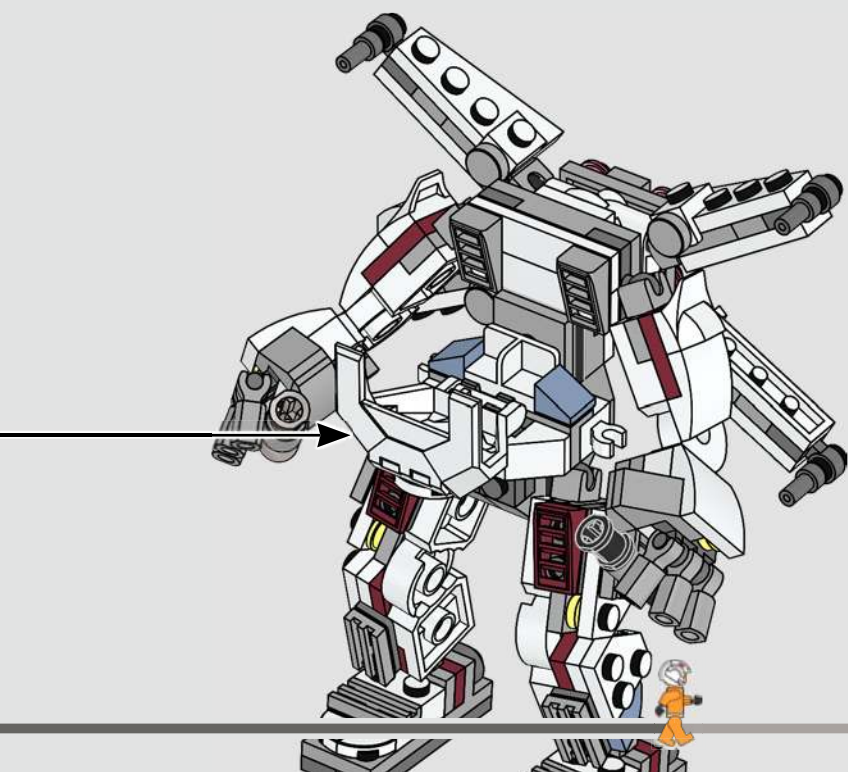

100

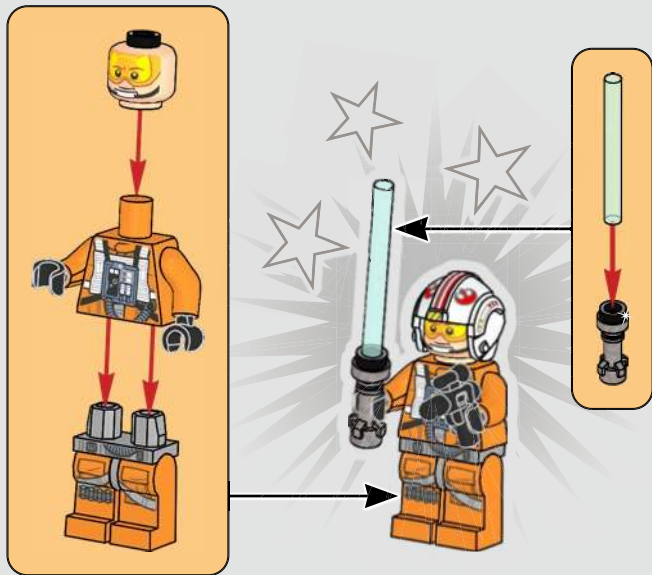

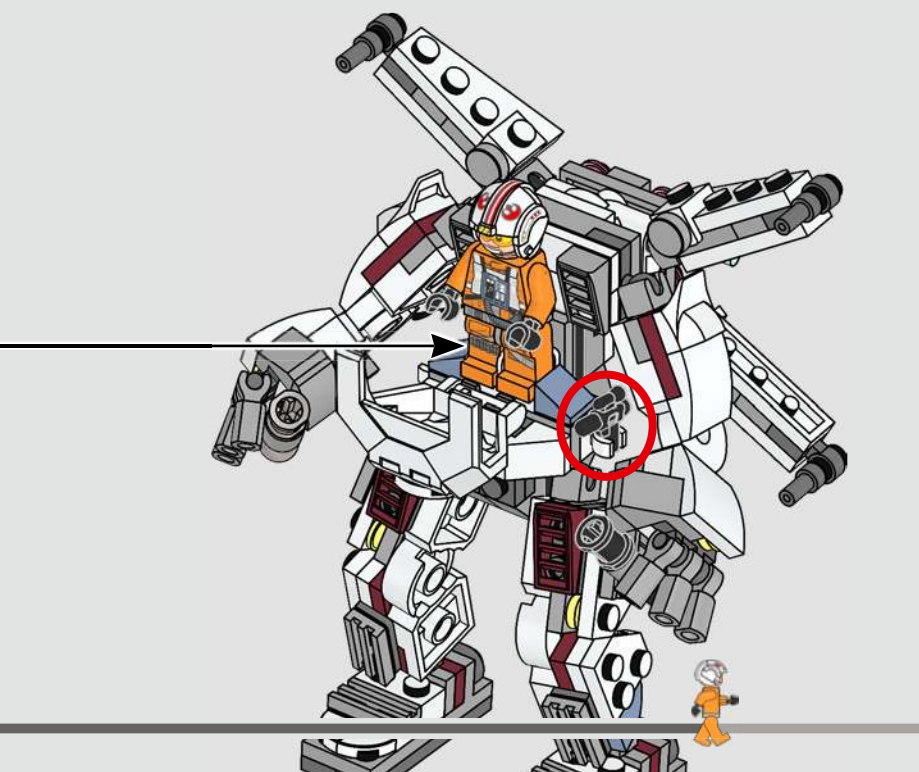

101

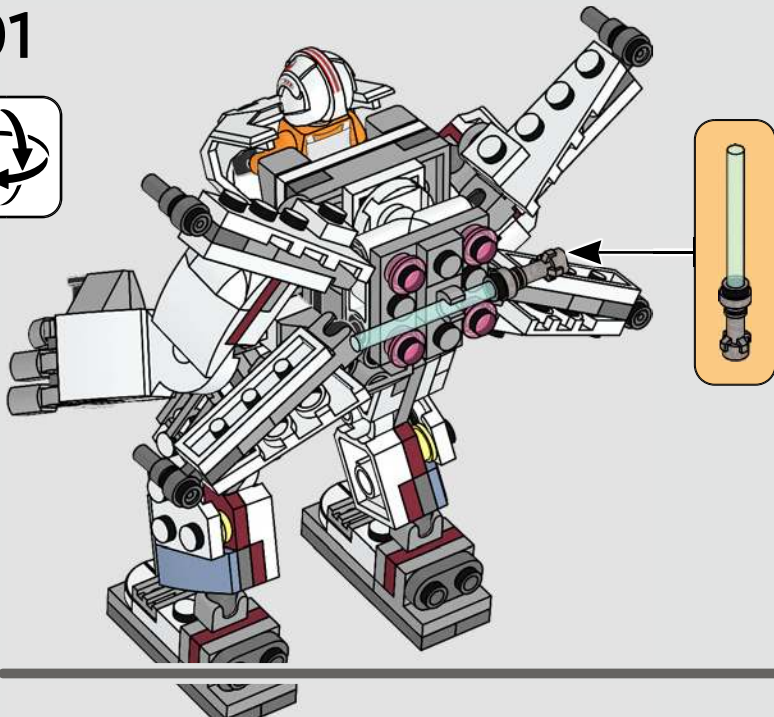

102

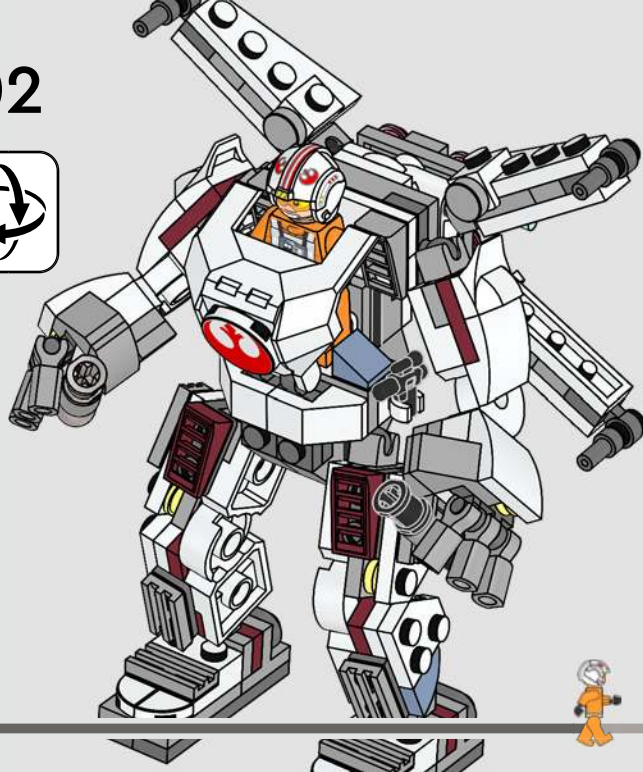

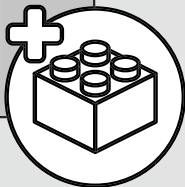
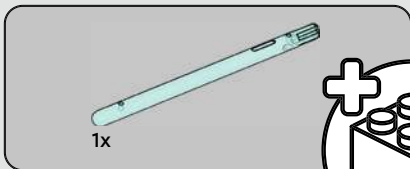

103

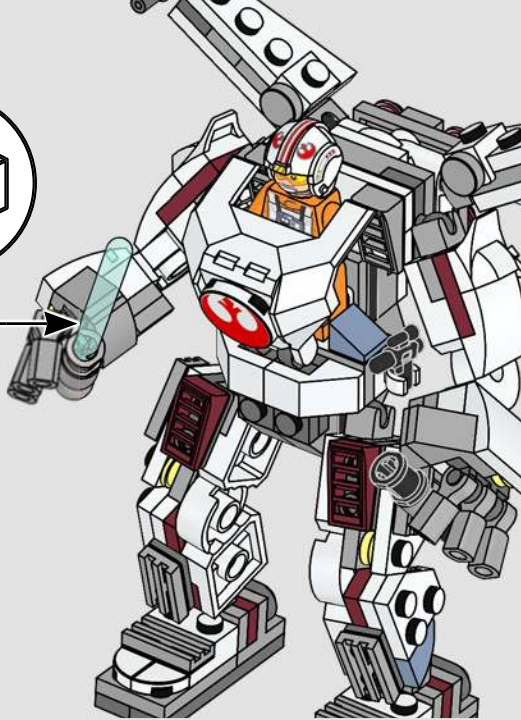
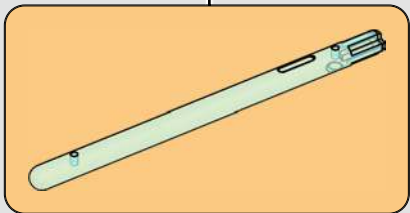



2x

104



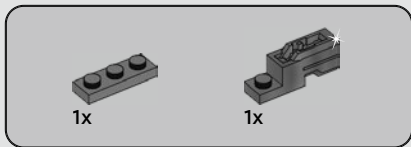

105

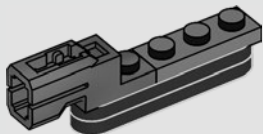

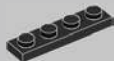

1x

106

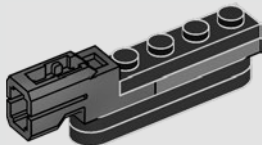

1x

107

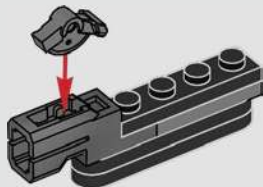



1x

108

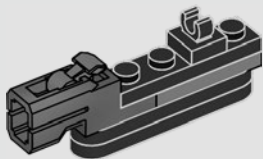



109

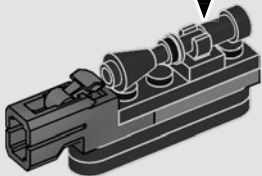
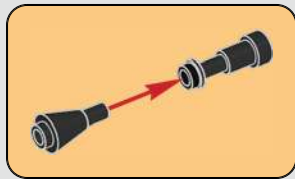



1x

110

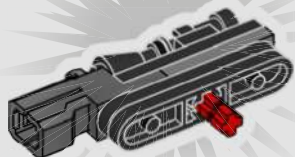
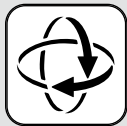

111

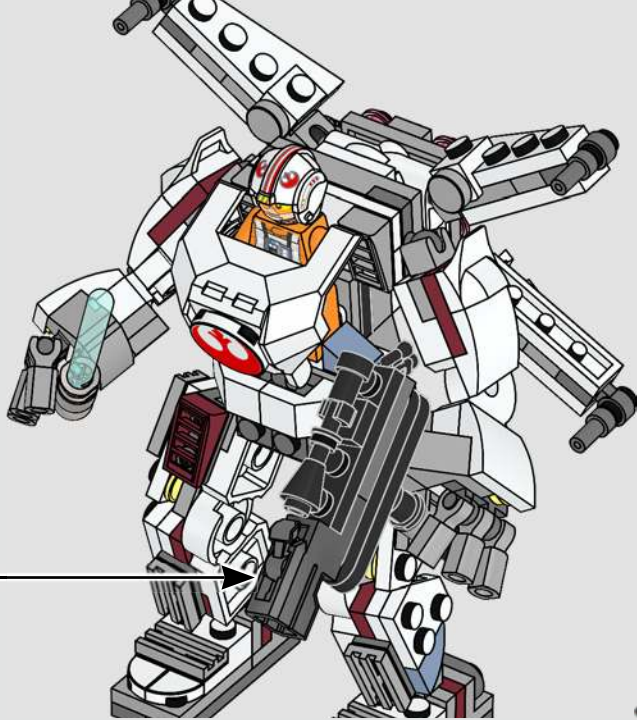



2x

112

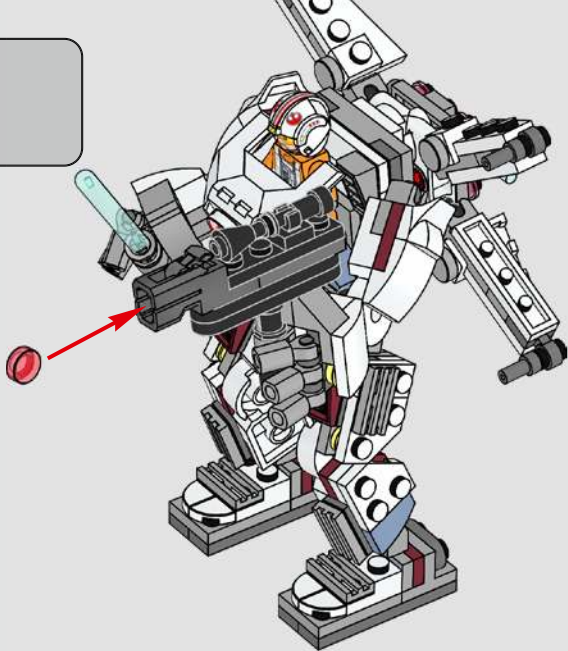

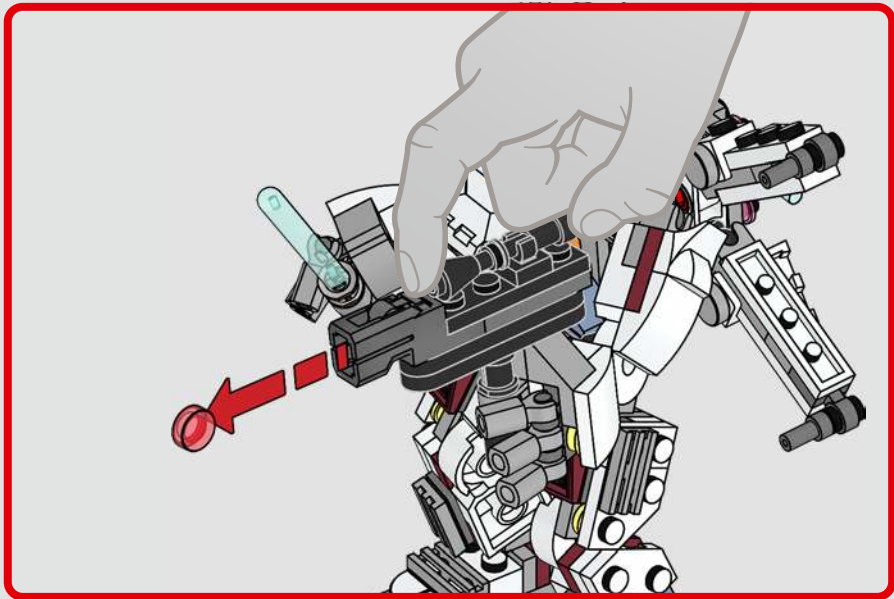

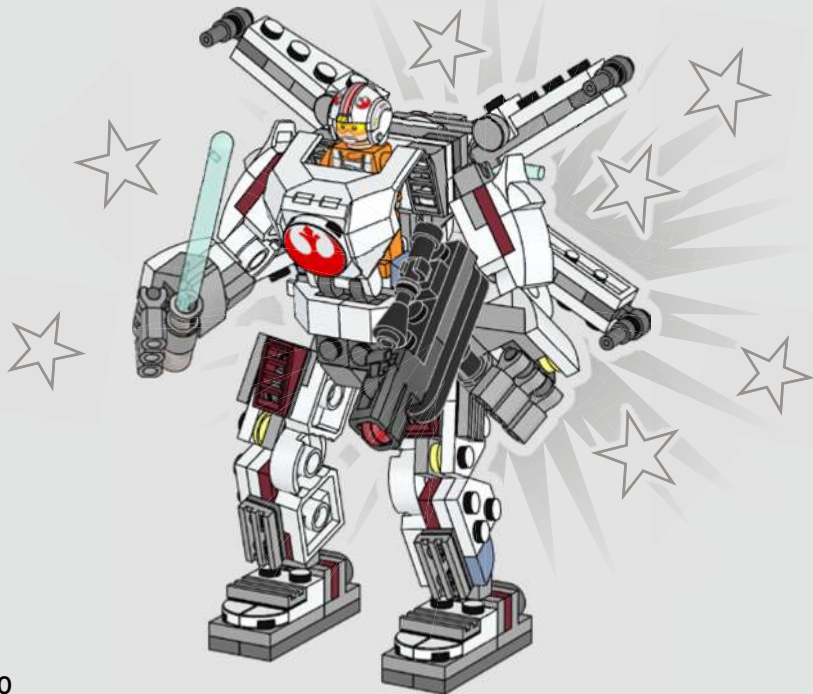



STAR WARS

75386



75390

75391



75373



© & ™ Lucasfilm Ltd.



4x
6172366



2x
302401



4x
6296132



2x
6320310



1x
6253062



2x
4160857



2x
4161326



2x
4161326



1x
6488451



2x
403201



4x
302301



4x
6176240



2x
6375711



2x
6166894



1x
6093479



4x
6047220



2x
6469441



1x
6247424



4x
371001



2x
6249091



1x
6341397



1x
370901



4x
6425460



3x
6378120



1x
4142865



2x
4206482



1x
6056234



1x
6121485



1x
6335388



1x
6360207



4x
6344752



1x
4538456



1x
6321745



1x
371026



2x
6280168



1x
6039194



1x
6334227



1x
6507882



2x
6258607



4x
6240230



2x
6062686



2x
6179812



2x
6409756



5x
4539097



2x
6210310



2x
4585479



6x
6355025



4x
6284071



5x
4211399



1x
6328227



6x
4211350



6x
6043656

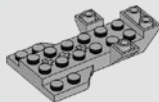

1x
6452334



2x
6213378



2x
6093859



2x
6092111



1x
6326078



2x
4654582



2x
6258820



1x
6126082



4x
6043639



2x
6438836



4x
4211396



1x
6015347



4x
6144138



6x
6319958



1x
6253114



1x
4211133



4x
6413109



1x
6360675



2x
6221607



2x
4210660



4x
6281996



6x
6039479



4x
6214341



4x
6350724



2x
6336990



2x
4211094



1x
6161155



1x
6287673



1x
6345952



1x
6051389



1x
6508267



LEGO.com/service

YOU COULD

WIN

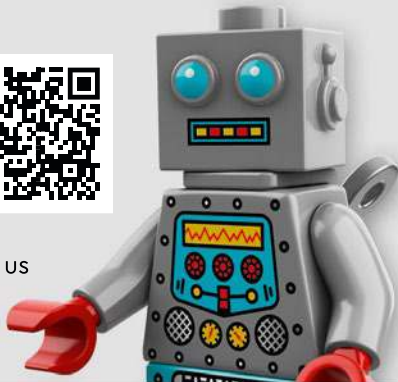

Scan this QR code or go to
LEGO.COM/PRODUCTFEEDBACK and give us
your short feedback about this LEGO® set
for a chance to win a cool LEGO prize.

Terms and Conditions apply*

EN: YOU COULD WIN. Terms and Conditions apply* **DE: Du könntest GEWINNEN.** Es gelten die Teilnahmebedingungen* **FR: Tu pourrais GAGNER.** Des conditions s'appliquent* **IT: Potresti VINCERE tu.** Termini e condizioni sono applicabili* **ES: Puedes GANAR.** Aplican términos y condiciones* **PT: Poderá GANHAR.** Aplicam-se termos e condições* **ZH: 轻松获奖.** 条款和条件适用* **PL: Szansa na WYGRANĄ.** Obowiązują warunki korzystania* **CS: Máte šanci VYHRÁT.** Platí všeobecné smluvní podmínky* **SK: Máte šancu VYHRÁT.** Platia všeobecné zmluvné podmienky* **HU: TE IS NYERHETSZ.** Felhasználási feltételek érvényesek* **RO: Ai putea CÂȘTIGA.** Se aplică termenii și condiții* **BG: Можете да СПЕЧЕЛИТЕ.** Има определени правила и условия* **LV: Tu vari LAIMĒT.** Ir spēkā noteikumi un nosacījumi.* **ET: Sul on võimalus VÕITA.** Kehtivad tingimused* **LT: Jūs galite LAIMĖTI.** Taikomos sąlygos*

*[LEGO.com/productfeedback-terms](https://www.lego.com/productfeedback-terms)

LEGO and the LEGO logo are trademarks of the LEGO Group. ©2024 The LEGO Group.

© & ™ Lucasfilm Ltd.

6522627