



JURASSIC WORLD

76962



LEGO® Builder



[LEGO.com/sustainable-packaging](https://LEGO.com/sustainable-packaging)



**FR**  
**DONNEZ**  
OU  
**RECYCLEZ**

 OU  OU 

ASSOCIATION MAGASIN DÉCHÈTERIE

Adresses sur [quefairedemesdechets.fr](https://quefairedemesdechets.fr)

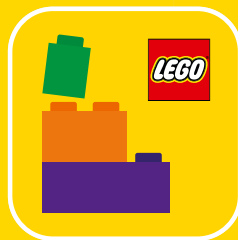

Q LEGO® Builder

# BUILDER



Apple and the Apple logo are trademarks of Apple Inc., registered in the U.S. and other countries and regions. App Store is a service mark of Apple Inc. Google Play and the Google Play logo are trademarks of Google LLC. Tencent and the Tencent logo are trademarks of Tencent Inc.

Q [LEGO.com/devicecheck](https://lego.com/devicecheck)

**EN** Ask parents' permission before going online | **DE** Eltern um Erlaubnis bitten, bevor du online gehst | **FR** Demande l'autorisation d'un parent avant d'aller en ligne | **IT** Chiedi il permesso ai tuoi genitori prima di andare online | **ES** Pídeles permiso a tus papás antes de conectarte a Internet | **PT** Pede autorização aos pais antes de acederes online | **ZH** 上网前应先征得父母的同意 | **PL** Poproś rodziców o zgodę, zanim wejdiesz do Internetu | **CS** Než půjdeš na internet, požádej rodiče o svolení | **SK** Skôr než pôjdeš na internet, vypýtaj si povolenie od rodičov | **HU** Kérj szülői engedélyt, mielőtt online csatlakoznál! | **RO** Cere permisiunea părinților înainte de a te conecta online | **BG** Поискайте разрешение от родител, преди да влезете онлайн | **LV** Pirms došanās tiešsaistē palūdz atļauju vecākiem | **ET** Enne Interneti kasutamist küsi vanematelt luba | **LT** Prieš prisijungdami prie interneto, atsiklauskite tėvų



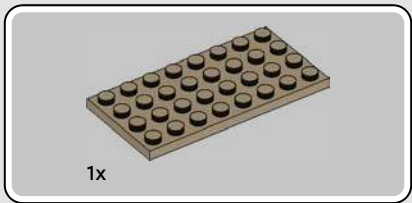
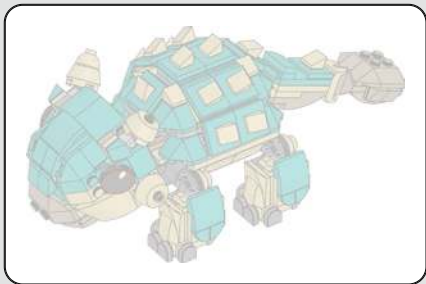

1

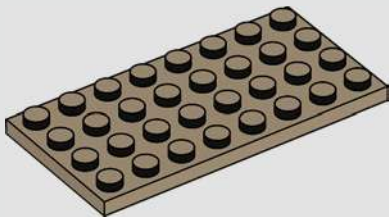



2x

2

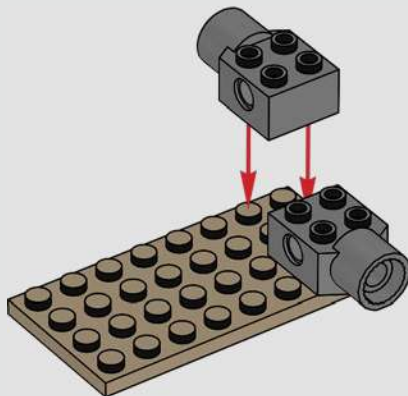

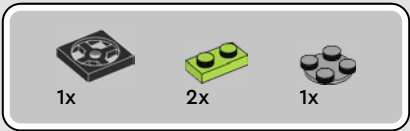

3

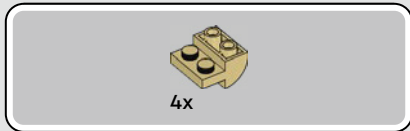
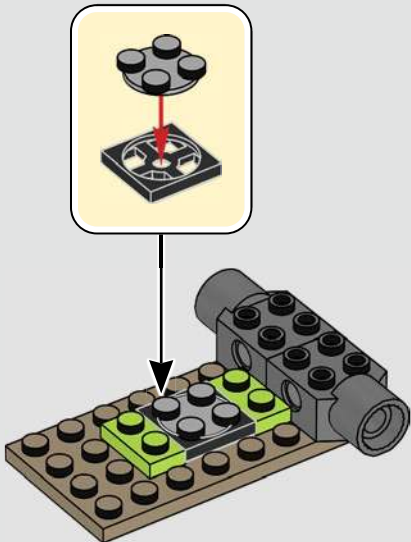

4

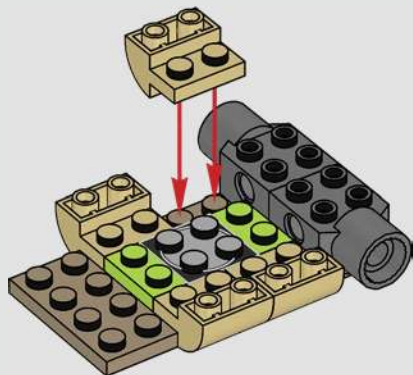

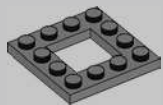

1x

5

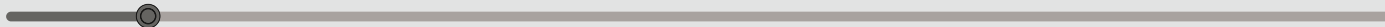
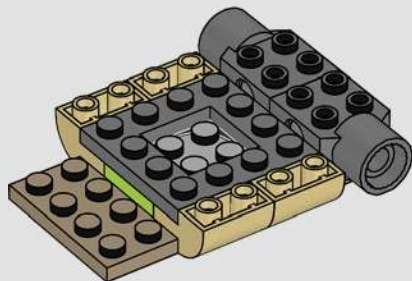



1x

6

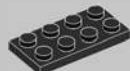
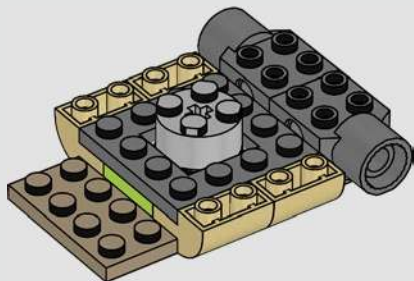

2x

7

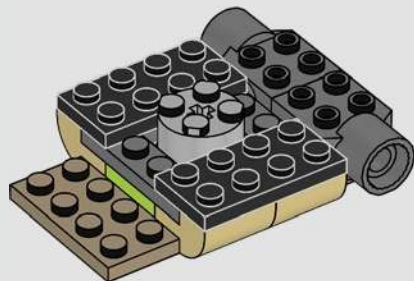

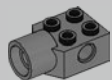

2x

8

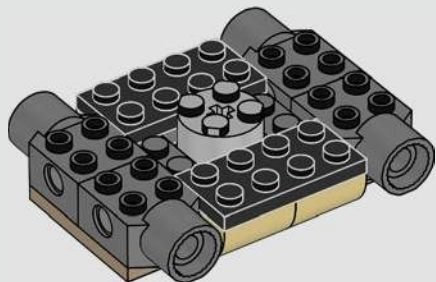

2x

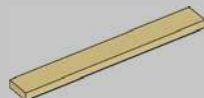

2x

9

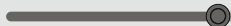
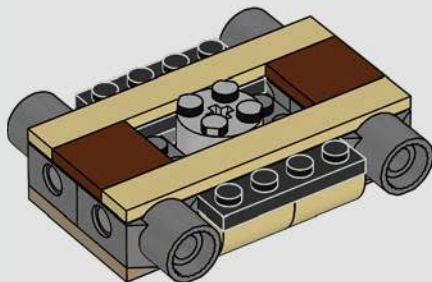

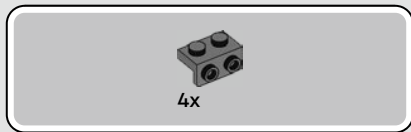

10

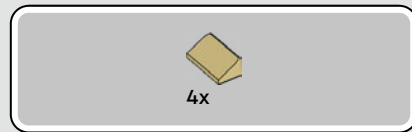
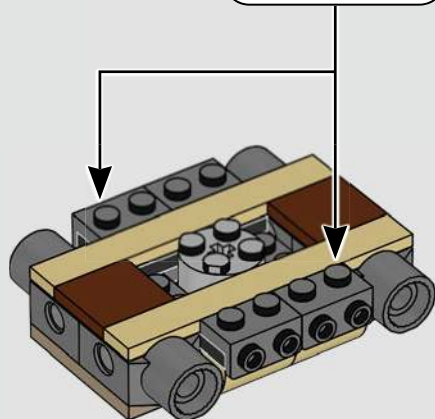

11

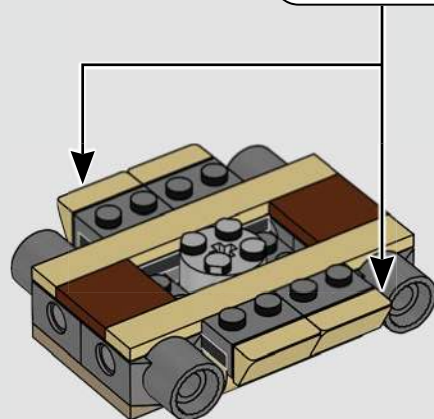
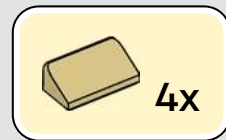



2x



2x



2x



4x



4x



4x

12

1

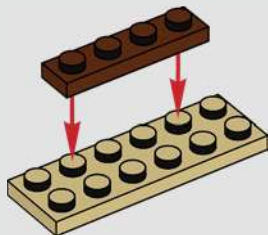

2

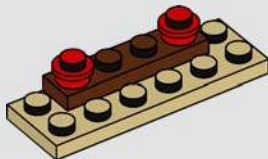

3

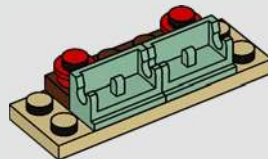

4

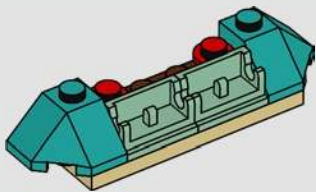

2x

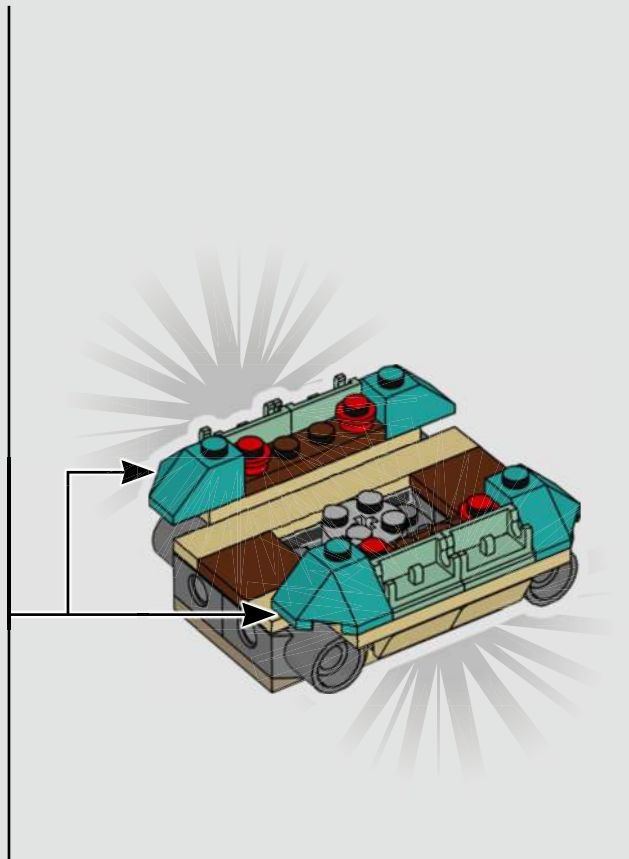

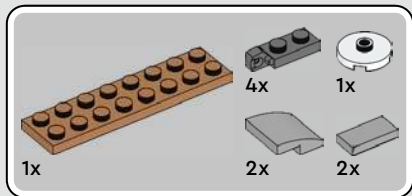

13

1

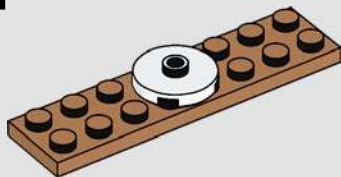

2

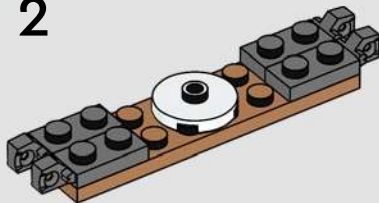

3

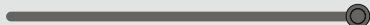
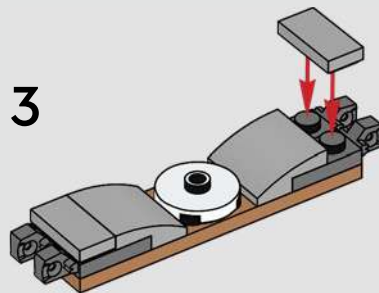

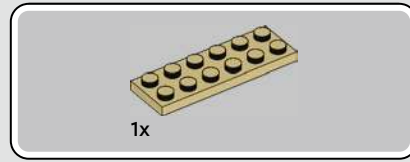

14

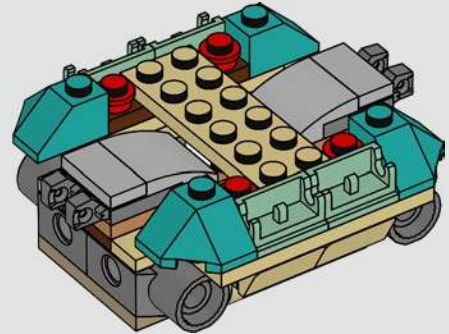
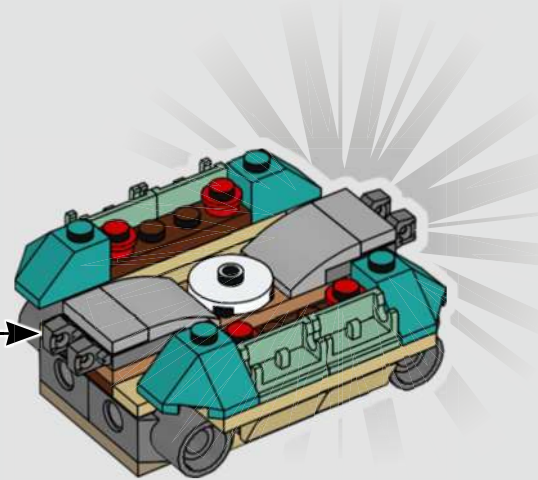



15

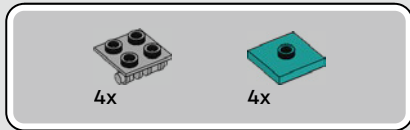
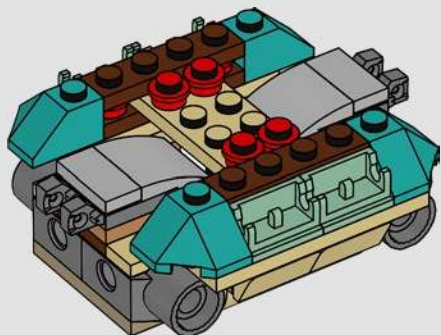

16

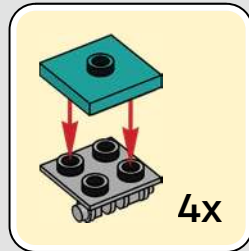
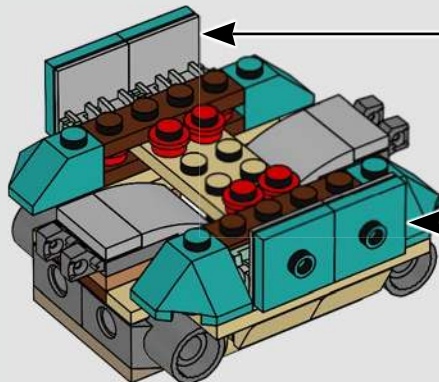

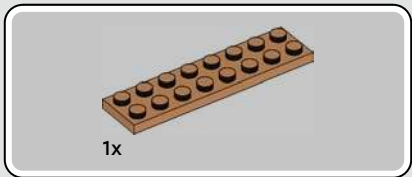

17

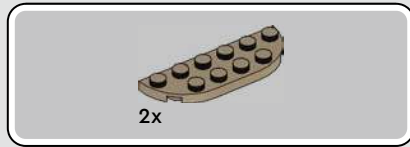
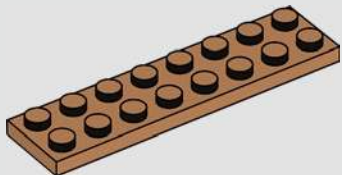

18

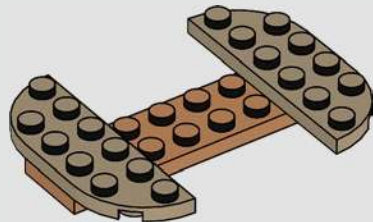



4x

19

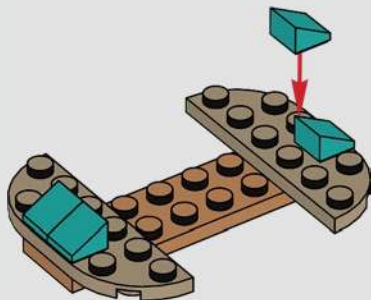

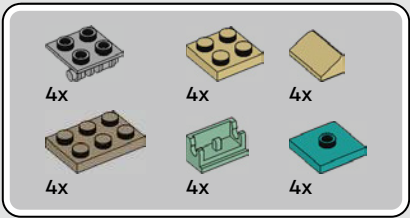

20

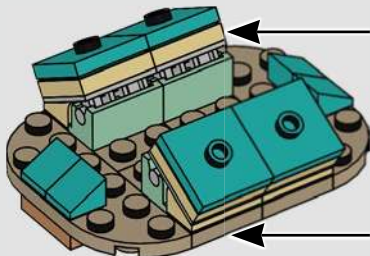
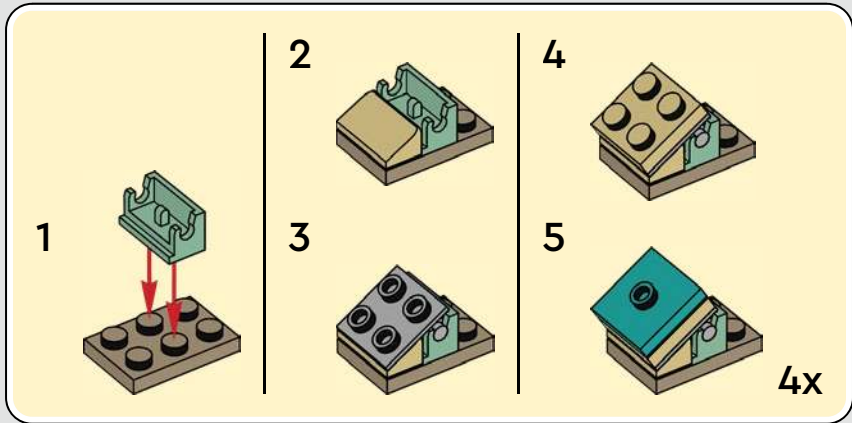

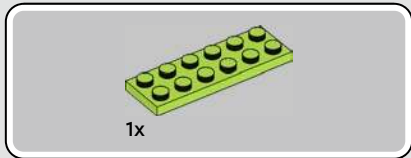

21

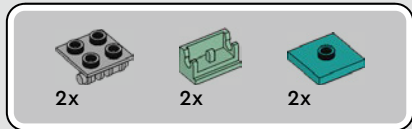
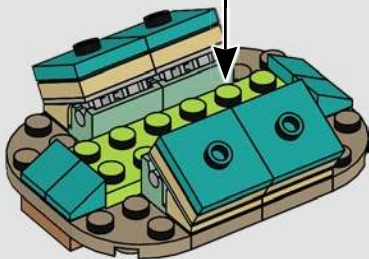
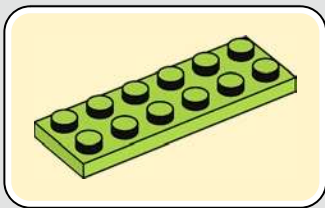

22

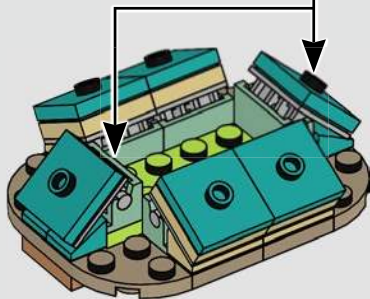
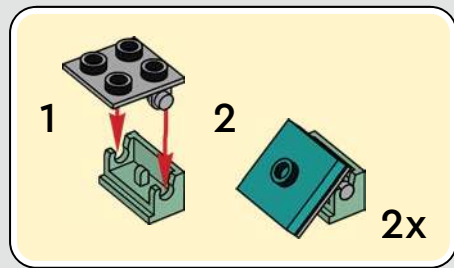



4x

23

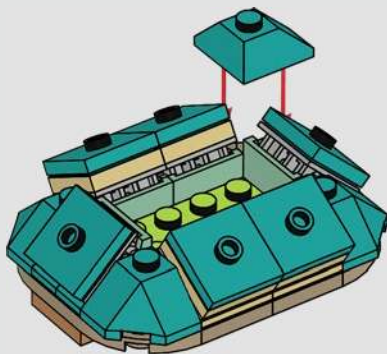

4x

24

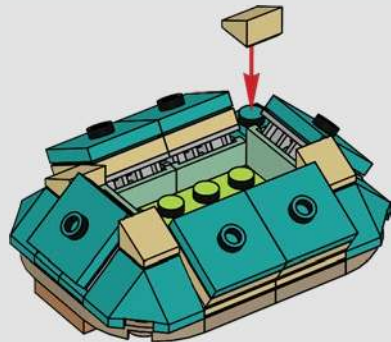

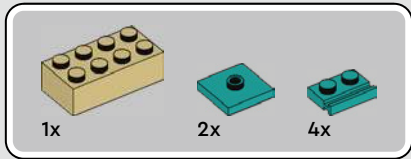

25

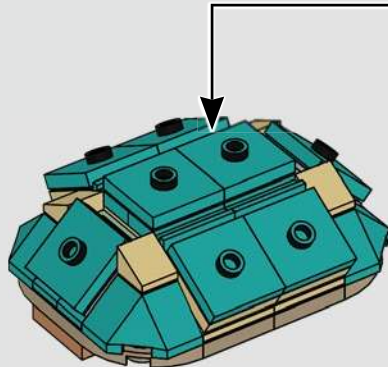
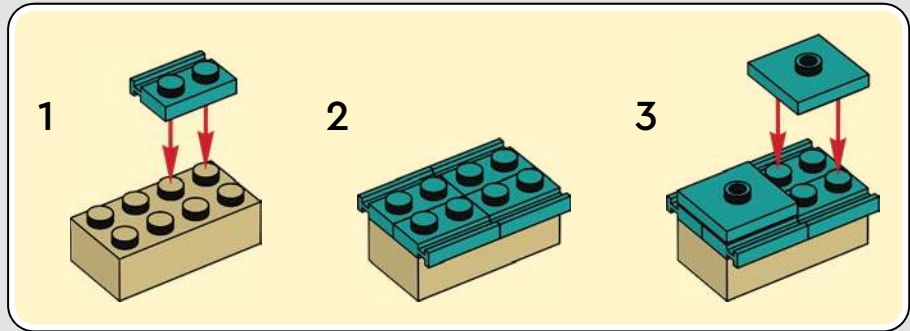

26

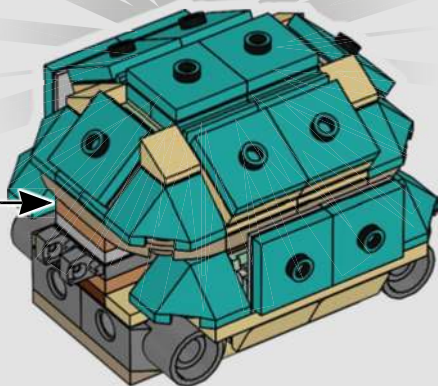

27

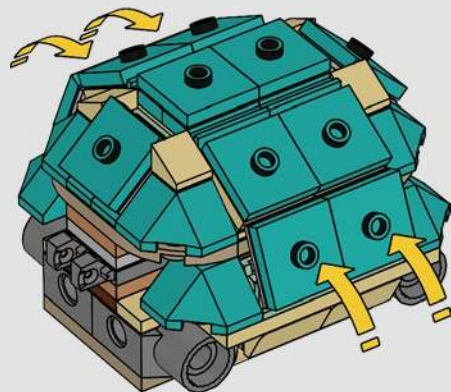



12x

28



12x

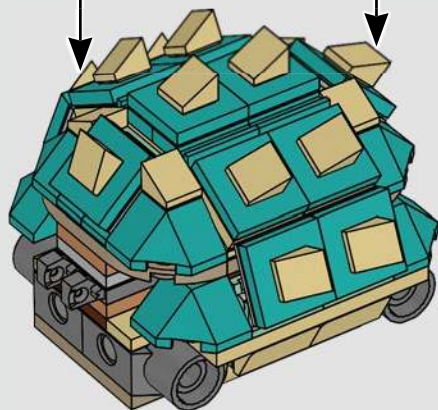



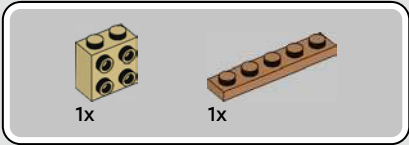

29

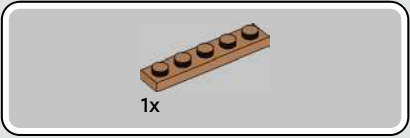
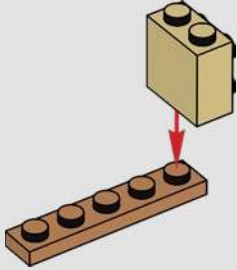

30

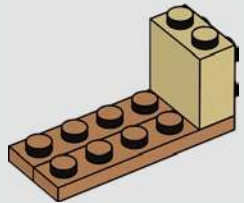



1x



2x

# 31

1



2

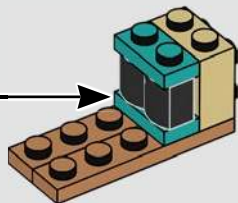

3x

# 32

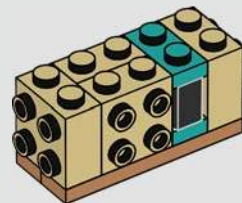



1x

33

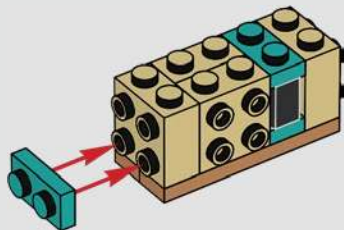

2x

34

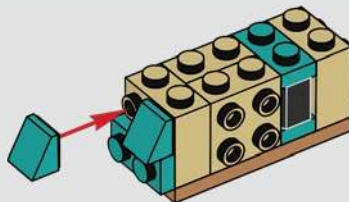



2x



2x

35

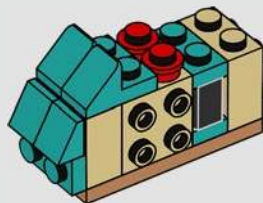



1x



1x

# 36

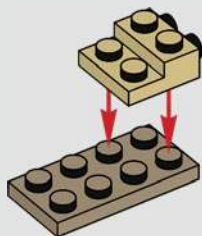

1x

# 37

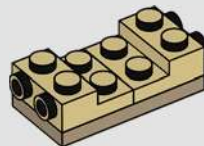



1x



1x

38

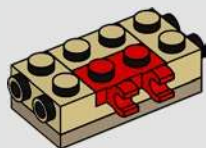

1x

39

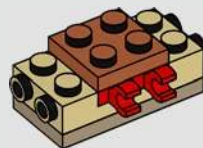



2x

40

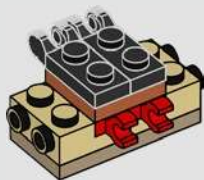

2x



2x

41

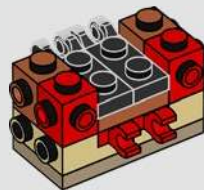

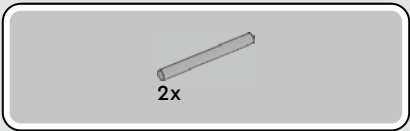

42

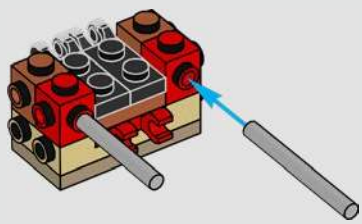

43

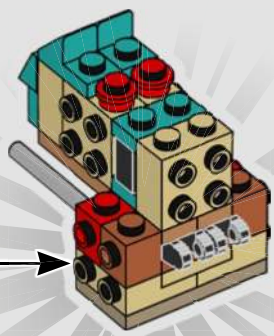
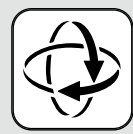



2x

44

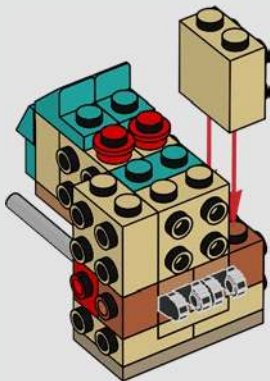

1x

45

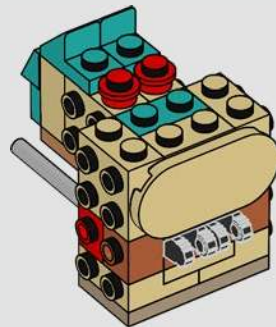



2x

46

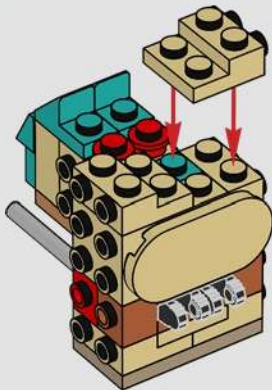

1x

47

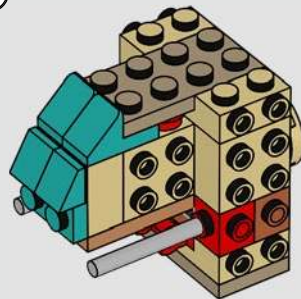

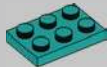

1x

48

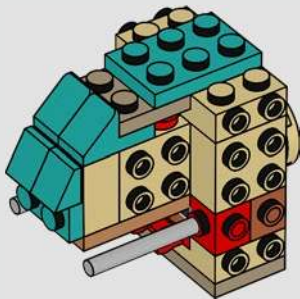

3x

49

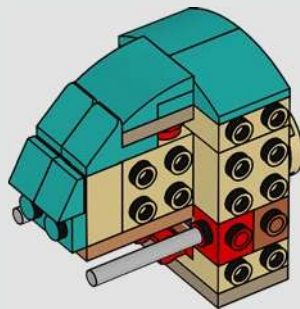

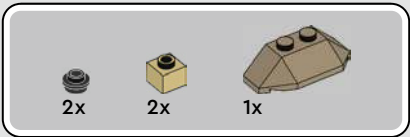

50

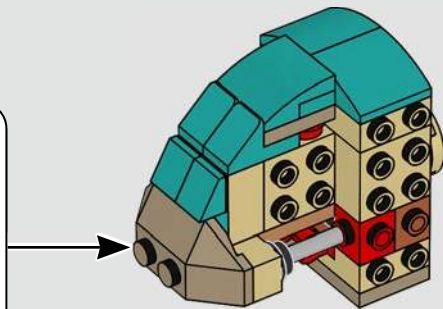
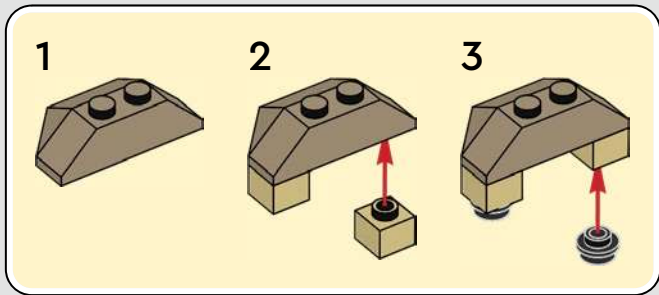

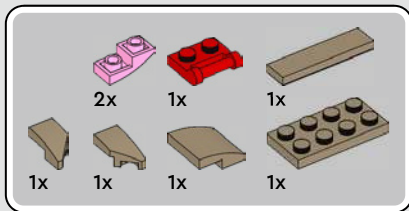

51

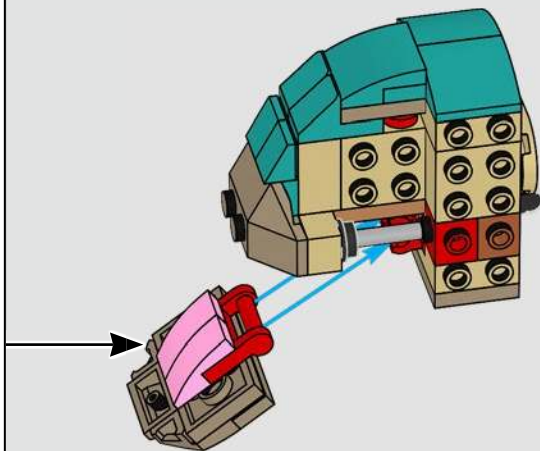
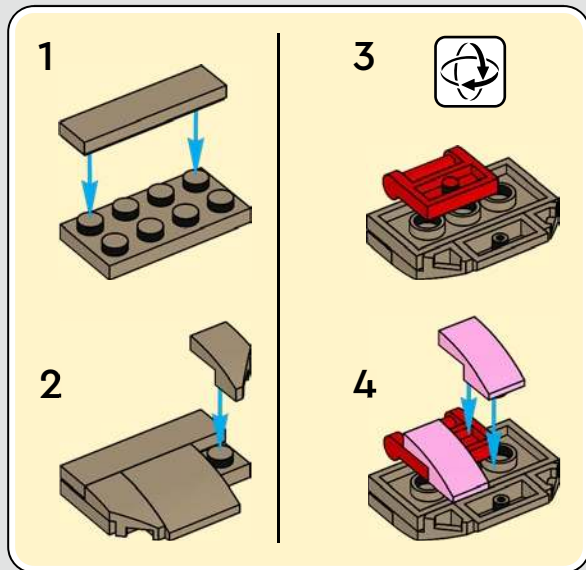



1x



1x

# 52

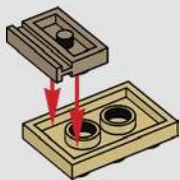

1x



1x

# 53

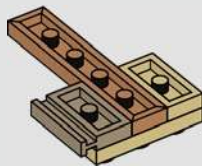



1x

54

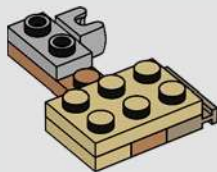

2x



1x

55

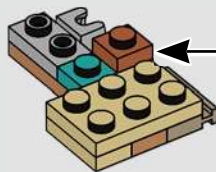

1



2





1x



1x

56

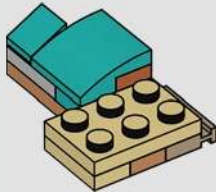

1x



1x

57

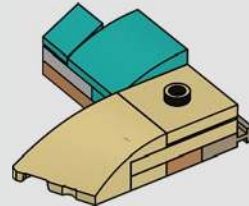



1x

58

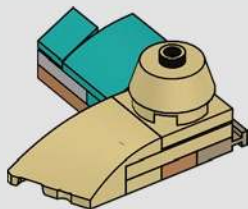

1x



1x

59

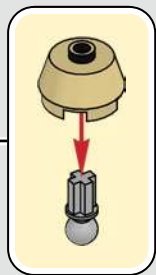

60

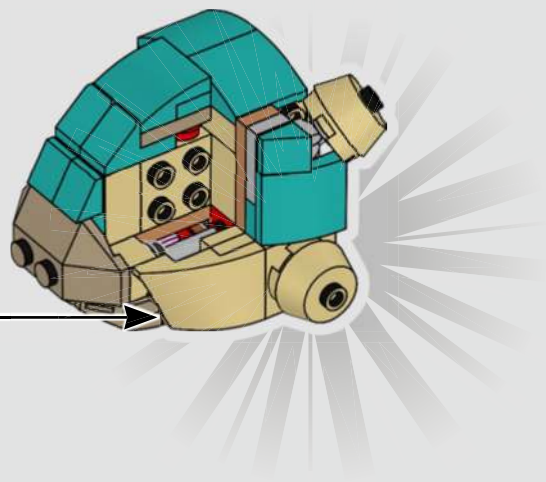

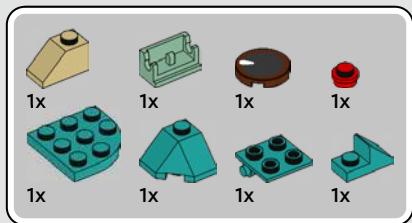

# 61

1



2



3



4

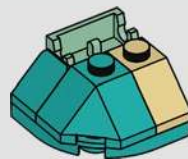

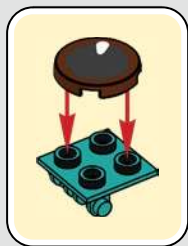

5

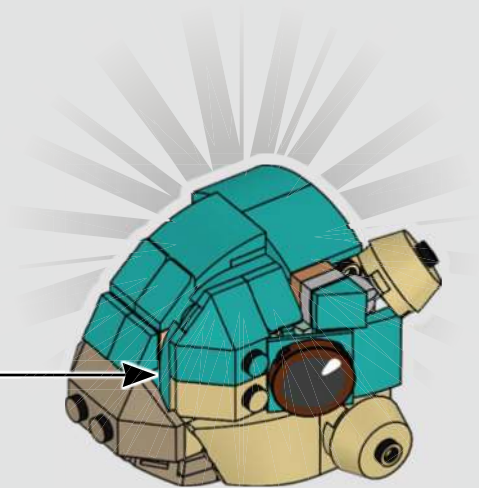
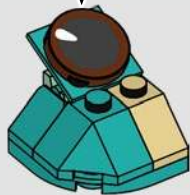

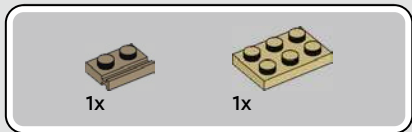

62

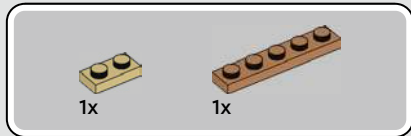
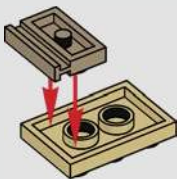

63

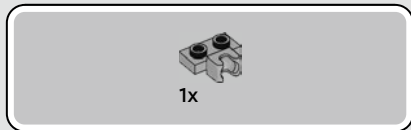
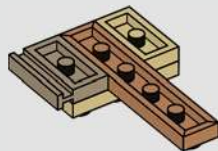

64

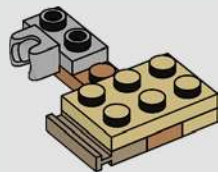
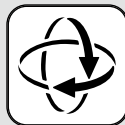



2x



1x

# 65

1



2

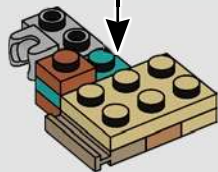

1x



1x

# 66

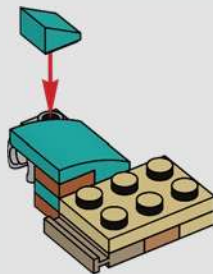



1x



1x

67

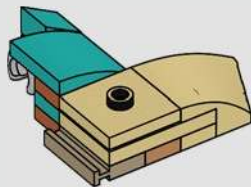

1x

68

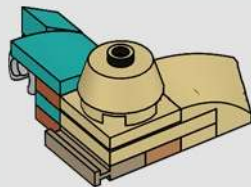



69

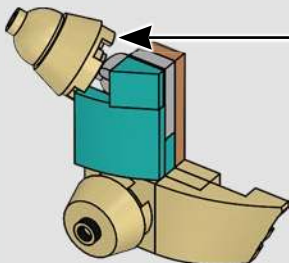
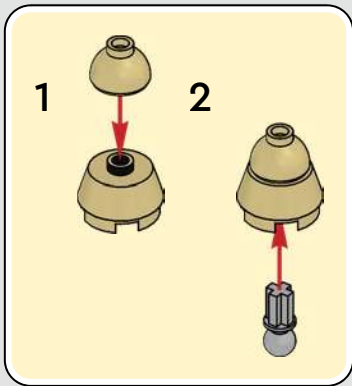

70

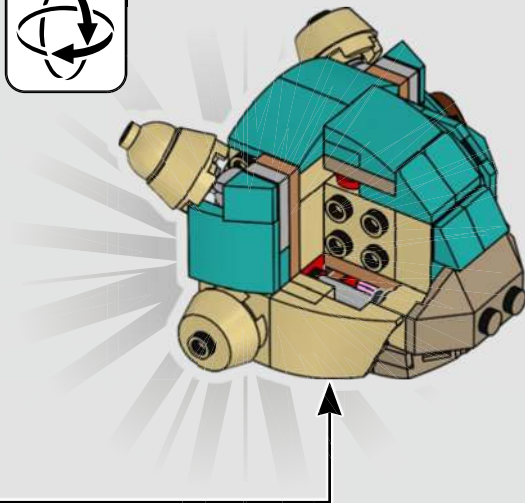

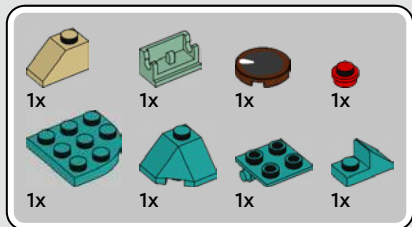

# 71

1



2



3



4

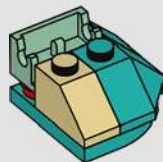

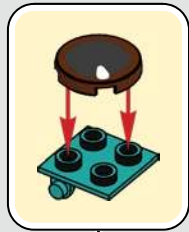

5

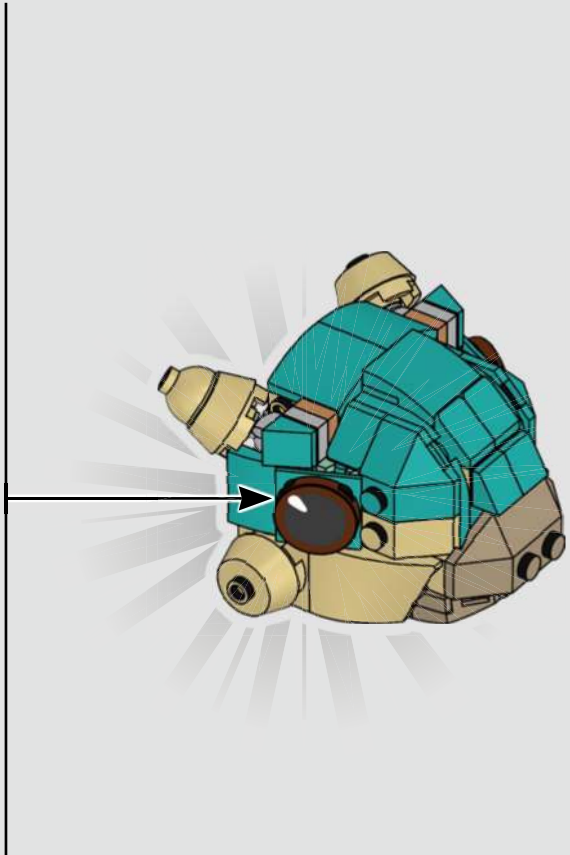
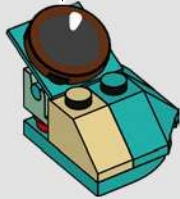

72

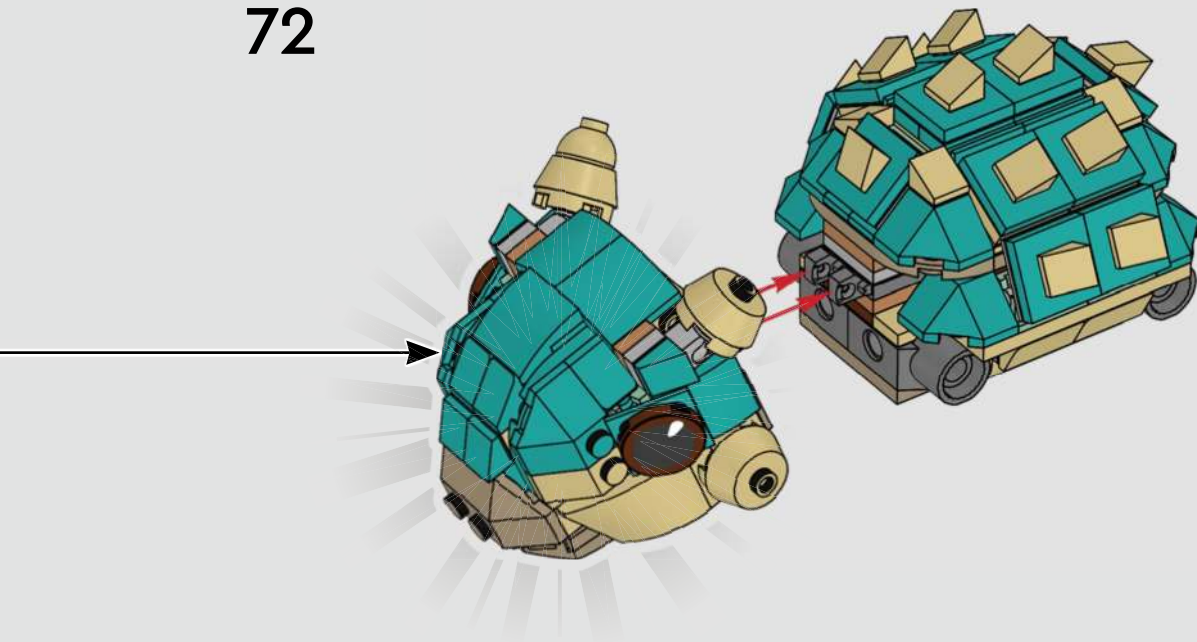





2x

73

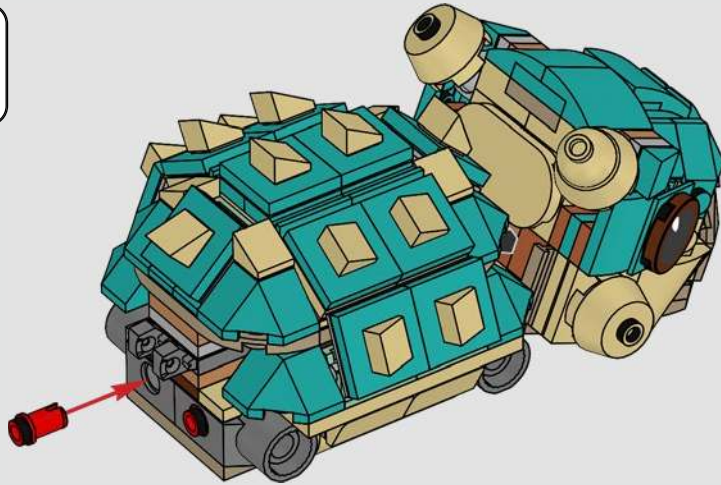



1x

74

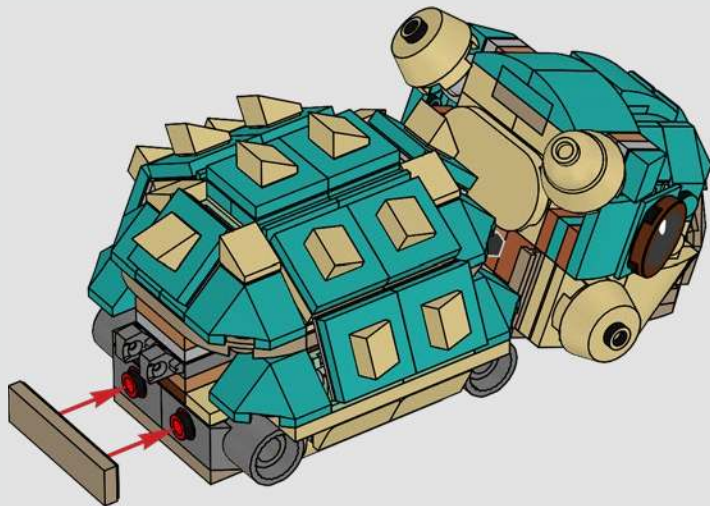



1x

75



2x

76

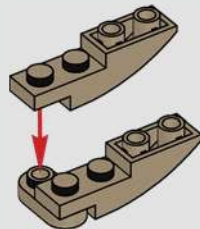



2x

77

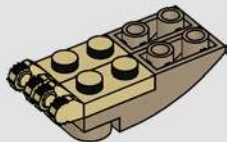

1x

78

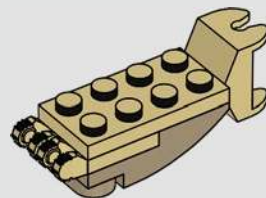

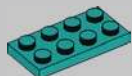

1x

79

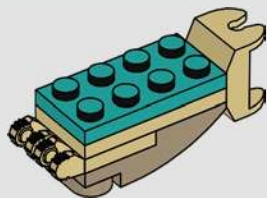

1x



1x

80

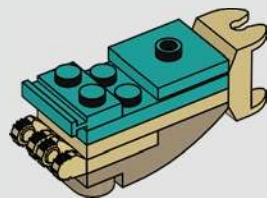



1x



1x

# 81

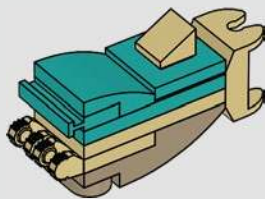

# 82

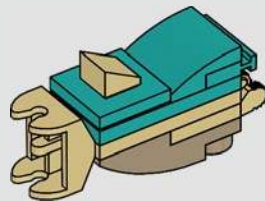

83

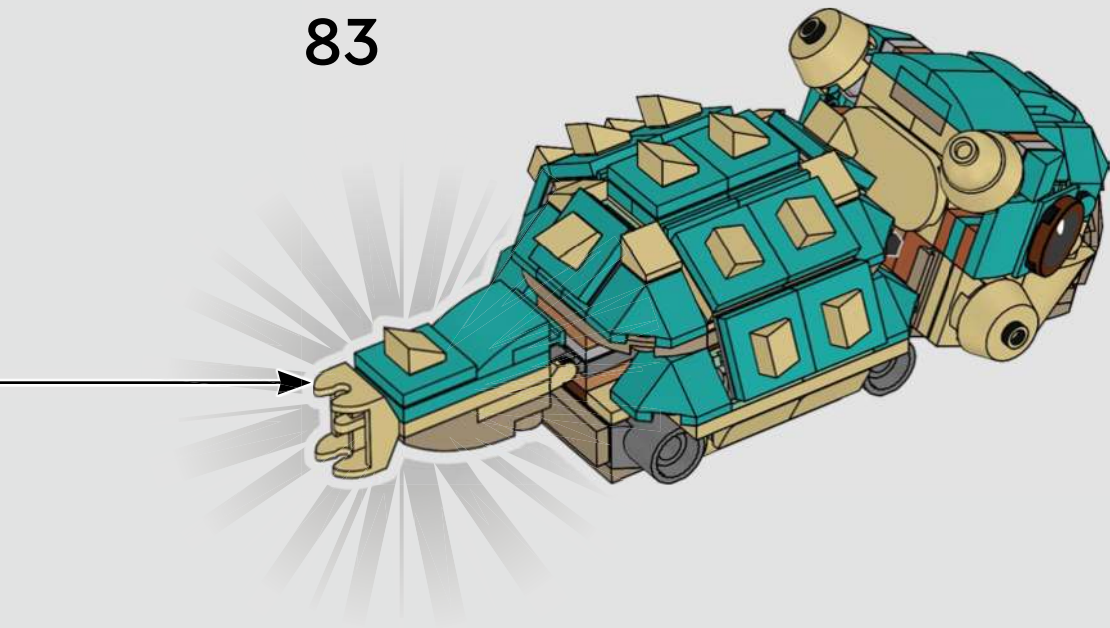

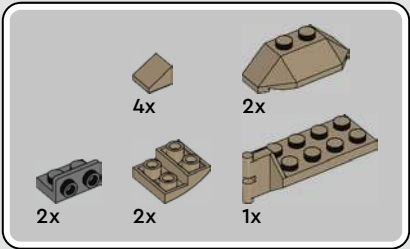

# 84

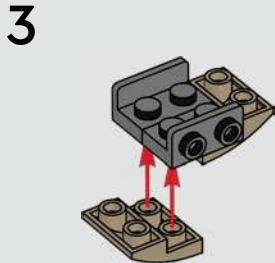
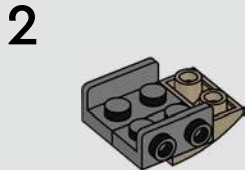
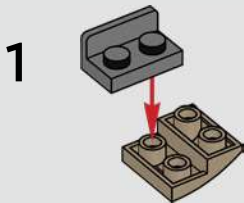

4

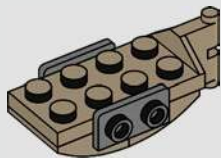

5

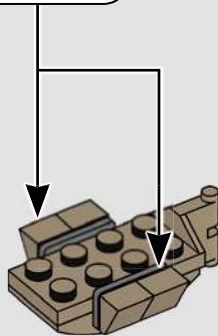
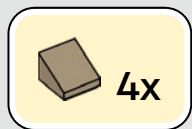

6

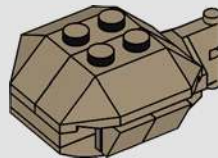

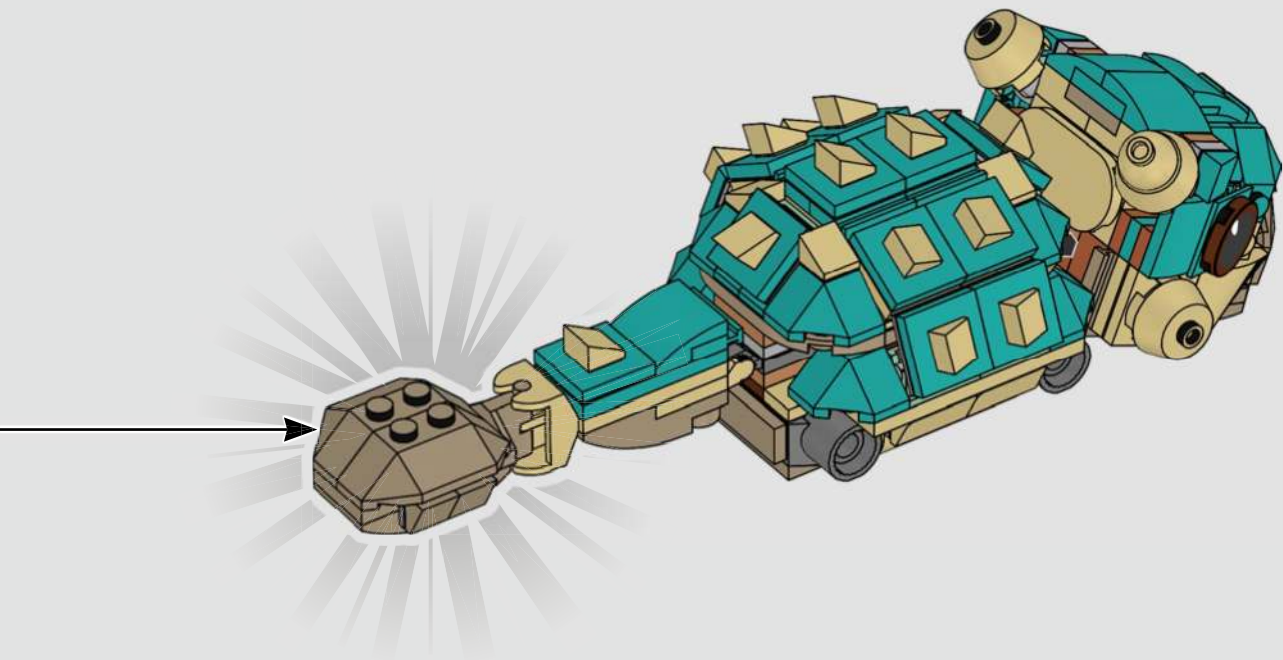



2x



1x



1x

85

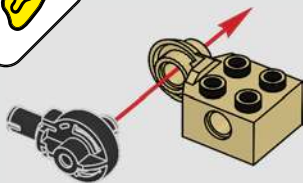

2x

86



2x

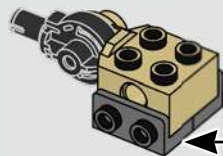



2x

87

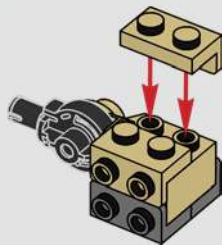

1x

88

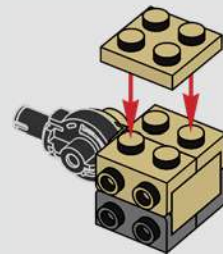



89

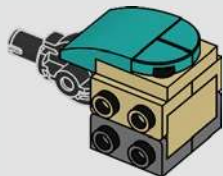

90

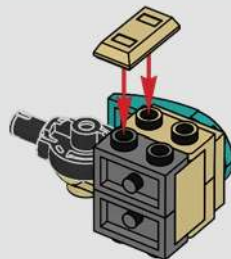



1x



2x

# 91

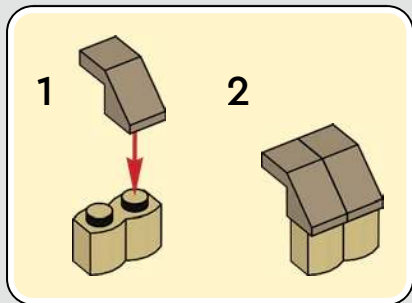

1x

# 92

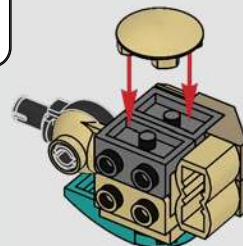

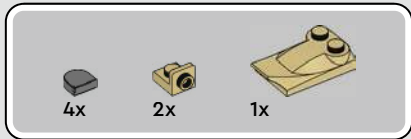

93

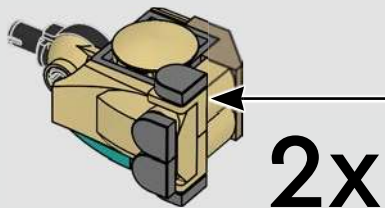
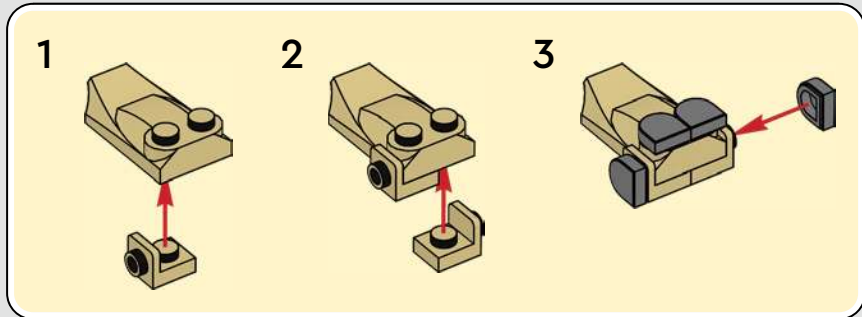

94

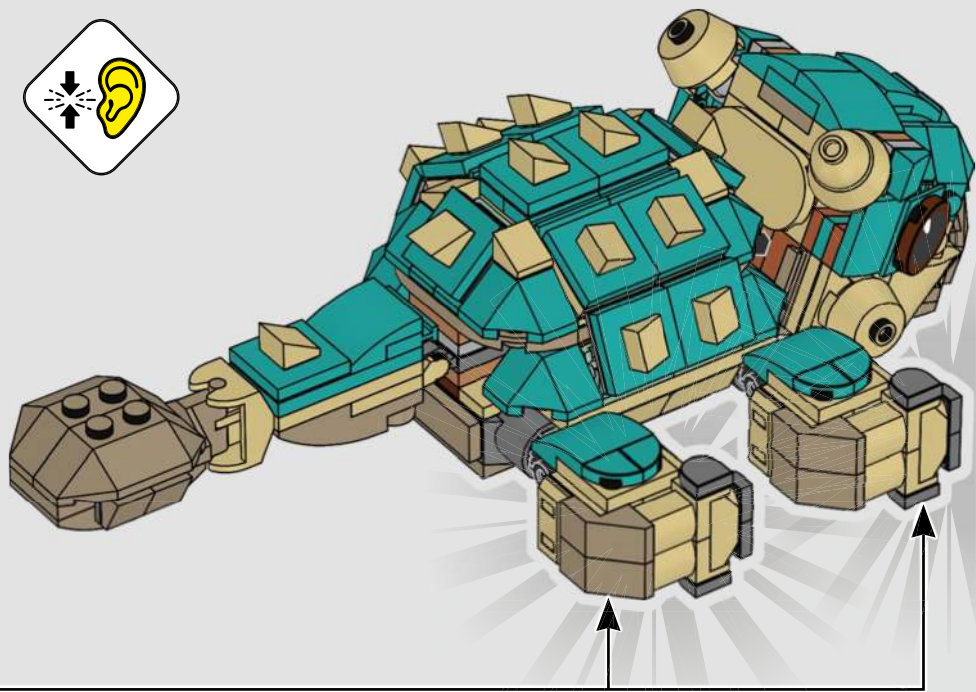



2x



1x



1x

95

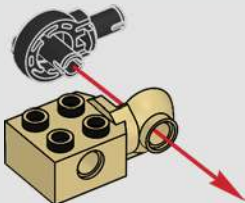

2x

96



2x

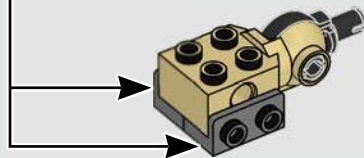



2x

97

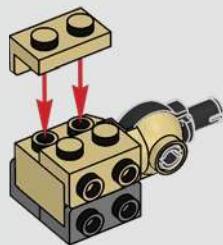

1x

98

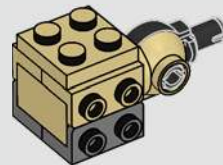



99

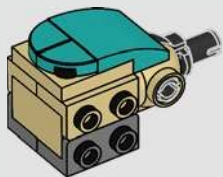

100

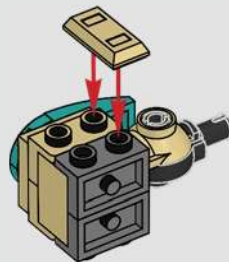



1x



2x

# 101

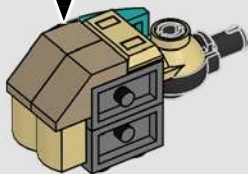
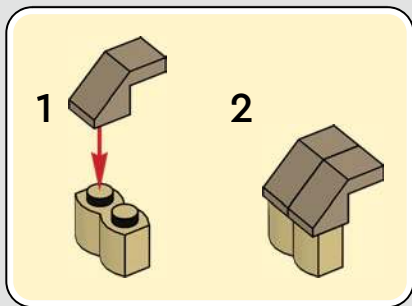

1x

# 102

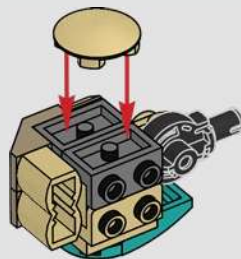

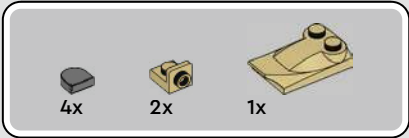

103

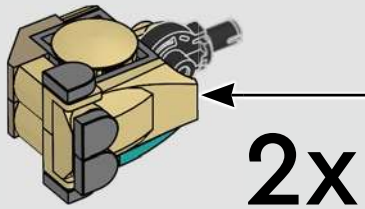
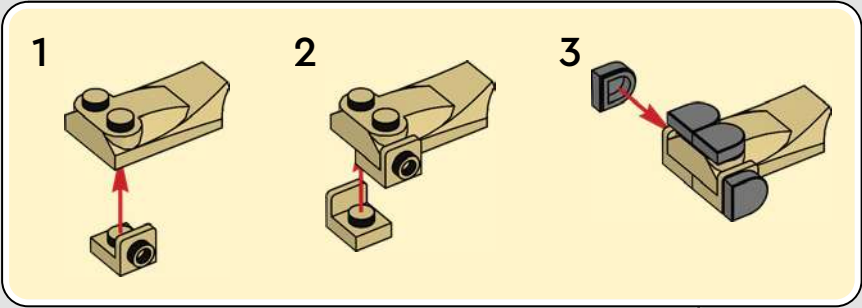

104

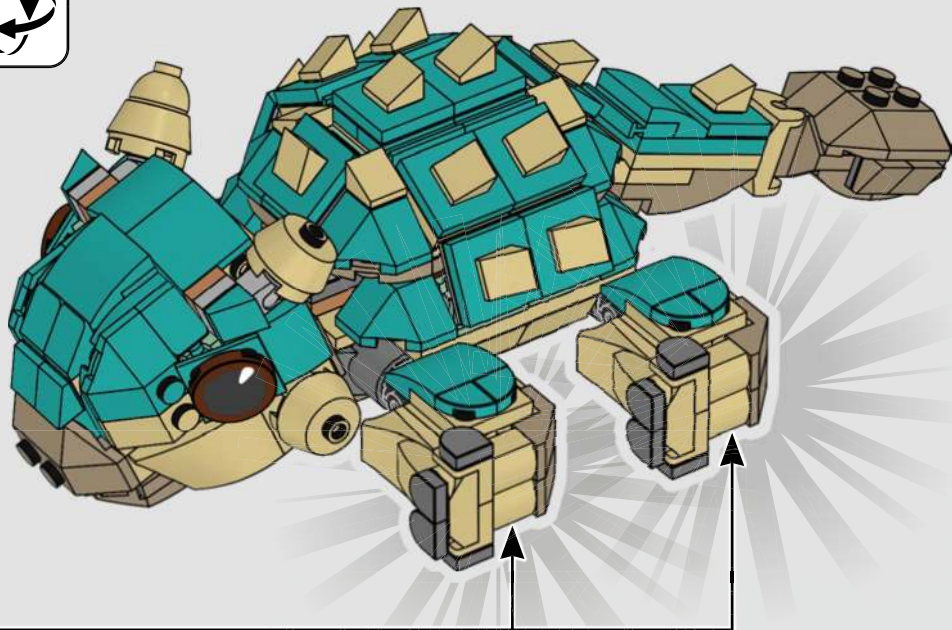

105

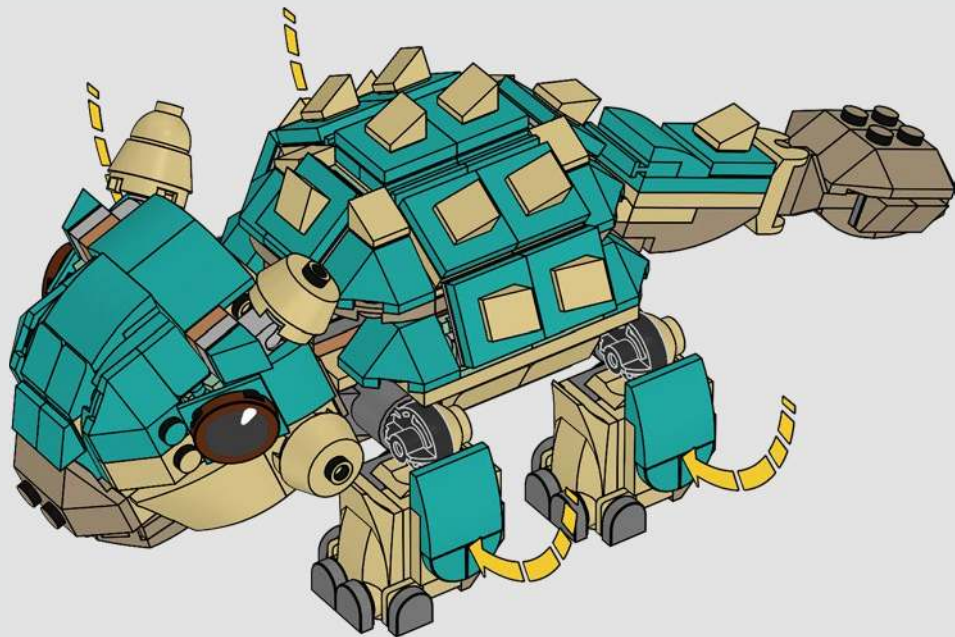

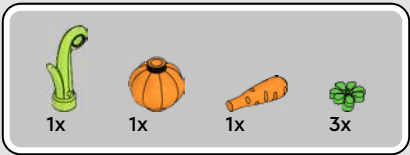

106

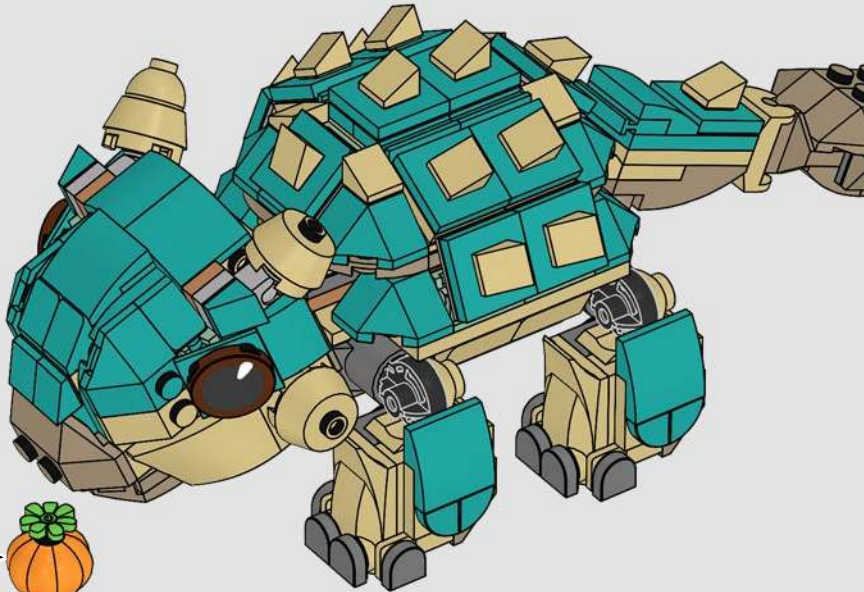
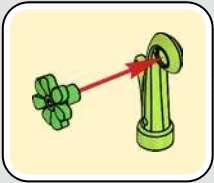
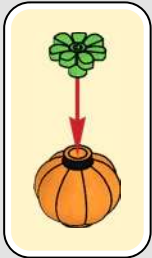
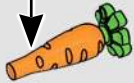
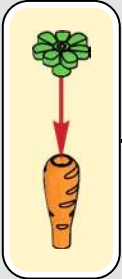

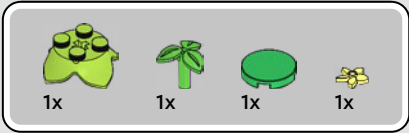

107

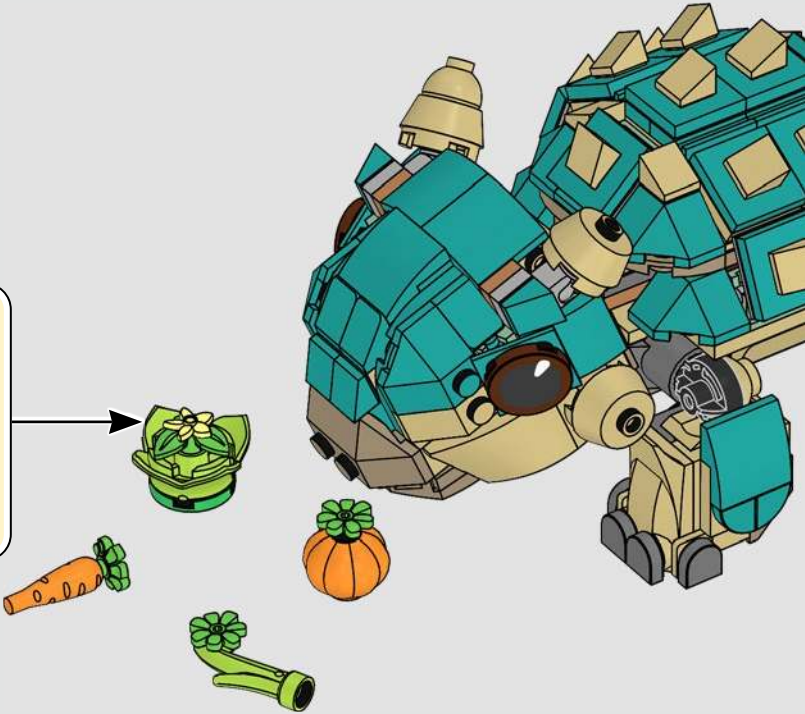
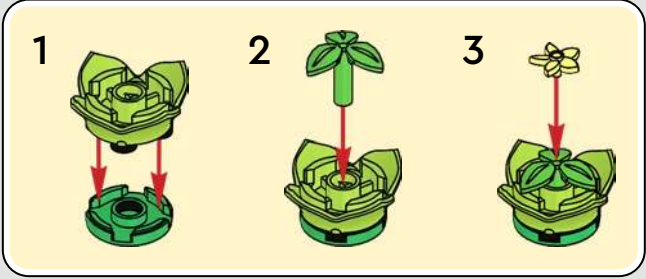





76964



76960



76966



76965





Rebuild  
the  
world™





1x  
6093053



8x  
6365720



4x  
4218749



1x  
4114319



6x  
6214334



4x  
6375375



4x  
6215023



8x  
4624086



2x  
4121972

82



1x  
6404629



4x  
6485743



1x  
6404628



4x  
6271228



3x  
4113917



2x  
4565387



8x  
4114084



2x  
4118790



3x  
4113993



1x  
6487883



8x  
6249809



4x  
6469454



2x  
6485745



4x  
4278422



1x  
6294716



4x  
6485751



1x  
6485750



2x  
4544139



17x  
4516055



2x  
6458392



2x  
6473603



1x  
6360036



1x  
4226876



12x  
614121



2x  
6378120



1x  
4644456



4x  
4213374



2x  
302026



2x  
6168646



2x  
6267045



1x  
368026



1x  
6238881



3x  
6488792



1x  
6235080



1x  
6267125



1x  
6424015



8x  
6240467



8x  
6278172



4x  
6487879



5x  
6213777



5x  
6441762



10x  
6307898



10x  
6223665



13x  
6290269



2x  
6488169



1x  
6249417



1x  
6338181



2x  
6251838



YOU COULD  
**WIN**

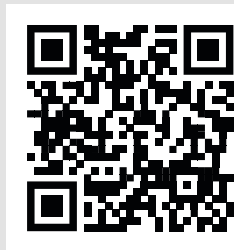

Scan this QR code or go to  
**LEGO.COM/PRODUCTFEEDBACK** and give  
us your short feedback about this LEGO® set  
for a chance to win a cool LEGO prize.

Terms and Conditions apply\*

**EN: YOU COULD WIN.** Terms and Conditions apply\* **DE: Du könntest GEWINNEN.** Es gelten die Teilnahmebedingungen\* **FR: Tu pourrais GAGNER.** Des conditions s'appliquent\* **IT: Potresti VINCERE tu.** Termini e condizioni sono applicabili\* **ES: Puedes GANAR.** Aplican términos y condiciones\* **PT: Poderá GANHAR.** Aplicam-se termos e condições\* **ZH: 轻松获奖. 条款和条件适用\*** **PL: Szansa na WYGRANĄ.** Obowiązują warunki korzystania\* **CS: Máte šanci VYHRÁT.** Platí všeobecné smluvní podmínky\* **SK: Máte šancu VYHRAŤ.** Platia všeobecné zmluvné podmienky\* **HU: TE IS NYERHETSZ.** Felhasználási feltételek érvényesek\* **RO: Ai putea CÂȘTIGA.** Se aplică termeni și condiții\* **BG: Можете да СПЕЧЕЛИТЕ.** Има определени правила и условия\* **LV: Tu vari LAIMĒT.** Ir spēkā noteikumi un nosacījumi.\* **ET: Sul on võimalus VÕITA.** Kehtivad tingimused\* **LT: Jūs galite LAIMĖTI.** Taikomos sąlygos\*

\*[LEGO.com/productfeedback-terms](https://www.lego.com/productfeedback-terms)

LEGO and the LEGO logo and are trademarks of the LEGO Group. ©2024 The LEGO Group.

© Universal City Studios LLC and Amblin Entertainment, Inc. Series © DreamWorks Animation LLC. All Rights Reserved.

6519662