



DREAMZZZ

71485



4

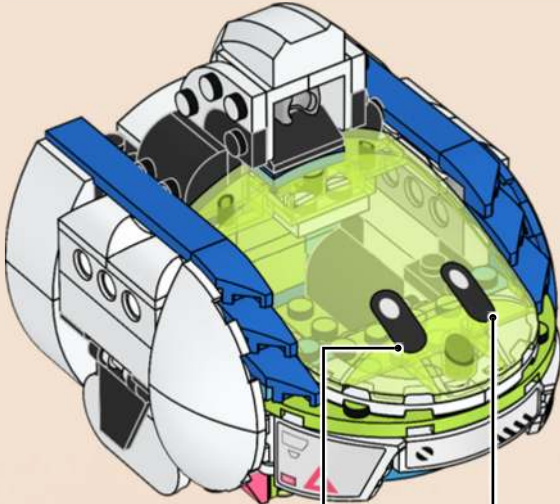
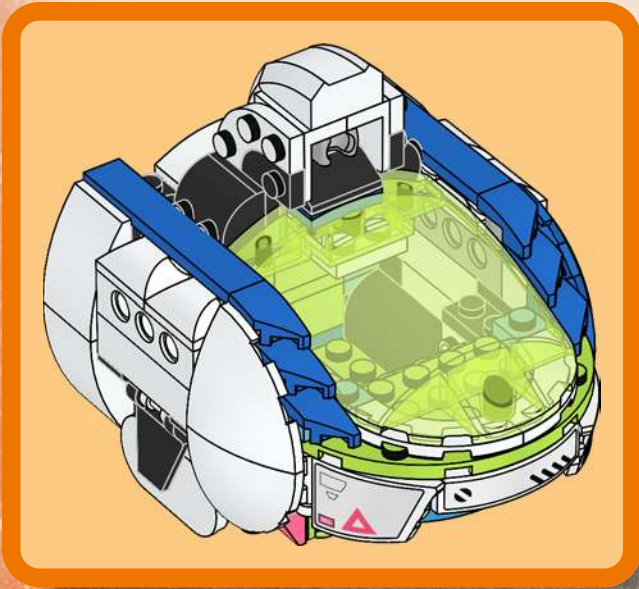

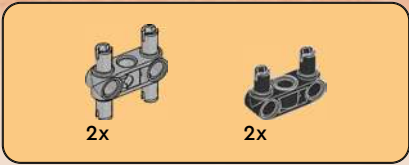

1

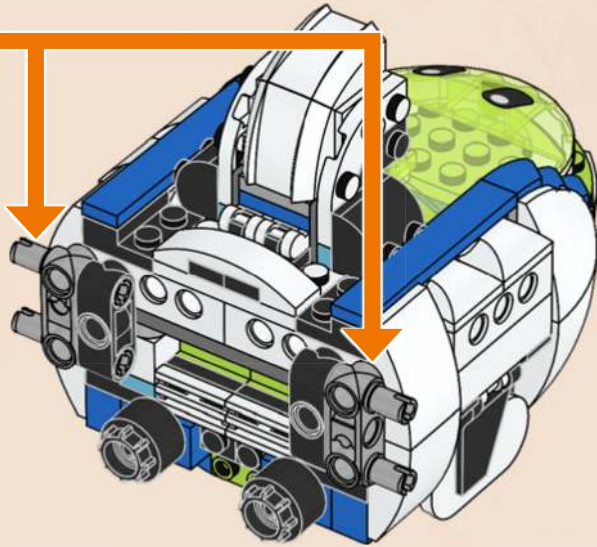
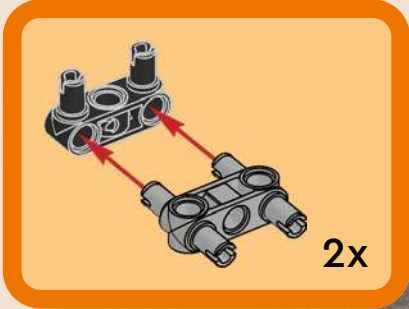



2x

2

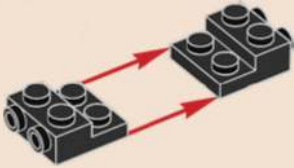

1x

3



3x

4

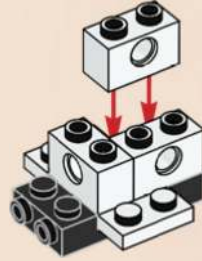

1x

5

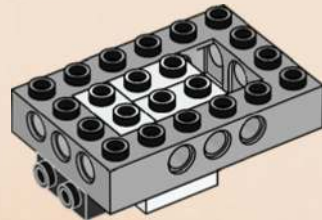



6

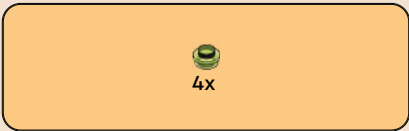
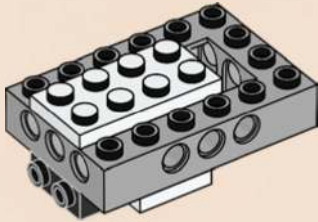

7

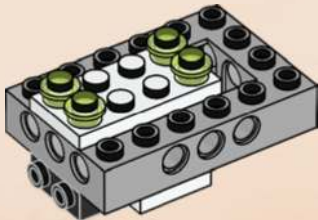

8

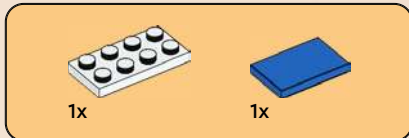
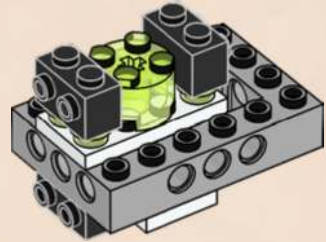

9

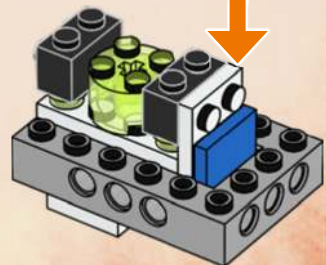

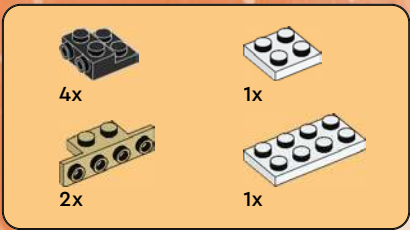

10

1



2



3



4

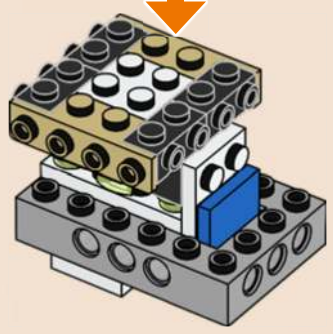



11

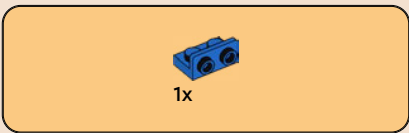
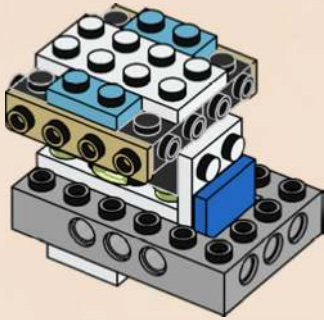

12

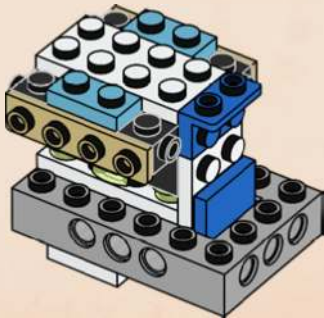

13

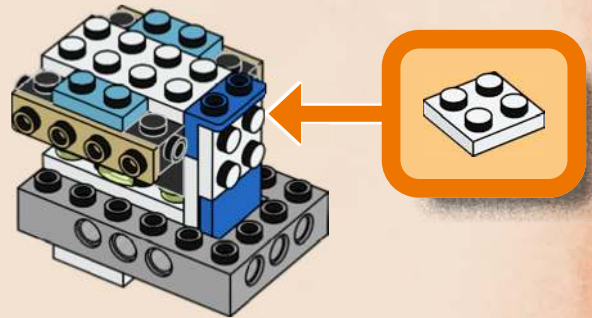

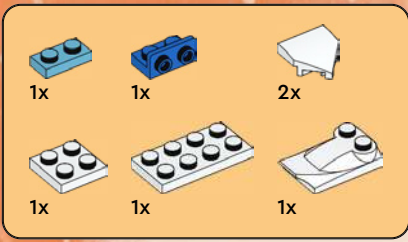

14

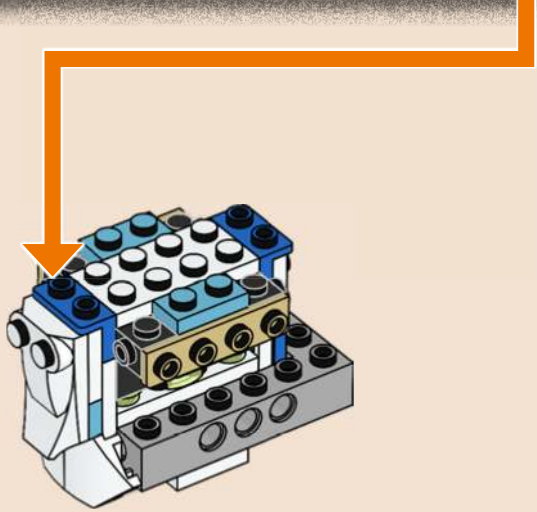
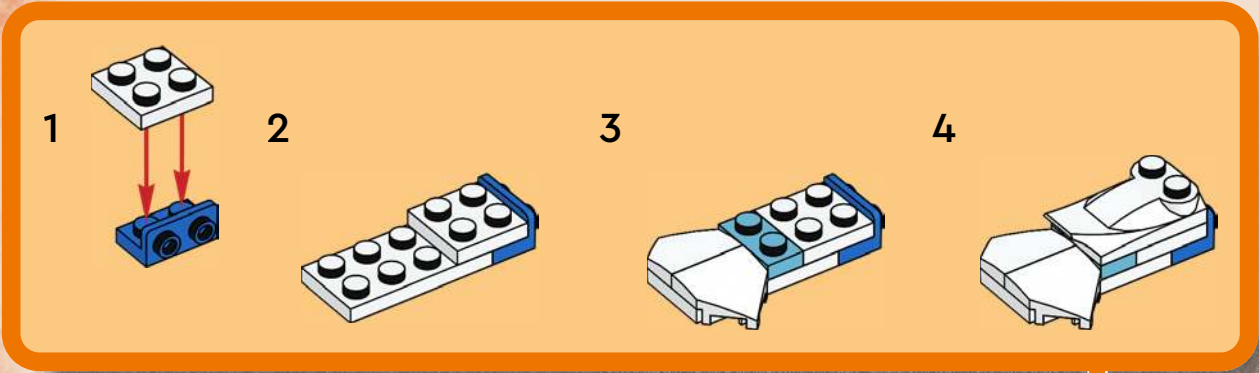

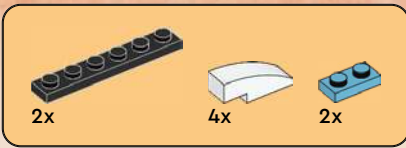

15

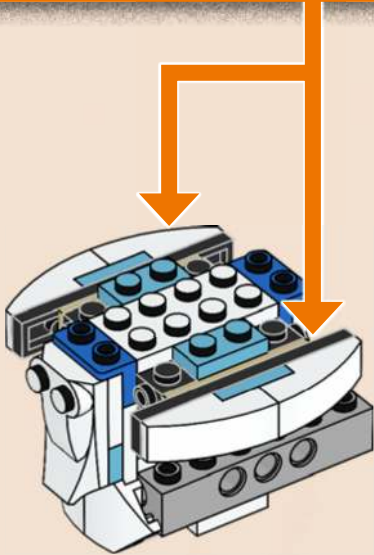
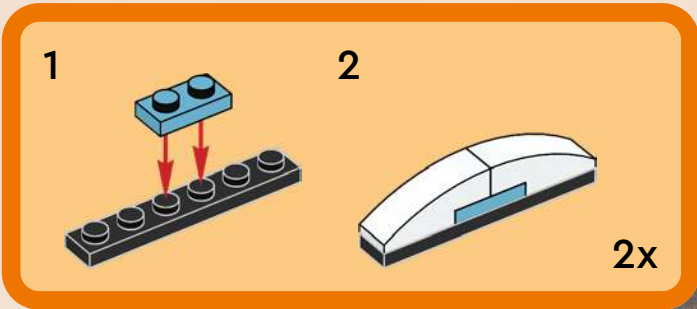

16

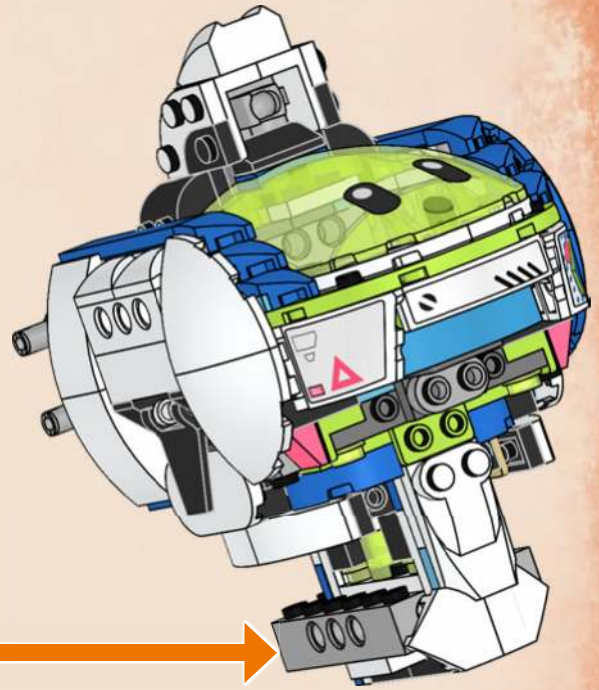
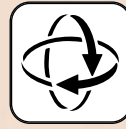



1x



1x

17

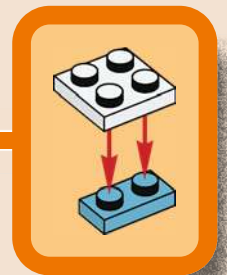
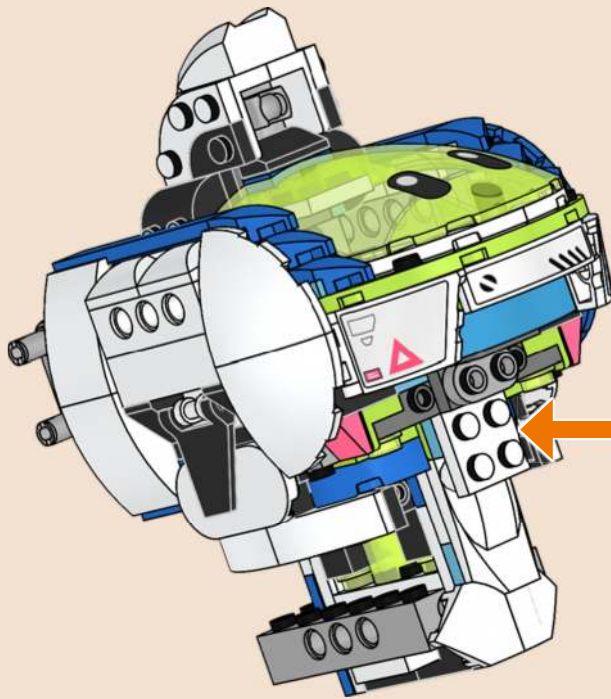

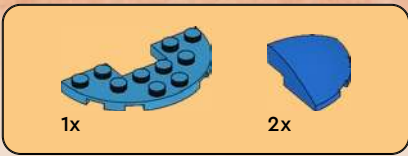

18

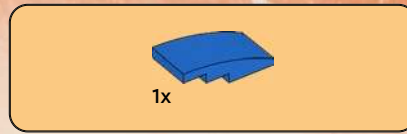
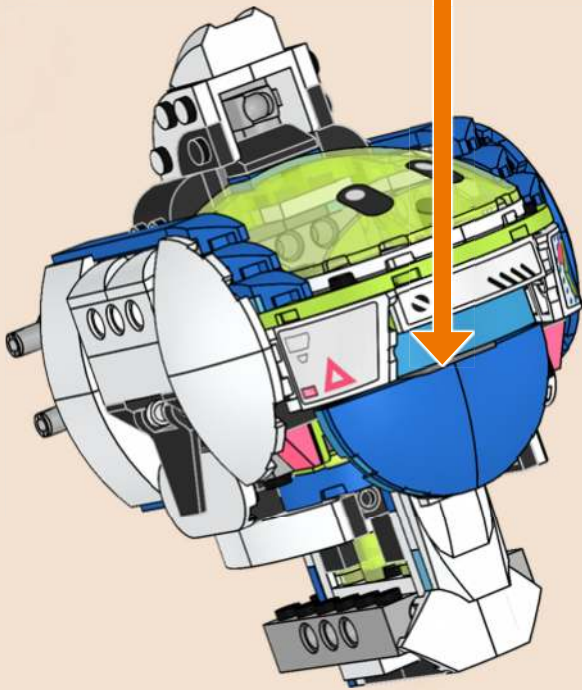
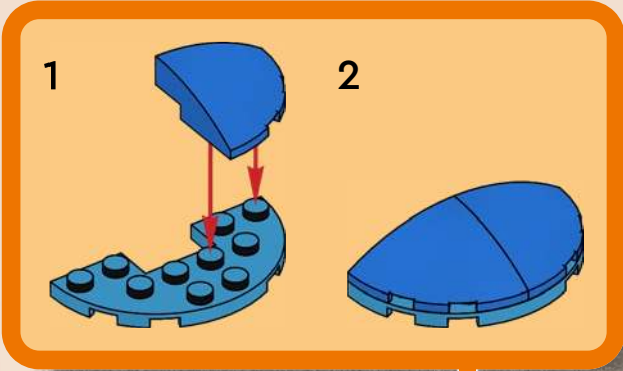

19

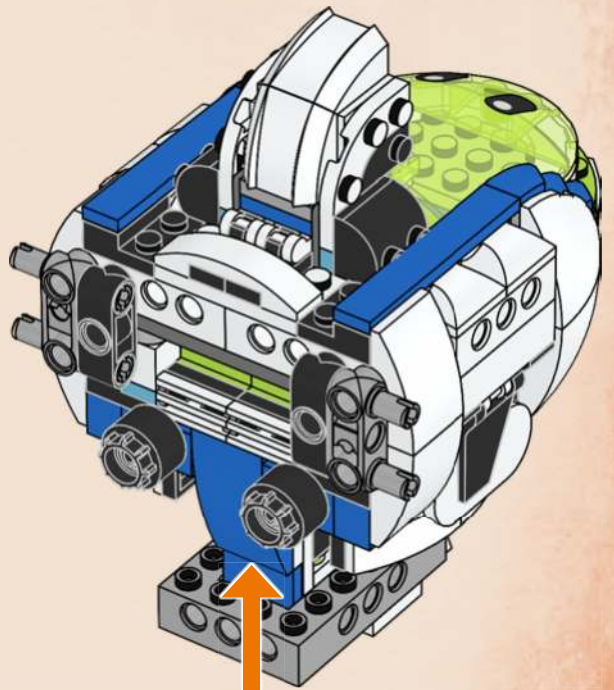

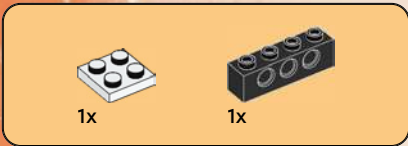

20

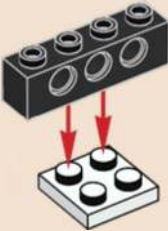

21

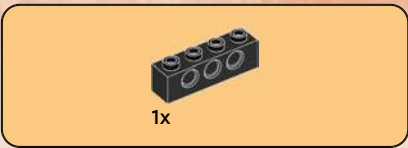

22

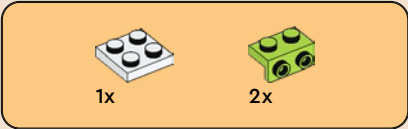

23





1x



1x

24

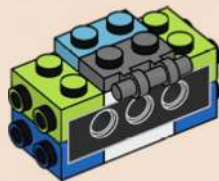

1x

26

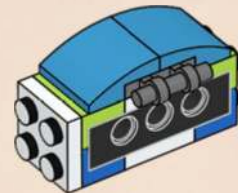

2x

25

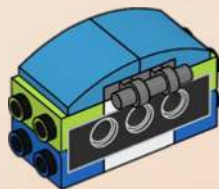

1x

27

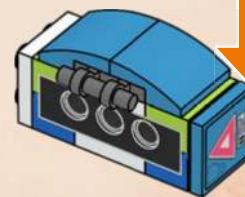
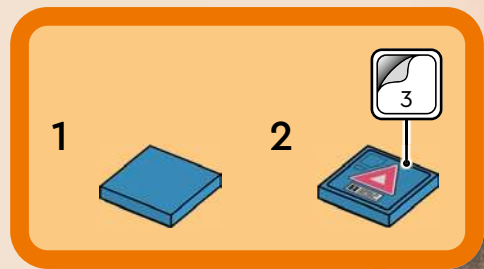



1x

28



1x



2x



1x



1x

29

1

2

3

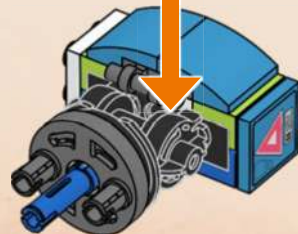

30

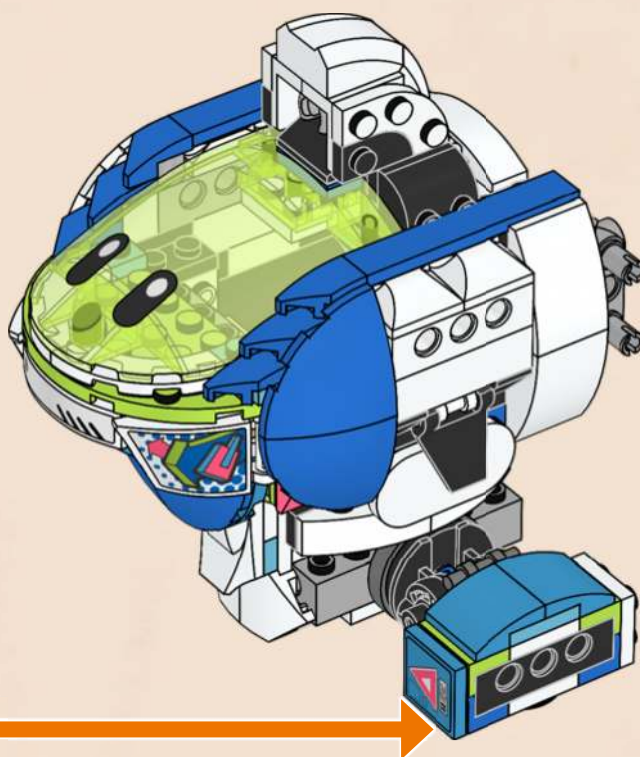



1x



1x

31

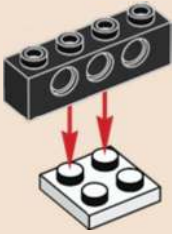

2x

32



1x

33



1x



2x

34

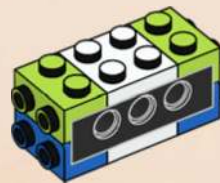



35

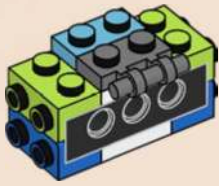

36

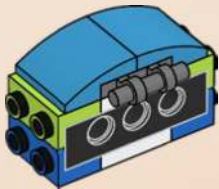

37

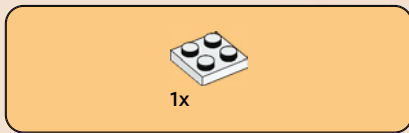
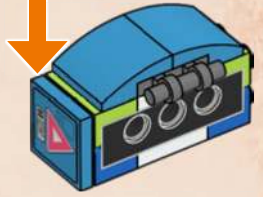
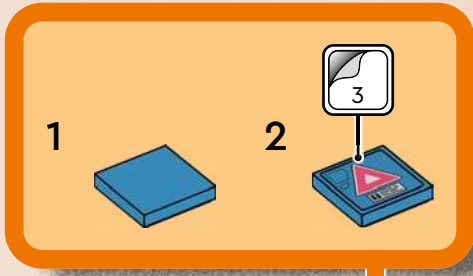

38

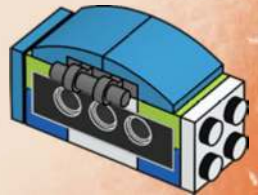

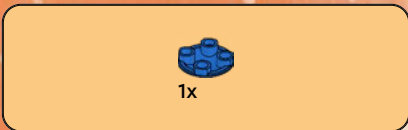

39

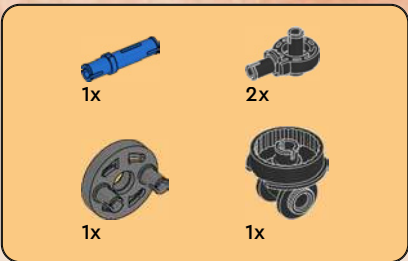
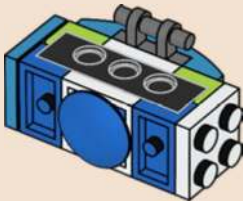

40

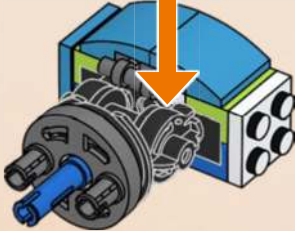
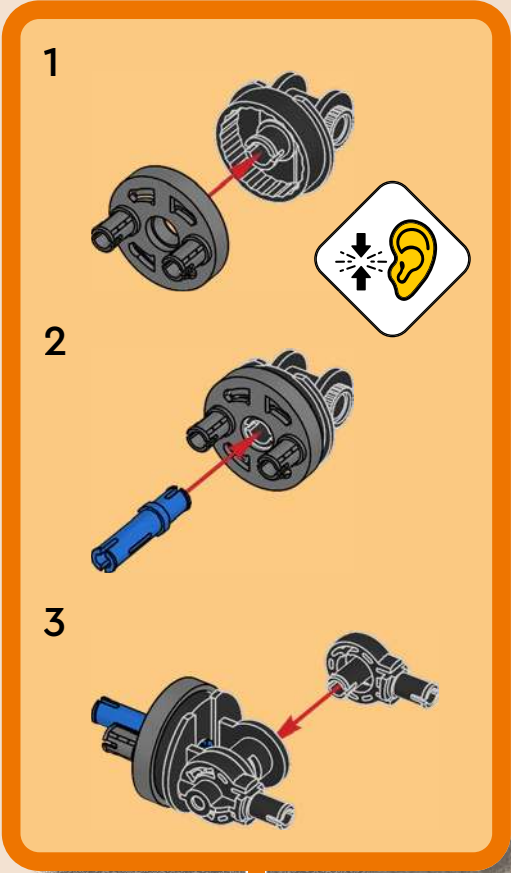

41

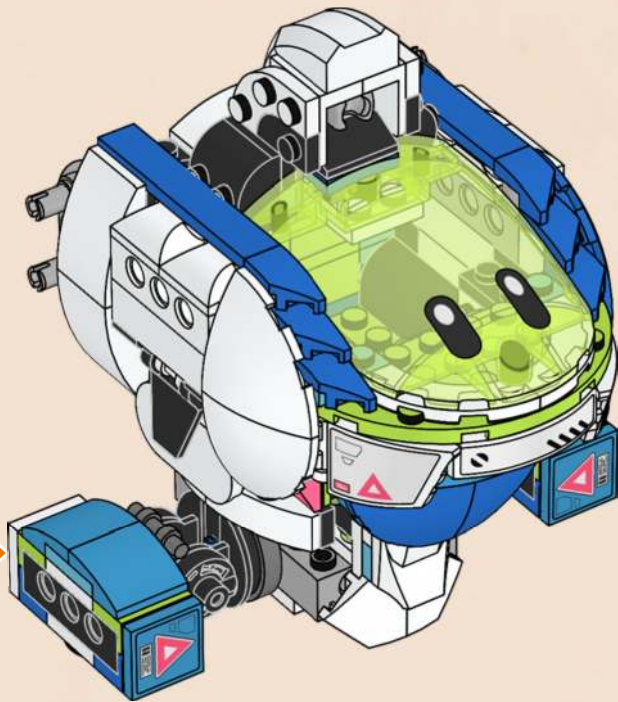



1



2





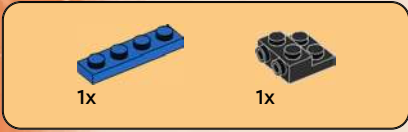
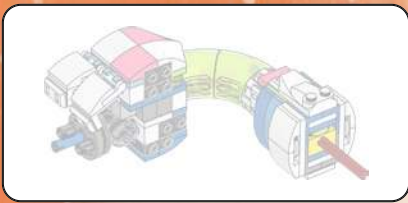

42

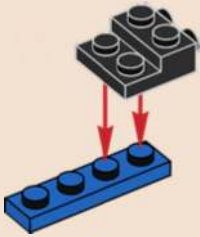

43

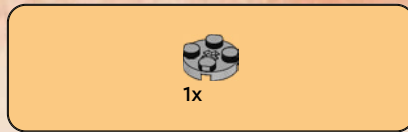

44

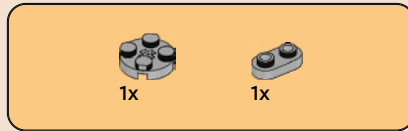
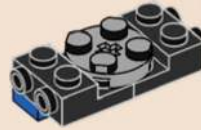

45

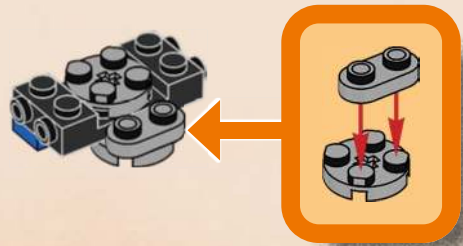

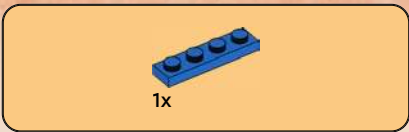

46



47

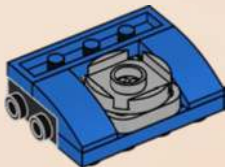

48

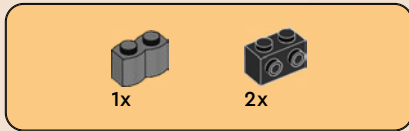

49





50

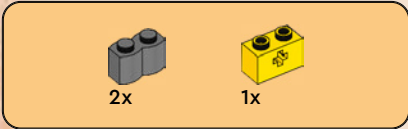
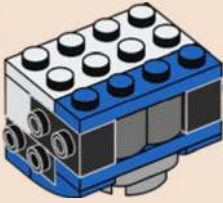

51

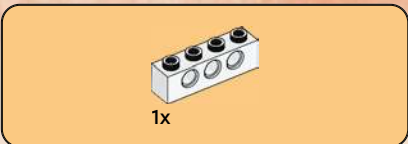
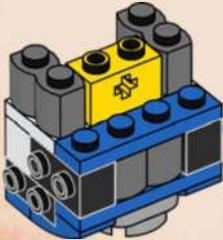

52

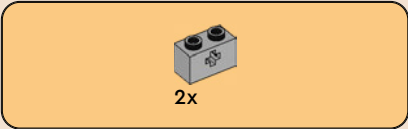
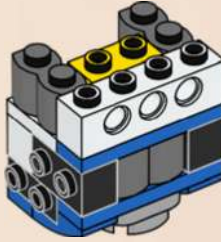

53

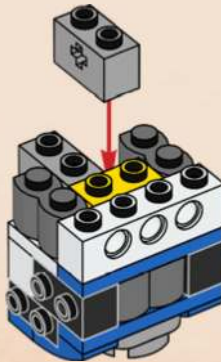

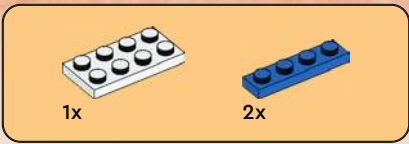

54

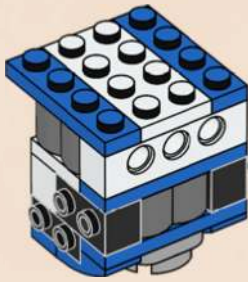

55

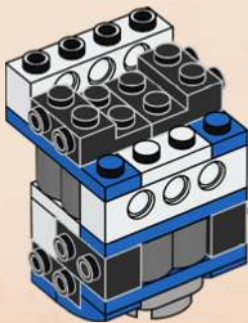

56

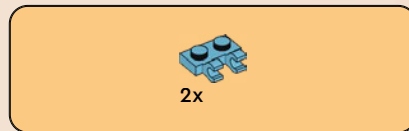
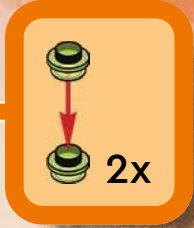
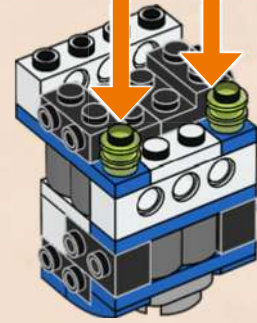

57

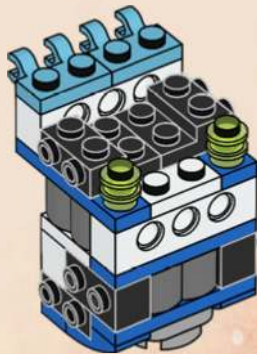



2x

58

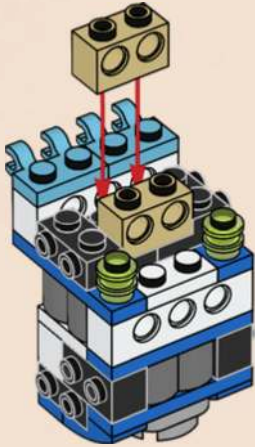

2x

60



2x



1x

59



1x



1x



1x



1x

61

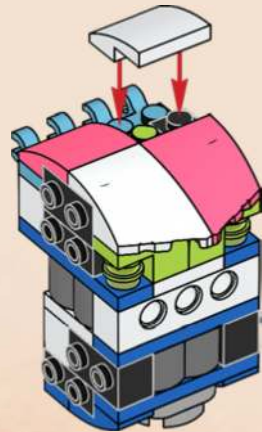

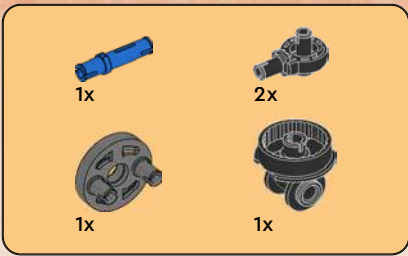

62

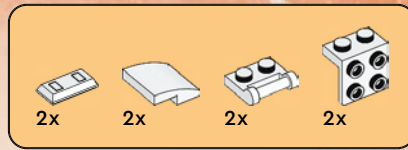
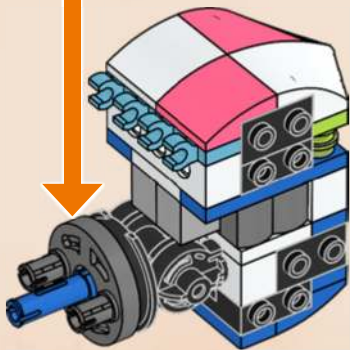
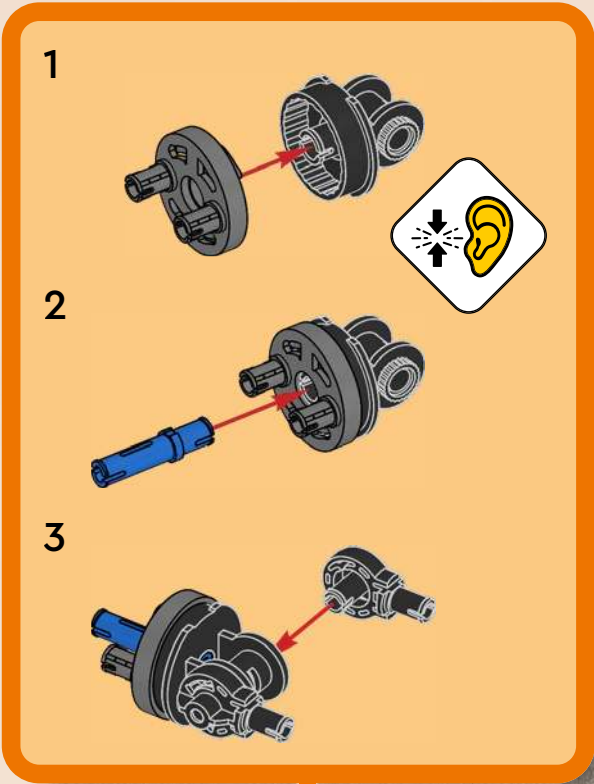

63

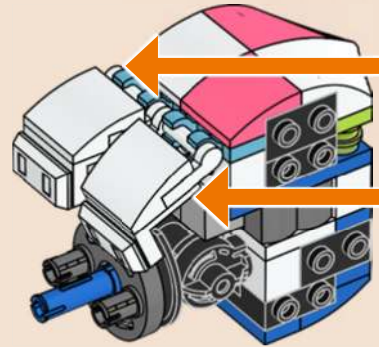
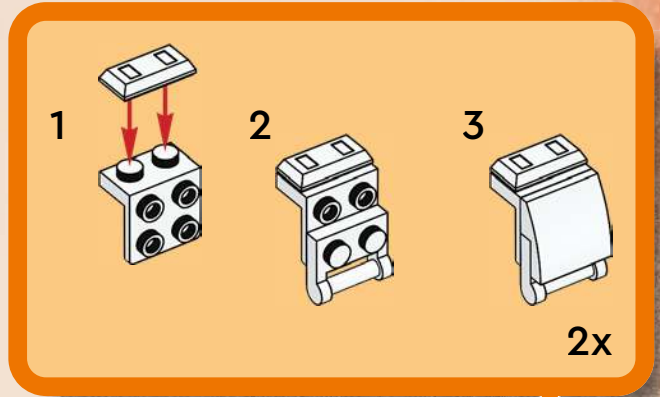



64

1

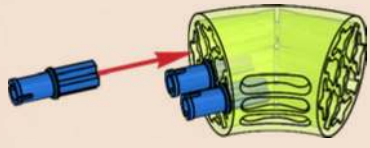

3

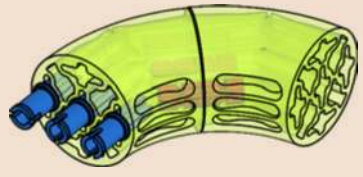

2

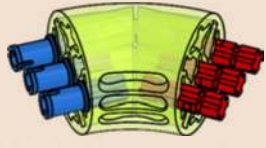

4

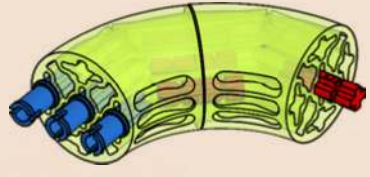

5

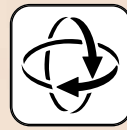
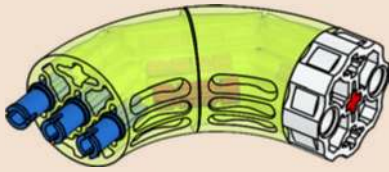

6

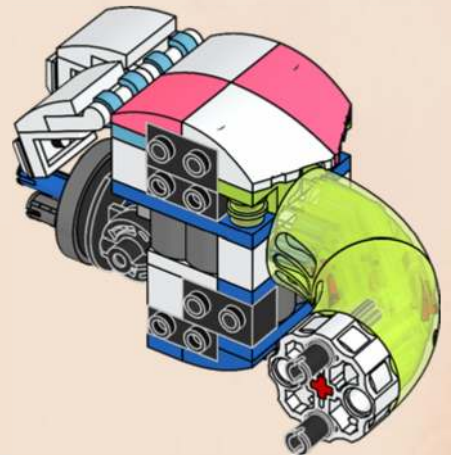
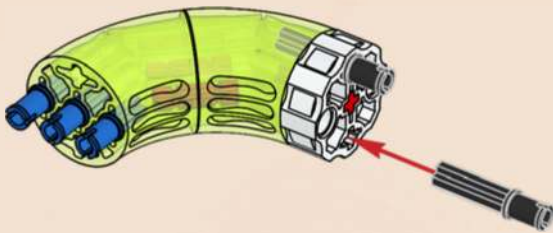



69

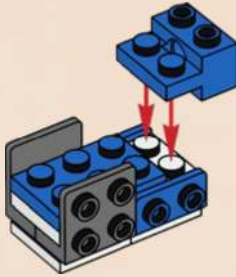

71

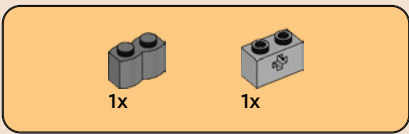
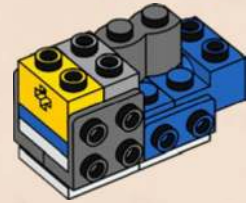

70

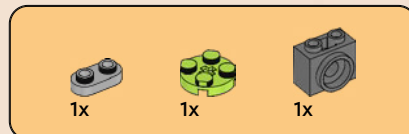
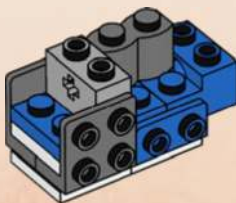

72

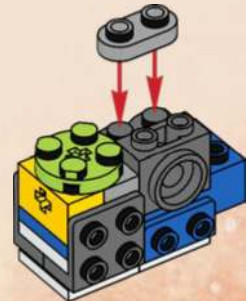



2x

73

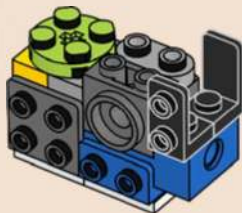

1x



1x

75



1x

74



1x

76

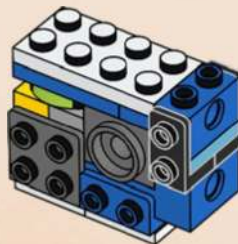

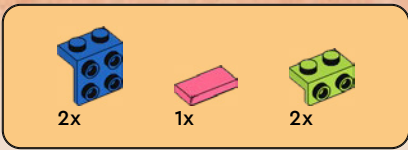

77

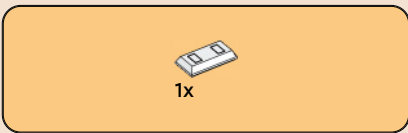
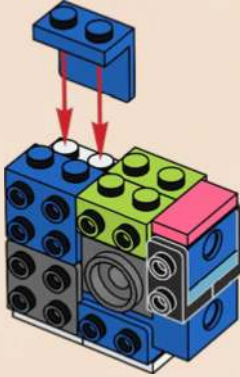

78

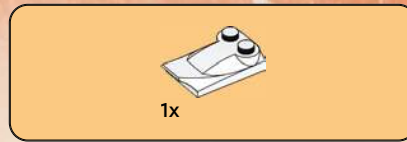

79

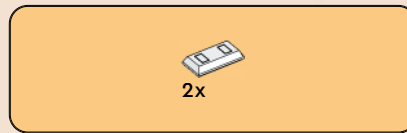

80

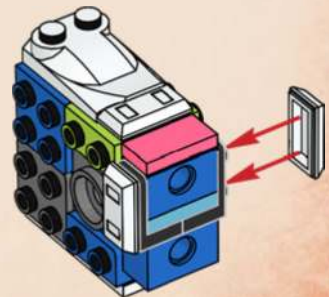



81

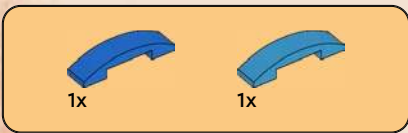
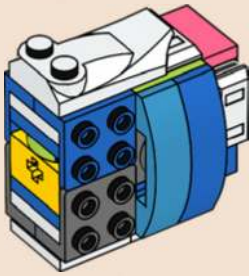

82

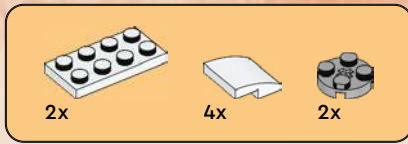
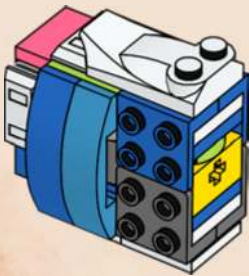

83

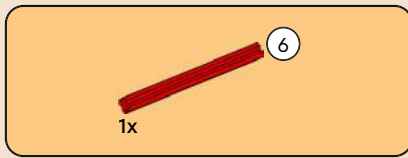
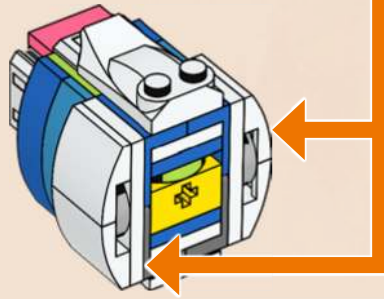
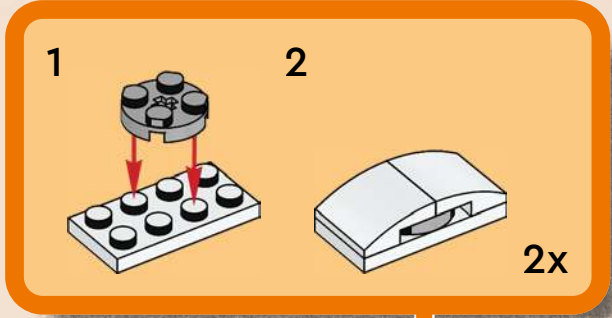

84

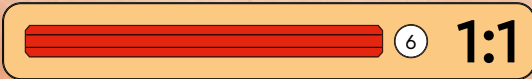
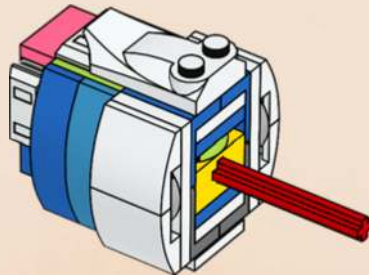

85

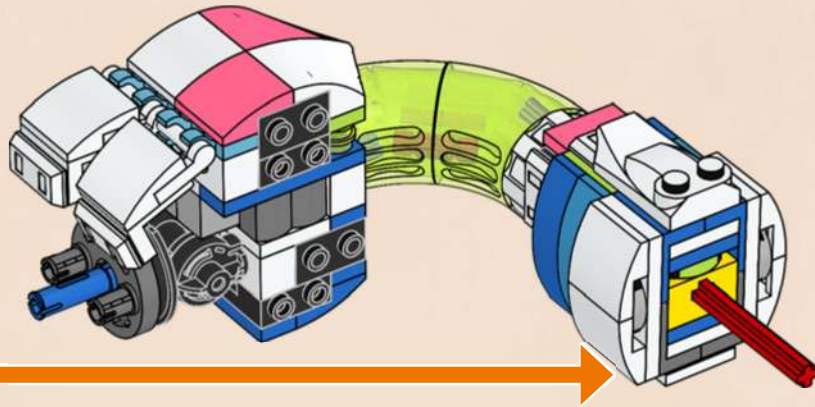

86

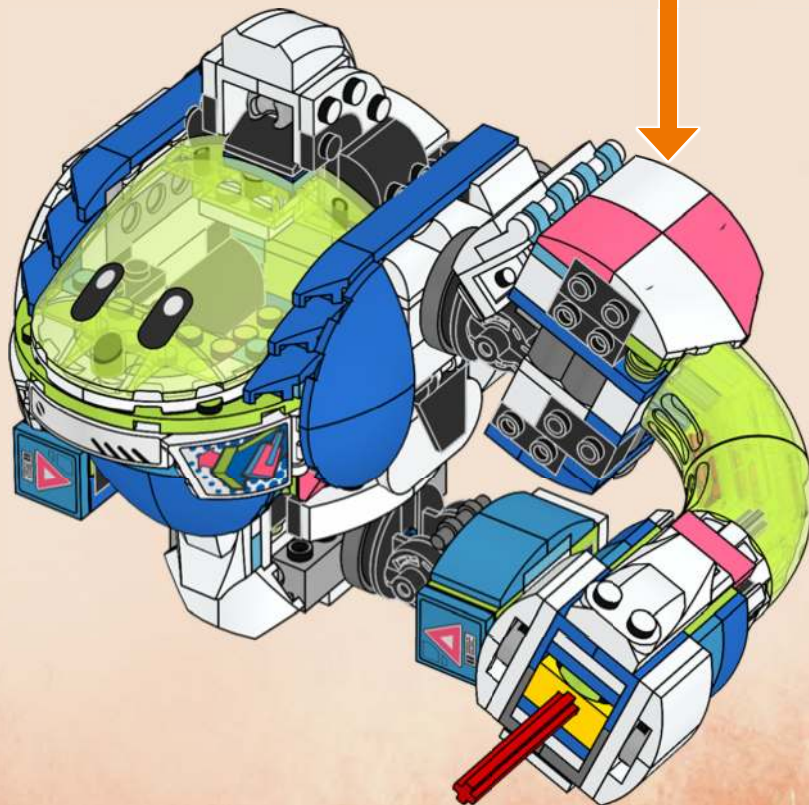



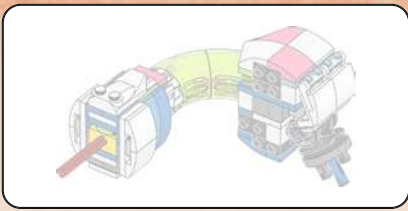

87

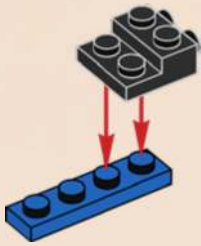

88

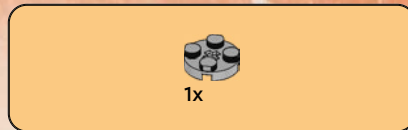

89

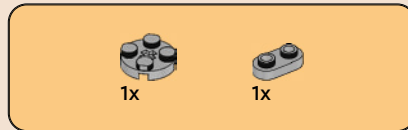

90

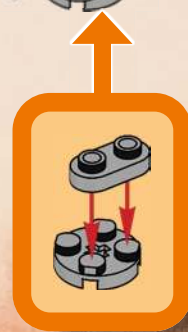



1x

91



2x

92

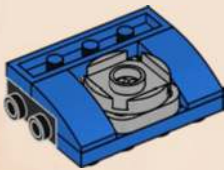

1x



1x

93



1x



2x

94



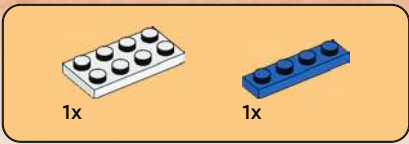

95

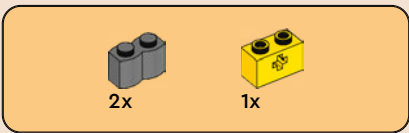

96

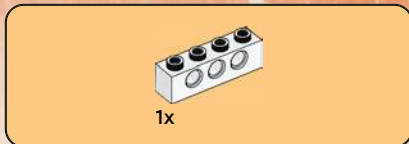
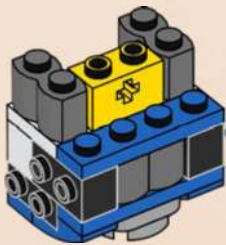

97

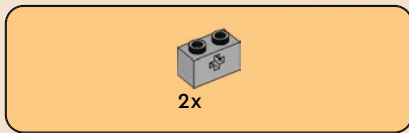
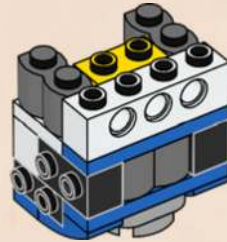

98

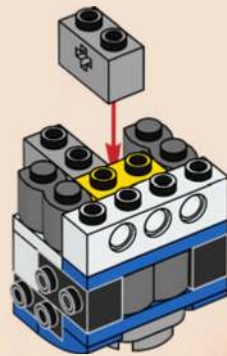



99

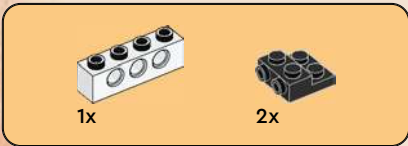
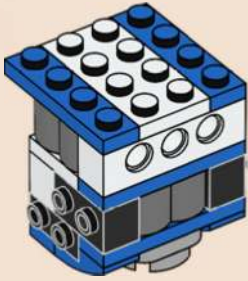

100

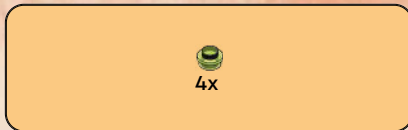
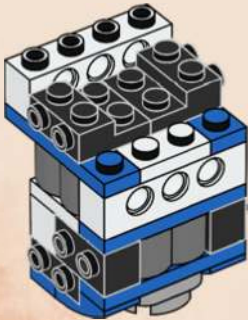

101

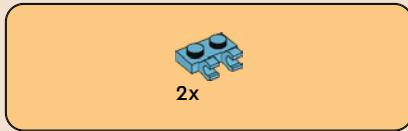
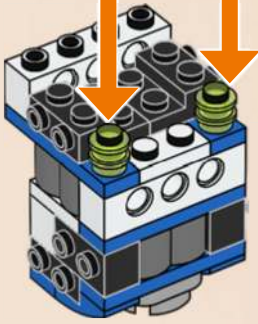
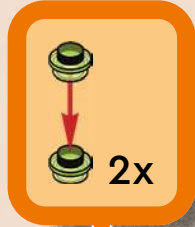

102

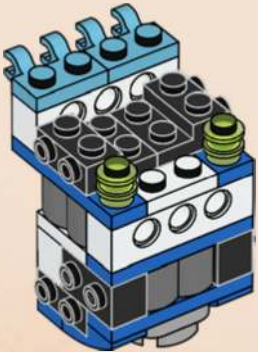



2x

103

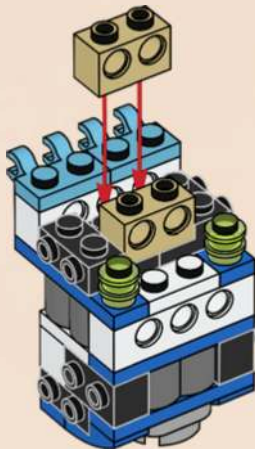

2x

105



2x



1x

104



1x



1x



1x



1x

106

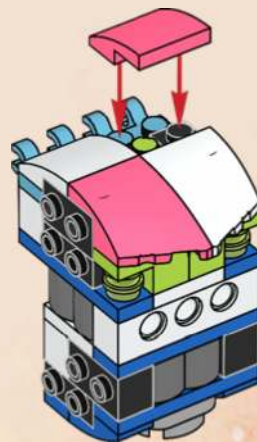



107

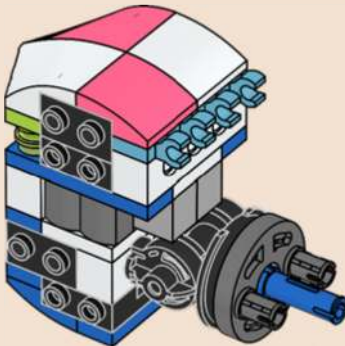
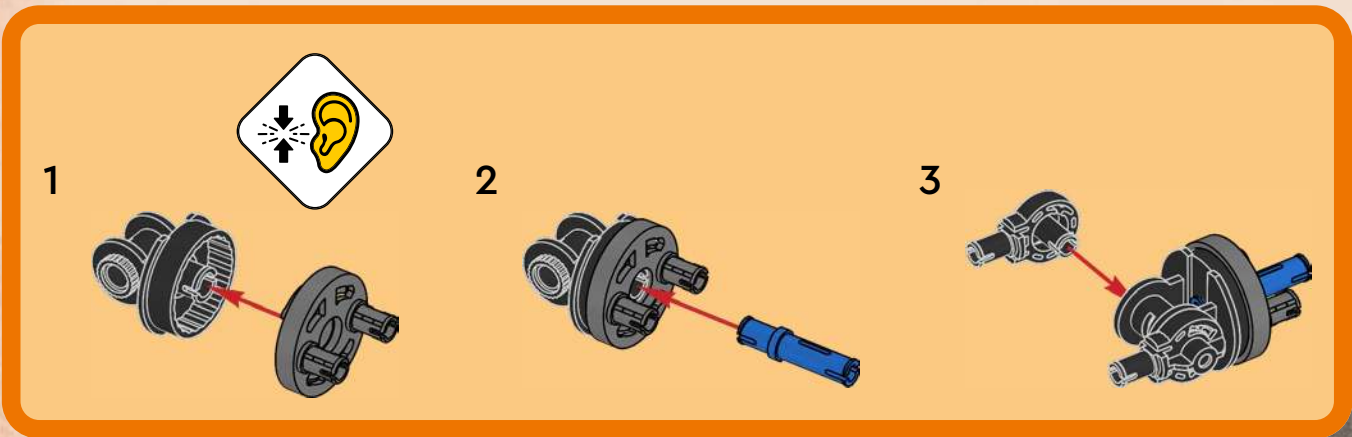

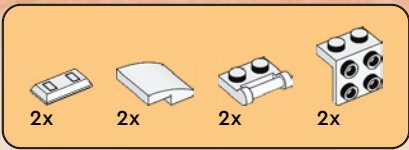

108

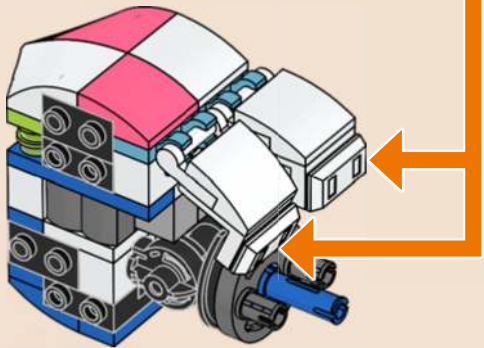
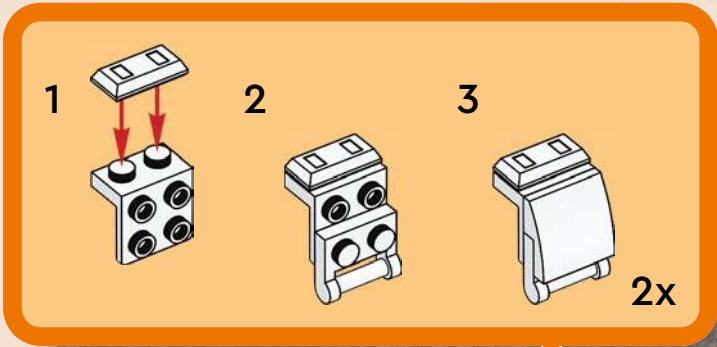

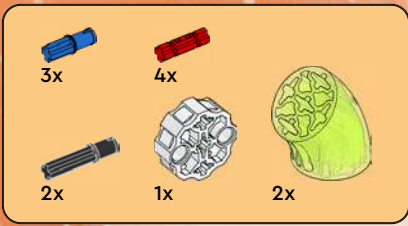

109

1

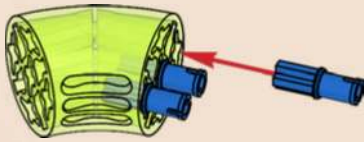

2

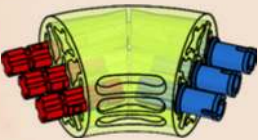

3

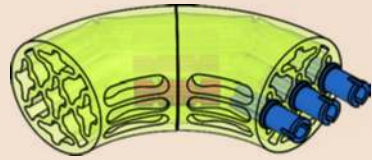

4

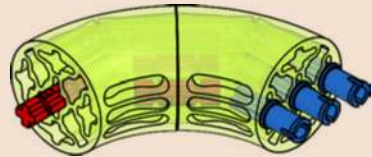

5

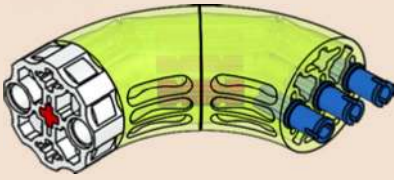

6

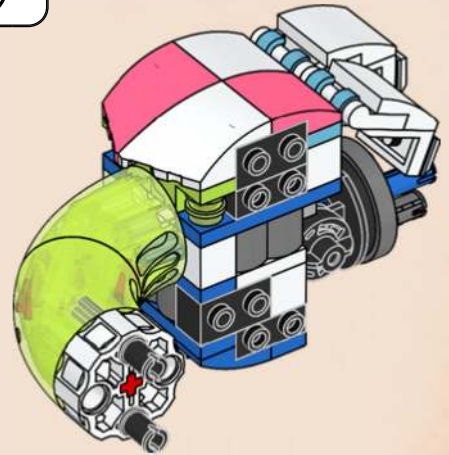
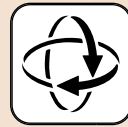
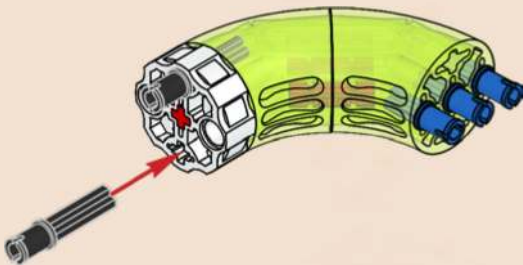



110

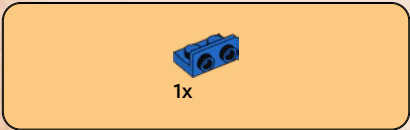
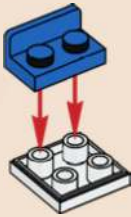

111



112

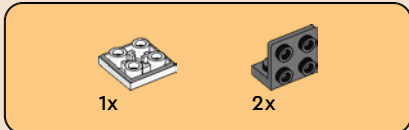

113

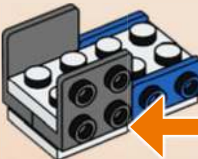
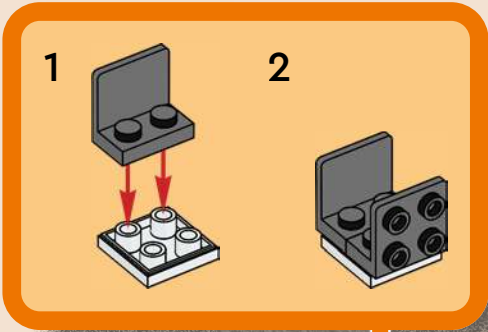
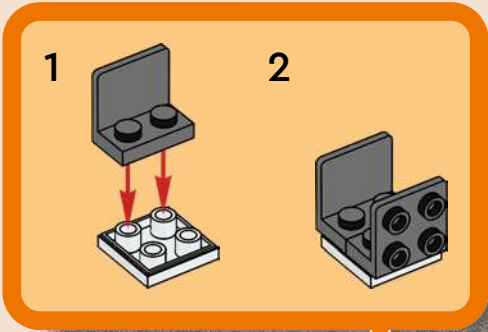



114

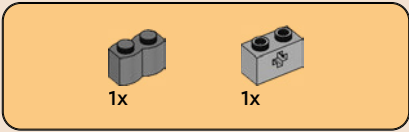
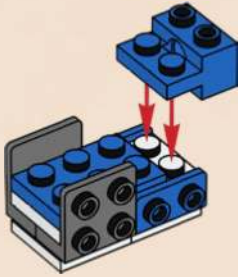

115

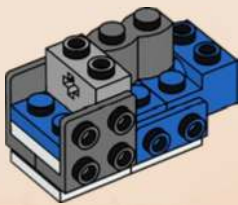

116

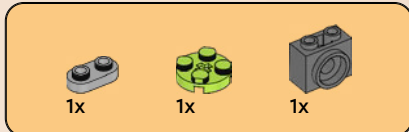
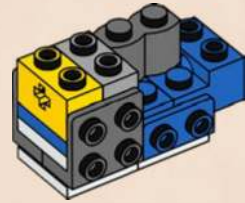

117

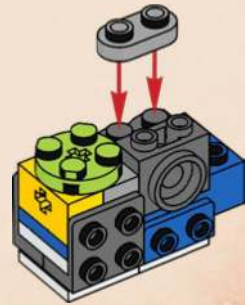



2x

118

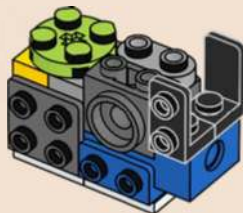

1x

119

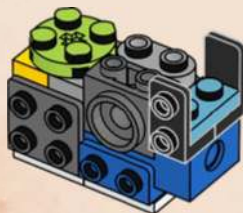

1x



1x

120



1x

121

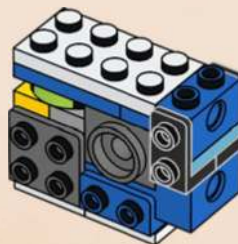



122



124

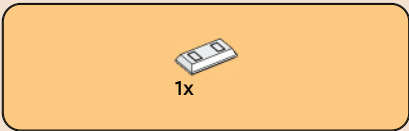

123

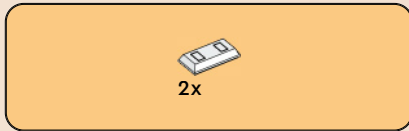

125

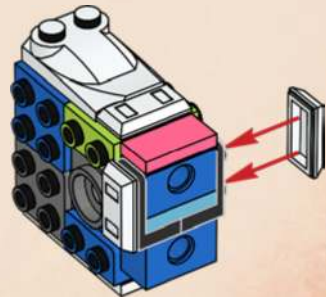



126

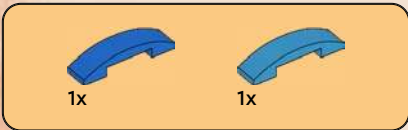
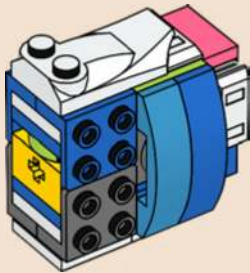

127

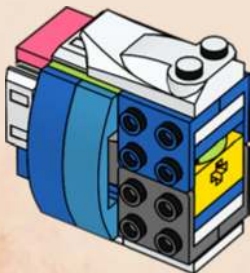

128

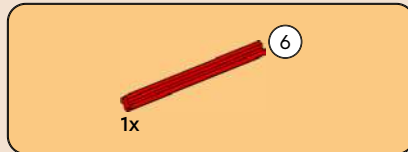
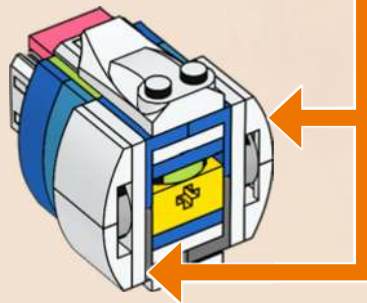
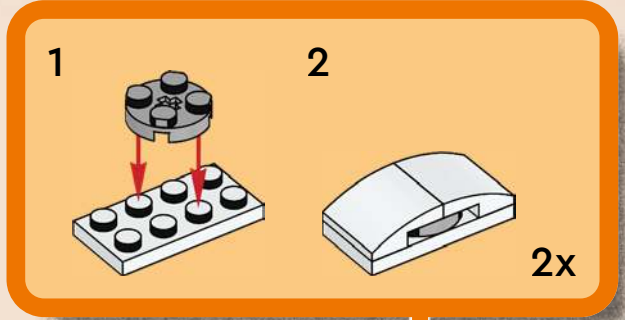

129

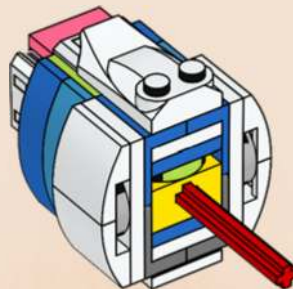

130

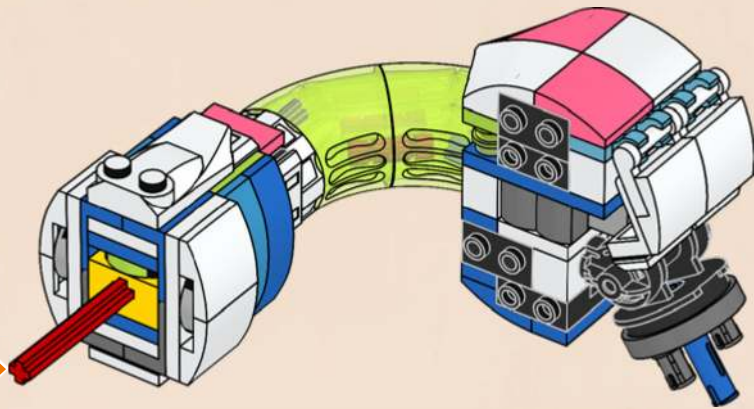

131

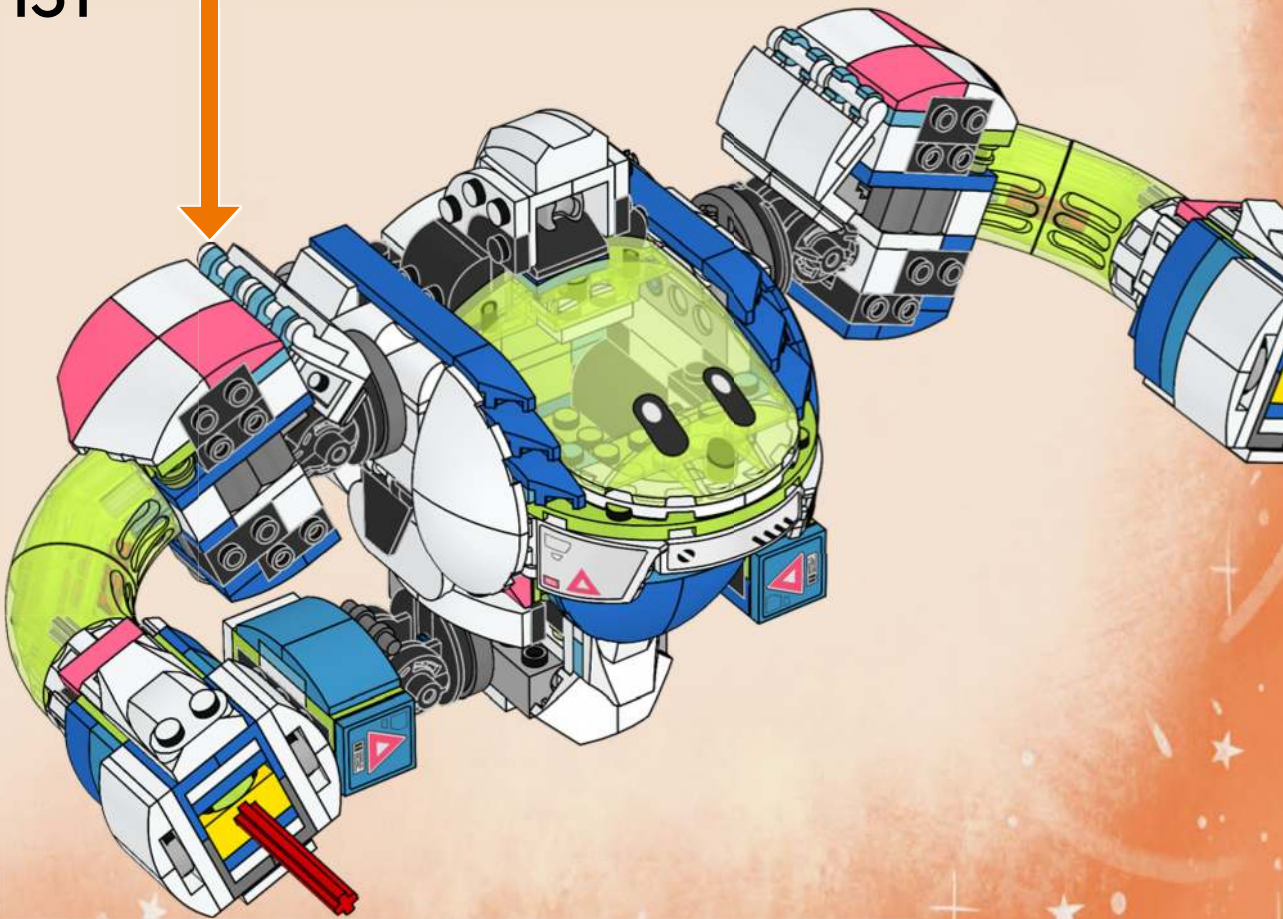



1

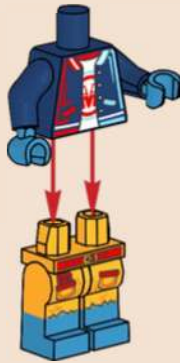

2

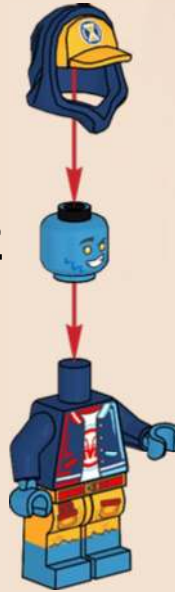

3





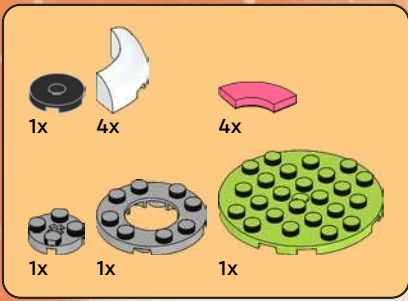

132

1



2



3



4



5

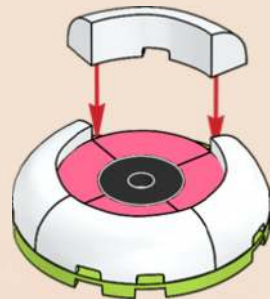

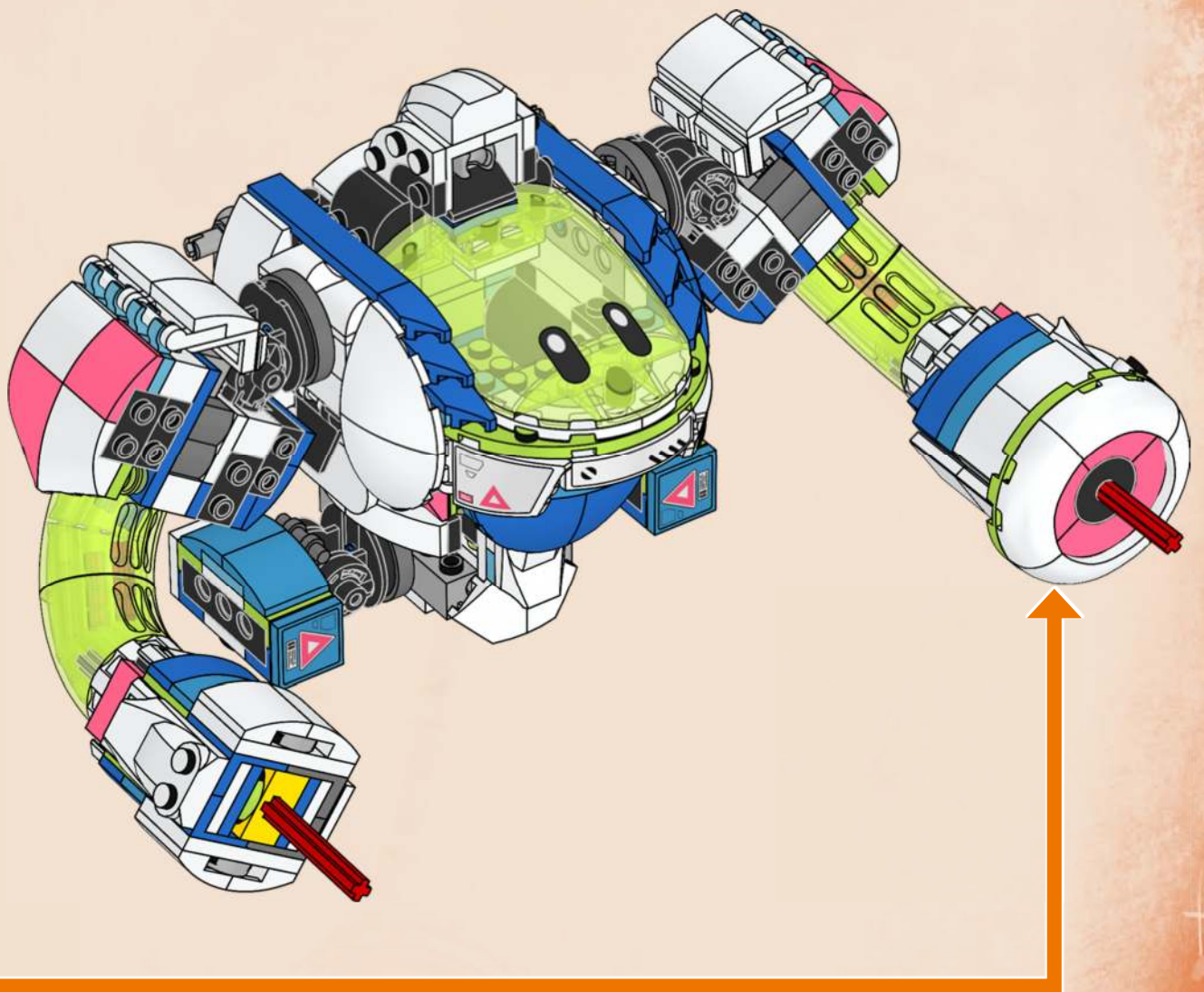

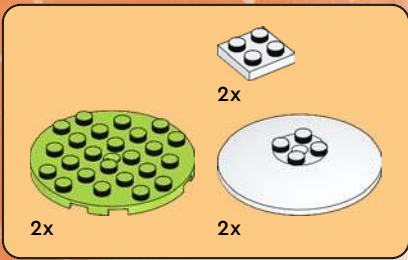

133

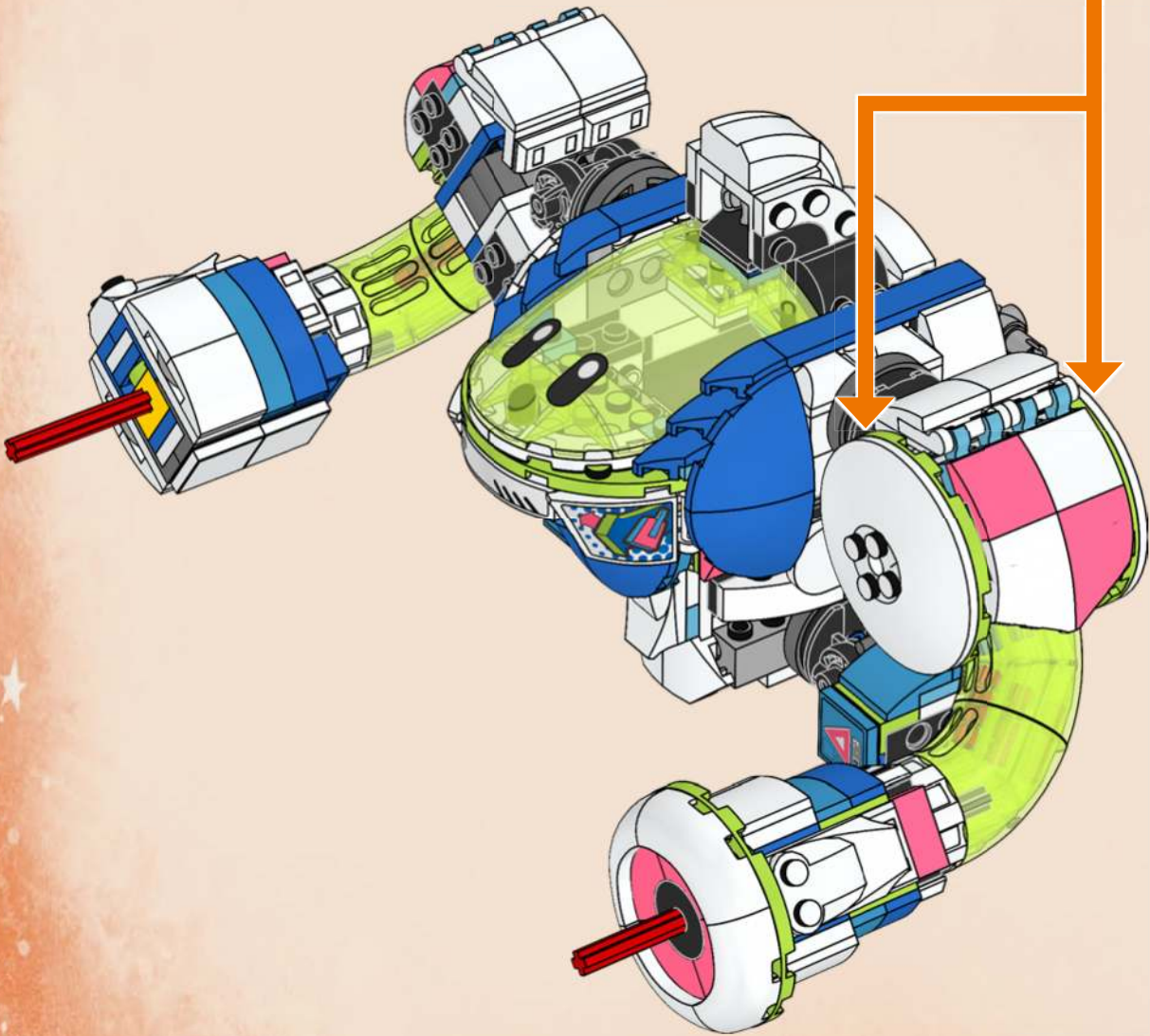
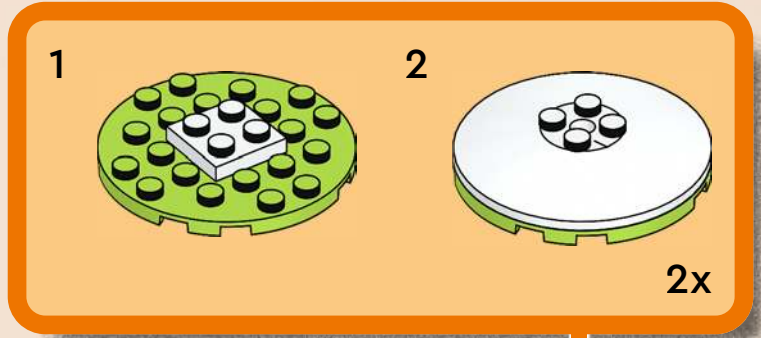

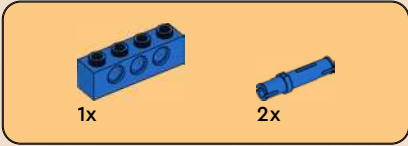
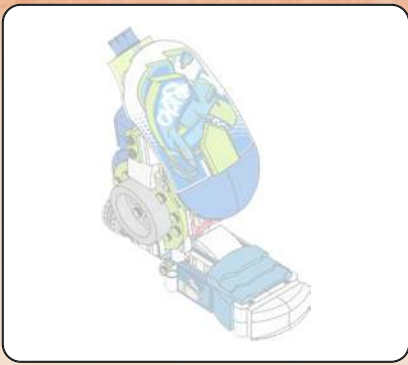

134

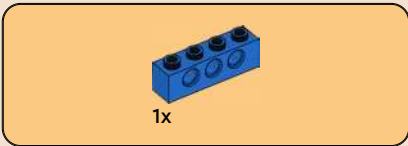
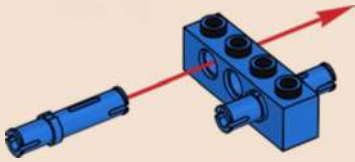

135

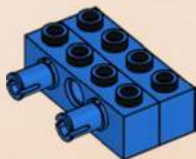

136

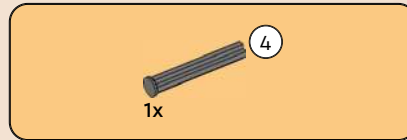
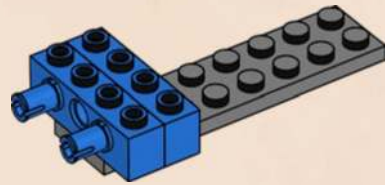

137

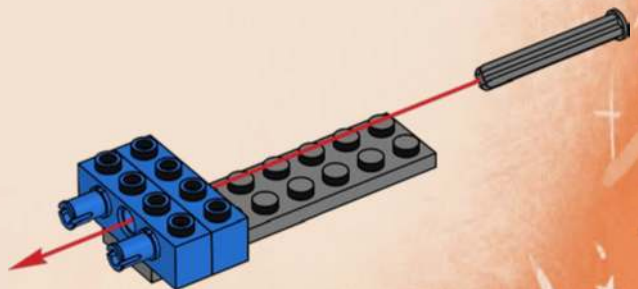

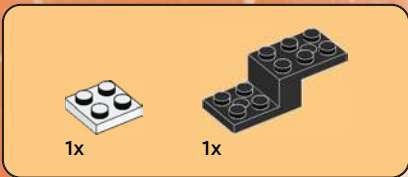

138

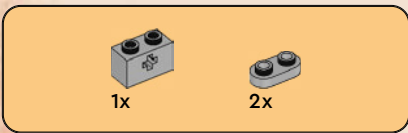
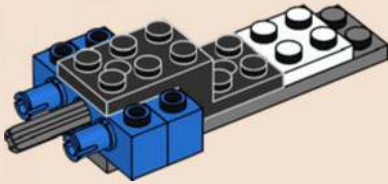

139

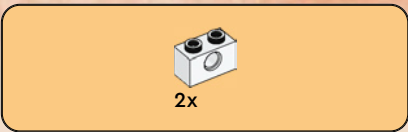
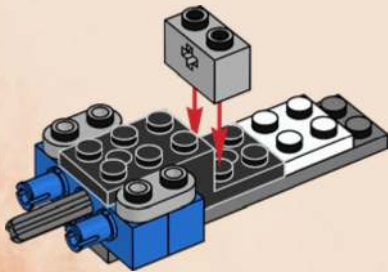

140

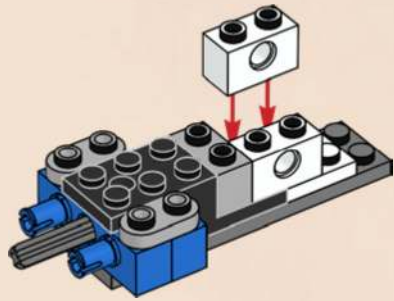

141

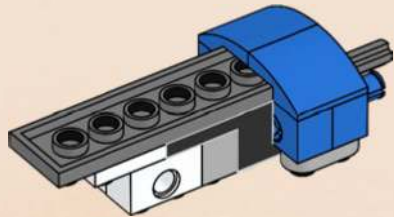

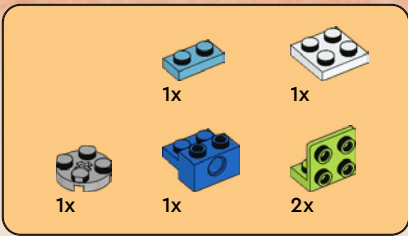

142

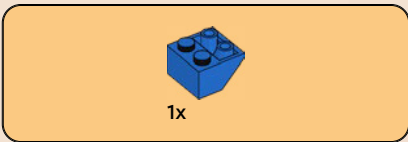
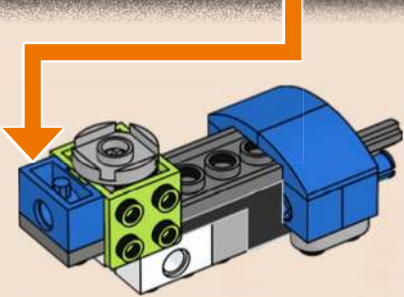
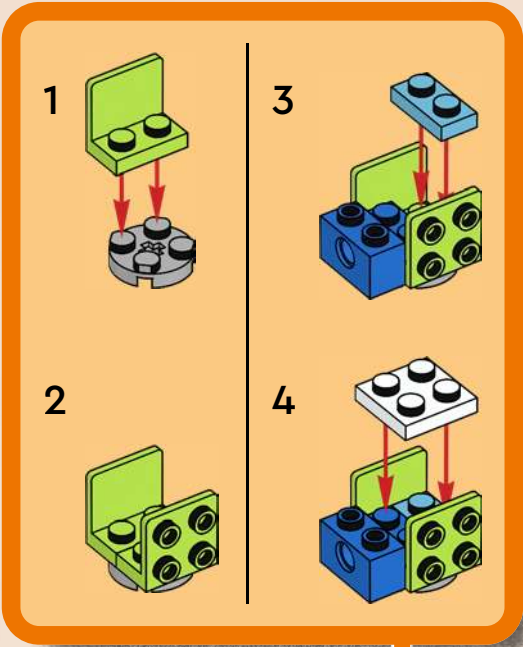

143

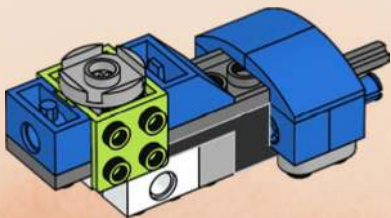

144

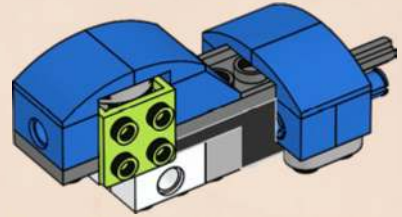

145

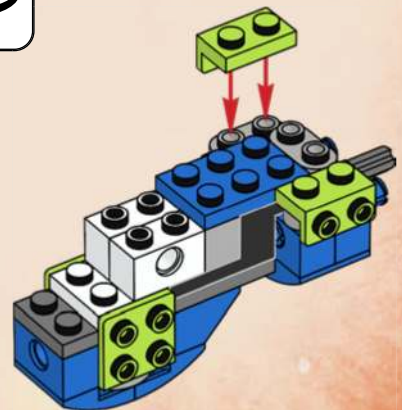
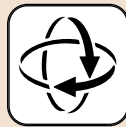

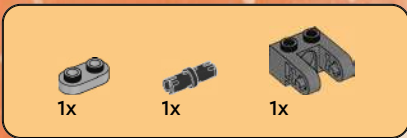

146

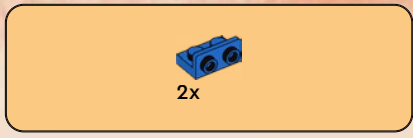
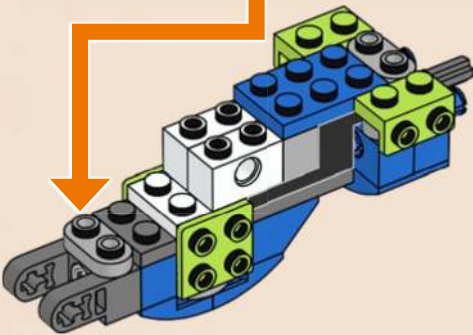
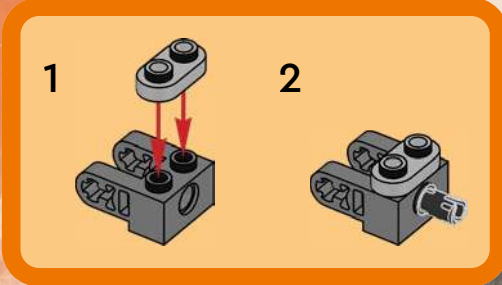

148

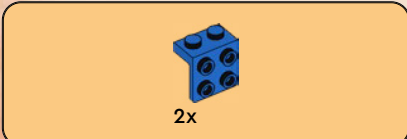
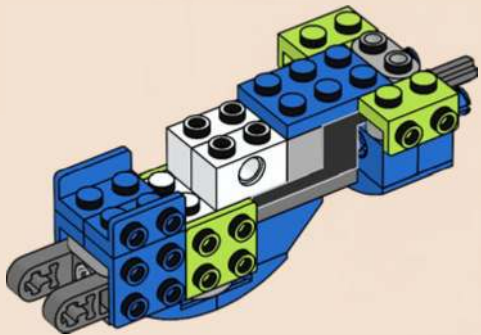

147

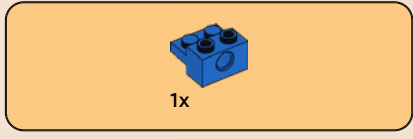
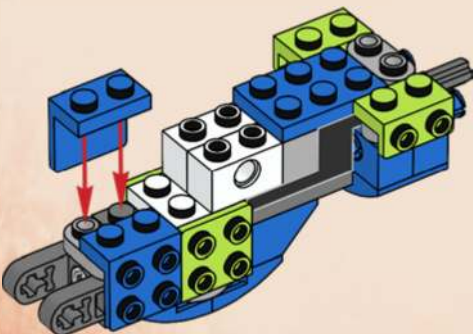

149

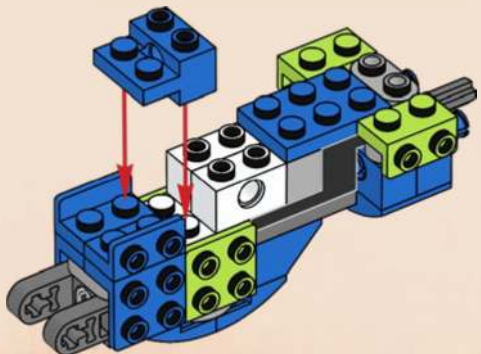



150

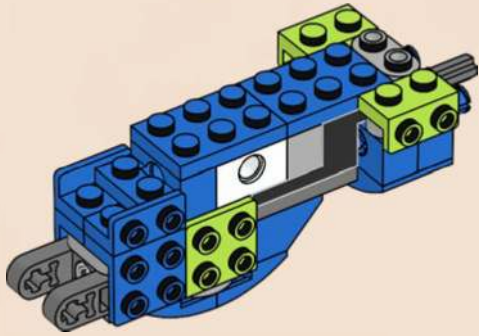

152

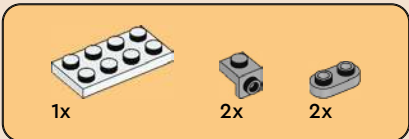
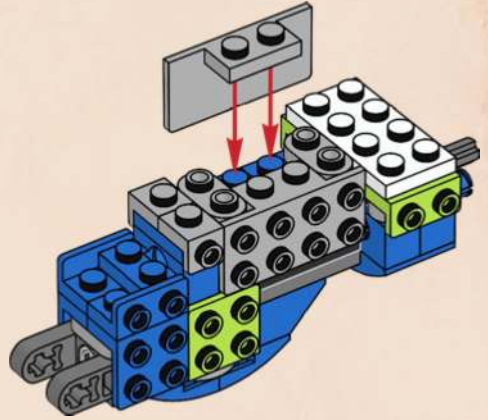

151

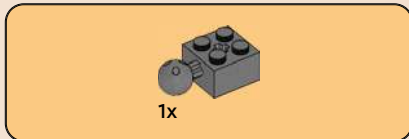
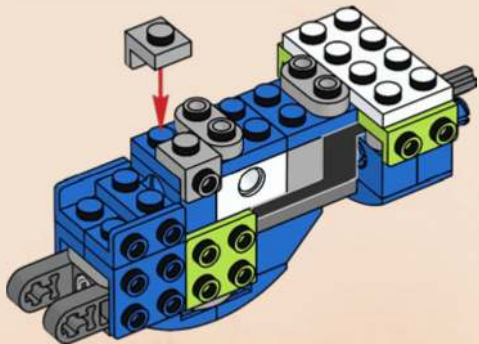

153

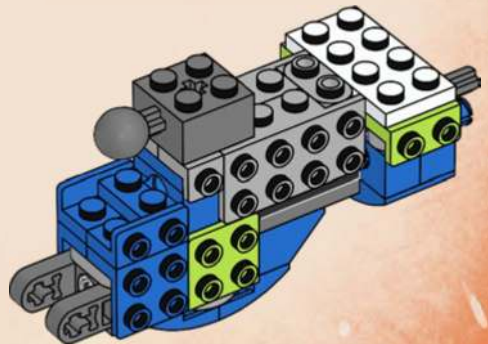



1x

154

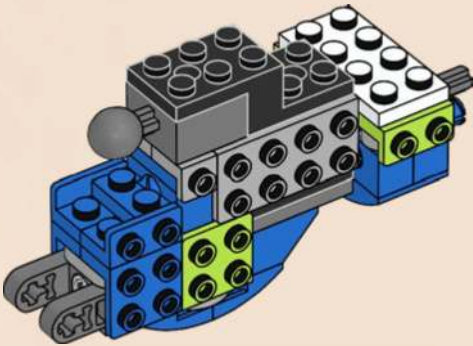

2x

155

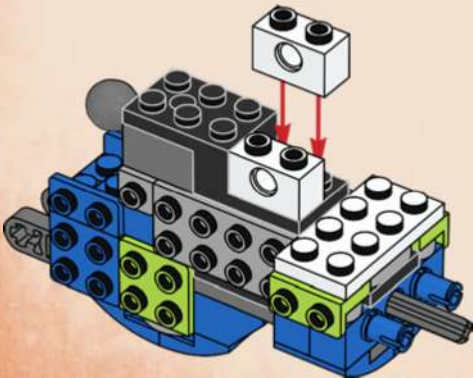

1x



1x

156

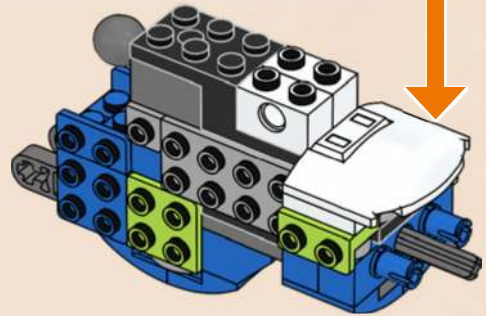
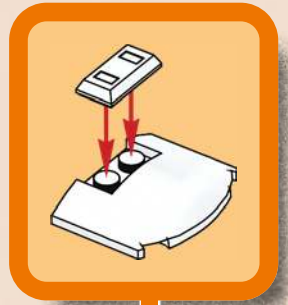

1x



2x

157

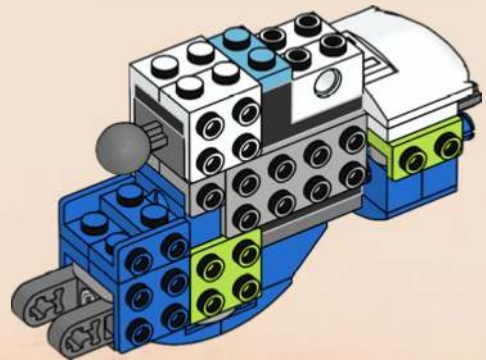

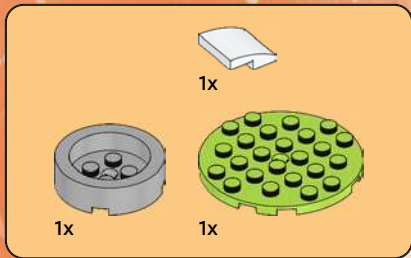

160

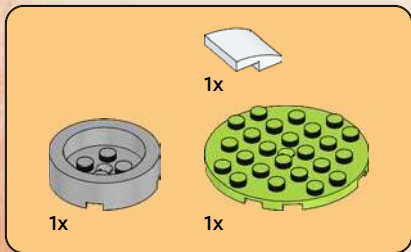
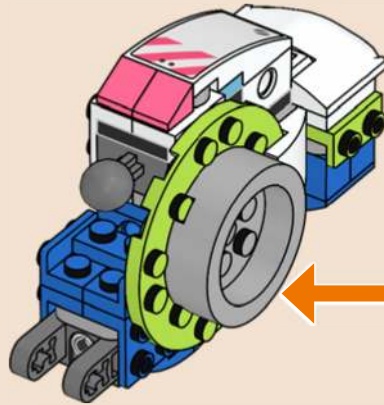
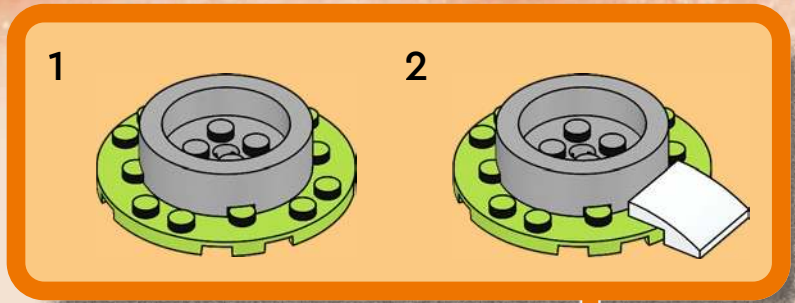

161

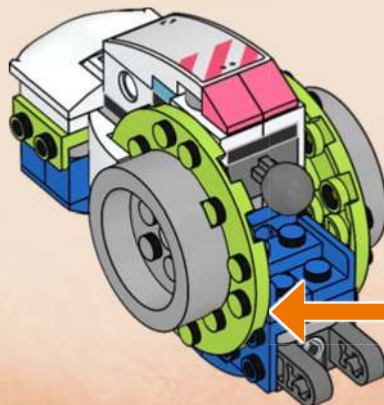
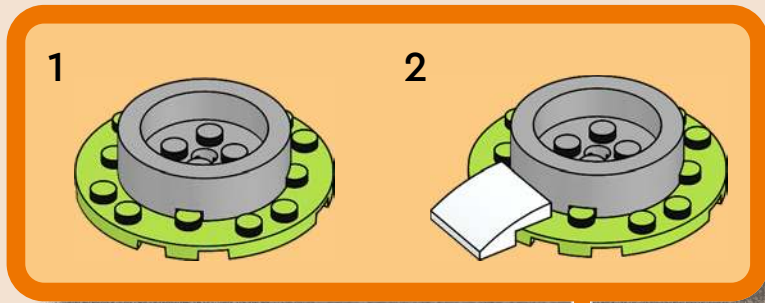



2x



2x

162

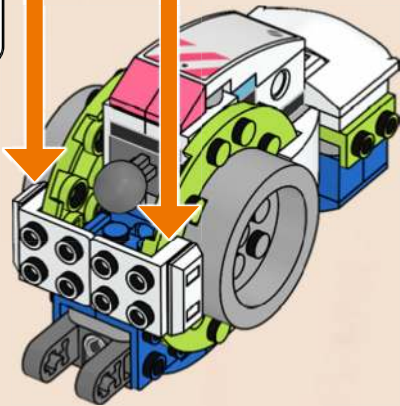
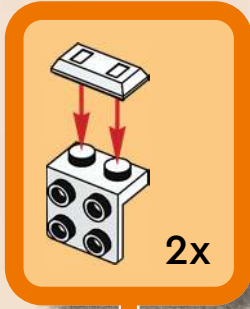

1x

163

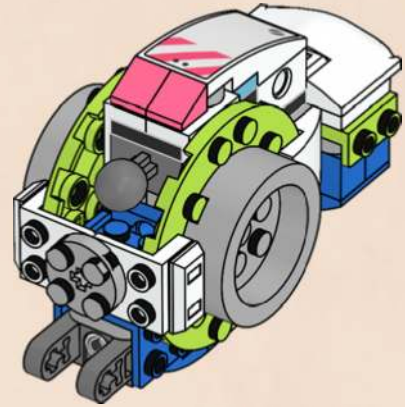

2x

164

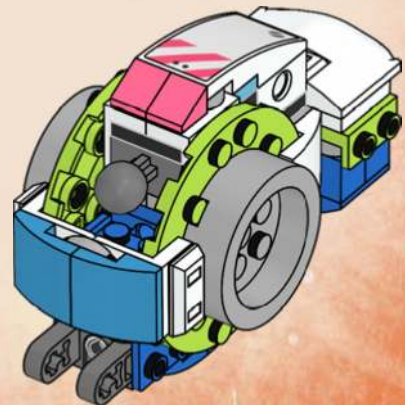

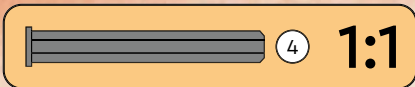
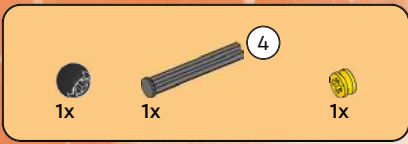

165

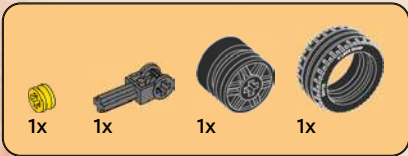
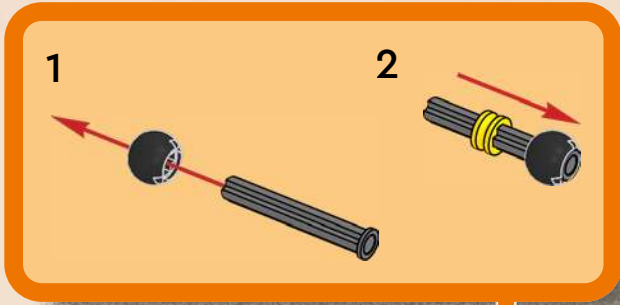
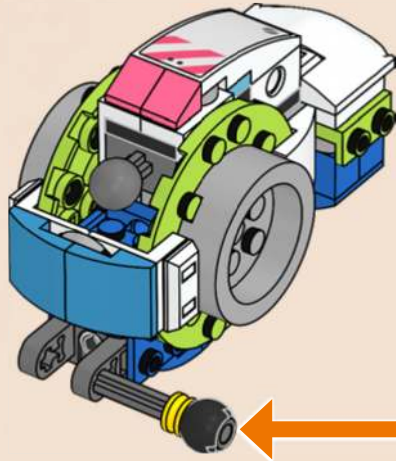

166

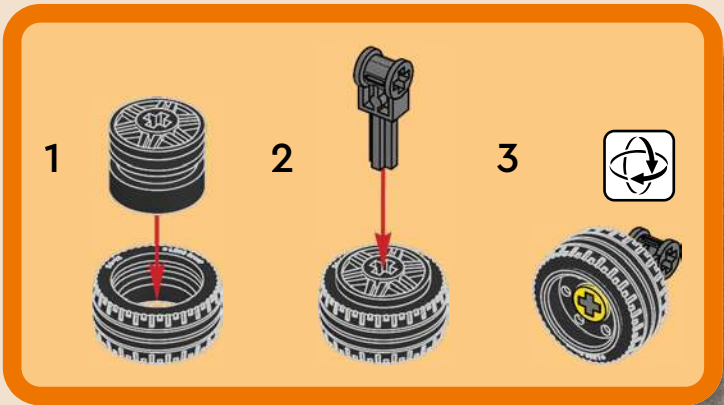
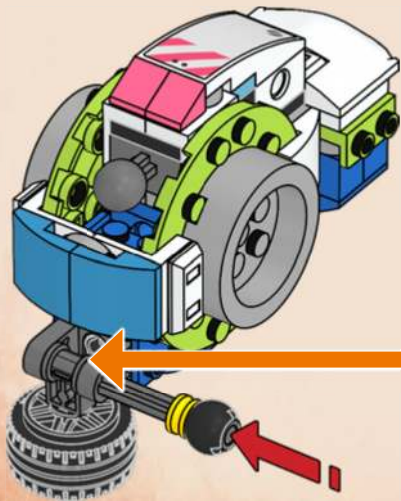

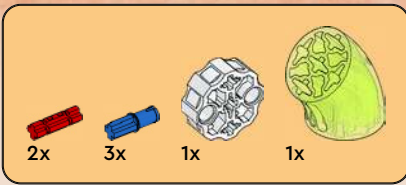

167

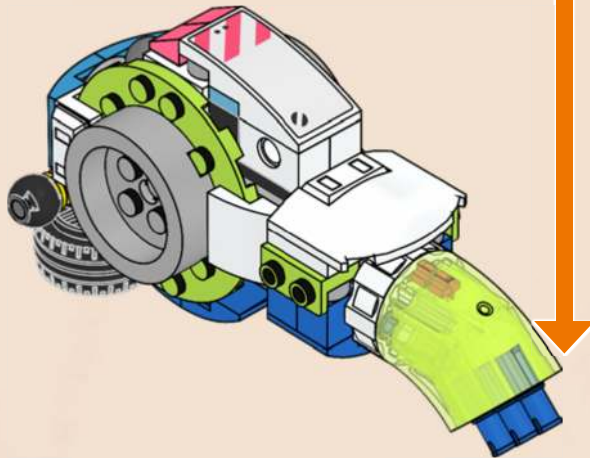
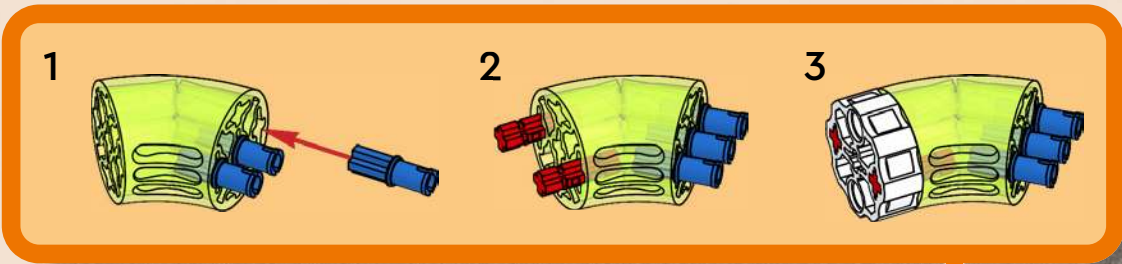

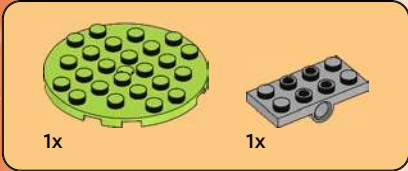

168

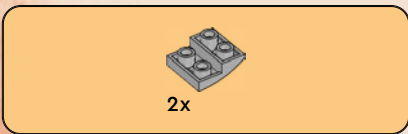
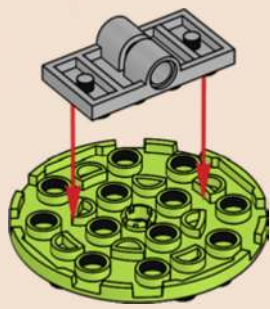

169

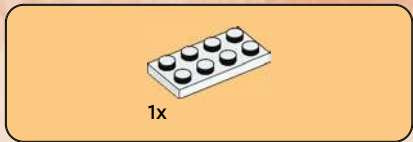
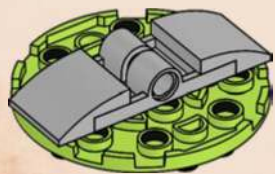

170

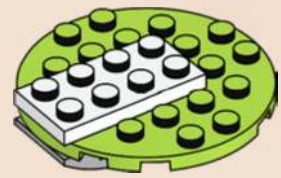

171





172

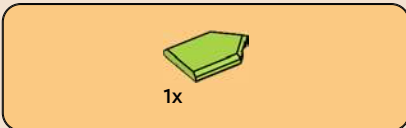

173



174

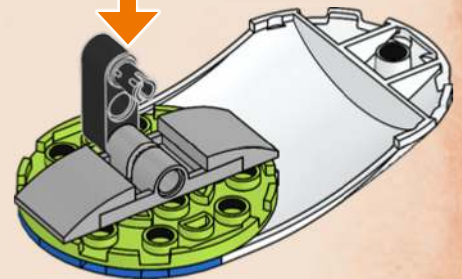
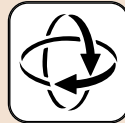
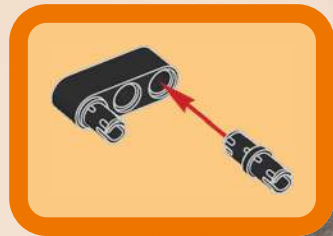

175

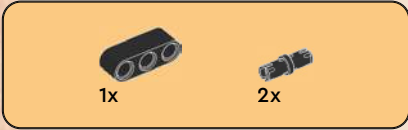
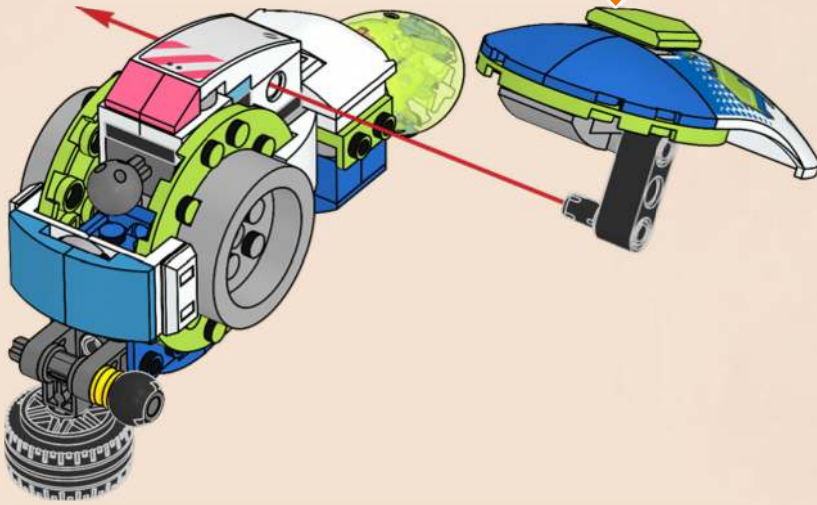

176

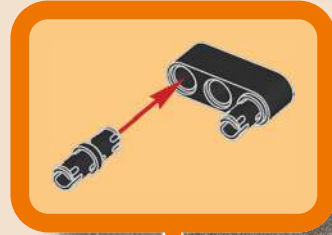
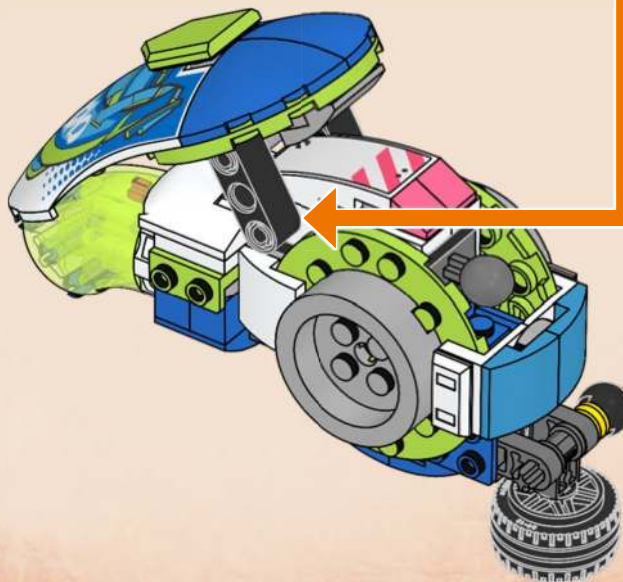

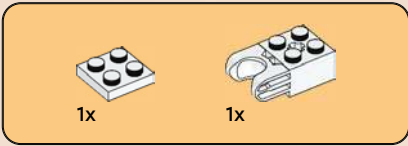

177

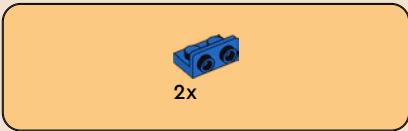
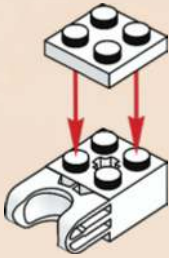

178



179



180





2x

181



1x



1x

183

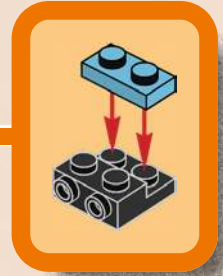

1x



1x

182

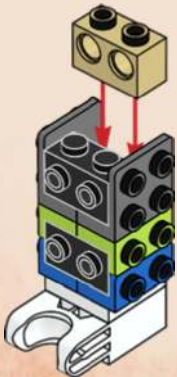

1x



1x

184





2x

185

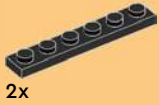

2x

186

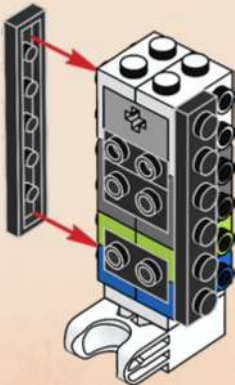

2x



2x

187

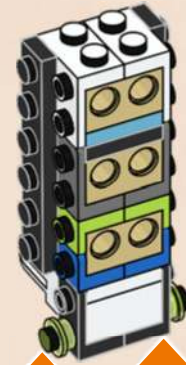
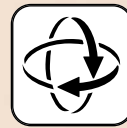

2x



4x

188

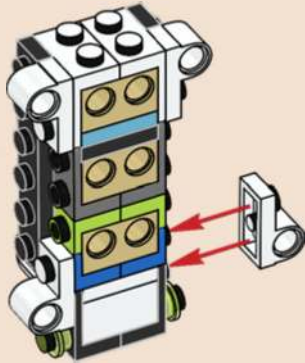

4x

189

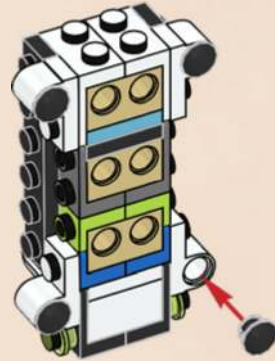

2x

190

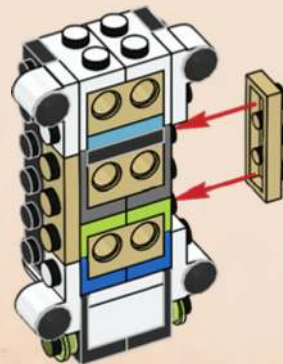



191

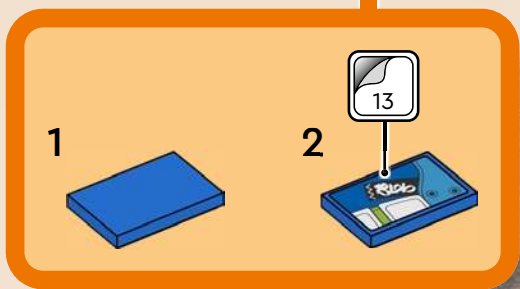

192



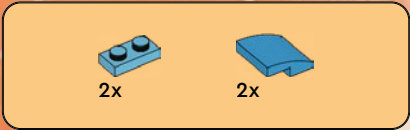

193

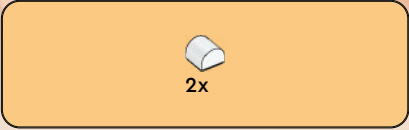
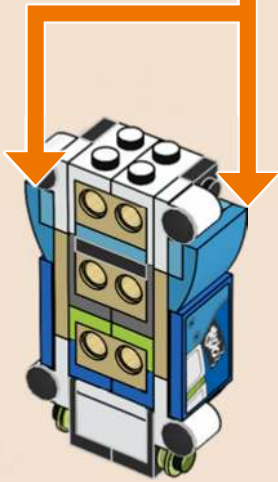
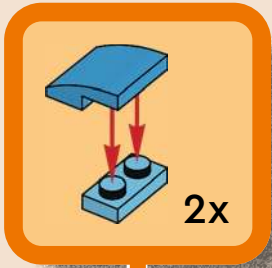

194

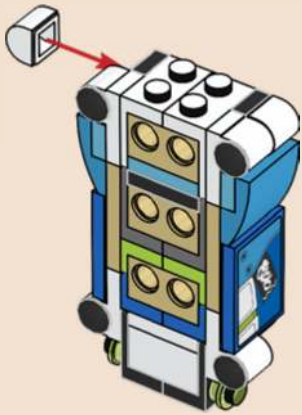



1x



2x

195

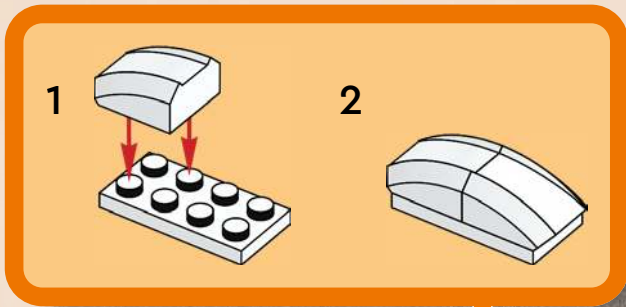

1x



2x

196

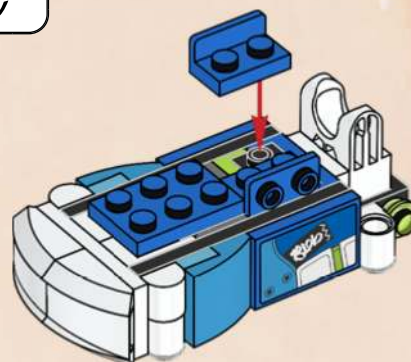

1x

197

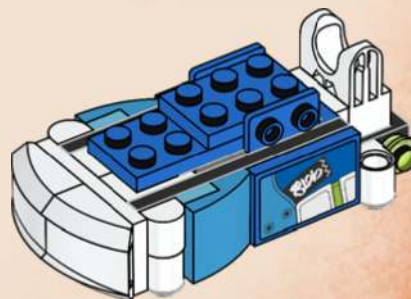



1x



1x

198

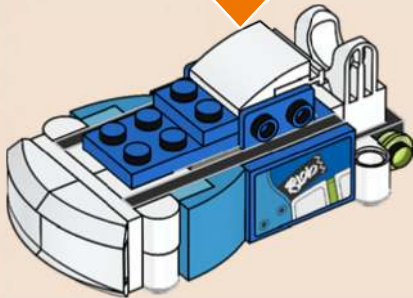
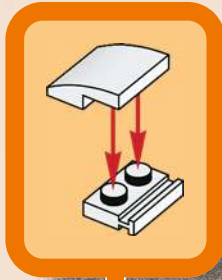

2x

199

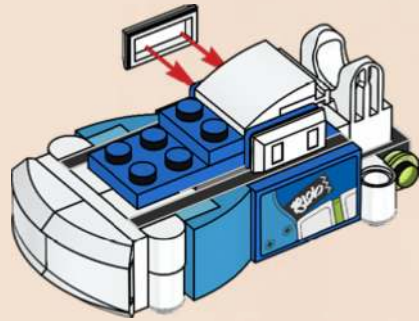

1x

200

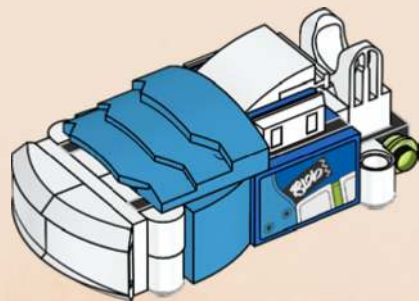

201

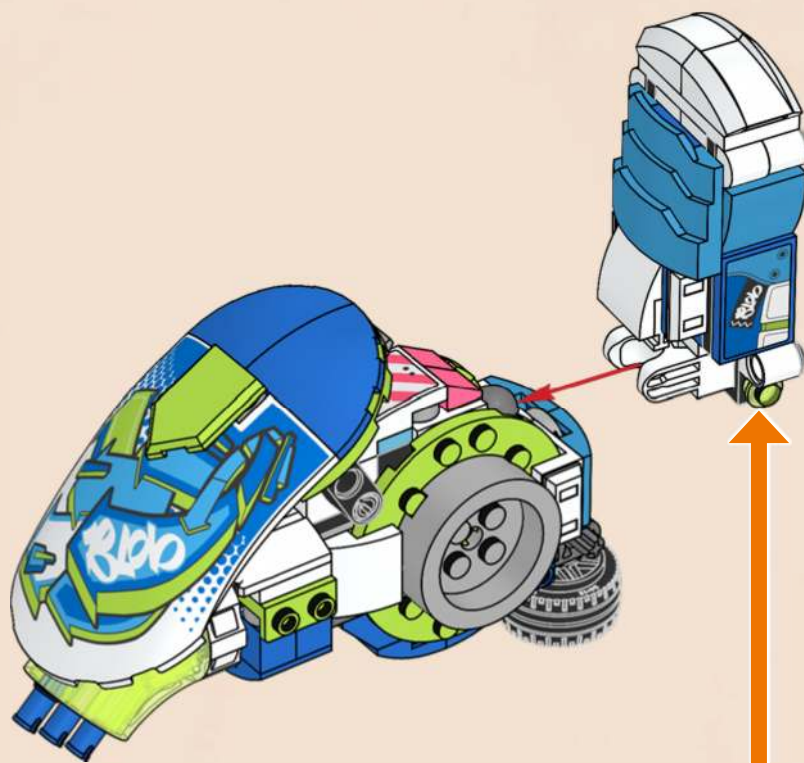

202

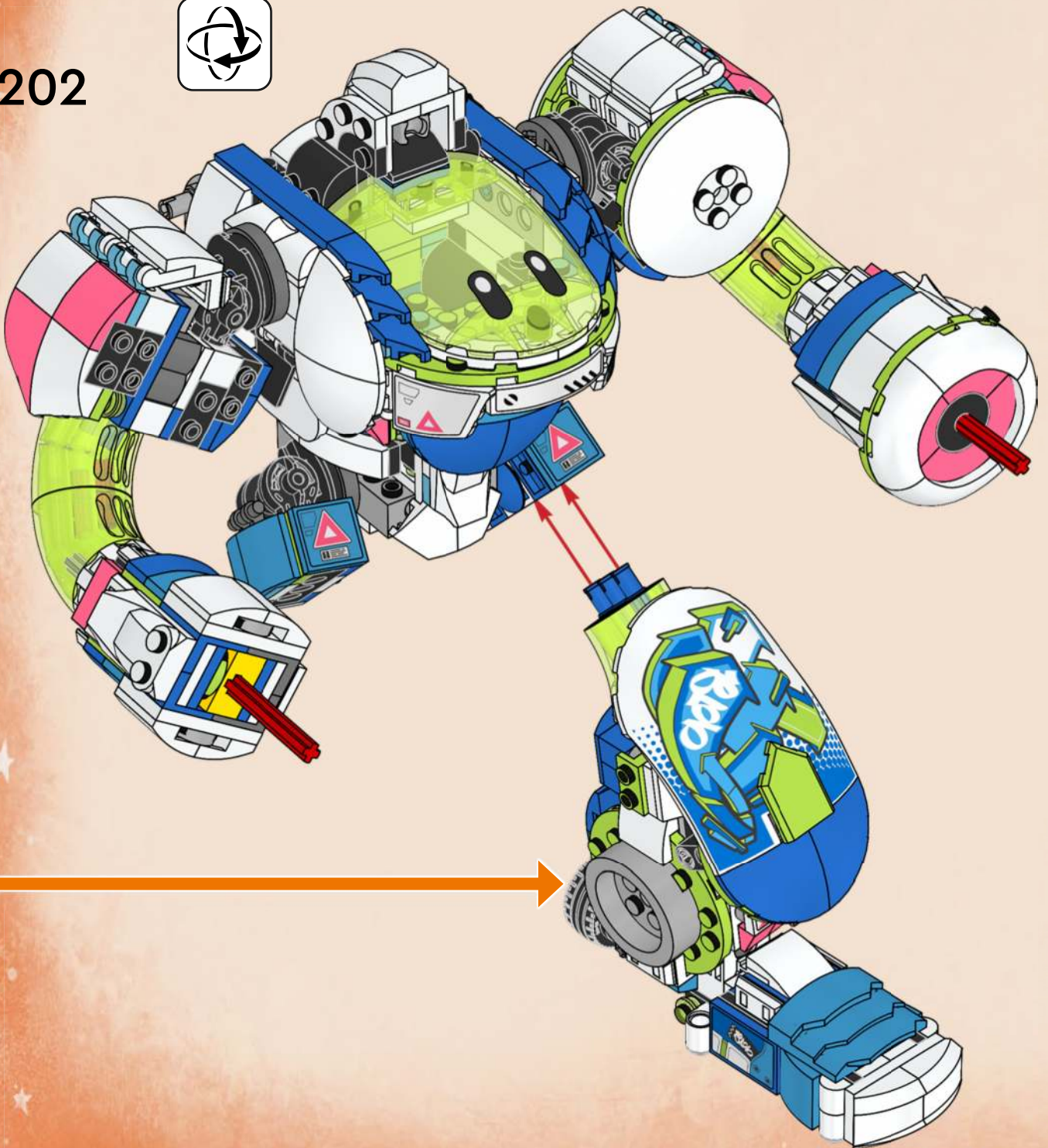

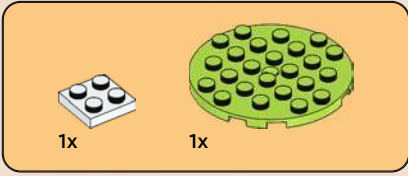
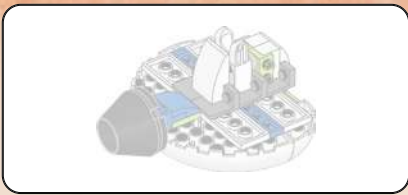

203

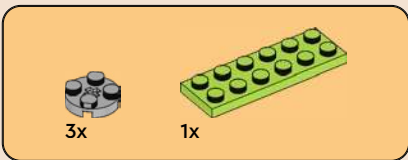

204

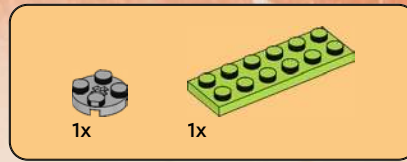
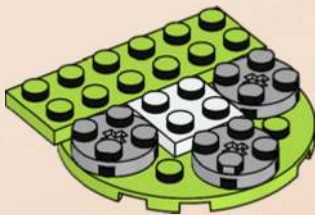

205

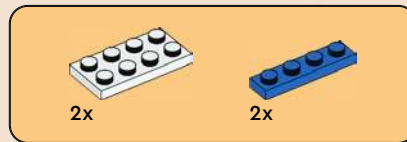
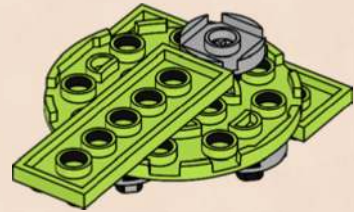
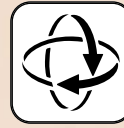

206

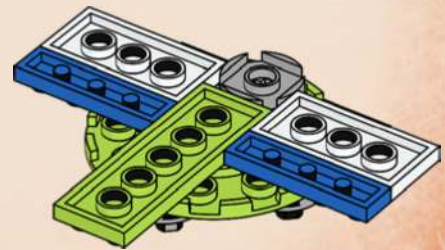

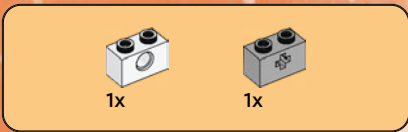

207

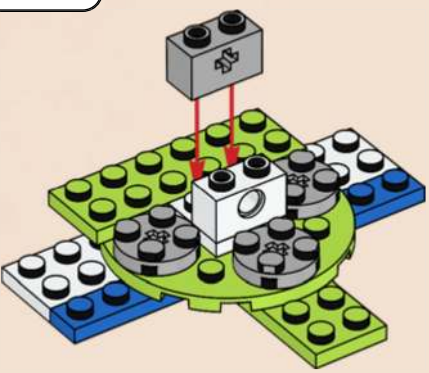

208

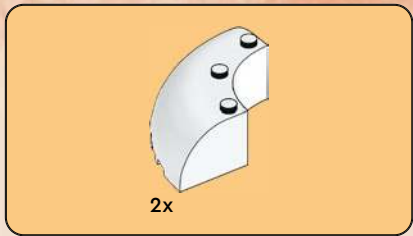
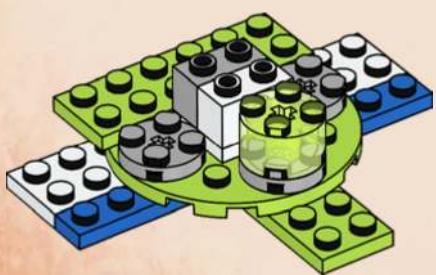

209



210

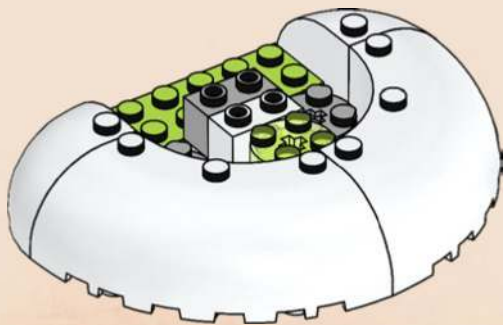



3x

211

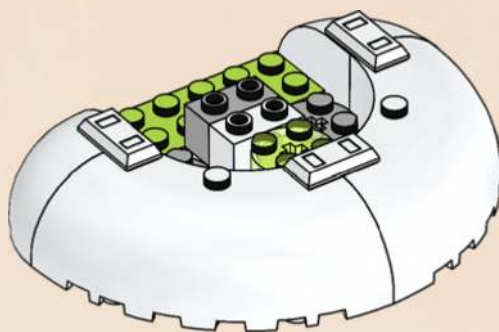

2x

212

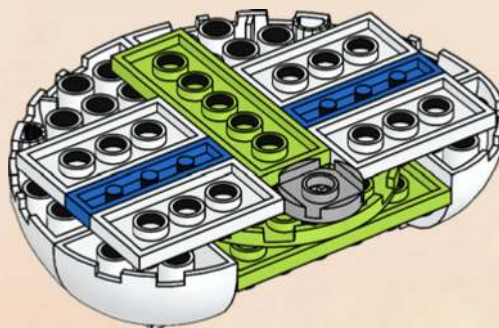

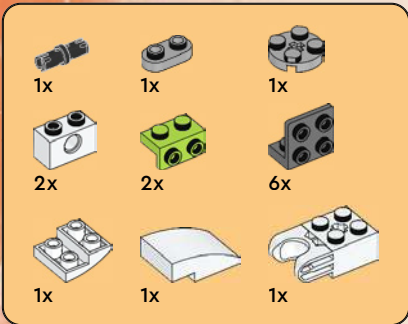

213

1



2



3



4



5

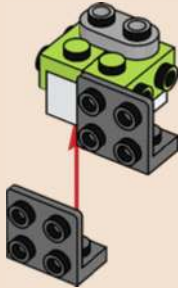

6



7



8

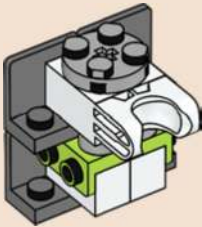

9

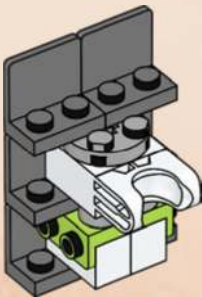

10

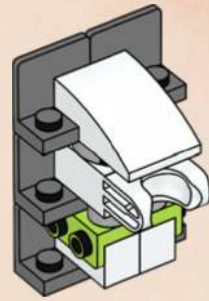

11

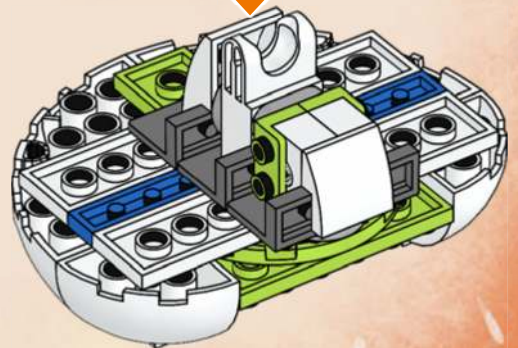
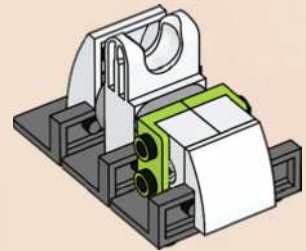
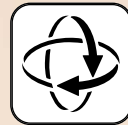



1x



1x

214

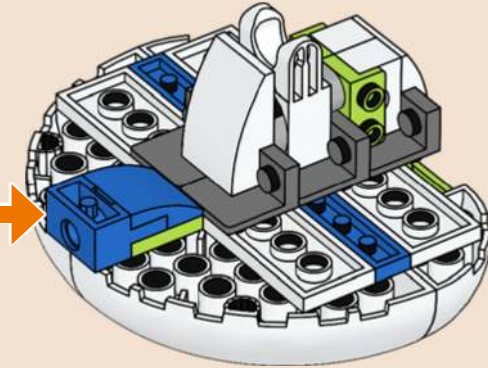
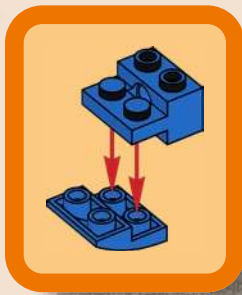

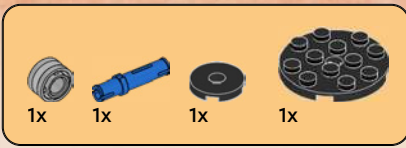

215

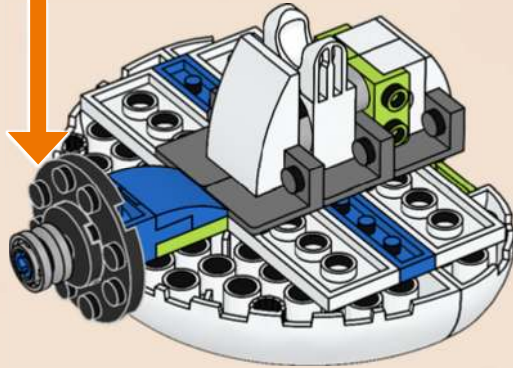
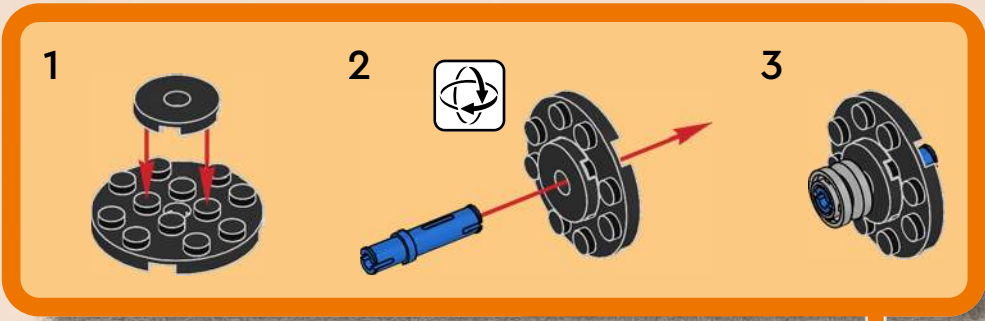

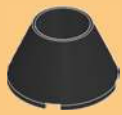

1x

216

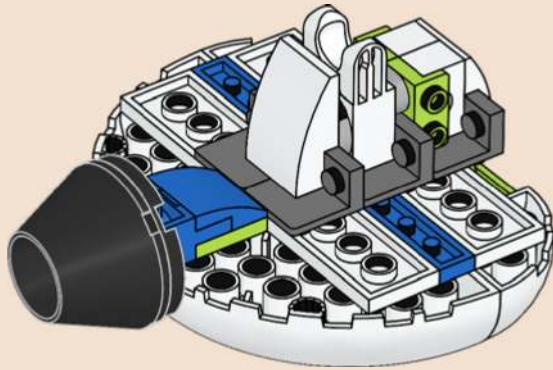

217

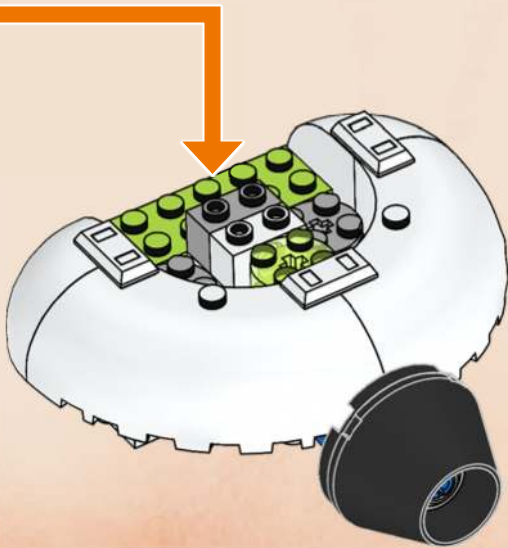
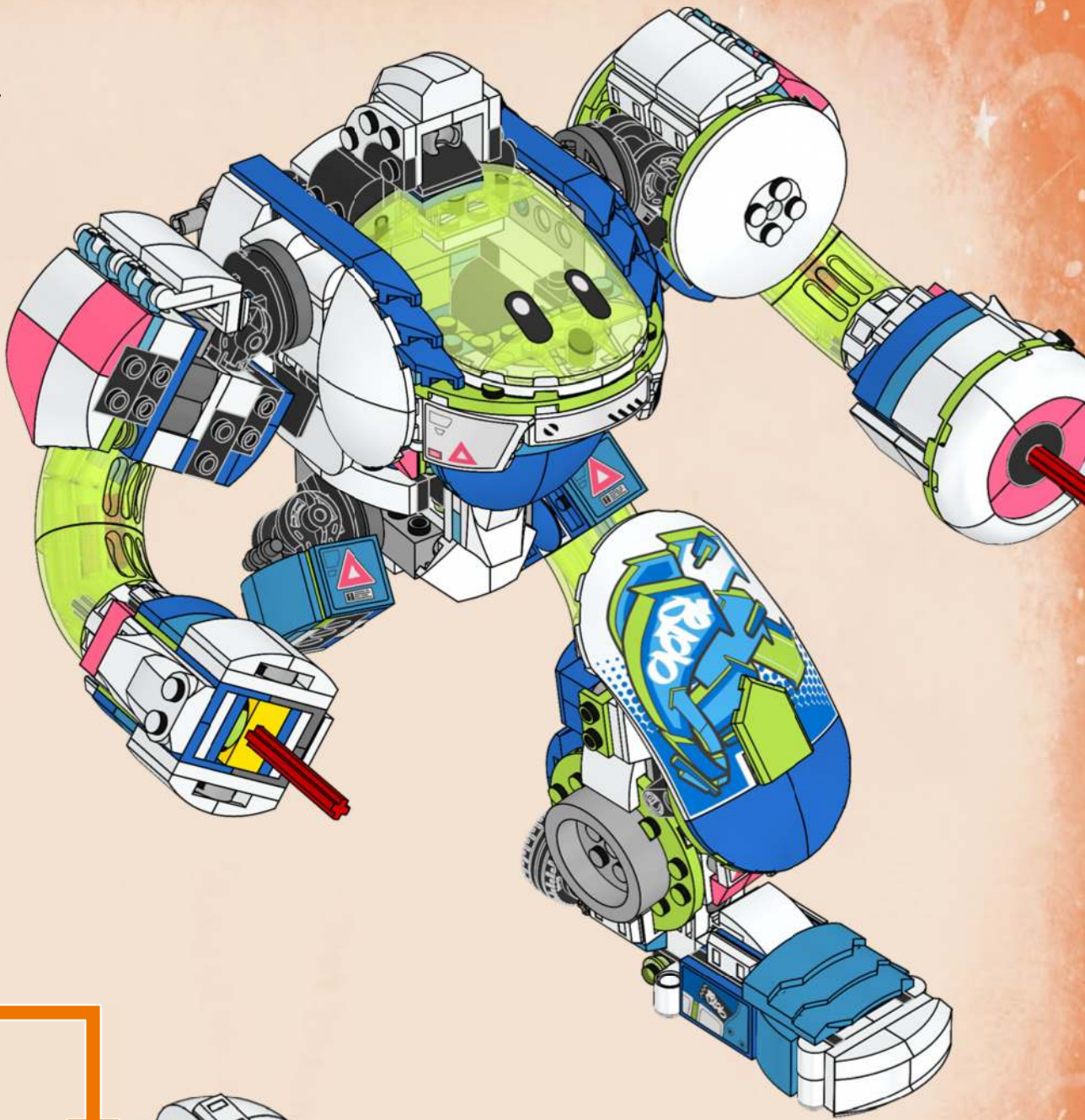



1

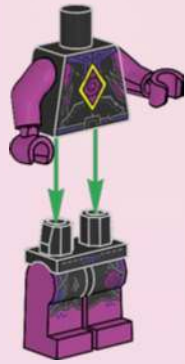



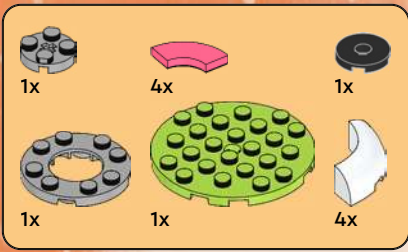

218

1



2



3



4



5

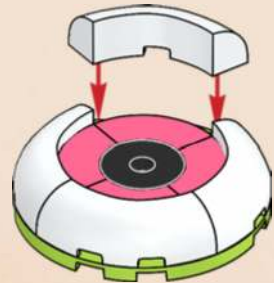

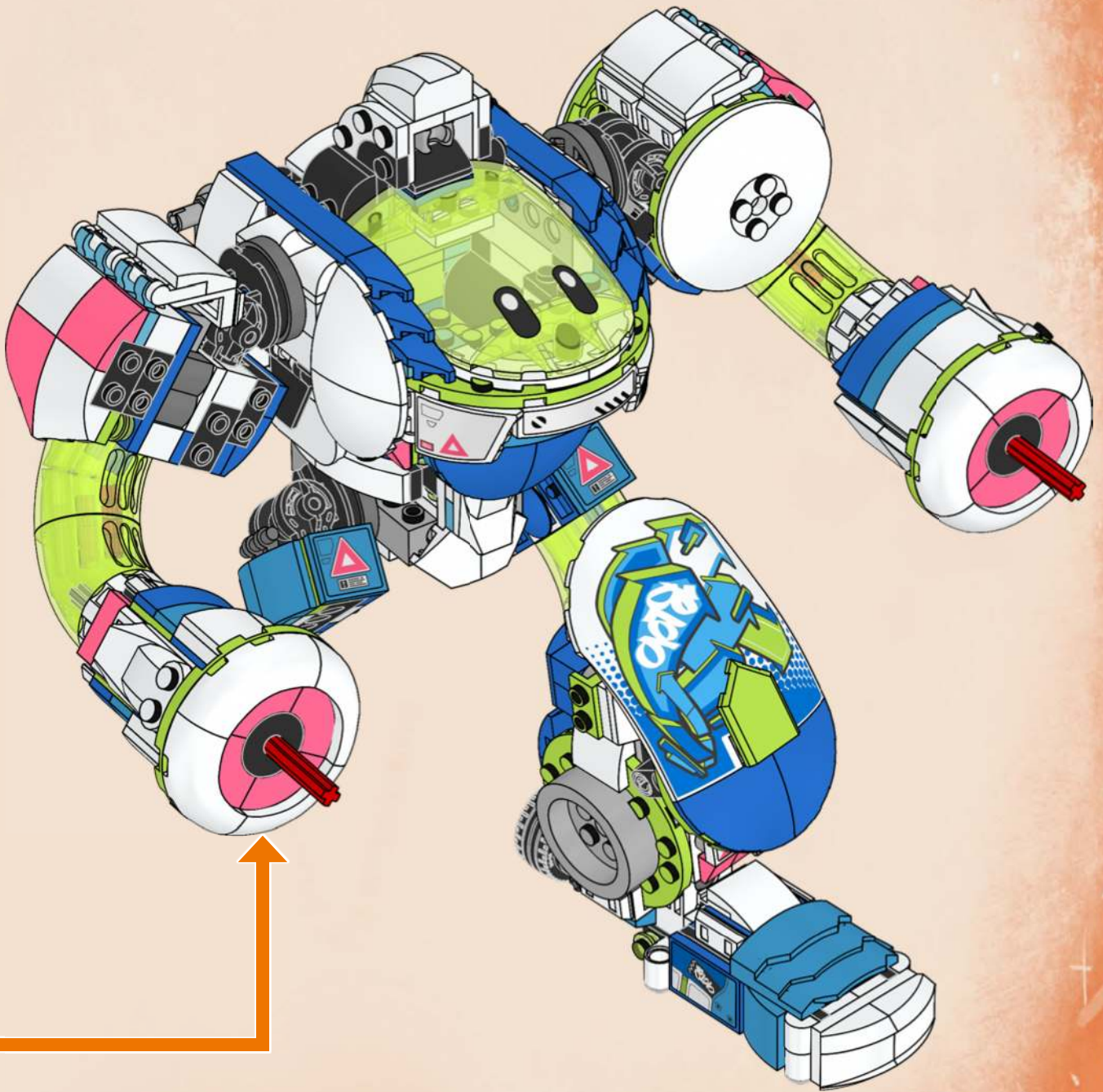

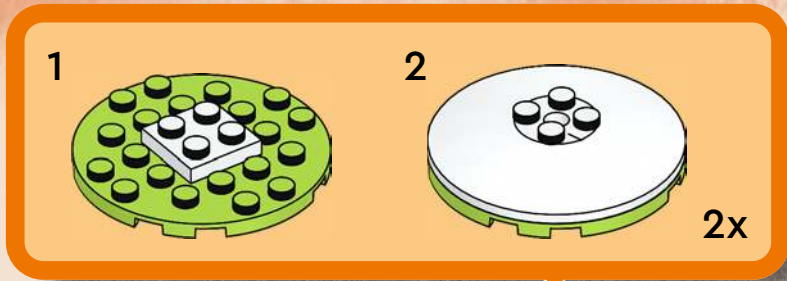
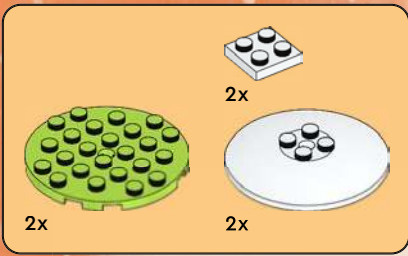

219

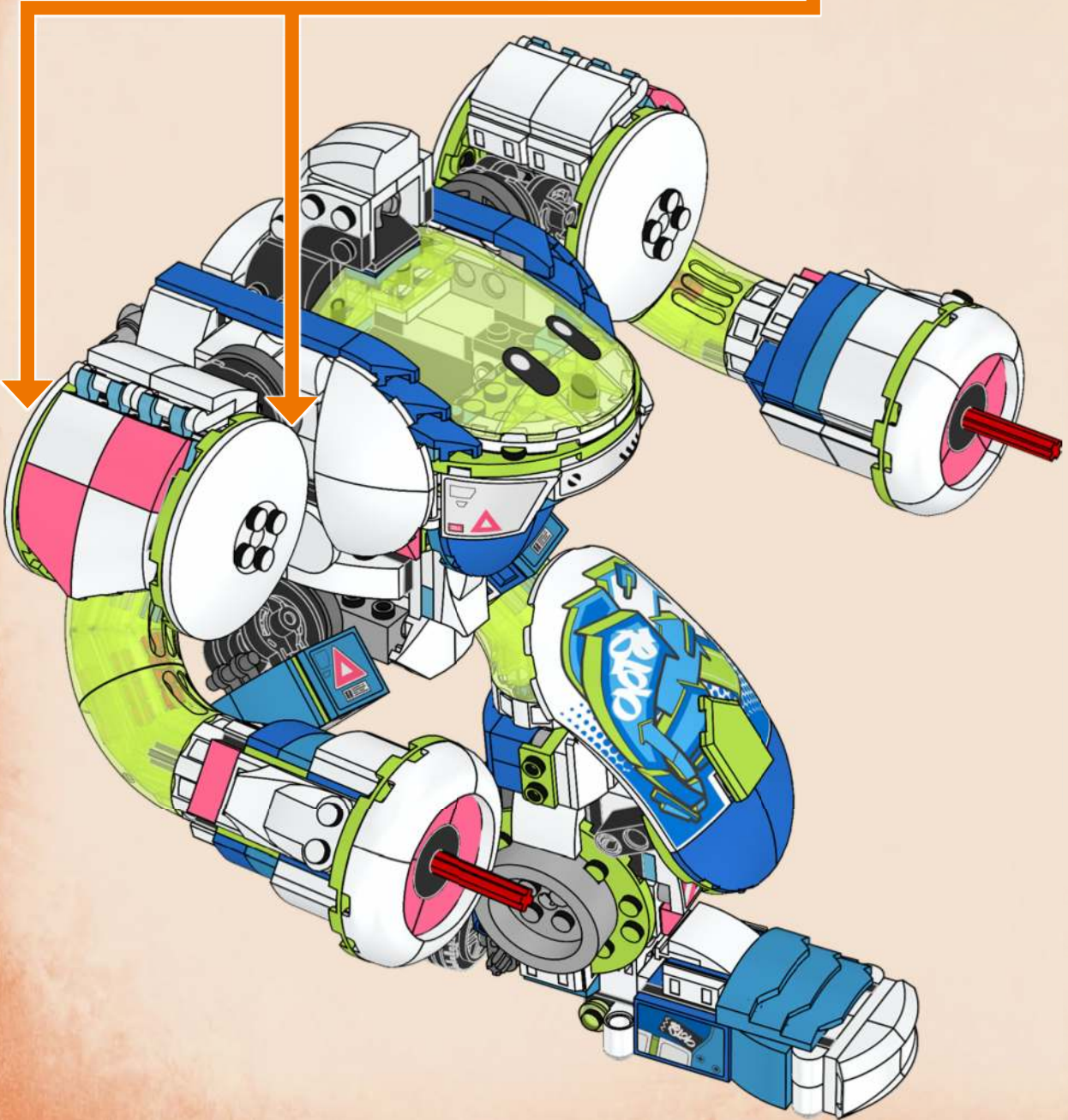

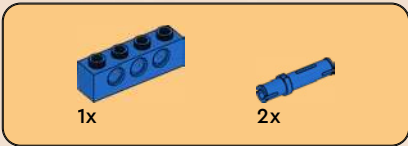
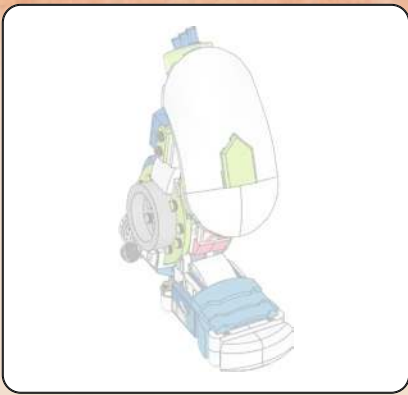

220

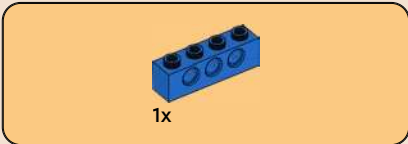
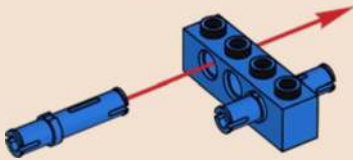

221

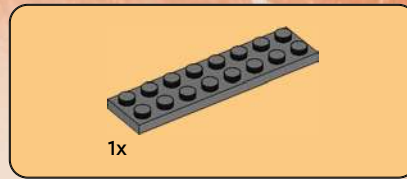

222

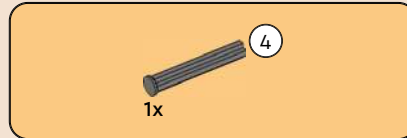
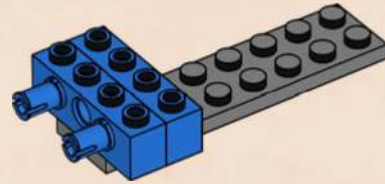

223

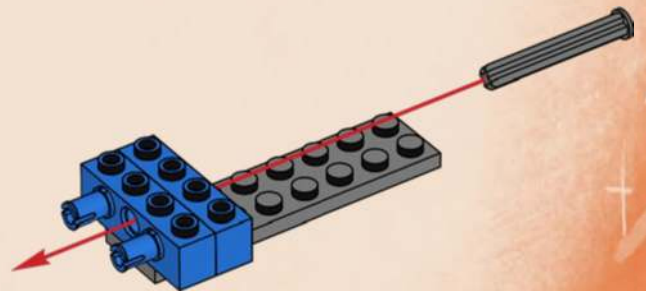

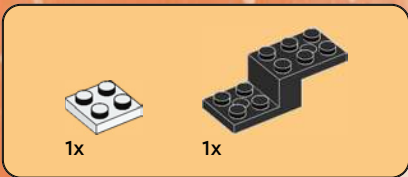

224

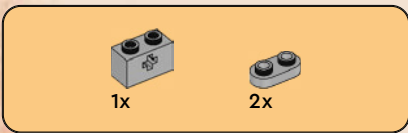
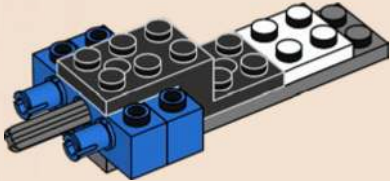

225

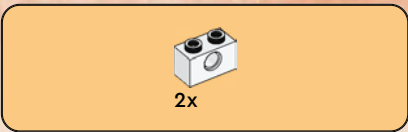
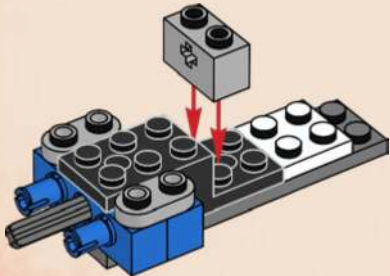

226

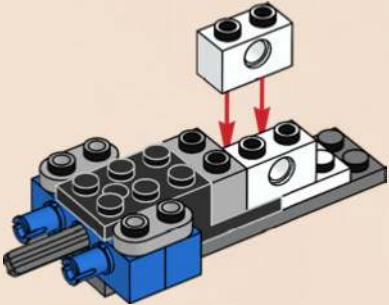

227

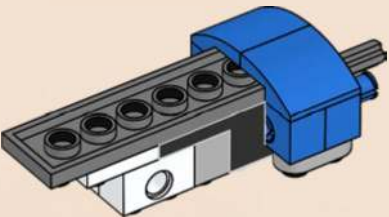

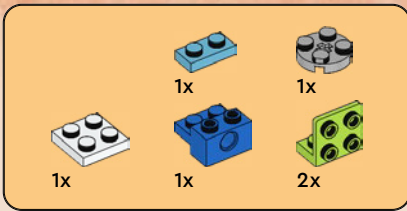

228

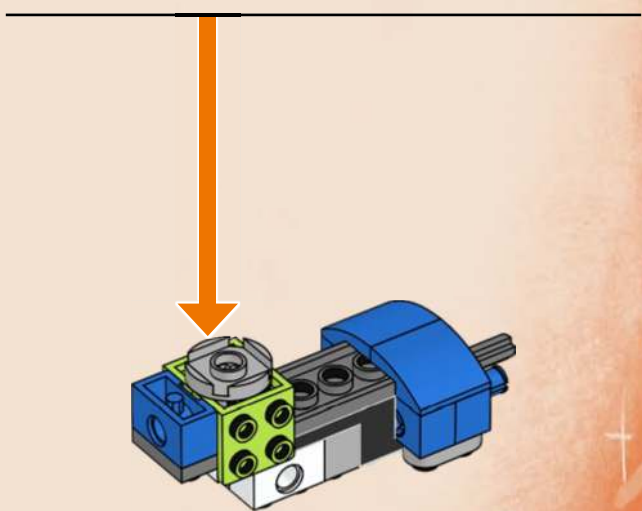
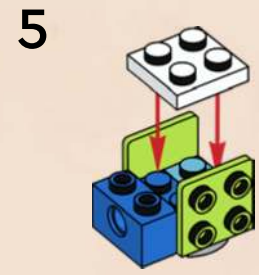
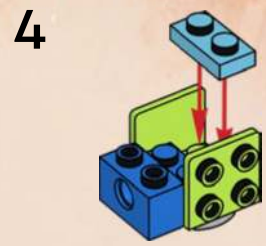
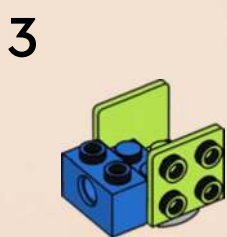
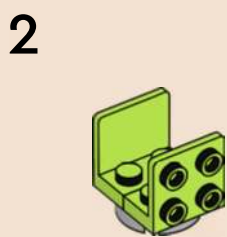
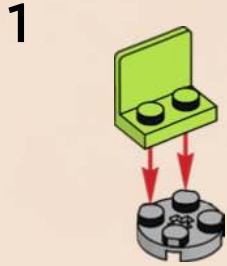



1x

229

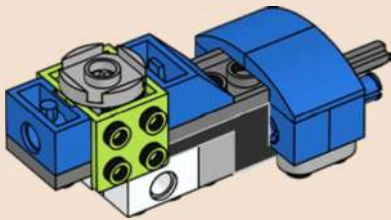

2x

230

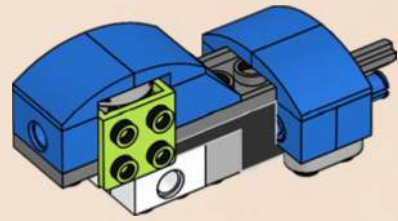

1x



2x



1x

231

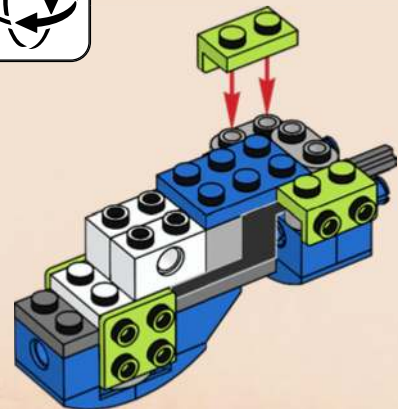

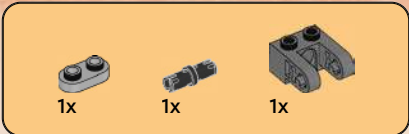

232

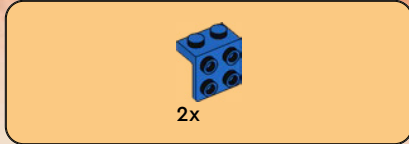
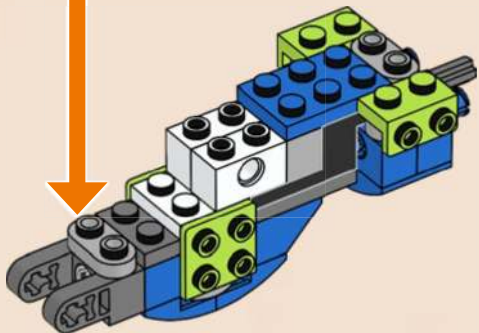
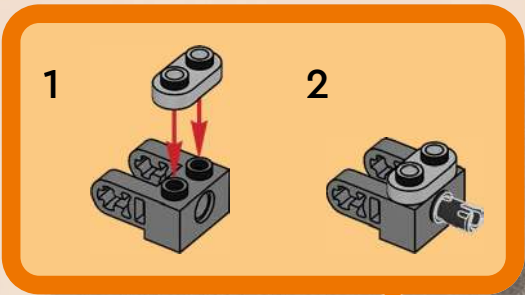

233

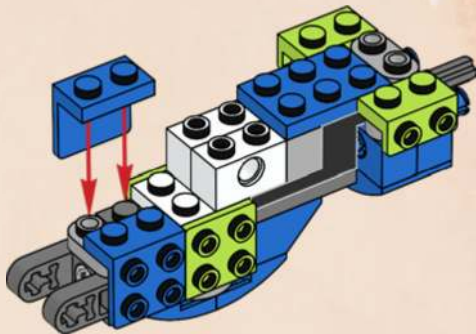

234

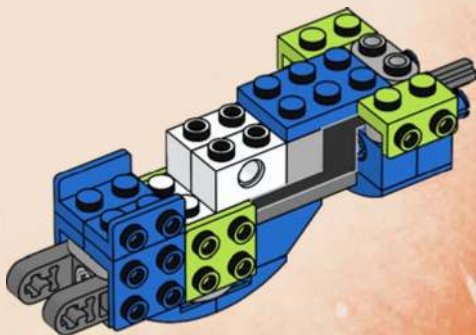



1x

235

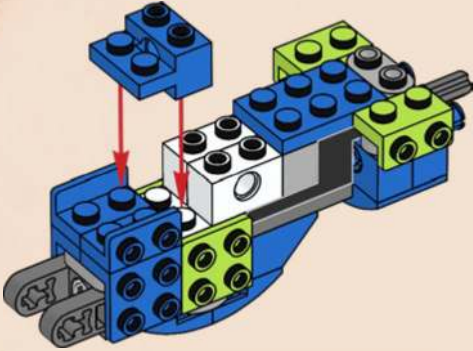

1x

236

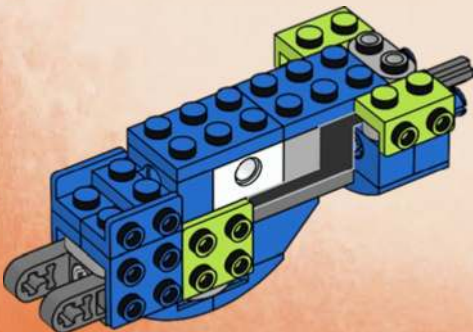

1x



2x



2x

237

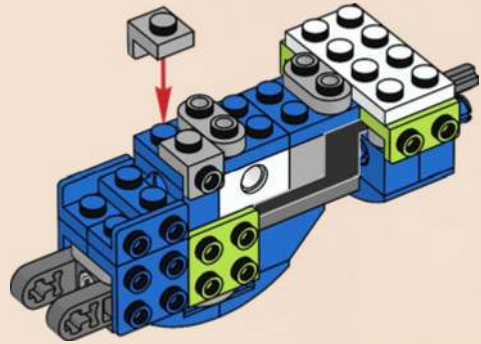

2x

238

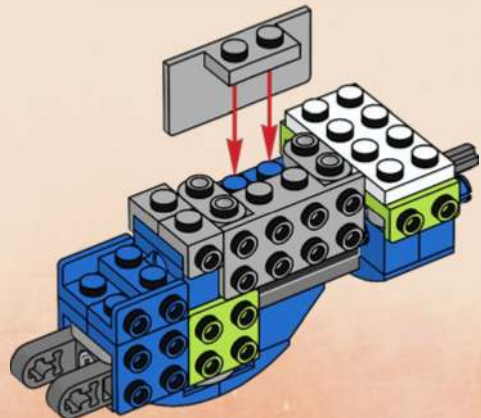



1x

239

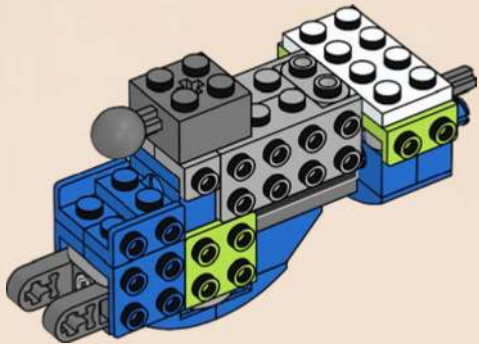

2x

241

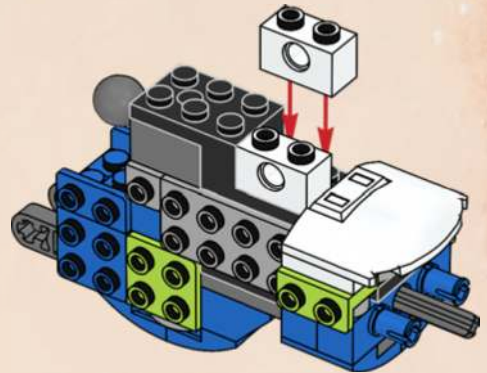

1x

1x

1x

240

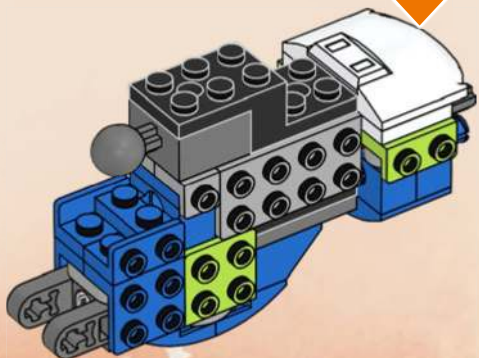
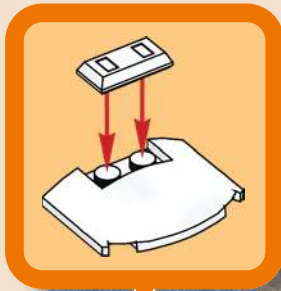

1x



2x

242

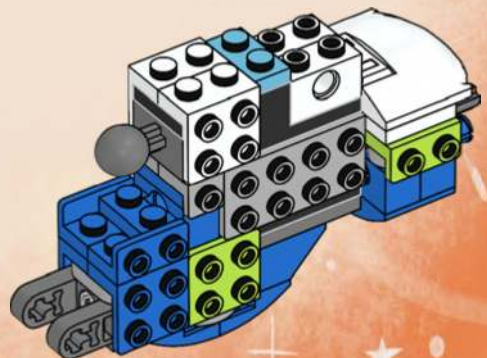



1x



2x

243

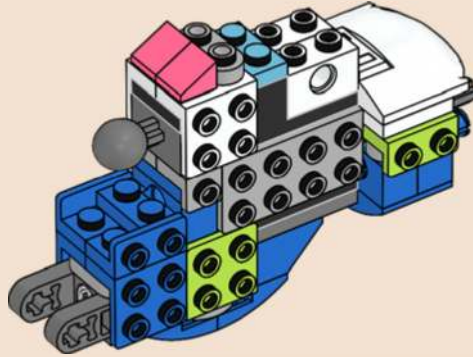

1x

244

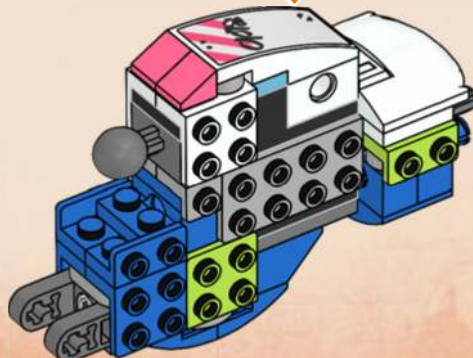
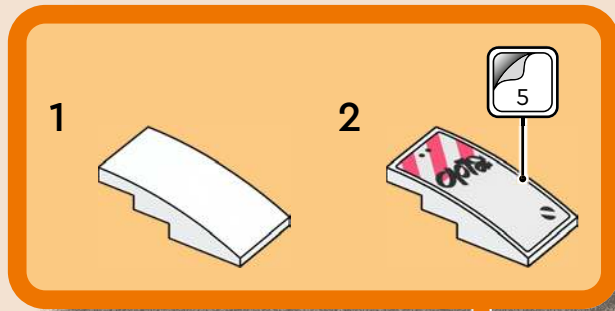

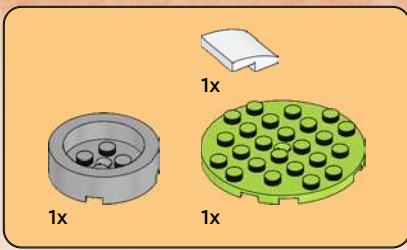

245

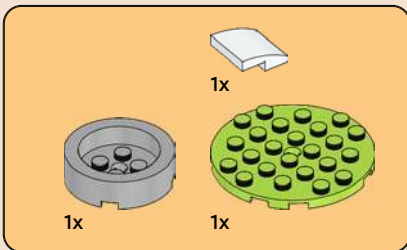
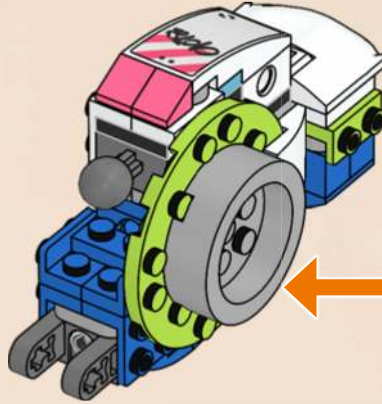
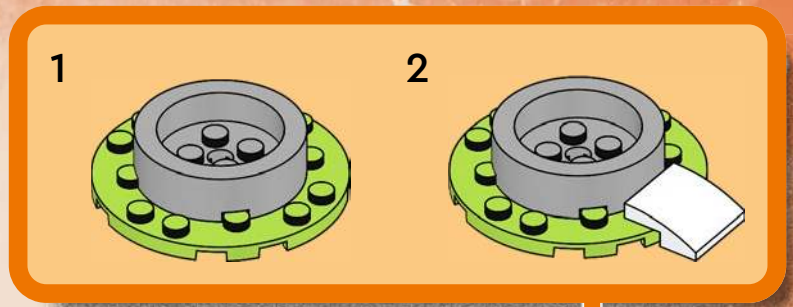

246

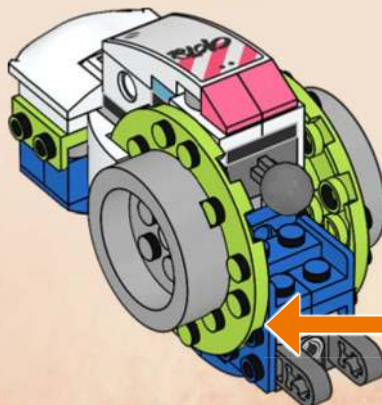
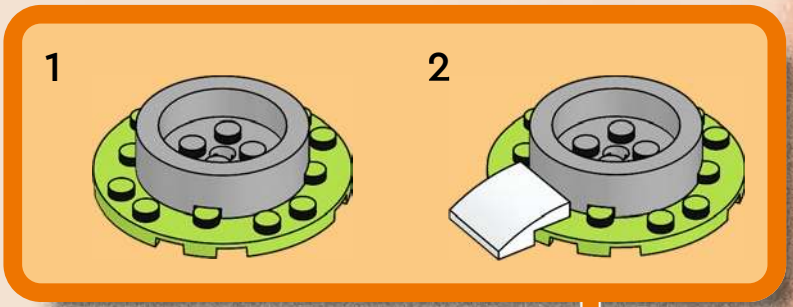



2x



2x

247

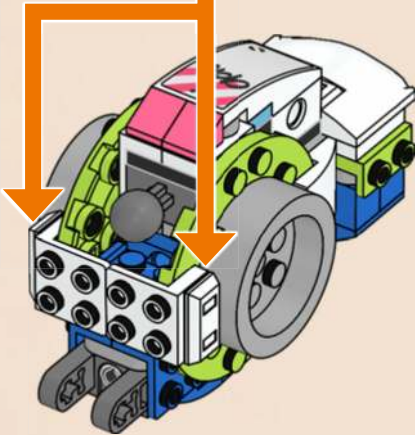
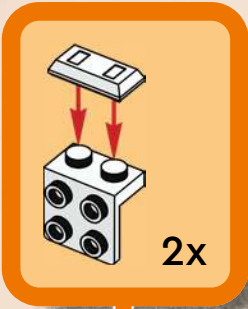

1x

248

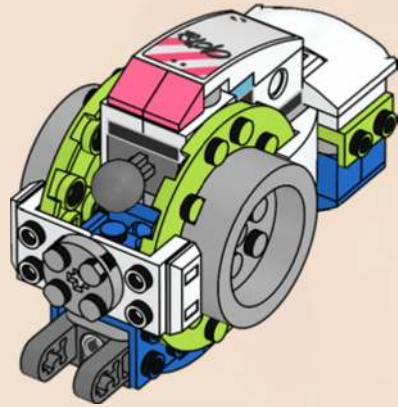

2x

249

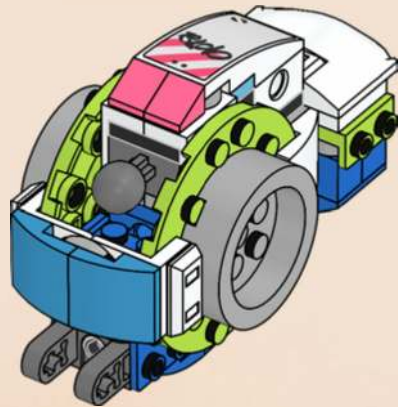

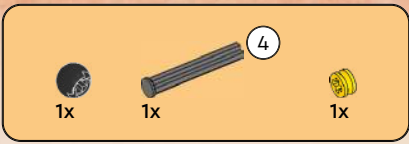

250

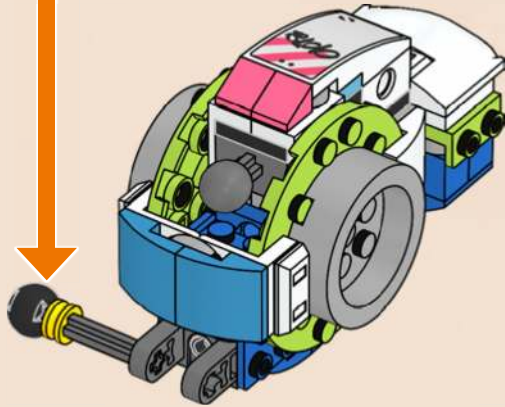
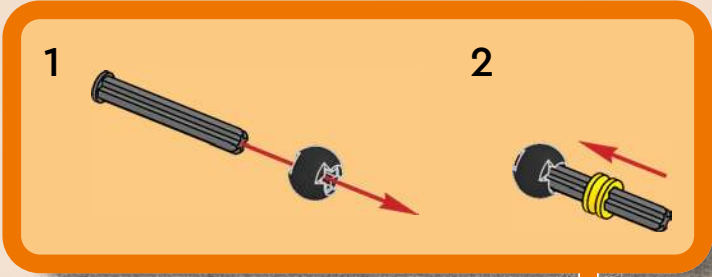



251

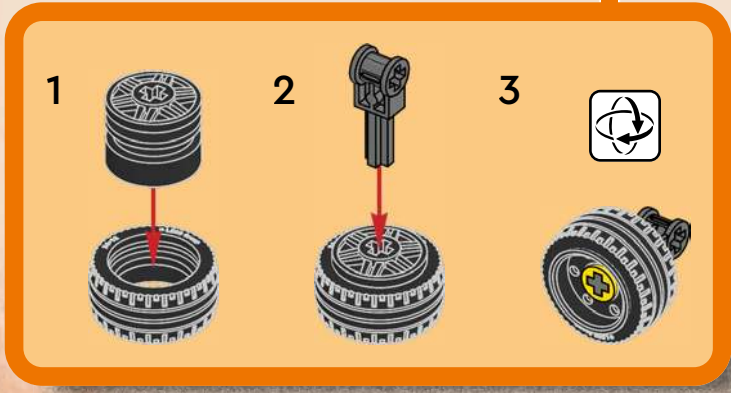
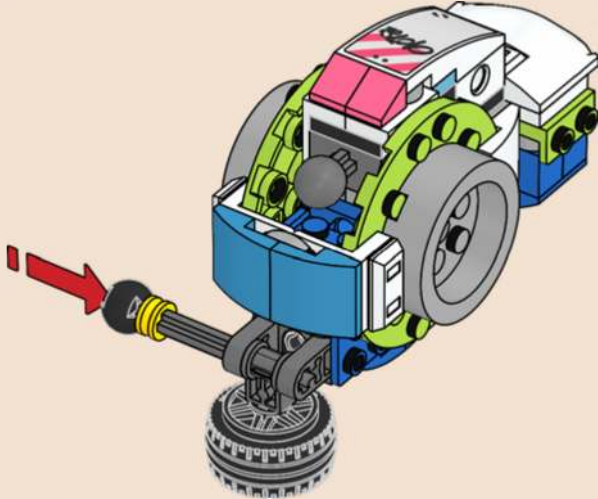



252

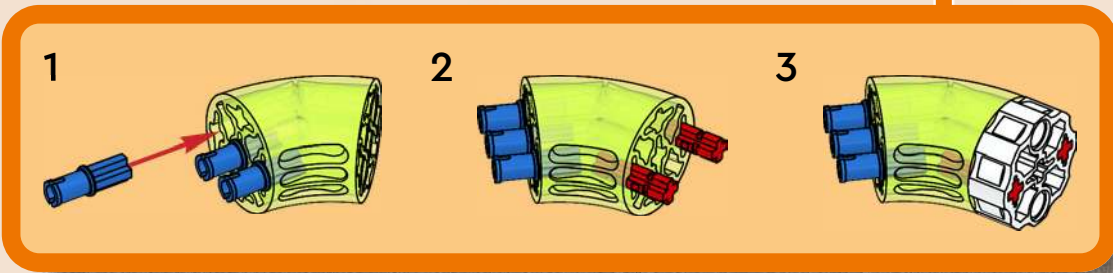
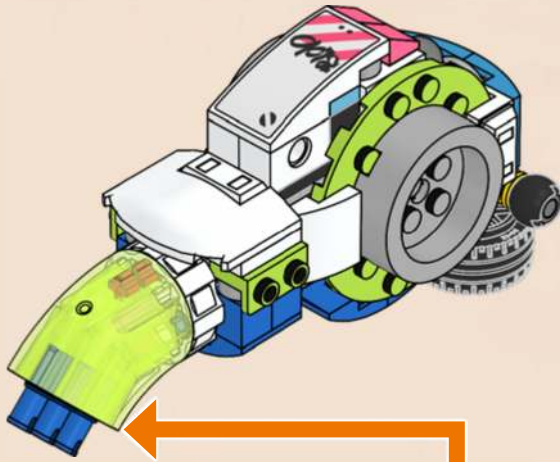

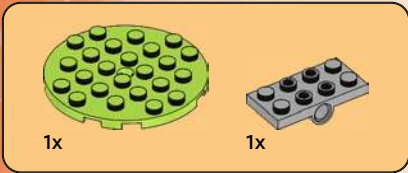

253

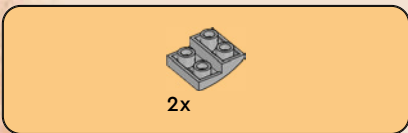
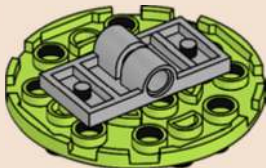

254

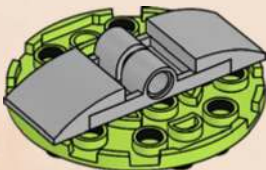

255



256

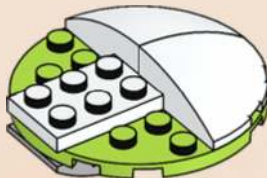



257

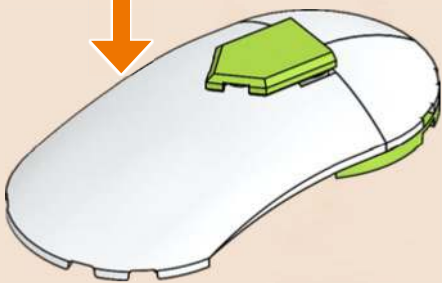
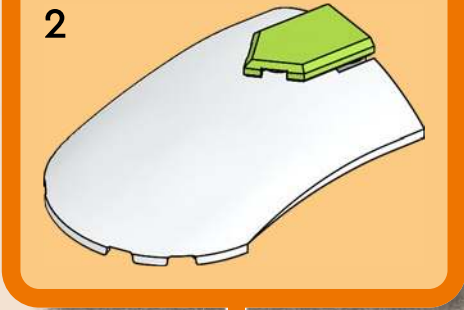
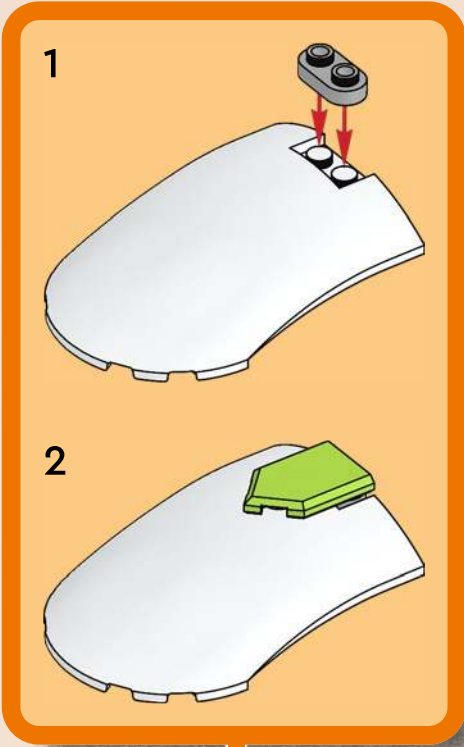

258

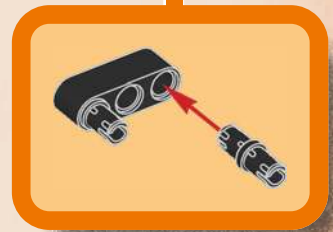
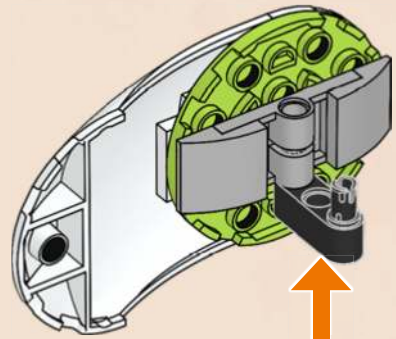

259

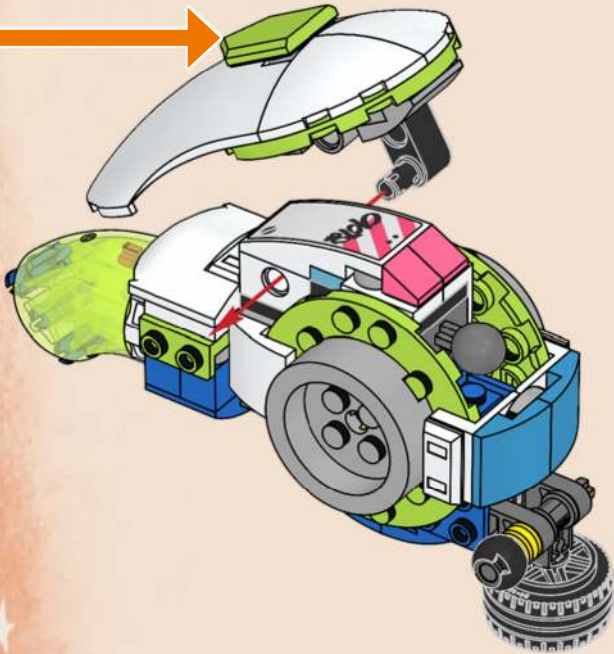

260

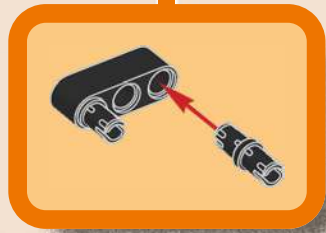
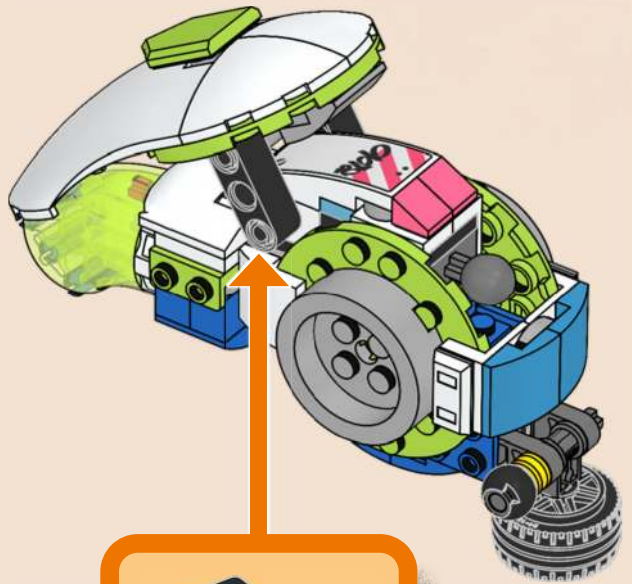

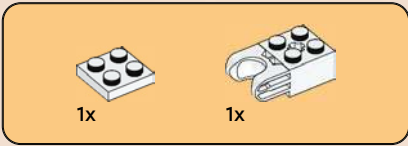
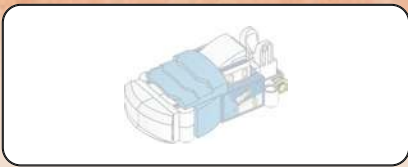

261

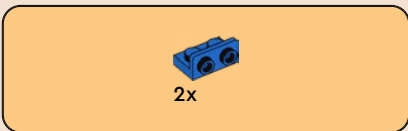
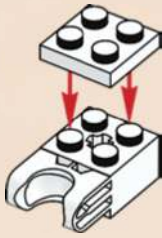

262



263

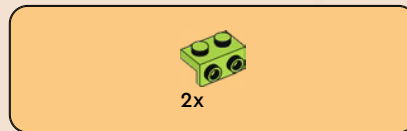

264





2x

265



1x



1x

266



1x



1x

267

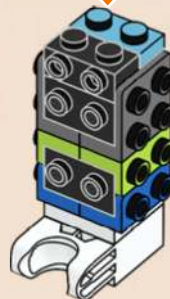
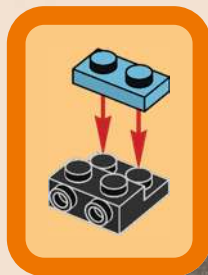

1x



1x

268





269



270

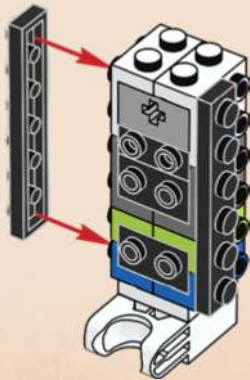

271

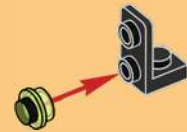
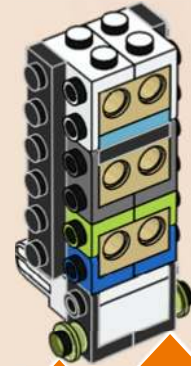
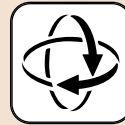

2x



4x

272

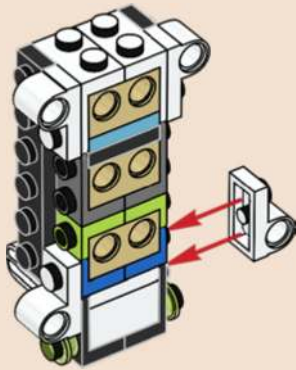

4x

273

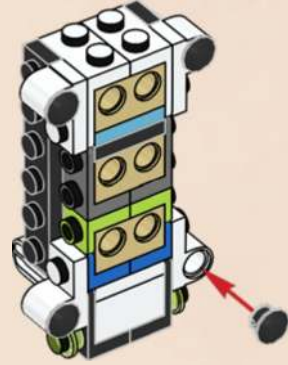

2x

274

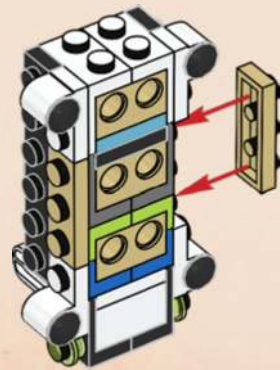



275

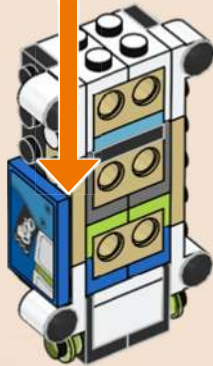
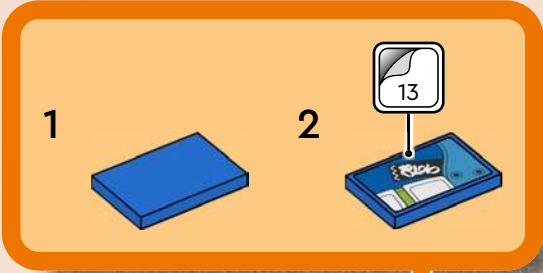

276

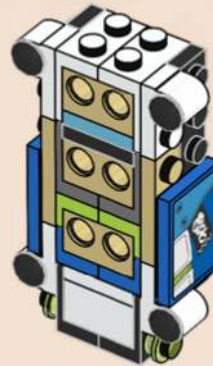
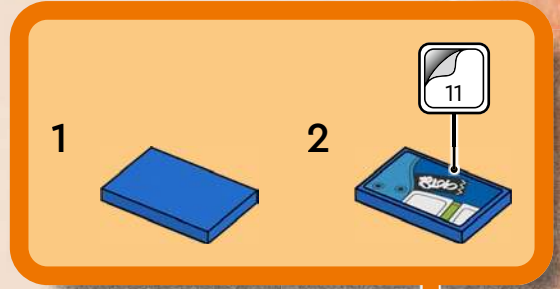

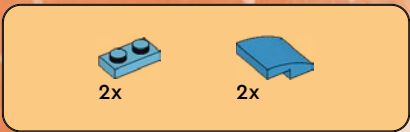

277

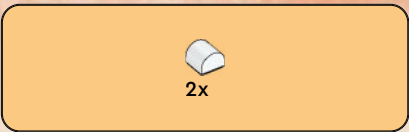
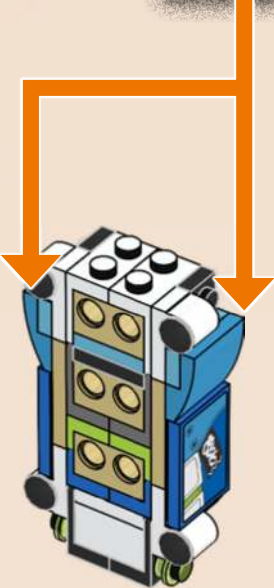
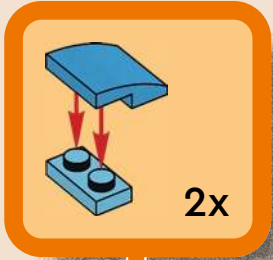

278

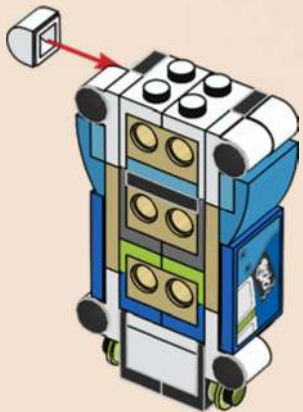

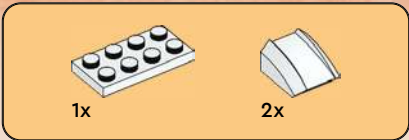

279

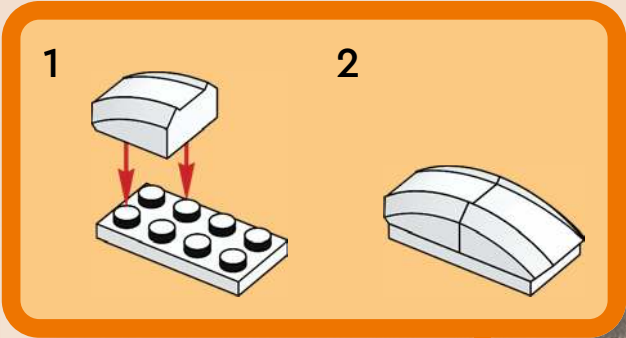

280

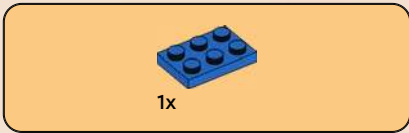
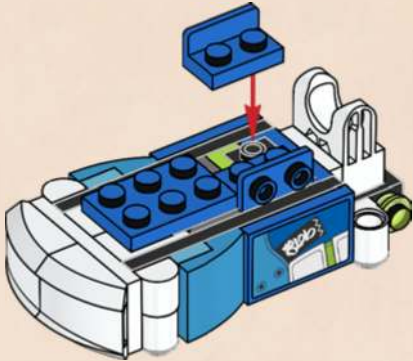

281

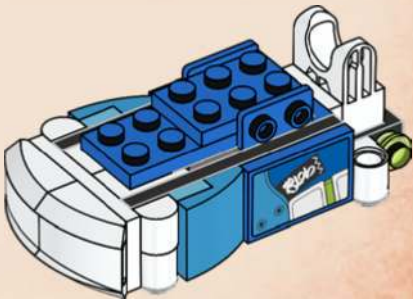



1x



1x

282

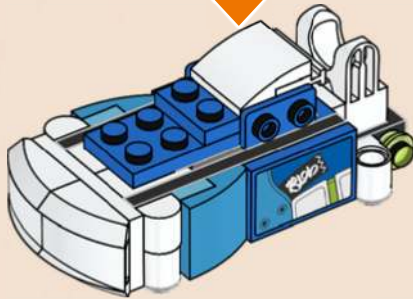

2x

283

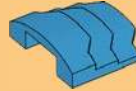
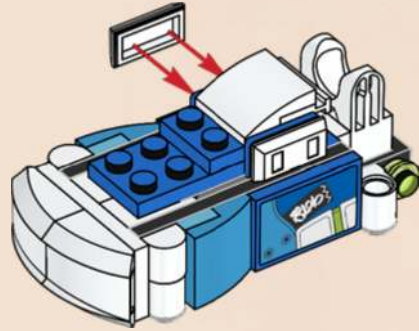

1x

284

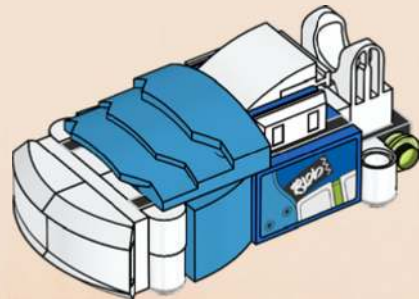

285

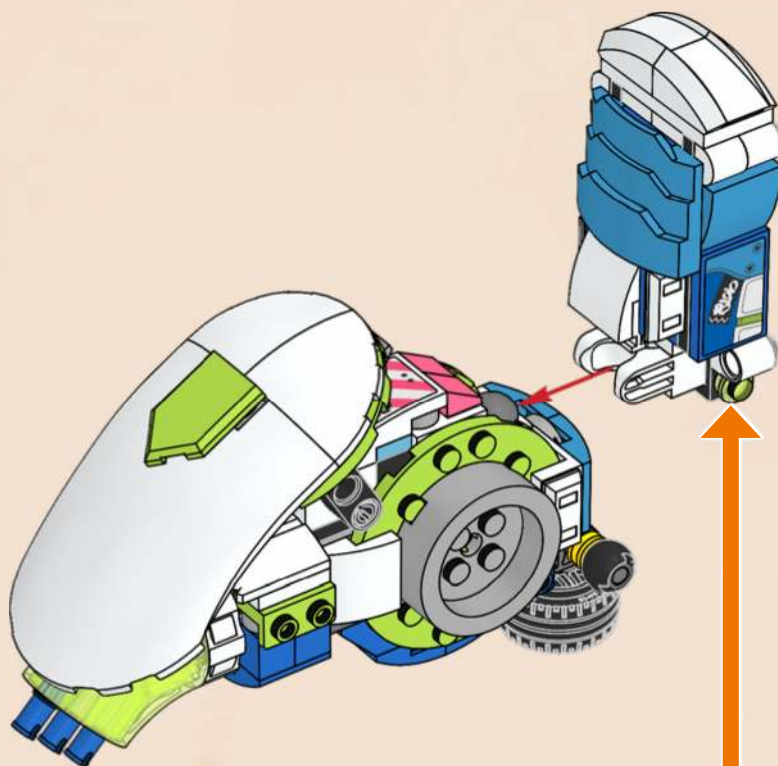



286

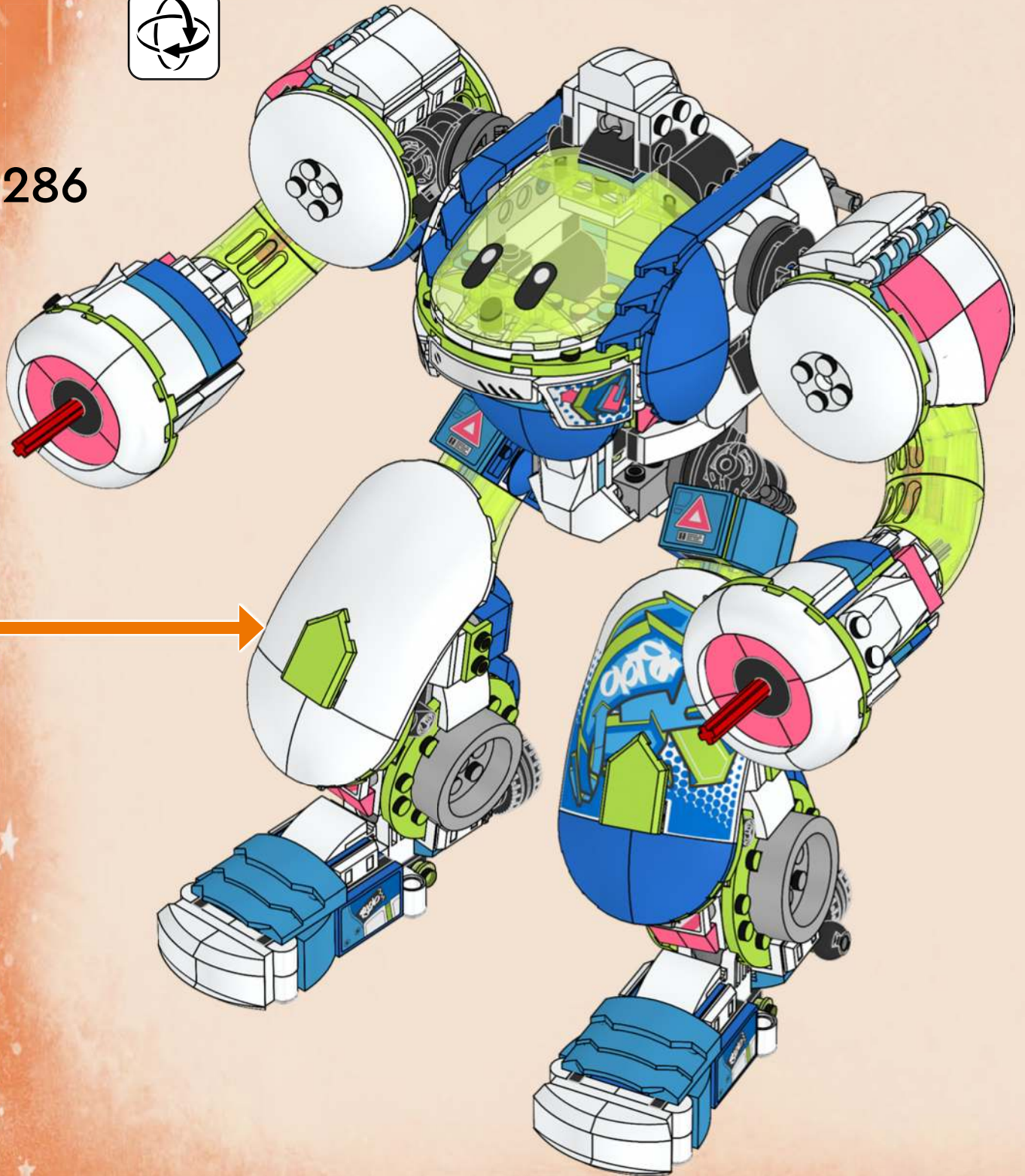



1x



1x

291

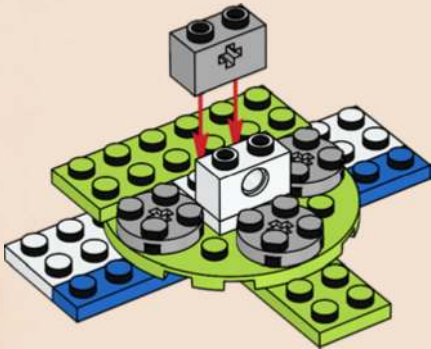

1x

292

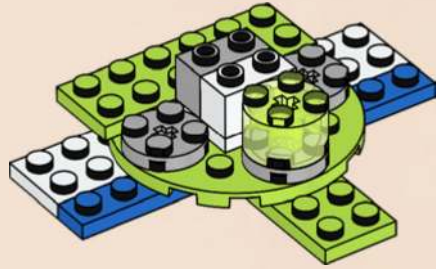

2x

293

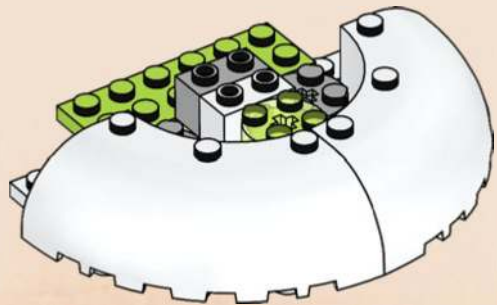



2x

294

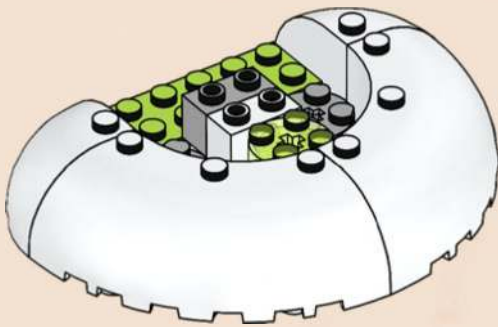

3x

295

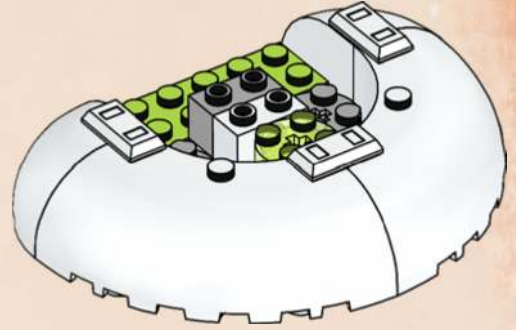

2x

296

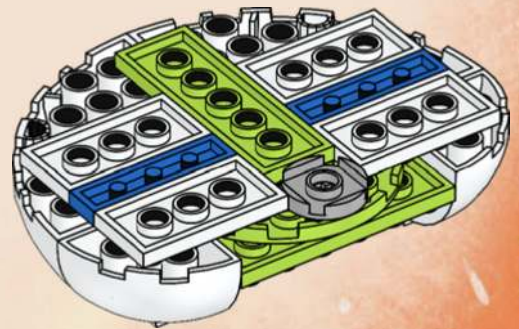

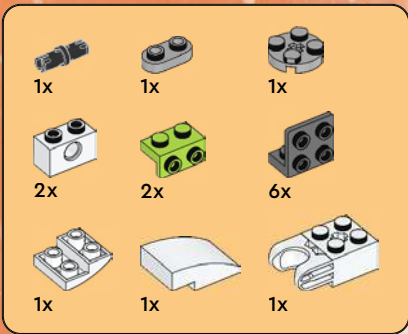

297

1

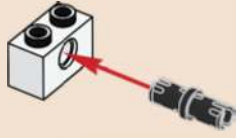

2



3



4



5

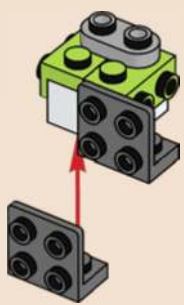

6



7



8

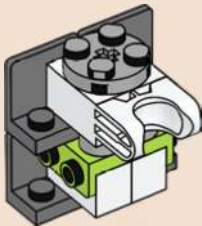

9

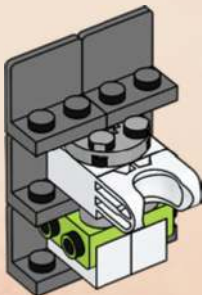

10

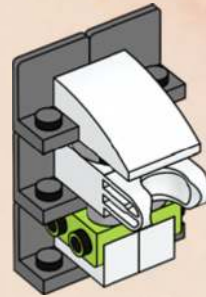

11

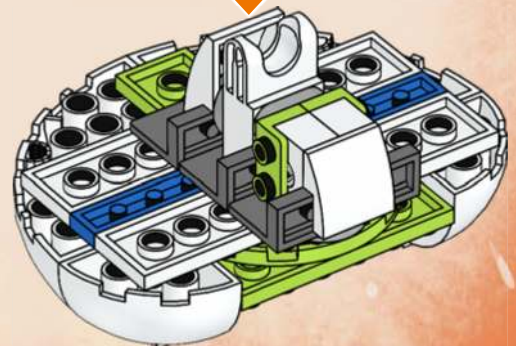
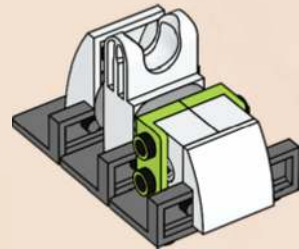



1x



1x

298

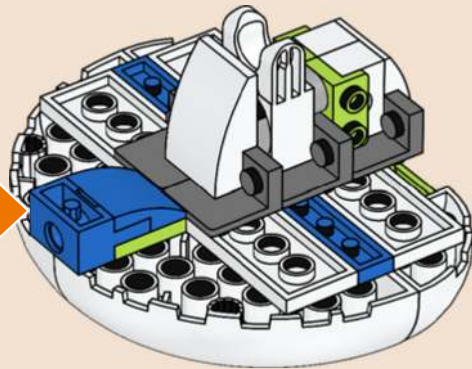
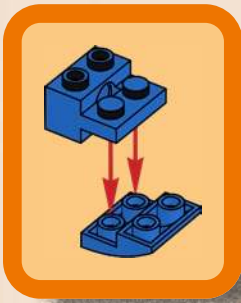

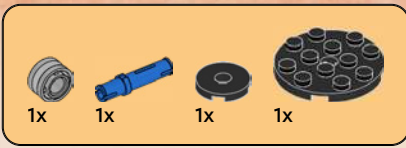

299

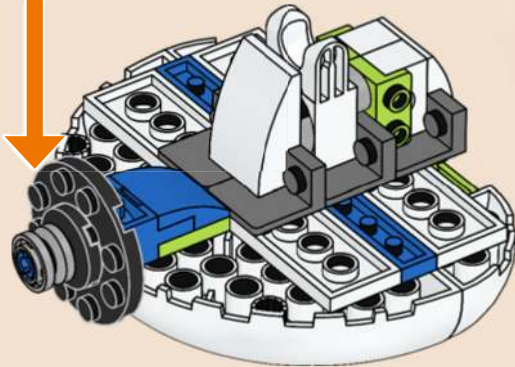
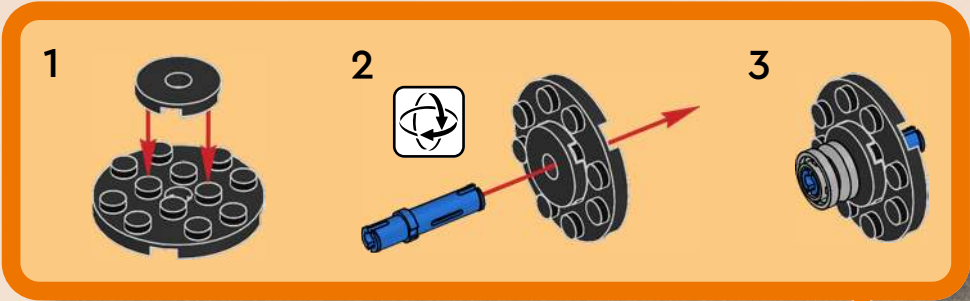

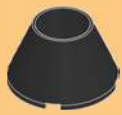

1x

300

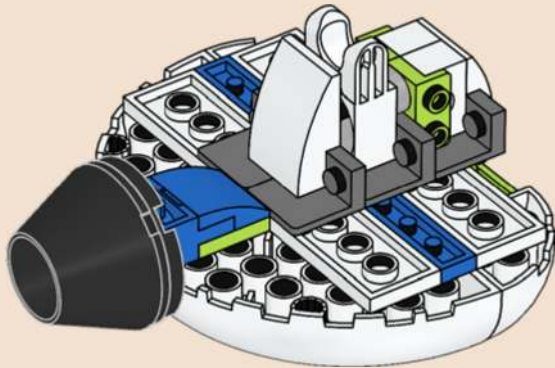

301

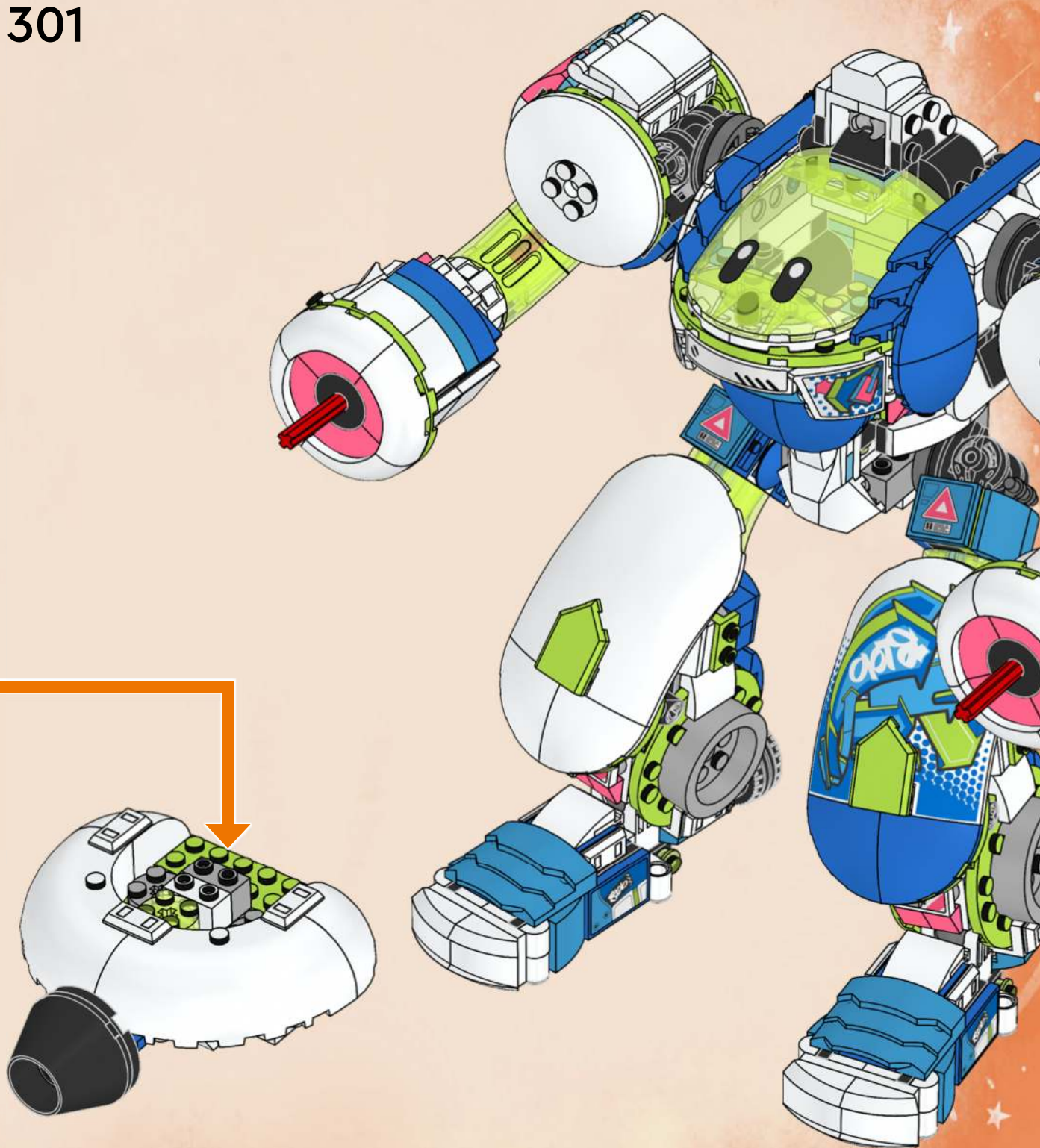



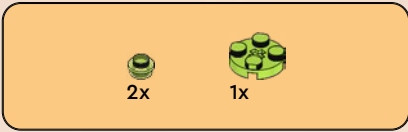

302



303

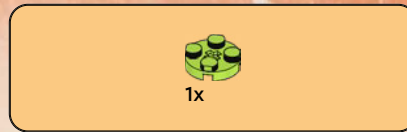

304

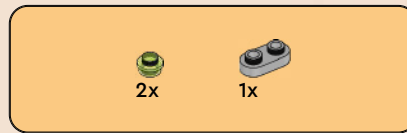

305





1x

306



1x



1x

308

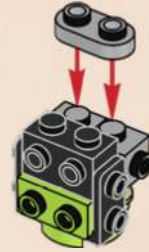

2x

307



2x



1x

309





1x

310



2x

312



2x

311



1x



1x

313

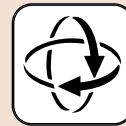



1x



1x

314

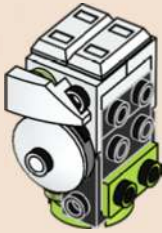

1x



1x

315



1x



1x

316

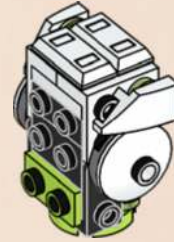

1x



1x

317





1x

318



319

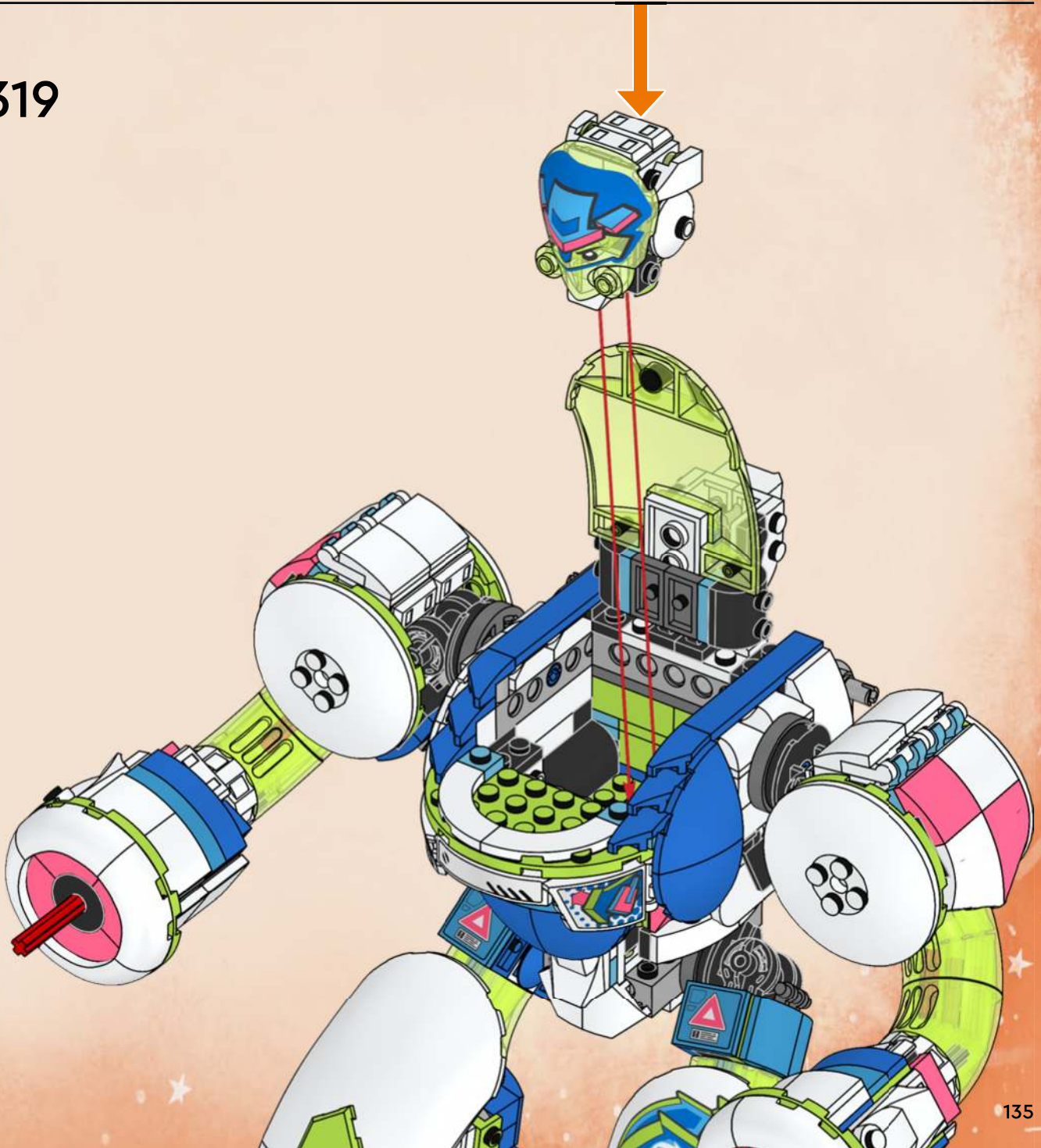

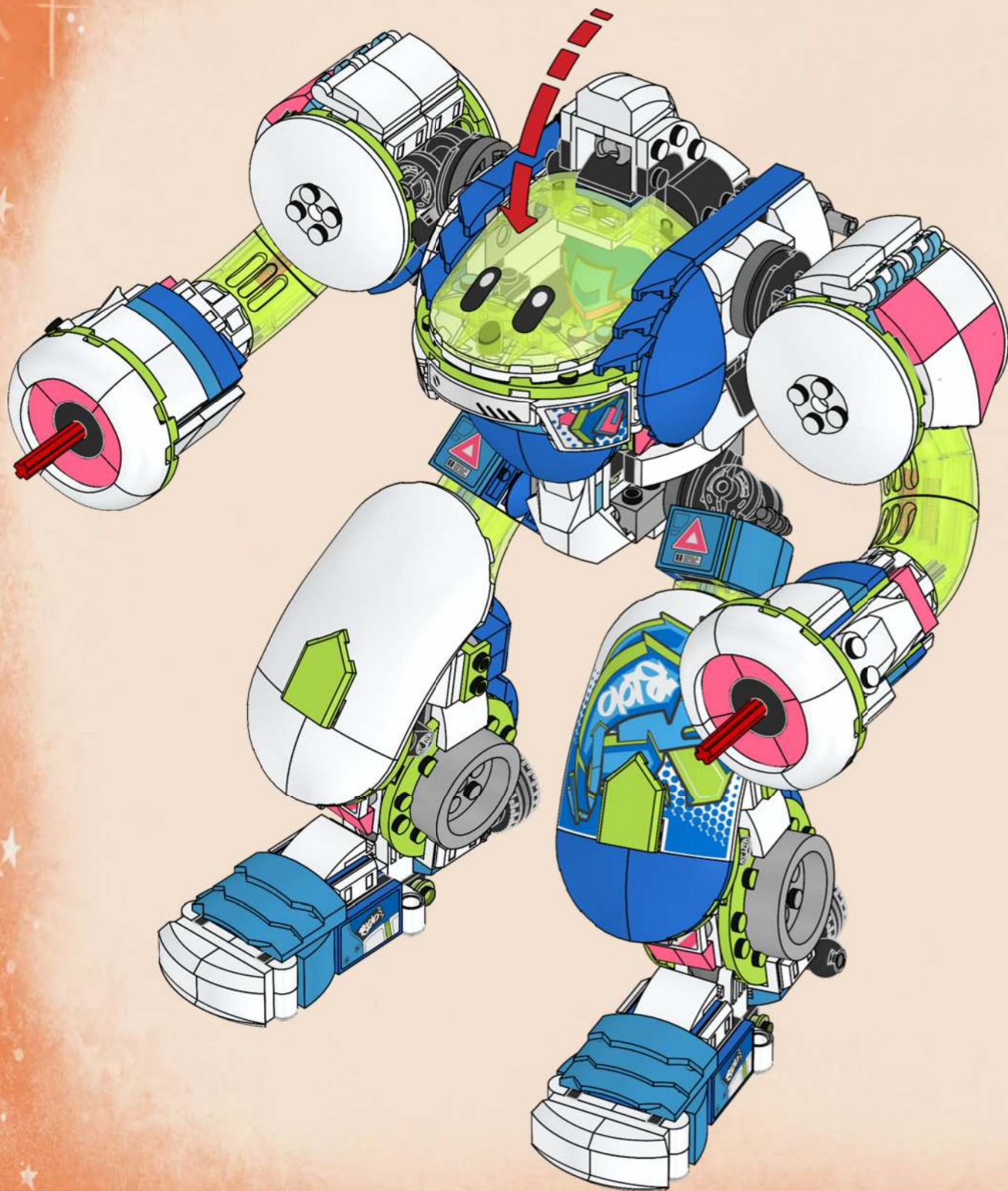



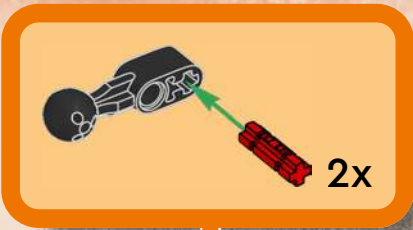
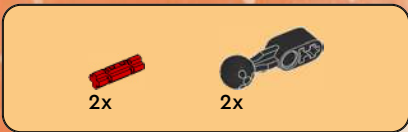

321

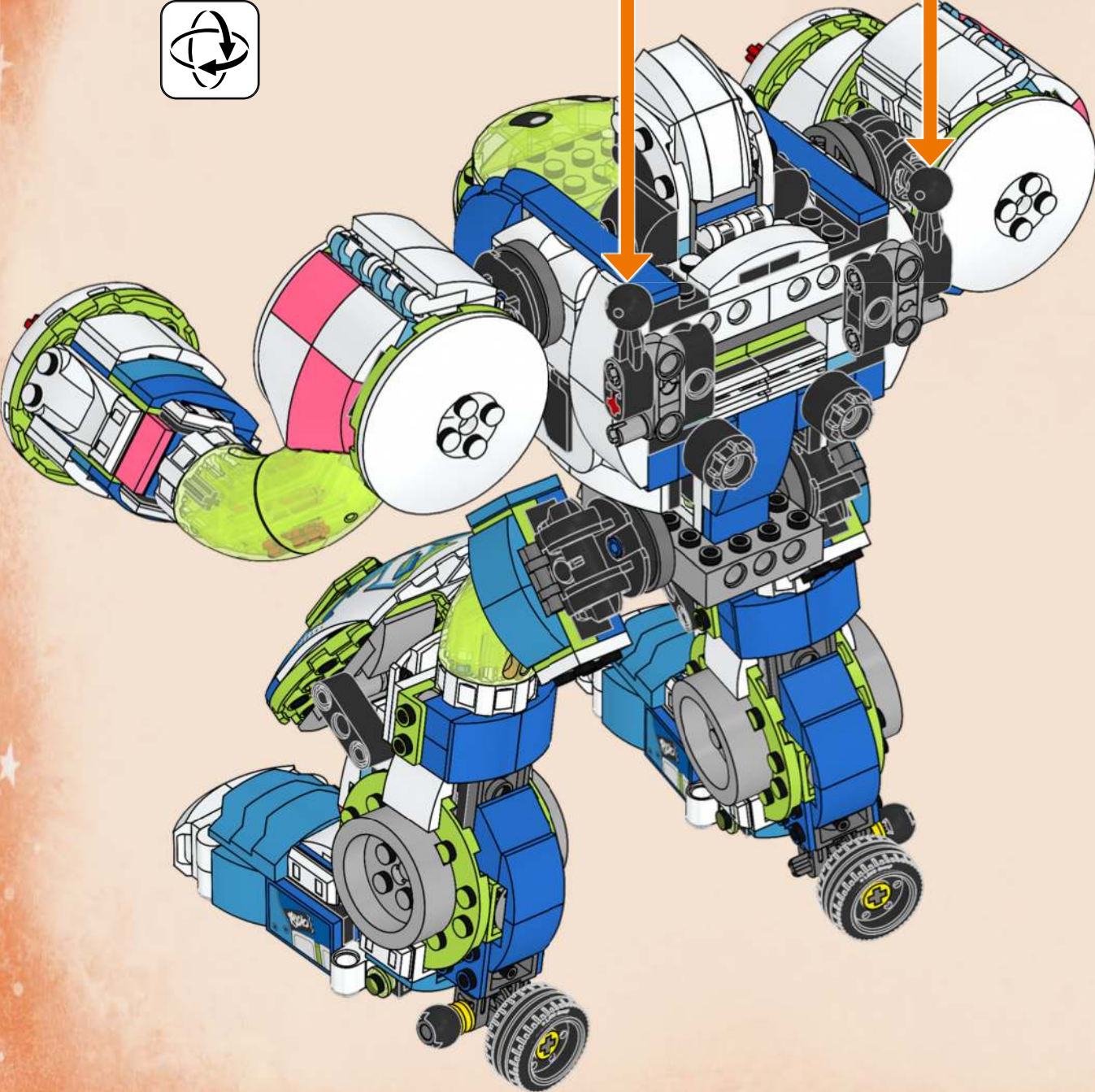



2x

322

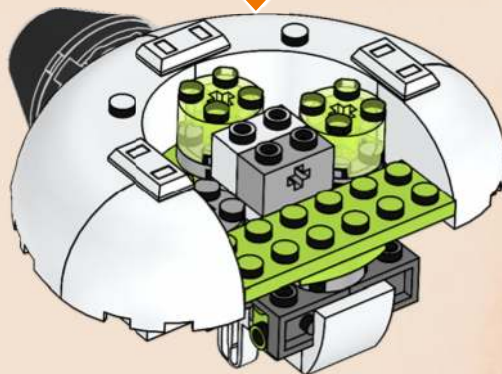
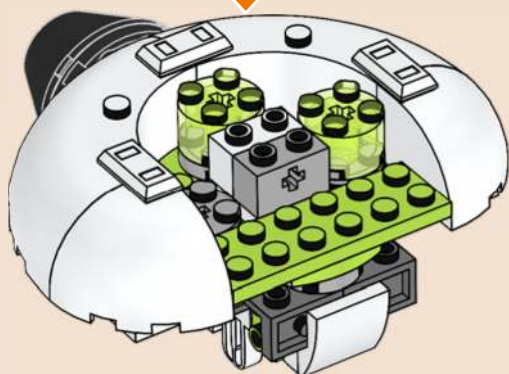
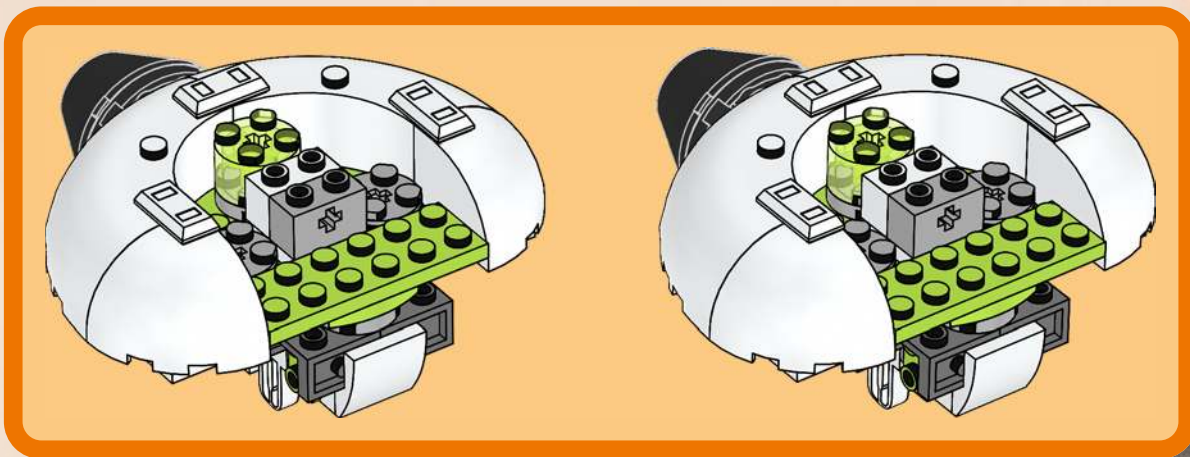



2x



2x

323

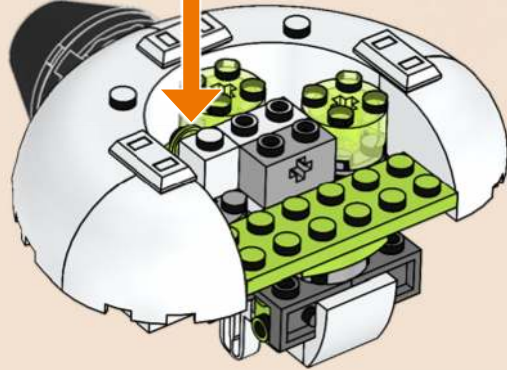
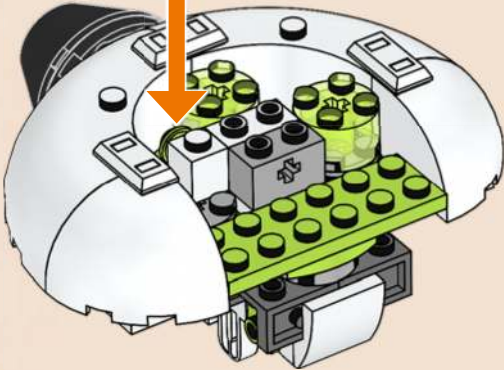



2x

324



2x

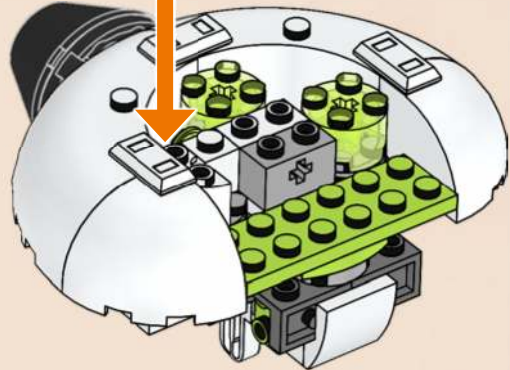
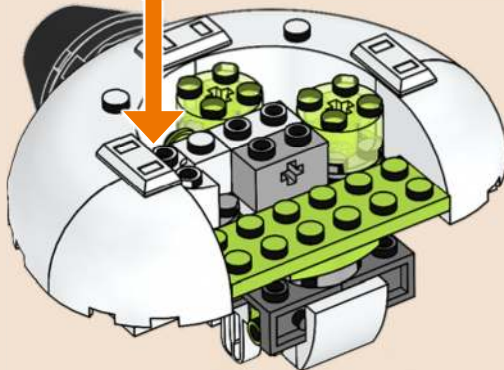



2x

325

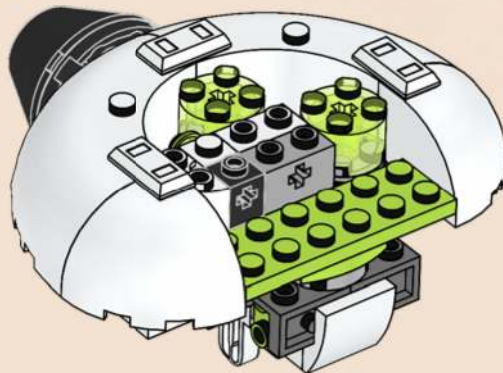
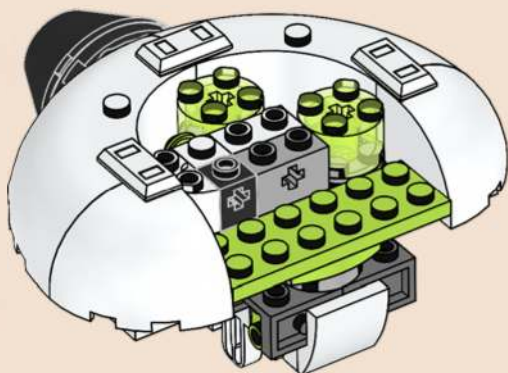



2x



4x

326

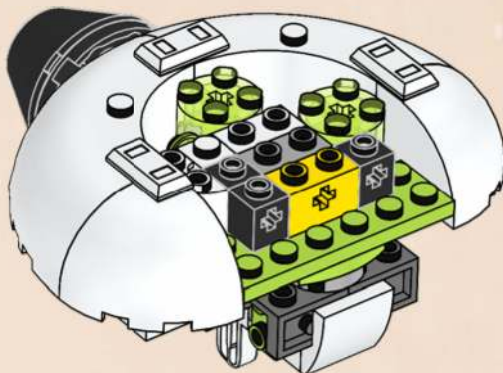
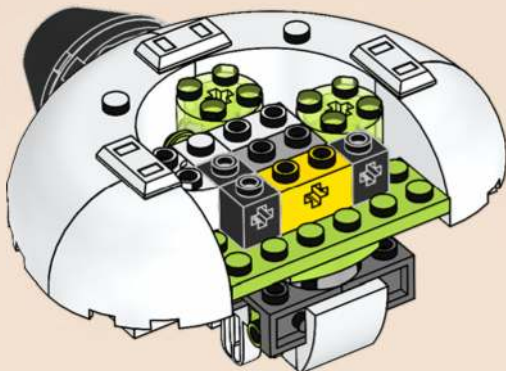

2x



4x

327

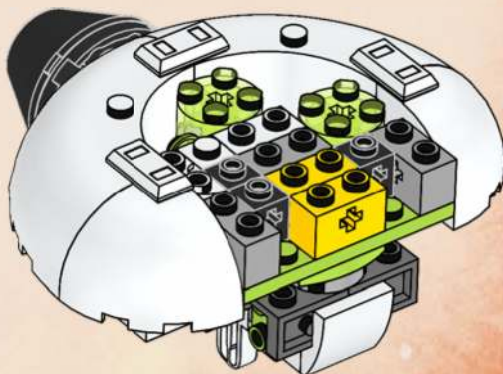
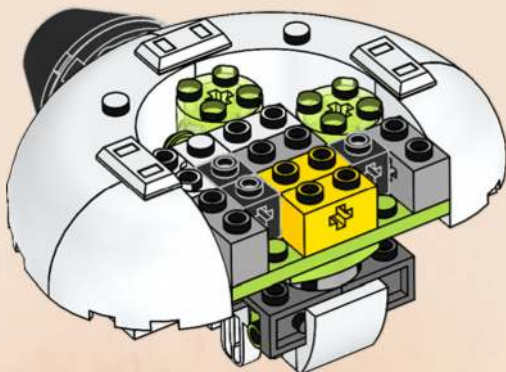

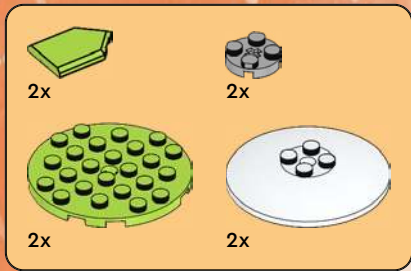

328

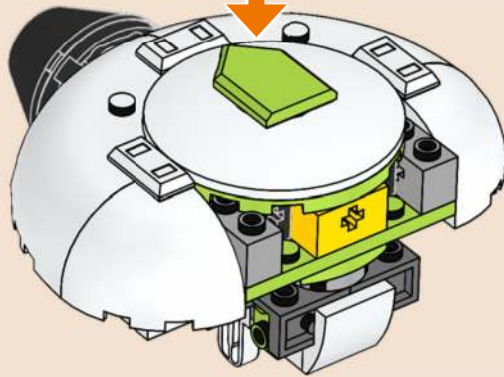
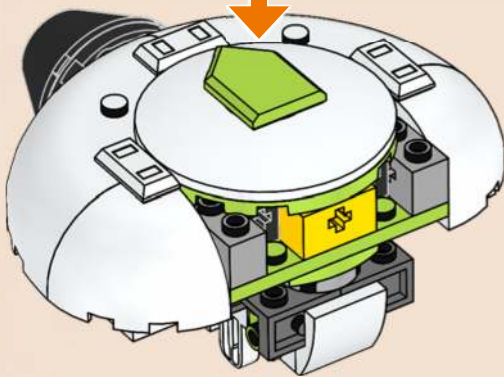
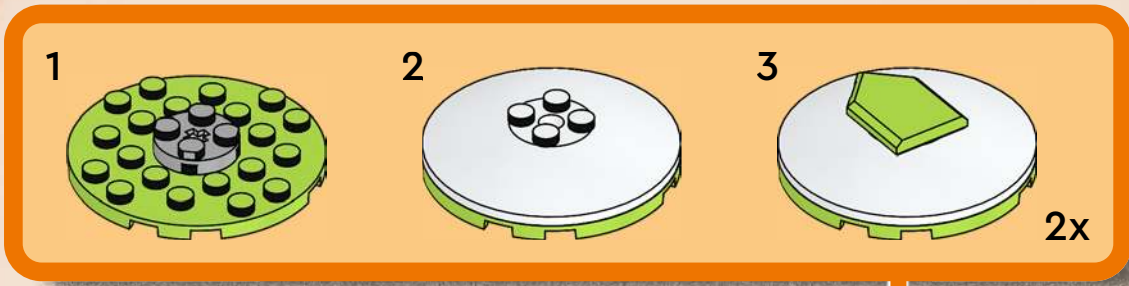

329

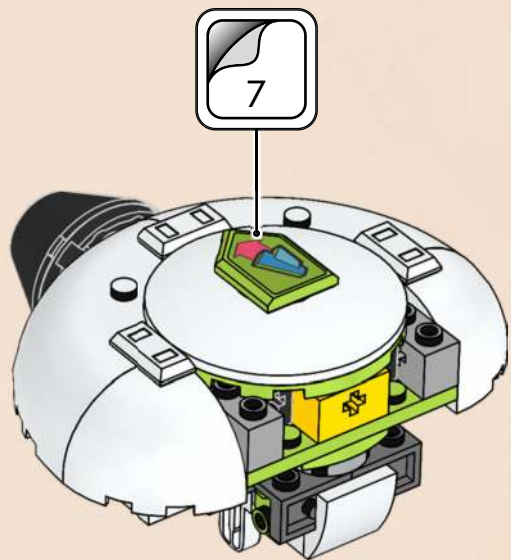
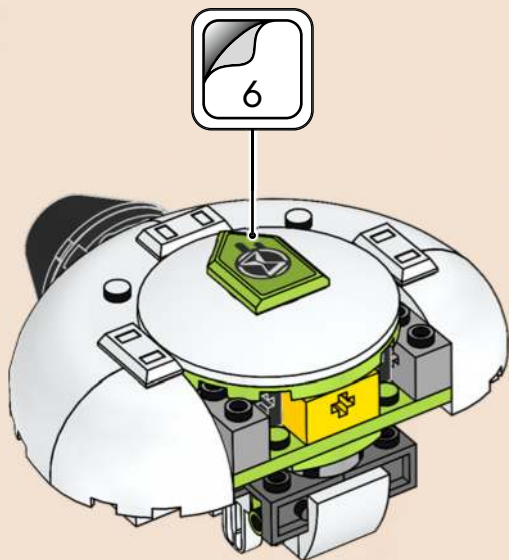

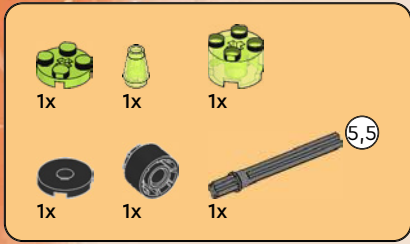

330

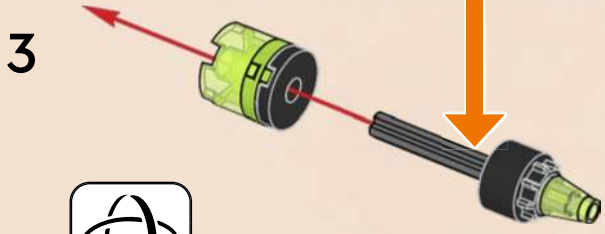

2x

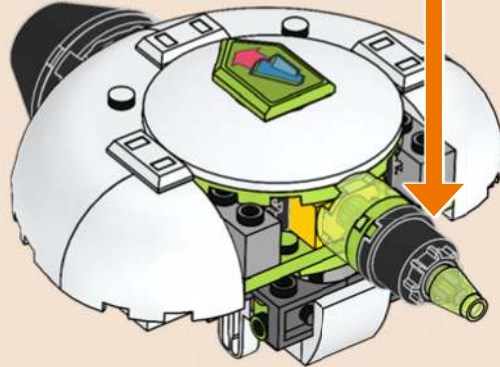
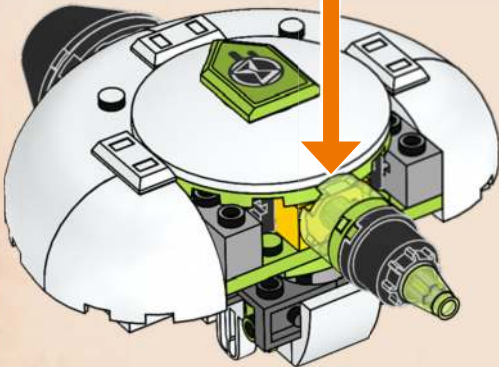

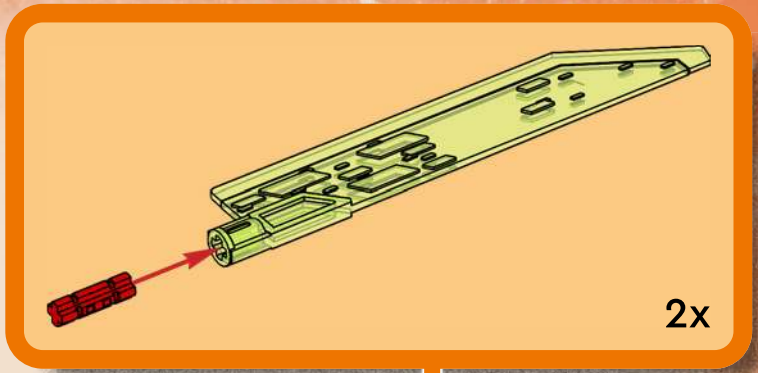
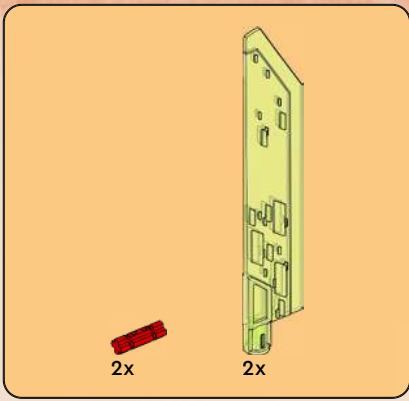

331

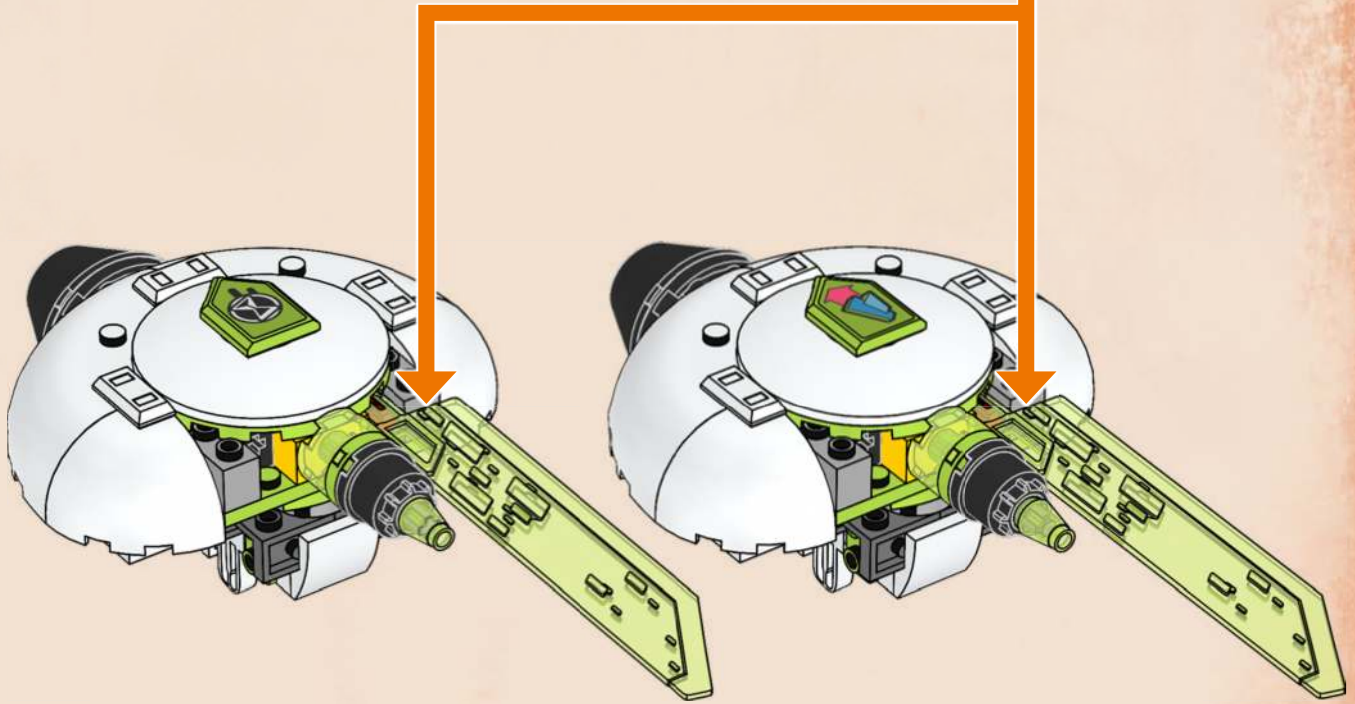

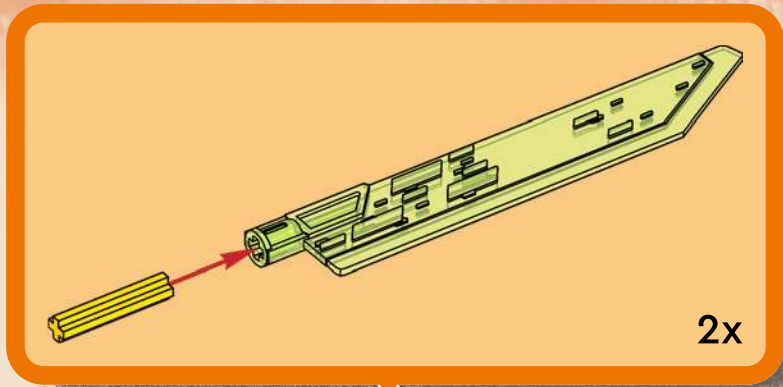
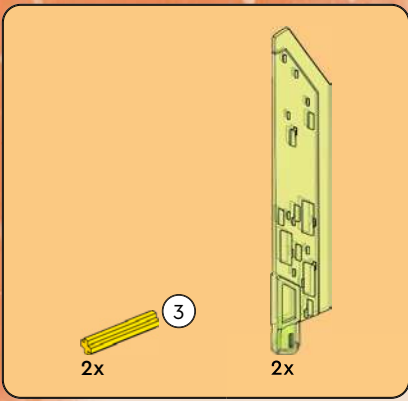

332

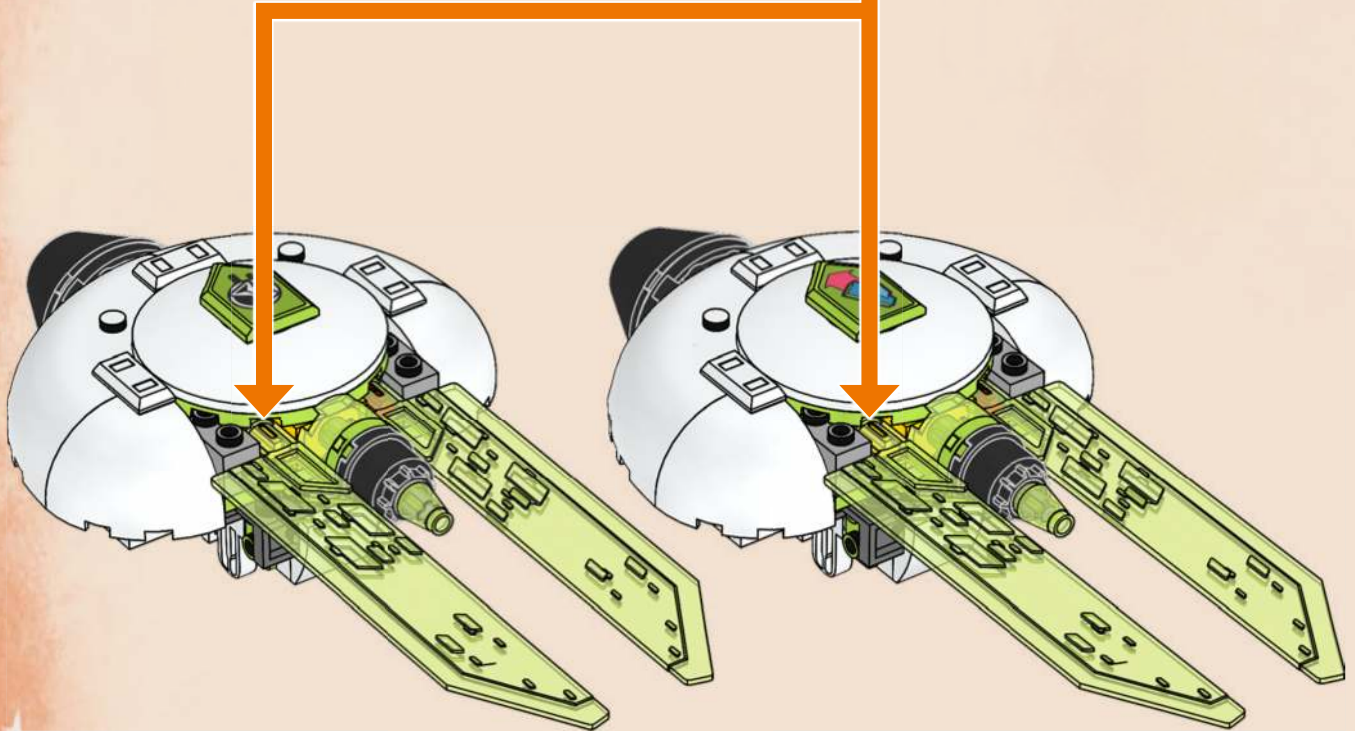

333

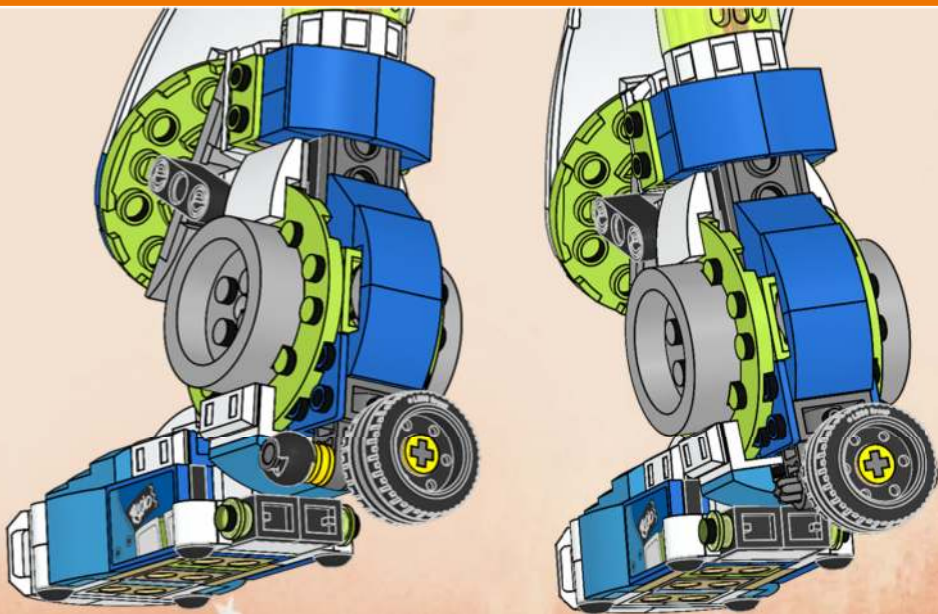
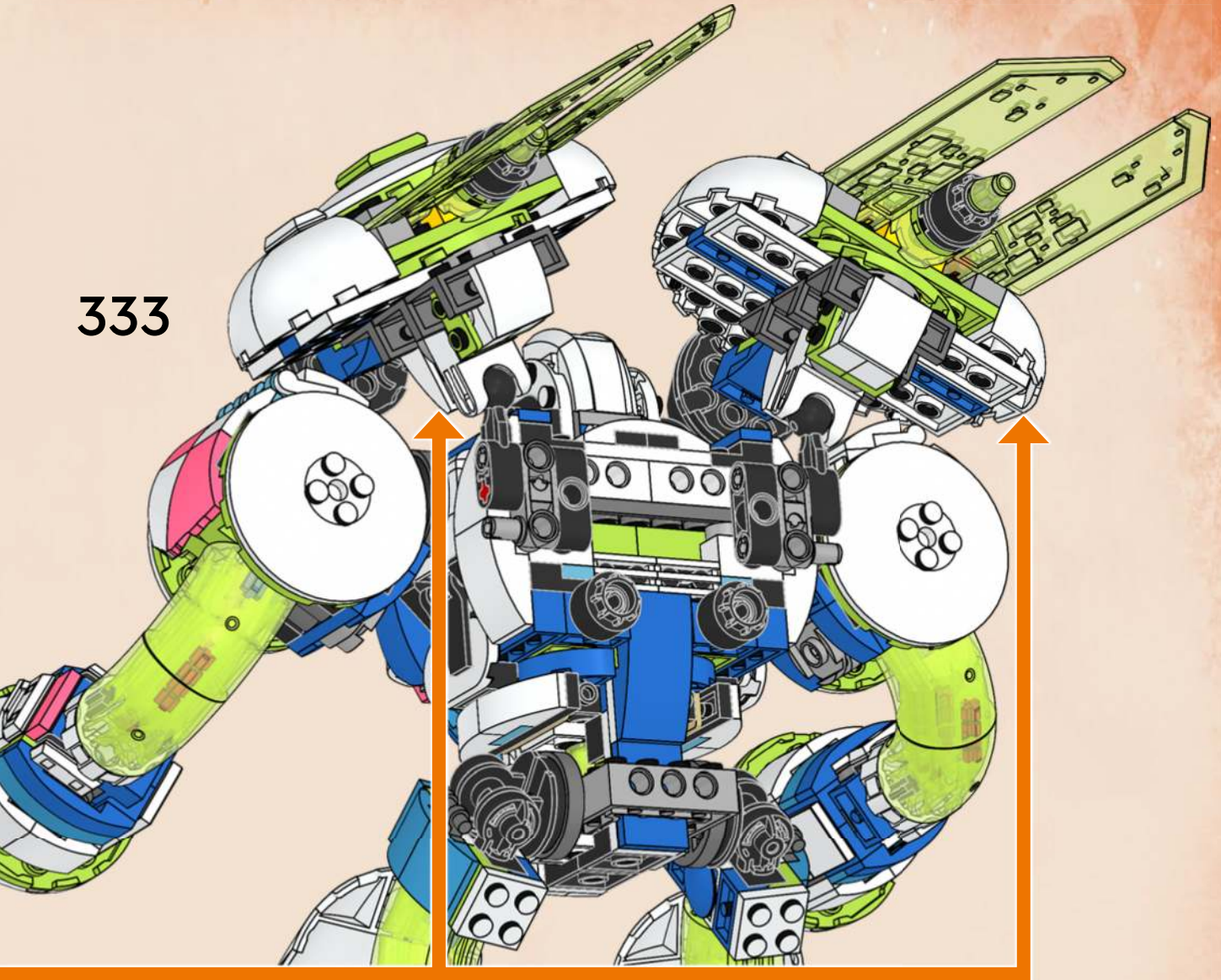



2x



1x



1x

334

1



2



3

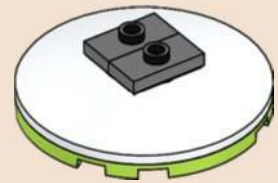

4

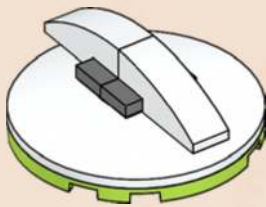

1



2



5

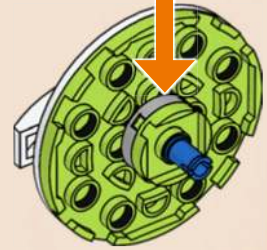
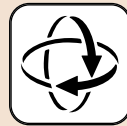

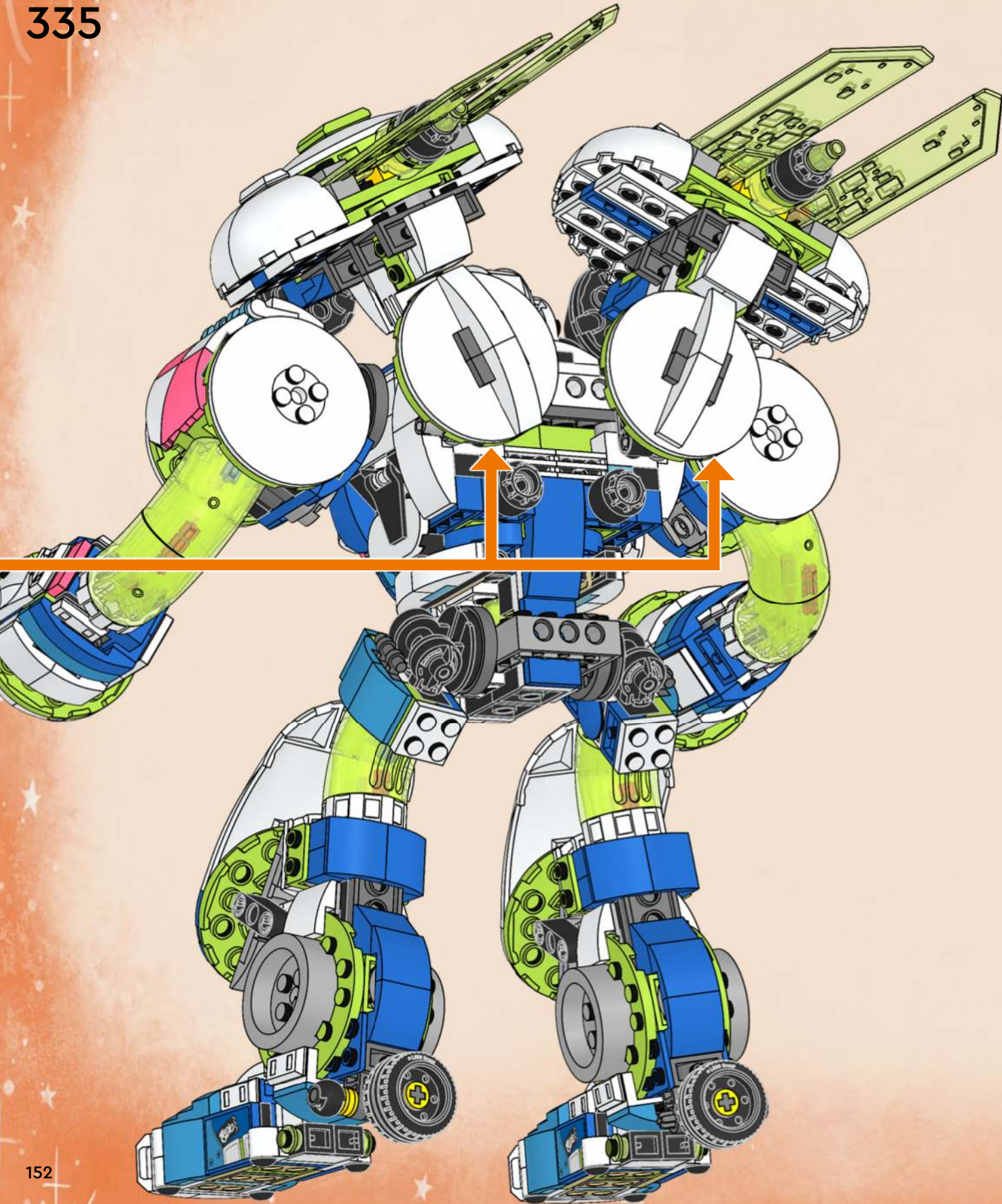

2x



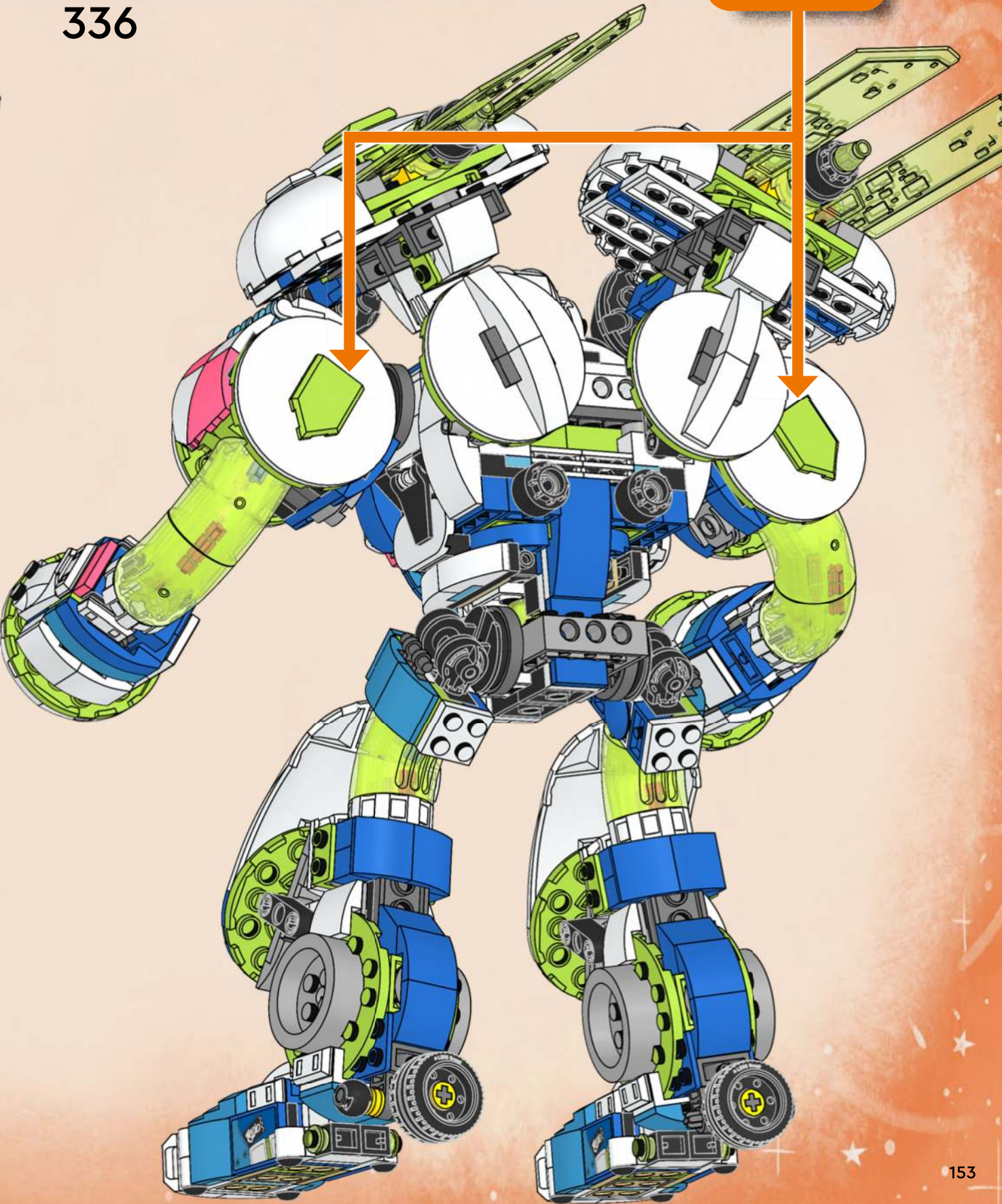

336



1x  1x 

337

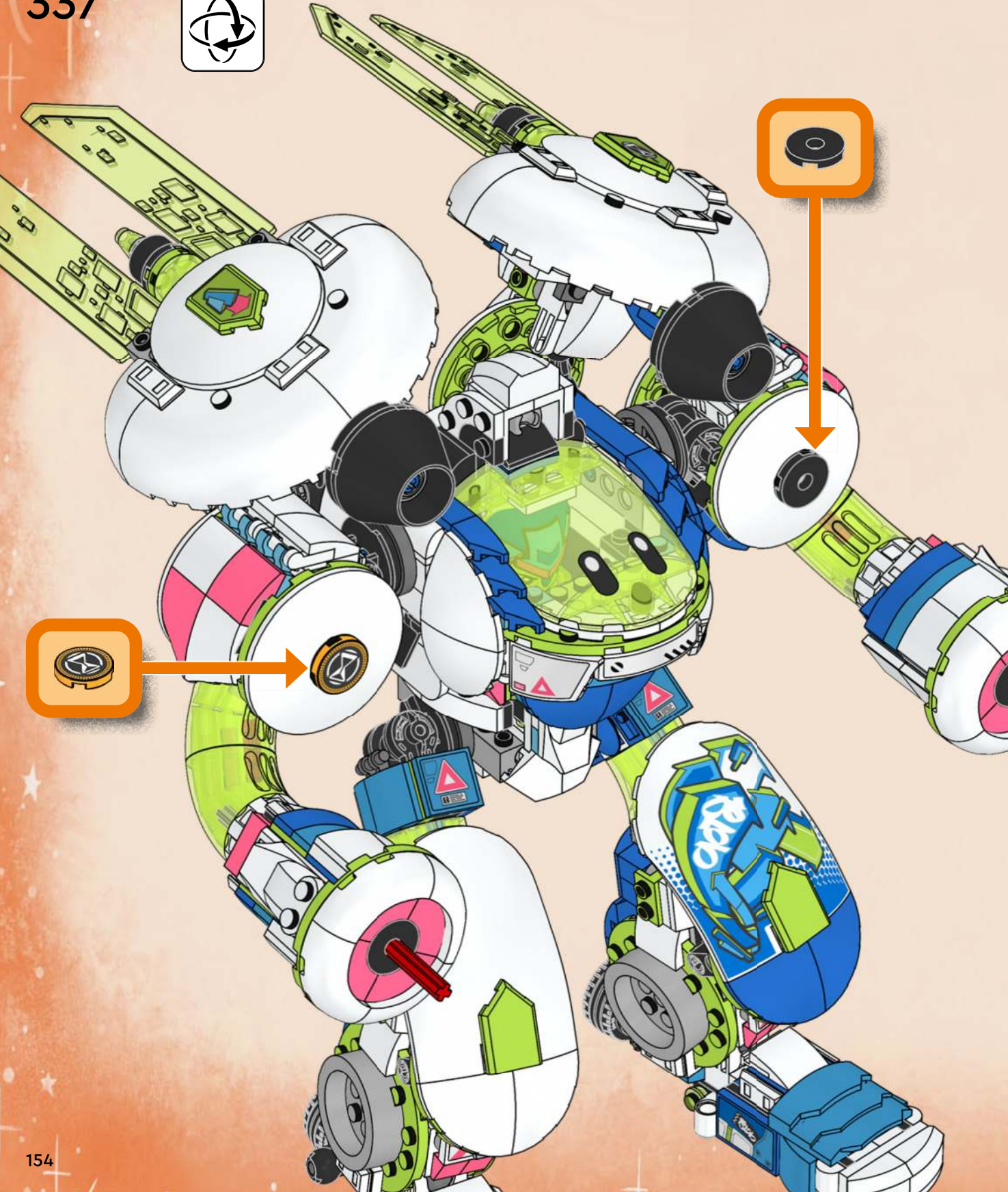



338

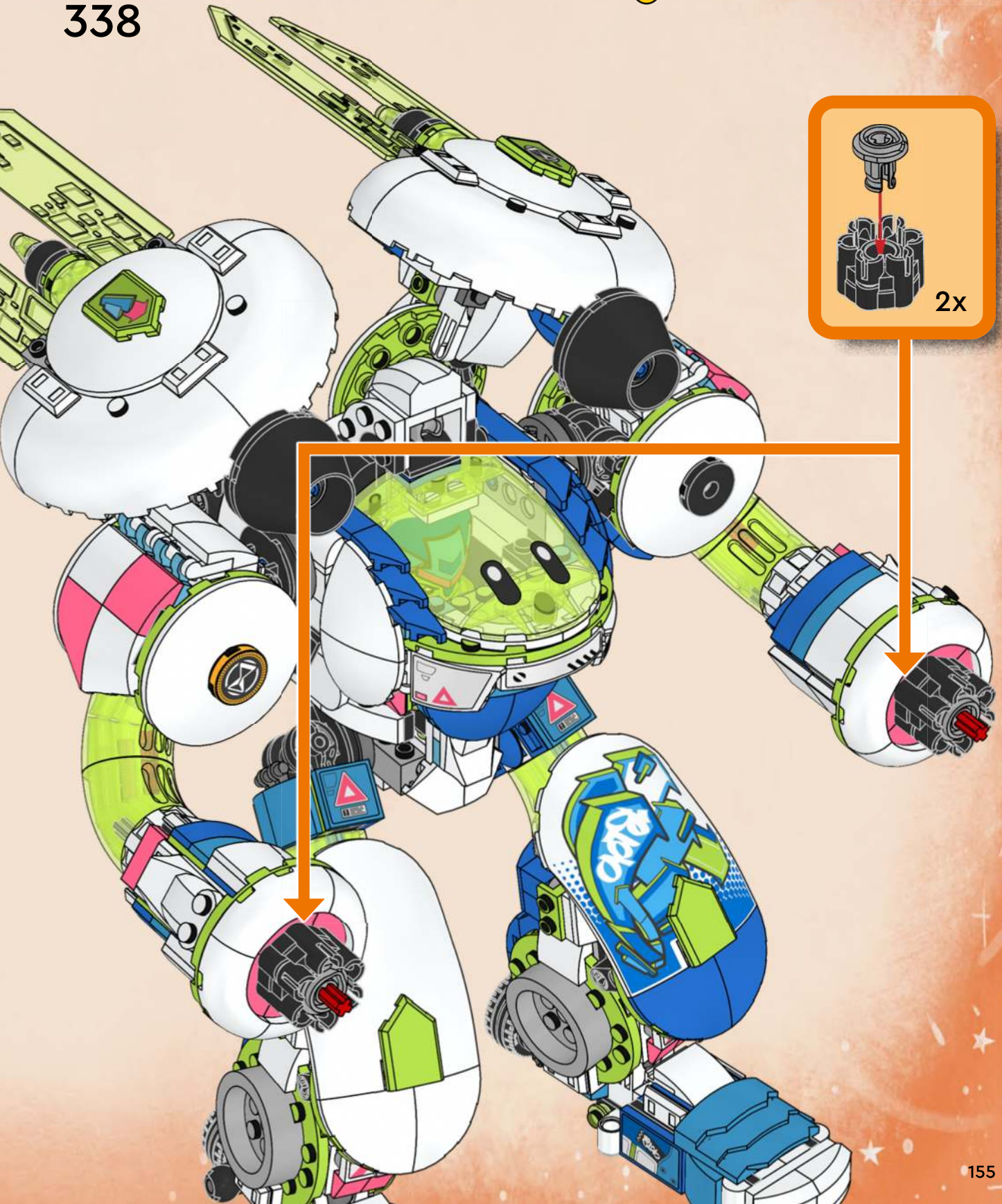
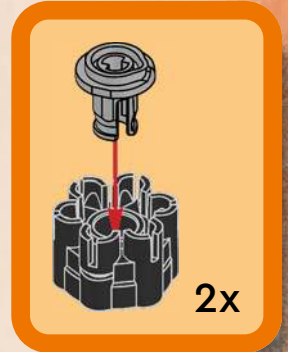



2x

339

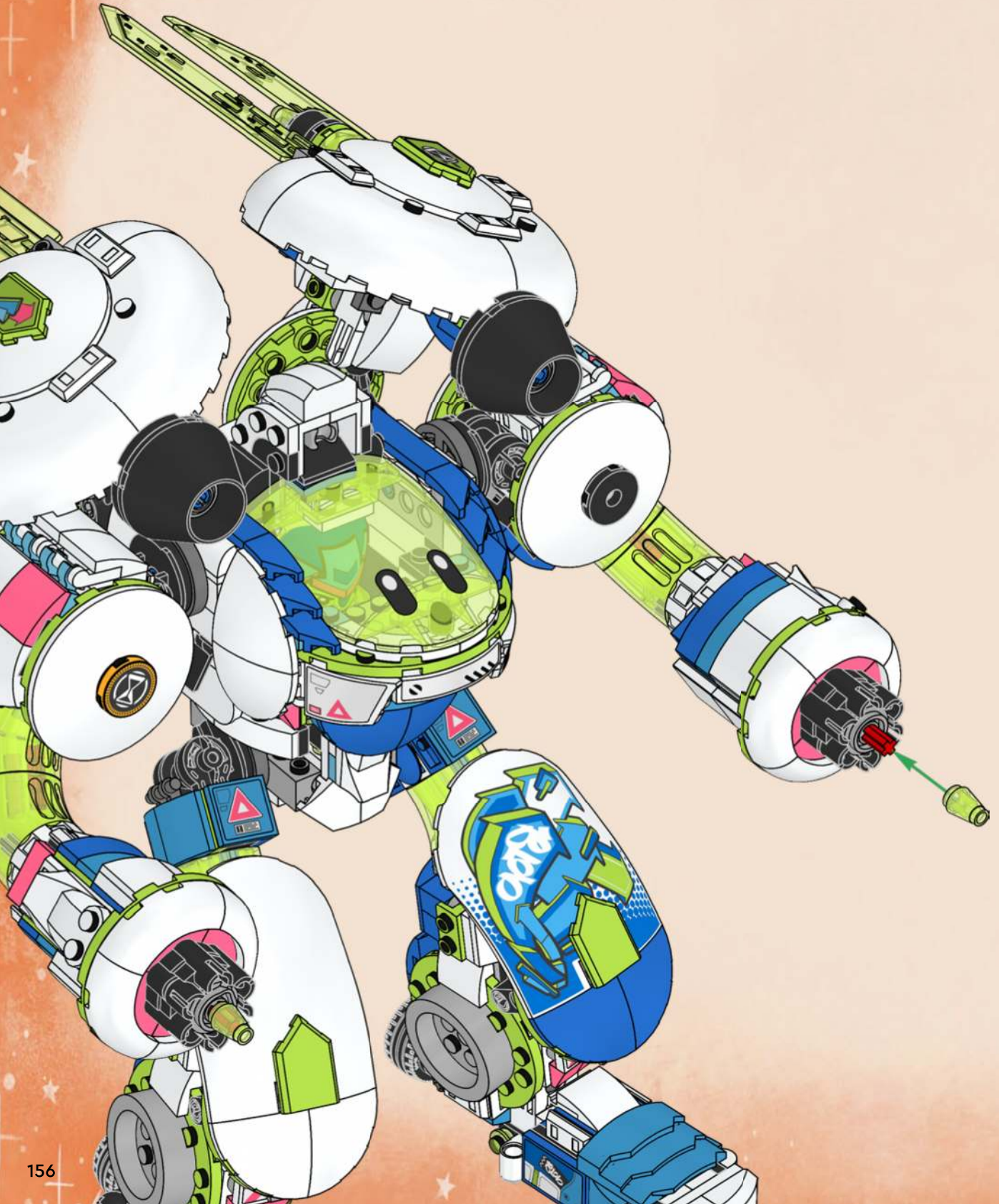

24x

340

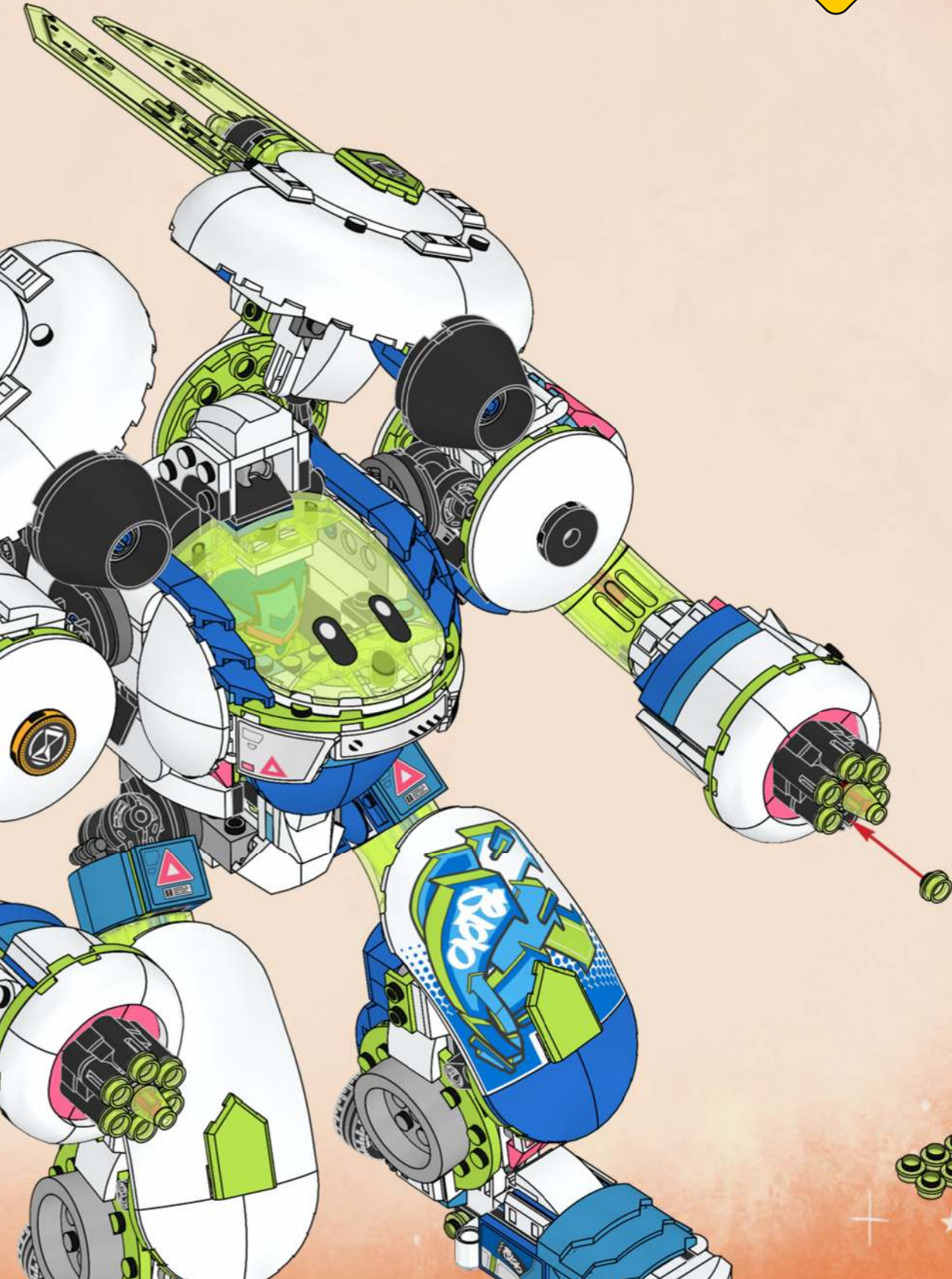

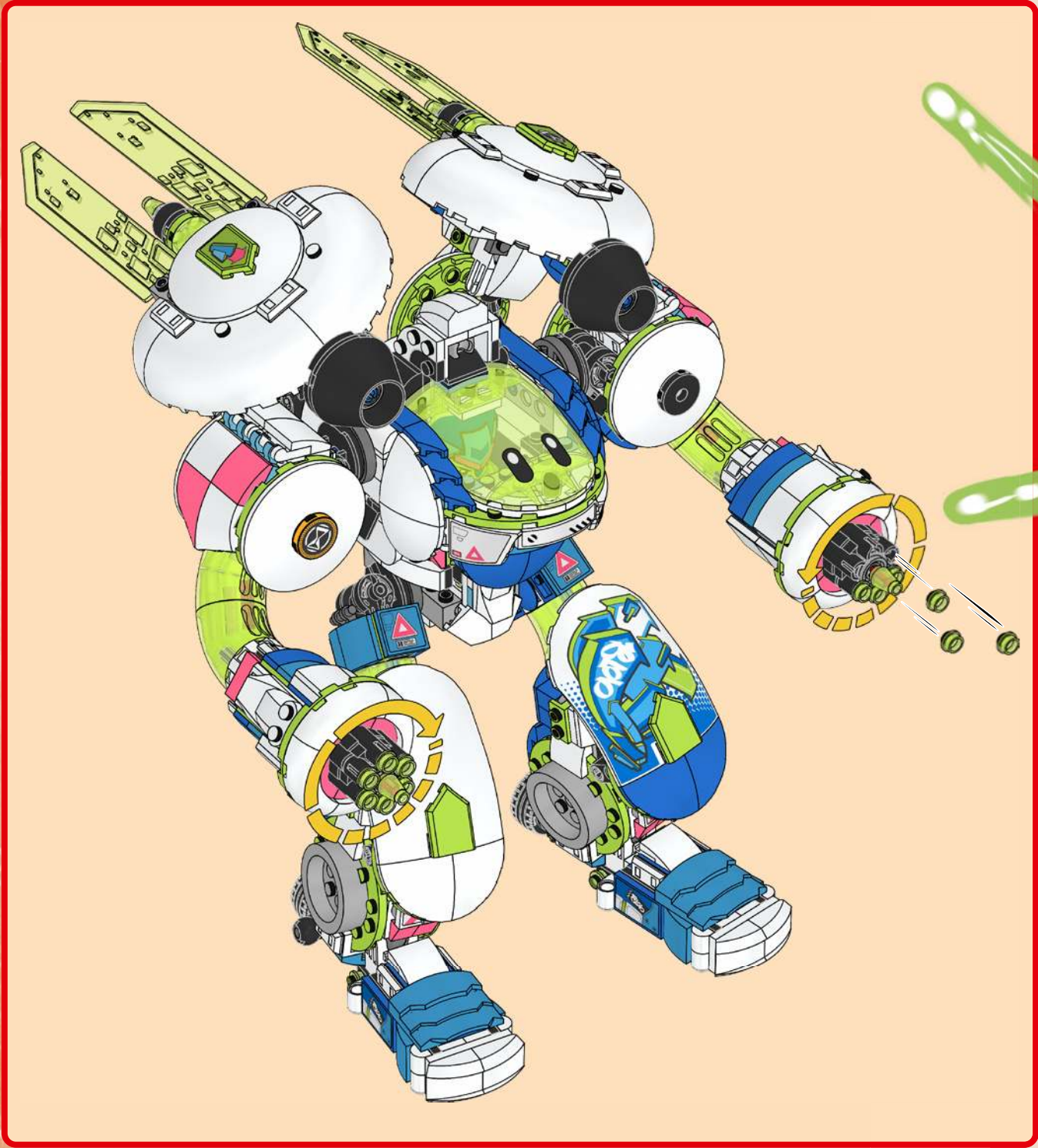



YOU COULD

WIN

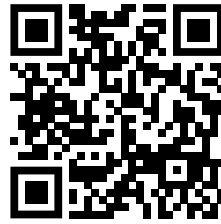

Scan this QR code or go to **LEGO.COM/PRODUCTFEEDBACK** and give us your short feedback about this LEGO® set for a chance to win a cool LEGO prize.

Terms and Conditions apply*

EN: YOU COULD WIN. Terms and Conditions apply* **DE: Du könntest GEWINNEN.** Es gelten die Teilnahmebedingungen* **FR: Tu pourrais GAGNER.** Des conditions s'appliquent* **IT: Potresti VINCERE tu.** Termini e condizioni sono applicabili* **ES: Puedes GANAR.** Aplican términos y condiciones* **PT: Poderá GANHAR.** Aplicam-se termos e condições* **ZH: 轻松获奖. 条款和条件适用*** **PL: Szansa na WYGRANĄ.** Obowiązują warunki korzystania* **CS: Máte šanci VYHRÁT.** Platí všeobecné smluvní podmínky* **SK: Máte šancu VYHRAŤ.** Platia všeobecné zmluvné podmienky* **HU: TE IS NYERHETSZ.** Felhasználási feltételek érvényesek* **RO: Ai putea CÂȘTIGA.** Se aplică termenii și condițiile* **BG: Можете да СПЕЧЕЛИТЕ.** Има определени правила и условия* **LV: Tu vari LAIMĒT.** Ir spēkā noteikumi un nosacījumi.* **ET: Sul on võimalus VÕITA.** Kehtivad tingimused* **LT: Jūs galite LAIMĖTI.** Taikomos sąlygos*

*[LEGO.com/productfeedback-terms](https://www.lego.com/productfeedback-terms)