



# Friends

42624



LEGO® Builder



LEGO.com/sustainable-packaging



FR

**DONNEZ**  
OU  
**RECYCLEZ**



OU



OU



ASSOCIATION

MAGASIN

DÉCHÈTERIE

Adresses sur [quefairedemesdechets.fr](http://quefairedemesdechets.fr)

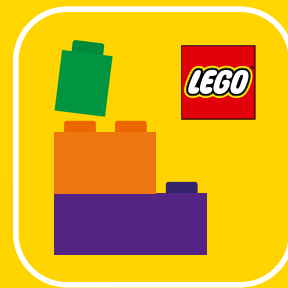

🔍 LEGO® Builder

# BUILDER



Apple and the Apple logo are trademarks of Apple Inc., registered in the U.S. and other countries and regions. App Store is a service mark of Apple Inc. Google Play and the Google Play logo are trademarks of Google LLC. Tencent and the Tencent logo are trademarks of Tencent Inc.

🔍 [LEGO.com/devicecheck](https://LEGO.com/devicecheck)

EN Ask parents' permission before going online | DE Eltern um Erlaubnis bitten, bevor du online gehst | FR Demande l'autorisation d'un parent avant d'aller en ligne | IT Chiedi il permesso ai tuoi genitori prima di andare online | ES Pídeles permiso a tus papás antes de conectarte a Internet | PT Pede autorização aos pais antes de acederes online | ZH 上网前应先征得父母的同意 | PL Poproś rodziców o zgodę, zanim wejdziesz do Internetu | CS Než půjdeš na internet, požádej rodiče o svolení | SK Skôr než pôjdeš na internet, vypýtaj si povolenie od rodičov | HU Kérj szülői engedélyt, mielőtt online csatlakoznál! | RO Cere permisiunea părinților înainte de a te conecta online | BG Поискайте разрешение от родител, преди да влезете онлайн | LV Pirms došanās tiešsaistē palūdz atļauju vecākiem | ET Enne Interneti kasutamist küsi vanematelt luba | LT Prieš prisijungdami prie interneto, atsklauskite tėvų



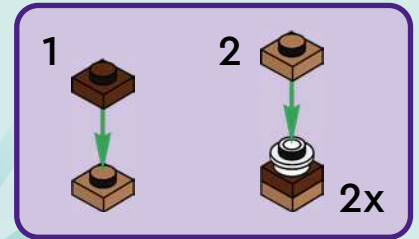
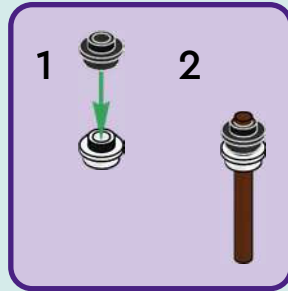
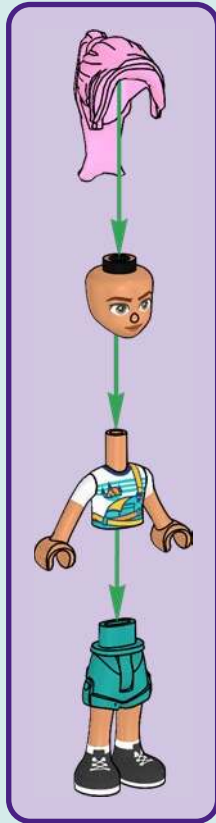

SKY

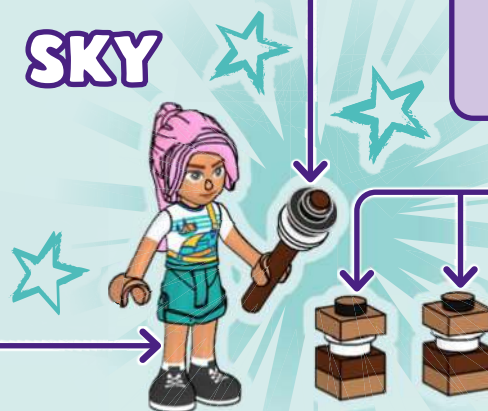

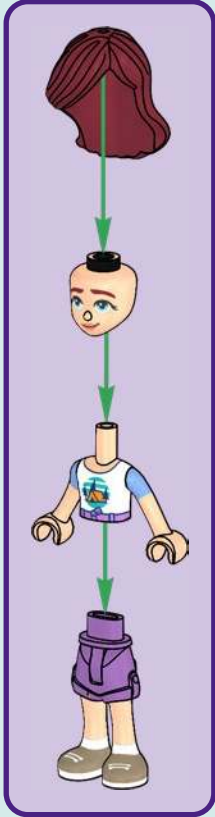

# PAISLEY





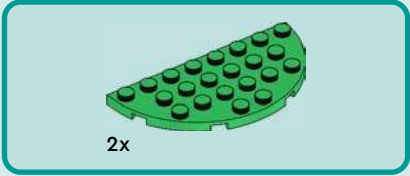

1

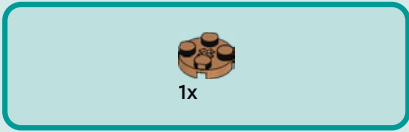
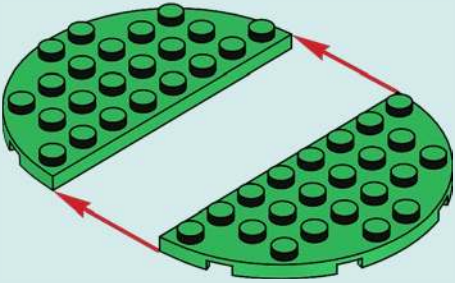

2

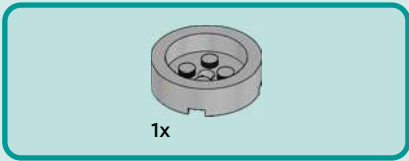
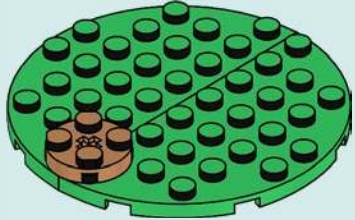

3

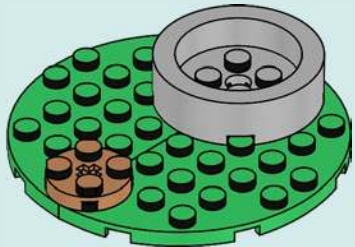



2x

4

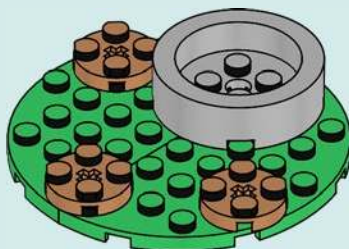

2x



3x

5

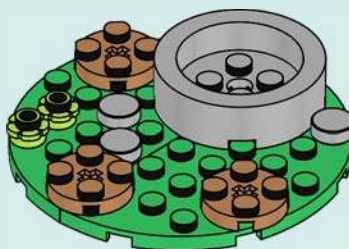



6

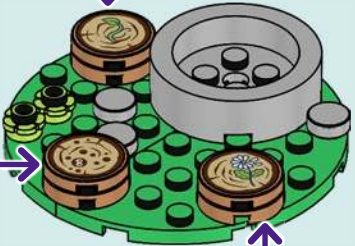
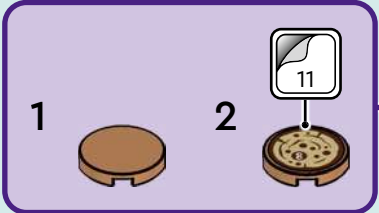
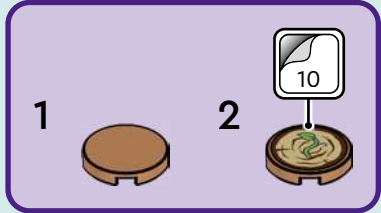

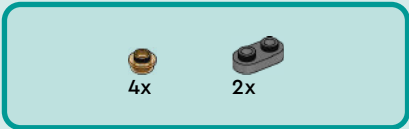

7

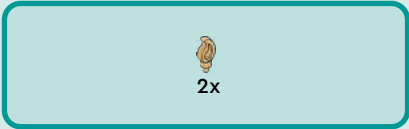
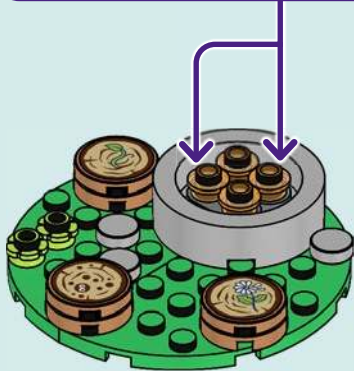

8





2x

9



2x



4x

10

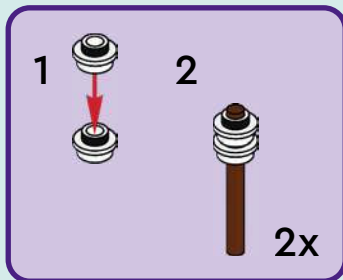



1x

11



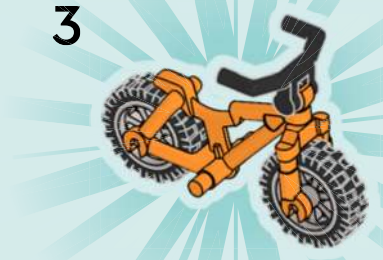
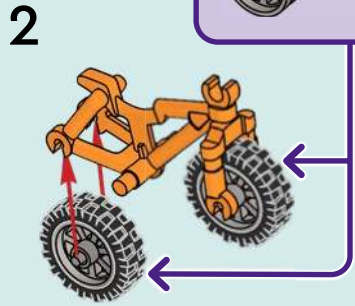
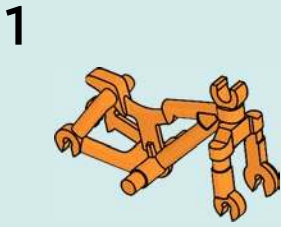
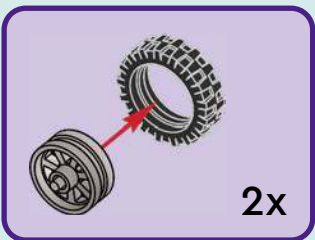
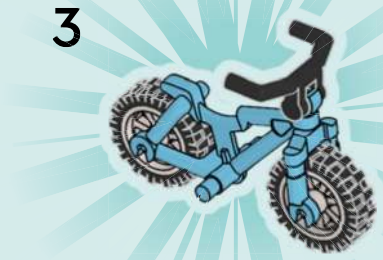
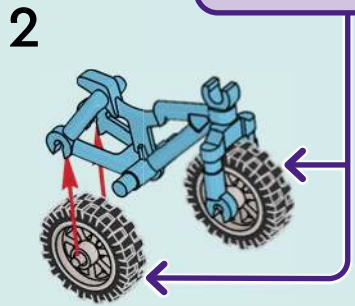
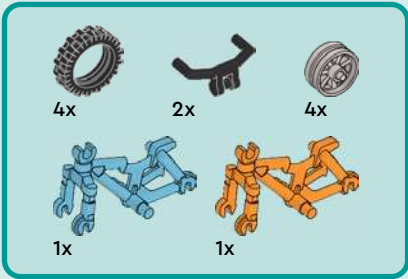

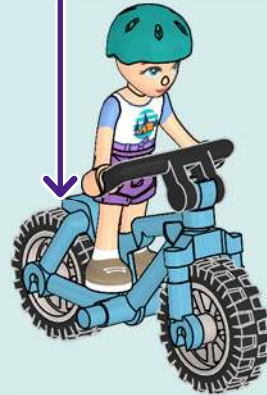
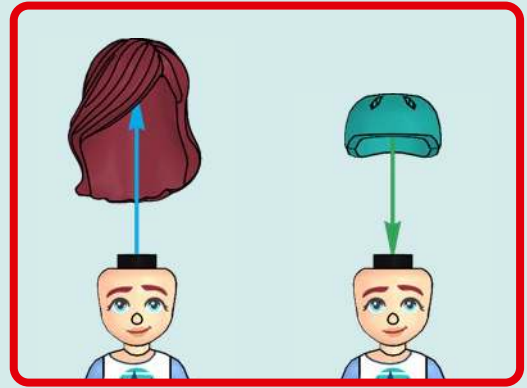
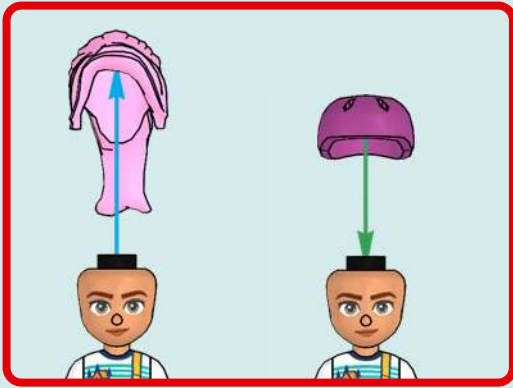

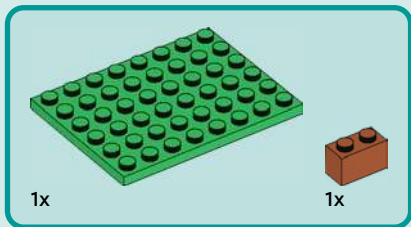
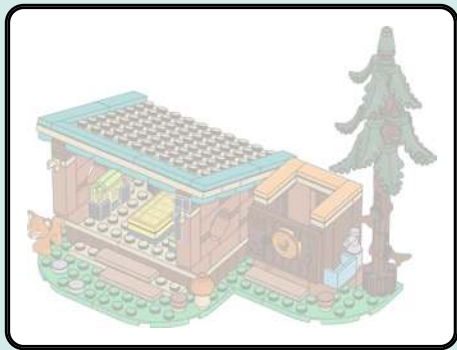

1

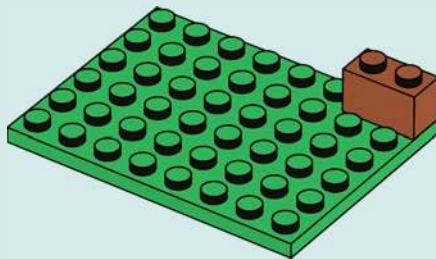

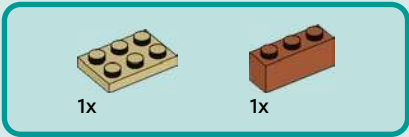

2

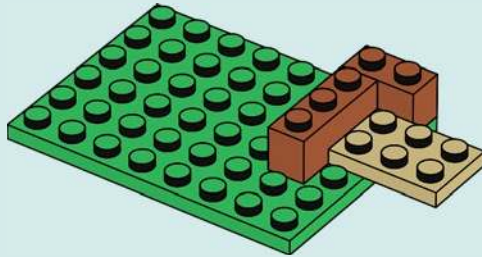

3

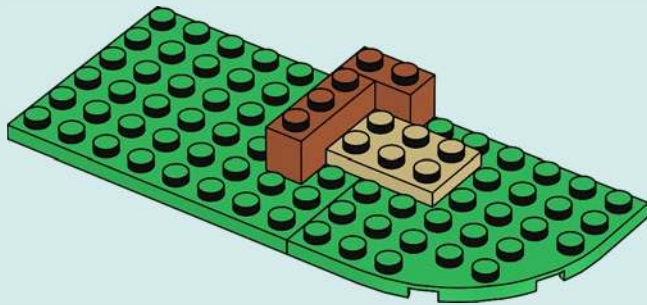



1x

4

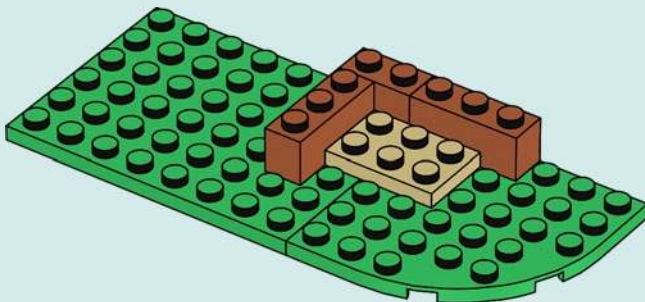

1x



1x

5

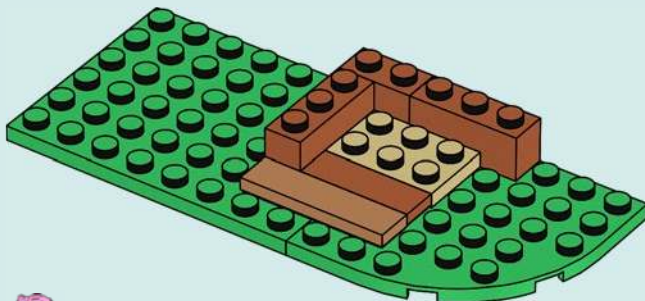



6

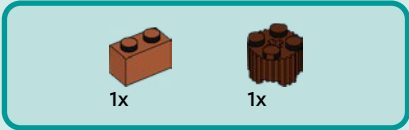
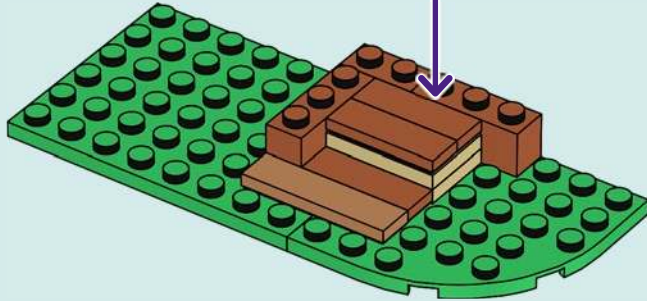
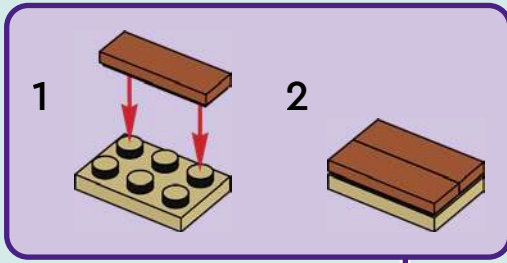

7

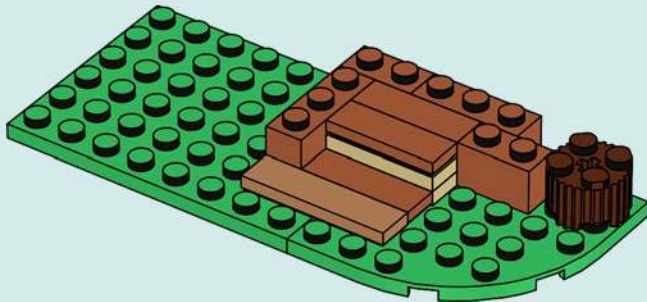



1x

8

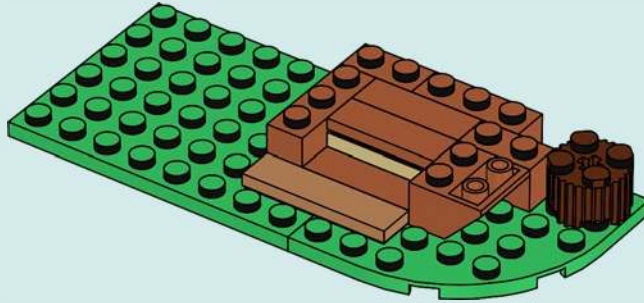

2x



2x

9

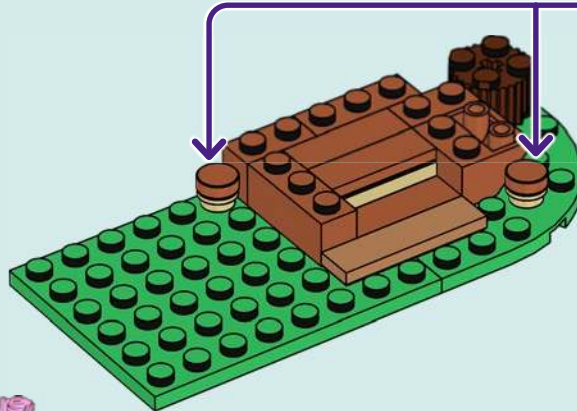

2x



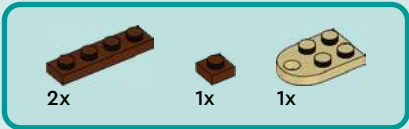

10

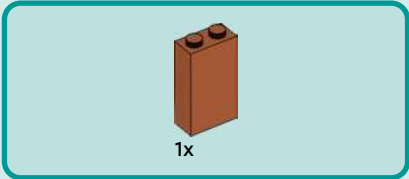
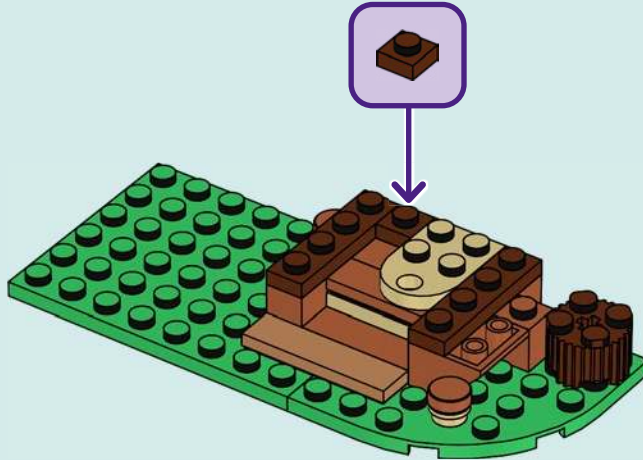

11

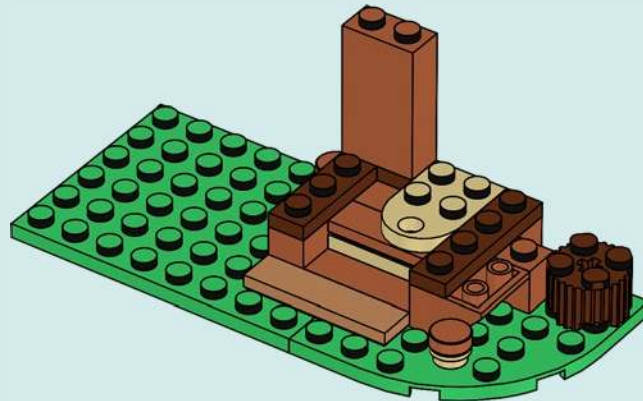

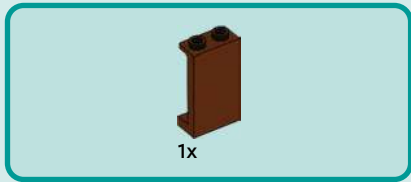

12

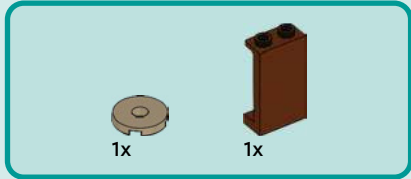
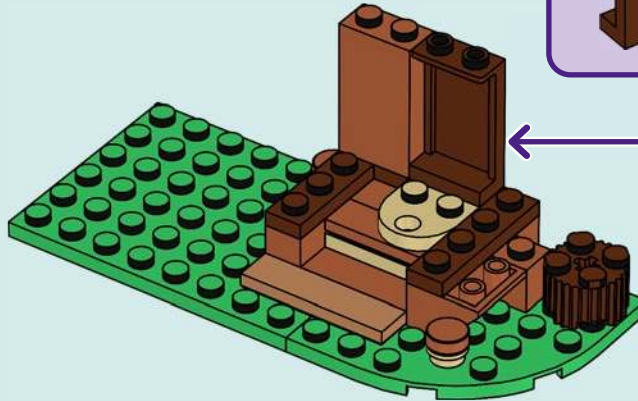

13

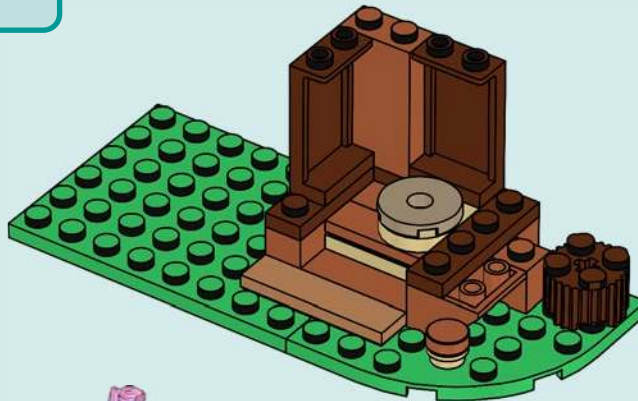

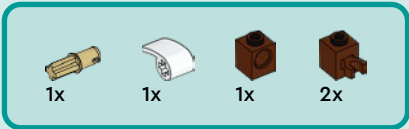

# 14

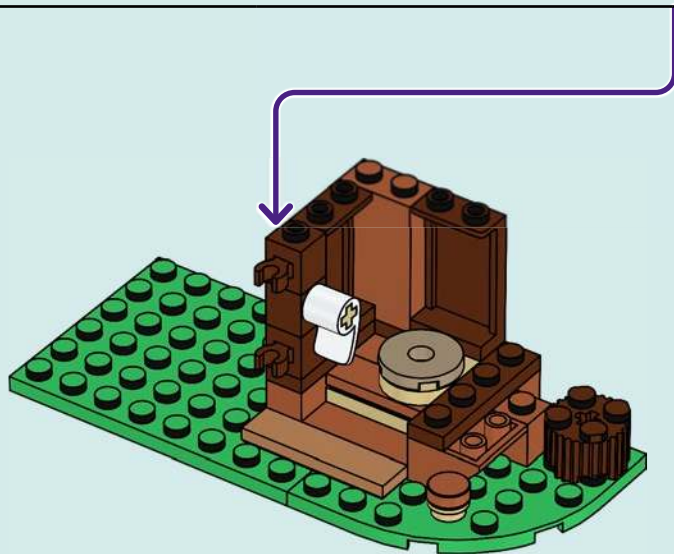
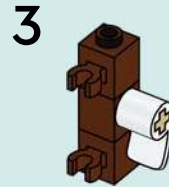
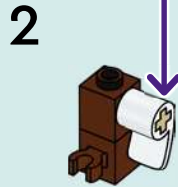
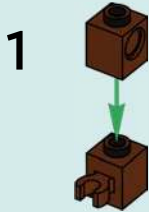
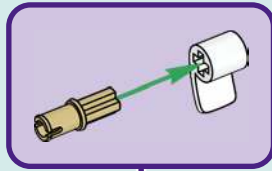

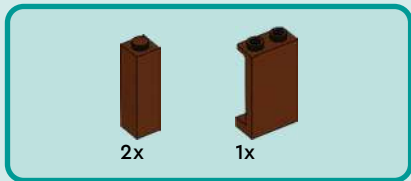

15

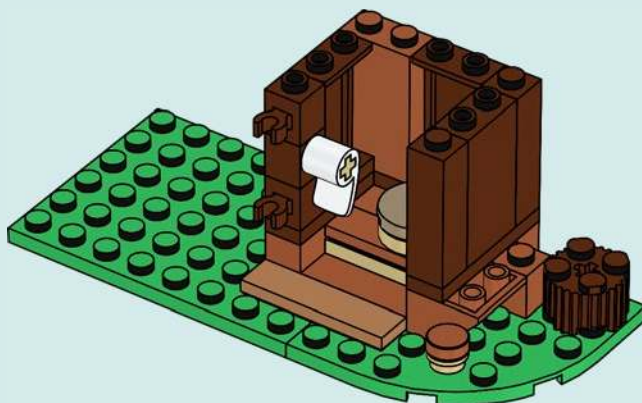



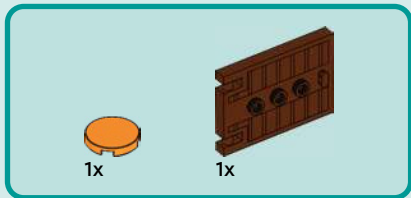

18

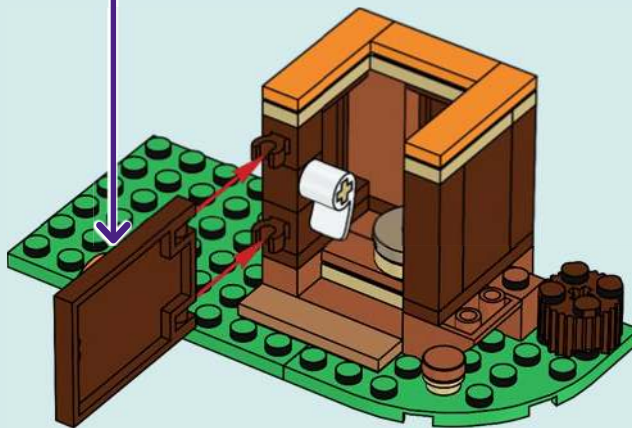
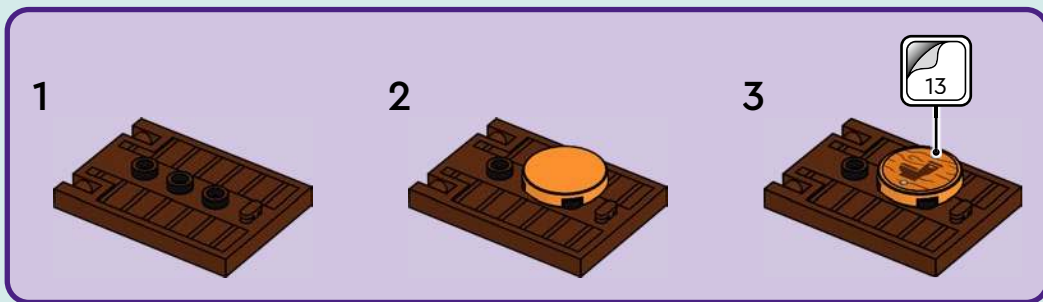



1x

19

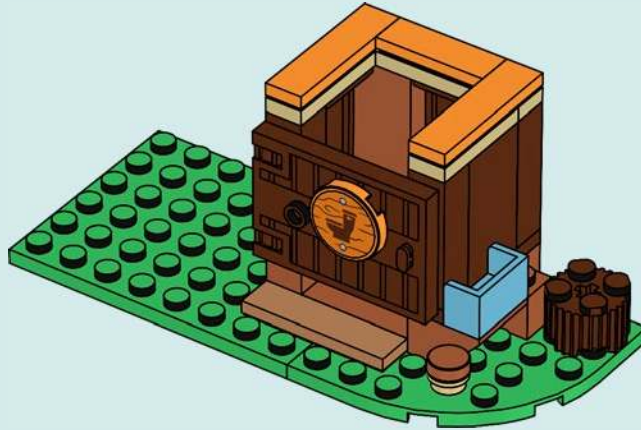

1x



1x

20

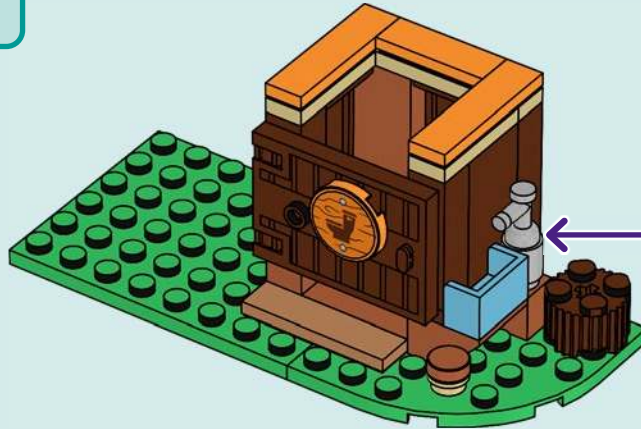

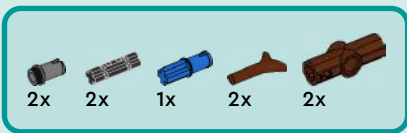

# 21

1

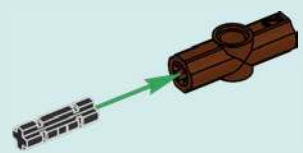

2

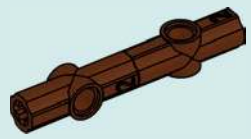

3



4



5

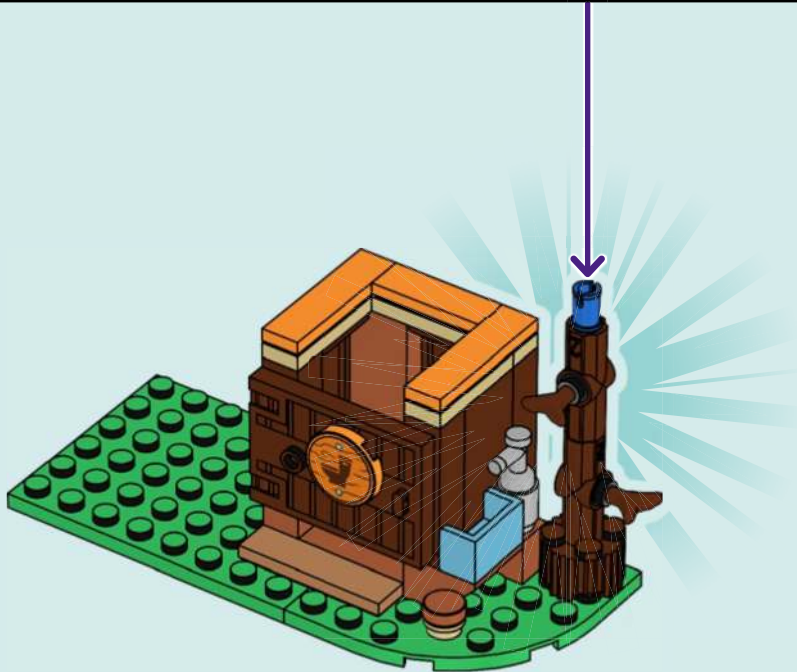
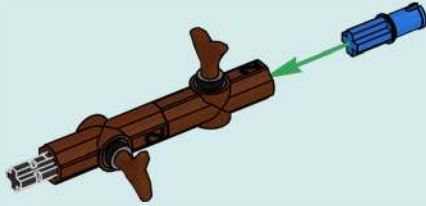



1x



1x

22

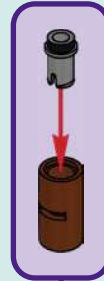

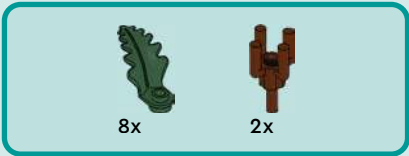

23

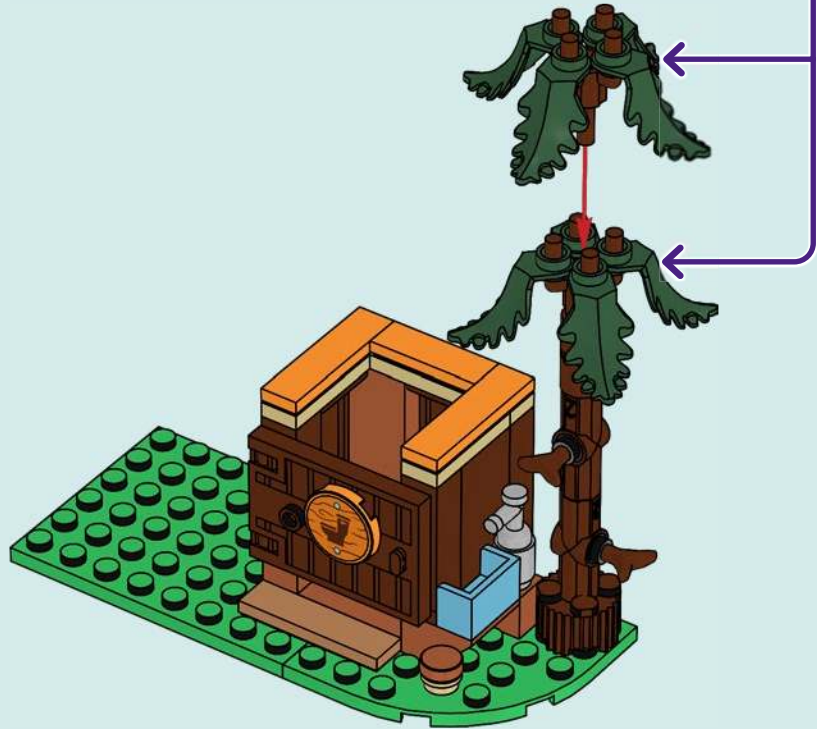
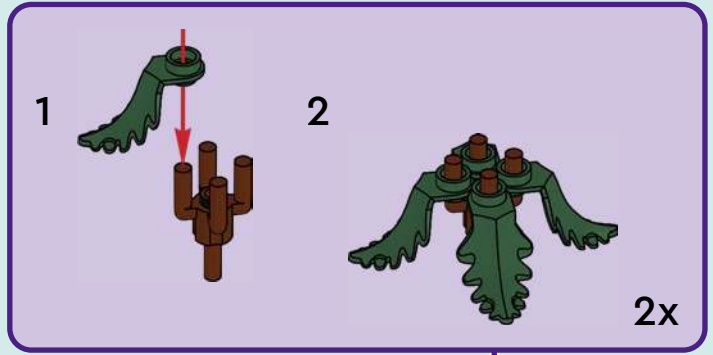

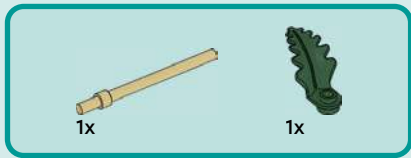

24

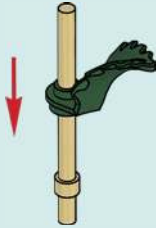

25

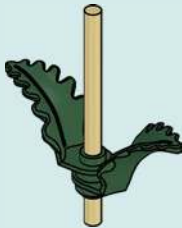

26

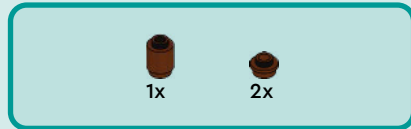
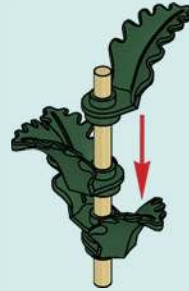

27

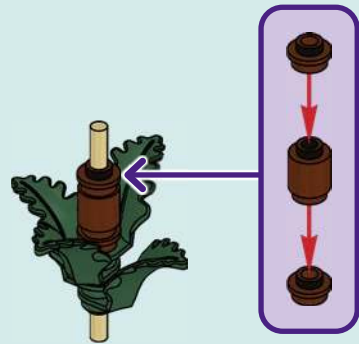

28



29





1x



1x

30

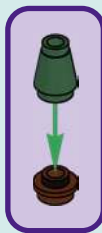



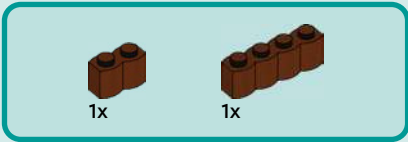

31



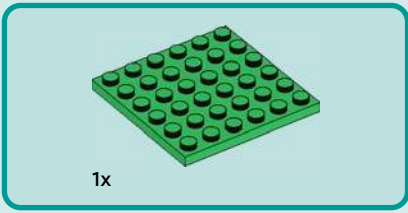

32





1x

33



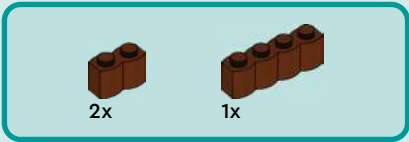

34



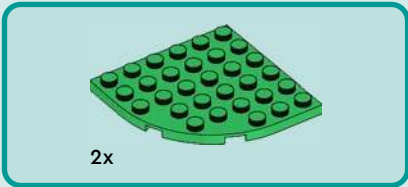

35





1x



2x

36





2x

37



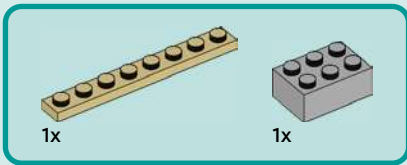

38





2x

39



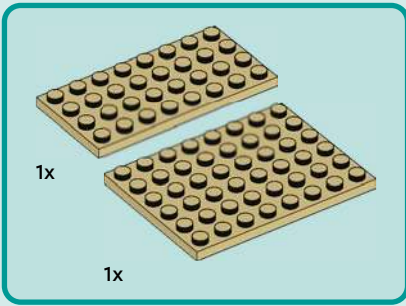

40





1x



1x

41





3x



2x



1x

42

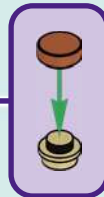
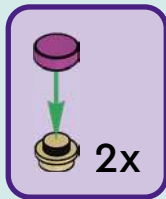



2x

43



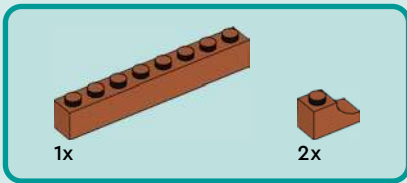

44





2x

45





2x



2x

46



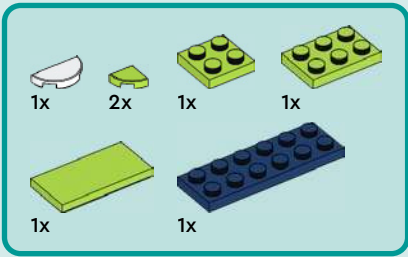

47

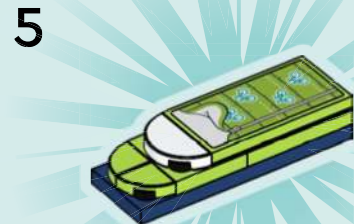
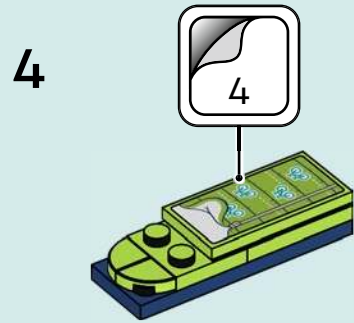
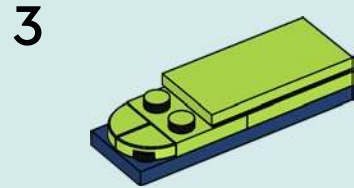
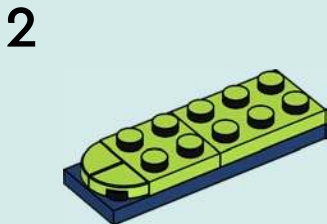
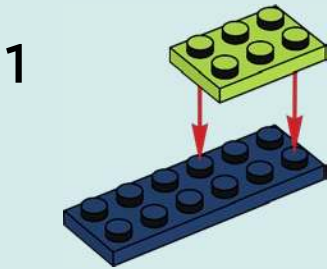



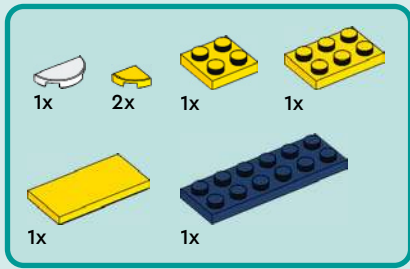

48

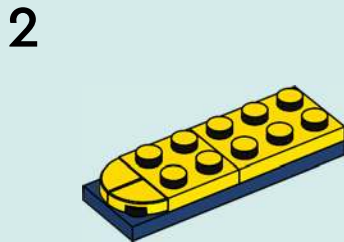
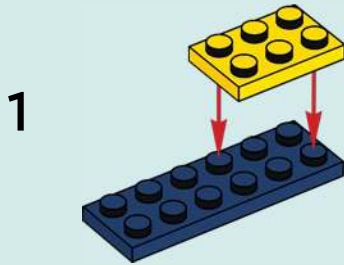

3

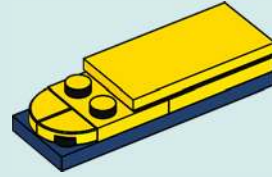

4

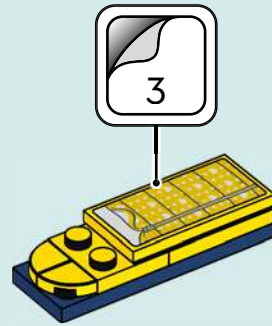

5



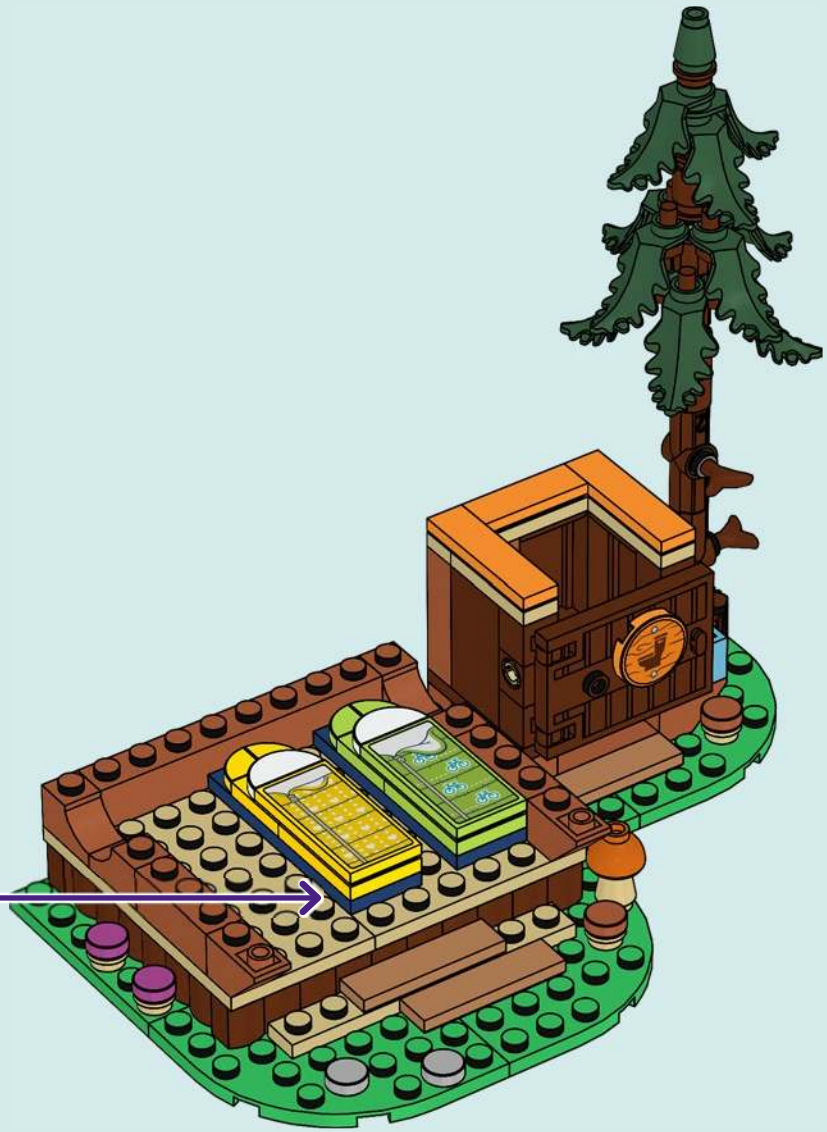

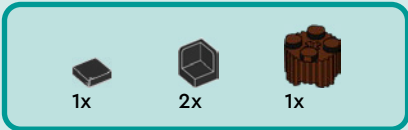

49



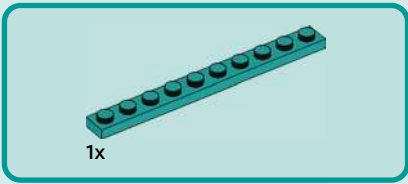

50





2x

51



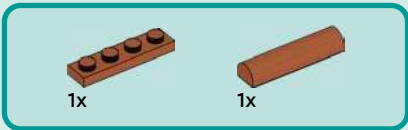

52





4x

53



2x

1x

54

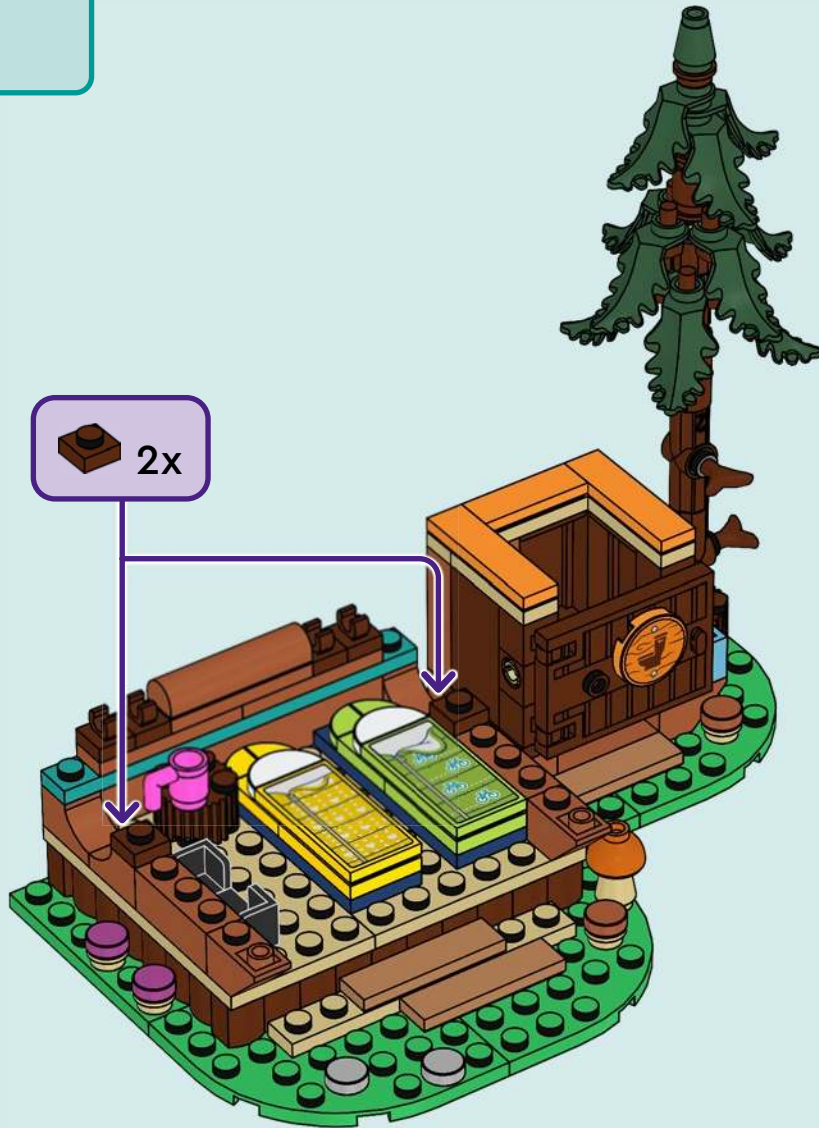



2x

55





4x

56



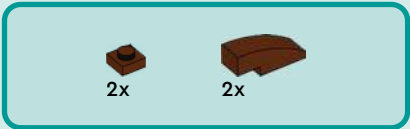

57

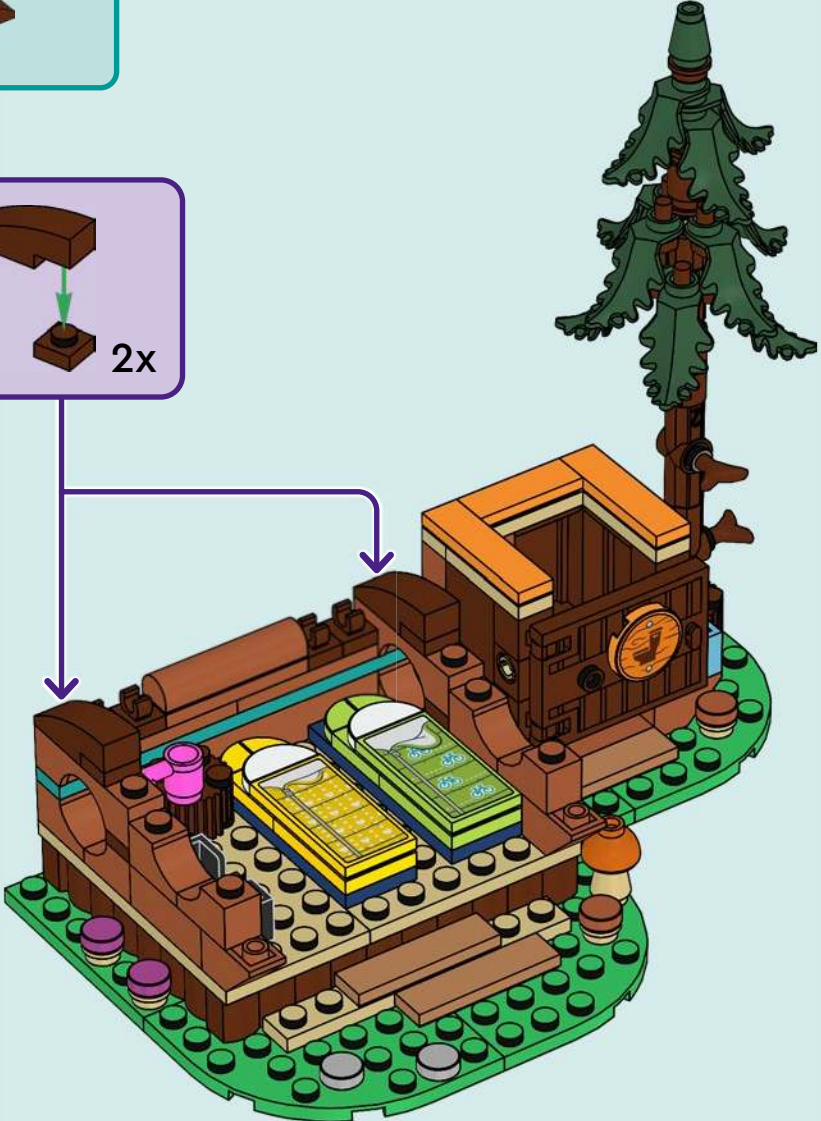
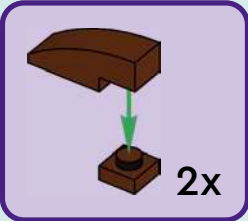



2x

58



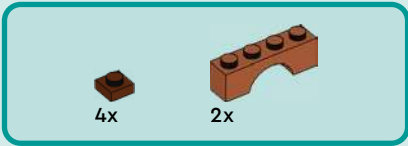

# 59

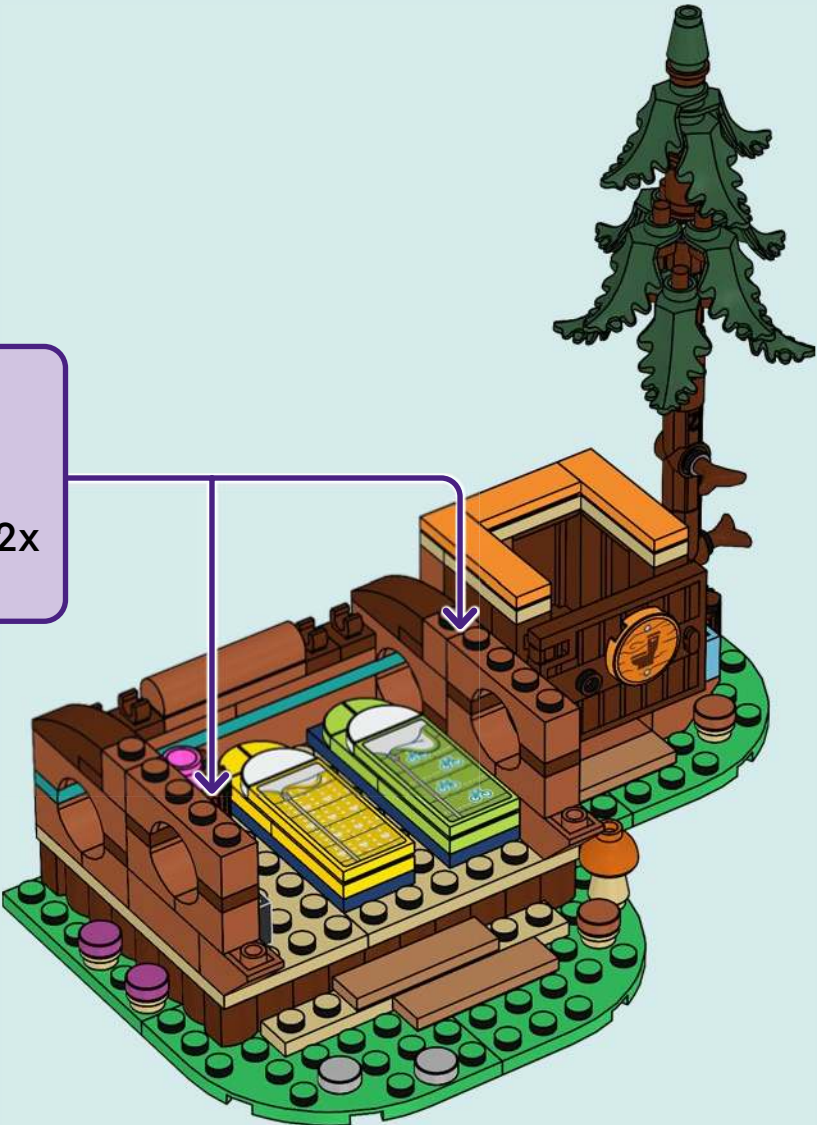
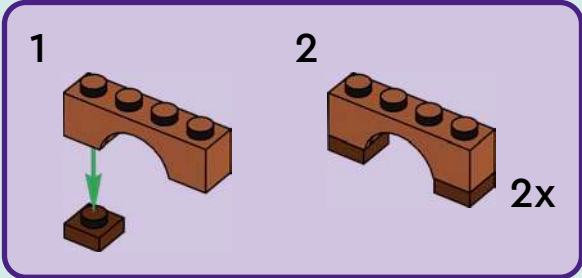



2x



2x

60

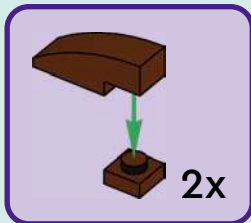



2x

61



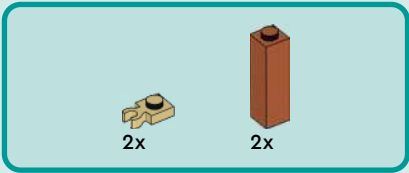

62

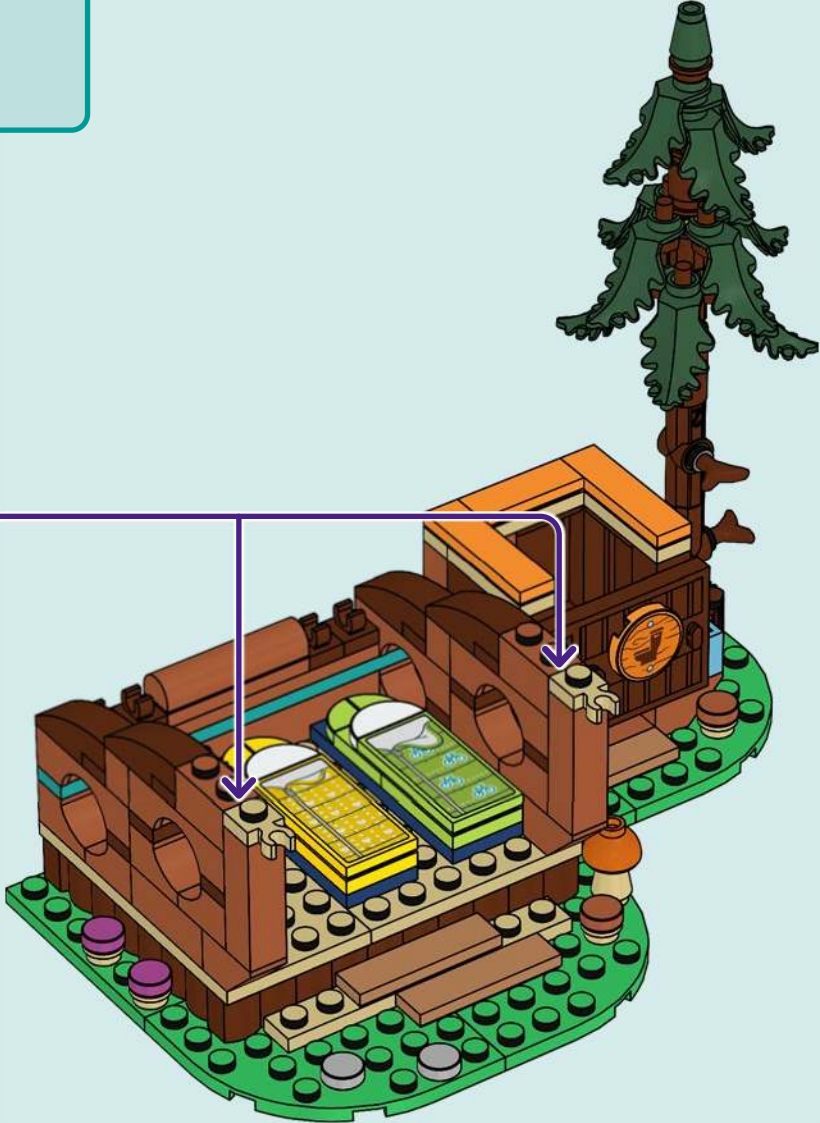
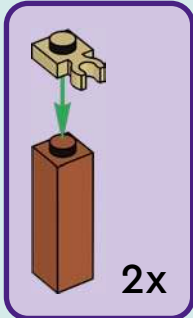



2x



2x

63

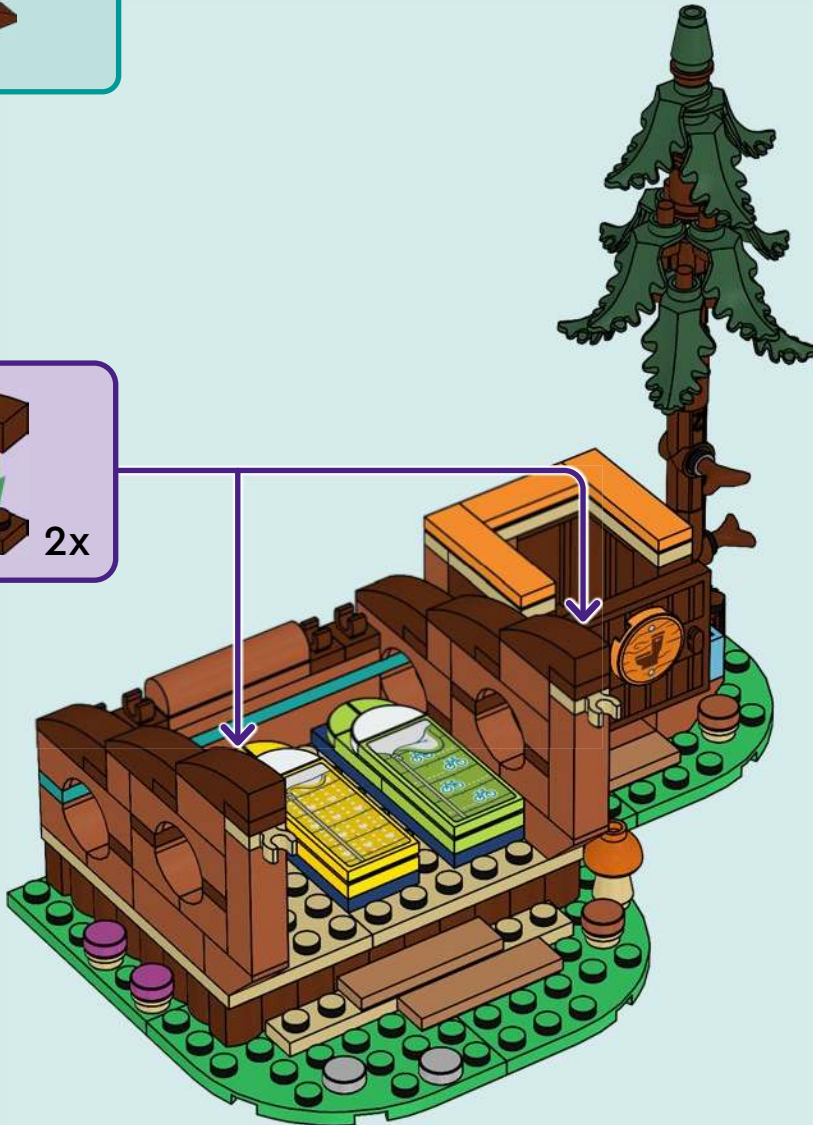
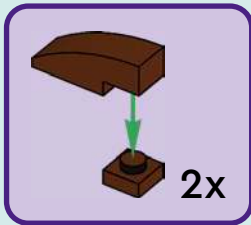

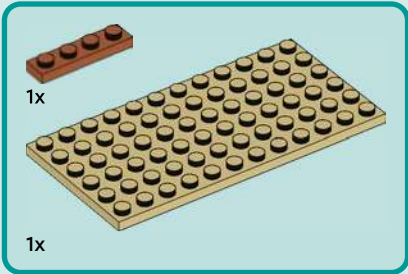

64

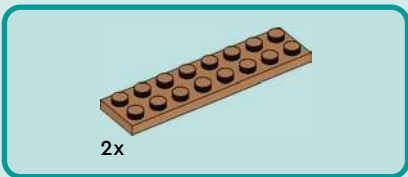
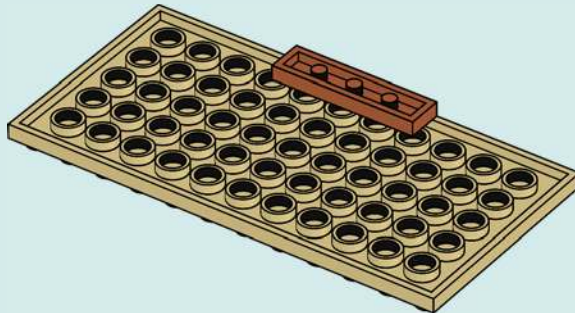

65

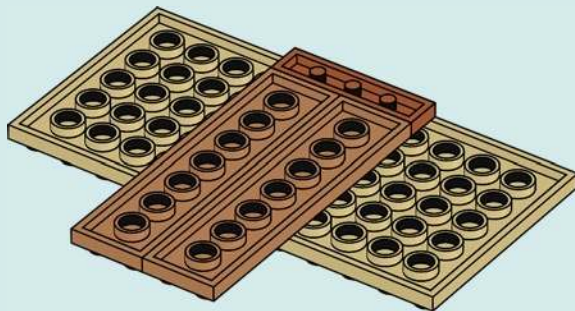

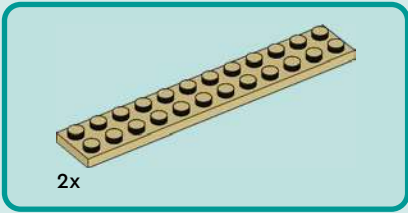

66

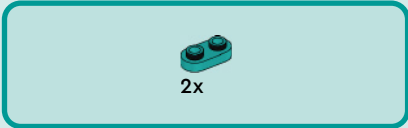
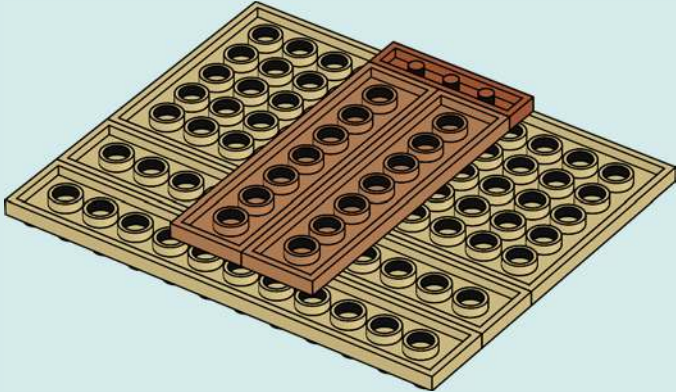

67

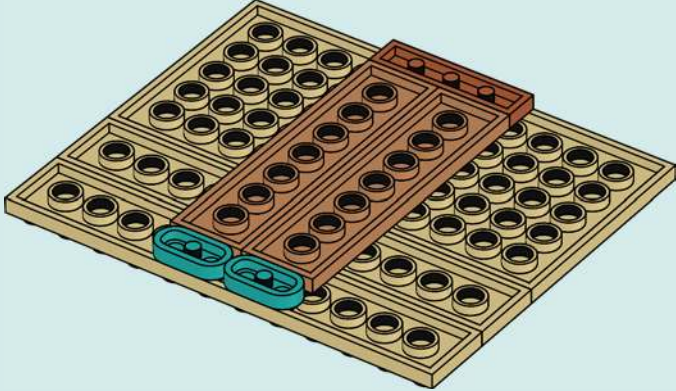



10x

68

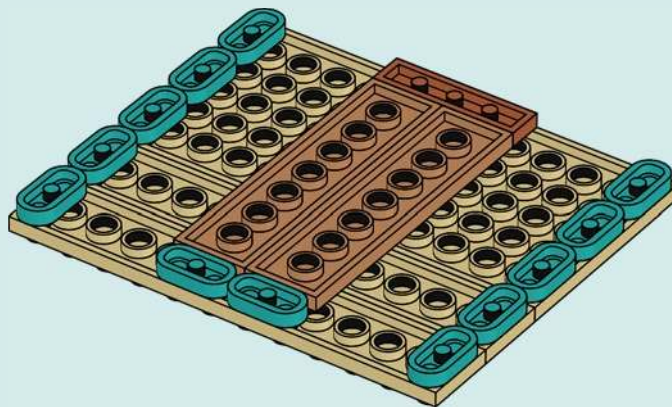

2x

69

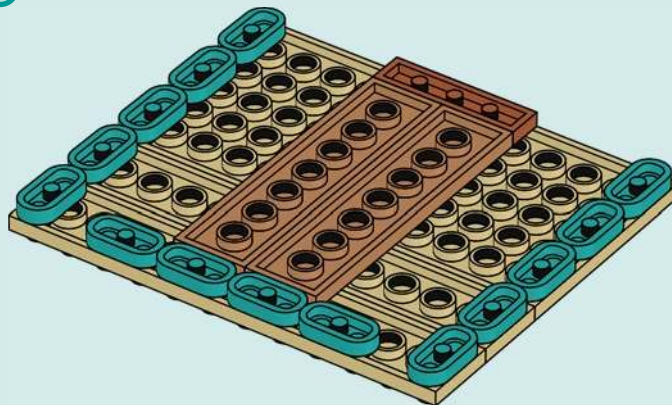

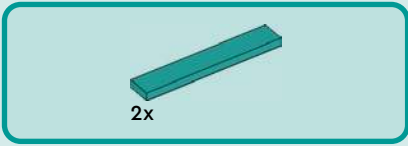

70

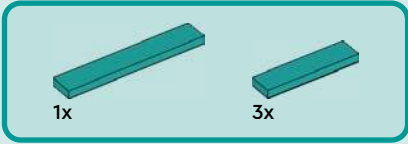
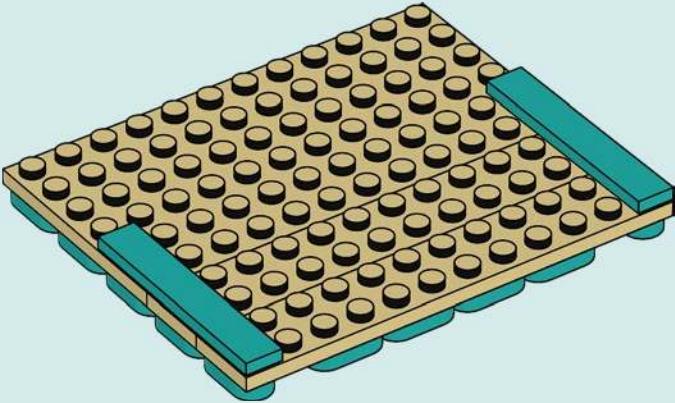

71

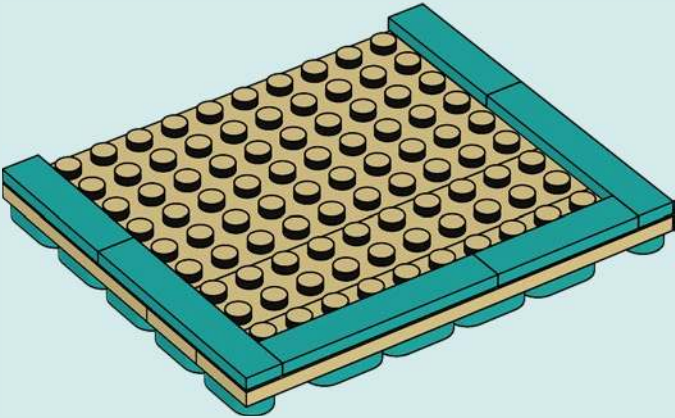



2x

72

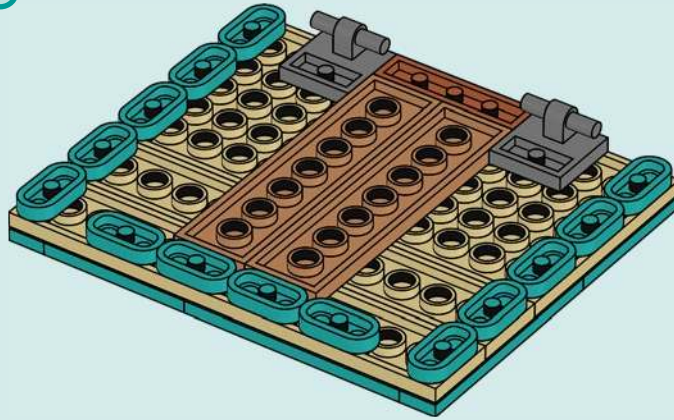

2x

73

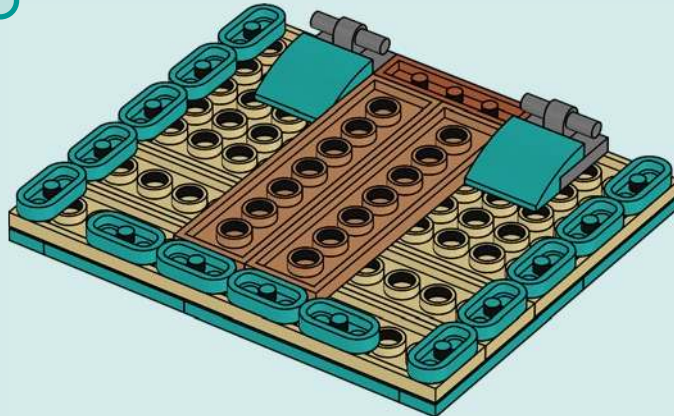

74

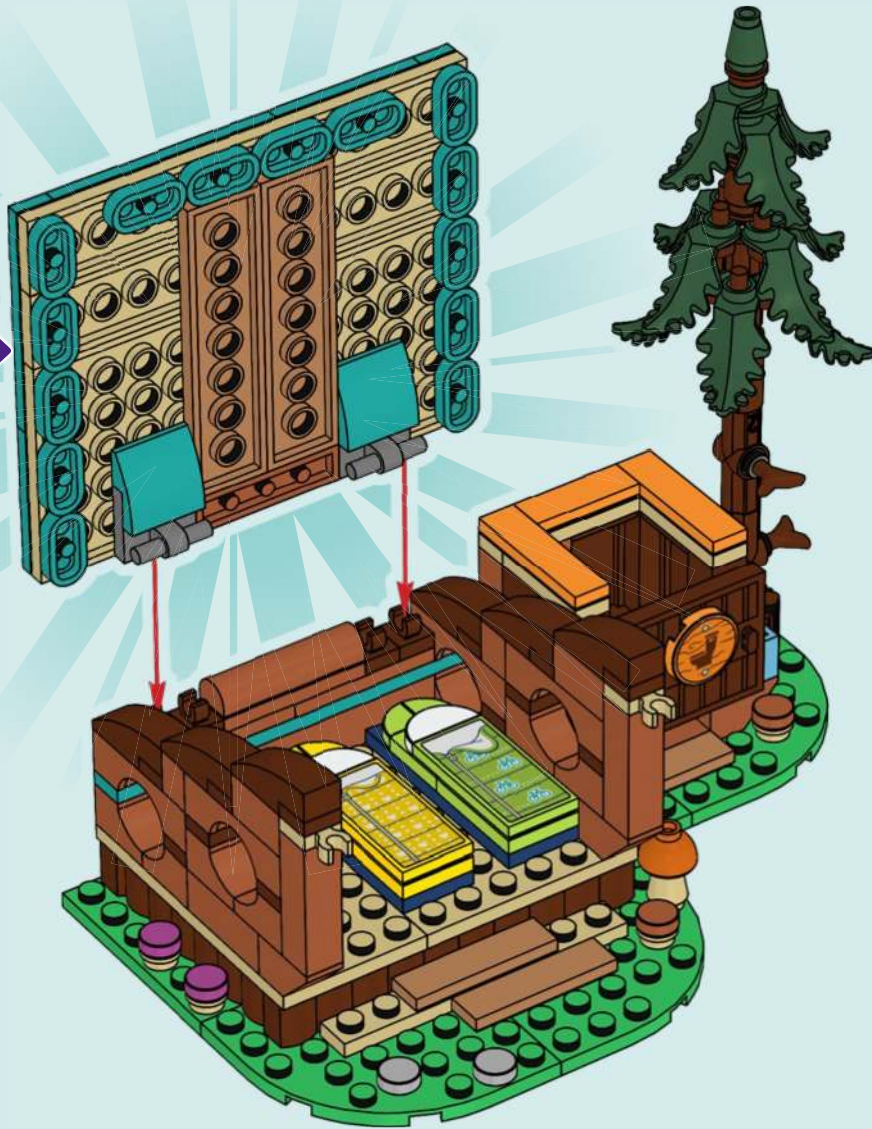

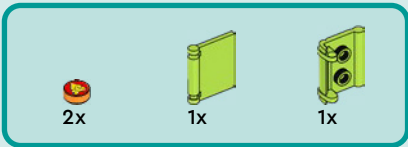

75

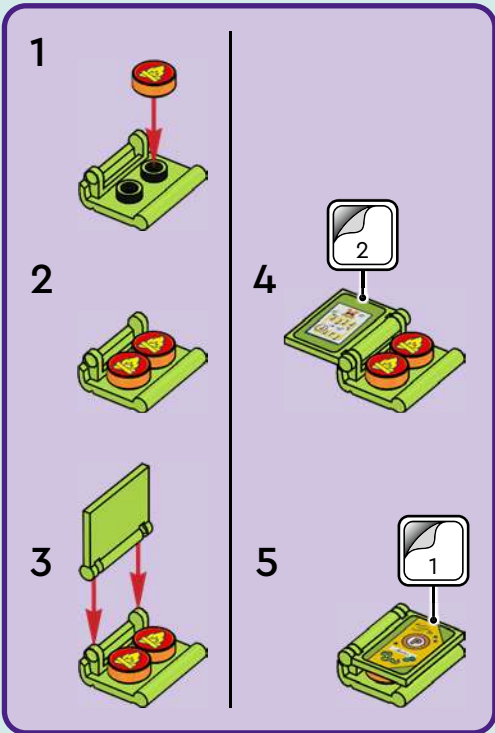



1x



1x

76





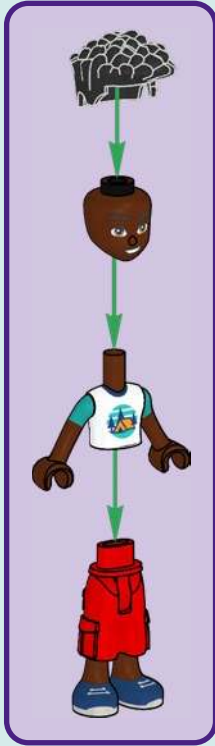

ZAC



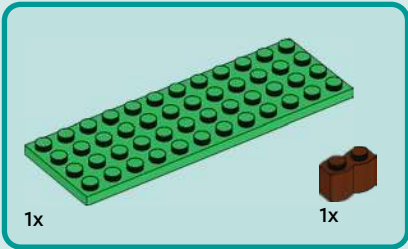
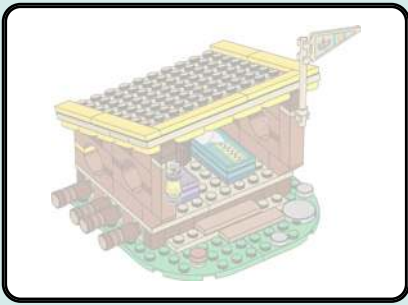

1

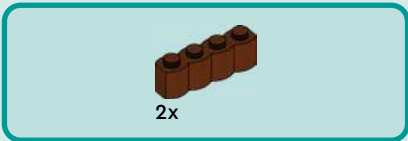
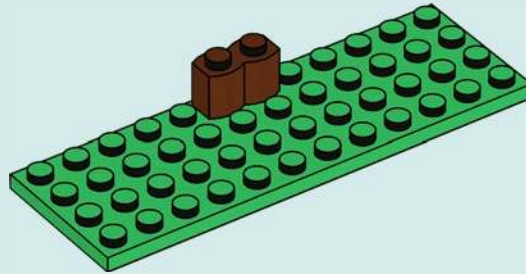

2

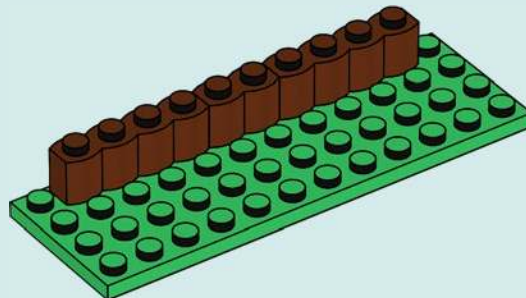



1x

3

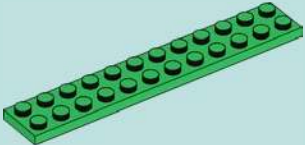
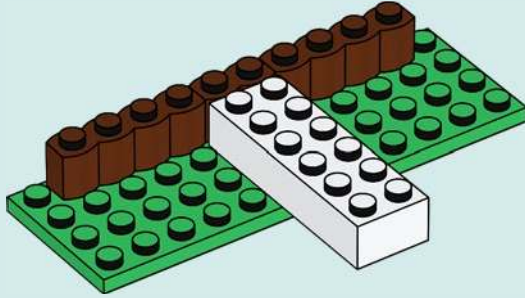

1x

4

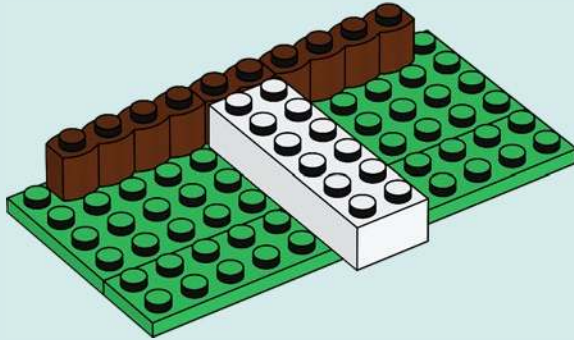

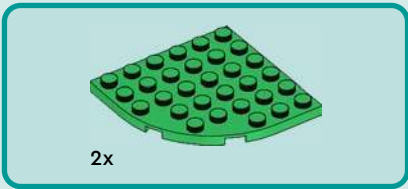

5

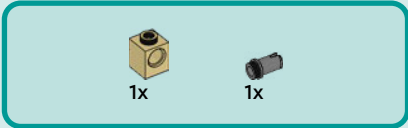
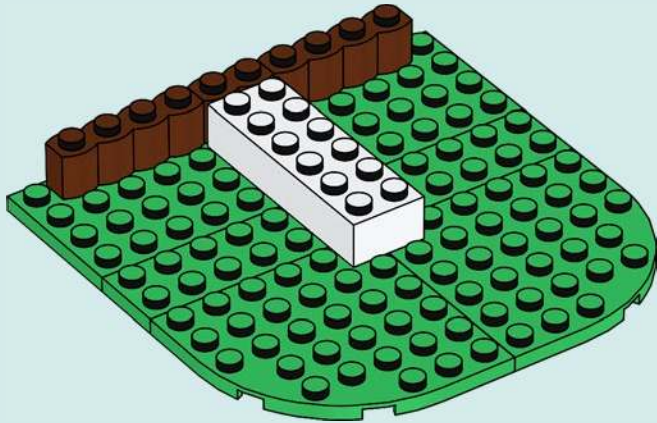

6

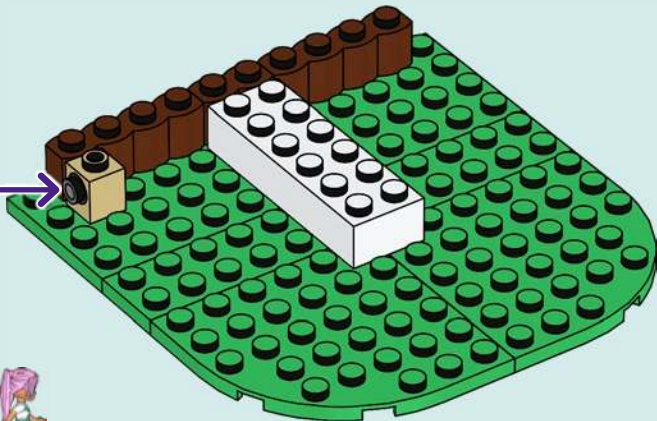
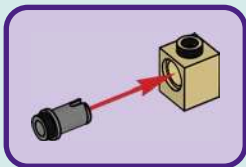



1x



1x

7

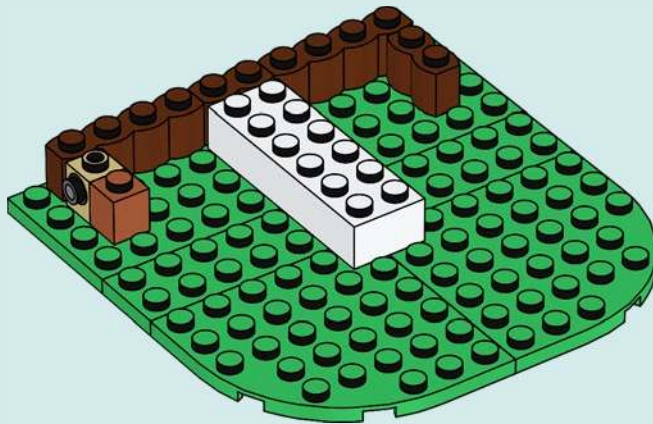

1x



2x

8

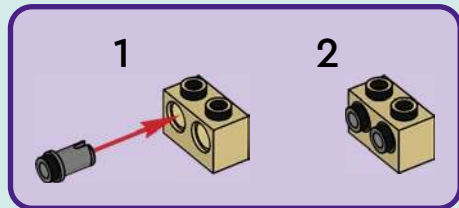

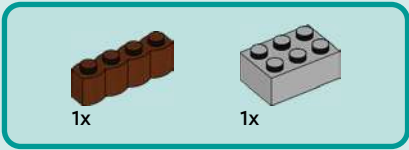

9

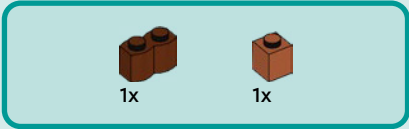
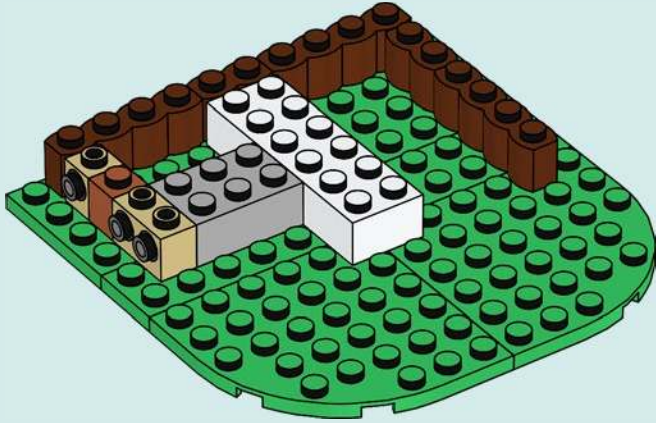

10

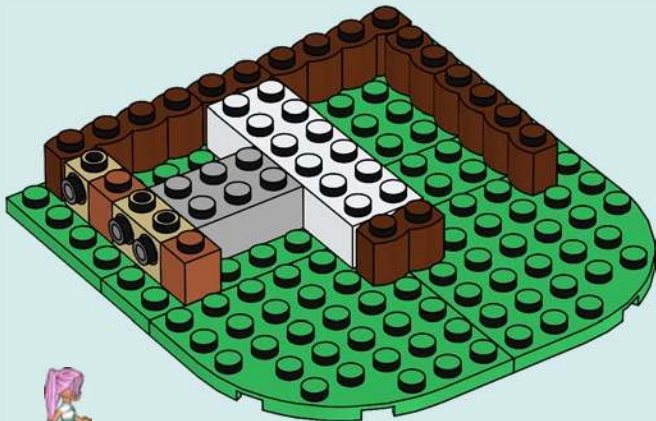



1x



1x

11

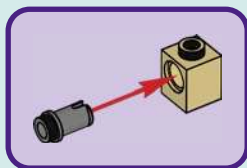

2x

12



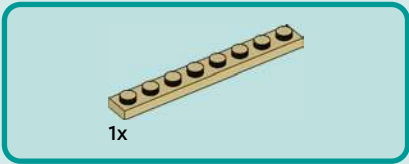

13

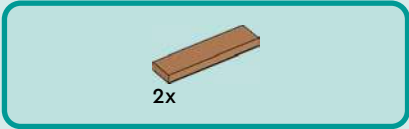
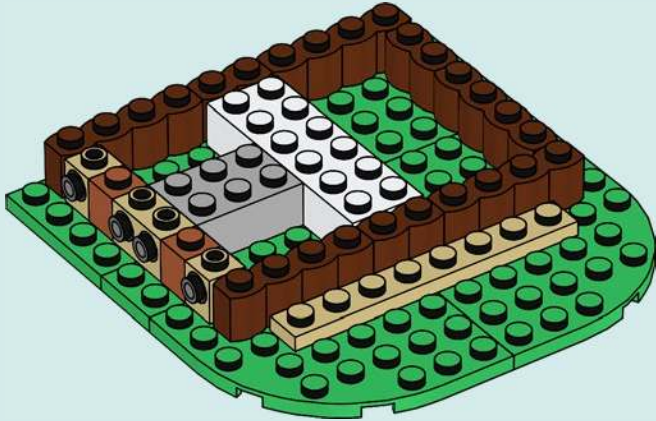

14



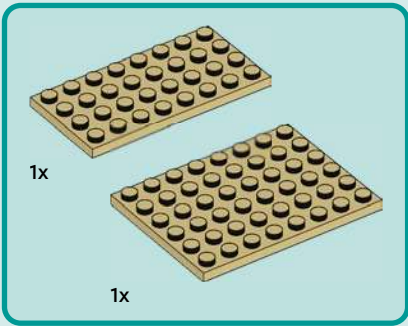

15

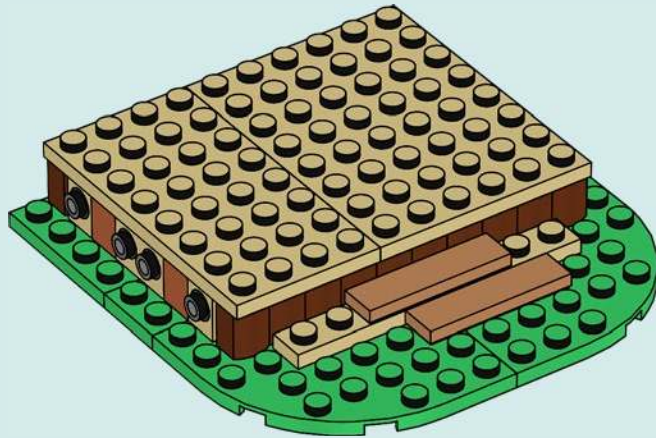

16

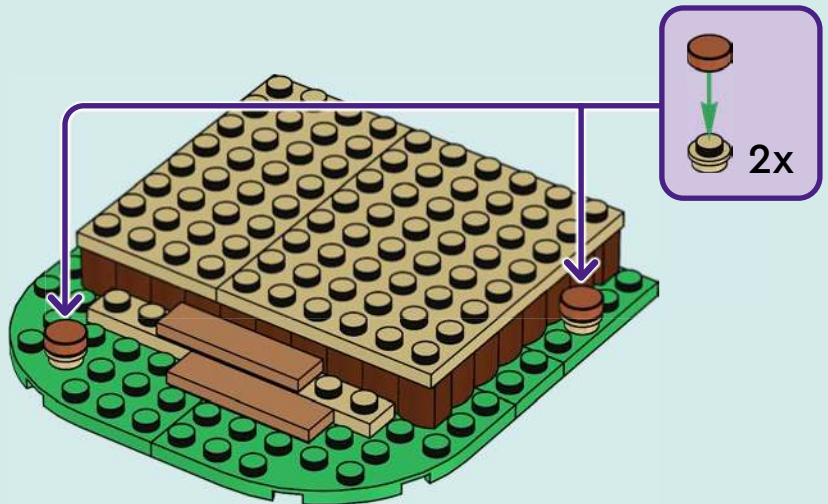



17

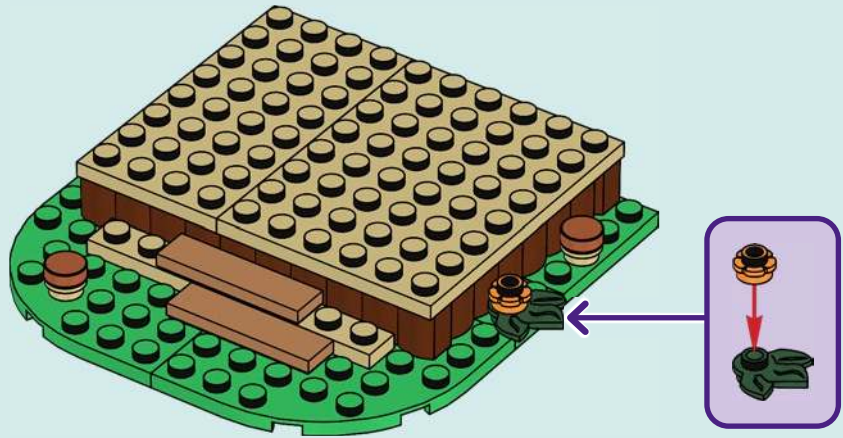

18

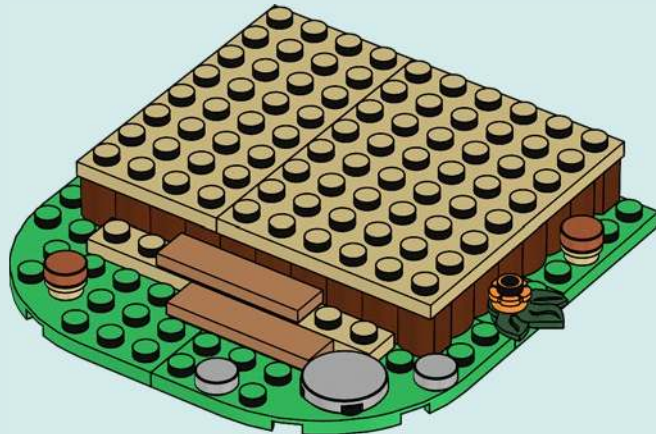

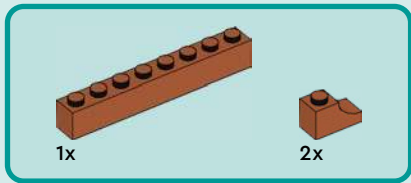

19

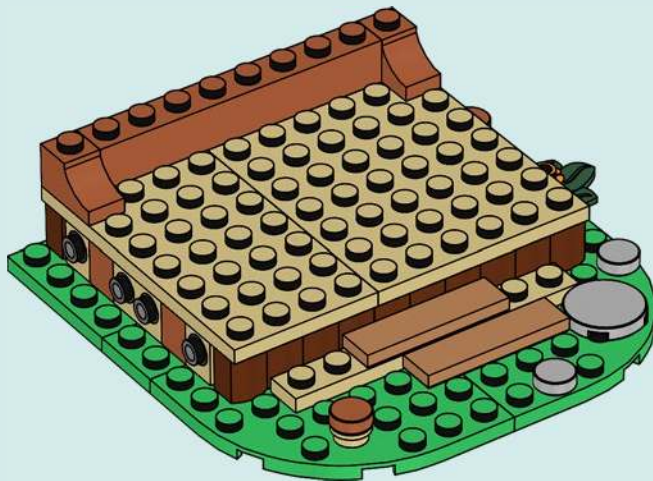
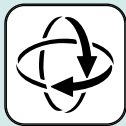



2x

20

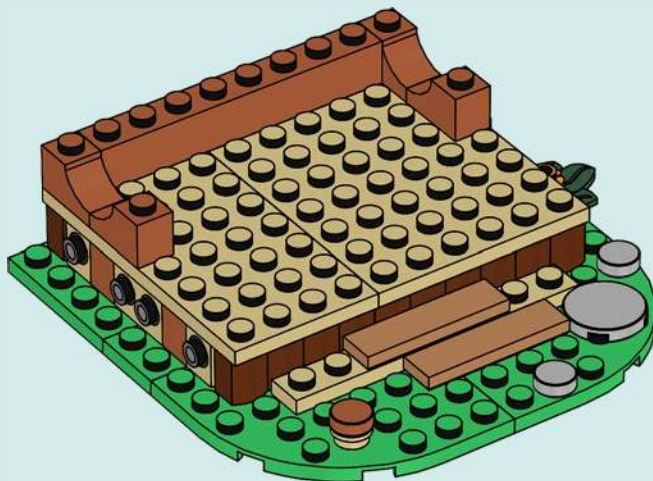

2x



2x

21

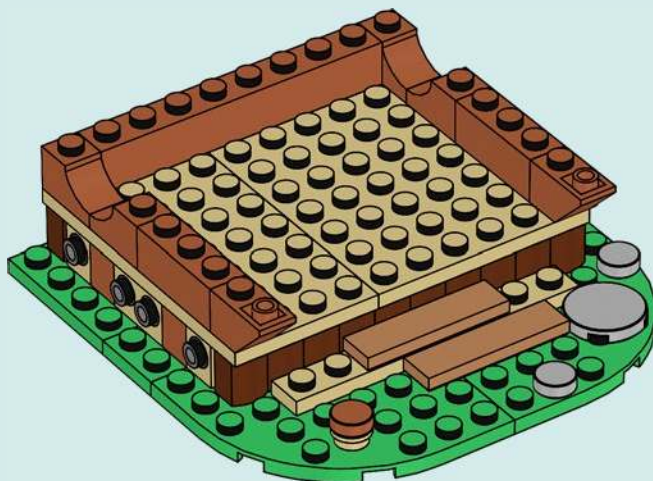

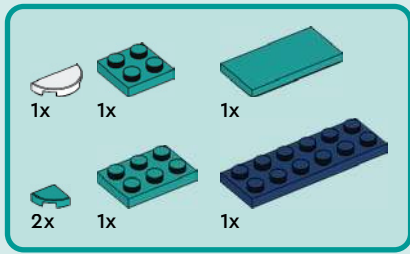

22

1

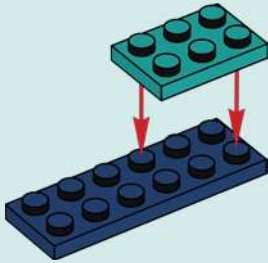

2



3

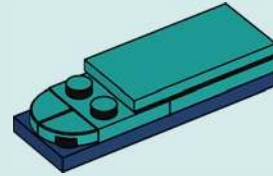

4

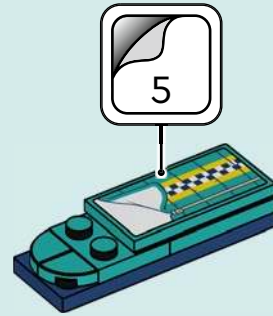

5

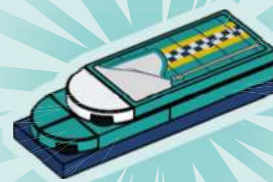

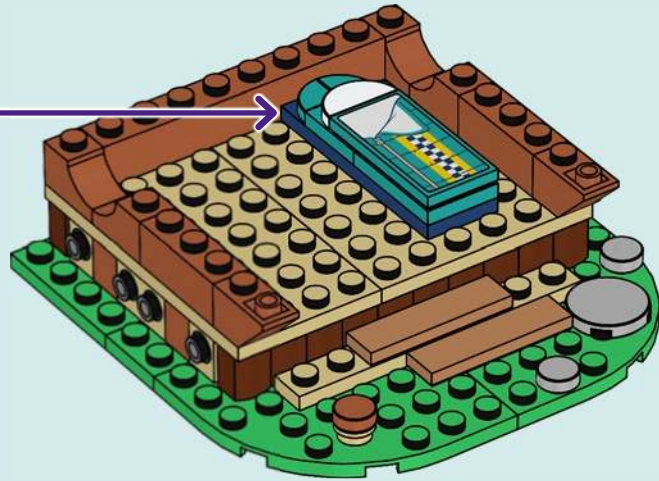

1x

23



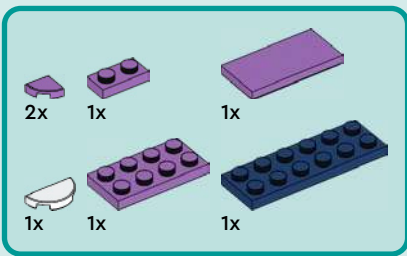

24

1

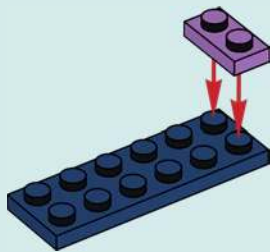

2

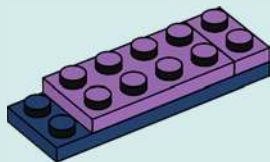

3

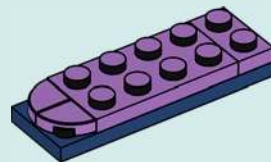

4

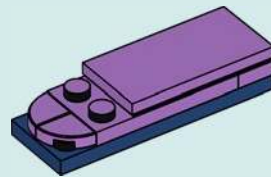

5

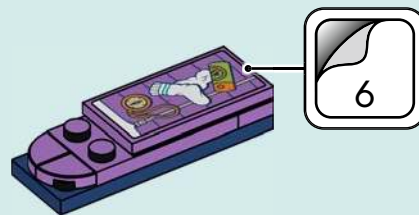

6



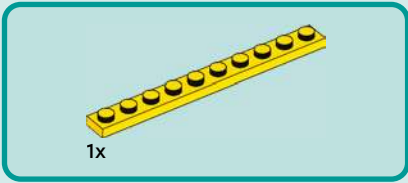

25



26



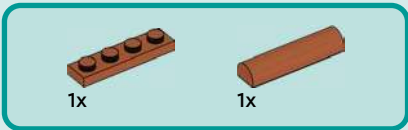

27

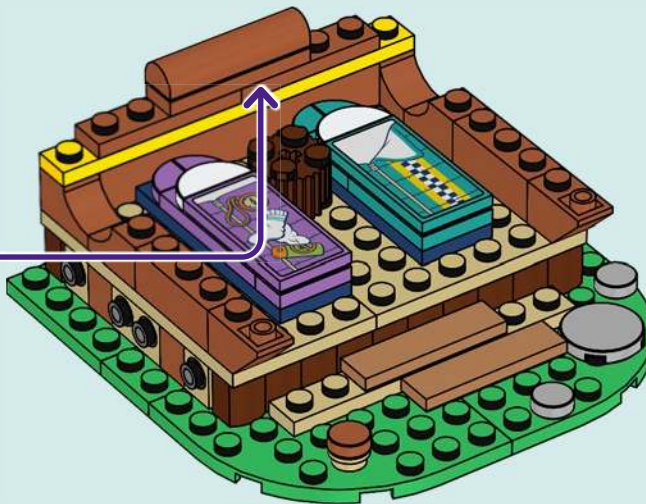
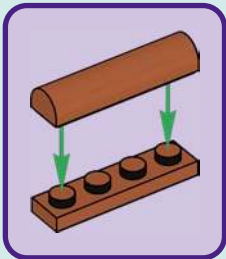

28





2x

29



2x

30





4x

31

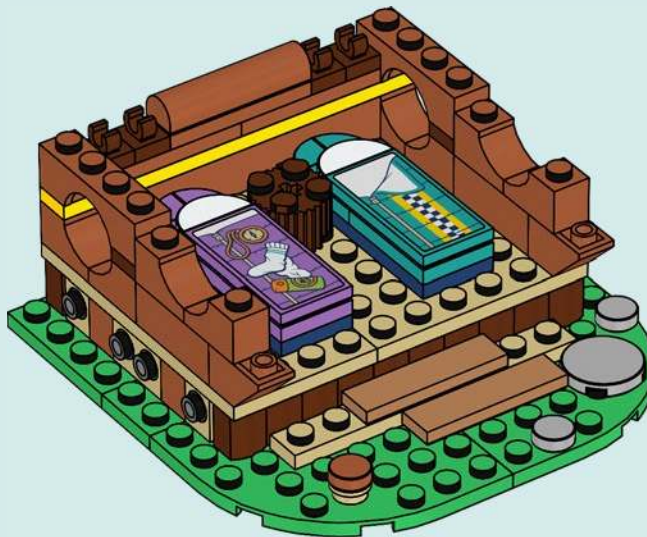

2x



2x

32

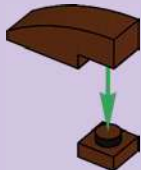
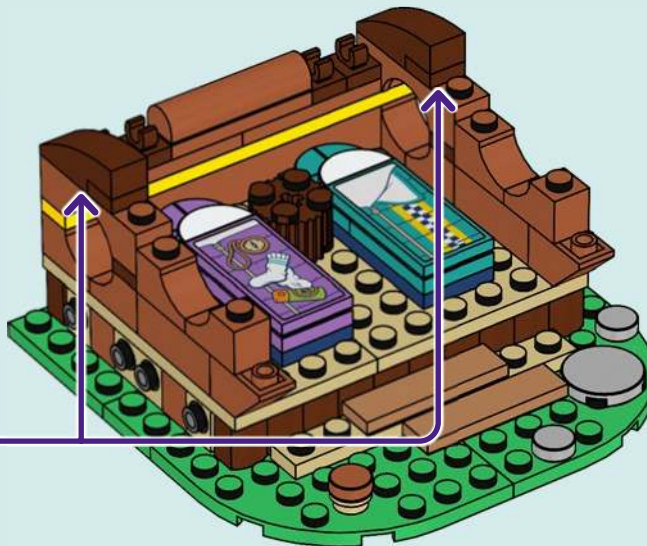

2x





2x

33



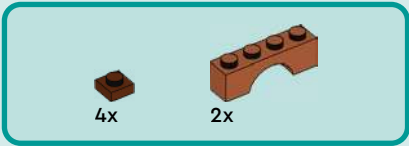

34

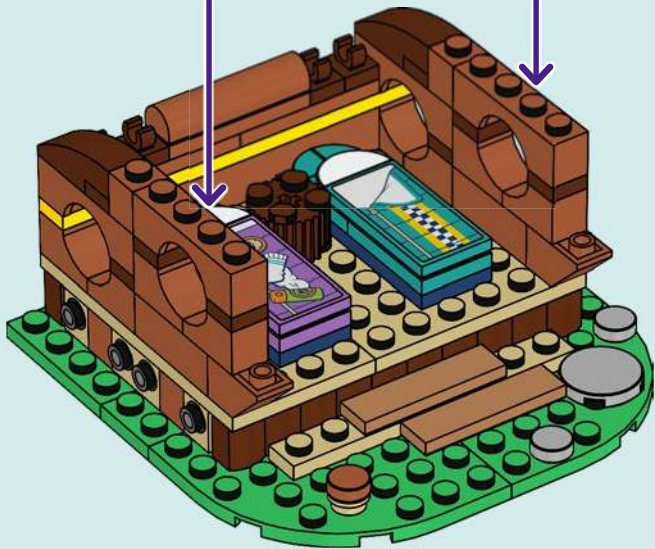
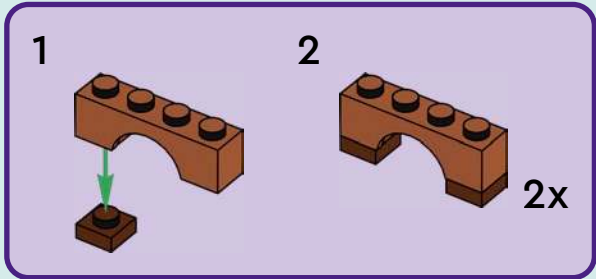



2x



2x

35

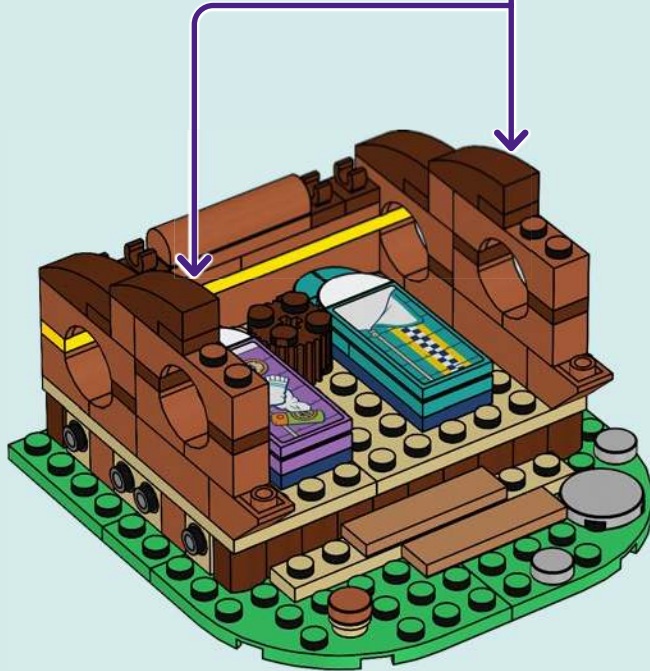



2x

36



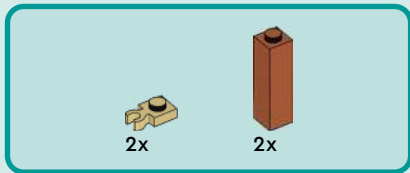

37

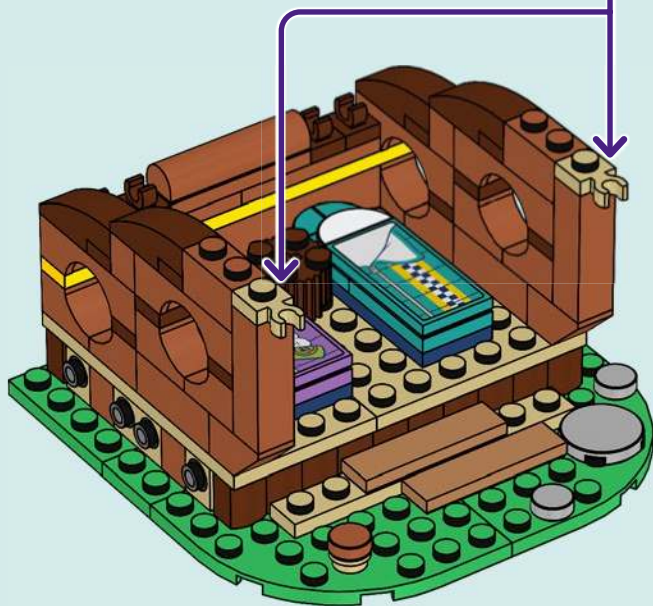
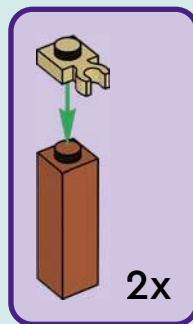



2x



2x

38

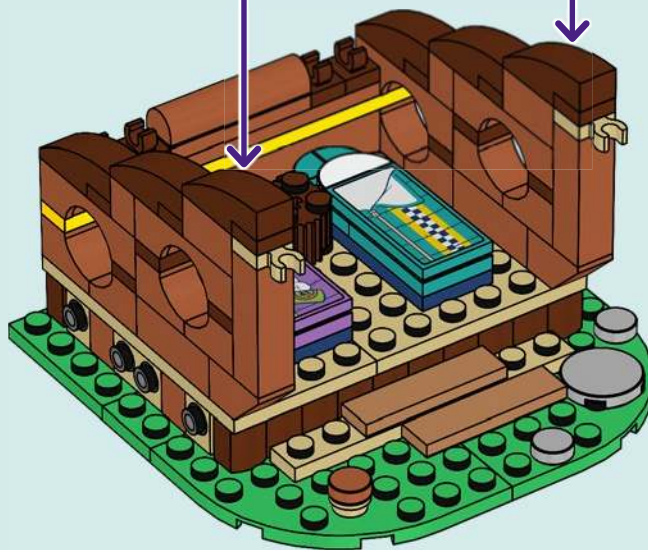
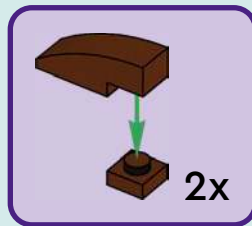

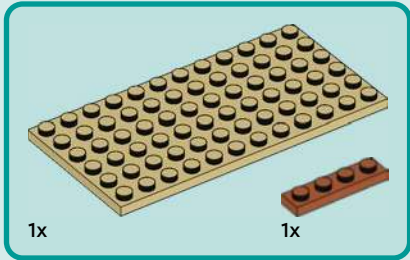

39

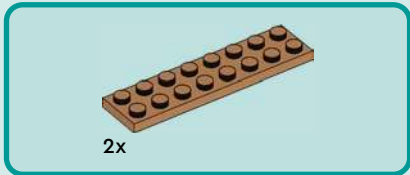
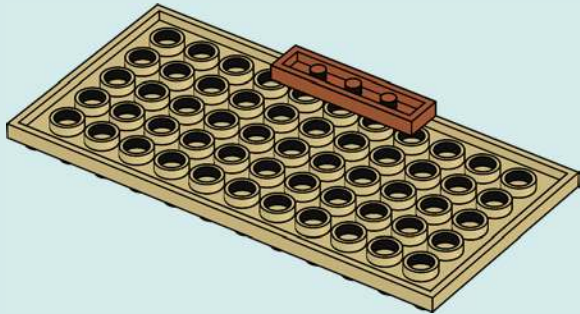

40

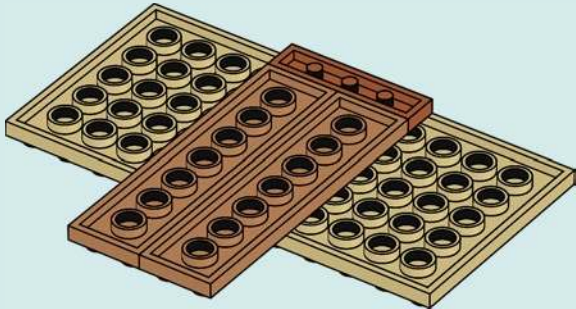

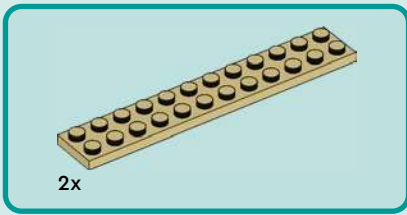

41

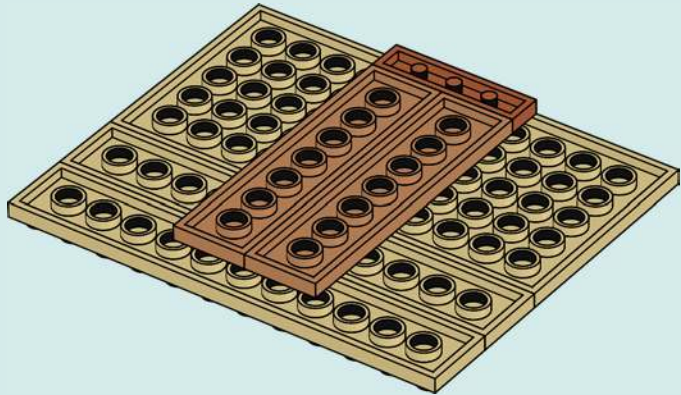

42





10x

43

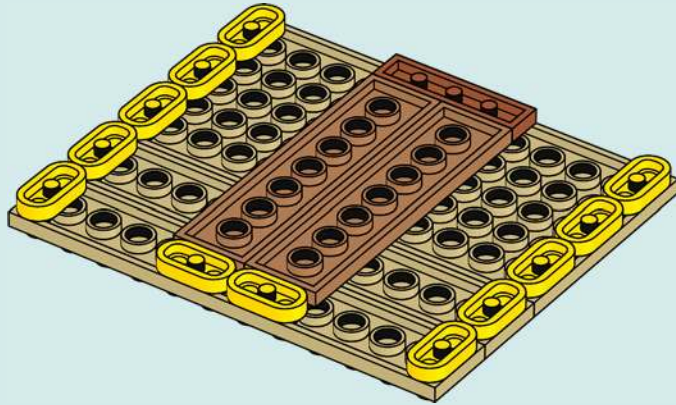

2x

44

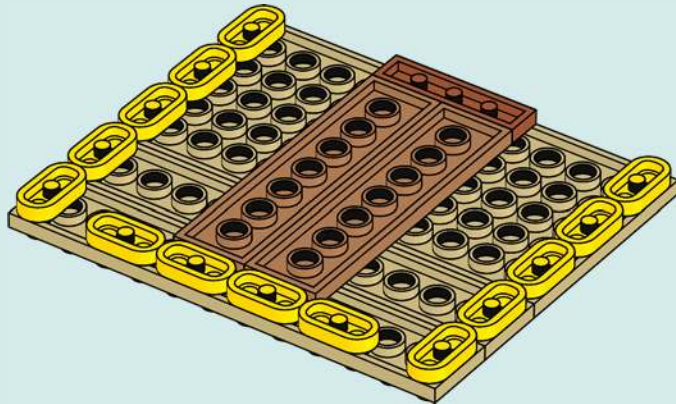

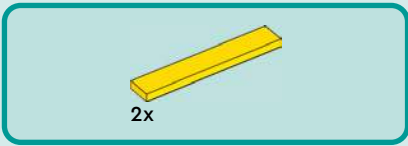

45

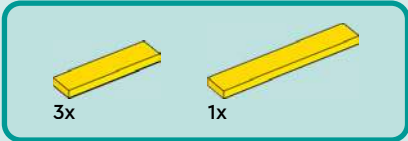
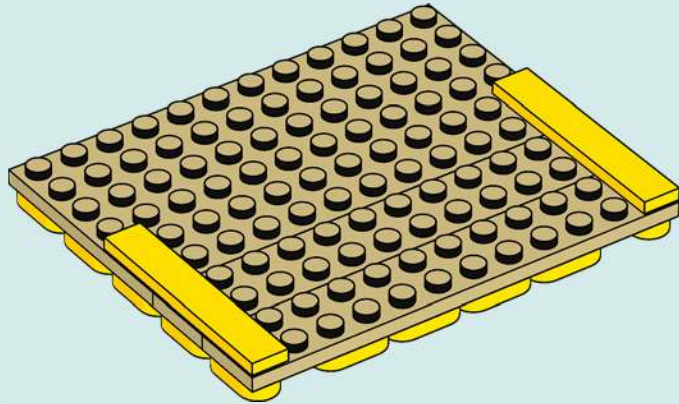

46

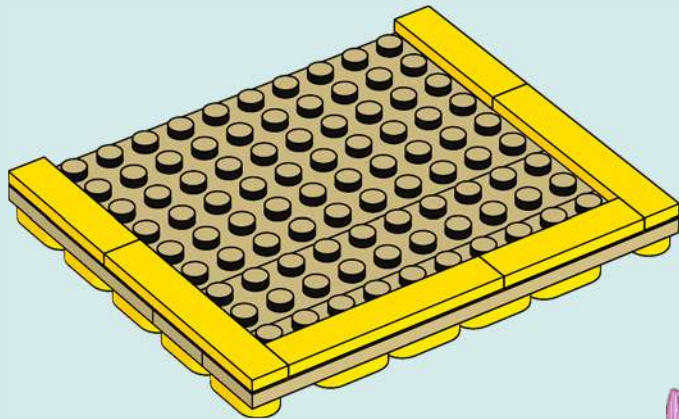



2x

47

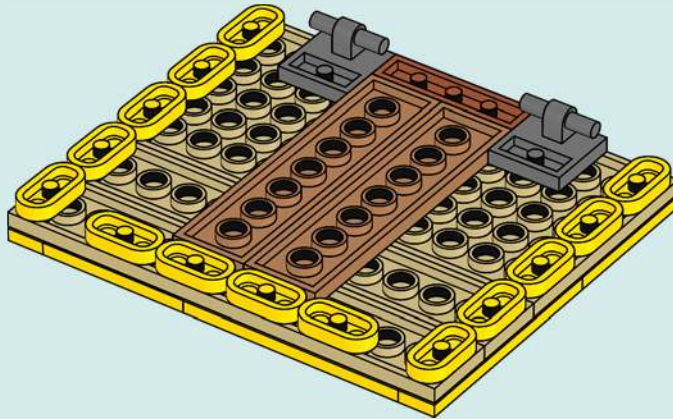



2x

48

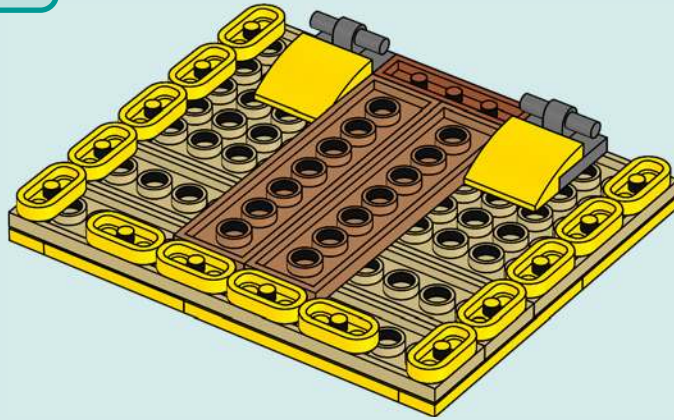

49

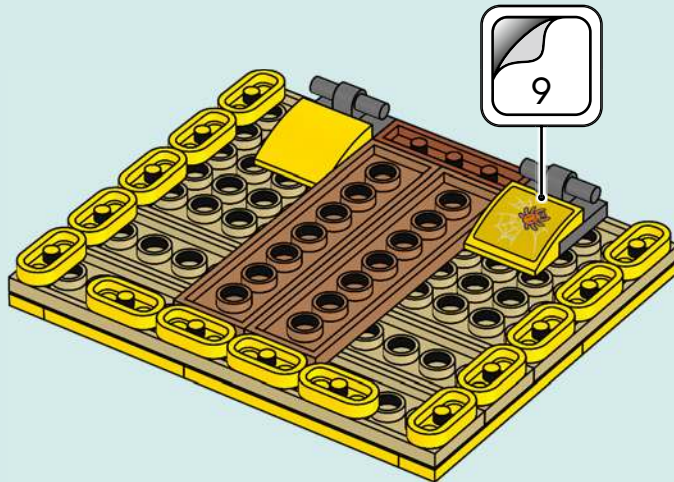

50

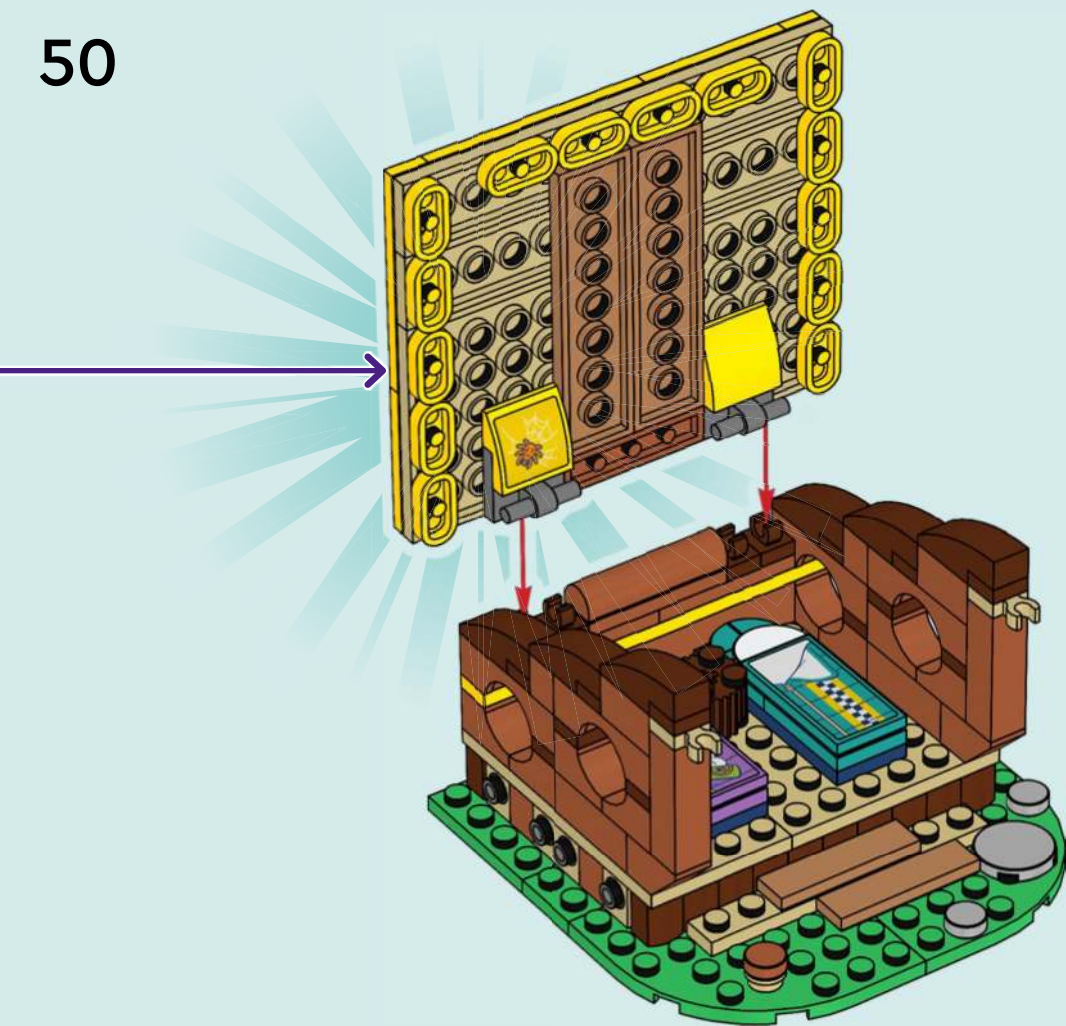

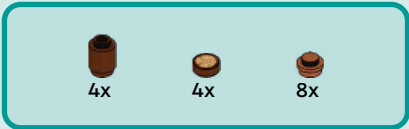

51

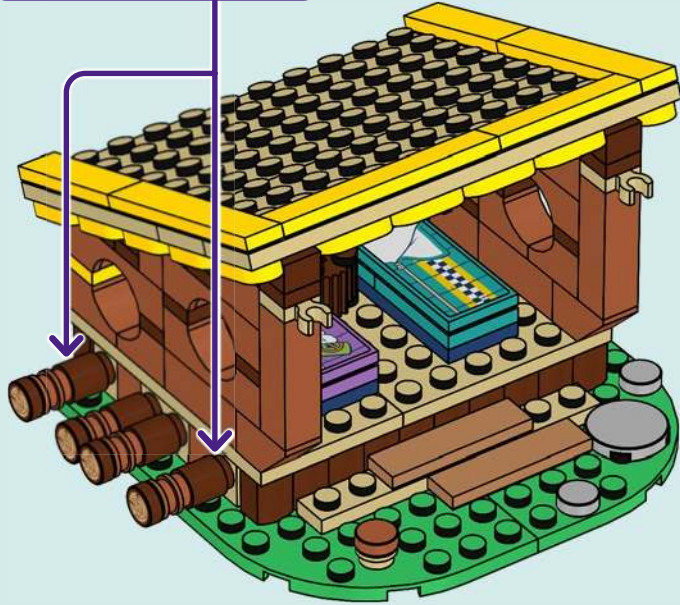
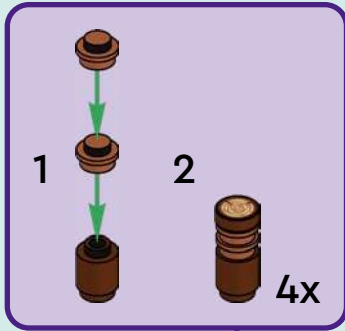



1x



1x



1x

# 52

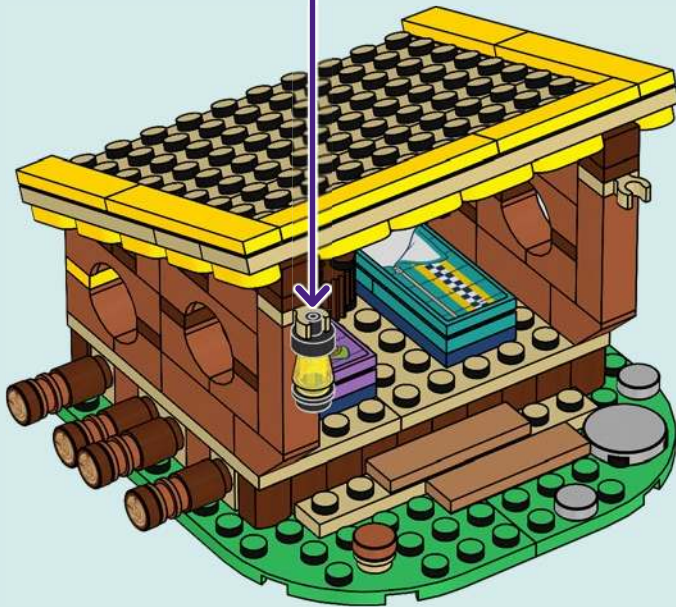
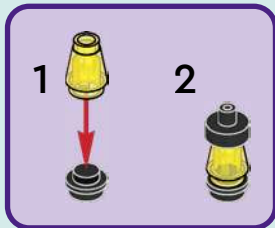



53

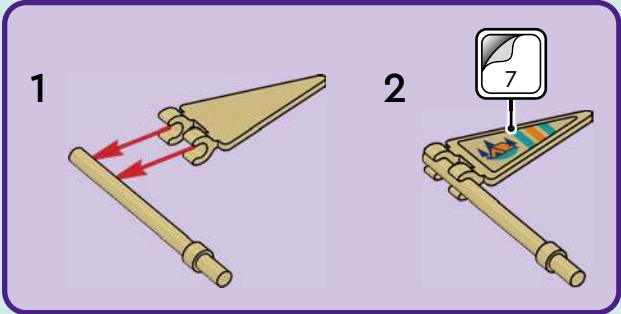





# Friends

WATCH  
SERIES  
ONLINE



WATCH SERIES ONLINE  
SCHAU DIR DIE SERIE ONLINE AN  
REGARDE LA SÉRIE EN LIGNE  
GUARDA LA SERIE ONLINE  
MIRA LA SERIE EN INTERNET  
ASSISTIR À SÉRIE ONLINE  
在线观看剧  
OGLĄDAJ SERIAL W INTERECIE

SLEDUJ SERIÁL ONLINE  
POZRI SI SERIÁL ONLINE  
NÉZD A SOROZATOT ONLINE  
VIZIONEAZĂ SERIALUL ONLINE  
ГЛЕДАЙТЕ СЕРИАЛА ОНЛАЙН  
SKATIES SERIĀLU TIEŠSAISTĒ  
VAATA SARJA VEEBIST  
ŽIŪRĒK SERIALĄ INTERNETU











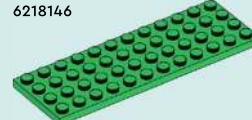

 7x  
 6168642  
 4x  
 6400114  
 1x  
 6434569  
 2x  
 4181142  
 7x  
 4161734  
 1x  
 4529237  
 2x  
 4179771  
 4x  
 6352222  
 1x  
 4666579  
 1x  
 4523145  
 2x  
 4121921  
 1x  
 6170776  
 2x  
 4118790  
 1x  
 6475813

 1x  
 6351905  
 2x  
 6254770  
 2x  
 4114324  
 2x  
 4509897  
 2x  
 6070501  
 4x  
 6093864  
 2x  
 6185313  
 1x  
 6478255  
 1x  
 6486016

 1x  
 6429941  
 1x  
 4206482  
 2x  
 6195183  
 14x  
 6248971  
 1x  
 302224  
 2x  
 6411332  
 1x  
 302124  
 3x  
 243124  
 1x  
 4560181  
 3x  
 663624  
 1x  
 6079138  
 1x  
 614126  
 1x  
 6186675  
 1x  
 6168646

 2x  
 4106347  
 1x  
 307026  
 2x  
 4109810  
 1x  
 6409770  
 4x  
 6064174  
 2x  
 6078610  
 1x  
 383526  
 2x  
 6133767  
 1x  
 6097194  
 5x  
 6021999  
 1x  
 4507311

 1x  
 6218146  
 1x  
 4279059  
 8x  
 6315782  
 5x  
 6322840  
 6x  
 6254484  
 4x  
 6397875  
 16x  
 6482692  
 6x  
 4579659  
 4x  
 6482689  
 1x  
 6315191  
 1x  
 6187575

 6x  
 6263221  
 3x  
 6340118  
 8x  
 6074892  
 2x  
 6439724  
 8x  
 6441766  
 2x  
 6264069  
 1x  
 6337597  
 1x  
 6214234  
 2x  
 6484357  
 1x  
 6092770  
 1x  
 4620693  
 2x  
 4160593  
 1x  
 6475812

2x  
6240467  
1x  
6469022  
1x  
6483118  
14x  
6482693  
1x  
6249390  
2x  
6222950  
1x  
6249417  
3x  
6292786  
1x  
6223065  
3x  
6264986  
1x  
6433414  
2x  
6209692  
2x  
6211875  
1x  
6258352

1x  
6258353  
1x  
4537937  
1x  
6013530  
1x  
6212989  
2x  
6322816  
1x  
6138657  
1x  
6132790  
4x  
6097420  
1x  
6411591  
1x  
6400754  
12x  
6447541  
1x  
6409769  
2x  
6357747  
4x  
6174023

2x  
6314353  
5x  
4211183  
4x  
6285623  
3x  
6215659  
1x  
6416487  
27x  
4221744  
8x  
6348057  
2x  
6177699  
1x  
4620075  
2x  
6483392  
2x  
6325717  
3x  
6036503  
7x  
4211180  
2x  
6078605

1x  
6173132  
3x  
6398342  
1x  
6484671  
2x  
6333110  
12x  
6325975  
3x  
6116613  
11x  
4211181  
2x  
4211190  
1x  
6438484  
7x  
6284071  
1x  
4211412  
1x  
4211503  
1x  
6052200

2x  
4211386  
1x  
6303438  
7x  
6395635  
2x  
6221607  
4x  
6457961  
4x  
6215606  
3x  
6167643  
3x  
6368592  
1x  
6371952  
5x  
6102998  
4x  
6226644

1x  
6482272  
1x  
6478257  
1x  
4618670  
4x  
6413492  
1x  
6400762  
1x  
6248486  
1x  
6495221

1x  
6416490  
1x  
6484662  
2x  
6199893  
1x  
6484627  
1x  
4619512  
1x  
4619516  
1x  
4651902



 [LEGO.com/service](https://www.LEGO.com/service)

YOU COULD

WIN

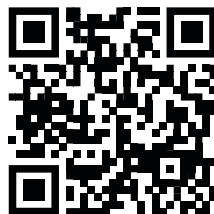

Scan this QR code or go to  
**LEGO.COM/PRODUCTFEEDBACK** and give us  
your short feedback about this LEGO® set for a  
chance to win a cool LEGO prize.

Terms and Conditions apply\*

**EN: YOU COULD WIN.** Terms and Conditions apply\* **DE: Du könntest GEWINNEN.** Es gelten die Teilnahmebedingungen\* **FR: Tu pourrais GAGNER.** Des conditions s'appliquent\* **IT: Potresti VINCERE tu.** Termini e condizioni sono applicabili\* **ES: Puedes GANAR.** Aplican términos y condiciones\* **PT: Poderá GANHAR.** Aplicam-se termos e condições\* **ZH: 轻松获奖. 条款和条件适用\*** **PL: Szansa na WYGRANĄ.** Obowiązują warunki korzystania\* **CS: Máte šanci VYHRÁT.** Platí všeobecné smluvní podmínky\* **SK: Máte šancu VYHRAŤ.** Platia všeobecné zmluvné podmienky\* **HU: TE IS NYERHETSZ.** Felhasználási feltételek érvényesek\* **RO: Ai putea CÂȘTIGA.** Se aplică termeni și condiții\* **BG: Можете да СПЕЧЕЛИТЕ.** Има определени правила и условия\* **LV: Tu vari LAIMĒT.** Ir spēkā noteikumi un nosacījumi.\* **ET: Sul on võimalus VÕITA.** Kehtivad tingimused\* **LT: Jūs galite LAIMĖTI.** Taikomos sąlygos\*

\*[LEGO.com/productfeedback-terms](https://www.lego.com/productfeedback-terms)

LEGO, the LEGO logo and the Friends LOGO are trademarks of the LEGO Group. ©2024 The LEGO Group.

6521567