



76288





Q LEGO® Builder



[LEGO.com/sustainable-packaging](https://LEGO.com/sustainable-packaging)



**FR**  
**DONNEZ**  
OU  
**RECYCLEZ**

 OU  OU 

ASSOCIATION    MAGASIN    DÉCHÈTERIE

Adresses sur [quefairedemesdechets.fr](https://quefairedemesdechets.fr)



# BUILDER



Apple and the Apple logo are trademarks of Apple Inc., registered in the U.S. and other countries and regions. App Store is a service mark of Apple Inc. Google Play and the Google Play logo are trademarks of Google LLC. Tencent and the Tencent logo are trademarks of Tencent Inc.



**EN** Ask parents' permission before going online | **DE** Eltern um Erlaubnis bitten, bevor du online gehst | **FR** Demande l'autorisation d'un parent avant d'aller en ligne | **IT** Chiedi il permesso ai tuoi genitori prima di andare online | **ES** Pídeles permiso a tus papás antes de conectarte a Internet | **PT** Pede autorização aos pais antes de acederes online | **ZH** 上网前应先征得父母的同意 | **PL** Poproś rodziców o zgodę, zanim wejdiesz do Internetu | **CS** Než půjdeš na internet, požádej rodiče o svolení | **SK** Skôr než pôjdeš na internet, vypýtaj si povolenie od rodičov | **HU** Kérj szülői engedélyt, mielőtt online csatlakoznál! | **RO** Cere permisiunea părinților înainte de a te conecta online | **BG** Поискайте разрешение от родител, преди да влезете онлайн | **LV** Pirms došanās tiešsaistē palūdz atļauju vecākiem | **ET** Enne Interneti kasutamist küsi vanematelt luba | **LT** Prieš prisijungdami prie interneto, atsiklauskite tėvų



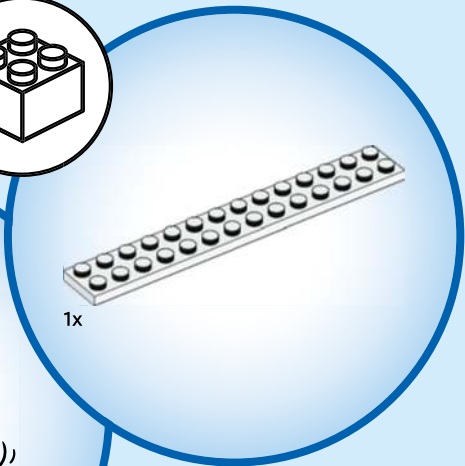
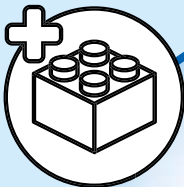

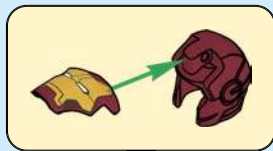
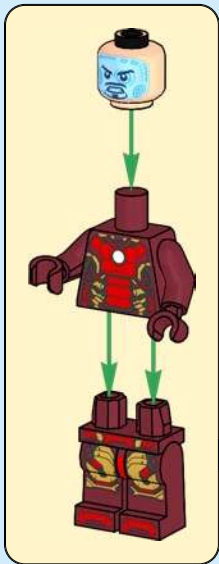



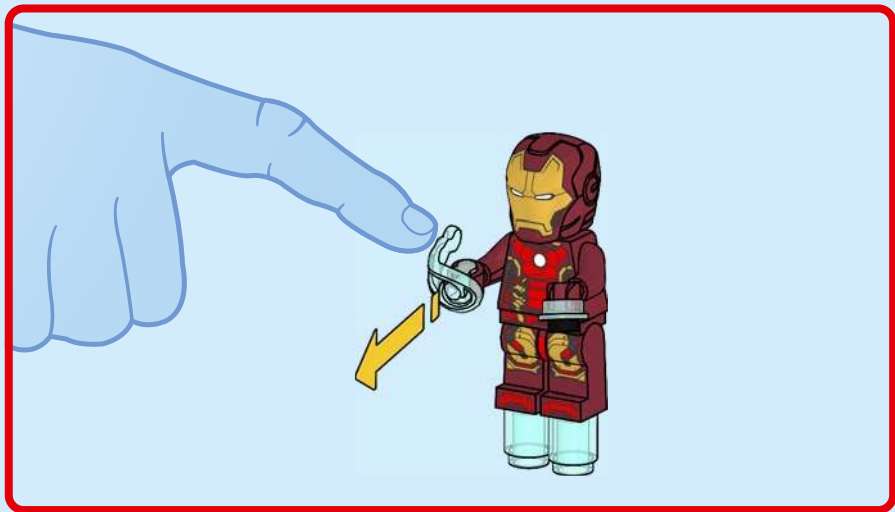

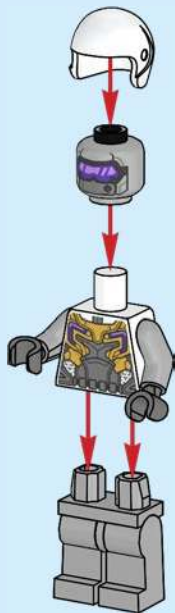

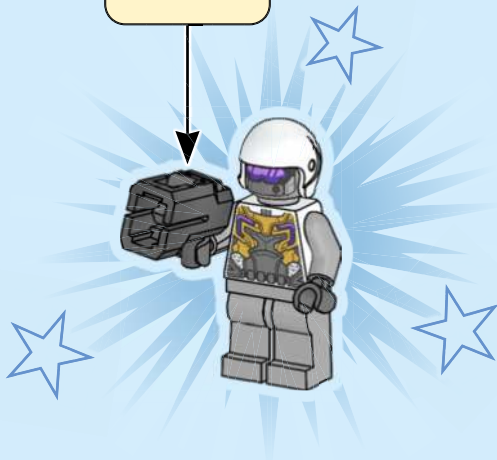
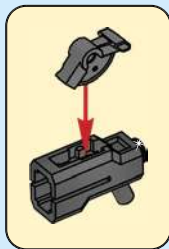



2x

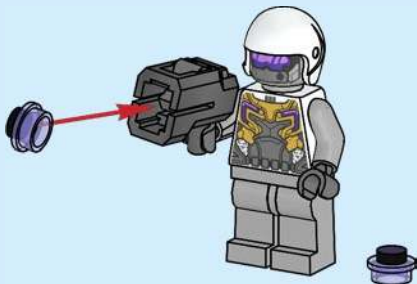

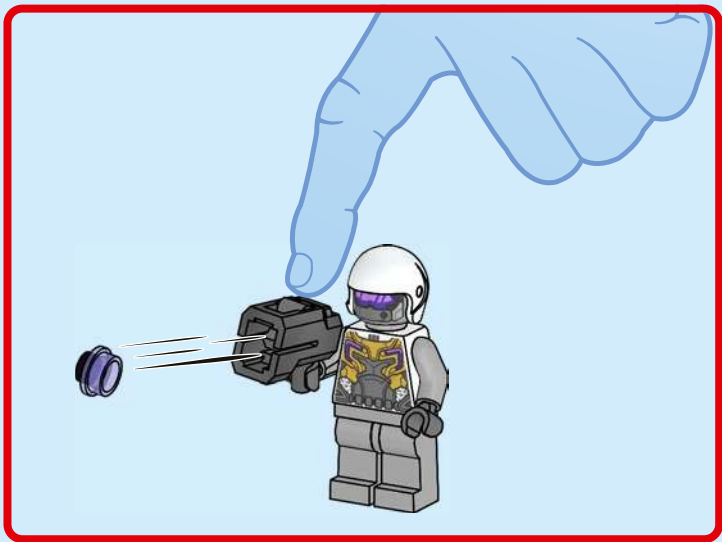

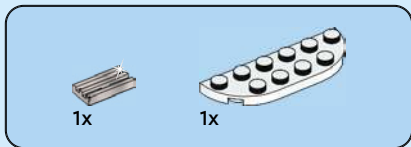

1

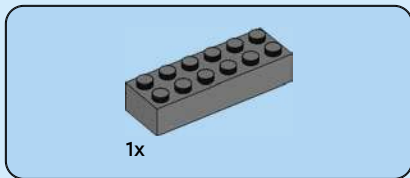
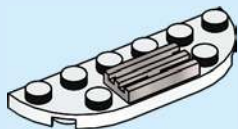

2

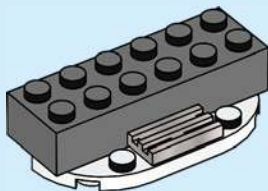

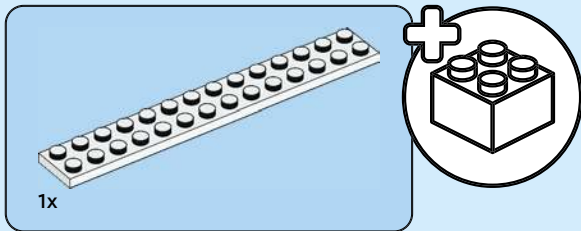

3

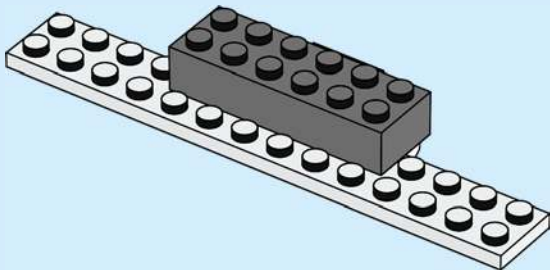



2x



1x

4



2x

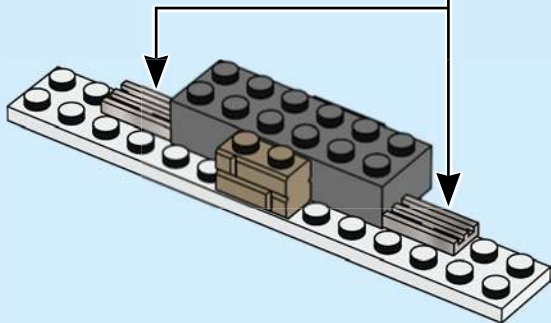



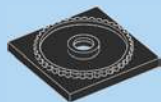

1x

6

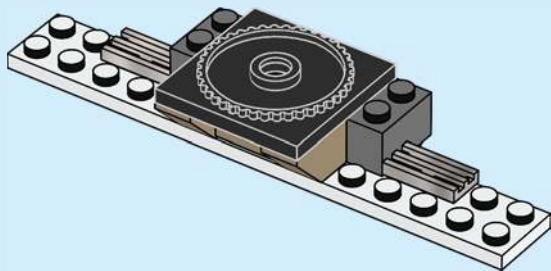



4x

7

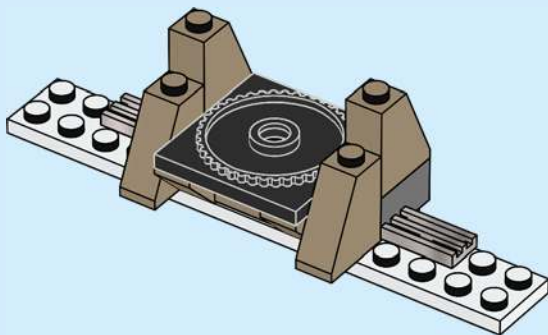



2x



2x

8

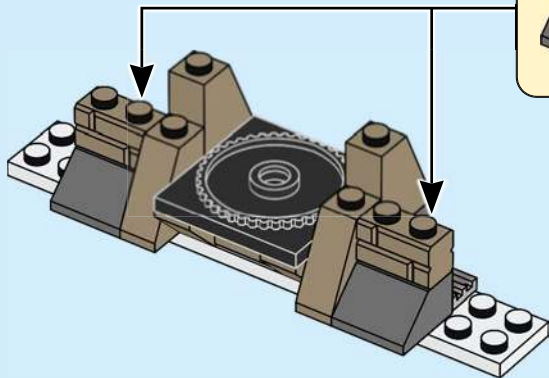

2x





2x

9

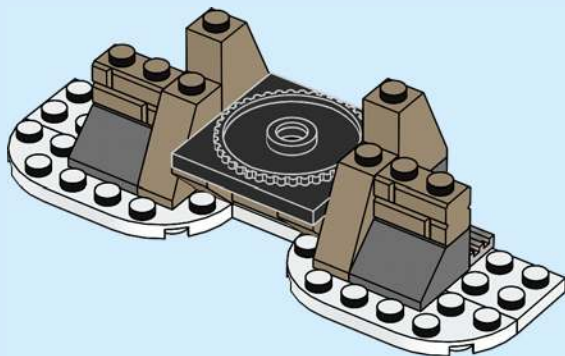



4x

10

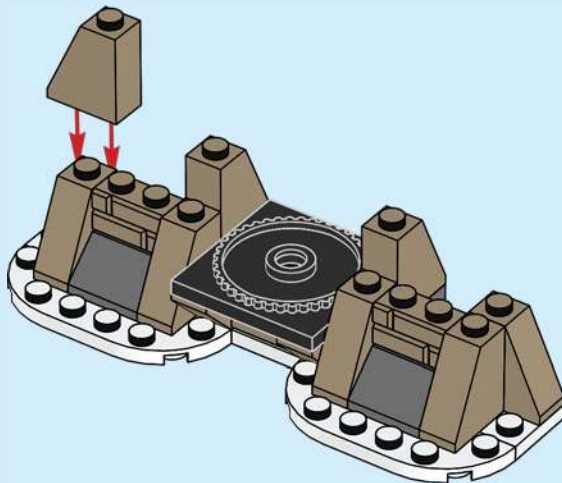



3x

11

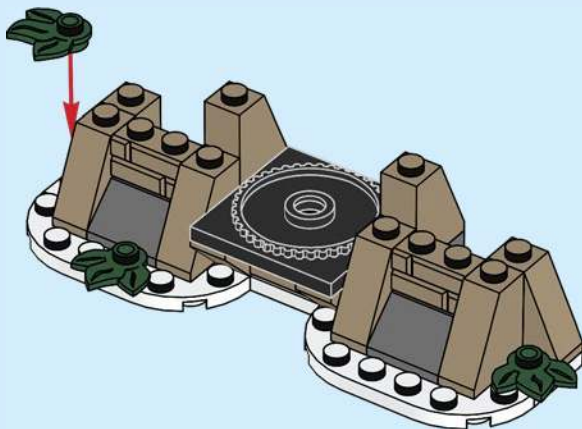



1x



12

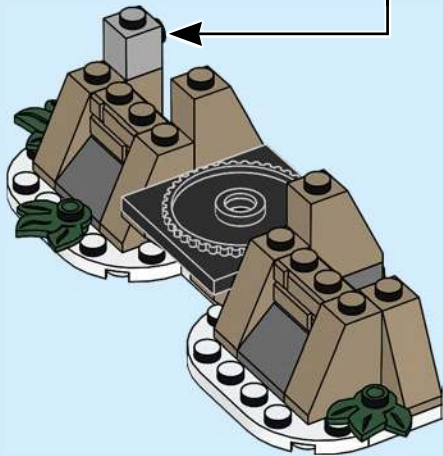



1x



1x

# 13

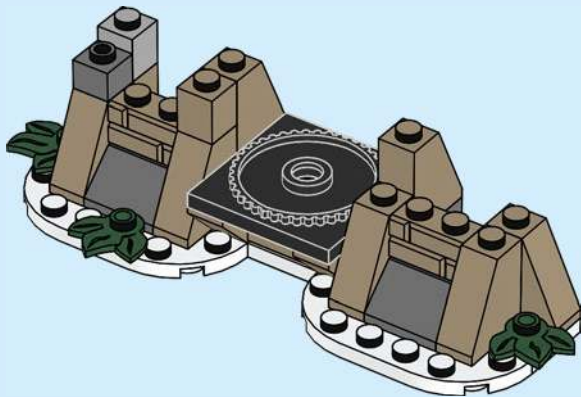



1x



1x

# 14

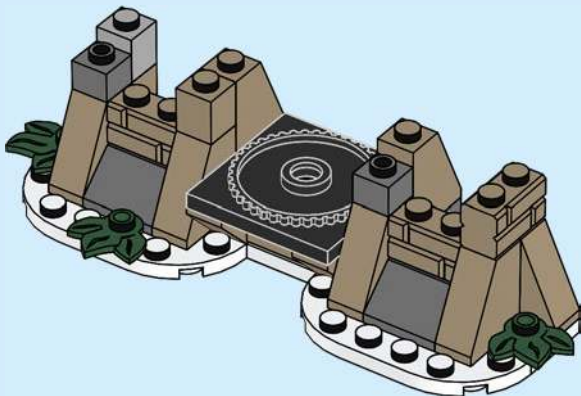



2x

15

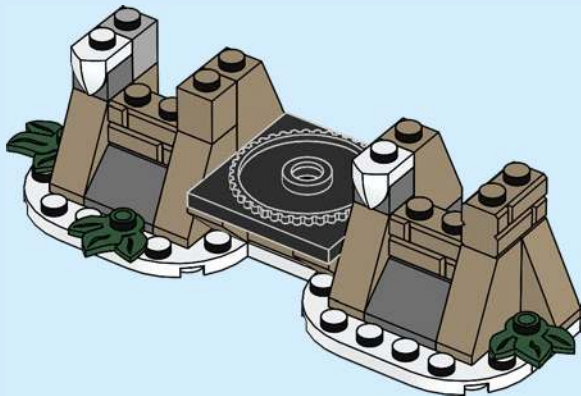



2x

16

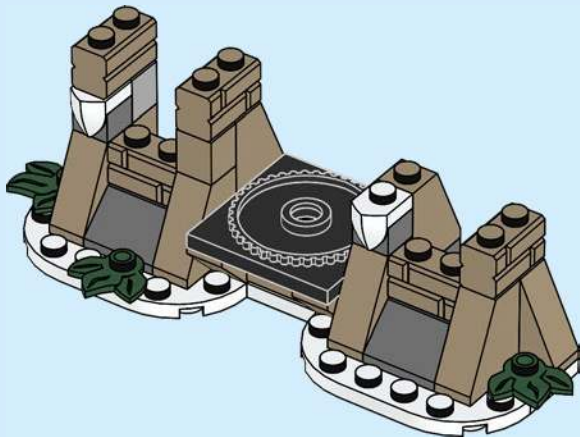



1x



1x



1x

# 17

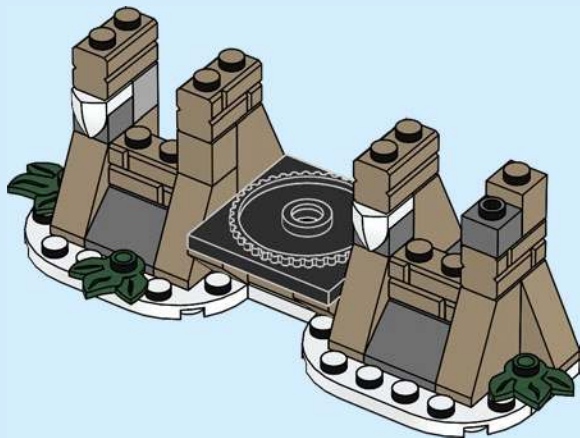



1x



2x

18

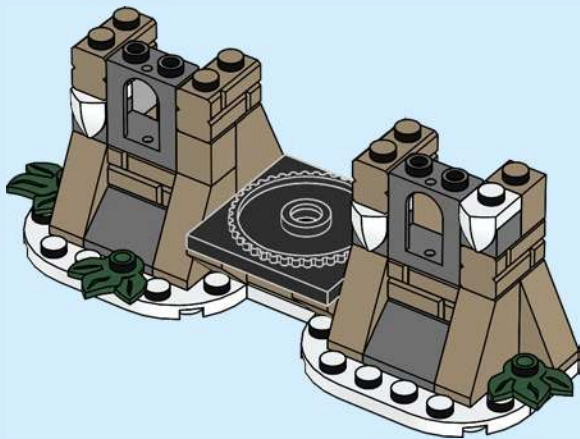



2x

19

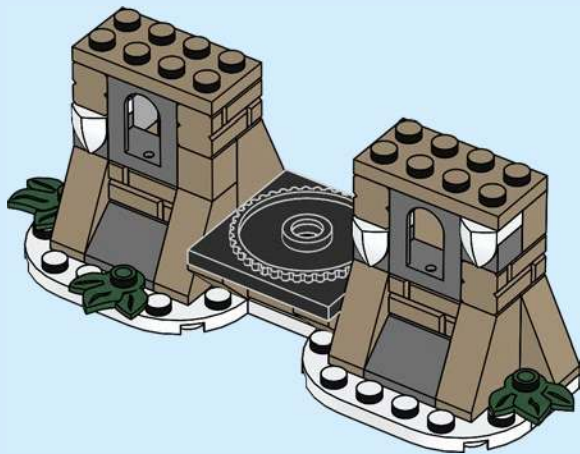



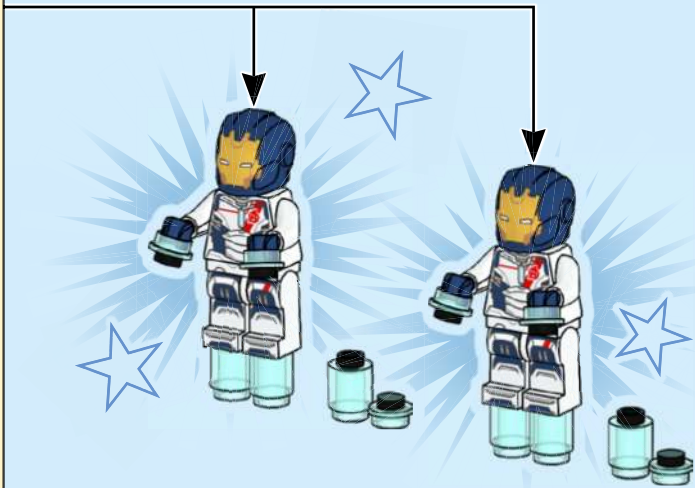
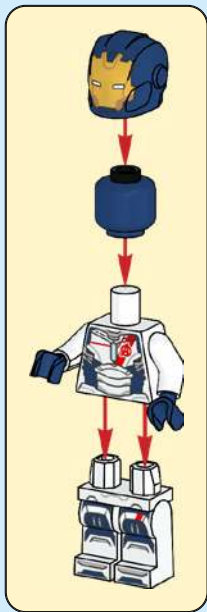

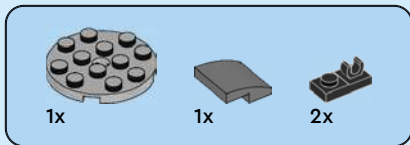

# 20

1



2



3



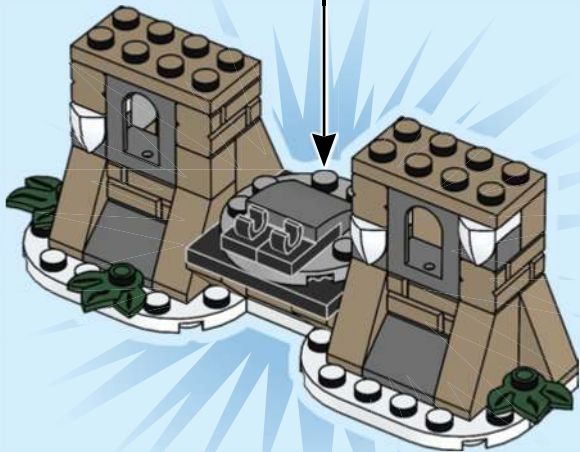

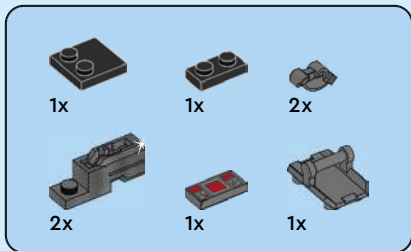

21

1

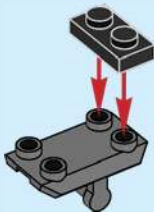

2



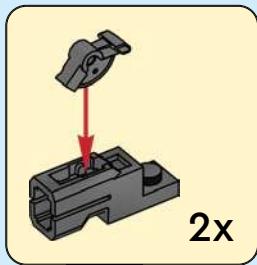

3

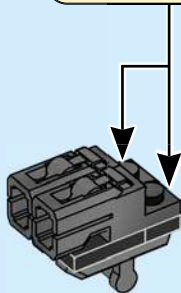

4

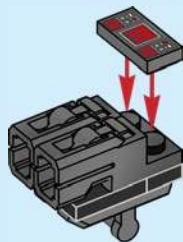

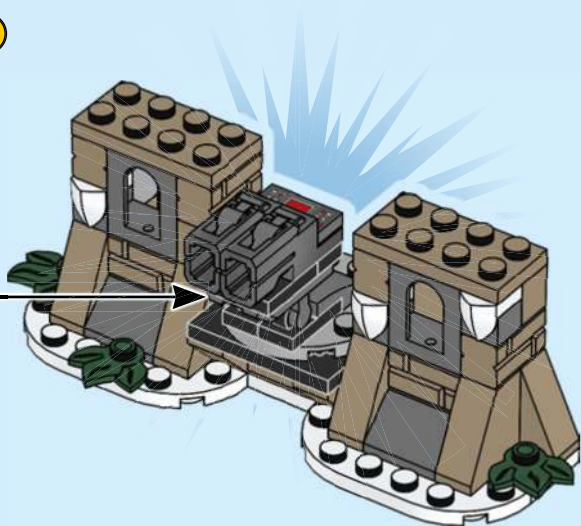



2x

22

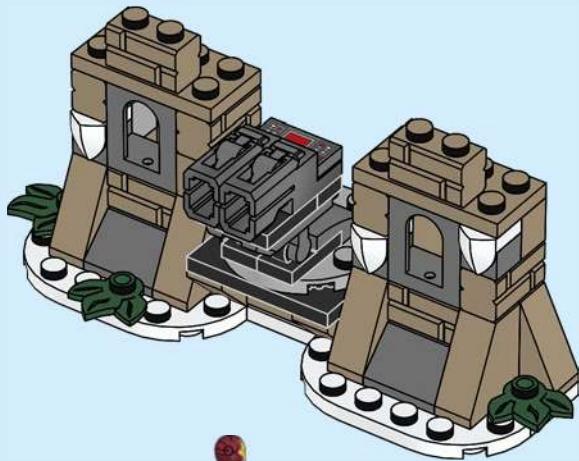



8x

23

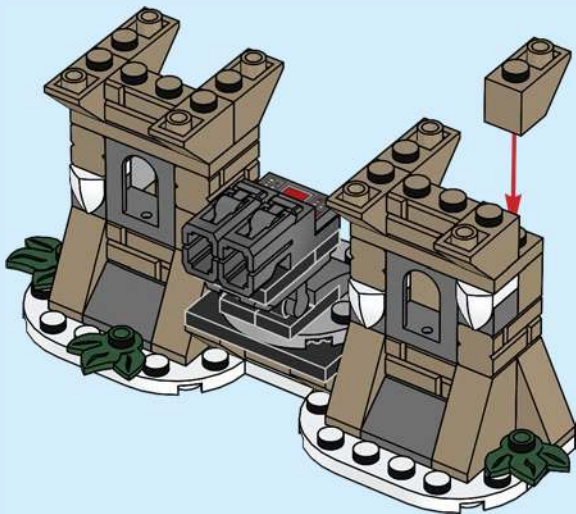

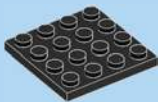

2x

24





2x



2x



2x

# 25

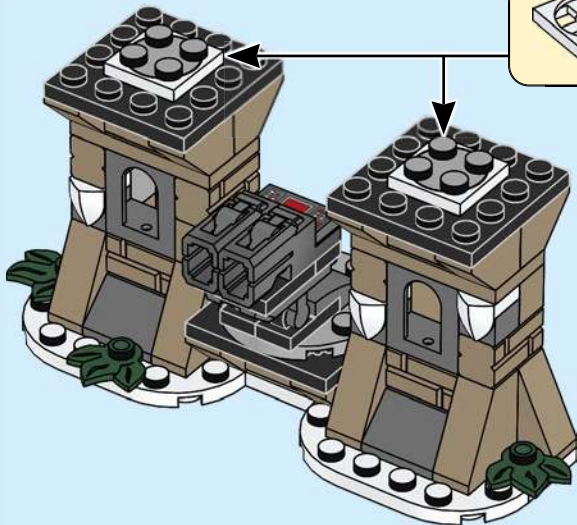

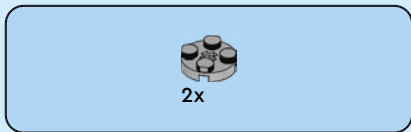

26

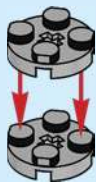



1x



1x

# 27





1x

# 28

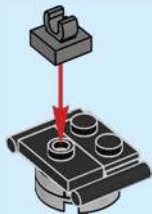



2x

29

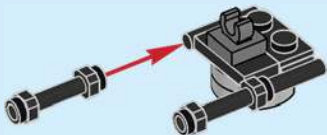



2x

30

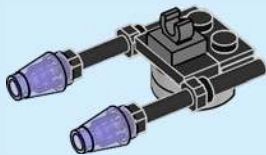

2x



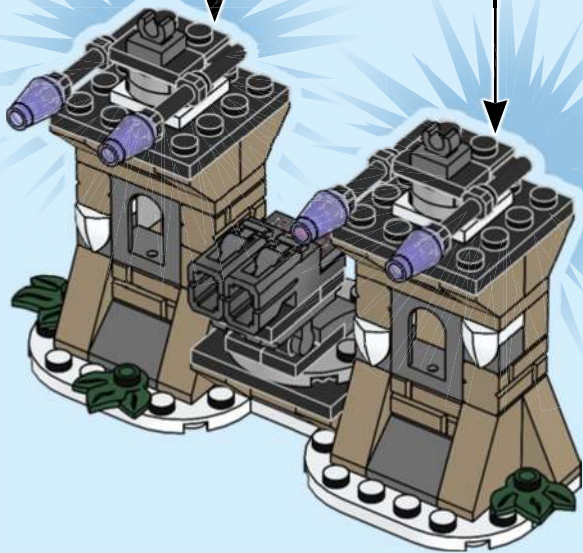



4x



31

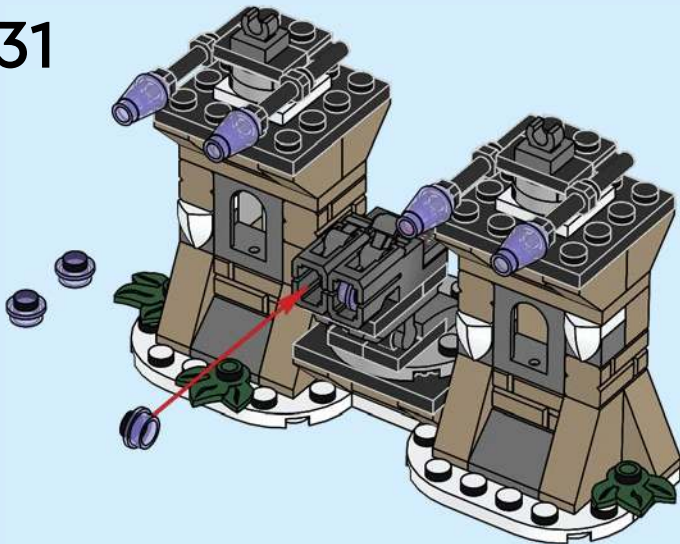

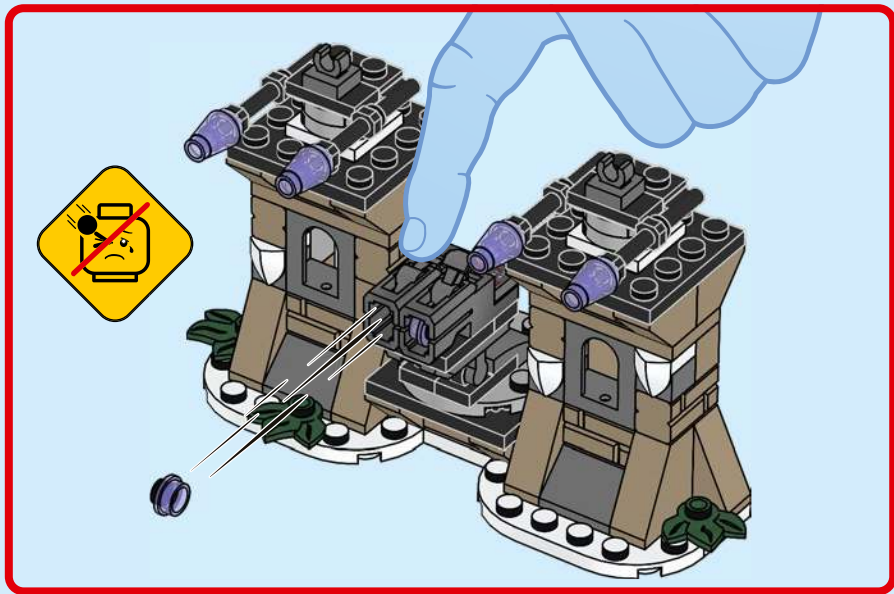





4x  
6331084



2x  
6092585



1x  
302326



2x  
6347310



1x  
6192346



2x  
383926



1x  
4517986

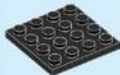

2x  
4243819



9x  
6240225



9x  
6238677



2x  
6353237



6x  
6240210



4x  
6337603



2x  
6001824



9x  
4646577



8x  
6354068



10x  
6121959



2x  
4267874



2x  
6454726



2x  
6488201



3x  
6400754



1x  
6221340



1x  
6488120



1x  
4558953



4x  
4211475



2x  
4540203



1x  
4227657



1x  
4515351



3x  
6388133



2x  
6344022



2x  
6181291



1x  
6291791



2x  
4211054



1x  
6071261



1x  
6258991



1x  
4210875



3x  
6360675



1x  
6345880



2x  
6345952



1x  
6488204



1x  
6398321



1x  
6488206



1x  
6501829



3x  
4619636



2x  
6501916



1x  
6502815



2x  
6488203



2x  
368001



1x  
6252744



3x  
6046905



3x  
6147792

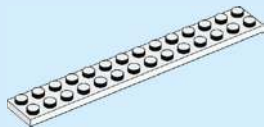

1x  
6359065



[LEGO.com/service](https://www.LEGO.com/service)

YOU COULD  
**WIN**



Scan this QR code or go to  
**LEGO.COM/PRODUCTFEEDBACK** and give us  
your short feedback about this LEGO® set  
for a chance to win a cool LEGO prize.

Terms and Conditions apply\*

**EN: YOU COULD WIN.** Terms and Conditions apply\* **DE: Du könntest GEWINNEN.** Es gelten die Teilnahmebedingungen\* **FR: Tu pourrais GAGNER.** Des conditions s'appliquent\* **IT: Potresti VINCERE tu.** Termini e condizioni sono applicabili\* **ES: Puedes GANAR.** Aplican términos y condiciones\* **PT: Poderá GANHAR.** Aplicam-se termos e condições\* **ZH: 轻松获奖.** 条款和条件适用\* **PL: Szansa na WYGRANĄ.** Obowiązują warunki korzystania\* **CS: Máte šanci VYHRÁT.** Platí všeobecné smluvní podmínky\* **SK: Máte šancu VYHRÁT.** Platia všeobecné zmluvné podmienky\* **HU: TE IS NYERHETSZ.** Felhasználási feltételek érvényesek\* **RO: Ai putea CÂȘTIGA.** Se aplică termenii și condiții\* **BG: Можете да СПЕЧЕЛИТЕ.** Има определени правила и условия\* **LV: Tu vari LAIMĒT.** Ir spēkā noteikumi un nosacījumi.\* **ET: Sul on võimalus VÕITA.** Kehtivad tingimused\* **LT: Jūs galite LAIMĖTI.** Taikomos sąlygos\*

\*[LEGO.com/productfeedback-terms](https://www.lego.com/productfeedback-terms)

LEGO and the LEGO logo are trademarks of the LEGO Group. ©2024 The LEGO Group.

© 2024 MARVEL

6534161