



SONIC™

THE HEDGEHOG

76998



LEGO® Builder



LEGO.com/sustainable-packaging



FR
DONNEZ
OU
RECYCLEZ



ASSOCIATION

OU



MAGASIN

OU



DÉCHÈTERIE

Adresses sur quefairedemesdechets.fr

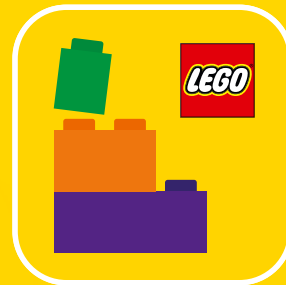

LEGO® Builder

BUILDER

Download on the
App Store

GET IT ON
Google Play

腾讯应用宝
安卓应用商店

Apple and the Apple logo are trademarks of Apple Inc., registered in the U.S. and other countries and regions. App Store is a service mark of Apple Inc. Google Play and the Google Play logo are trademarks of Google LLC. Tencent and the Tencent logo are trademarks of Tencent Inc.

LEGO.com/devicecheck

EN Ask parents' permission before going online | DE Eltern um Erlaubnis bitten, bevor du online gehst | FR Demande l'autorisation d'un parent avant d'aller en ligne | IT Chiedi il permesso ai tuoi genitori prima di andare online | ES Pídeles permiso a tus papás antes de conectarte a Internet | PT Pede autorização aos pais antes de acederes online | ZH 上网前应先征得父母的同意 | PL Poproś rodziców o zgodę, zanim wejdiesz do Internetu | CS Než půjdeš na internet, požádej rodiče o svolení | SK Skôr než pôjdeš na internet, vypýtaj si povolenie od rodičov | HU Kérj szülői engedélyt, mielőtt online csatlakoznál! | RO Cere permisiunea părinților înainte de a te conecta online | BG Поискайте разрешение от родител, преди да влезете онлайн | LV Pirms došanās tiešsaistē palūdz atļauju vecākiem | ET Enne Interneti kasutamist küsi vanematelt luba | LT Prieš prisijungdami prie interneto, atsklauskite tėvų



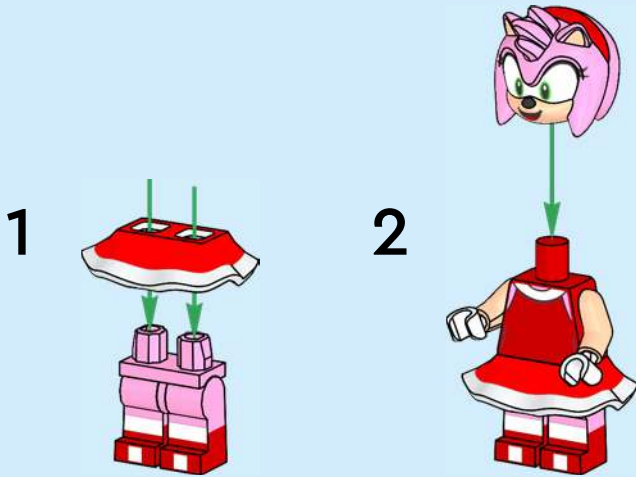
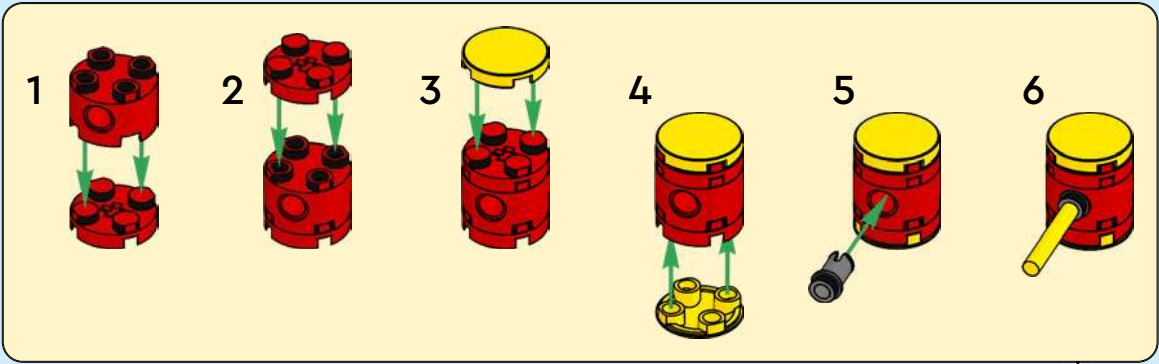

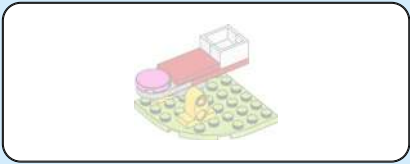

1

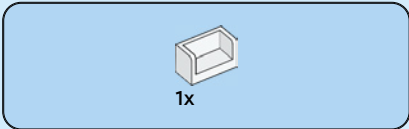
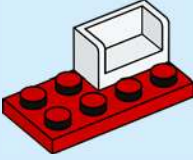

2

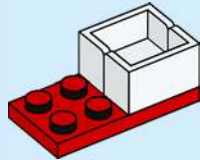

3

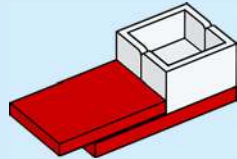



4

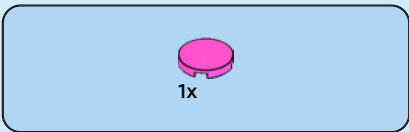
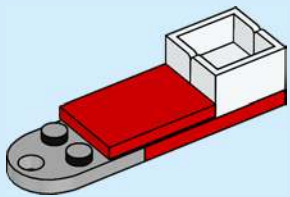

5

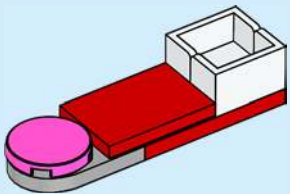

6

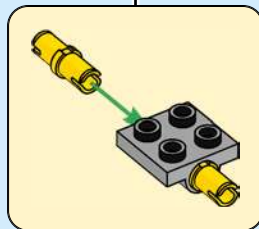
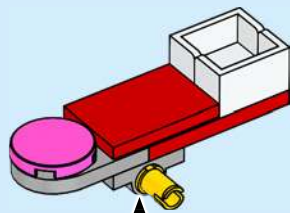



2x

7

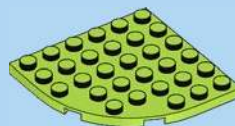
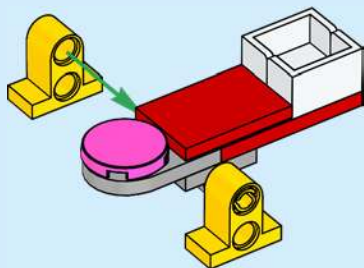

1x

8





9

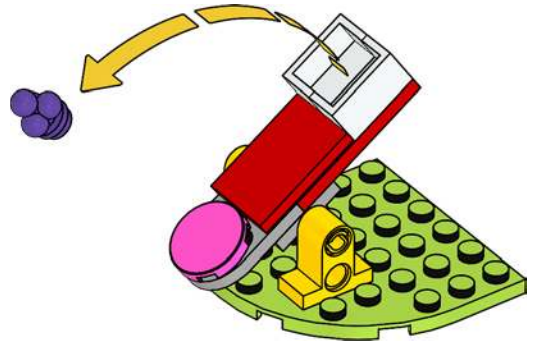
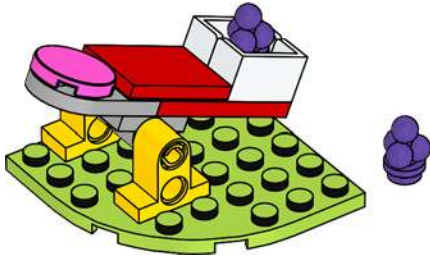



1

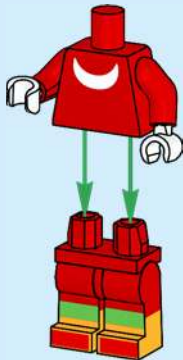

2

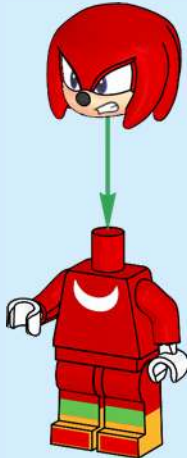

3



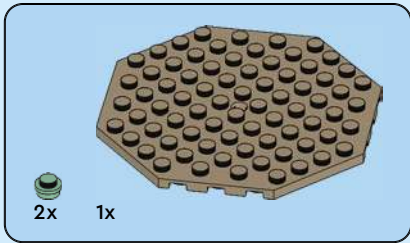
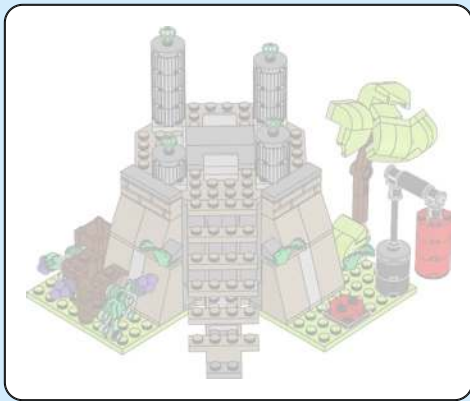

1

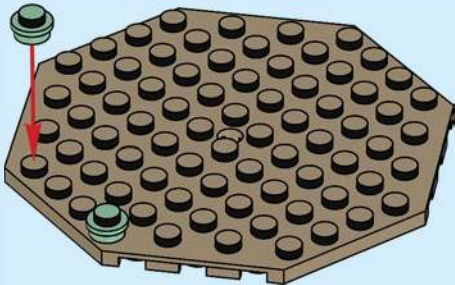

2

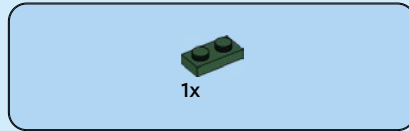
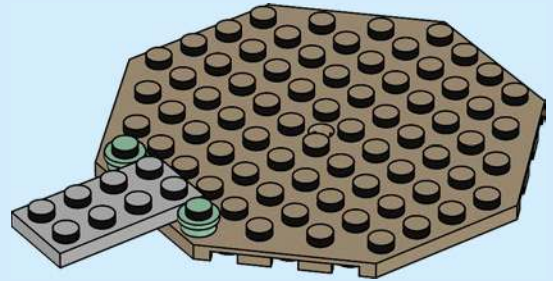

3

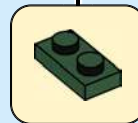
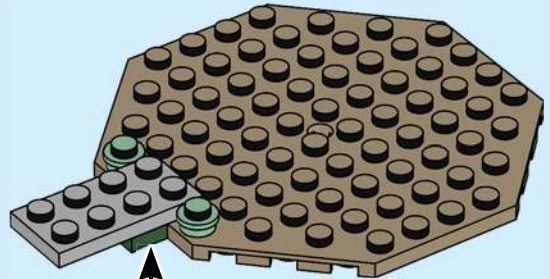

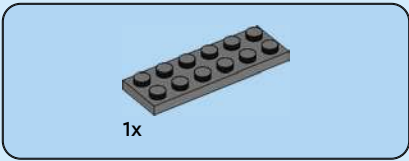

4

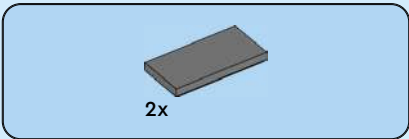
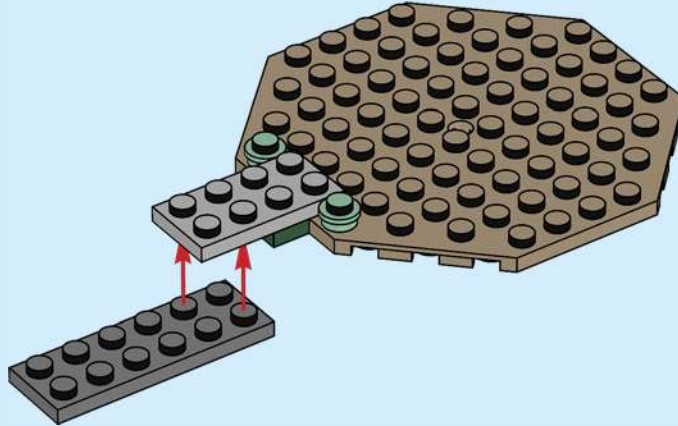

5

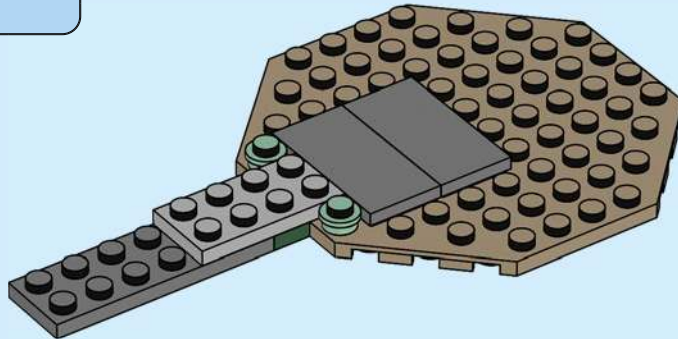

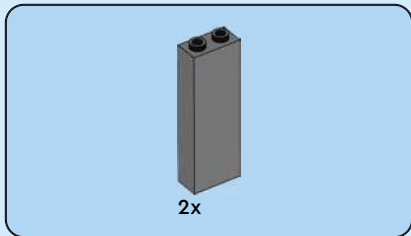

6

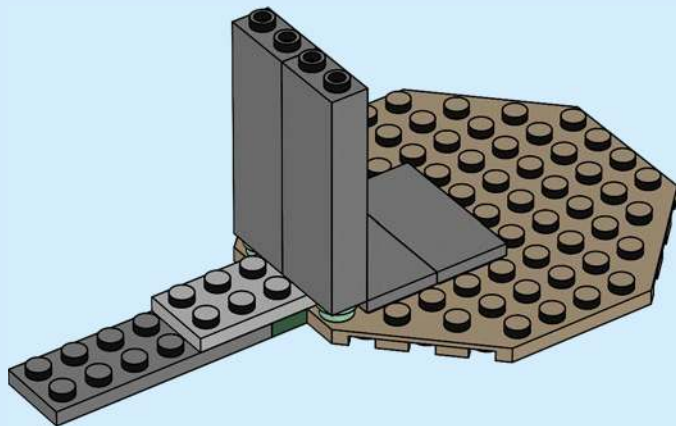

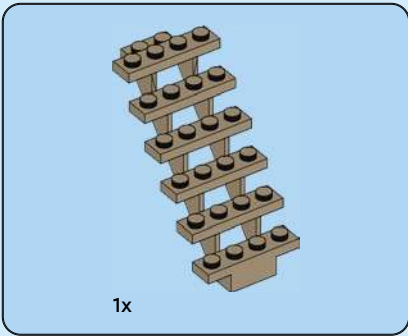

7

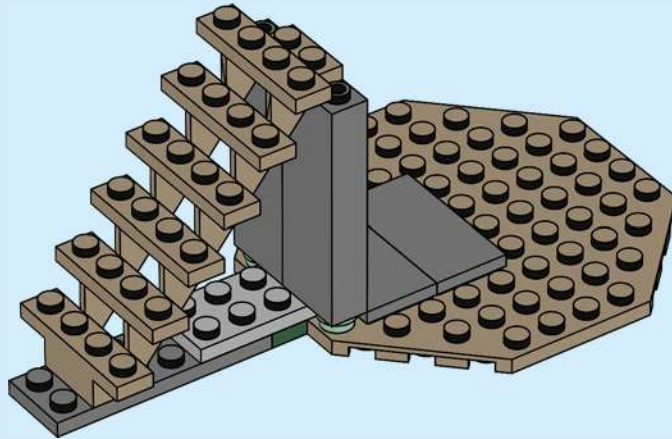



2x

8

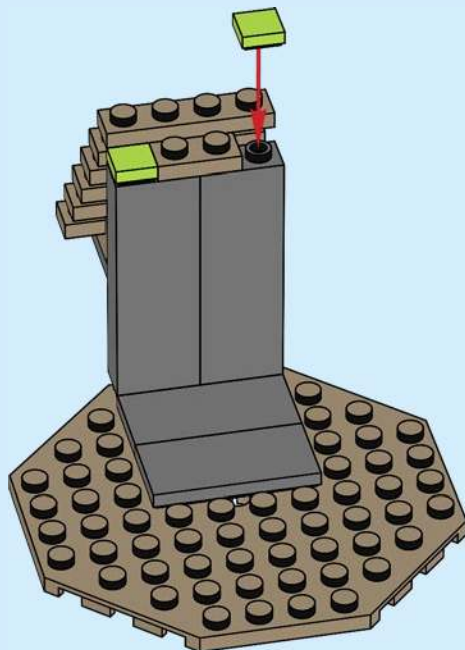
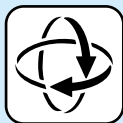

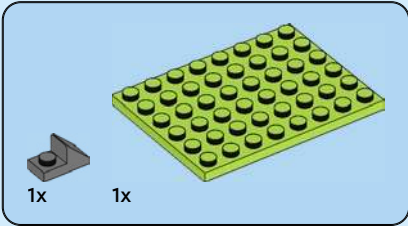
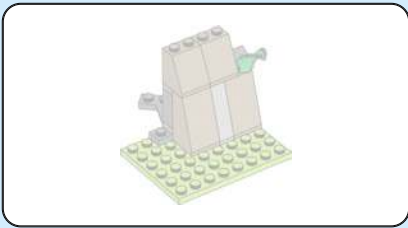

9

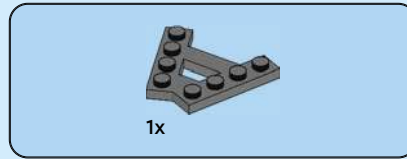
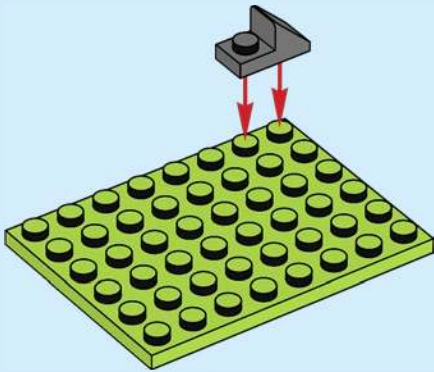

10

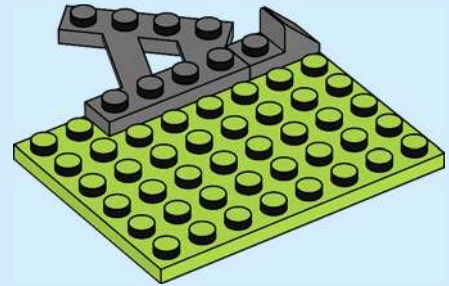

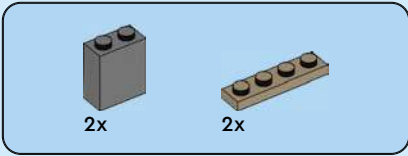

11

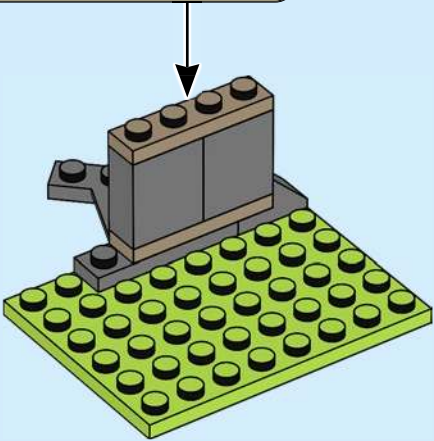
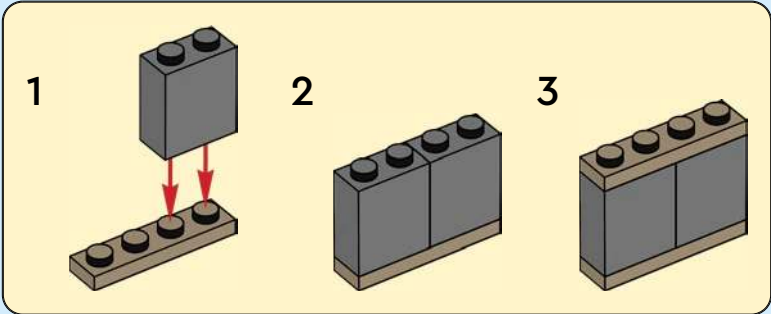

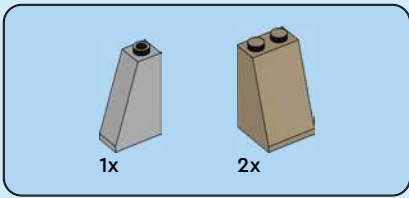

12

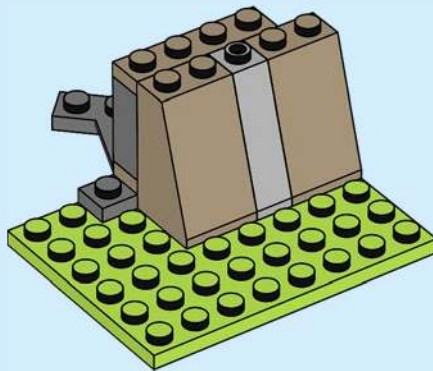



13

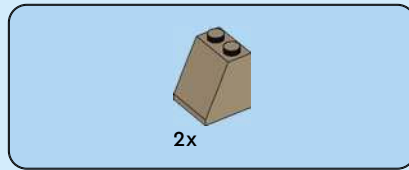
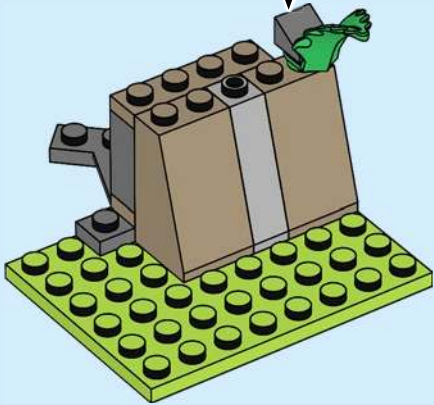
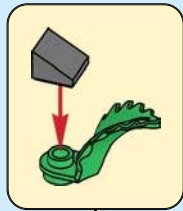

14

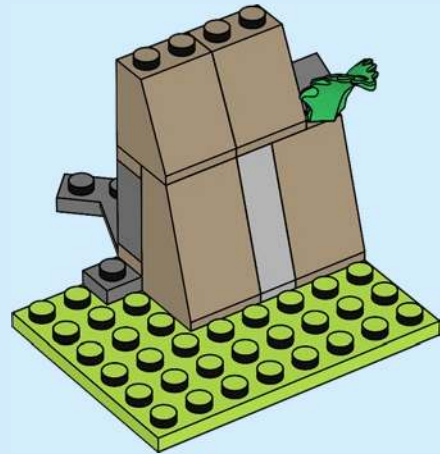

15

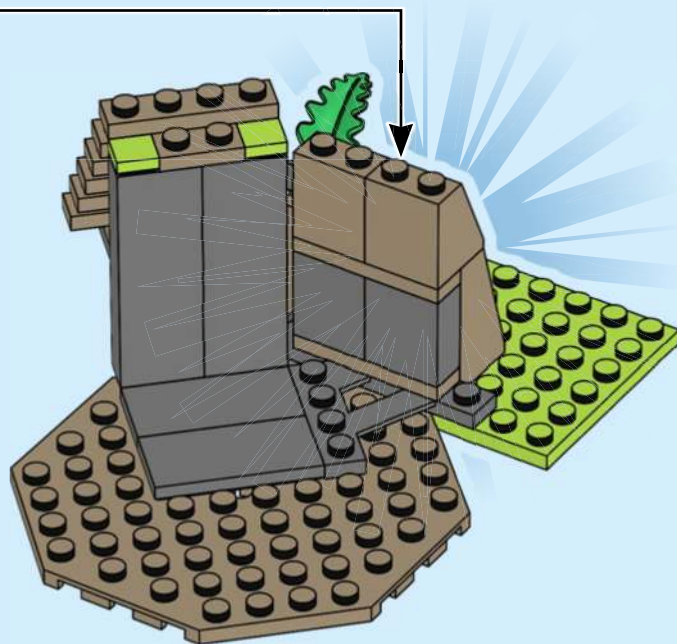

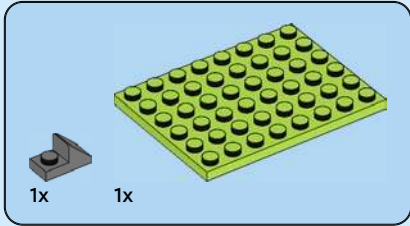
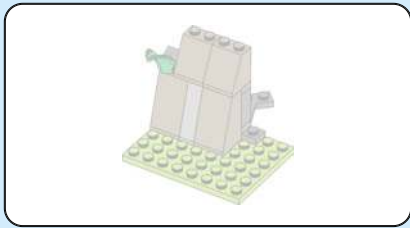

16

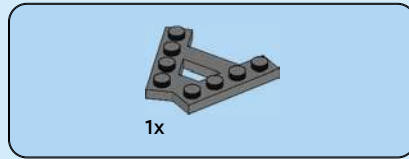
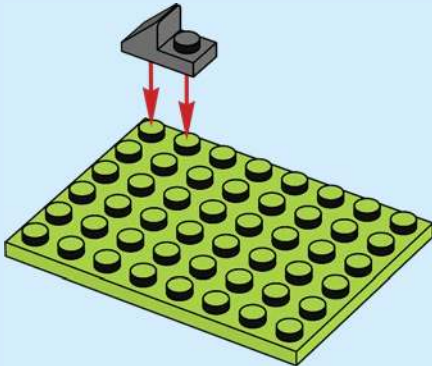

17

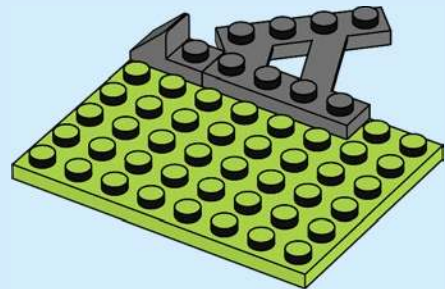

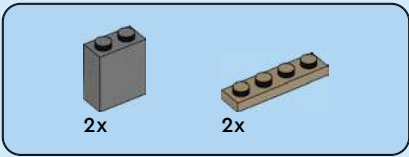

18

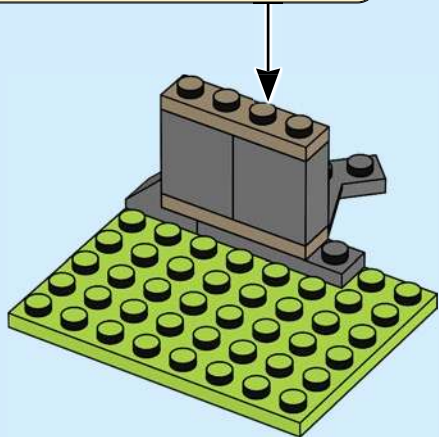
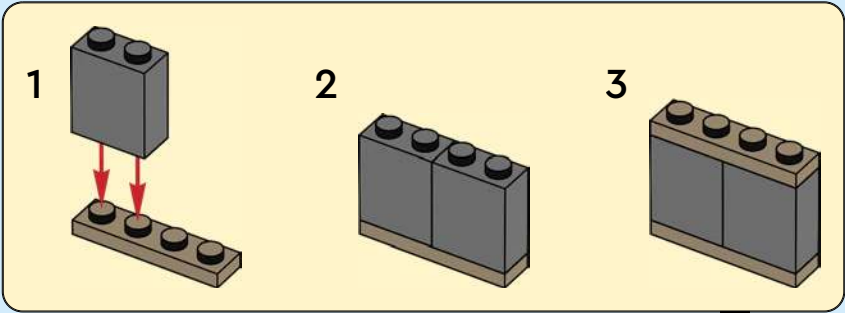

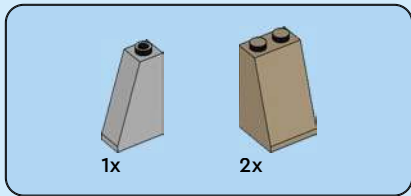

19

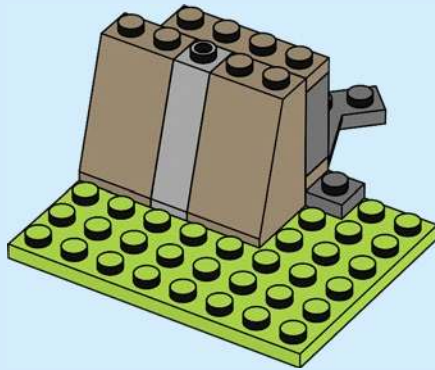

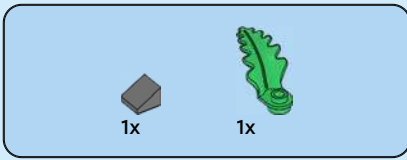

20

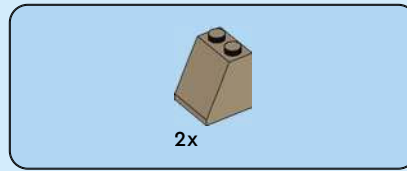
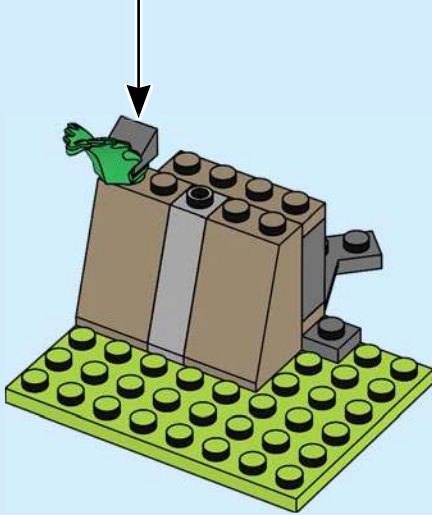
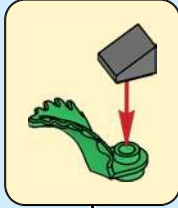

21

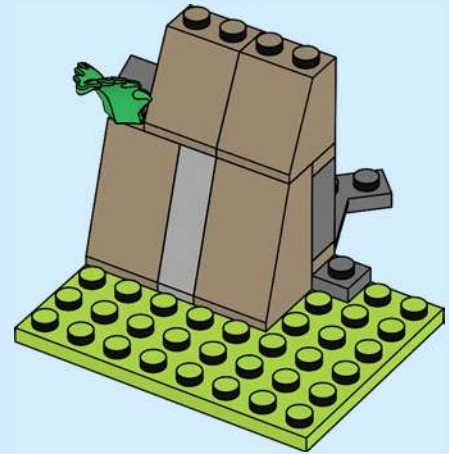

22

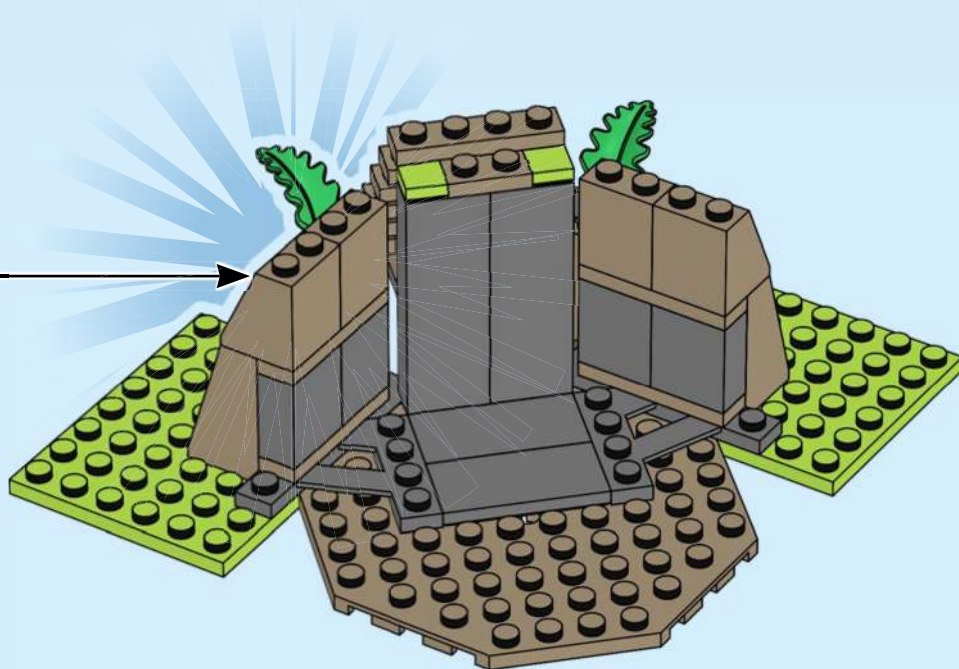

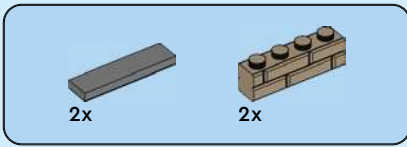

23

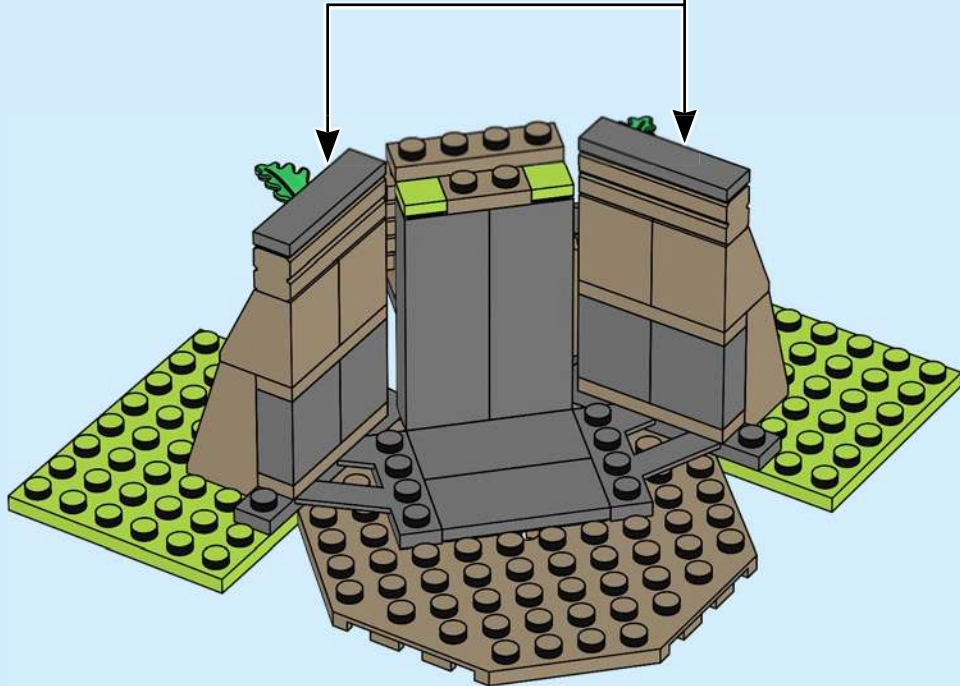
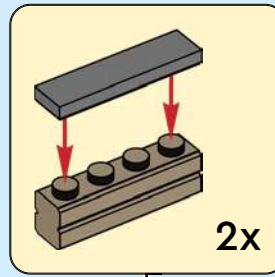

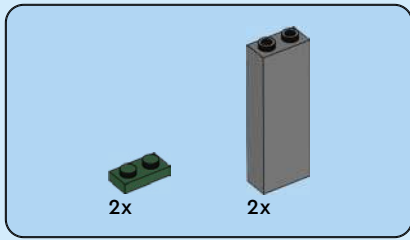

24

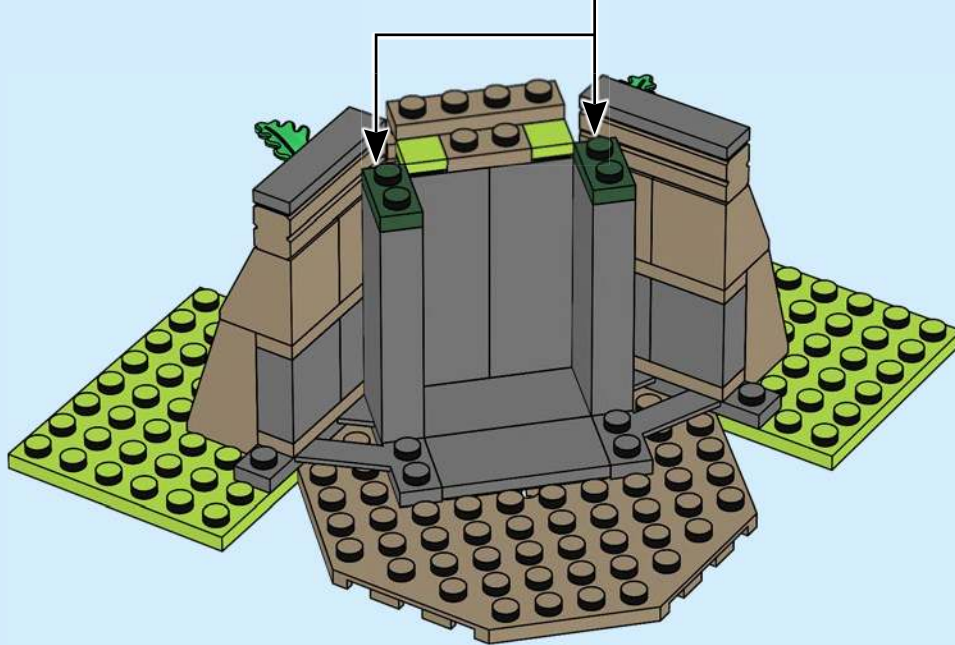
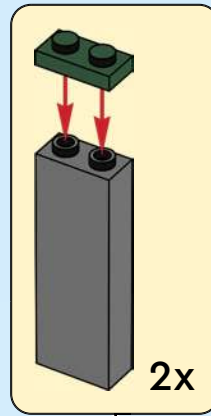



2x



2x

25





2x

26

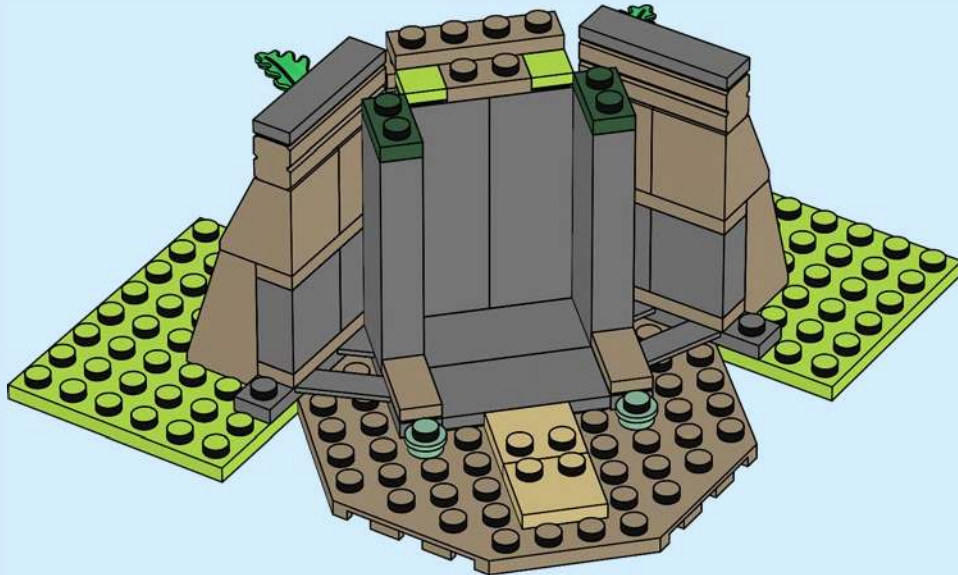

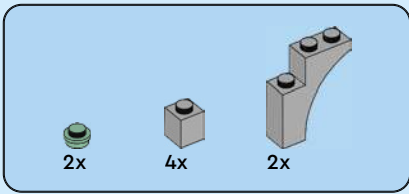

27

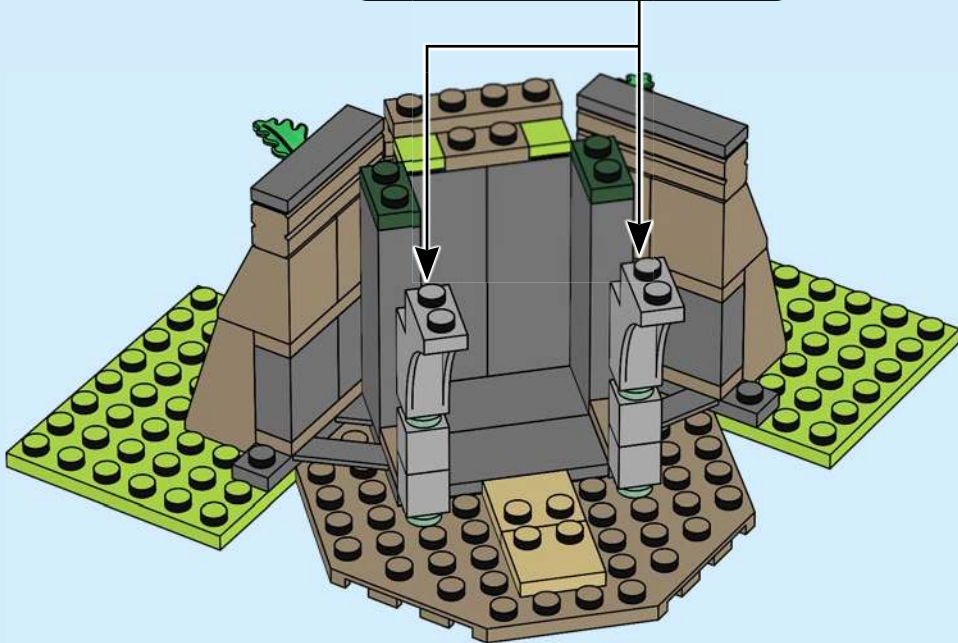
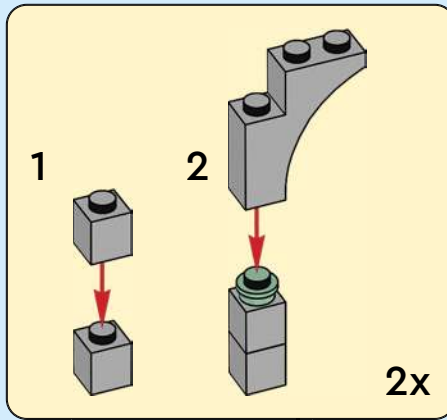



1x

28

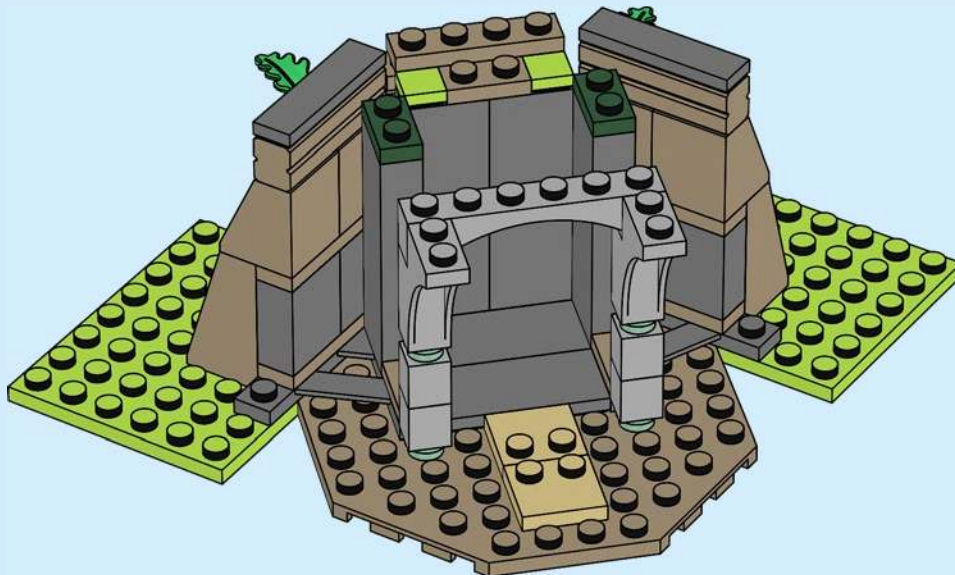

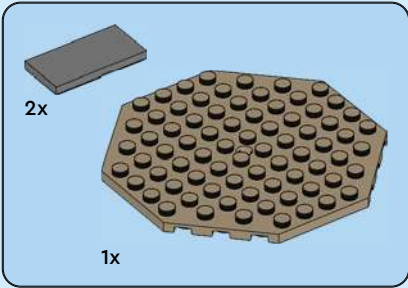
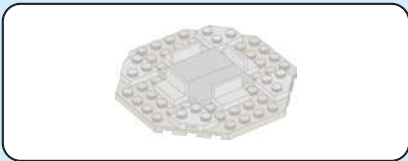

29

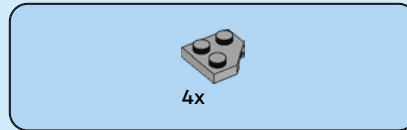
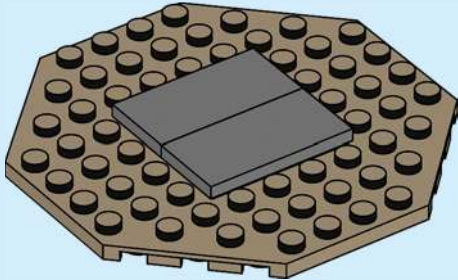

30

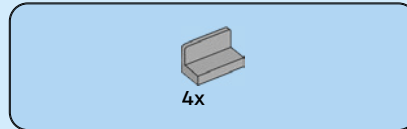
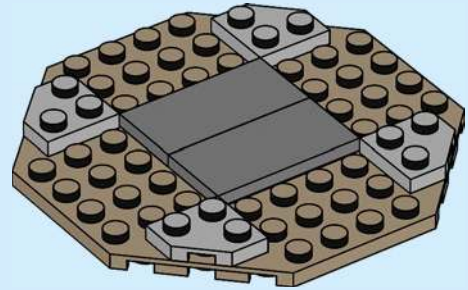

31

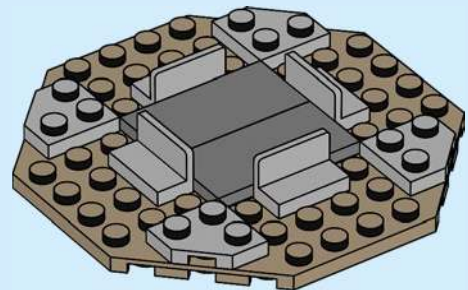

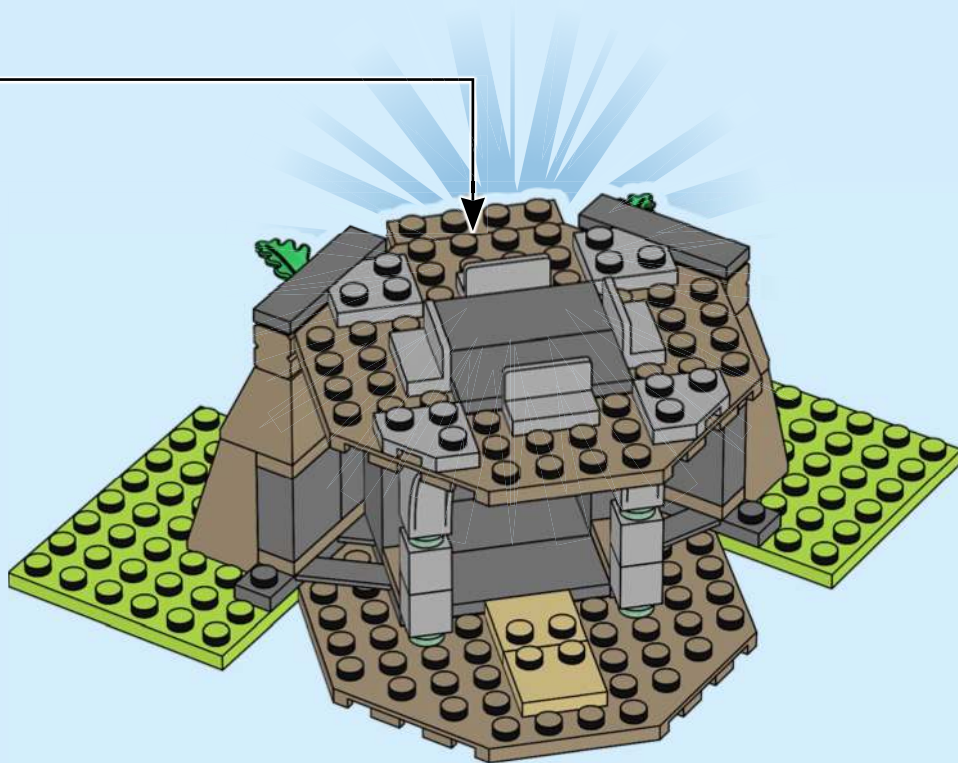

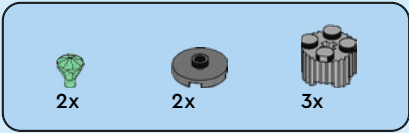

33

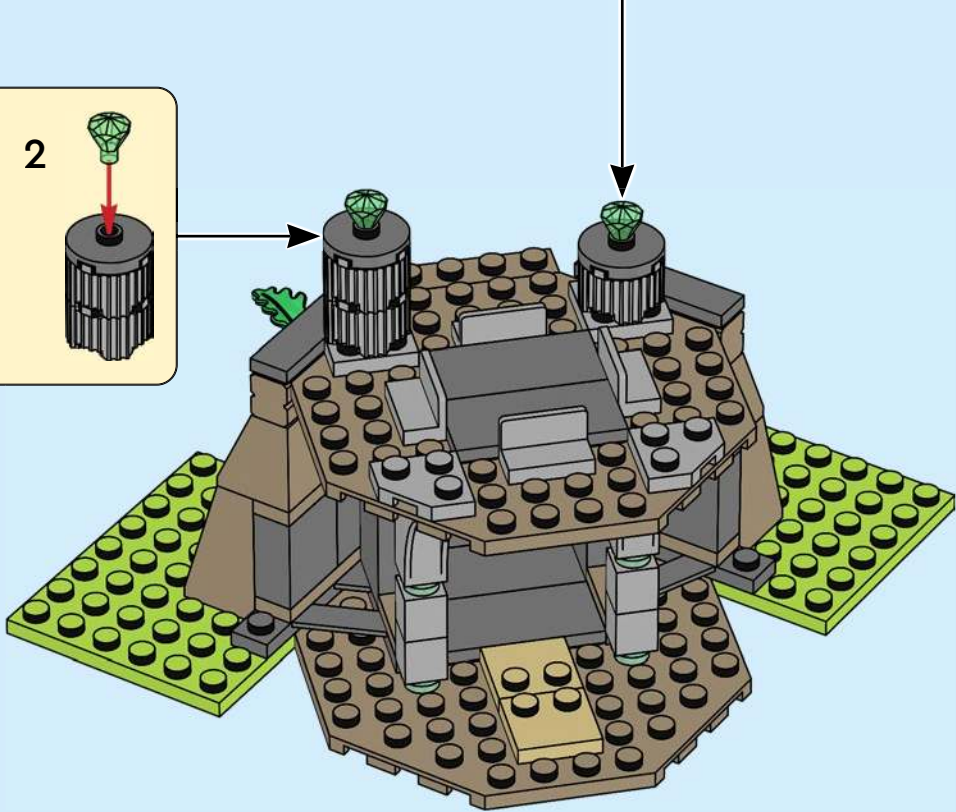
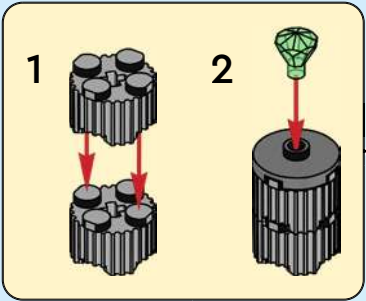
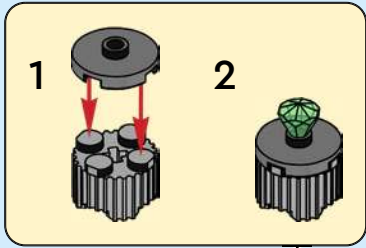

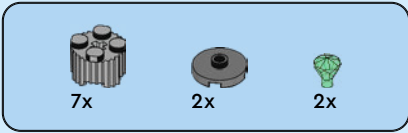

34

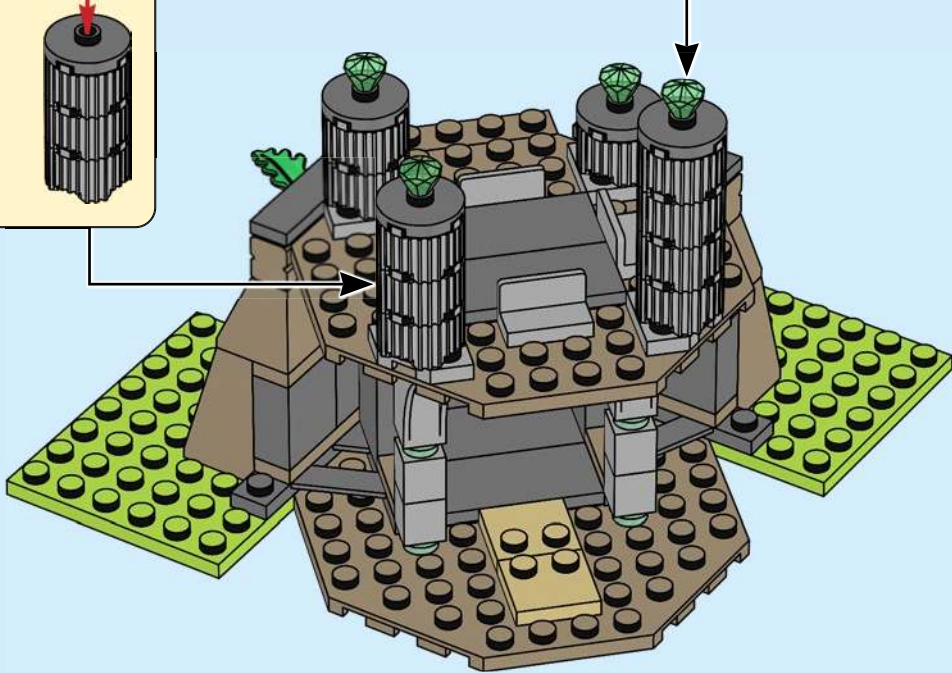
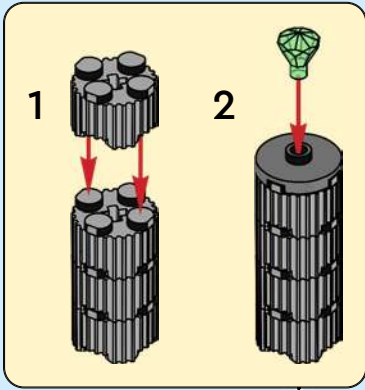
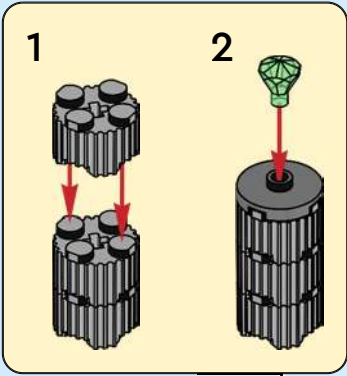

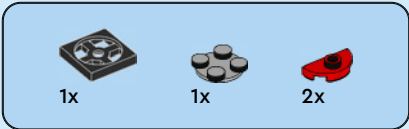

35

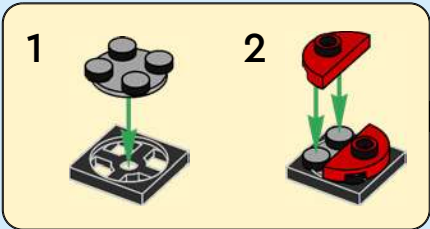
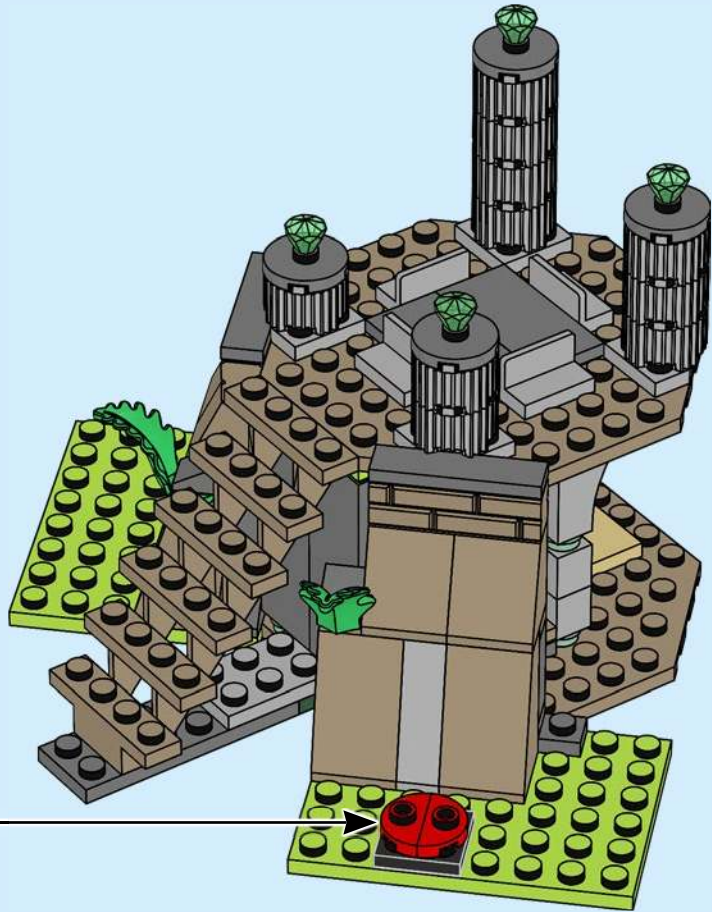



36

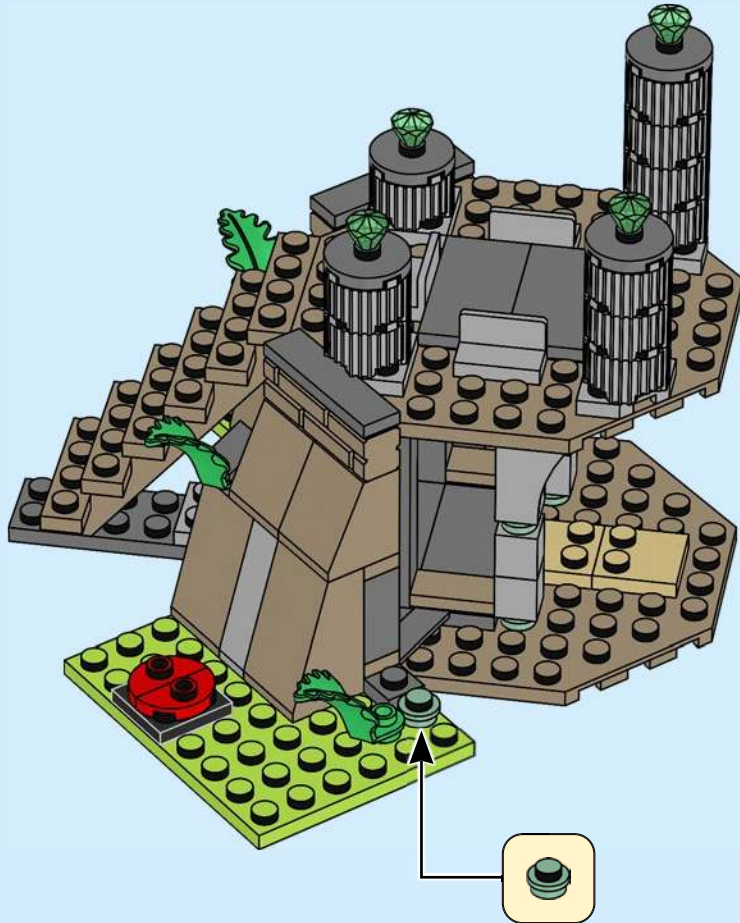



1x

37

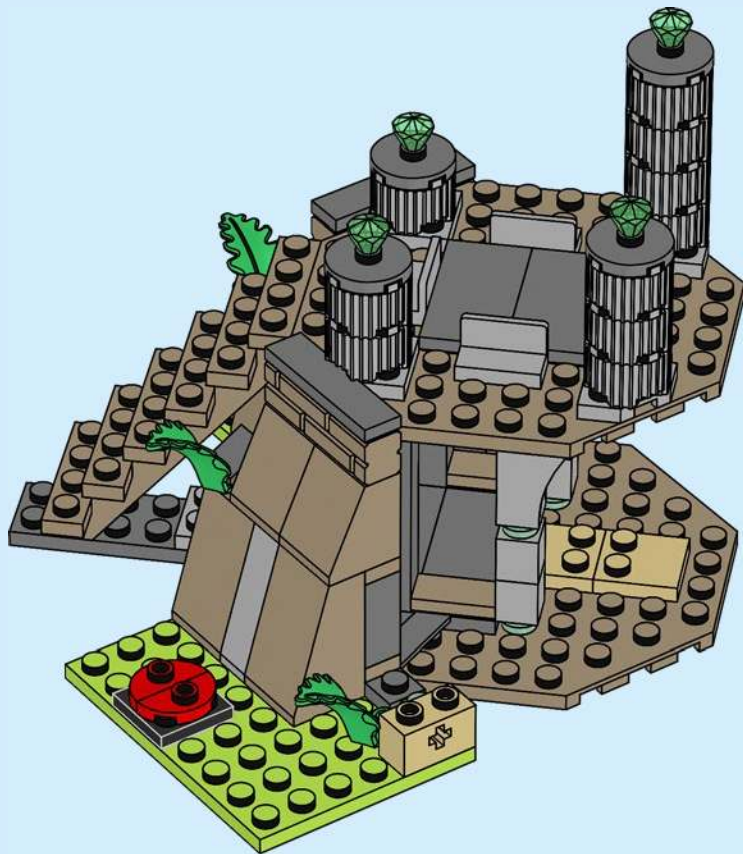



2x

38

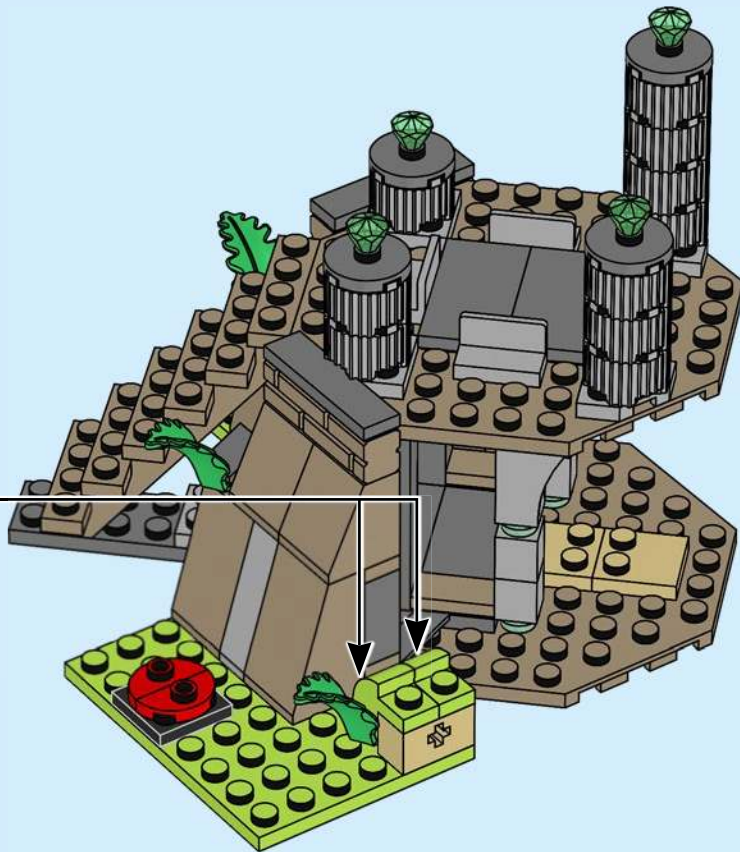

2x





1x

39

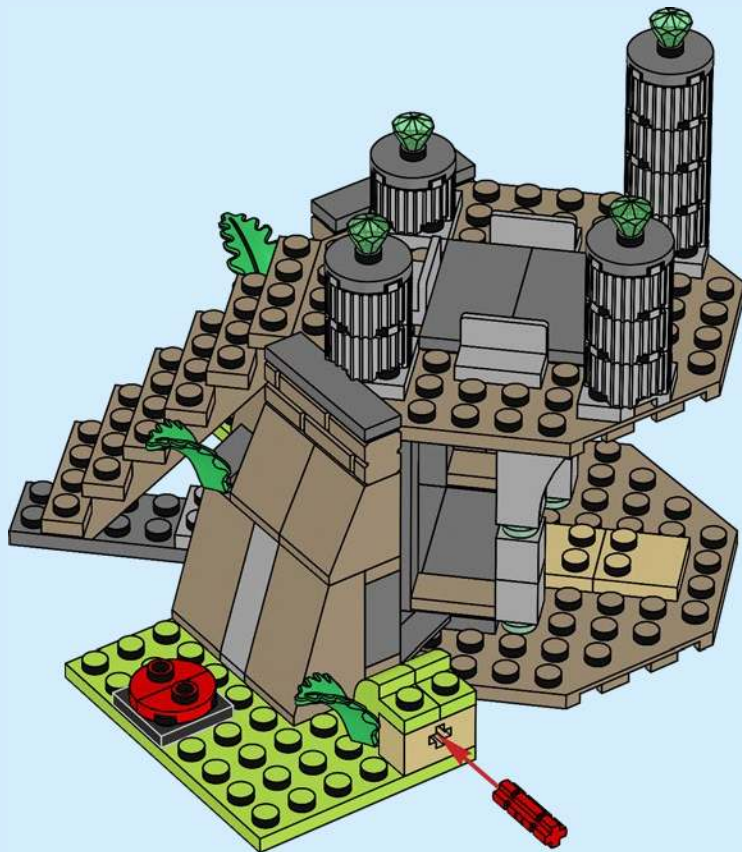



1x



1x

40

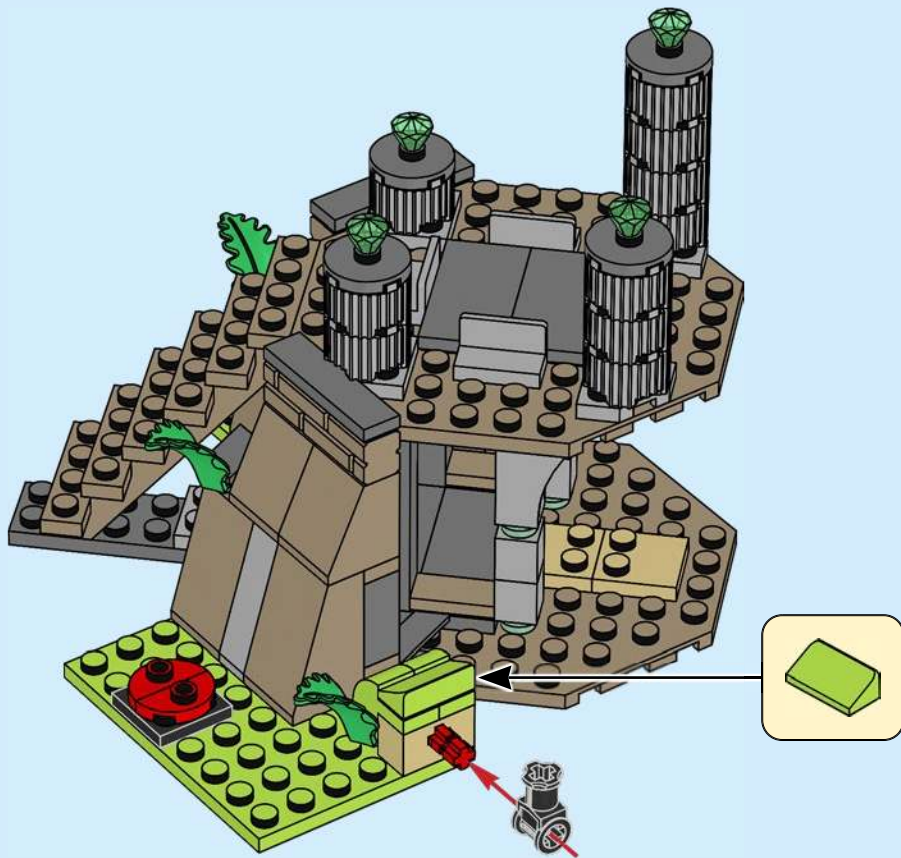

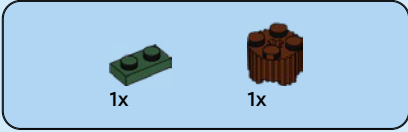

41



42

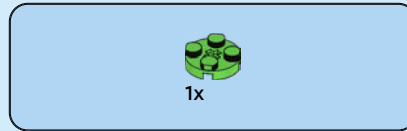

43

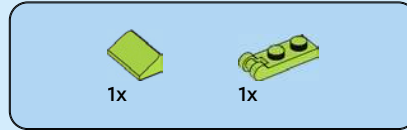
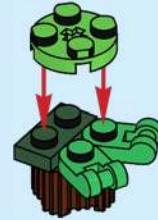

44

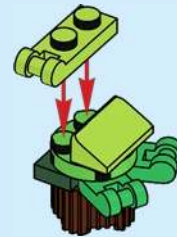



2x

45

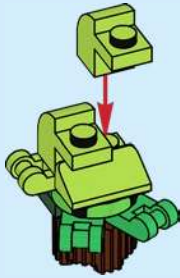

1x

46



2x



4x



2x

47

1



2

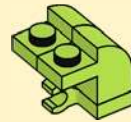

3



2x

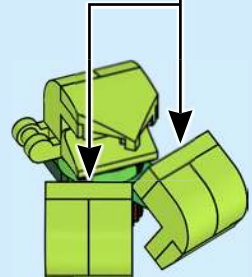



48

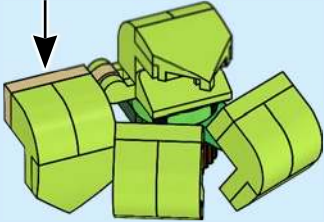
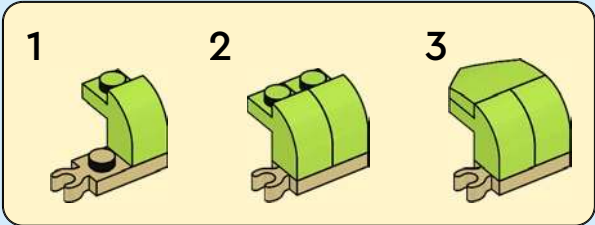



49

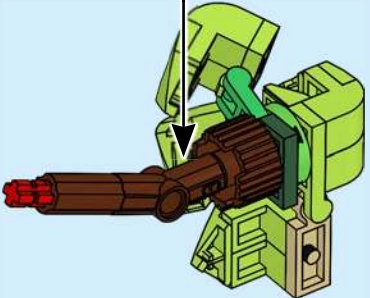
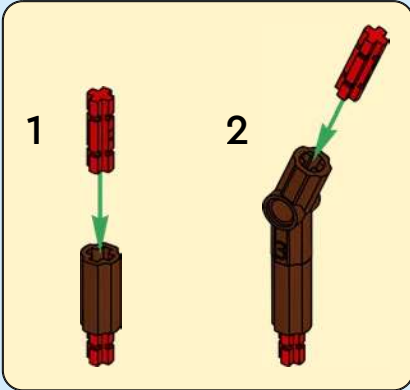

50

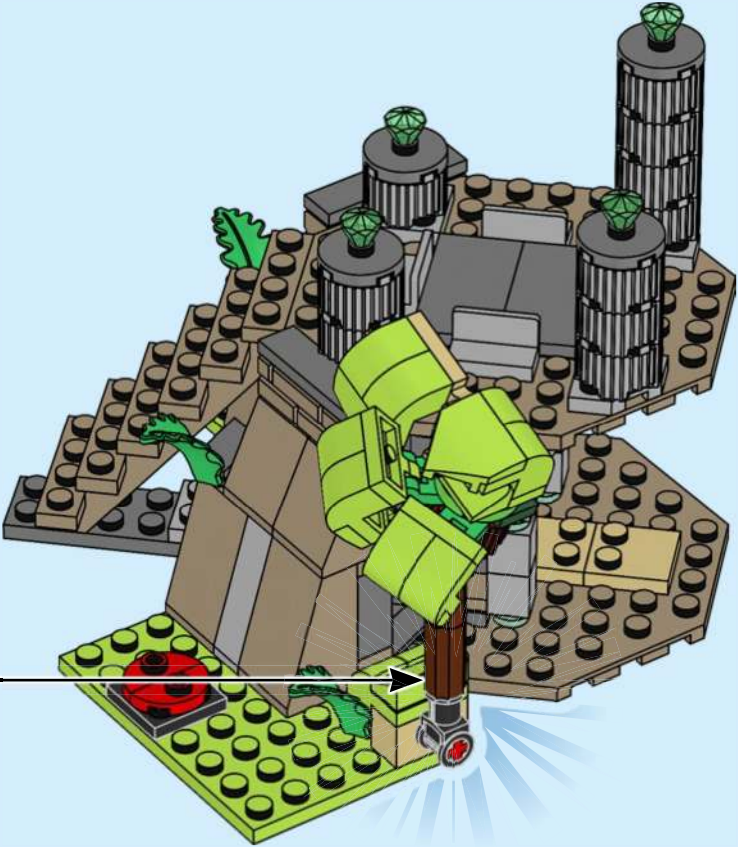



1x



2x

51

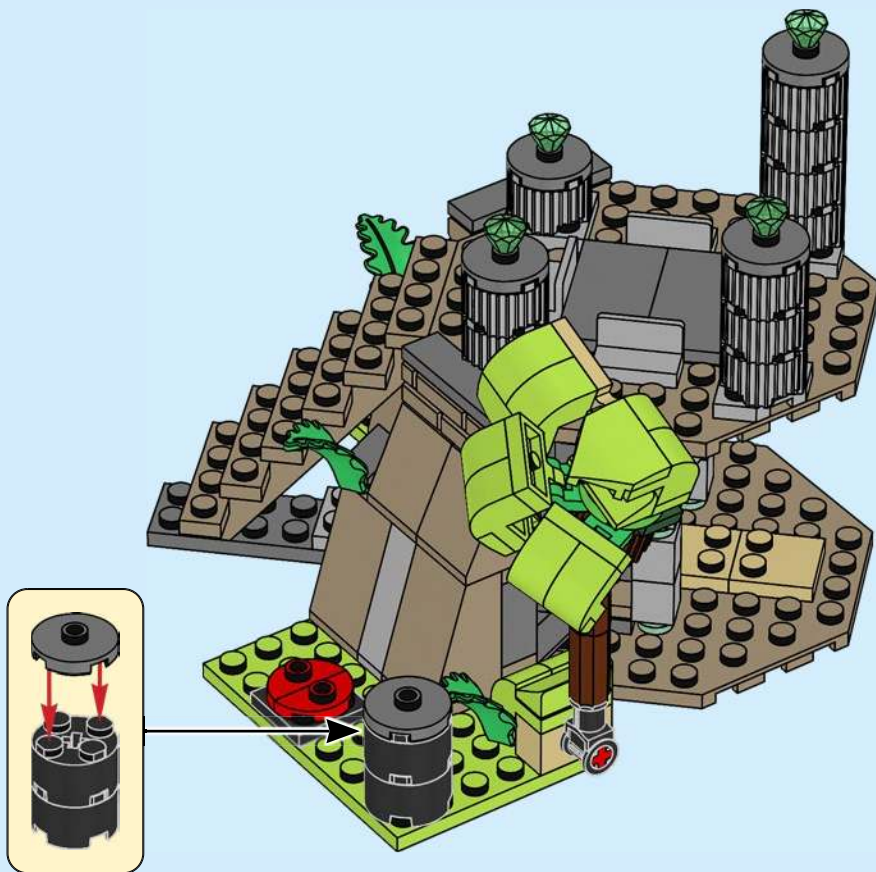

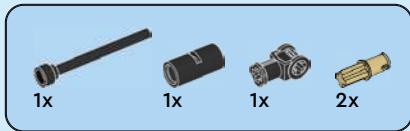

52

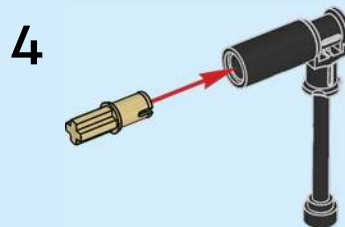
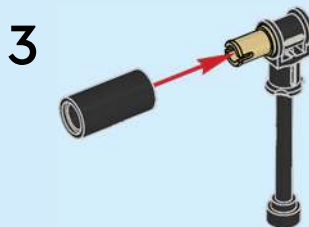
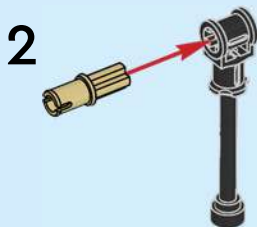

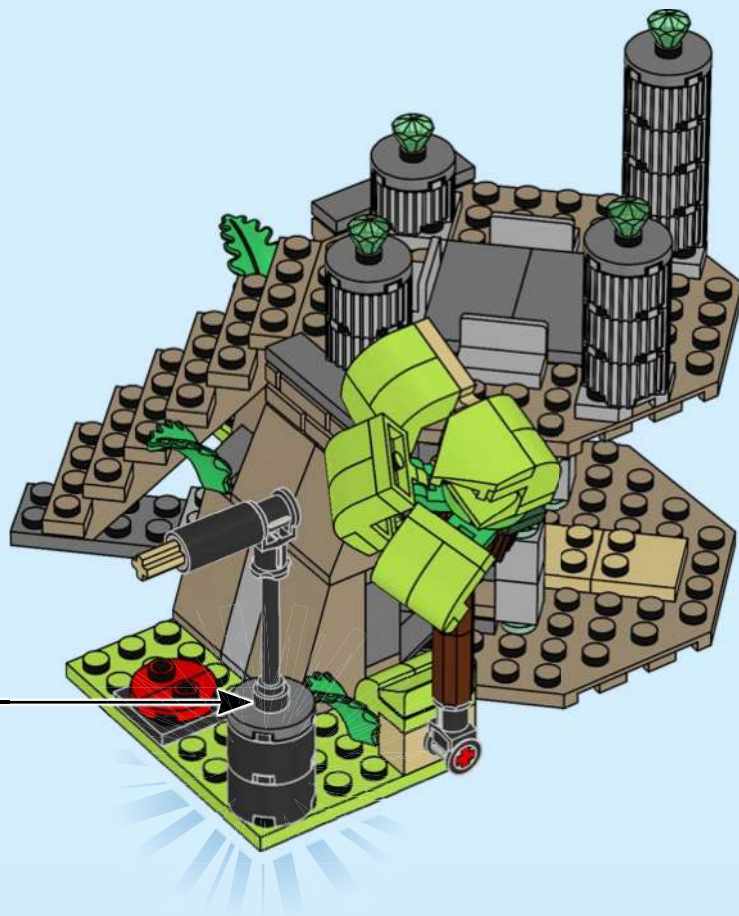

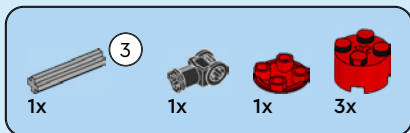

53

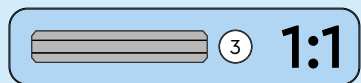
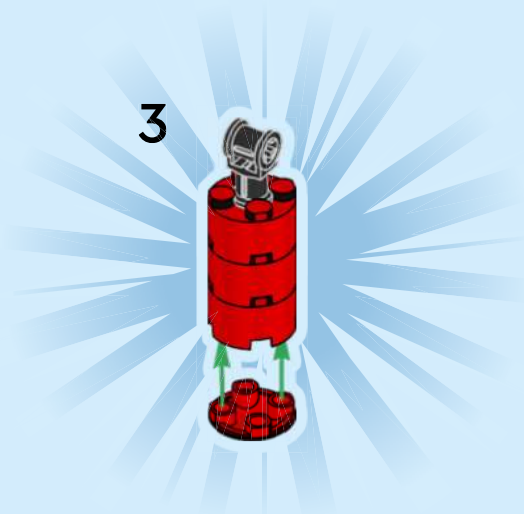
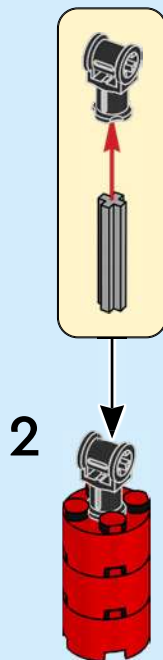
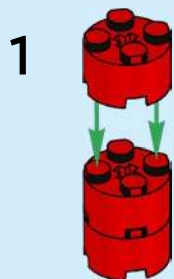

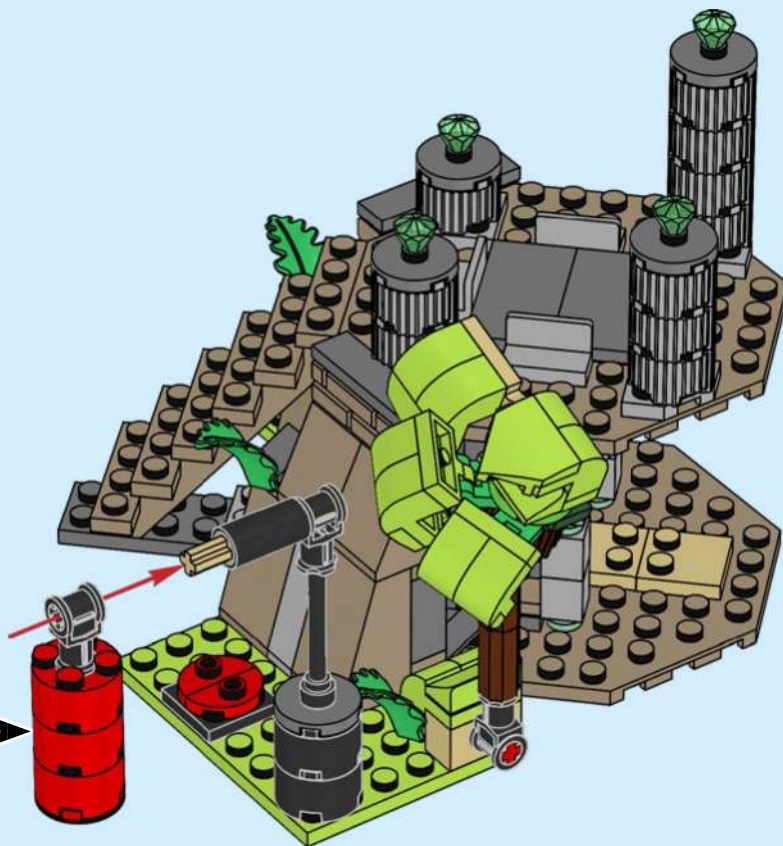





1x

54

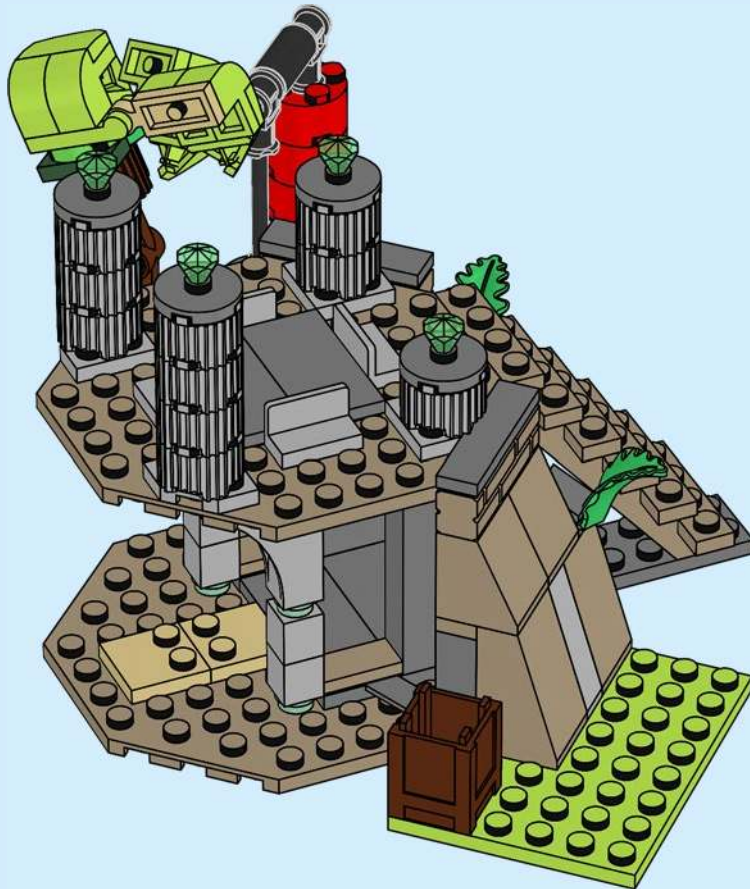



55



56



57

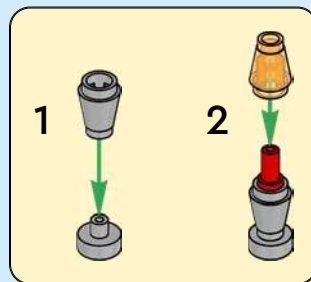

58

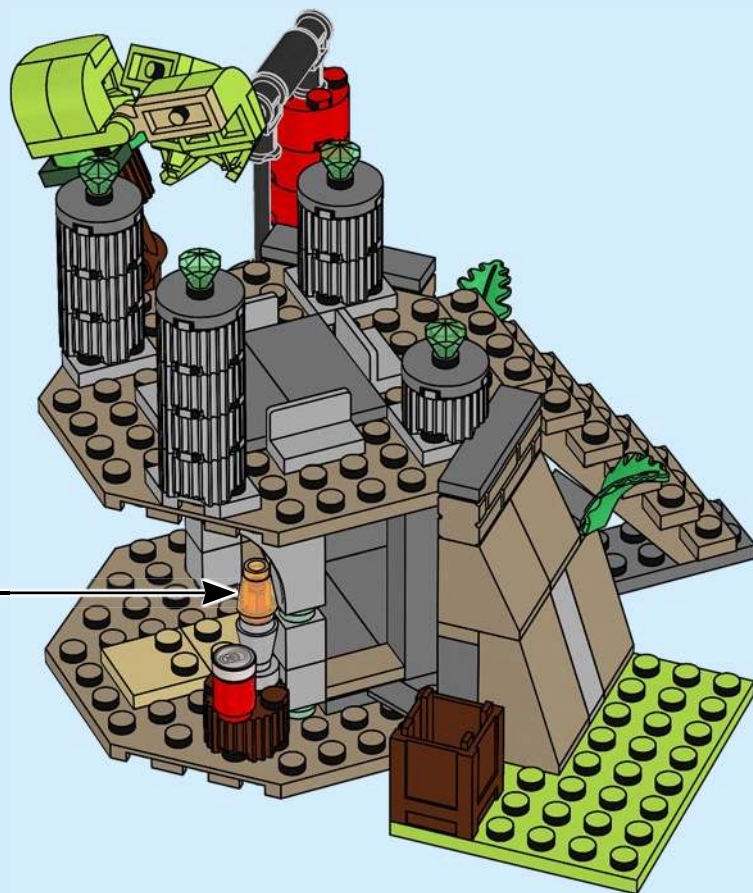



59

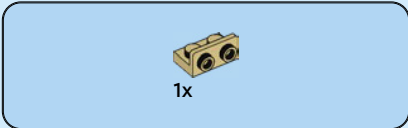

60

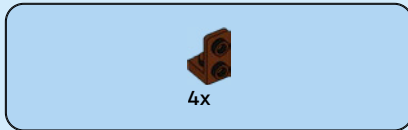

61

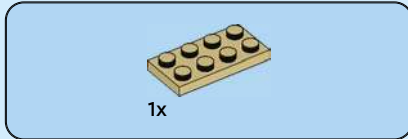
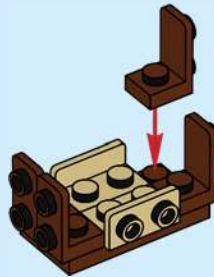

62



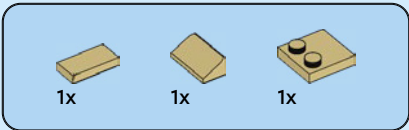

63

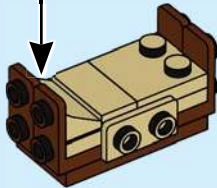
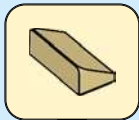

64

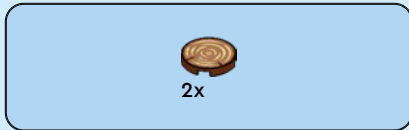
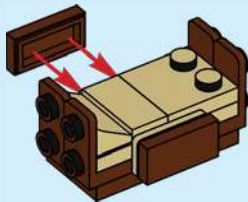

65

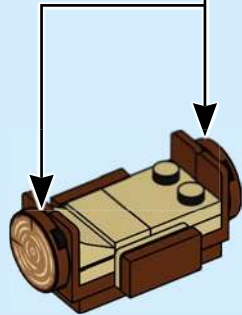

66

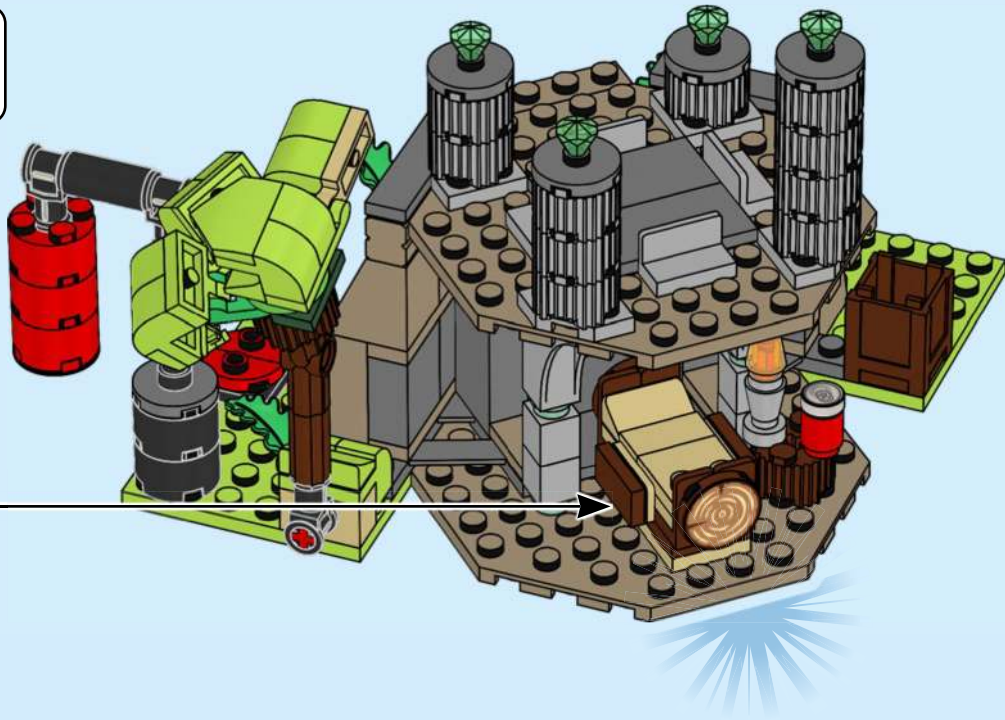



67



68

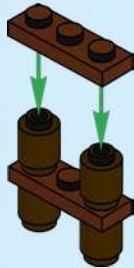

69

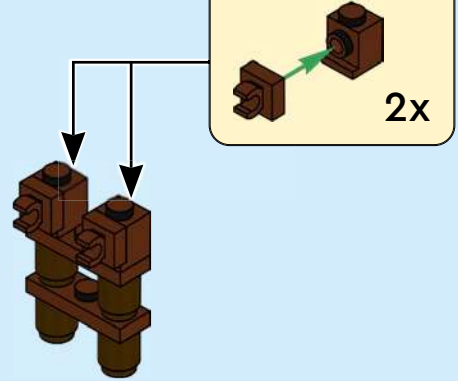

70

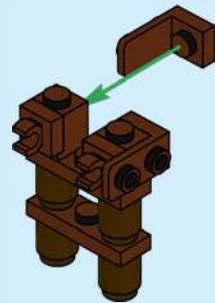

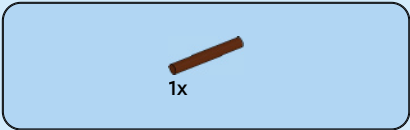

71



72

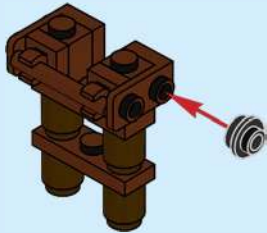

73

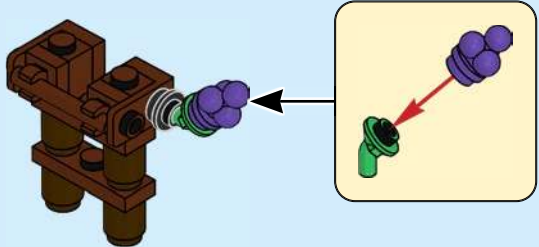



74

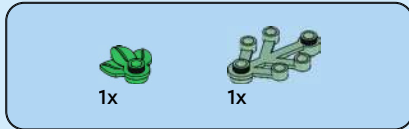
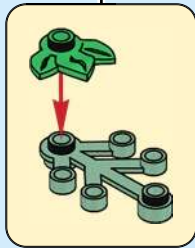

75

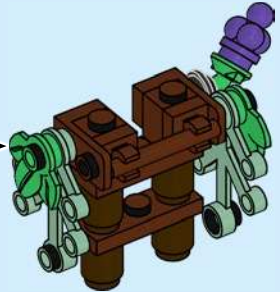
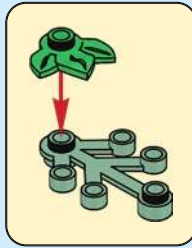
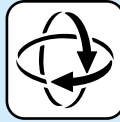

76

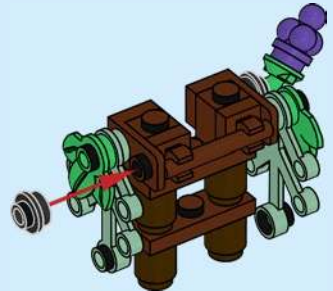



1x



1x

77

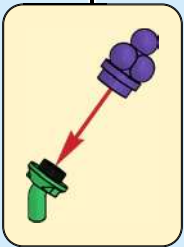
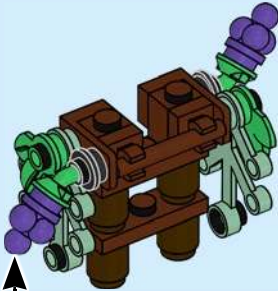

1x



1x

78

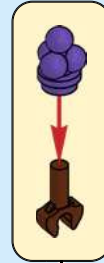
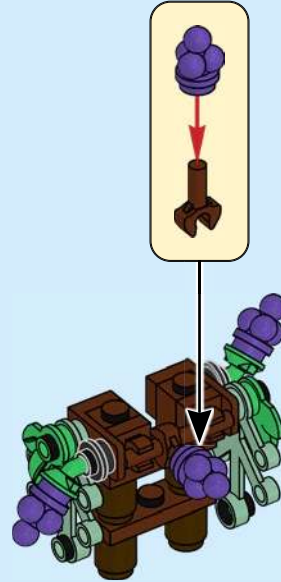

79

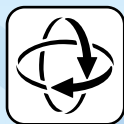

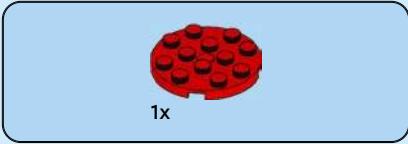
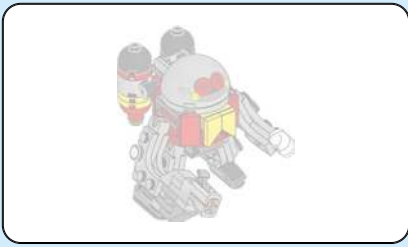

1



2

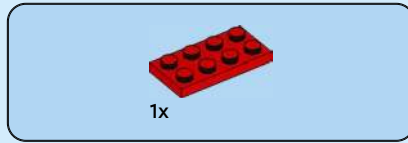

3

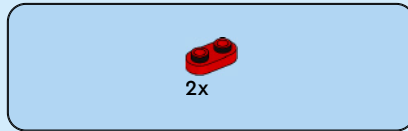

4

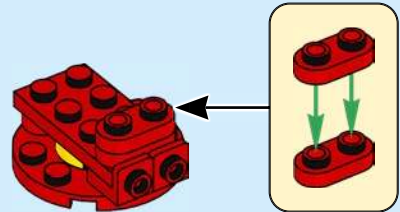



1x

5



1x



2x

6

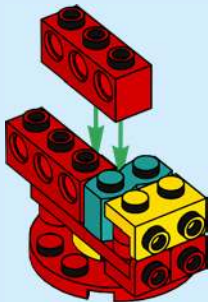

1x



1x

7





2x



4x



4x



4x



2x

8

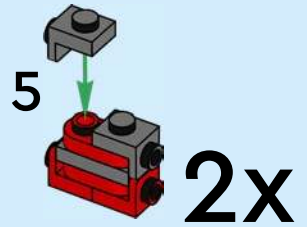
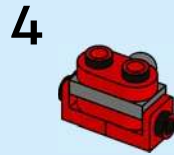
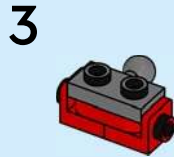
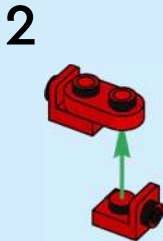
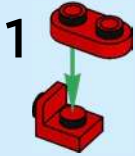

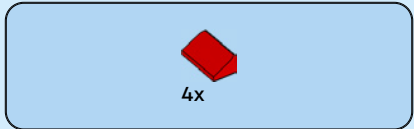

9

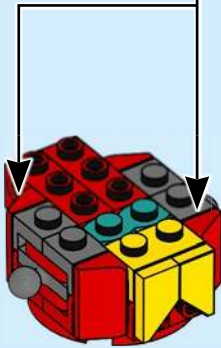
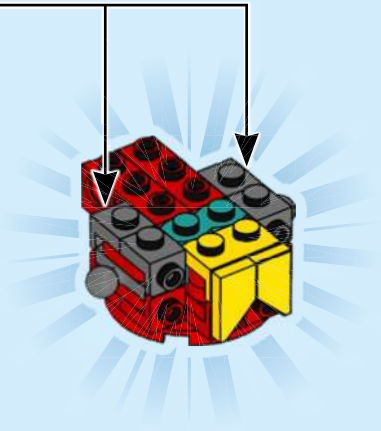
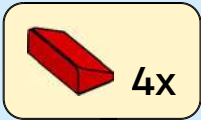

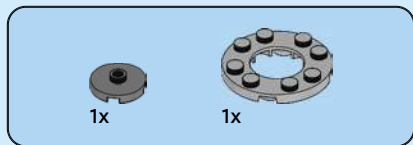

10



11

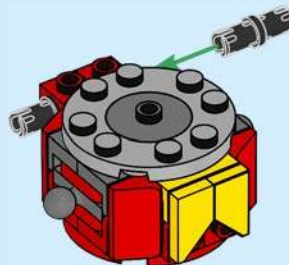



12

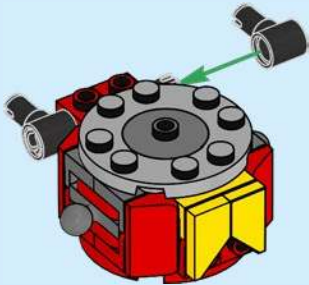

13

1



2

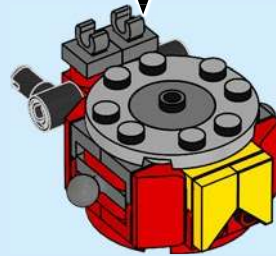



1x

14

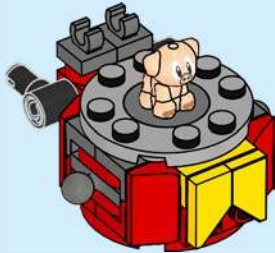

1x

15



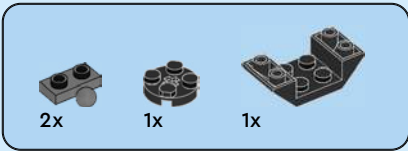

16

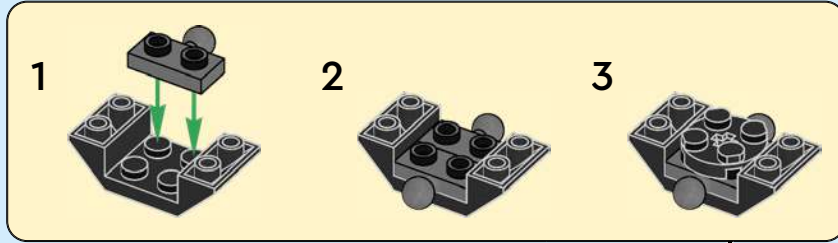

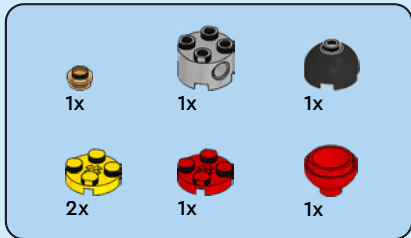

17

1



2

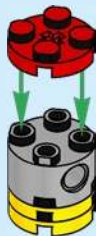

3



4

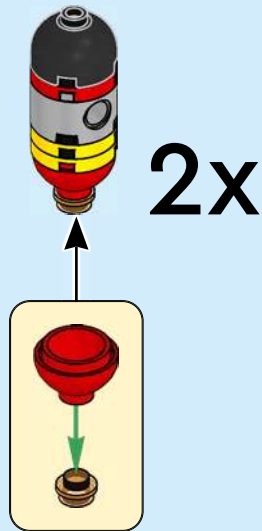

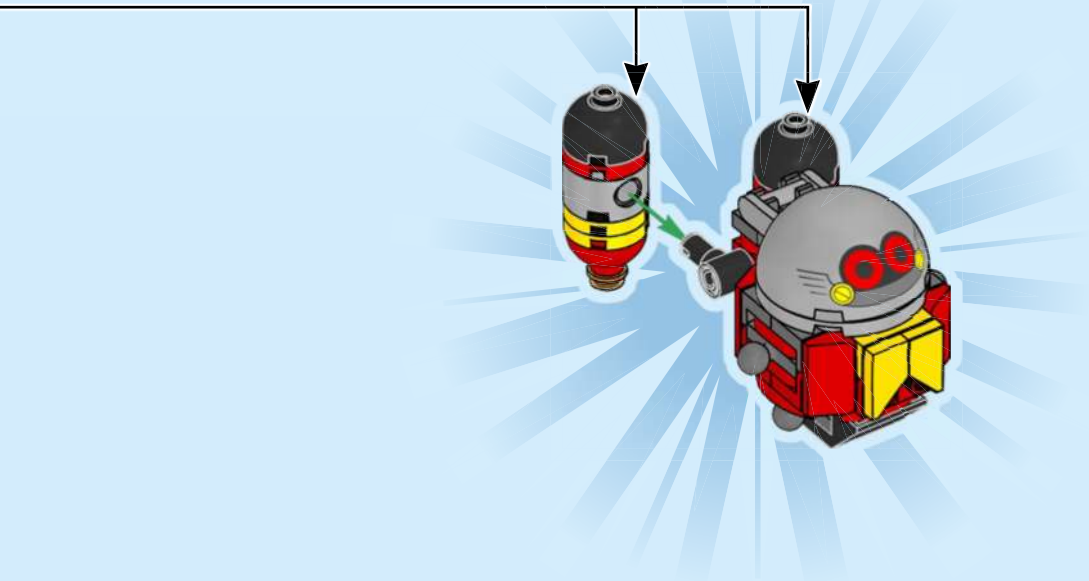

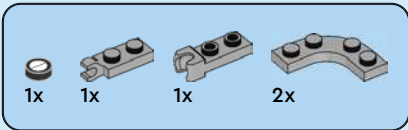

18

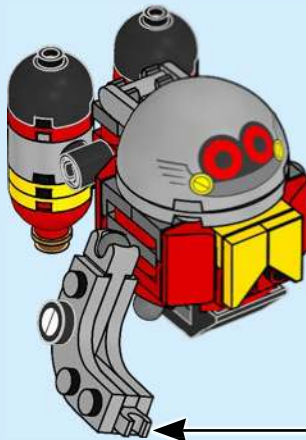
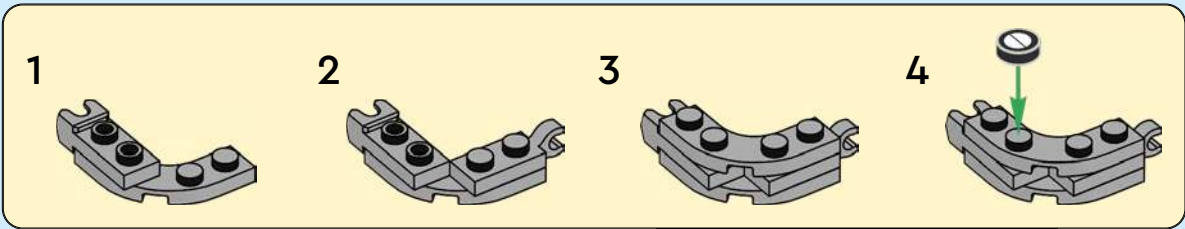

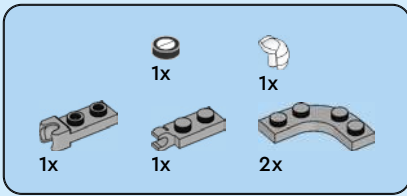

19

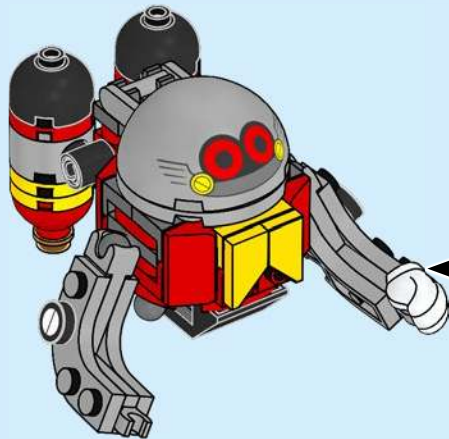
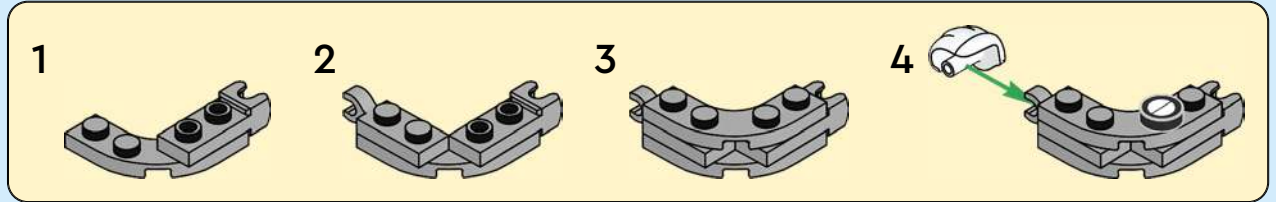

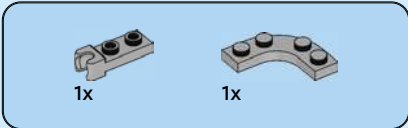

20

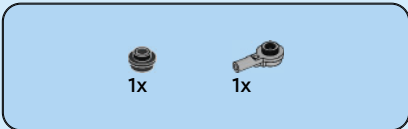

21

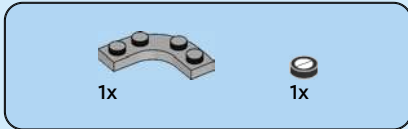

22

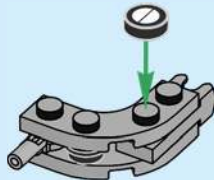

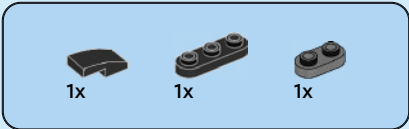

23

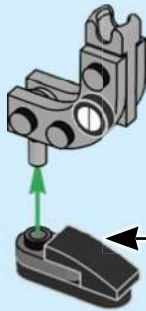
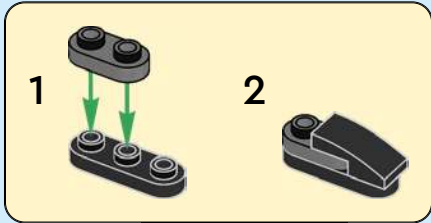

24

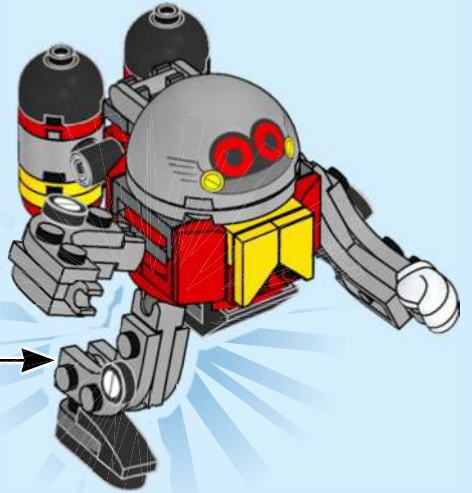

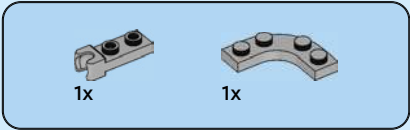

25

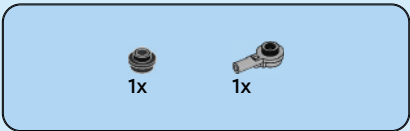

26

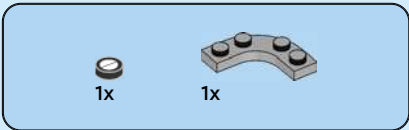

27

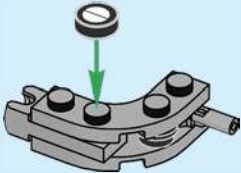

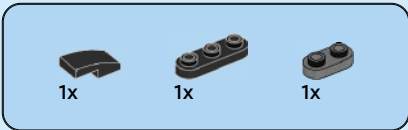

28

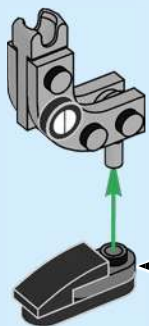
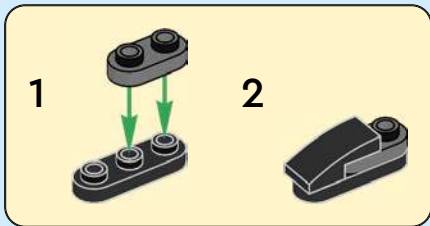

29

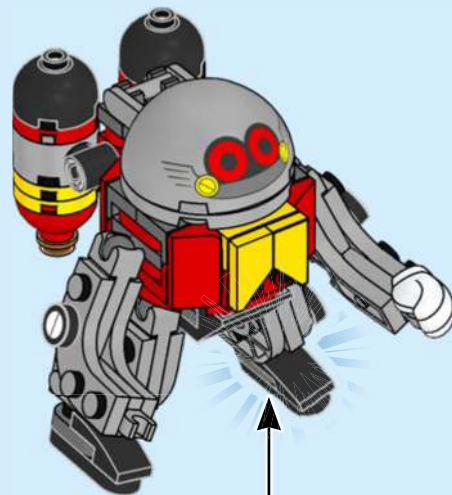

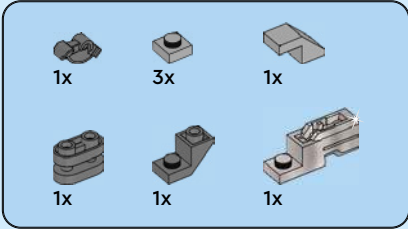

30

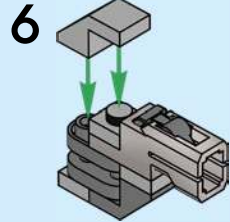
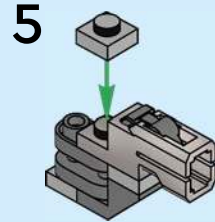
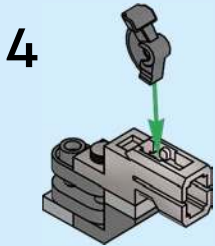
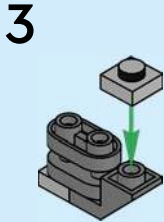
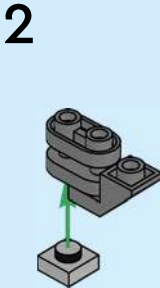
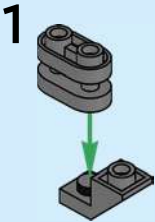

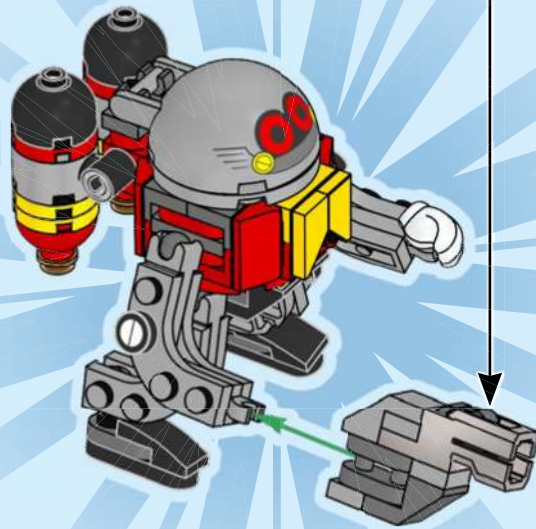

3x



31

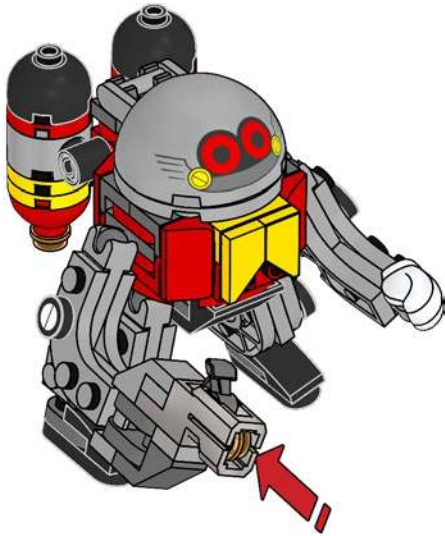





SONIC™

THE HEDGEHOG



EXPLORE MORE



7 LEGO.com/sonic



©SEGA. All rights reserved. SEGA is registered in the U.S. Patent and Trademark Office. SEGA and SONIC THE HEDGEHOG are either registered trademarks or trademarks of SEGA CORPORATION.





1x
6506160



2x
6431337



2x
6248490



1x
6510482



1x
4624086



2x
4666579



1x
4114026



1x
6219794



2x
6313611



1x
6372047



3x
6221467



1x
4114309



1x
6452585



6x
6249907



1x
6399645



86



2x
6510057



8x
6210269



2x
6065839



4x
4651524



4x
403221



4x
4142865



1x
4278275



1x
6173922



3x
614321



1x
6508124



1x
6492337



2x
6494104



1x
6453242



1x
6116606



1x
4188534



2x
6100914

2x
6288246



1x
6474530



1x
6189130



1x
4515348



2x
302021



1x
6510151



1x
6294771



1x
6078279



5x
403224



2x
6331822



1x
6510138



2x
6247387



1x
6185994



1x
6116606



1x
4188534



2x
6100914



2x
6288246

2x
6288246



4x
6168646



4x
6478985



1x
403226



2x
6279875



2x
6429056



2x
614326



2x
6282140



3x
6331716



1x
6173119



2x
6047276



2x
6428168



1x
368026



1x
395726



1x
4188534



2x
6100914



2x
6288246

2x
6288246



2x
6510190



2x
6229130



2x
6253140



3x
6411022



1x
6138624



2x
4537251



2x
6025026



10x
6411328



2x
6334046



4x
6442920



1x
6133859



1x
6129601



2x
6100914



2x
6288246



2x
6288246



2x
6288246

2x
6288246



4x
6013102



2x
4496699



4x
4616593



4x
6000852



4x
4626904



2x
6502374



1x
6506126



2x
6288246



2x
6288246



2x
6288246



2x
6288246



2x
6288246



2x
6288246



2x
6288246



2x
6288246



2x
6288246

2x
6288246

1x
4529241

1x
6258831

4x
4211389

3x
4211399

2x
6227897

10x
4650645

1x
4540203

2x
6372076

4x
6186657

4x
6146223

2x
4211494

1x
6213378

2x
6319336

1x
4211376

1x
4211815

4x
6043639

2x
6225228

1x
4211419

1x
6167798

8x
6383110

1x
4211395

1x
6478984

1x
4618874

1x
6439053

2x
6348057

2x
4225469

6x
6341553

2x
6036503

2x
6182435

1x
4531751

2x
4211151

1x
6428805

1x
4520638

1x
6261388

2x
4211152

1x
4211186

1x
6395635

6x
6115080

4x
6039479

2x
6069164

1x
6435267

4x
4210978

4x
4211075

2x
4211053

4x
4560184

2x
6133811

1x
4211002

2x
4504378

4x
6413106

2x
6344022

1x
6360675

1x
6390673

2x
6221607

1x
6172233

5x
6240227

5x
6278447

7x
6403175

2x
6328339

4x
6247788

1x
6325980

1x
6174946

1x
6501235

1x
6443212

1x
6443196

4x
6022105

1x
6322904

1x
6345950

 [LEGO.com/service](https://www.LEGO.com/service)



YOU COULD **WIN**

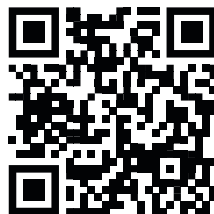

Scan this QR code or go to **LEGO.COM/PRODUCTFEEDBACK** and give us your short feedback about this LEGO® set for a chance to win a cool LEGO prize.

Terms and Conditions apply*

EN: YOU COULD WIN. Terms and Conditions apply* **DE: Du könntest GEWINNEN.** Es gelten die Teilnahmebedingungen* **FR: Tu pourrais GAGNER.** Des conditions s'appliquent* **IT: Potresti VINCERE tu.** Termini e condizioni sono applicabili* **ES: Puedes GANAR.** Aplican términos y condiciones* **PT: Poderá GANHAR.** Aplicam-se termos e condições* **ZH: 轻松获奖. 条款和条件适用*** **PL: Szansa na WYGRANĄ.** Obowiązują warunki korzystania* **CS: Máte šanci VYHRÁT.** Platí všeobecné smluvní podmínky* **SK: Máte šancu VYHRAŤ.** Platia všeobecné zmluvné podmienky* **HU: TE IS NYERHETSZ.** Felhasználási feltételek érvényesek* **RO: Ai putea CÂȘTIGA.** Se aplică termeni și condiții* **BG: Можете да СПЕЧЕЛИТЕ.** Има определени правила и условия* **LV: Tu vari LAIMĒT.** Ir spēkā noteikumi un nosacījumi.* **ET: Sul on võimalus VÕITA.** Kehtivad tingimused* **LT: Jūs galite LAIMĖTI.** Taikomos sąlygos*

*[LEGO.com/productfeedback-terms](https://www.lego.com/productfeedback-terms)

LEGO and the LEGO logo are trademarks of the LEGO Group. ©2024 The LEGO Group.

©SEGA. All rights reserved. SEGA is registered in the U.S. Patent and Trademark Office.
SEGA and SONIC THE HEDGEHOG are either registered trademarks or trademarks of SEGA CORPORATION.

6530633