



WICKED

75684



1

2



LEGO® Builder



LEGO.com/sustainable-packaging



FR
DONNEZ
OU
RECYCLEZ

 OU  OU 

ASSOCIATION MAGASIN DÉCHÈTERIE

Adresses sur quefairedemesdechets.fr

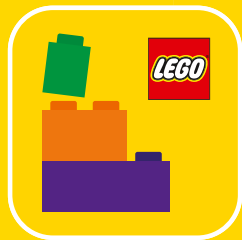

Q LEGO® Builder

BUILDER



Apple and the Apple logo are trademarks of Apple Inc., registered in the U.S. and other countries and regions. App Store is a service mark of Apple Inc. Google Play and the Google Play logo are trademarks of Google LLC. Tencent and the Tencent logo are trademarks of Tencent Inc.

Q LEGO.com/devicecheck

EN Ask parents' permission before going online | DE Eltern um Erlaubnis bitten, bevor du online gehst | FR Demande l'autorisation d'un parent avant d'aller en ligne | IT Chiedi il permesso ai tuoi genitori prima di andare online | ES Pídeles permiso a tus papás antes de conectarte a Internet | PT Pede autorização aos pais antes de acederes online | ZH 上网前应先征得父母的同意 | PL Poproś rodziców o zgodę, zanim wejdiesz do Internetu | CS Než půjdeš na internet, požádej rodiče o svolení | SK Skôr než pôjdeš na internet, vypýtaj si povolenie od rodičov | HU Kérj szülői engedélyt, mielőtt online csatlakoznál! | RO Cere permisiunea părinților înainte de a te conecta online | BG Поискайте разрешение от родител, преди да влезете онлайн | LV Pirms došanās tiešsaistē palūdz atļauju vecākiem | ET Enne Interneti kasutamist küsi vanematelt luba | LT Prieš prisijungdami prie interneto, atsiklauskite tėvų



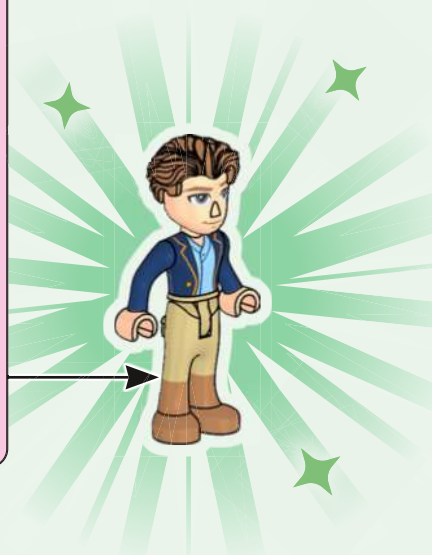
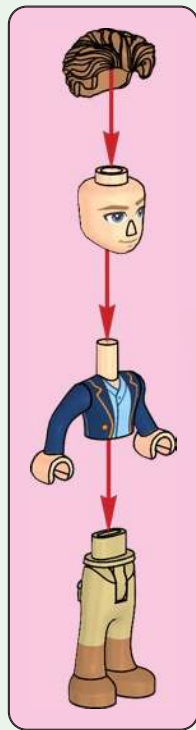

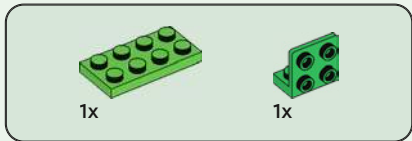
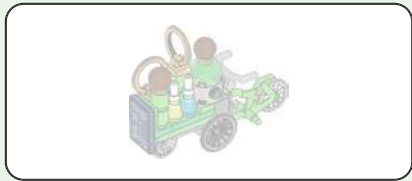

1

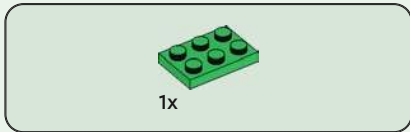
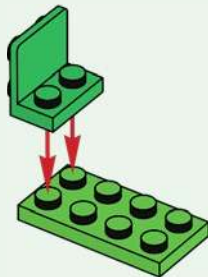

2

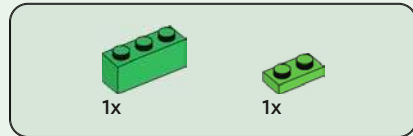
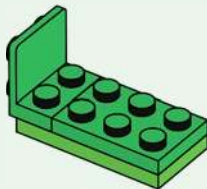

3

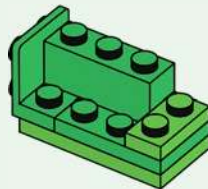



1x

4

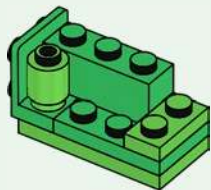

1x



1x

5

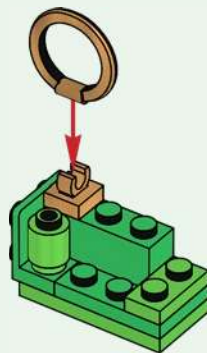



6

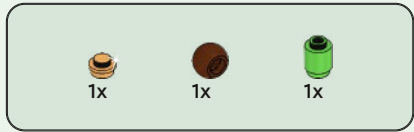
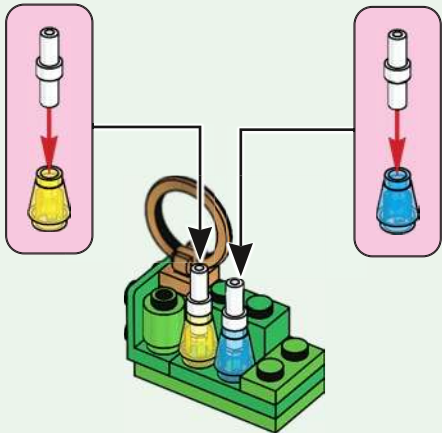

7

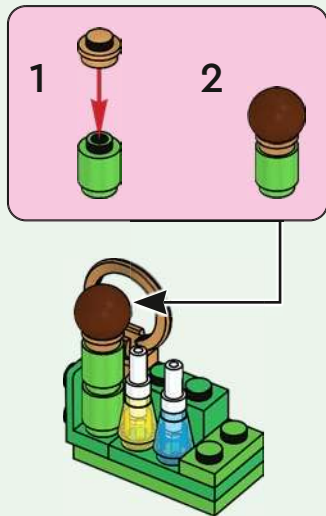



1x

8



1x



1x

9





1x



2x



1x

10

1



2

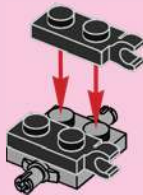

3

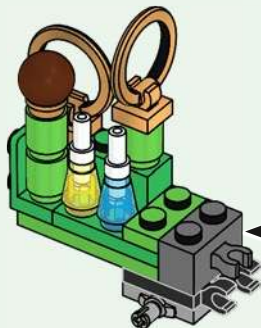

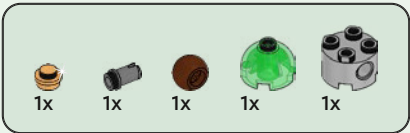

11

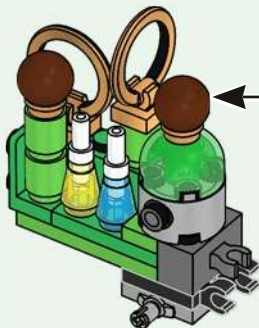
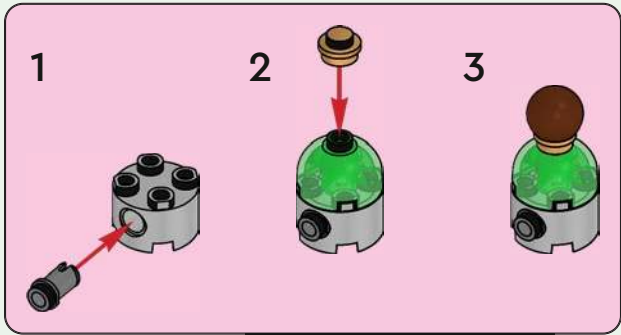



1x

12

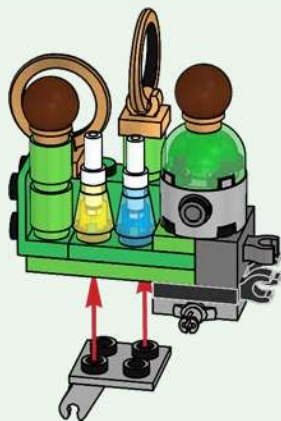

12



1x

13

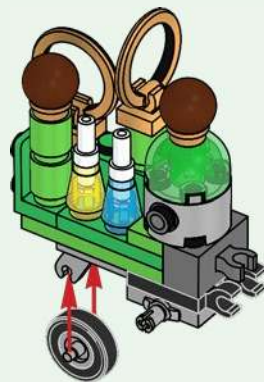



2x

14

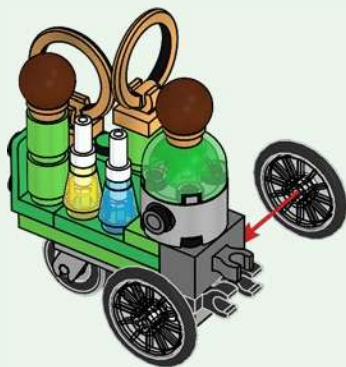

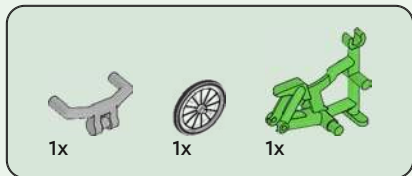

15

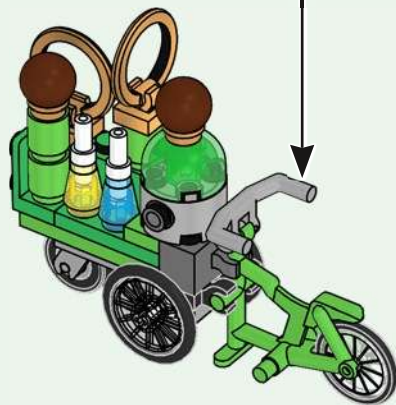
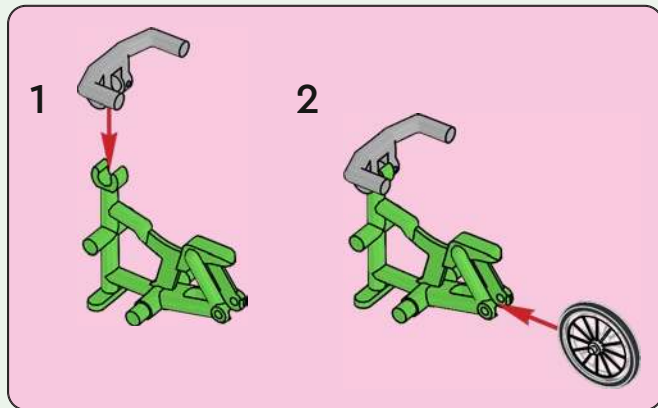

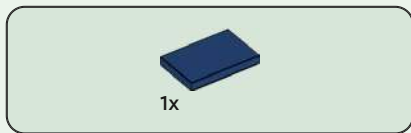

16

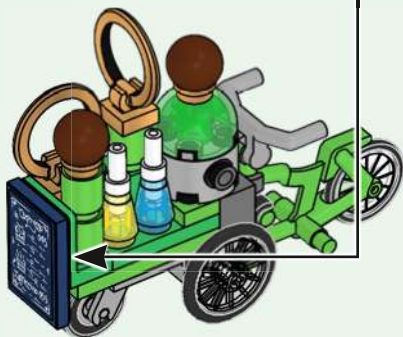
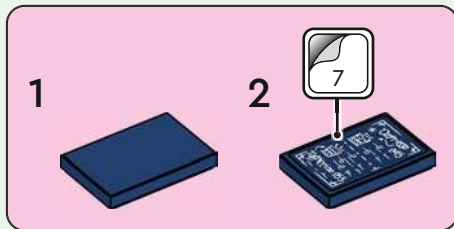

17



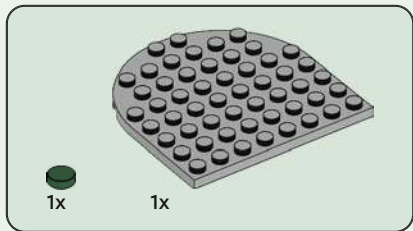

1

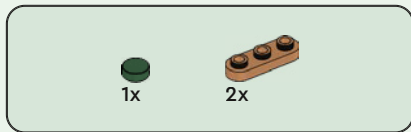
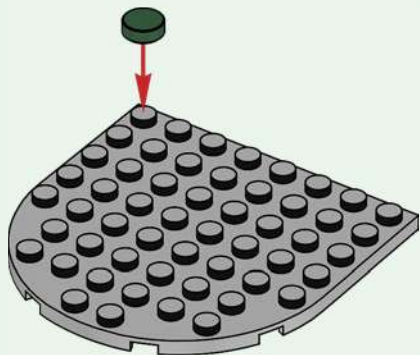

2

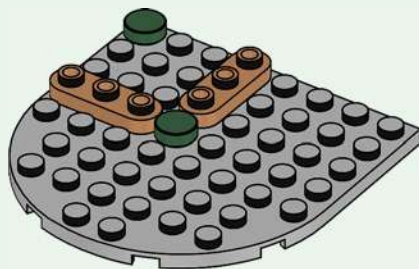

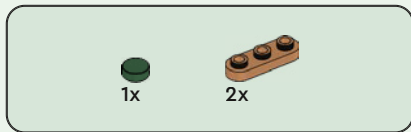

3

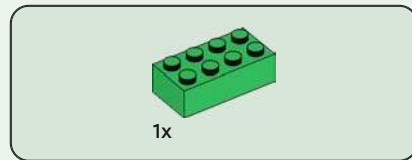
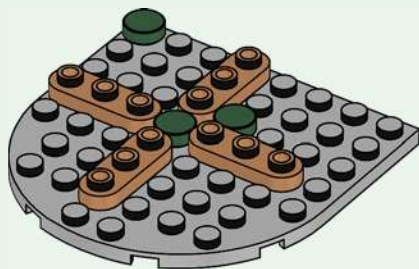

4

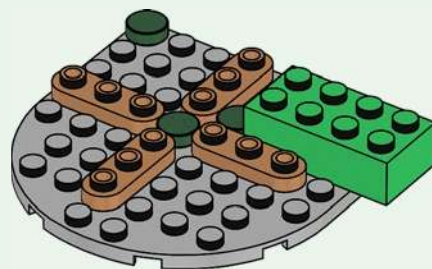



4x

5



2x

6

1



2

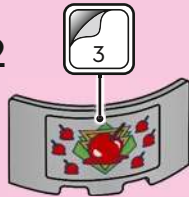

2x

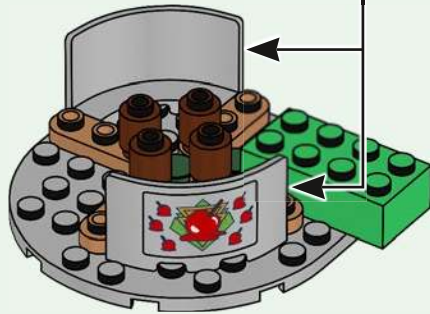

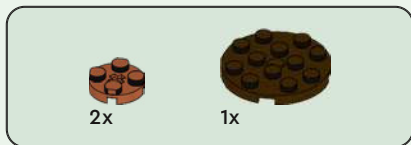

7

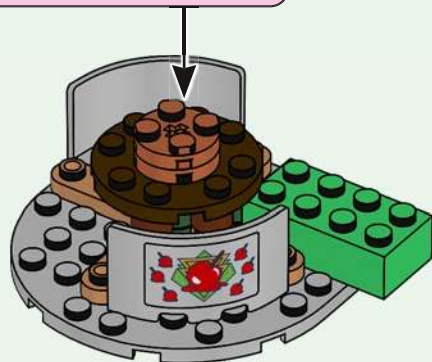
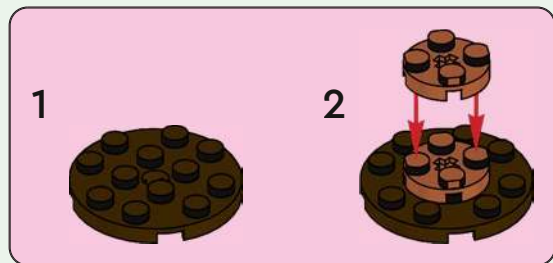

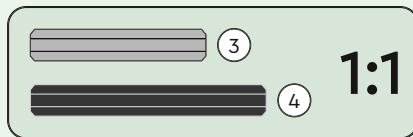
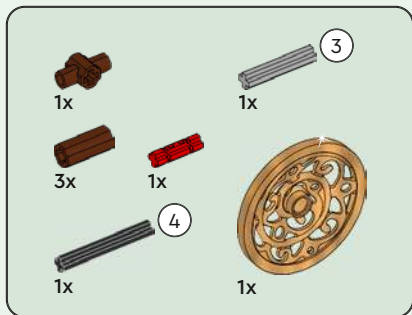

8

1



2



3



4



5

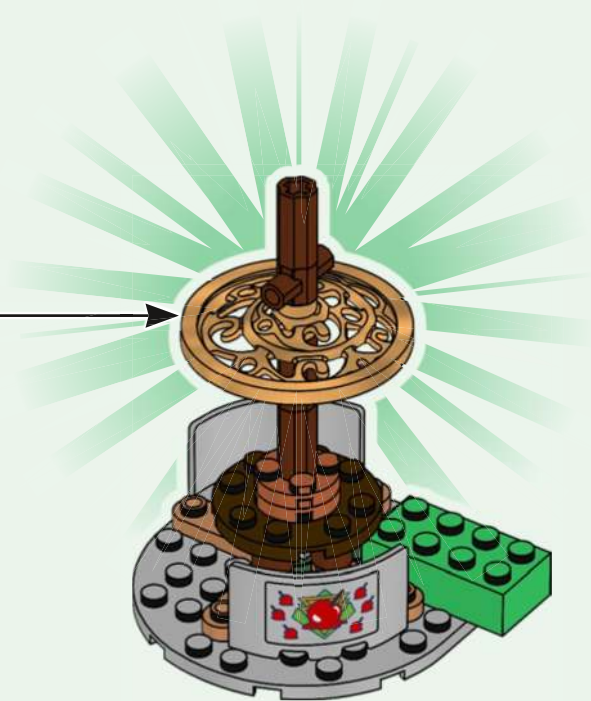



9

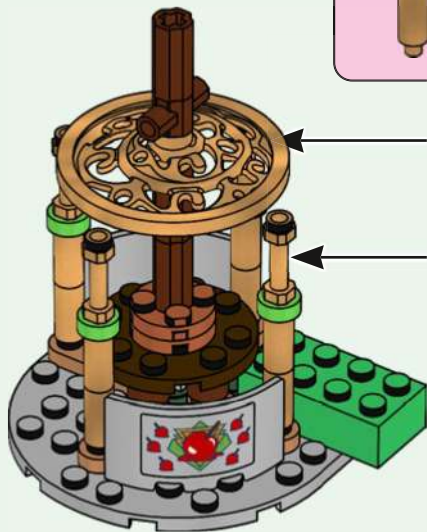
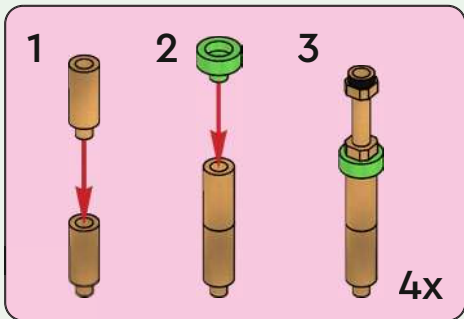



3x

10





3x



3x



3x



3x



3x

11

1



2



3



3x







1x



1x

12

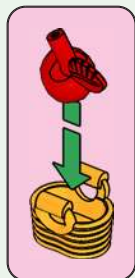



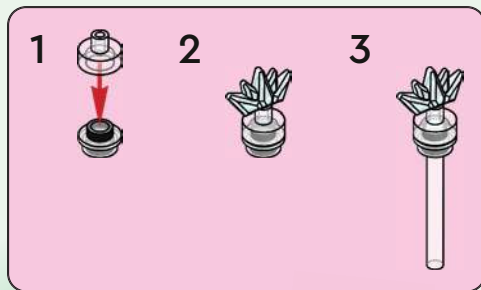
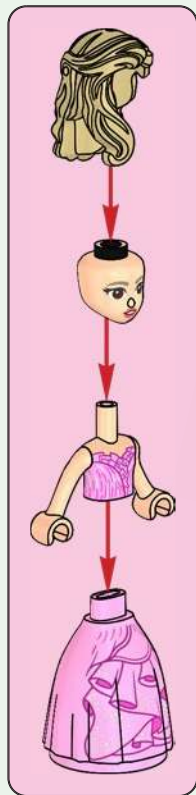

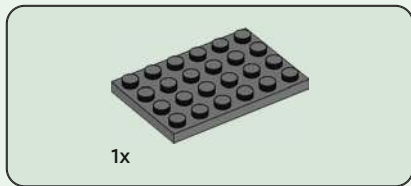

13





1x

14





2x



1x

15



1

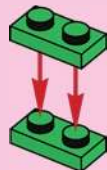

2





1x



1x

16

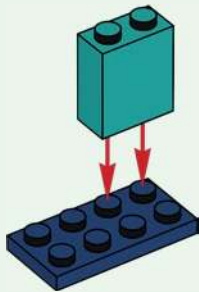

1x

17

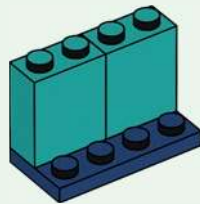



18

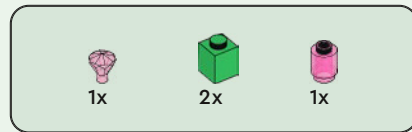
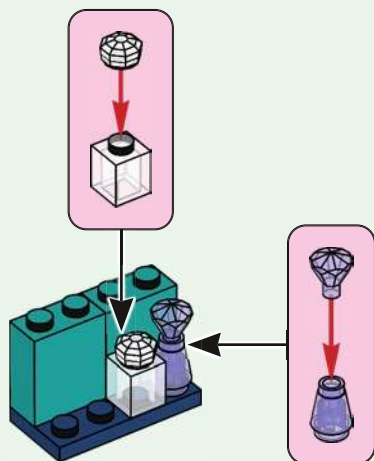

19

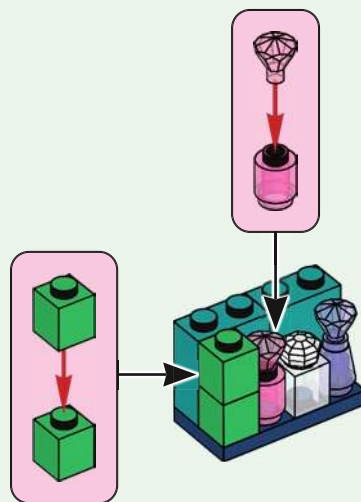



1x

20



2x

21





22

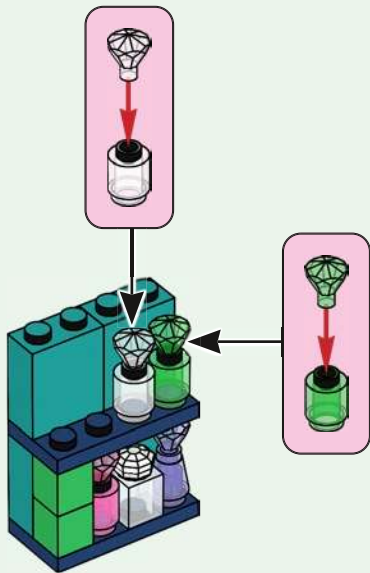

23

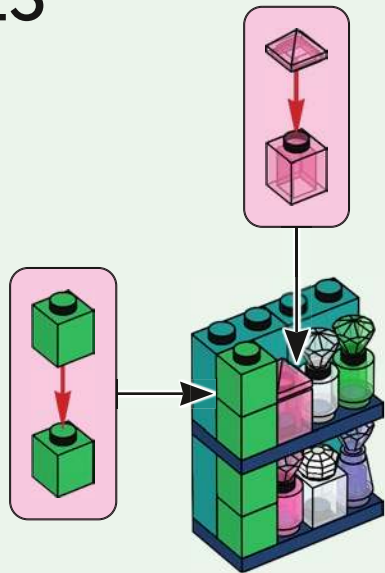

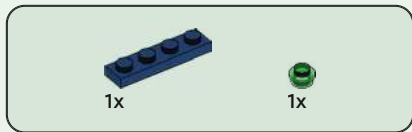

24



25



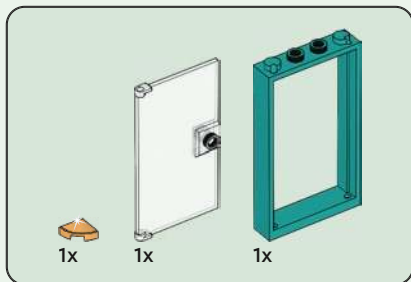

26

1



2

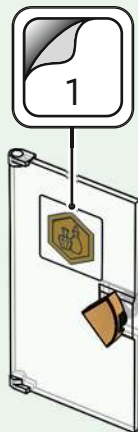

3

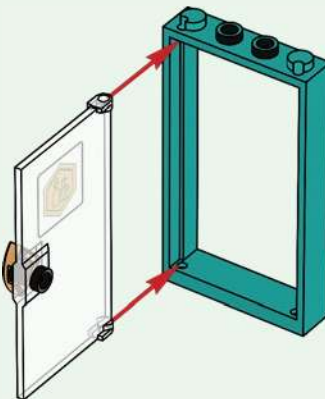





2x

27

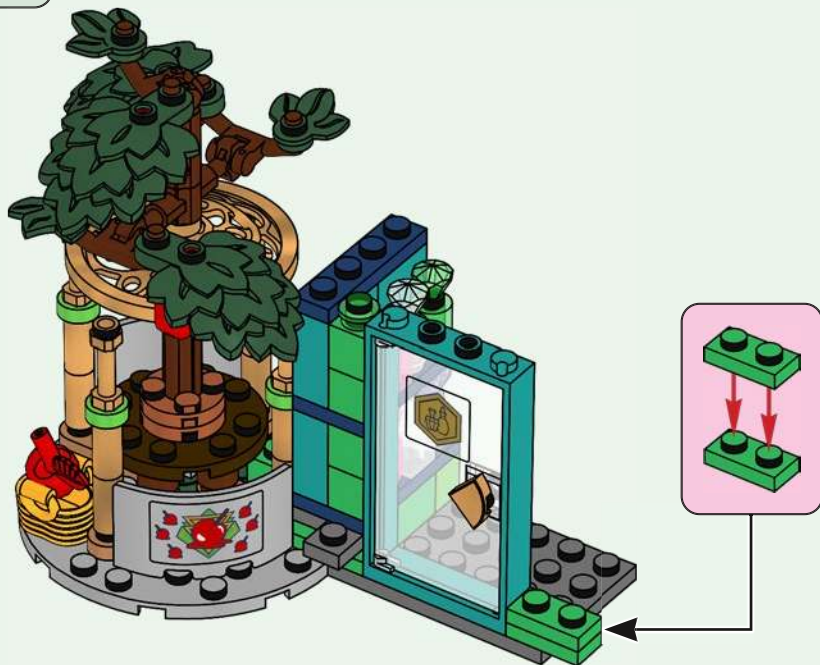



1x

28





1x



1x



1x

29





1x



1x

30

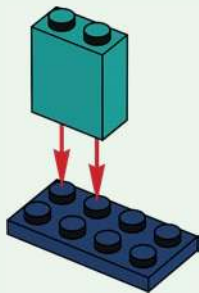

1x

31

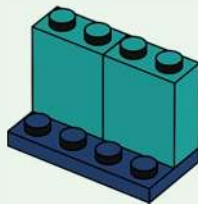

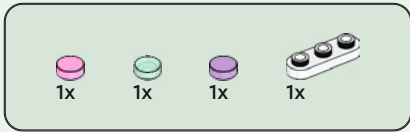

32

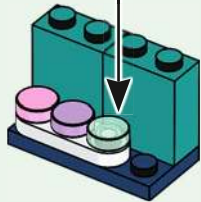
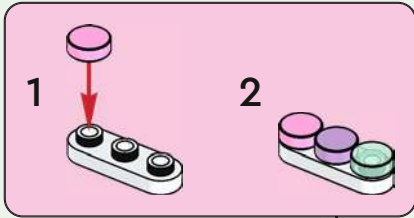

33

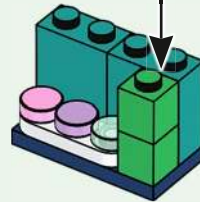
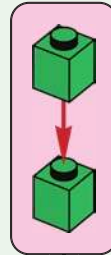

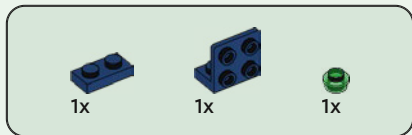

34

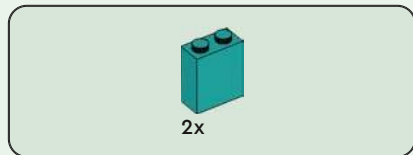
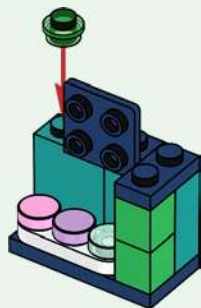

35





2x

36

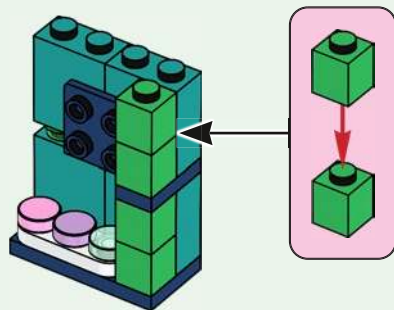

1x



1x

37





1x

38

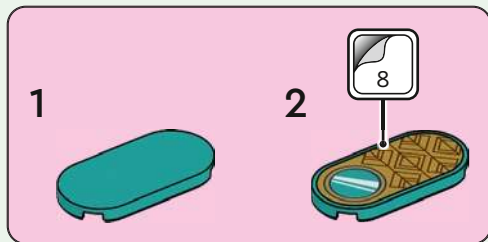

39





2x

40



2x



2x

41



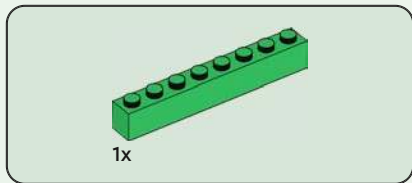

42





2x



1x

43





2x

44





1x



1x

45

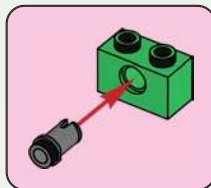

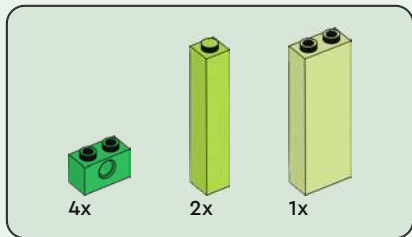

46

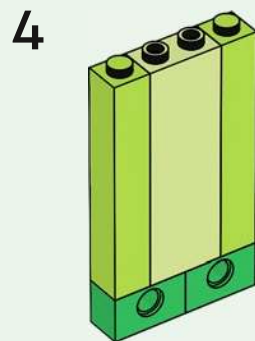
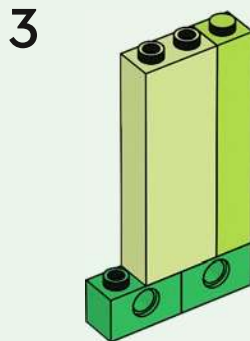
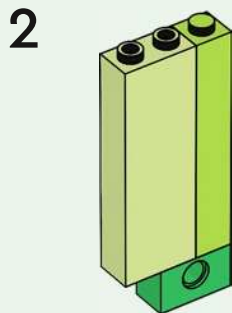
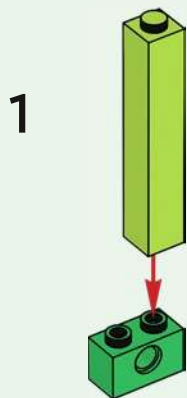

5

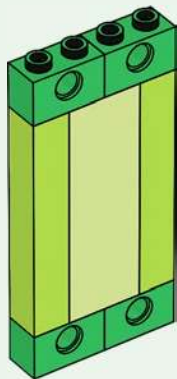

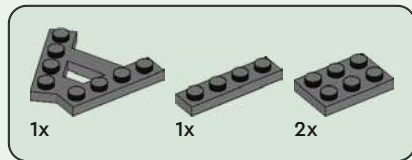

47





2x



2x

48





1x

49



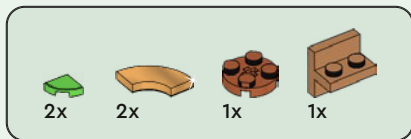

50

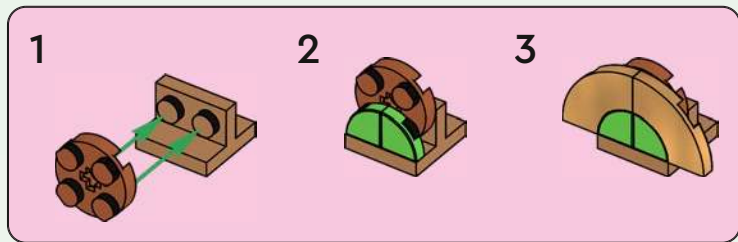

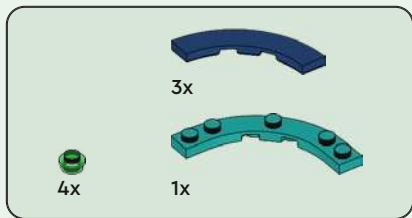

51

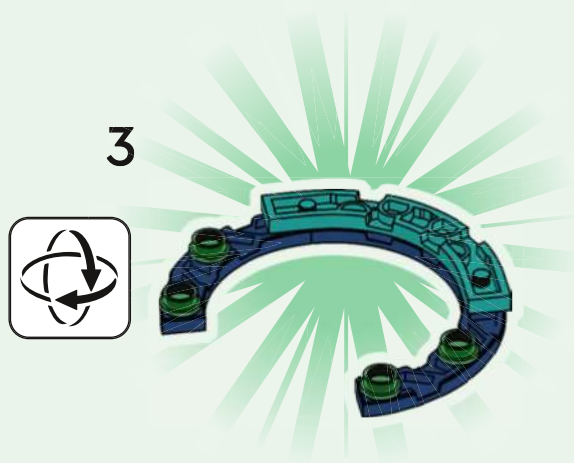
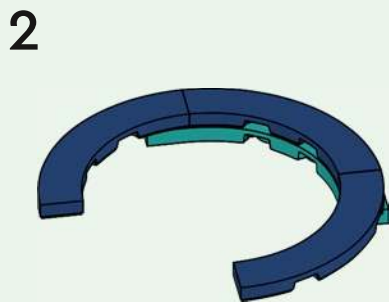
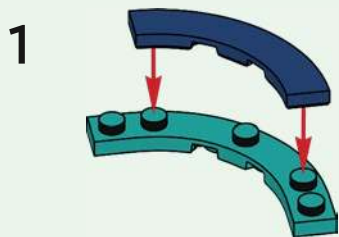





2x



1x

52

