



# SONIC™

THE HEDGEHOG

77003



Q LEGO® Builder



[LEGO.com/sustainable-packaging](https://LEGO.com/sustainable-packaging)



**FR**  
**DONNEZ**  
OU  
**RECYCLEZ**

 OU  OU 

ASSOCIATION MAGASIN DÉCHÈTERIE

Adresses sur [quefairedemesdechets.fr](https://quefairedemesdechets.fr)

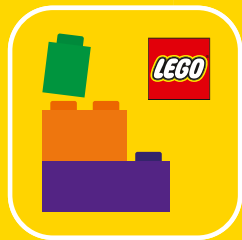

Q LEGO® Builder

# BUILDER



Apple and the Apple logo are trademarks of Apple Inc., registered in the U.S. and other countries and regions. App Store is a service mark of Apple Inc. Google Play and the Google Play logo are trademarks of Google LLC. Tencent and the Tencent logo are trademarks of Tencent Inc.

Q [LEGO.com/devicecheck](https://www.lego.com/devicecheck)

EN Ask parents' permission before going online | DE Eltern um Erlaubnis bitten, bevor du online gehst | FR Demande l'autorisation d'un parent avant d'aller en ligne | IT Chiedi il permesso ai tuoi genitori prima di andare online | ES Pídeles permiso a tus papás antes de conectarte a Internet | PT Pede autorização aos pais antes de acederes online | ZH 上网前应先征得父母的同意 | PL Poproś rodziców o zgodę, zanim wejdiesz do Internetu | CS Než půjdeš na internet, požádej rodiče o svolení | SK Skôr než pôjdeš na internet, vypýtaj si povolenie od rodičov | HU Kérj szülői engedélyt, mielőtt online csatlakoznál! | RO Cere permisiunea părinților înainte de a te conecta online | BG Поискайте разрешение от родител, преди да влезете онлайн | LV Pirms došanās tiešsaistē palūdz atļauju vecākiem | ET Enne Interneti kasutamist küsi vanematelt luba | LT Prieš prisijungdami prie interneto, atsiklauskite tėvų





1x



1x

1

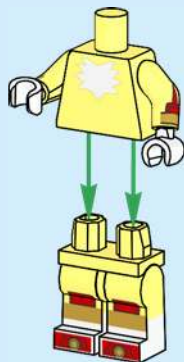

1x

2



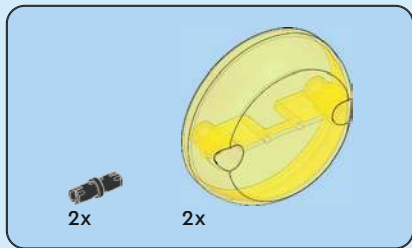

3

1



2

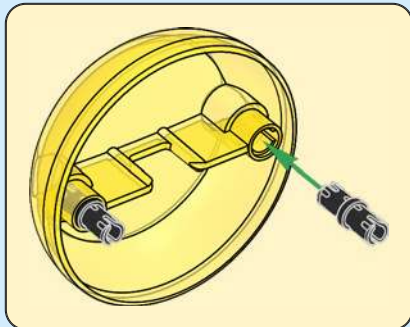
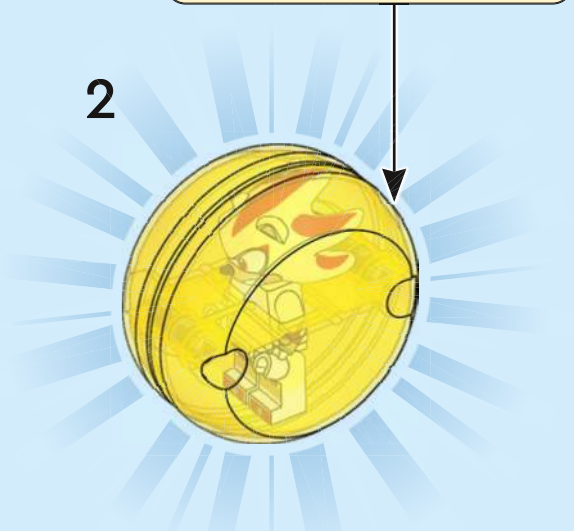

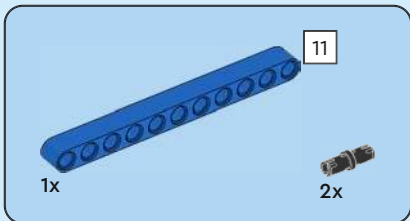
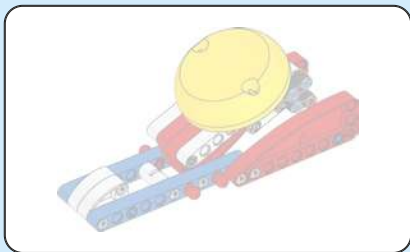

1

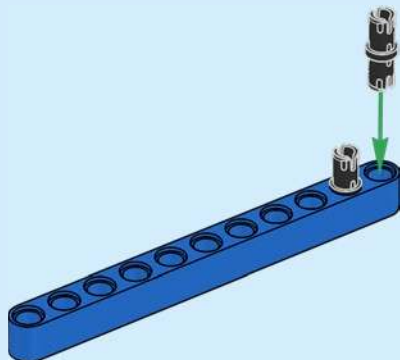
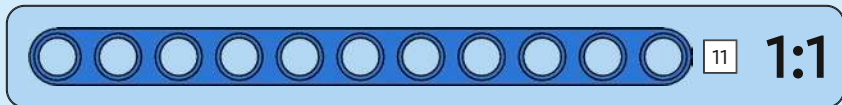



2x

2

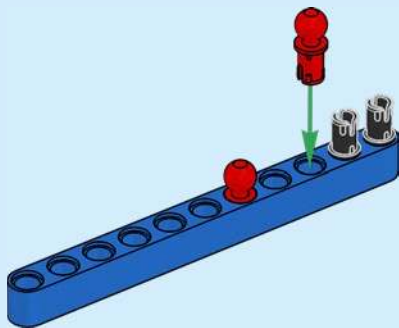

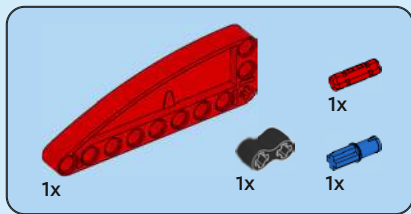

3

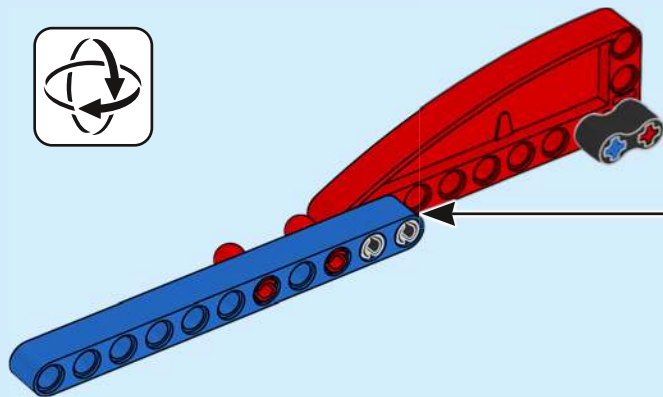
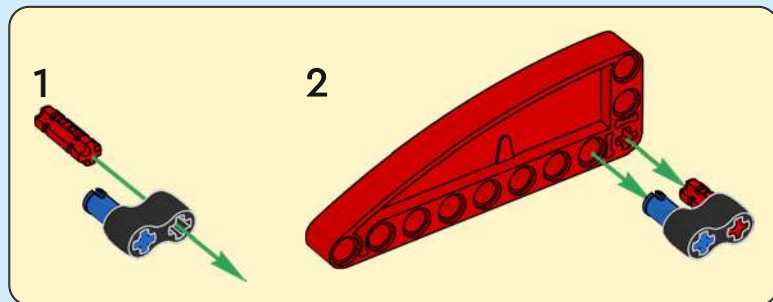



4

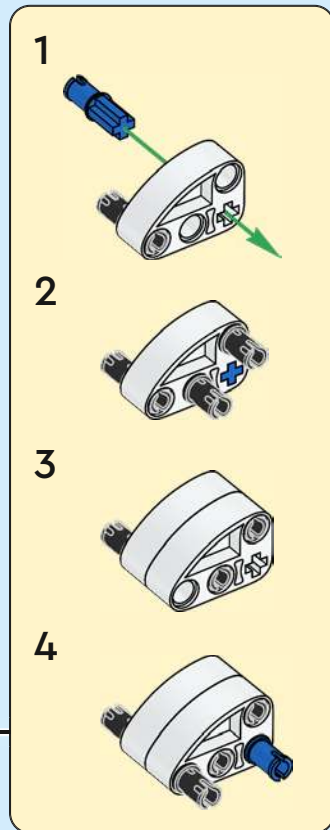
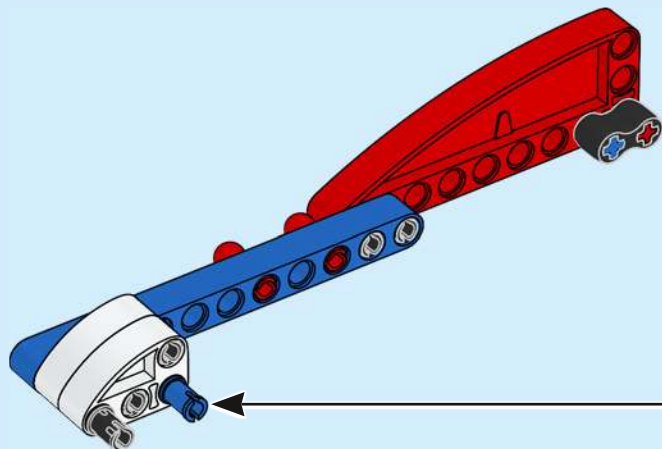



1x



2x

5

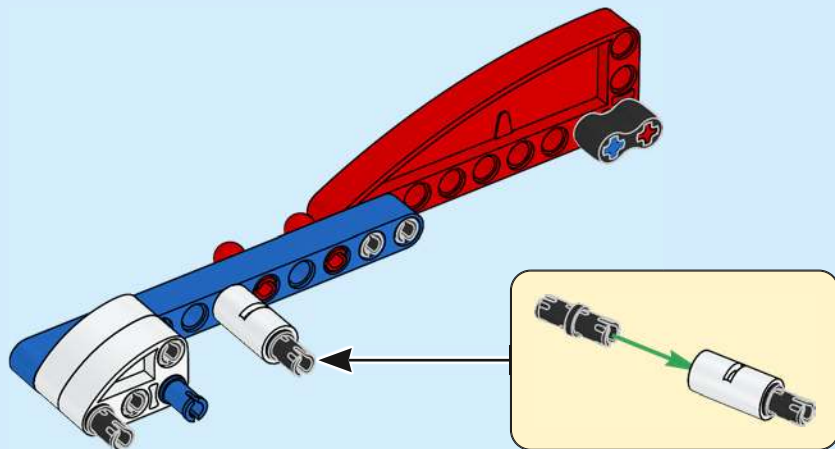

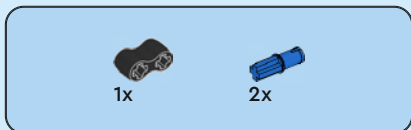

6

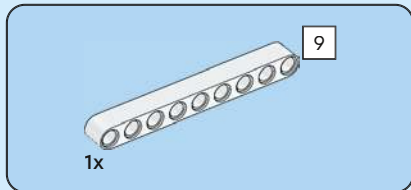
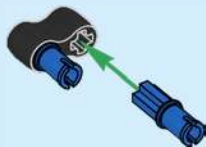

7

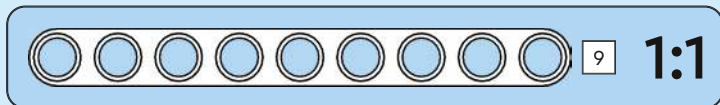
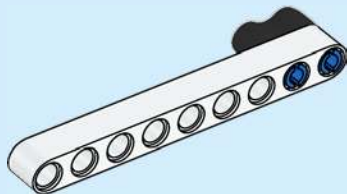

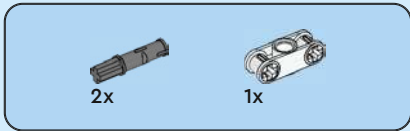

8

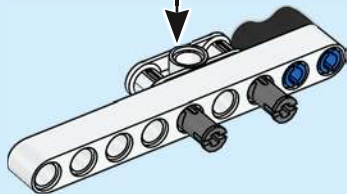
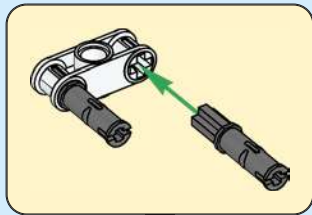

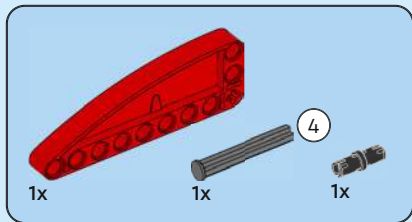

9

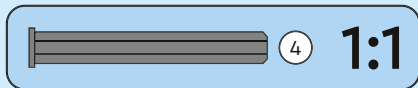
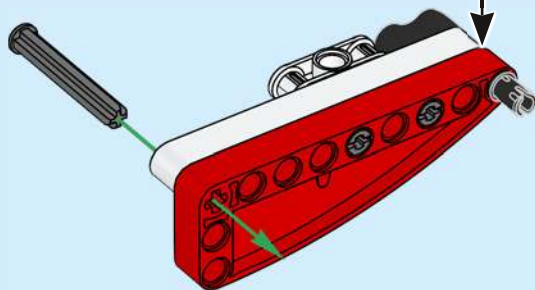
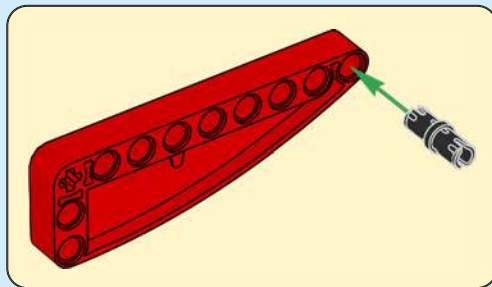

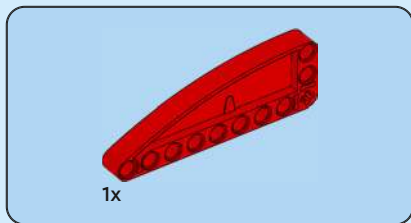

10

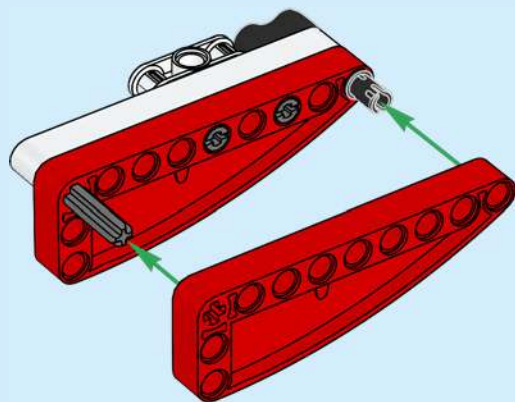

11

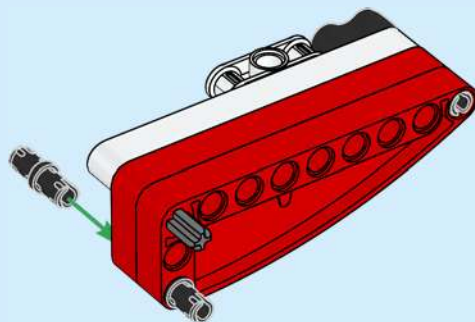

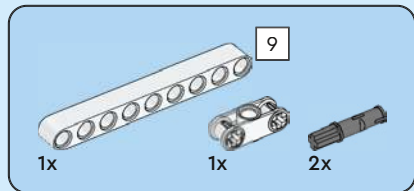

12

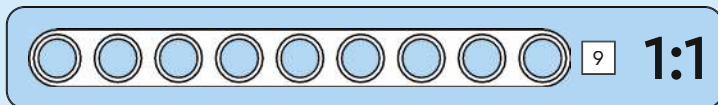
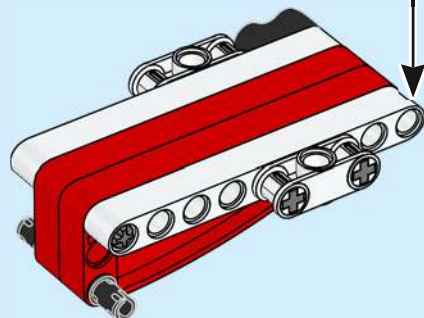
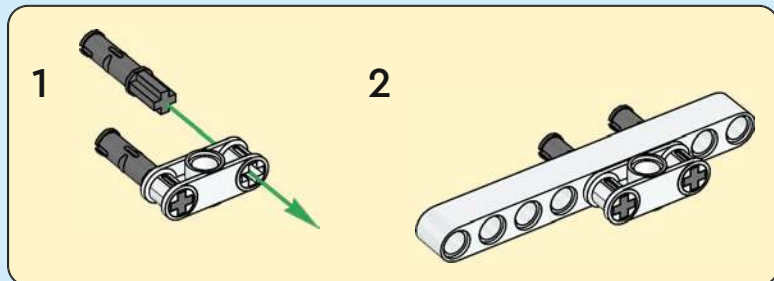



1x



2x

13

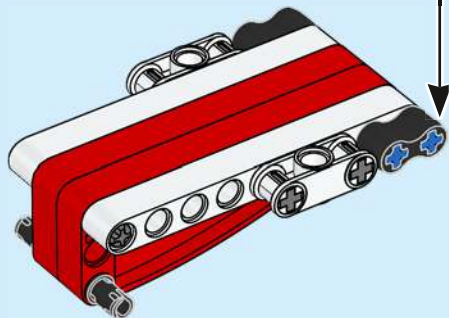
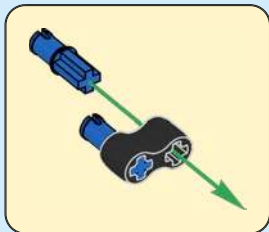

2x

14

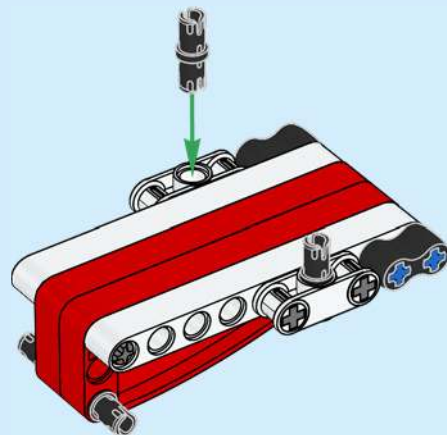

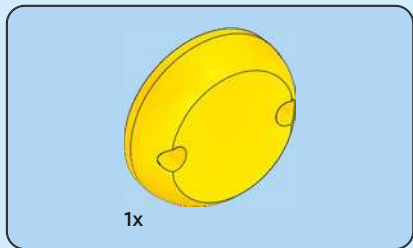

15

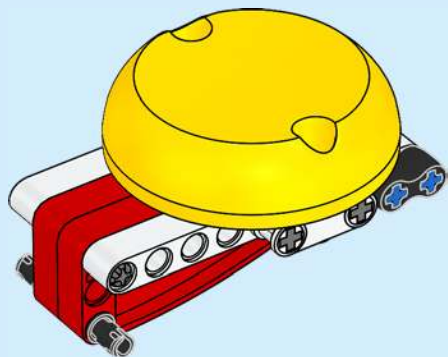

16

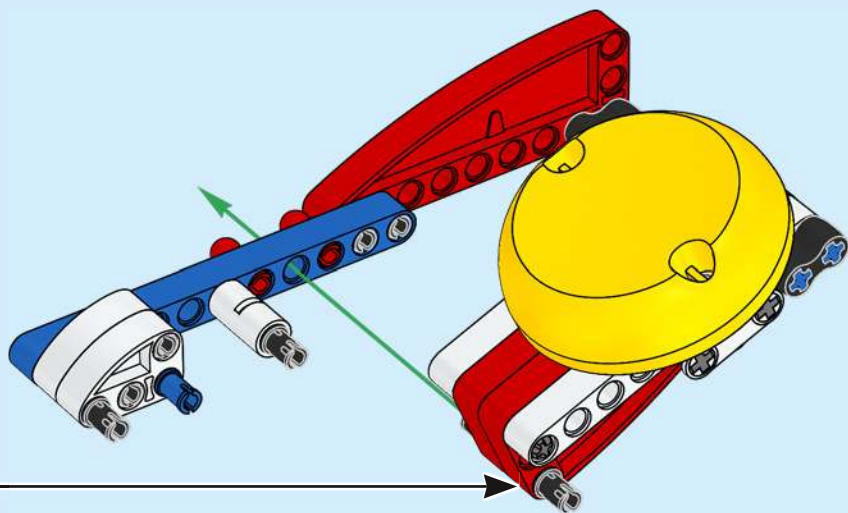

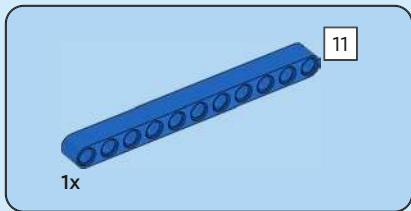

17

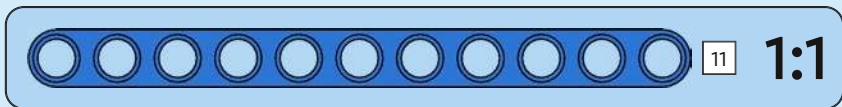
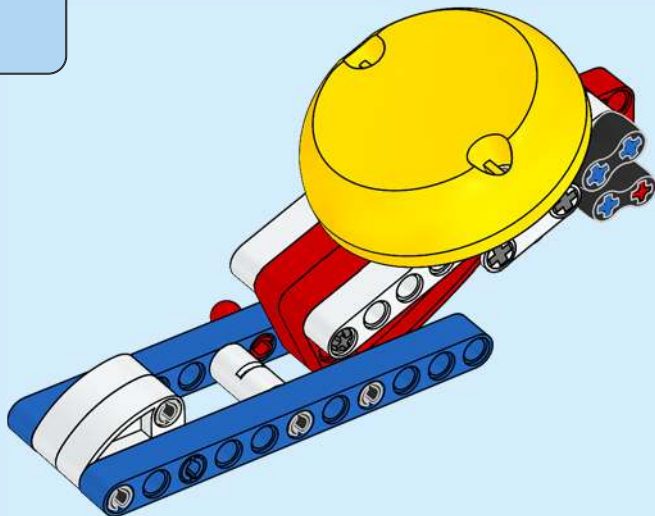



2x



2x

18

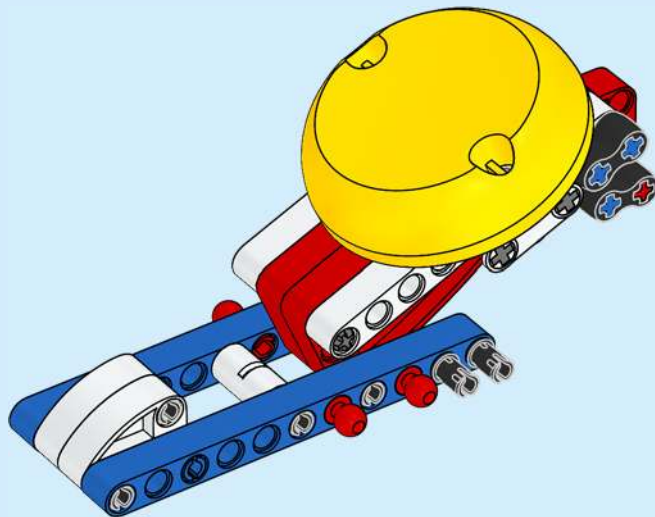

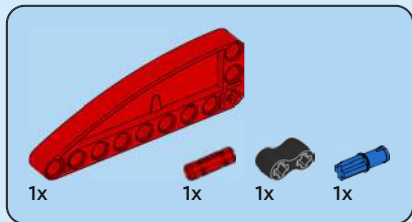

19

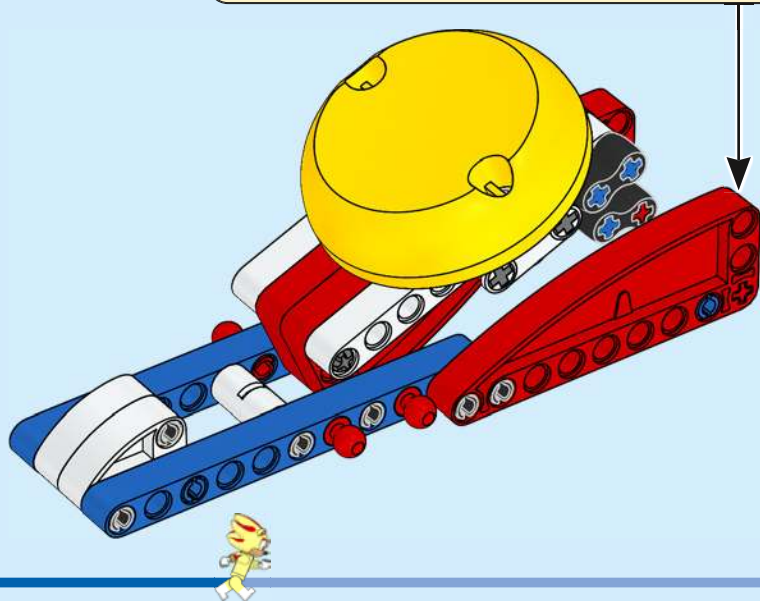
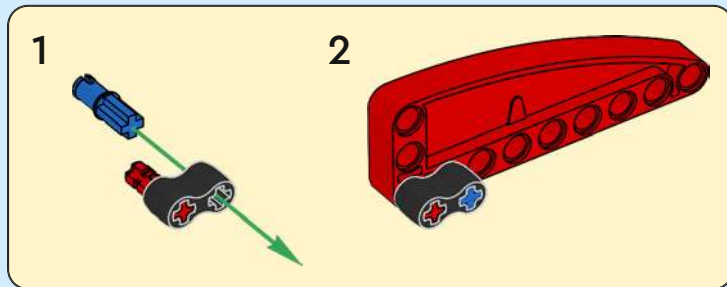

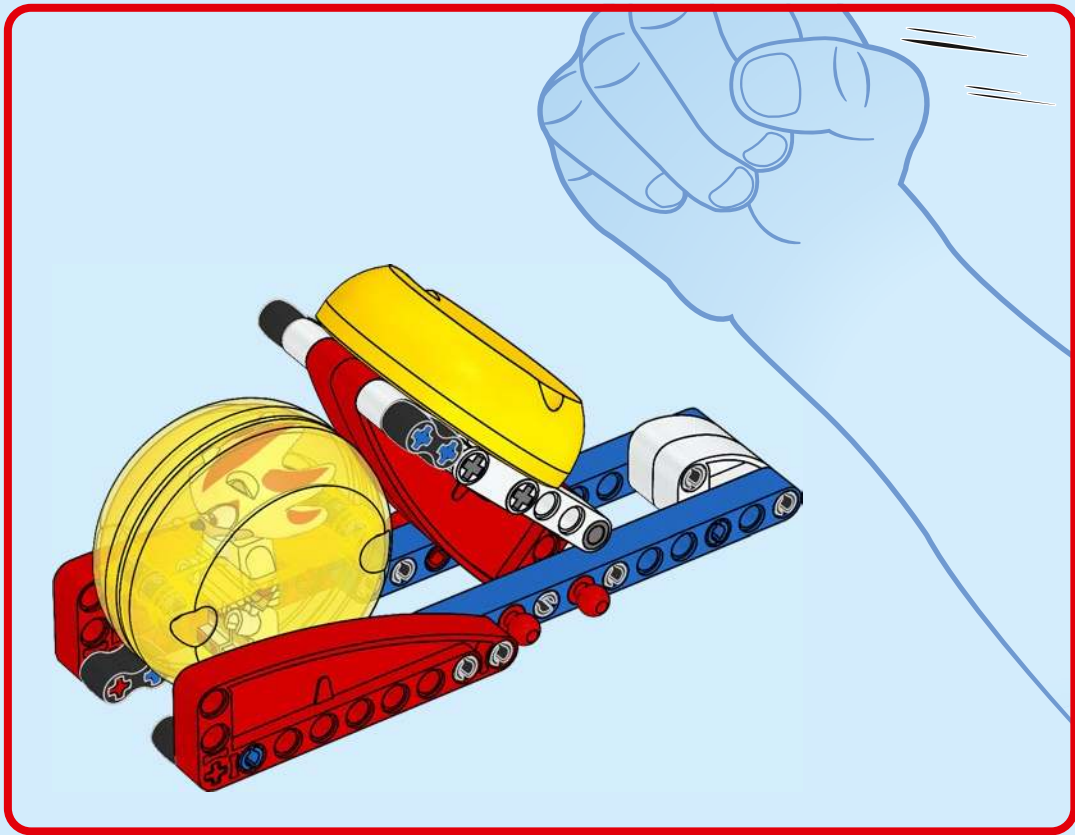

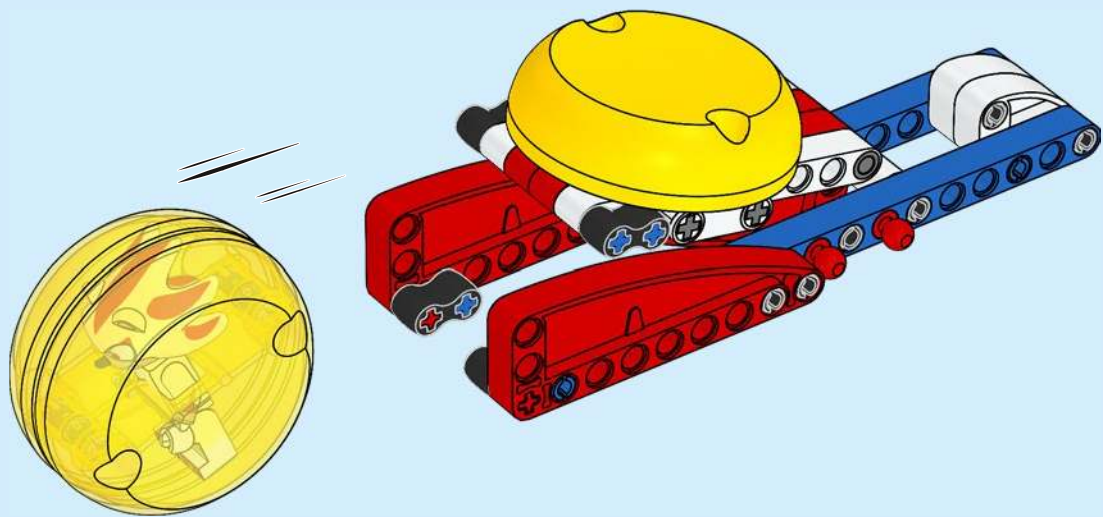



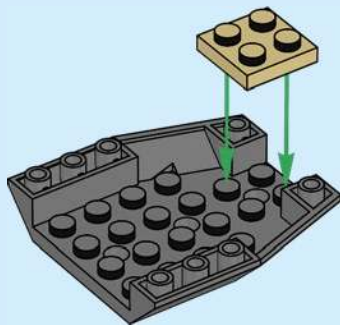
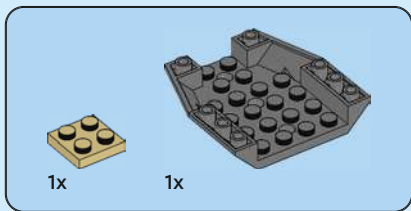
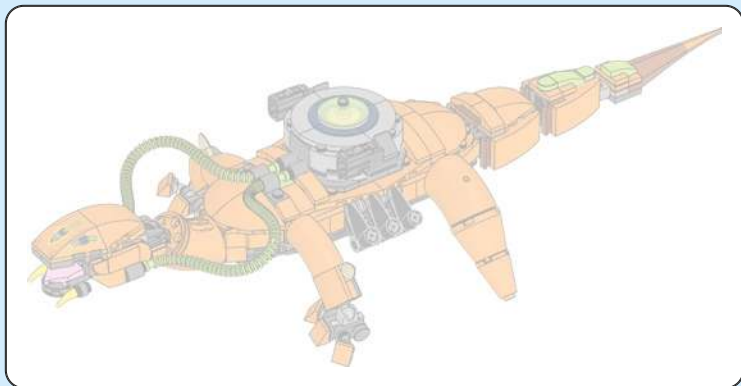

1



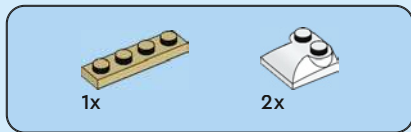

2

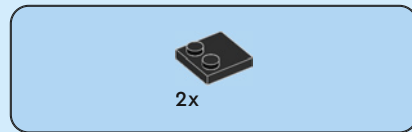
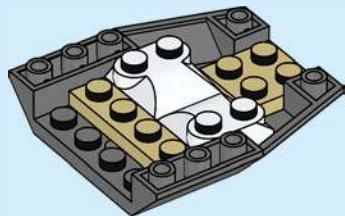

3

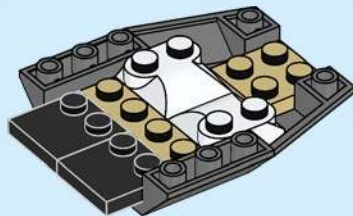

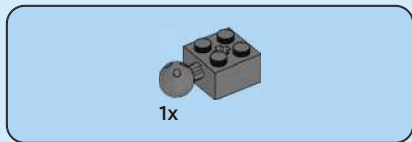

4

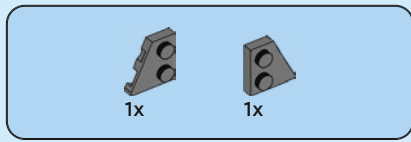
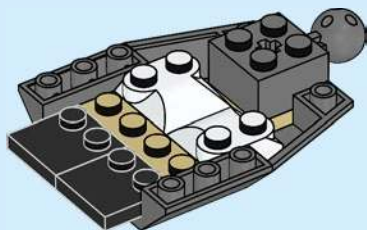

5

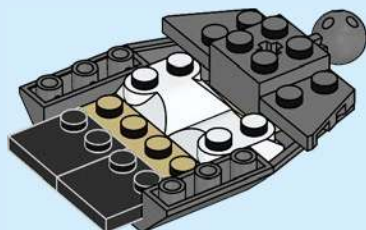



1x

6

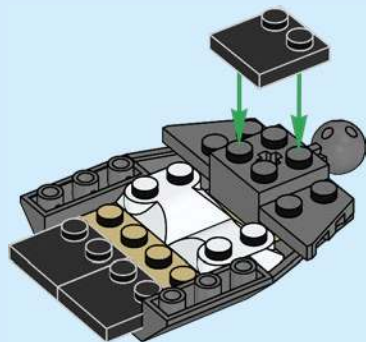

1x

7

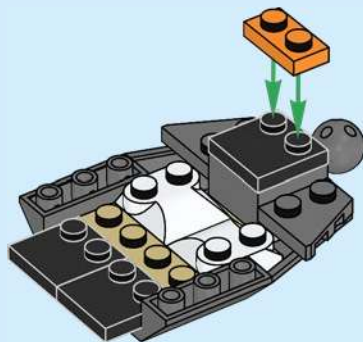



8

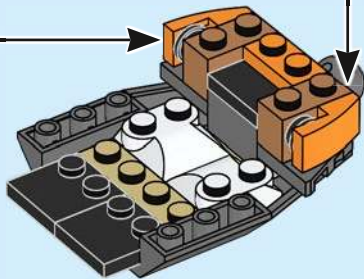
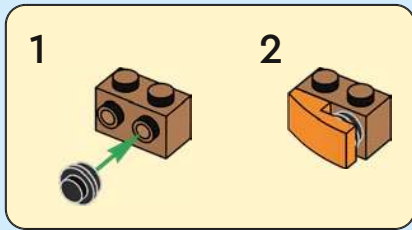
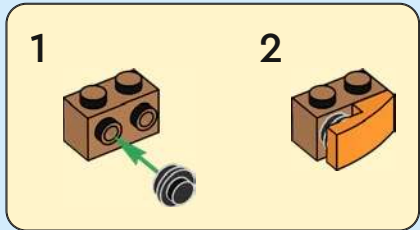



2x



2x

9

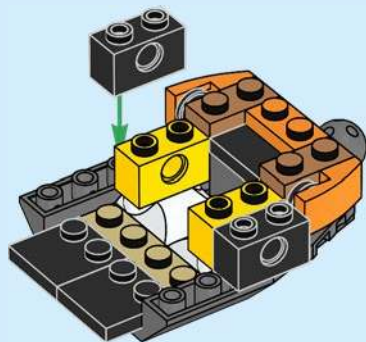

2x

10

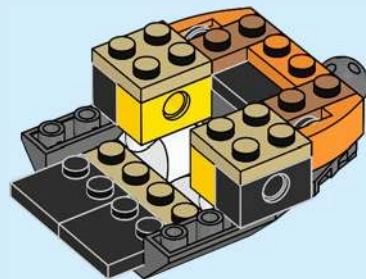





2x

13

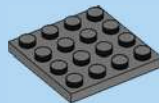
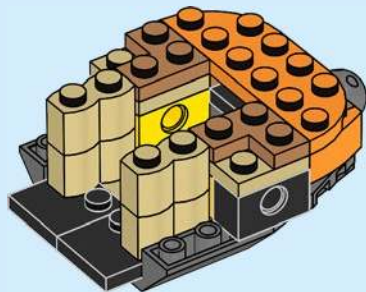

1x

14

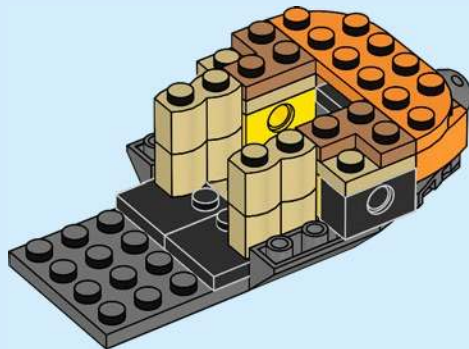



2x



1x

15

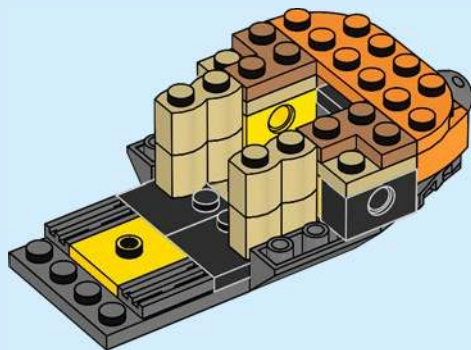

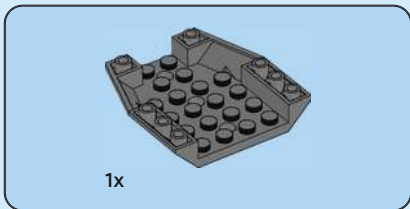
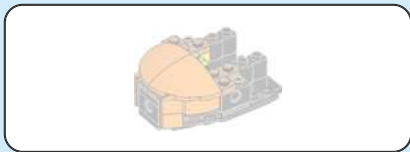

16

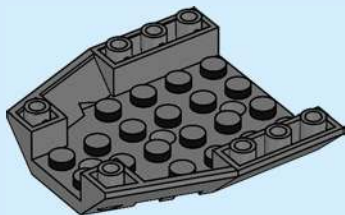

17

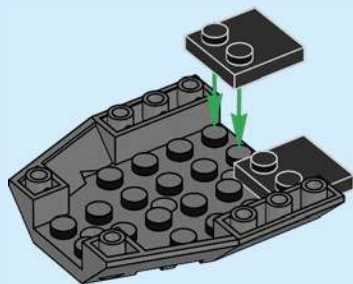

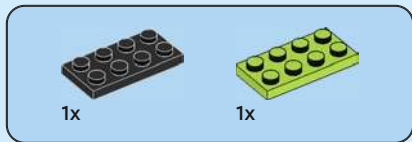

18

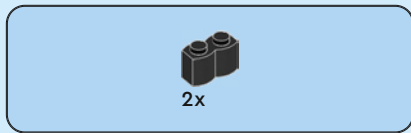
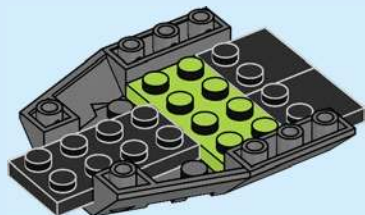

19

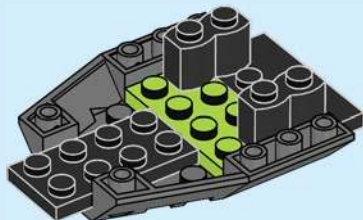

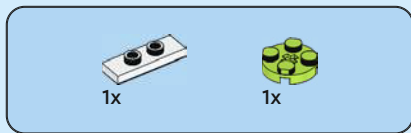

20

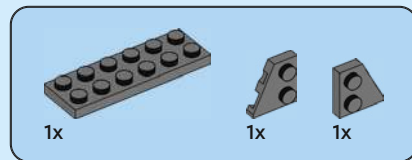
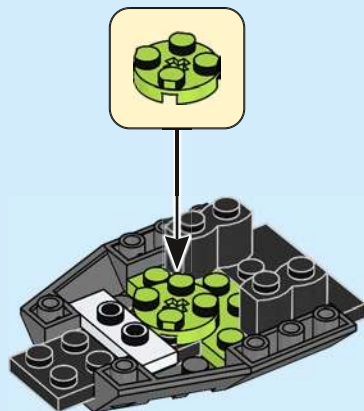

21

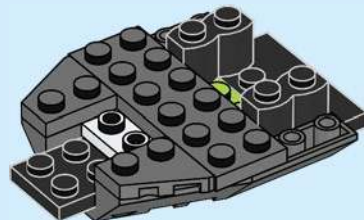



1x



1x

# 22

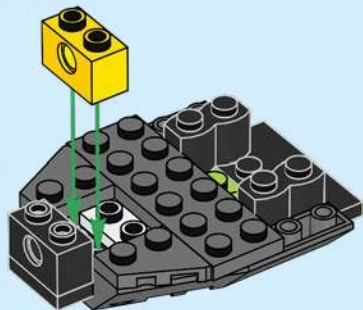

2x

# 23

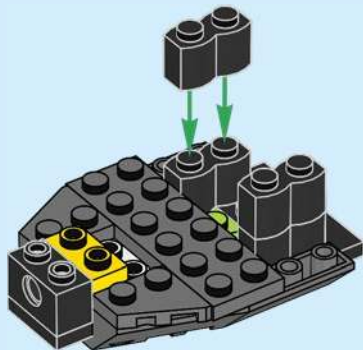

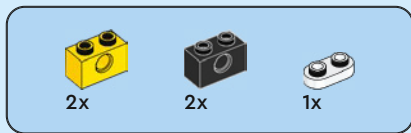

24

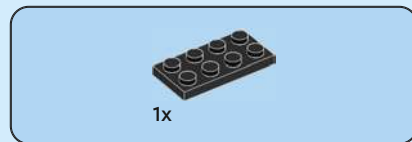
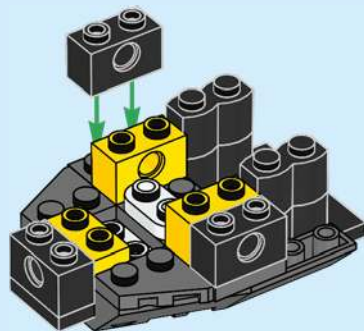

25

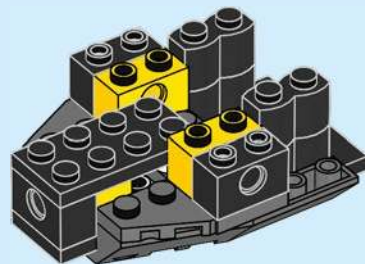



2x

26

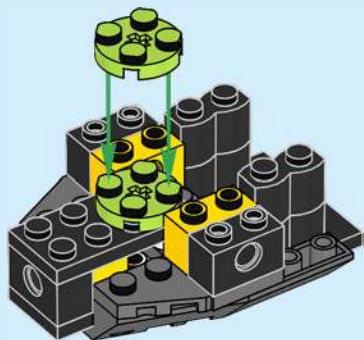

2x

27

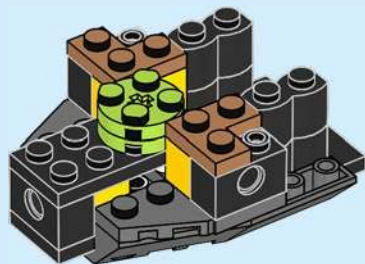



28

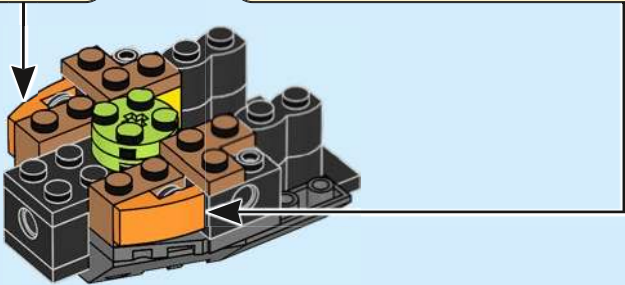
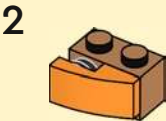
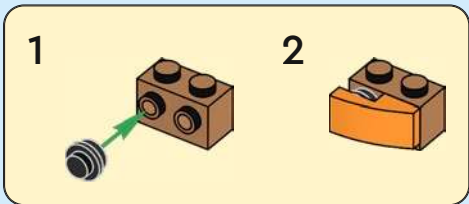



4x



2x

# 29

1

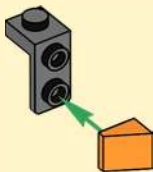

2



1



2

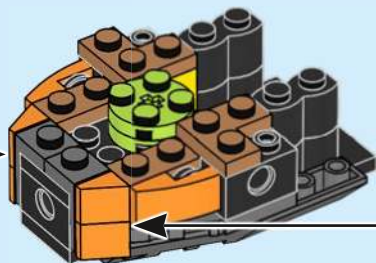



2x

30

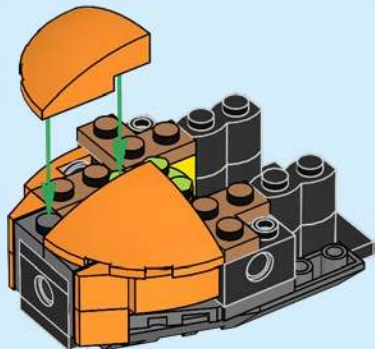

31

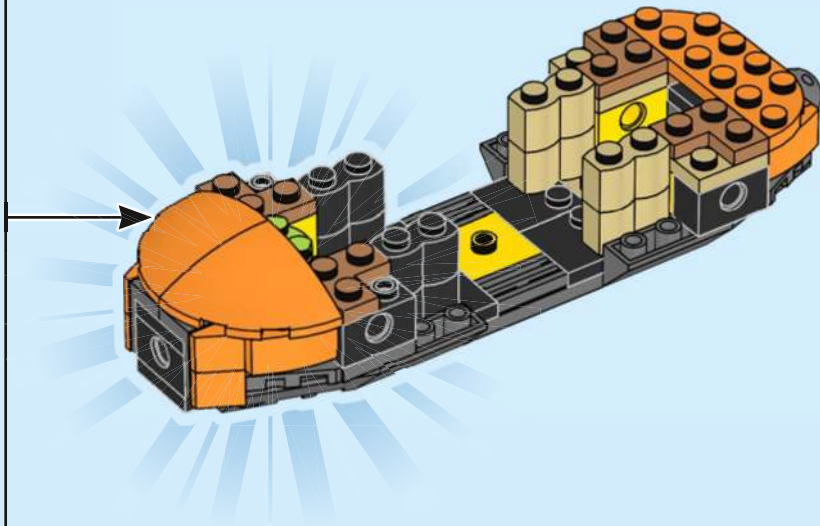



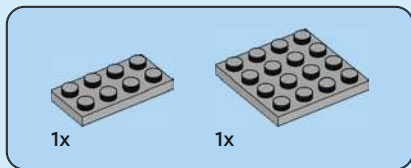

32

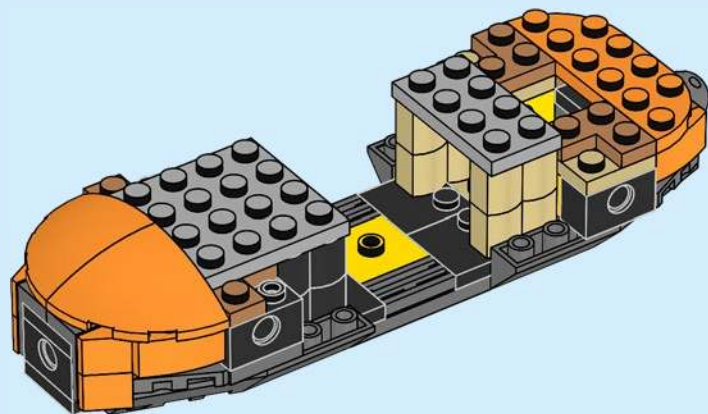



2x



1x



1x

33

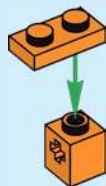

1x

34



35

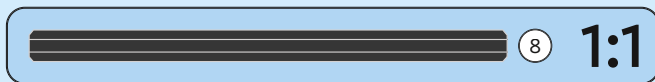
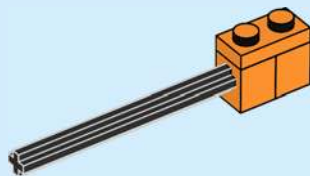

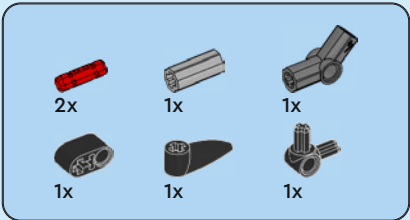

# 36

1

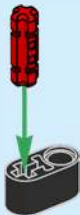

2



3

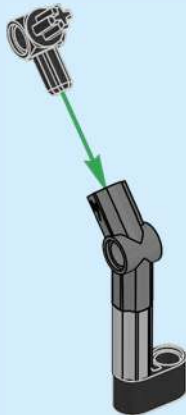

4

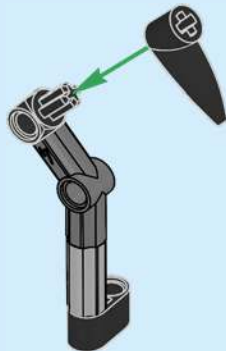



1x

37

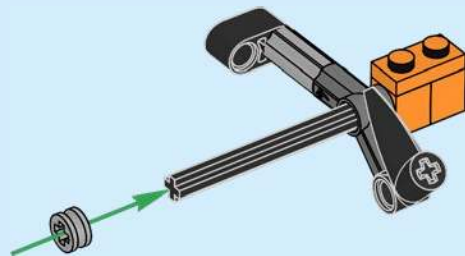

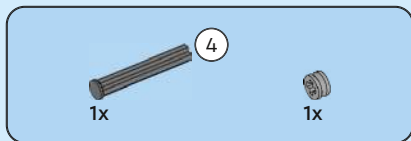

38

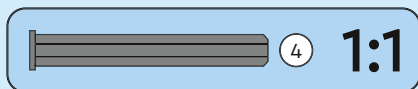
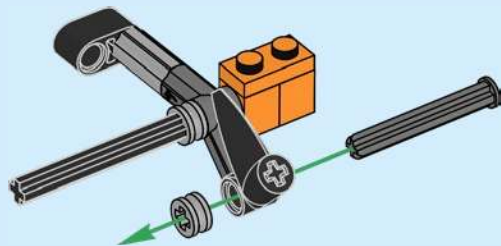

39

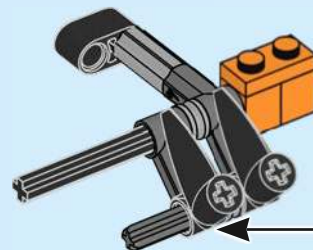
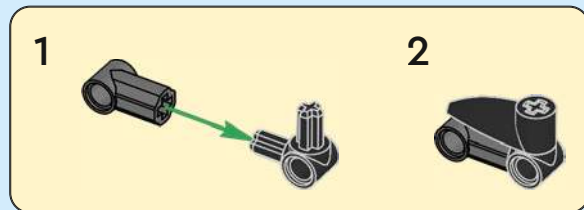



2x

40



2x

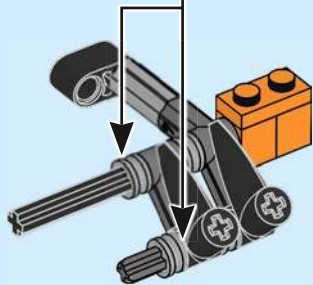

1x



1x



1x

41

1

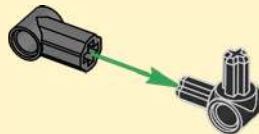

2

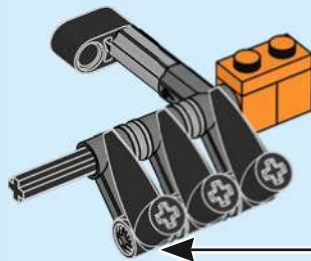



2x

42

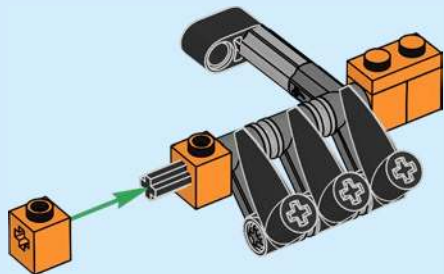

1x

43



2x

44

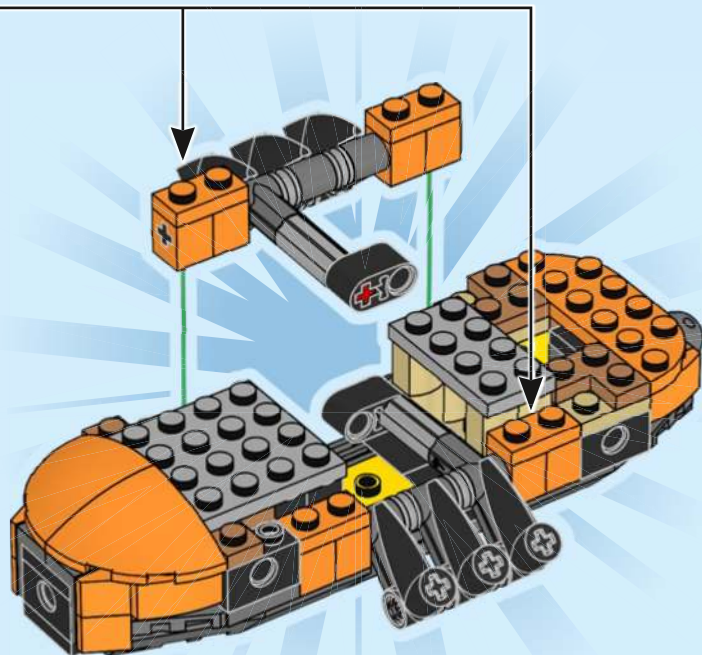

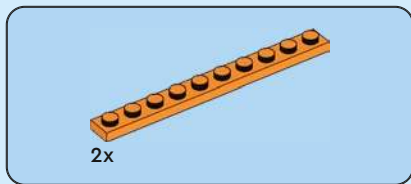

45

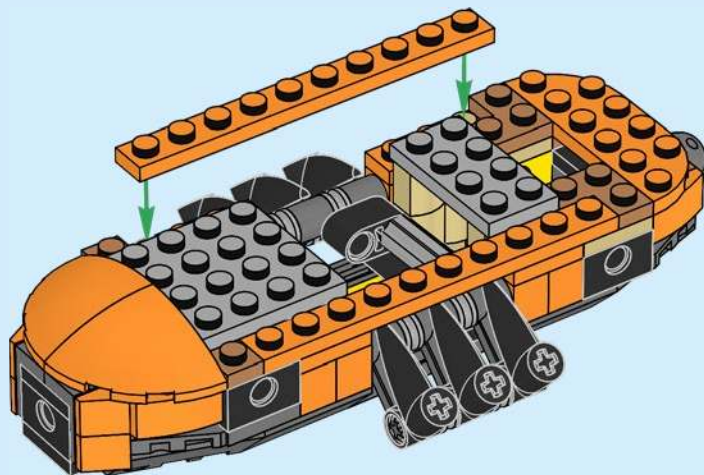



2x



1x

# 46

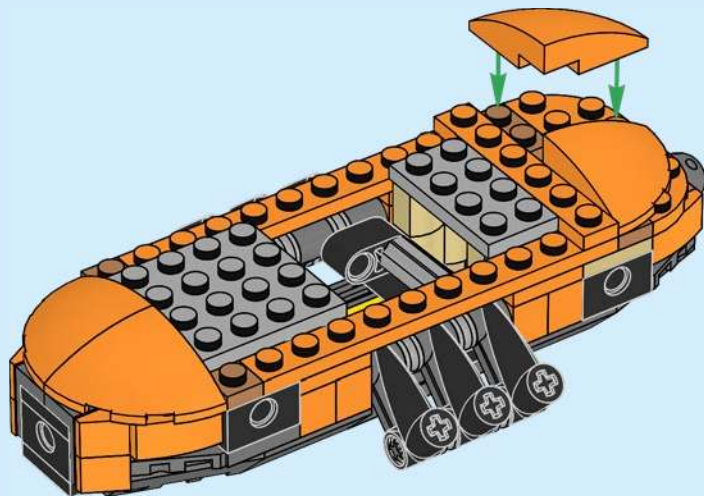

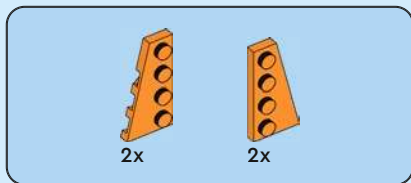

47

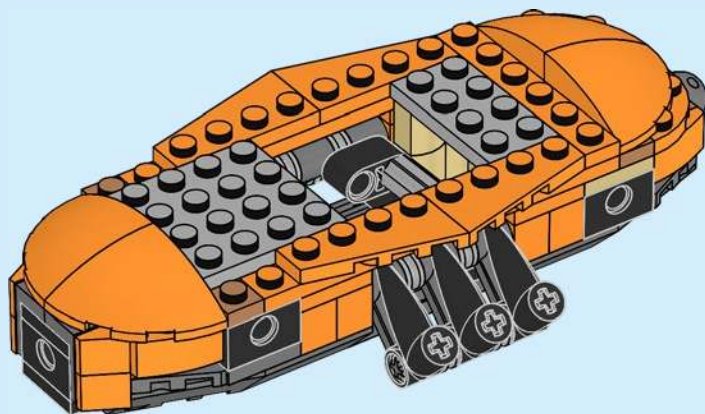



1x



1x

48

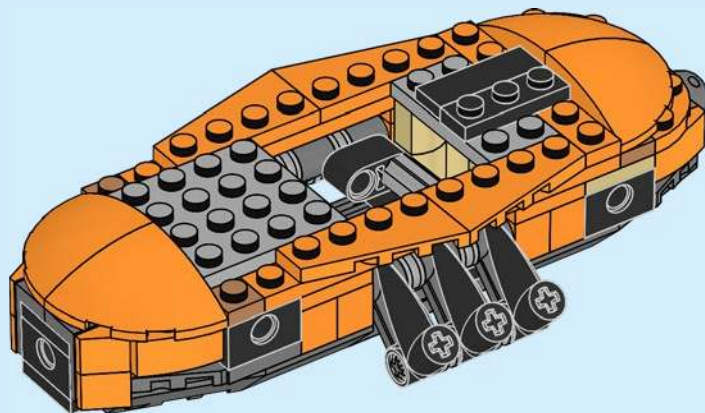



4x

49

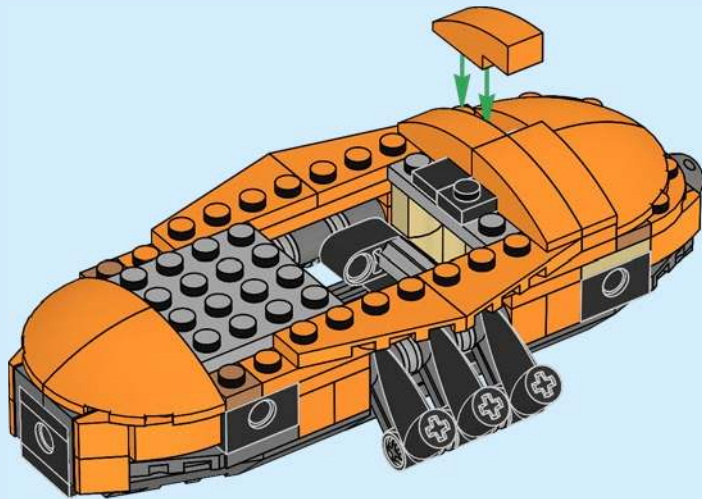



3x



4x

# 50

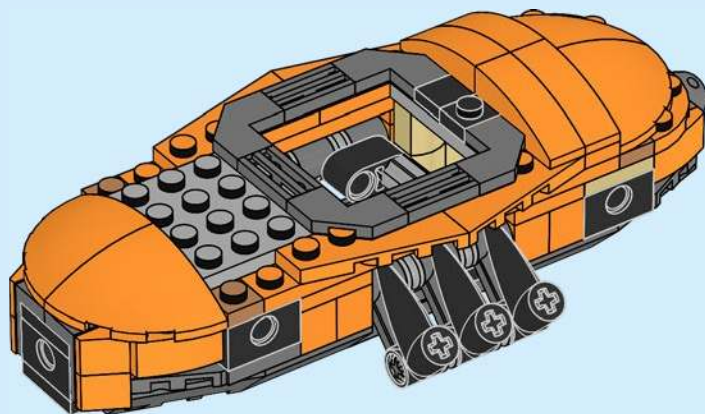



1x



2x

51

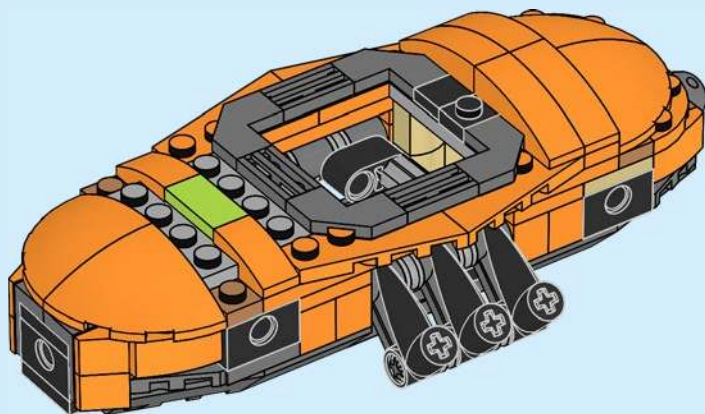



52

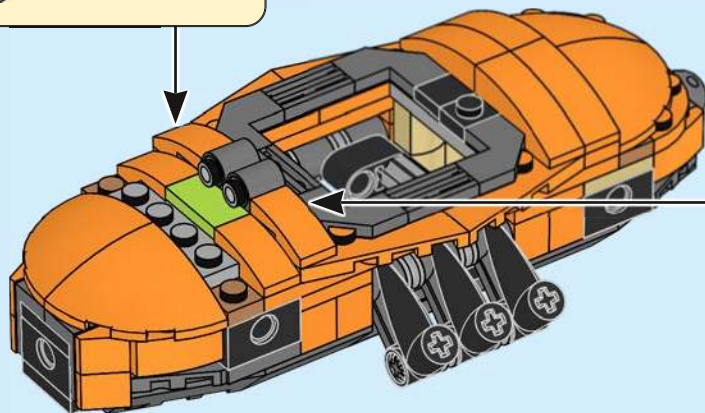
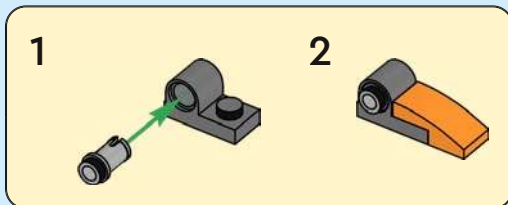
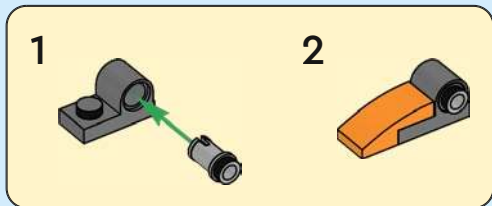



2x

53

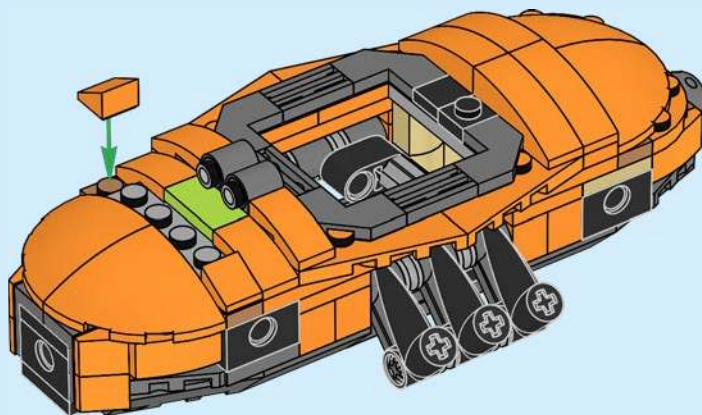



2x

54

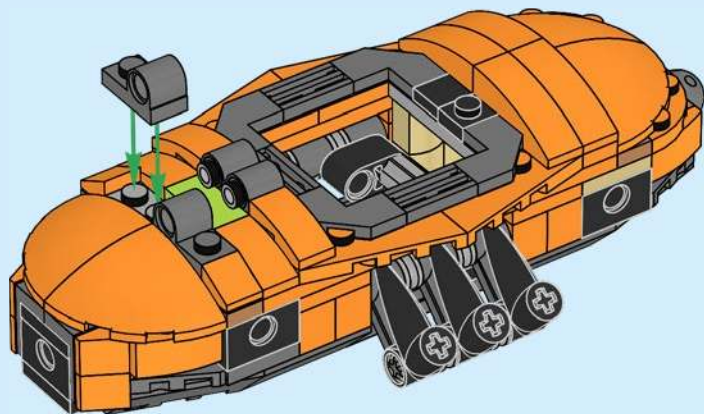



2x

55

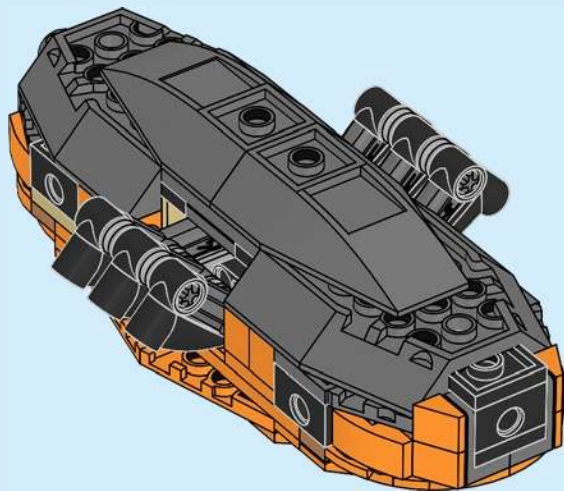



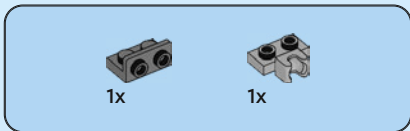
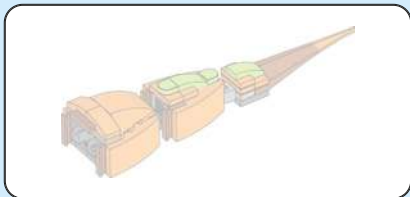

56

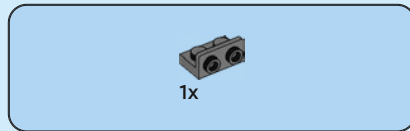
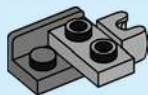

57

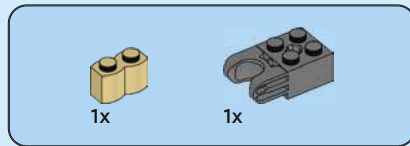

58





2x

59



2x

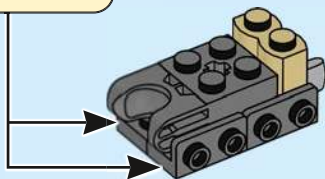

2x

60

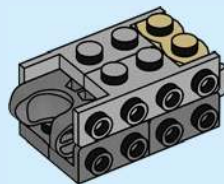

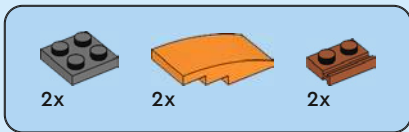

61

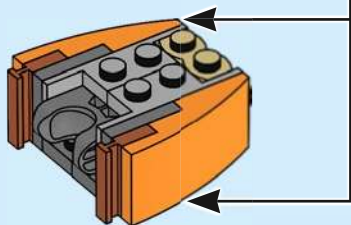
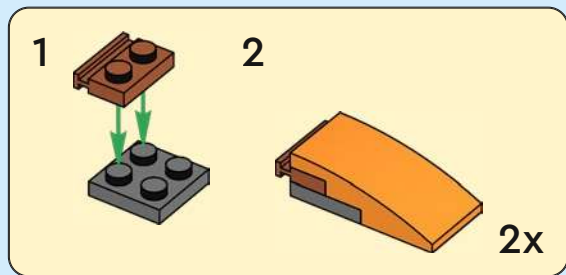

62



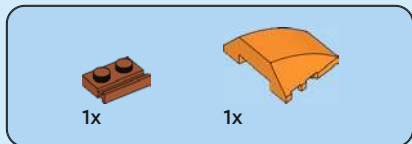

63

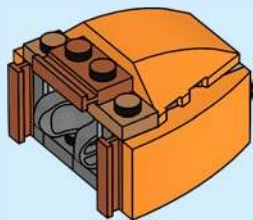

64

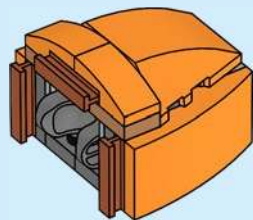

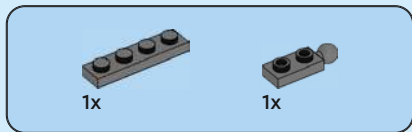

65

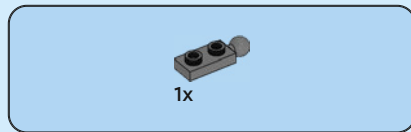
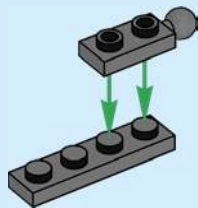

66

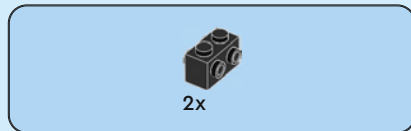

67

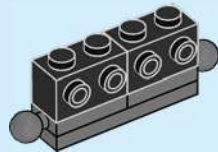

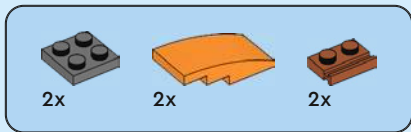

68

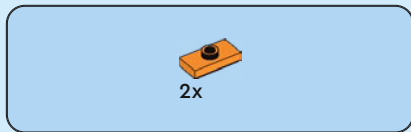
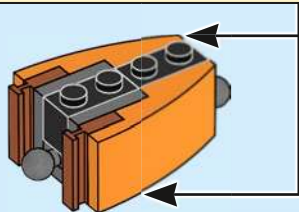
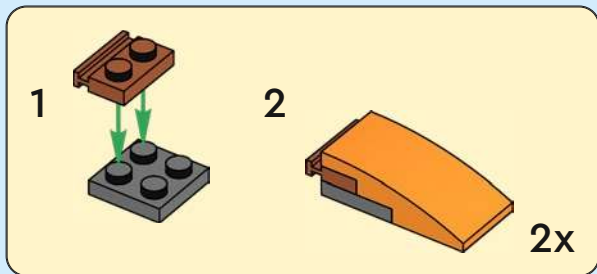

69





1x



2x

70

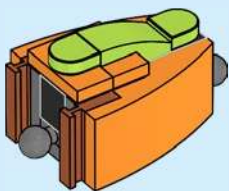

71

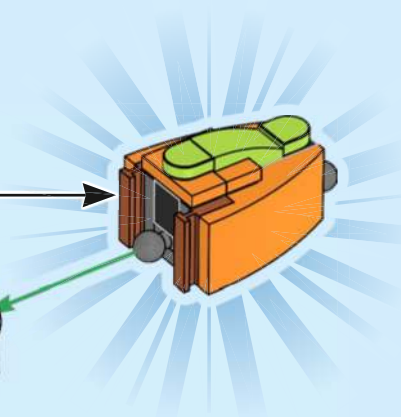
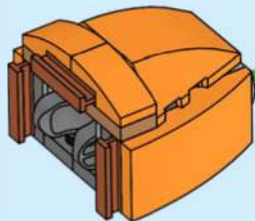

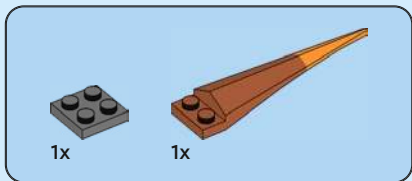
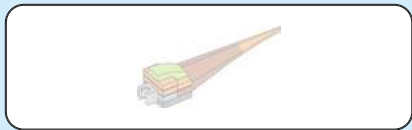

72

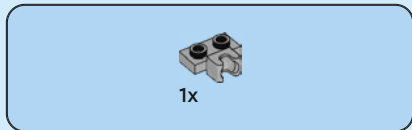
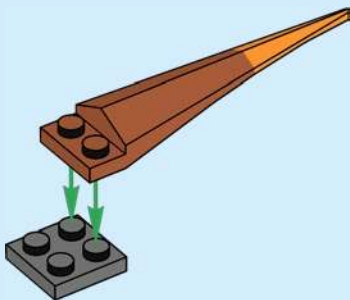

73

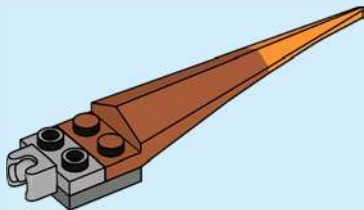



2x

74

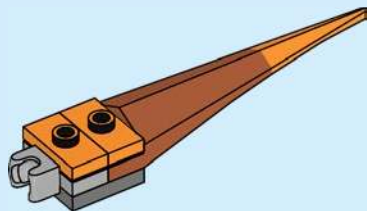

1x

75

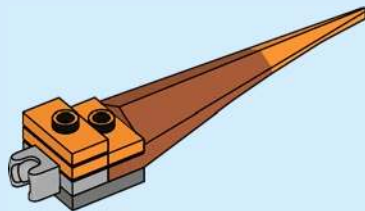



1x

76

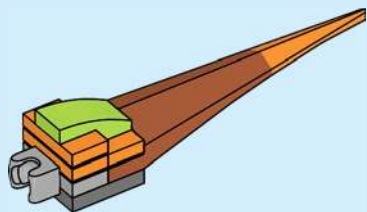

77

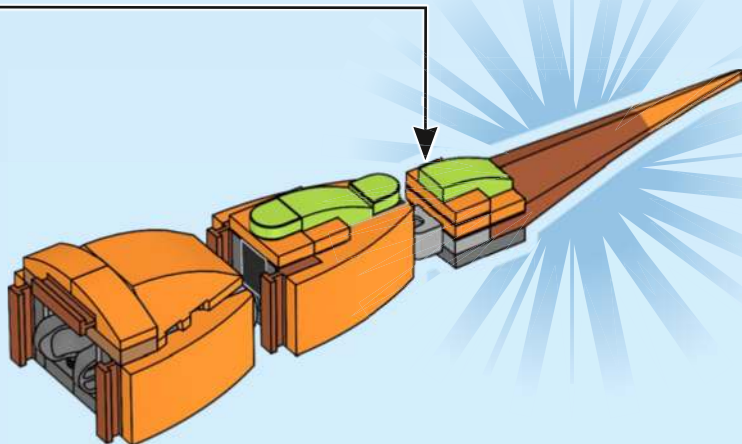

78

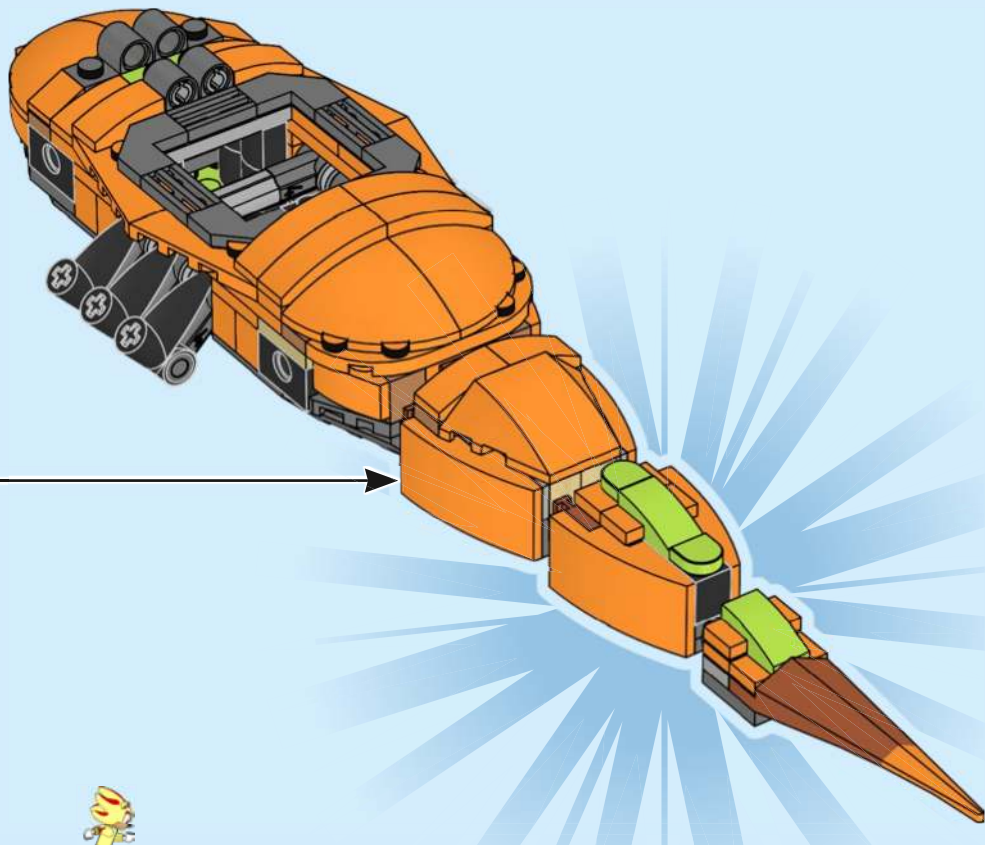



2x



2x



2x

5



2x



2x



2x

79

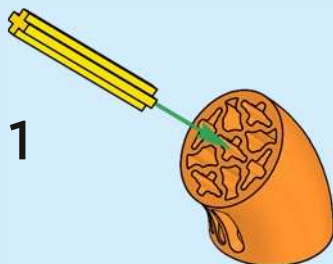

5

1:1

3

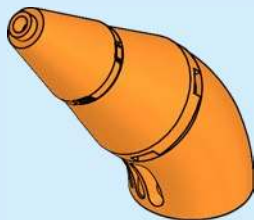

4

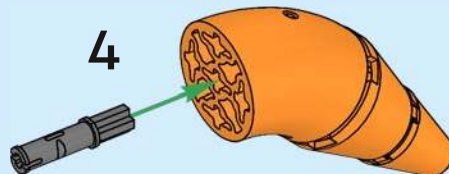

2x



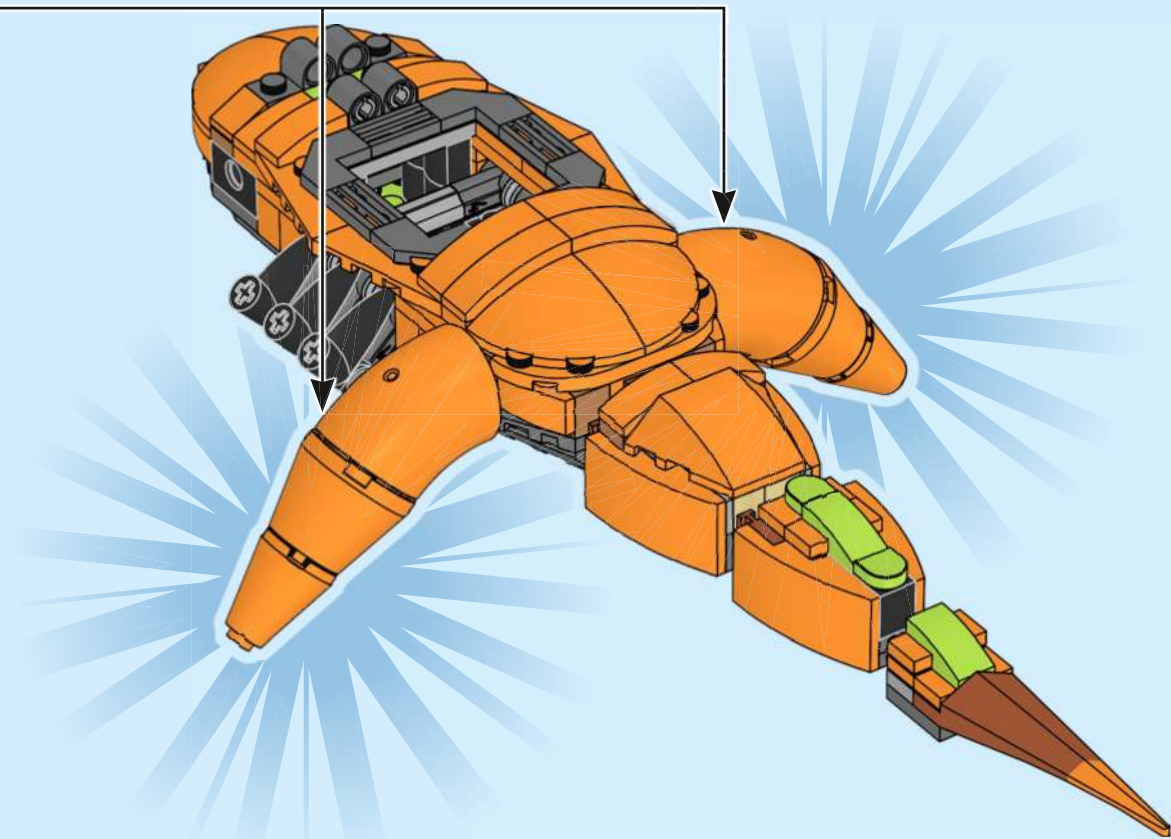



80

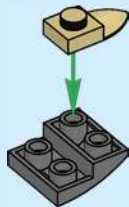

81





2x

82

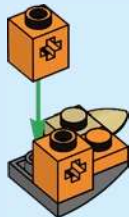

1x

83



1x



1x

84

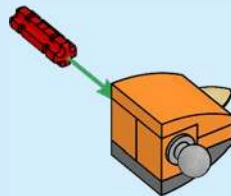



85

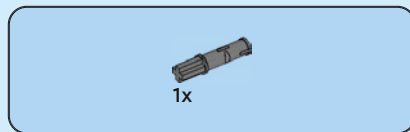
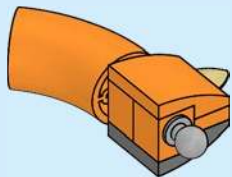

86

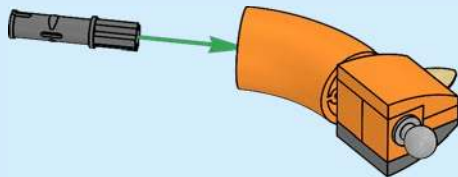



3x



1x



1x



2x



1x



2x



1x

# 87

1

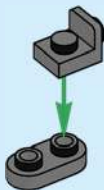

2



3

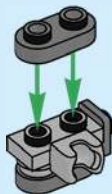

4

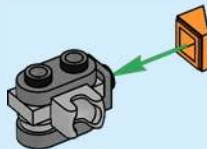

5



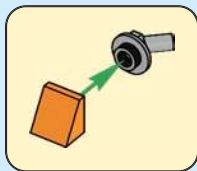

6

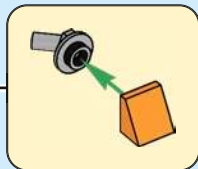
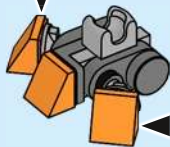

88

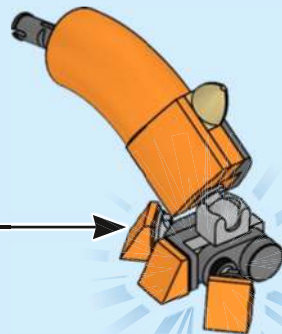

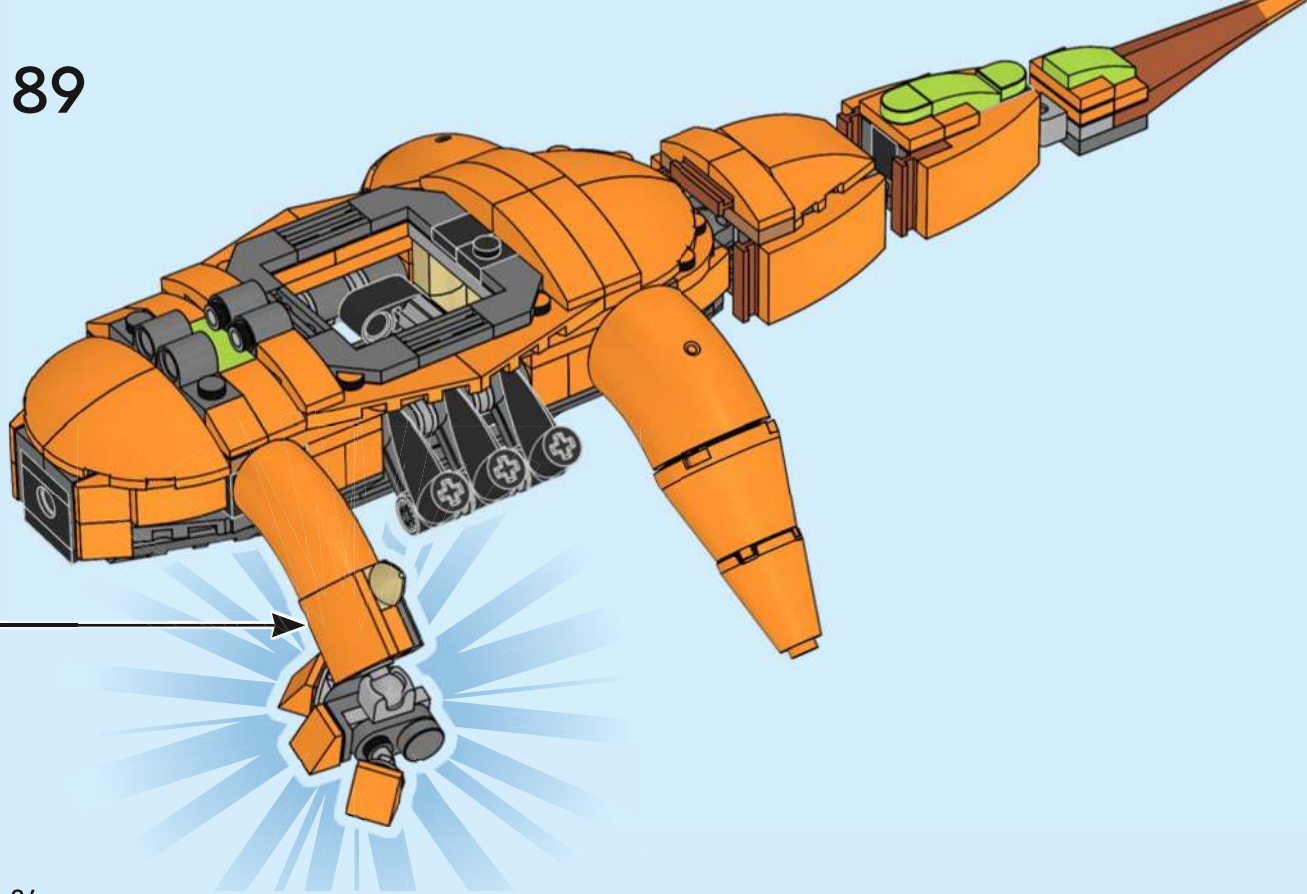

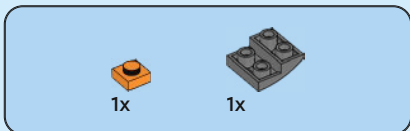

90

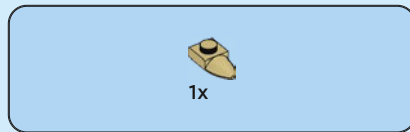
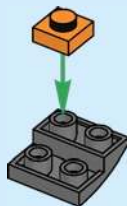

91





2x

92

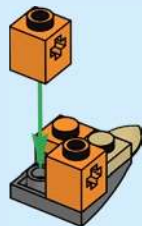

1x



1x

93

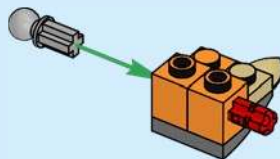

1x

94

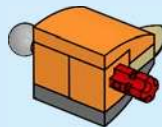



95

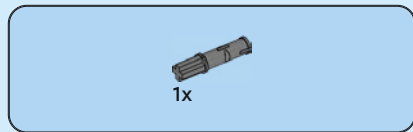
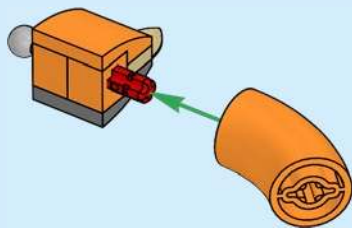

96

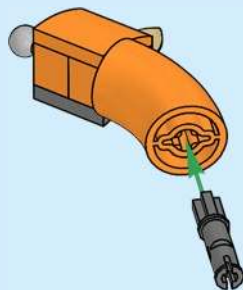



3x



1x



1x



2x



1x



2x



1x

# 97

1

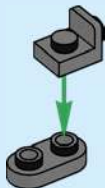

2



3

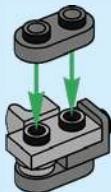

4

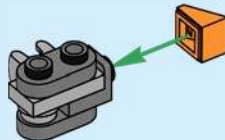

5

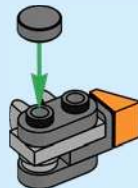

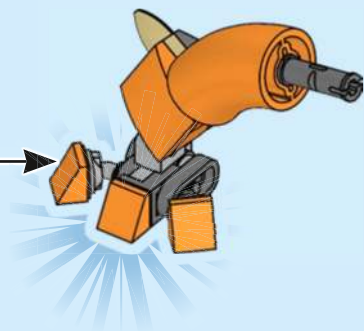
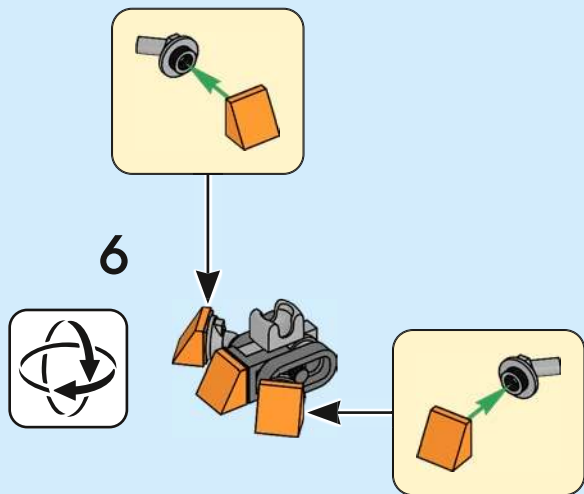

98

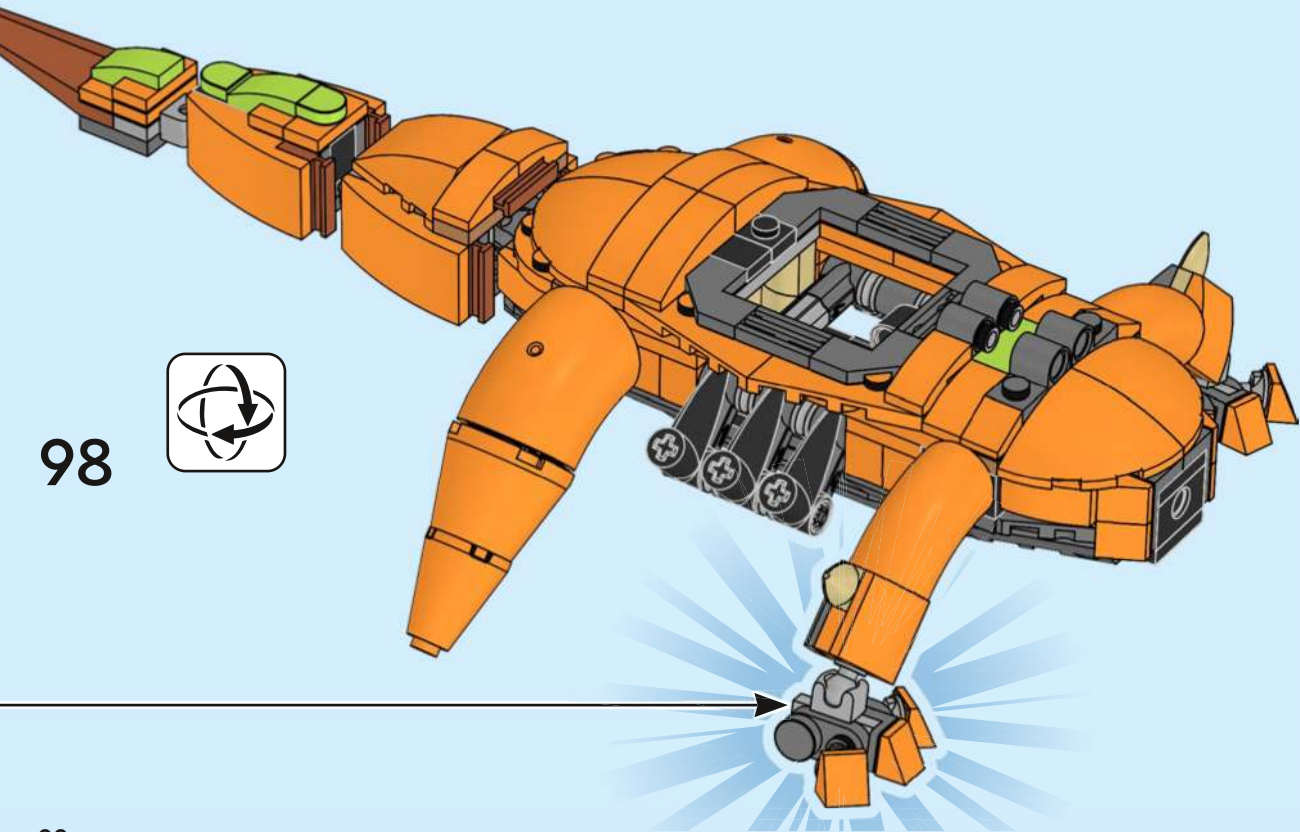

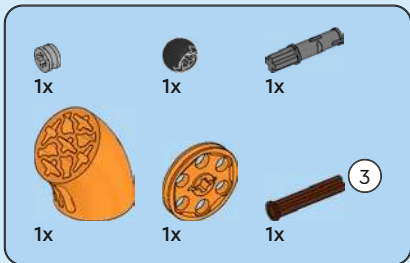
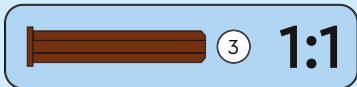

99

1

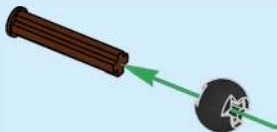

2



3



4

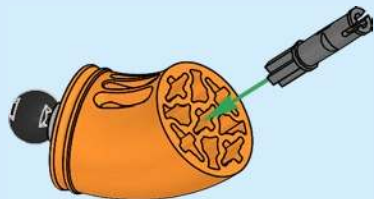

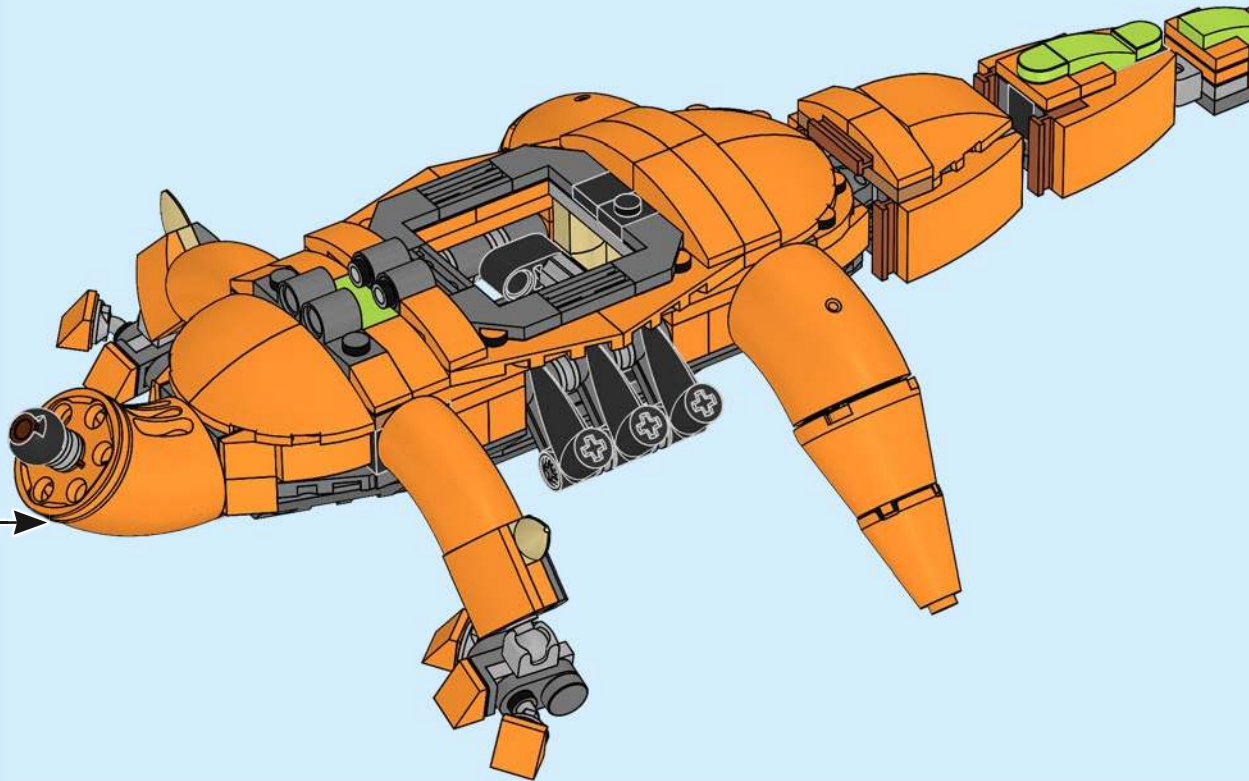



1

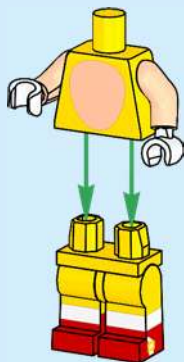

2



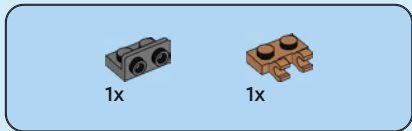

100

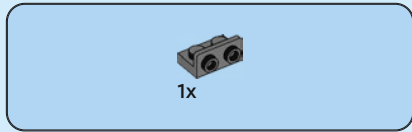

101





2x

102

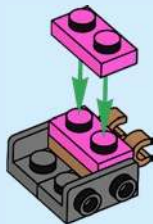

1x

103



2x

104

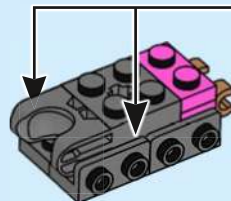

2x



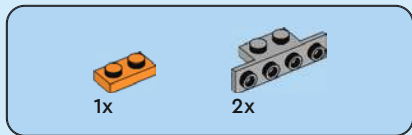

105

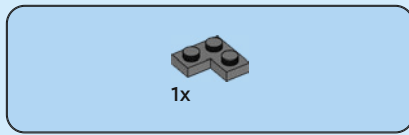
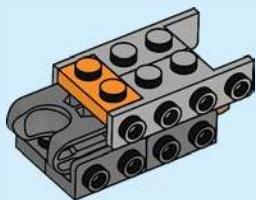

106

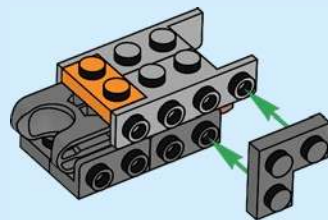

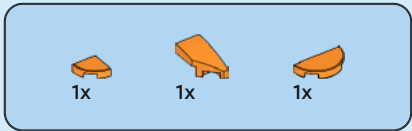

107

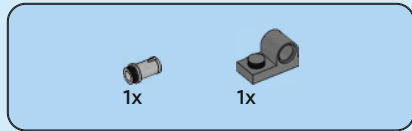
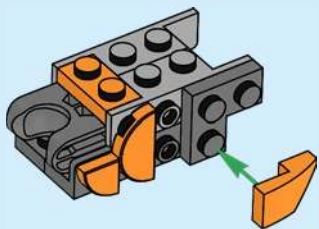

108

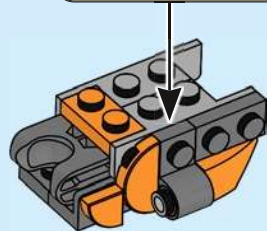
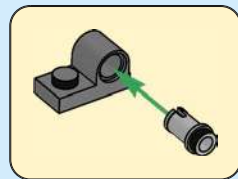



1x



1x

# 109

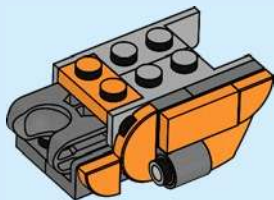

1x

# 110

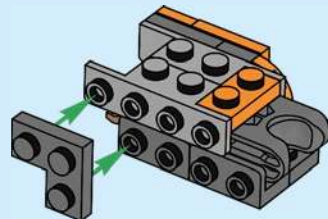



111

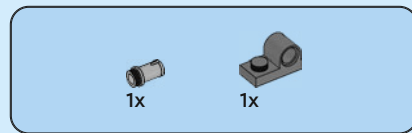
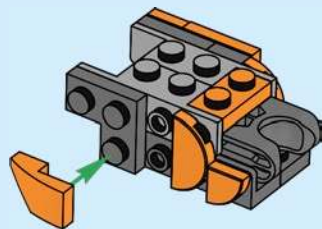

112

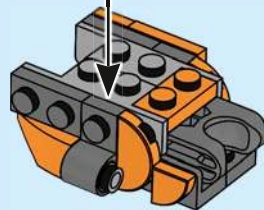



1x



1x

# 113

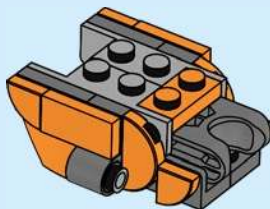

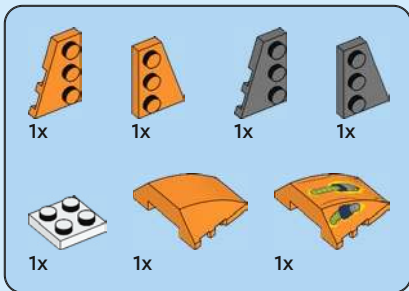

114

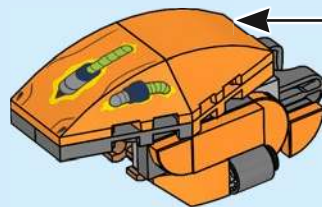
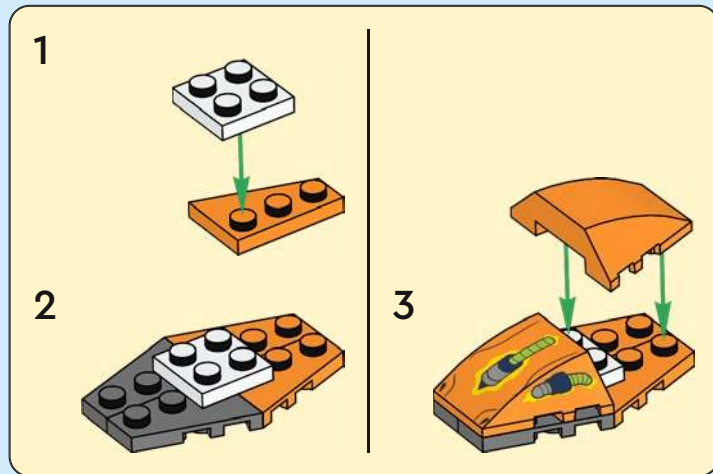

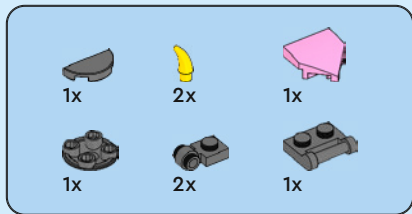

115

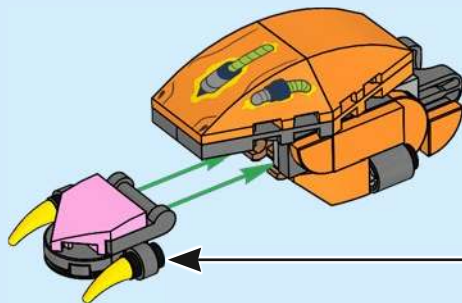

116

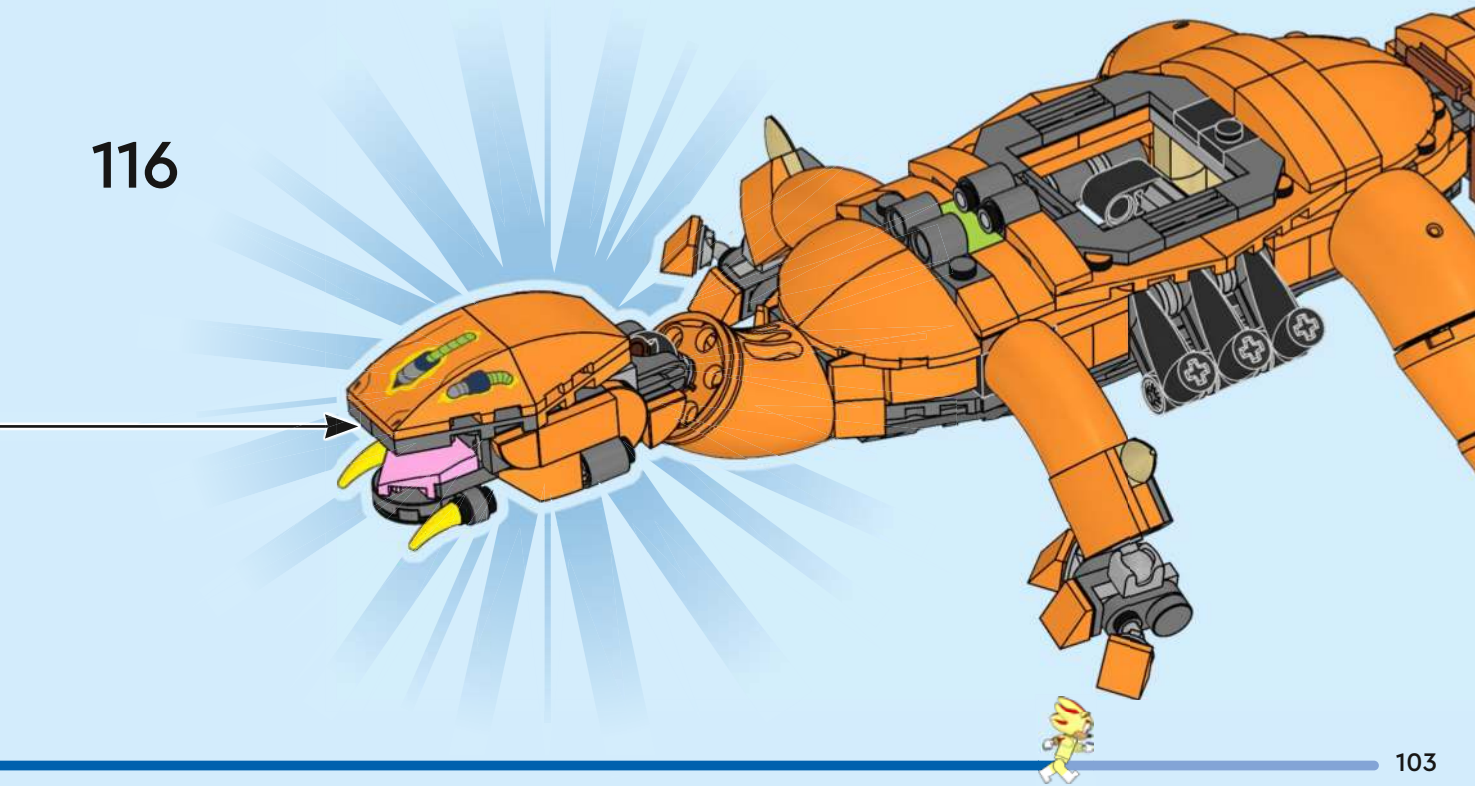

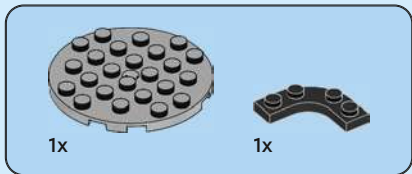

117

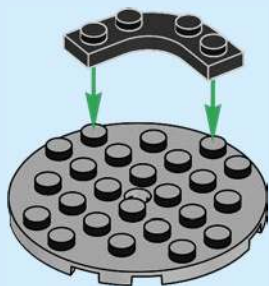

118

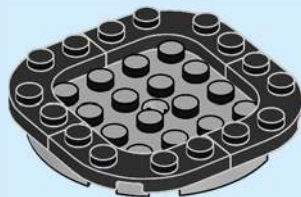



2x



1x

119



2x



4x

120

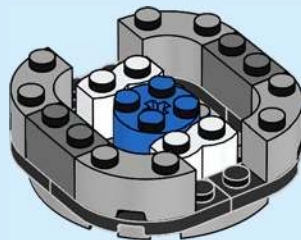

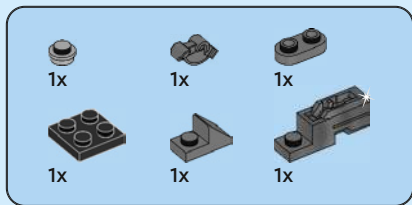

121

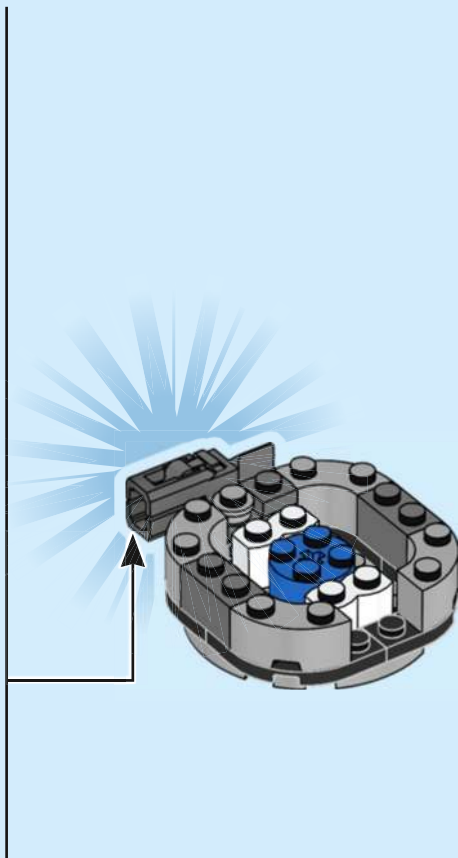
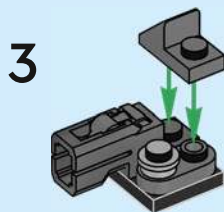
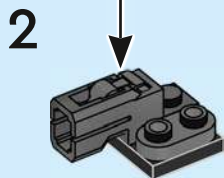
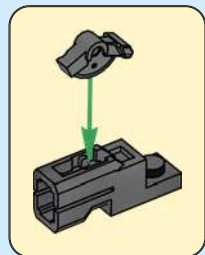

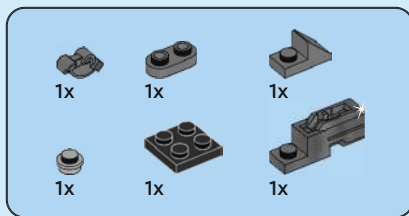

122

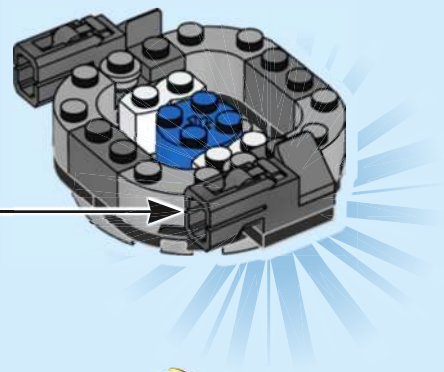
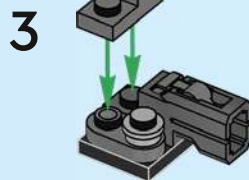
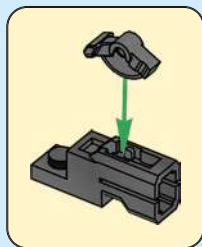
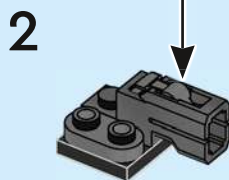
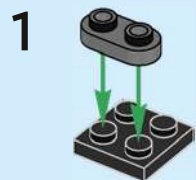



4x

# 123

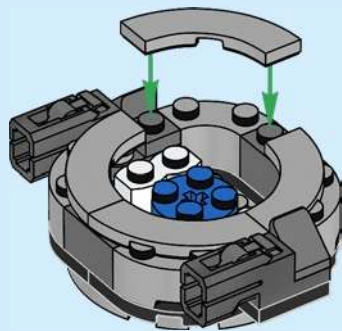

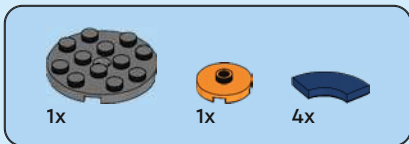

124

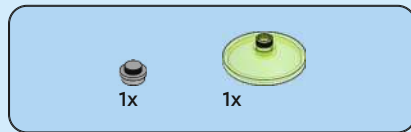
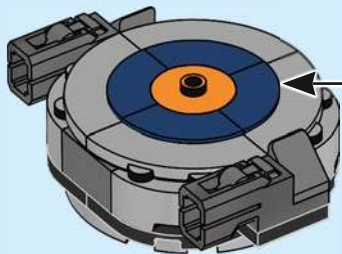
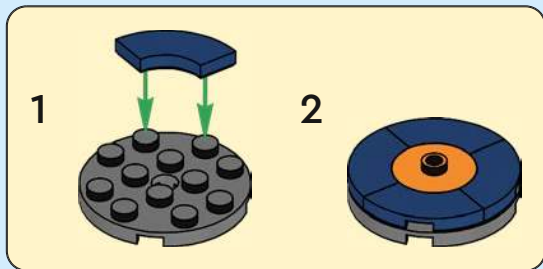

125

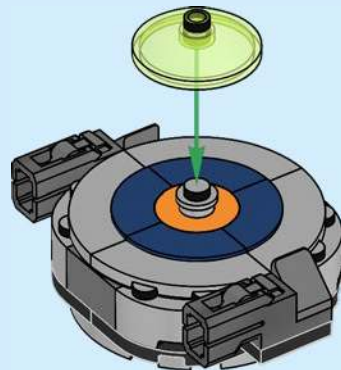

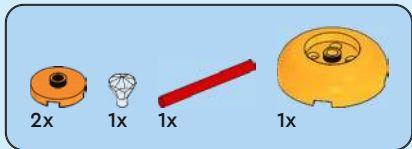

126

1

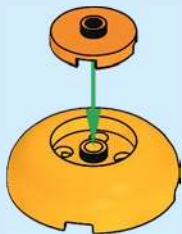

2

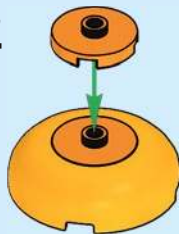

3

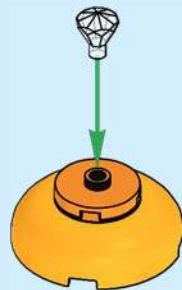

4

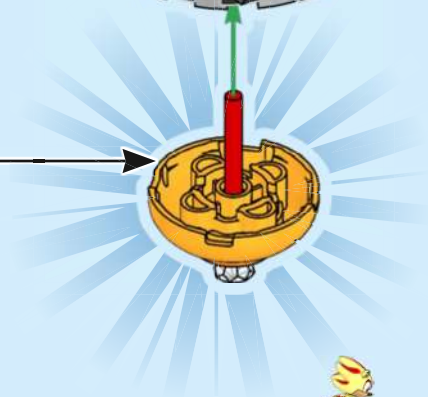
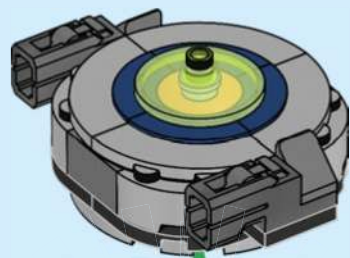
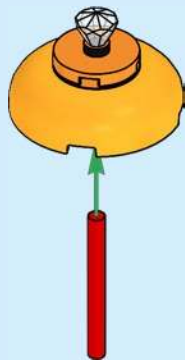

127

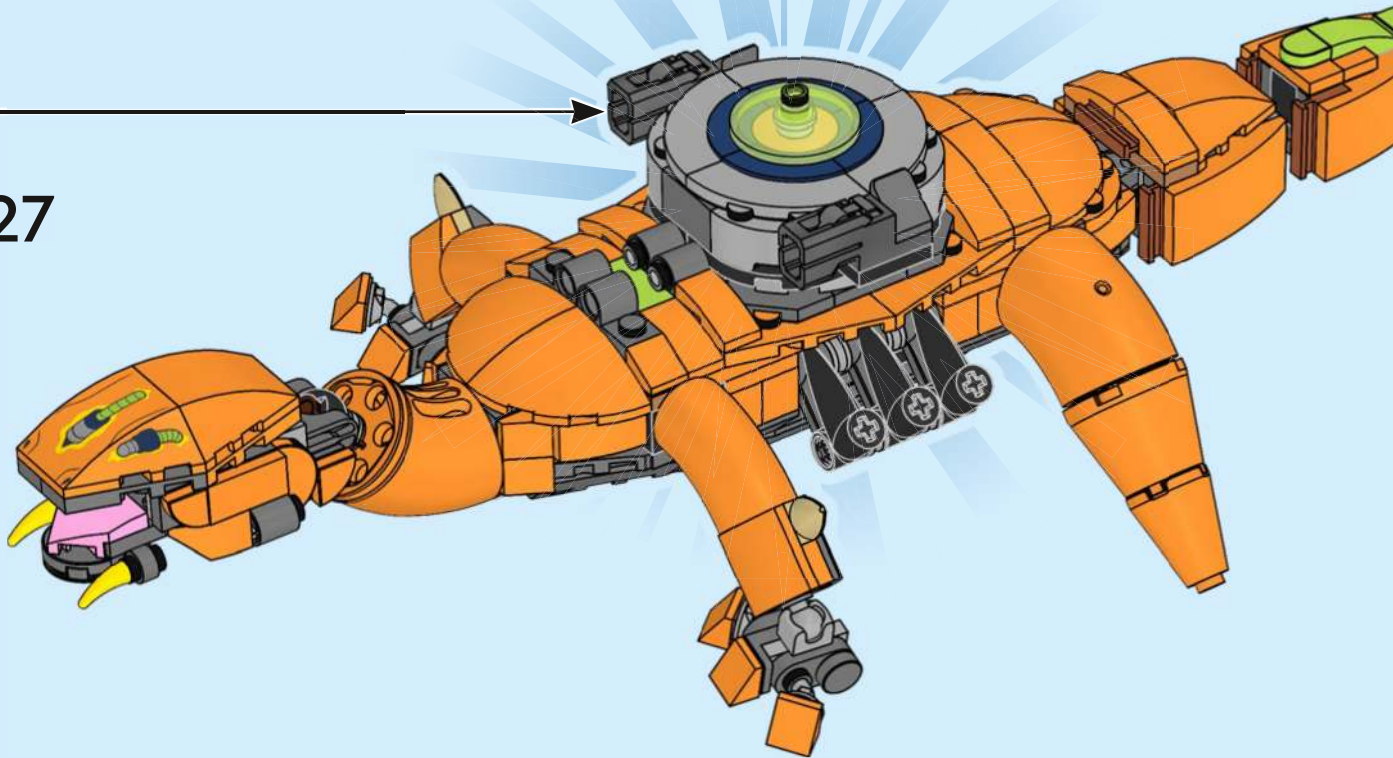

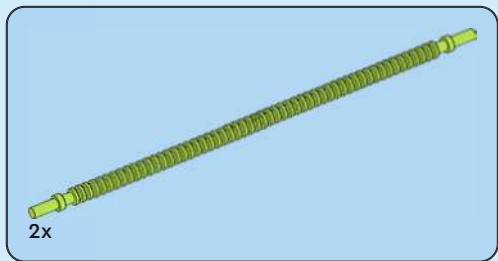

128

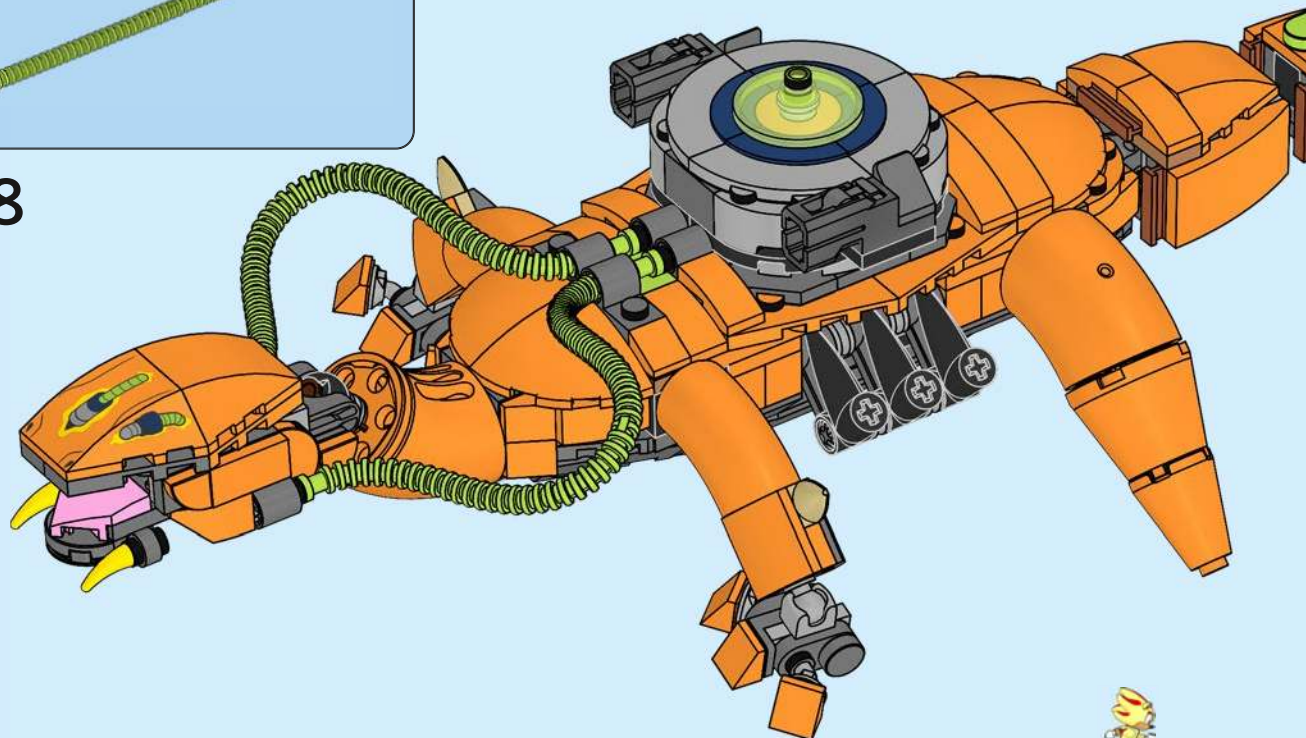



4x



129

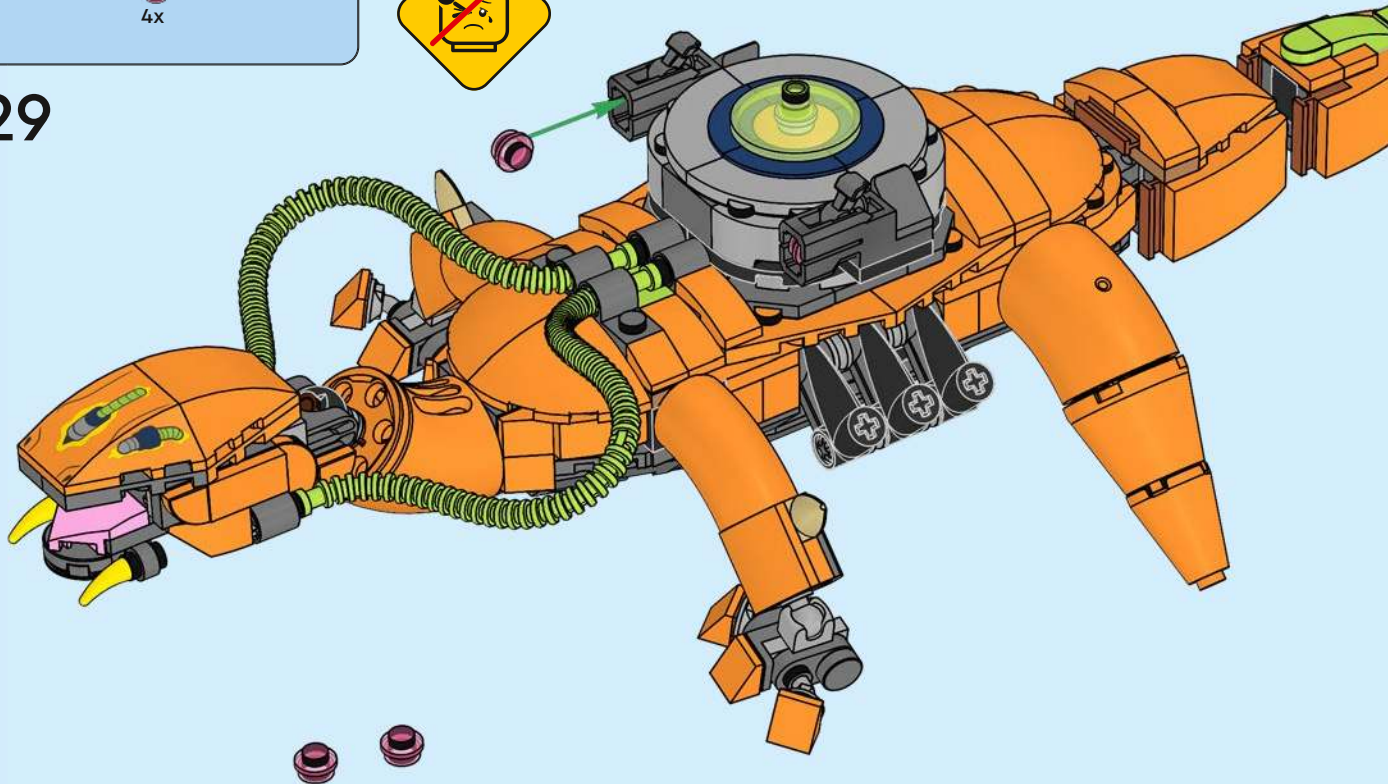

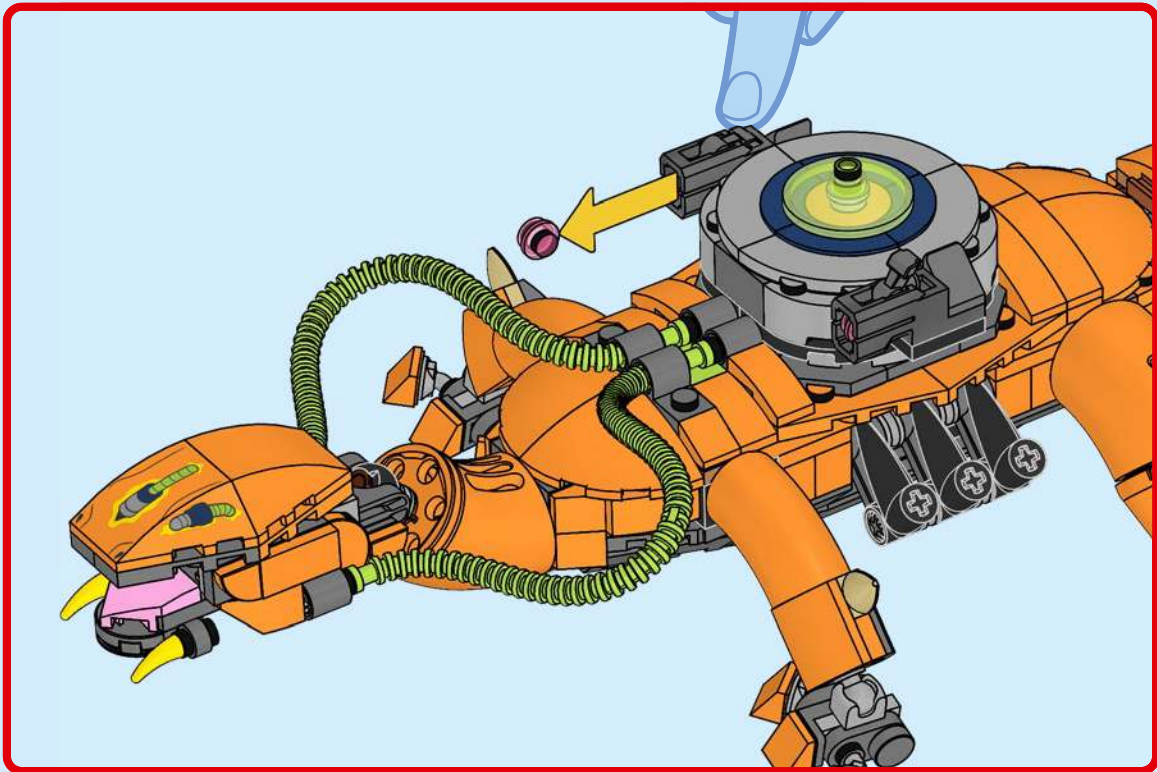

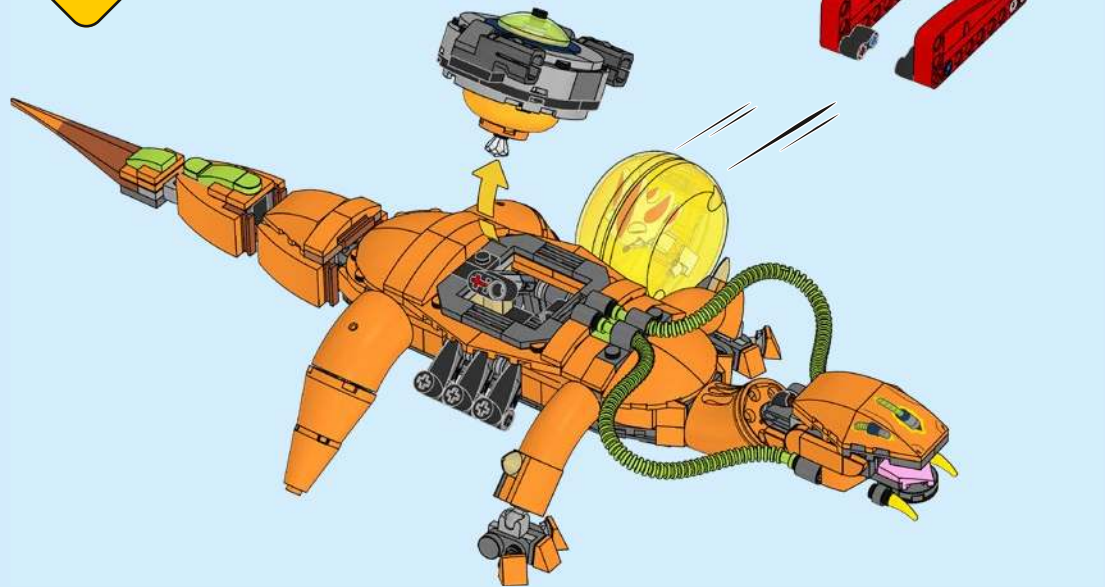





# SONIC™

THE HEDGEHOG





©SEGA. All rights reserved. SEGA is registered in the U.S. Patent and Trademark Office. SEGA and SONIC THE HEDGEHOG are either registered trademarks or trademarks of SEGA CORPORATION.

## EXPLORE MORE

Mehr entdecken  
En savoir plus  
Esplora di più  
Explora más  
Explorar mais  
了解更多  
Zobacz więcej  
Objev vice  
Objav viac  
Tudj meg többet!  
Descoperă mai multe  
Разглядайте още  
Izpeti vairāk  
Uuri lähemalt  
Atraskite daugiau





**Rebuild  
the  
World™**





2x  
6059185



2x  
6001831



2x  
6276981



2x  
6345327



1x  
302201



1x  
6195371



1x  
6210272



2x  
4494474



1x  
6173116



5x  
4218749



3x  
4114084



1x  
4113233



2x  
4224793



4x  
6530412



1x  
6296954



4x  
6360104



8x  
4142865



1x  
614323



2x  
6390388



8x  
4206482



5x  
370024



1x  
6126050



1x  
6479474



1x  
6493454



1x  
6515445



2x  
6270110

11



2x  
6130008



1x  
6530425



4x  
4644456



2x  
4253815



5x  
370026



2x  
6265091



1x  
4286267



2x  
302226



5x  
6192346

5



1x  
4558170



1x  
362326



2x  
302026



4x  
614126



4x  
6325190



6x  
6288220



17x  
6279875



6x  
6099801



4x  
4198367



2x  
370726

8



5x  
6228839



1x  
6247798



2x  
302026



4x  
614126



4x  
6325190



6x  
6288220



17x  
6279875



6x  
6099801



4x  
4198367



2x  
302226

5x  
6192346



1x  
6177499



1x  
6177490



2x  
4524929



5x  
6092599



10x  
6055069



2x  
6067913



4x  
4251969



4x  
6054529



1x  
6529766



2x  
6329309

12x  
4504371



4x  
6514060



1x  
6437703



2x  
6069006



1x  
4500125



1x  
4537936



2x  
6250601



3x  
6314224



2x  
6534733

122



6x  
4177932



2x  
4188771



2x  
6433114



2x  
6433119



4x  
6173925



2x  
6510077



1x  
4173332



2x  
6337519



1x  
4180540



1x  
4180512



3x  
6109909



1x  
6301806



1x  
6533559



3x  
6495090



2x  
6473699



1x  
6517938



4x  
4567448



1x  
4211395



1x  
4243797



4x  
6168615



4x  
6385740



1x  
6015349



4x  
6043656



5x  
4211525



4x  
6510189



9x  
6271165



4x  
4211483



2x  
6443149



2x  
4512360



1x  
6135494

3



4x  
6199898



1x  
6524506



2x  
4211088



1x  
4497253



2x  
6338291



2x  
6069164

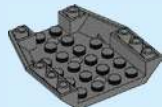

2x  
6210720



2x  
6344820



5x  
4211094



2x  
4210635



4x  
6177079



1x  
4211001



1x  
4243831



1x  
4211002

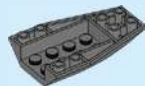

2x  
4636417



2x  
6284596



2x  
6225494



2x  
6281996



6x  
6019987



8x  
6000606



1x  
6146321



2x  
6435043



2x  
6143423



2x  
6143417



1x  
6510078



6x  
6221607



1x  
4278274



4x  
6296856



2x  
6360675



1x  
4210872



1x  
4210869



1x  
4528323



2x  
6123814



2x  
6262899



5x  
4210631



9x  
6015356



3x  
6083620



1x  
6529759



1x  
6533021



1x  
6529758



2x  
6057387



2x  
6345952



1x  
6475349



4x  
6411587



6x  
6177535



1x  
6347306

4



LEGO.com/service

YOU COULD  
**WIN**

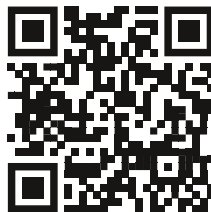

Scan this QR code or go to  
**LEGO.COM/PRODUCTFEEDBACK** and give  
us your short feedback about this LEGO® set  
for a chance to win a cool LEGO prize.

Terms and Conditions apply\*



**EN: YOU COULD WIN.** Terms and Conditions apply\* **DE: Du könntest GEWINNEN.** Es gelten die Teilnahmebedingungen\* **FR: Tu pourrais GAGNER.** Des conditions s'appliquent\* **IT: Potresti VINCERE tu.** Termini e condizioni sono applicabili\* **ES: Puedes GANAR.** Aplican términos y condiciones\* **PT: Poderá GANHAR.** Aplicam-se termos e condições\* **ZH: 轻松获奖. 条款和条件适用\*** **PL: Szansa na WYGRANĄ.** Obowiązują warunki korzystania\* **CS: Máte šanci VYHRÁT.** Platí všeobecné smluvní podmínky\* **SK: Máte šancu VYHRAŤ.** Platia všeobecné zmluvné podmienky\* **HU: TE IS NYERHETSZ.** Felhasználási feltételek érvényesek\* **RO: Ai putea CÂȘTIGA.** Se aplică termenii și condițiile\* **BG: Можете да СПЕЧЕЛИТЕ.** Има определени правила и условия\* **LV: Tu vari LAIMĒT.** Ir spēkā noteikumi un nosacījumi.\* **ET: Sul on võimalus VÕITA.** Kehtivad tingimused\* **LT: Jūs galite LAIMĖTI.** Taikomos sąlygos\*

\*[LEGO.com/productfeedback-terms](https://www.lego.com/productfeedback-terms)

LEGO and the LEGO logo are trademarks of the LEGO Group. ©2025 The LEGO Group.

©SEGA. All rights reserved. SEGA is registered in the U.S. Patent and Trademark Office.

SEGA and SONIC THE HEDGEHOG are either registered trademarks or trademarks of SEGA CORPORATION.

6555867