



40746





[LEGO.com/sustainable-packaging](https://LEGO.com/sustainable-packaging)



**FR**  
**DONNEZ**  
OU  
**RECYCLEZ**

 OU  OU 

ASSOCIATION MAGASIN DÉCHÈTERIE

Adresses sur [quefairedemesdechets.fr](https://quefairedemesdechets.fr)

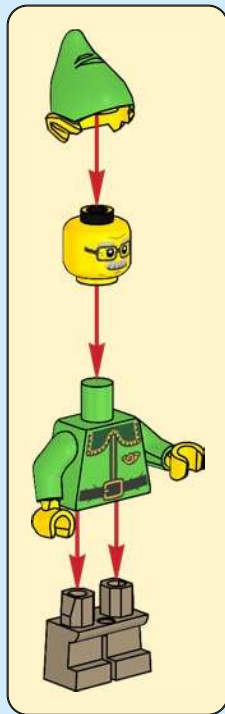
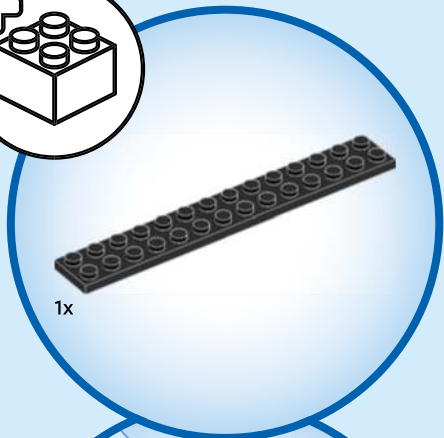
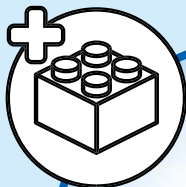

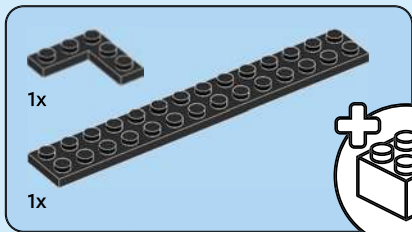

1

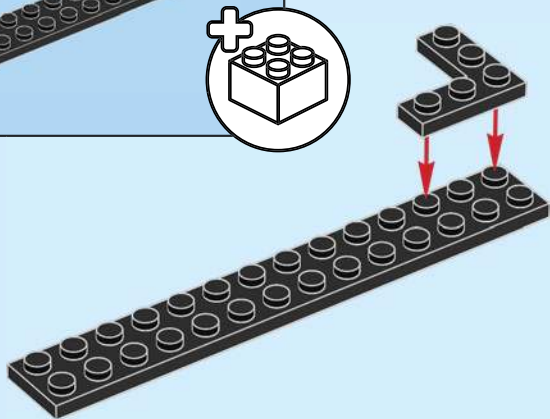

4



2

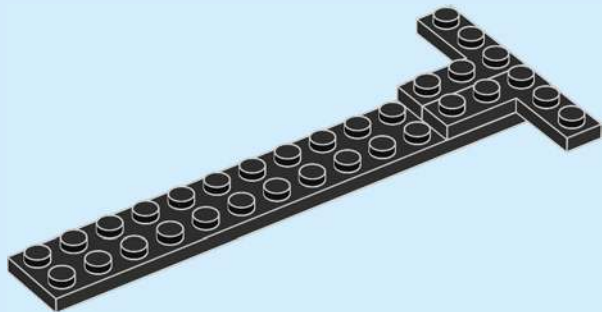

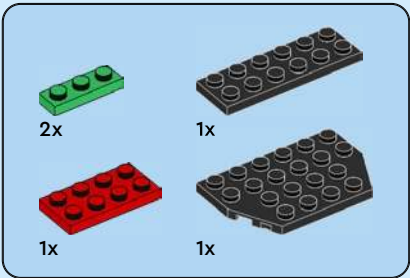

# 3

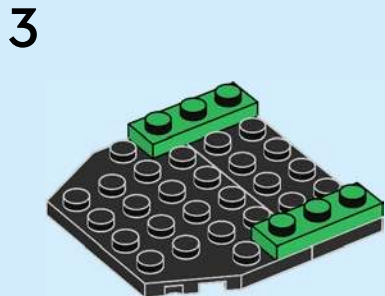
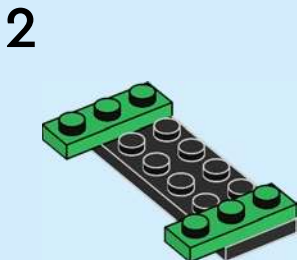
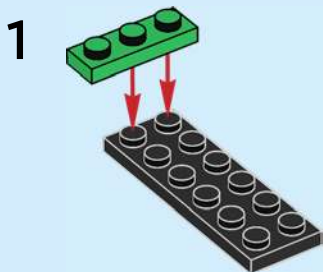

4

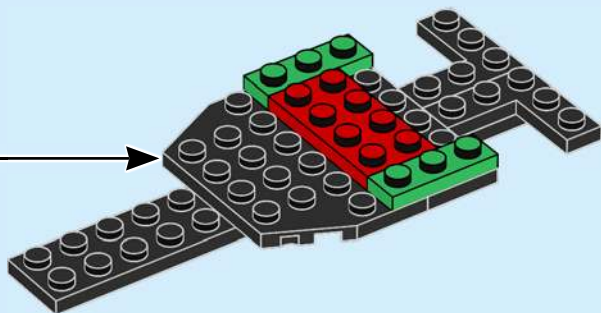
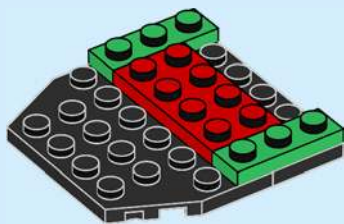



4

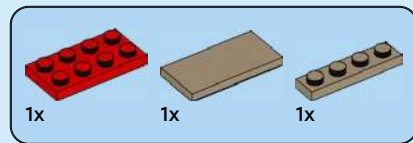
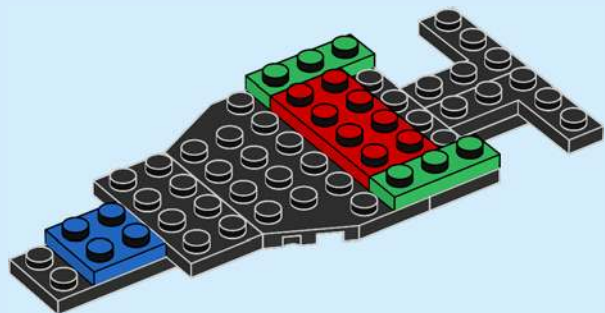

5

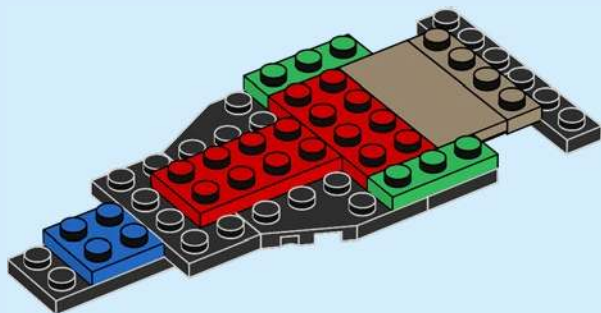

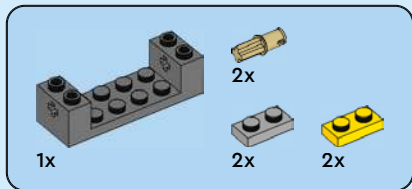

6

1

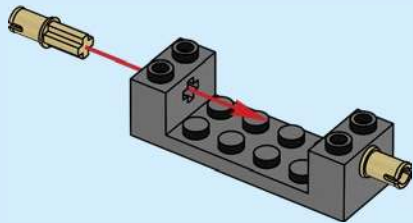

2

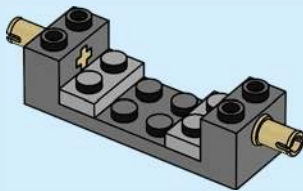

3

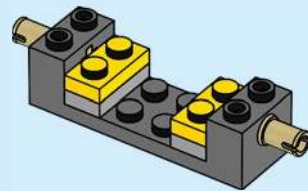

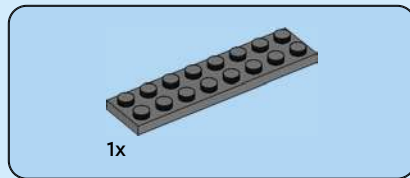
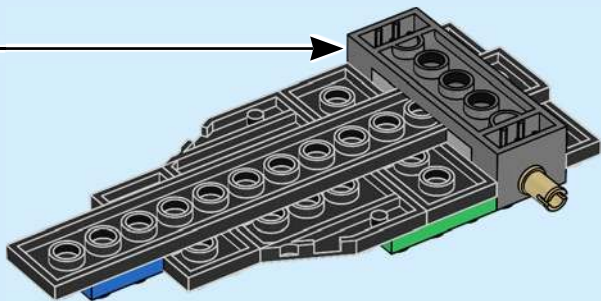

7

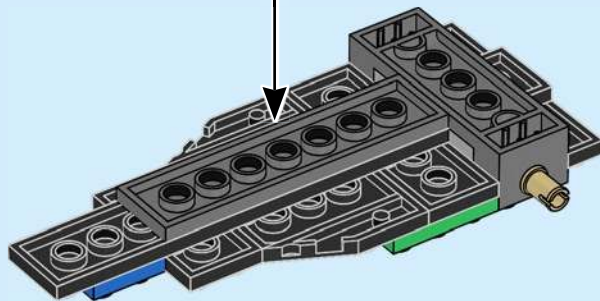
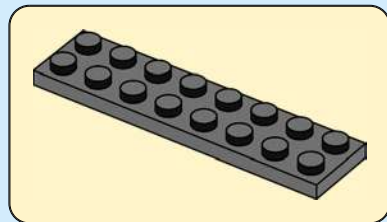

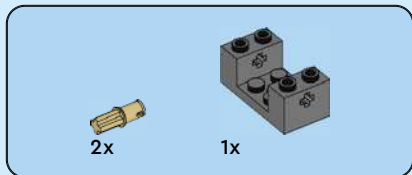

8

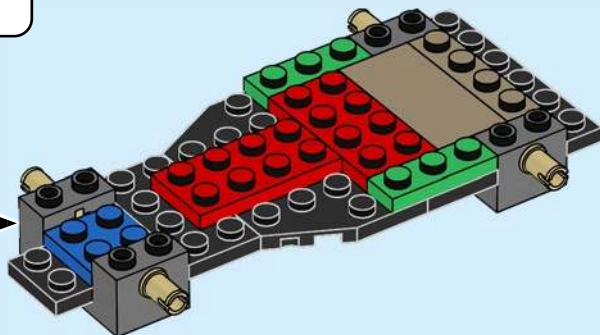
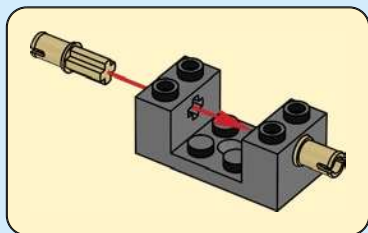

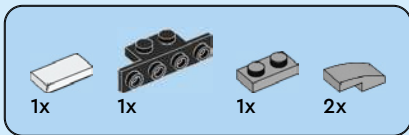

9

1

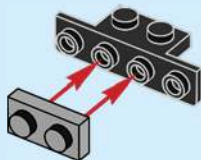

2

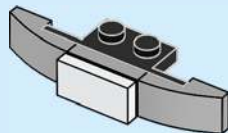

3

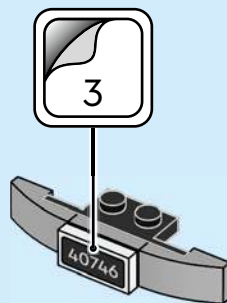

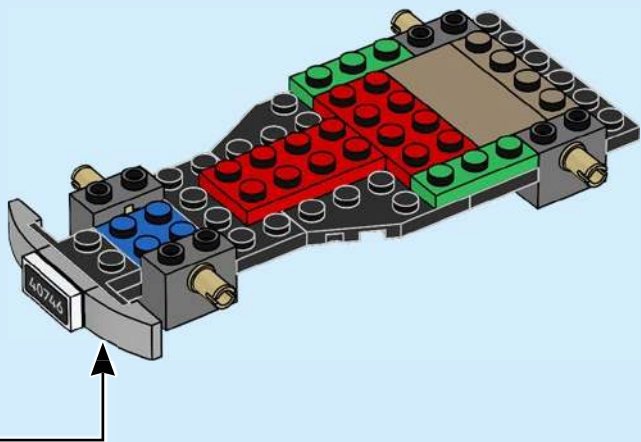

12

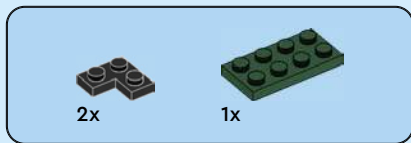

10

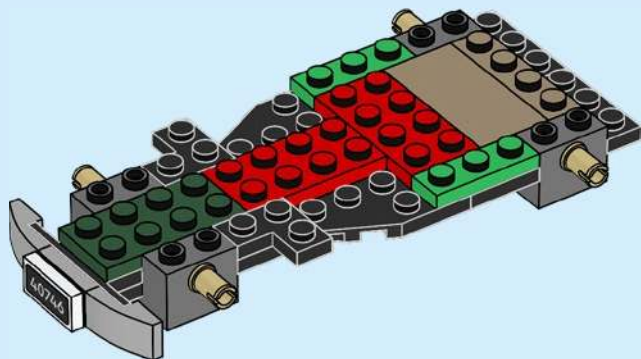

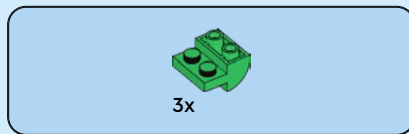

11

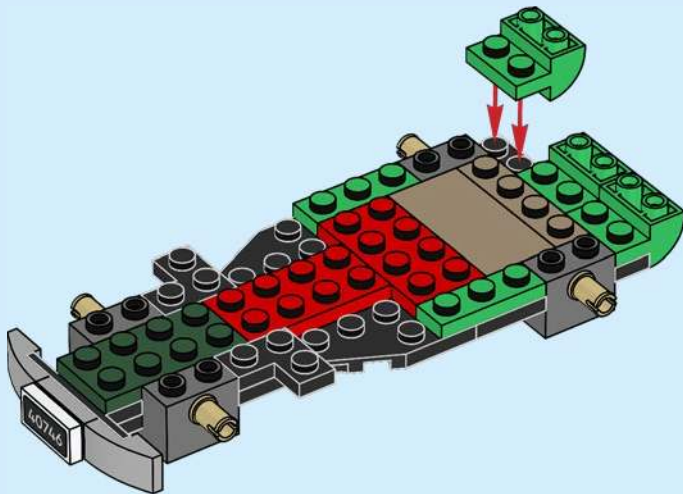



2x

12

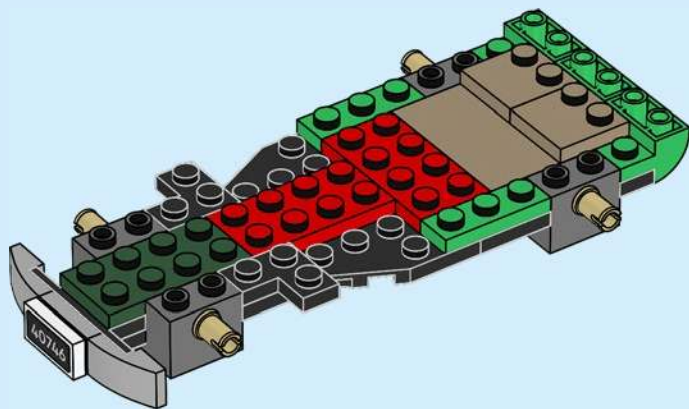



2x



1x



2x

# 13

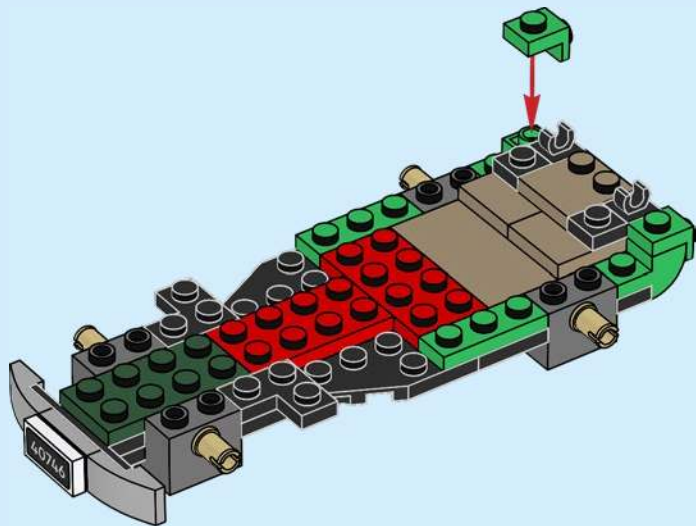





2x

15

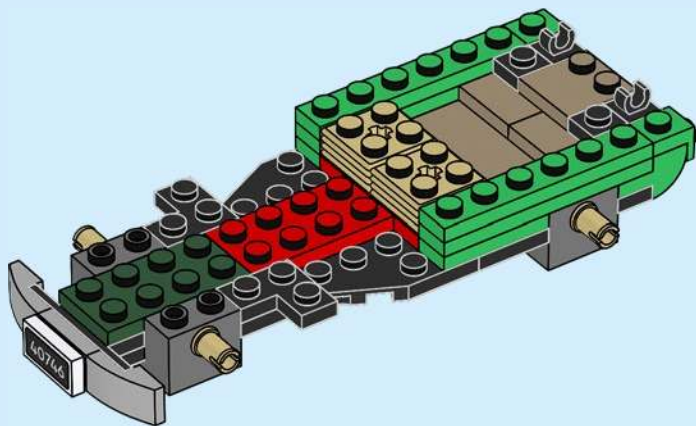

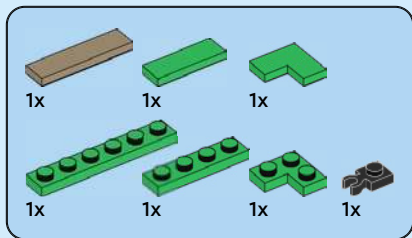

16

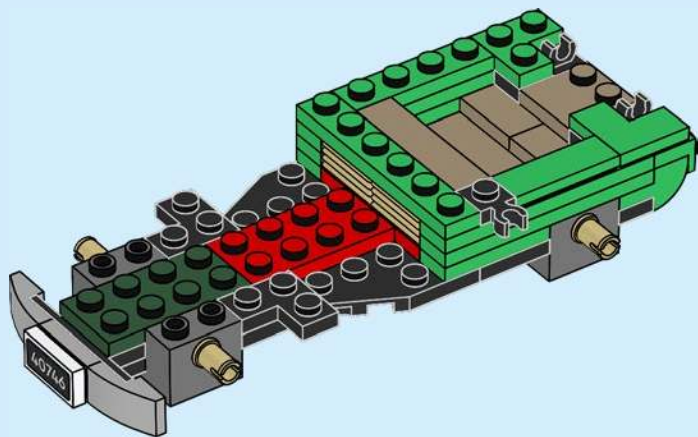

2x

17

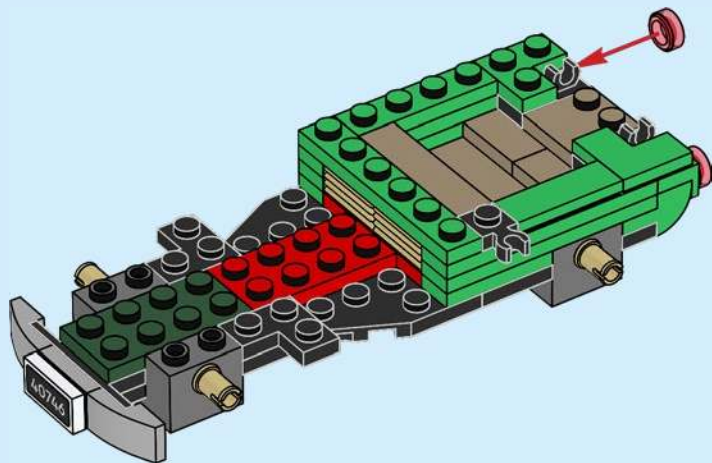





1x



2x

19

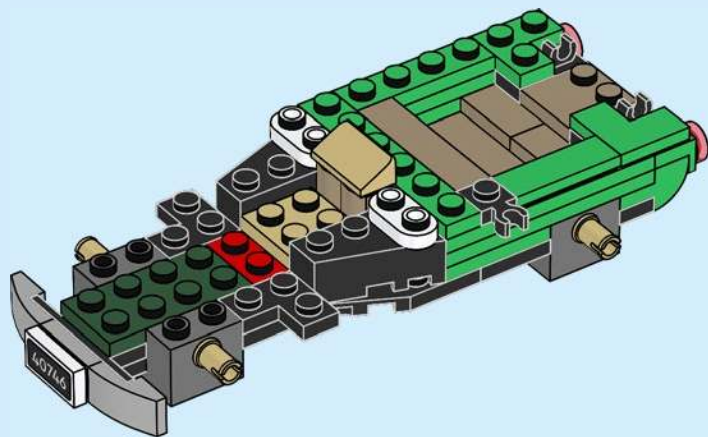

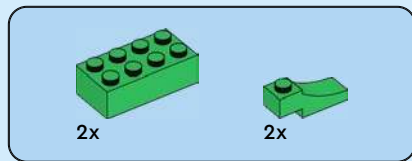

20

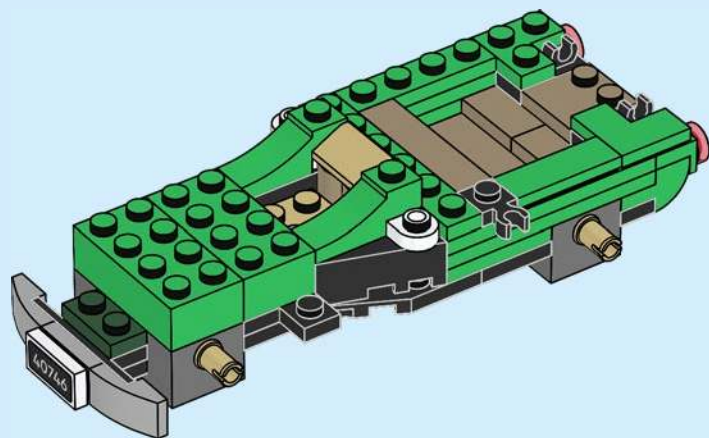

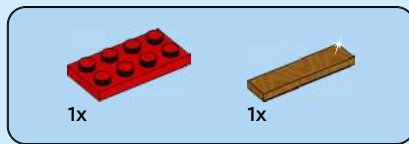
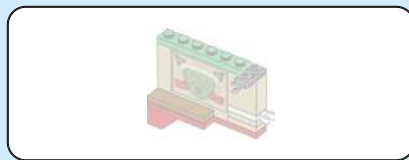

21

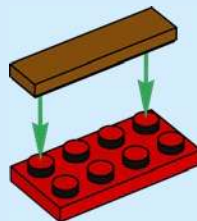

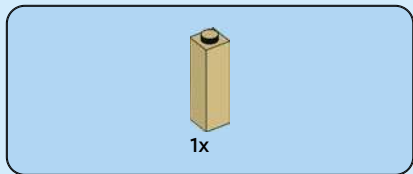

22

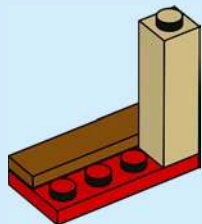

24

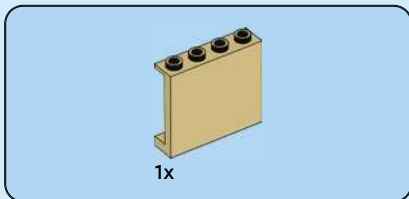

23

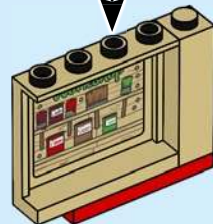
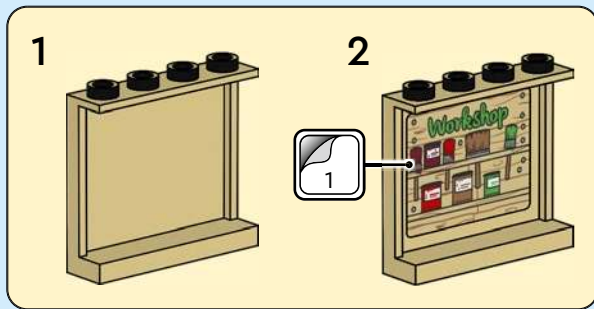

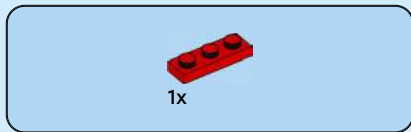

24

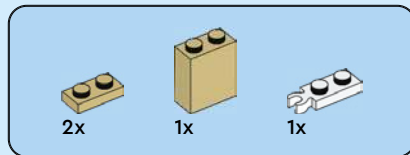
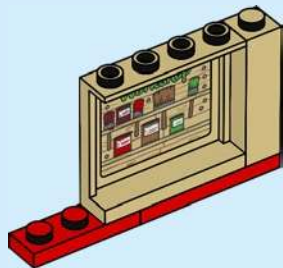

25

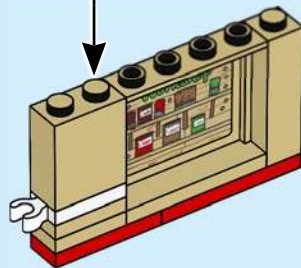
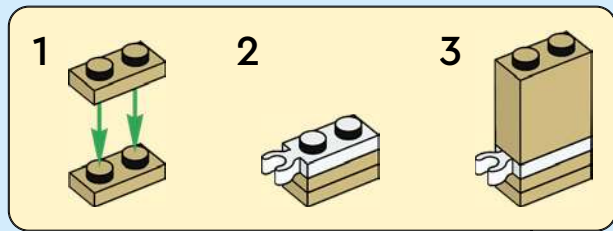

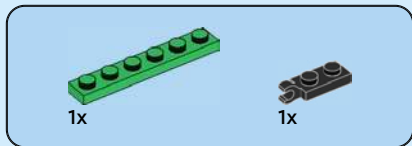

26

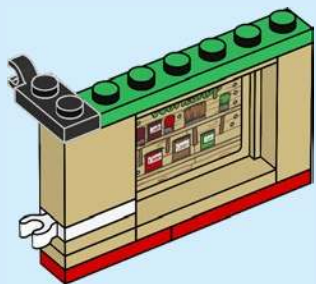

27

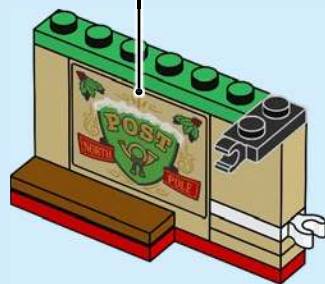
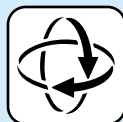



1x

28



29

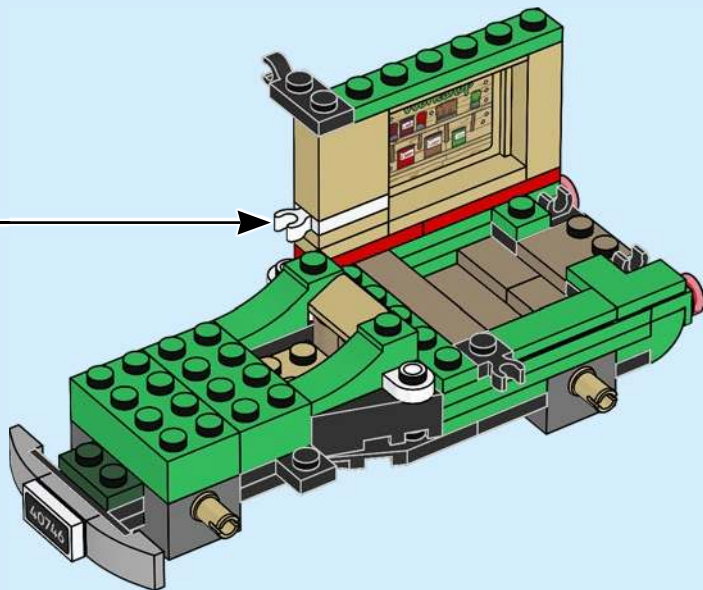

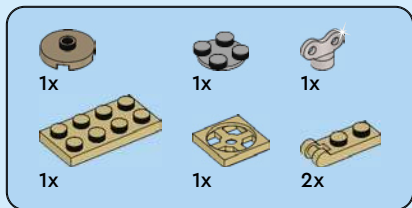

# 30

1

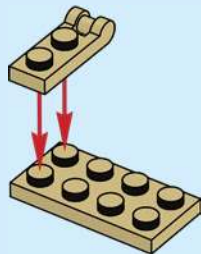

2

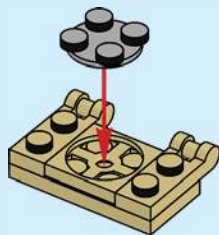

3

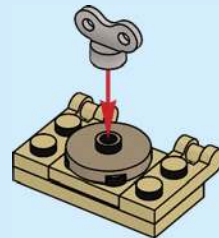

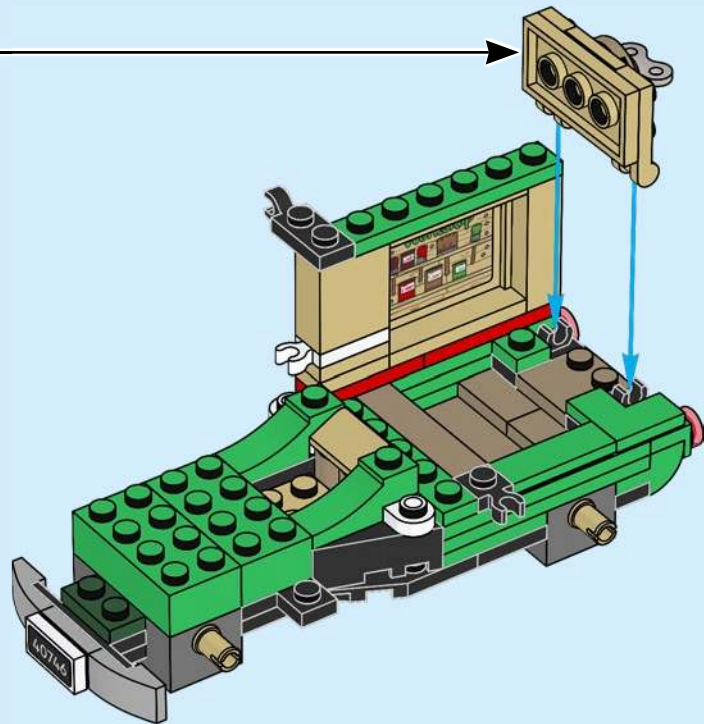

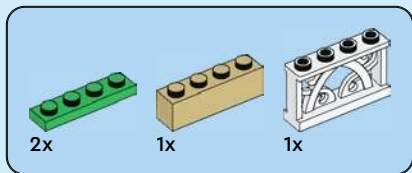

31

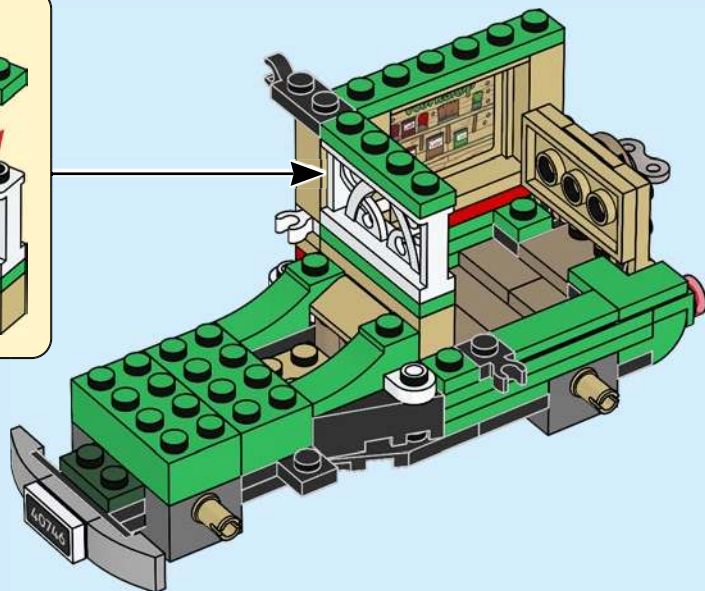
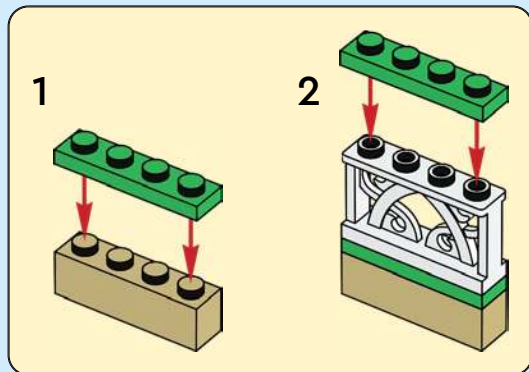

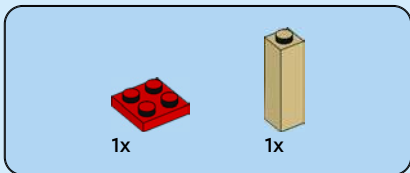

32

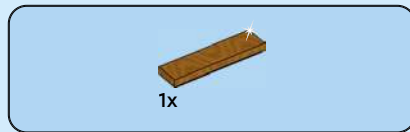
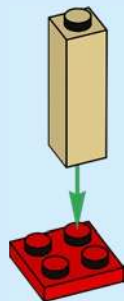

33

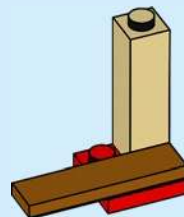



1x

34

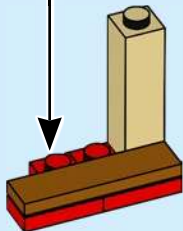

32



1x

35

1

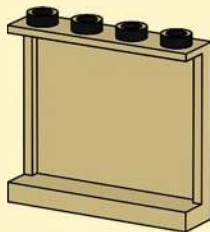

2

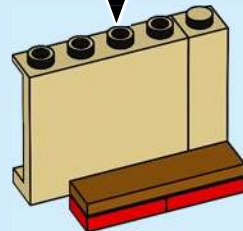
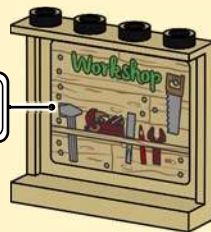

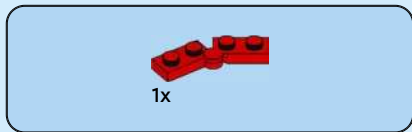

36

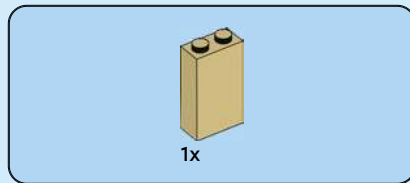
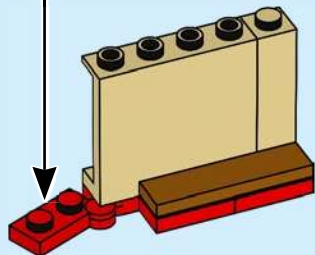
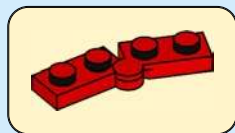

37

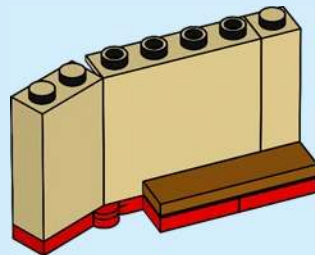

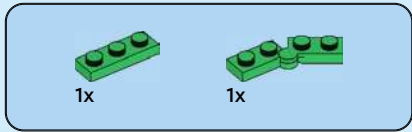

38

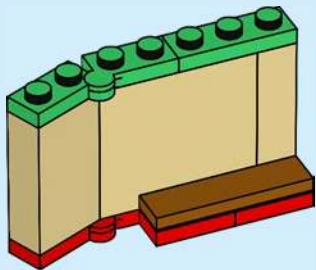

39





1x

40



41

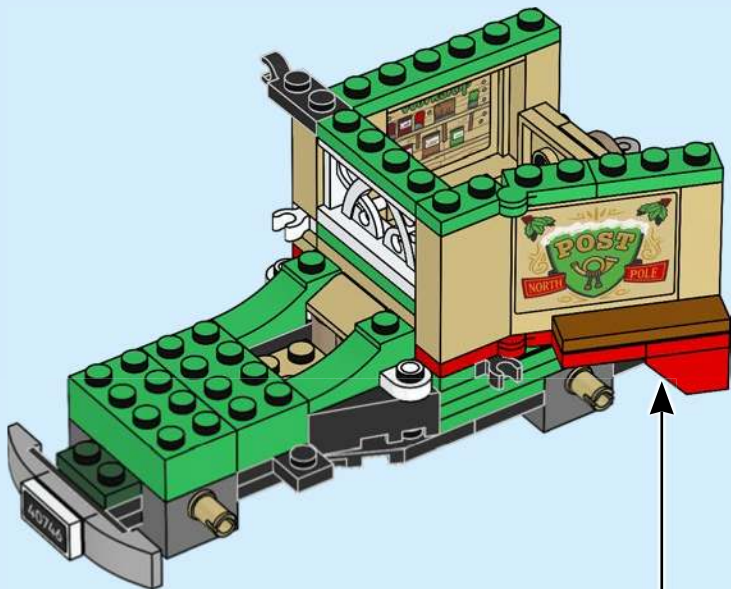

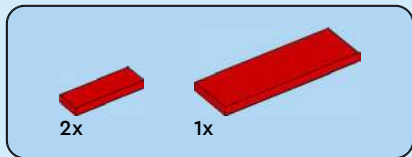

42

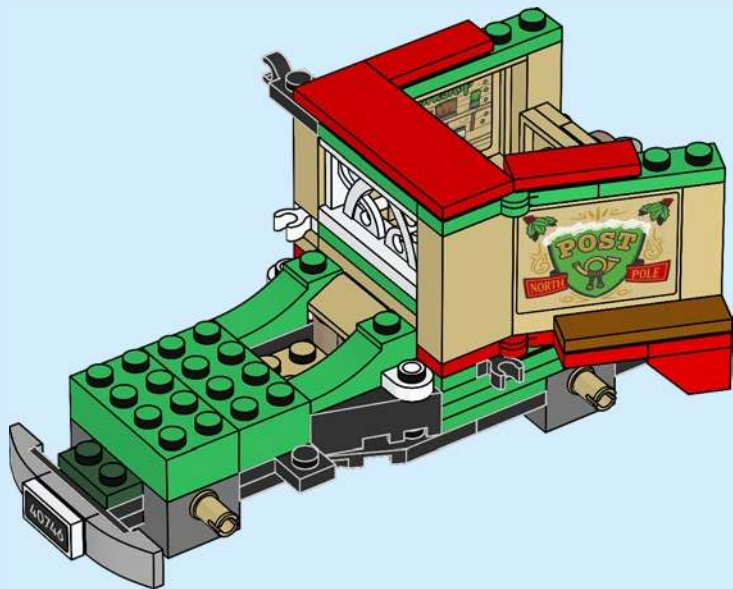



3x

43

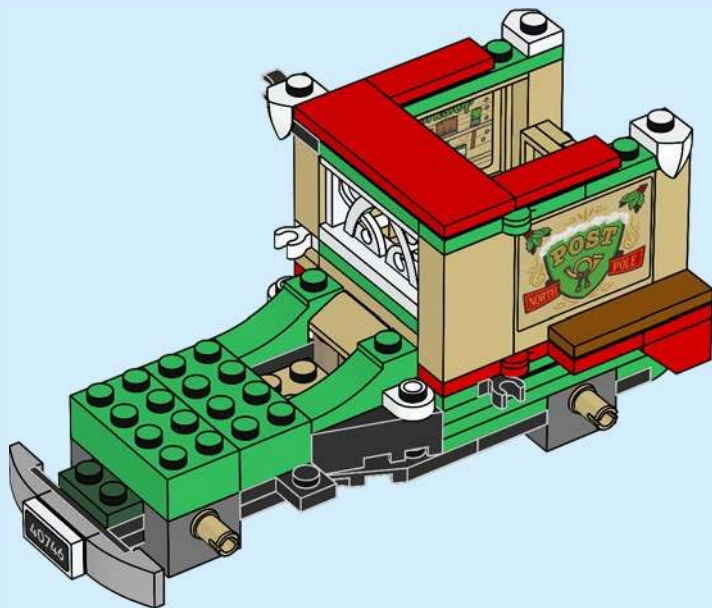

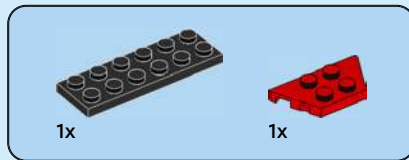

44

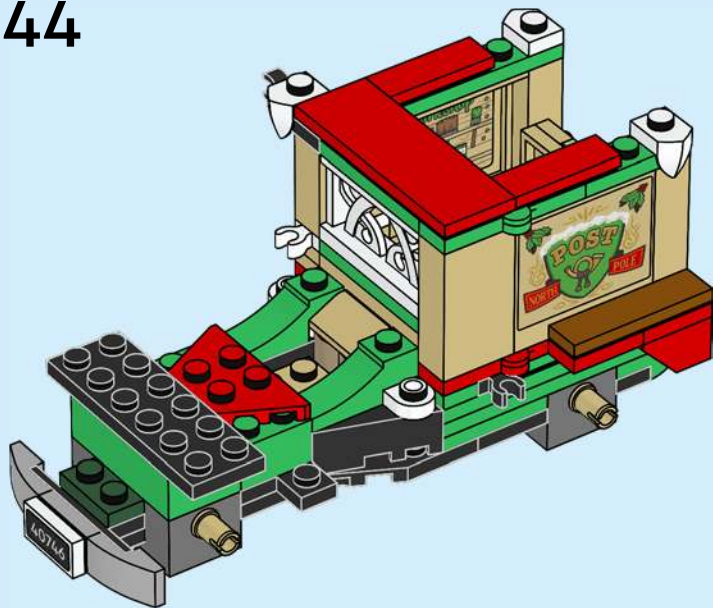



1x



1x

# 45

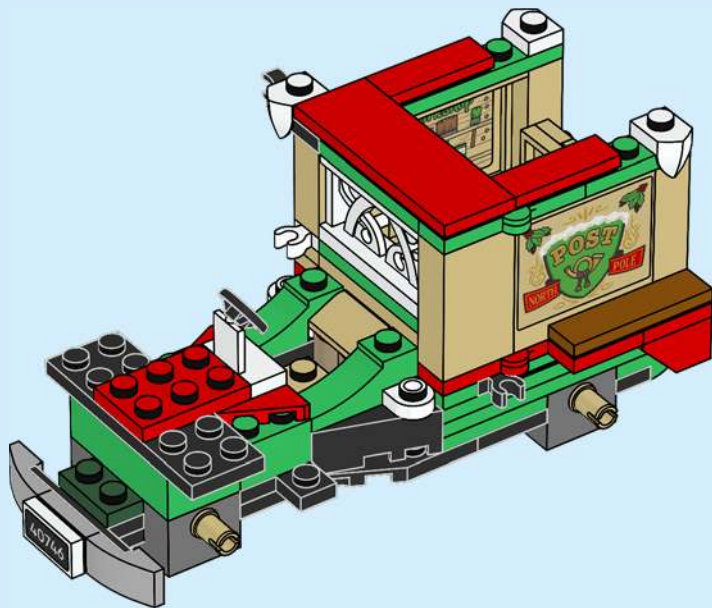

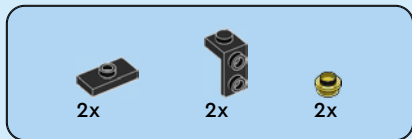

# 46

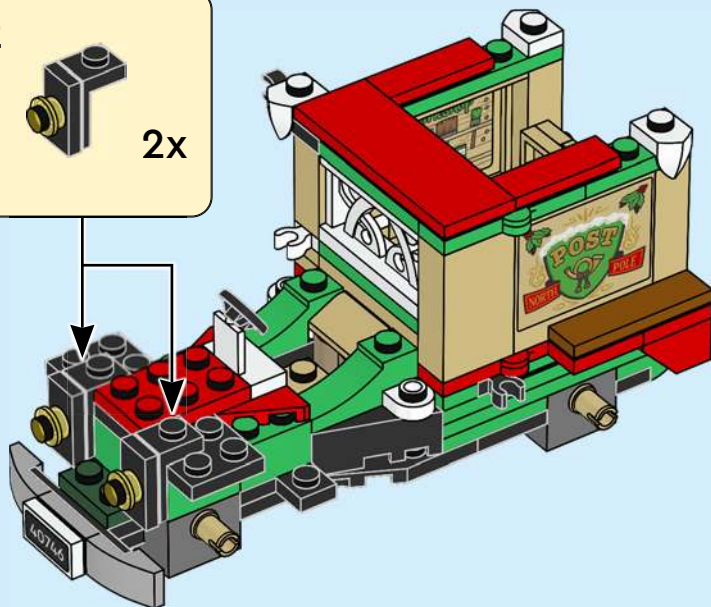
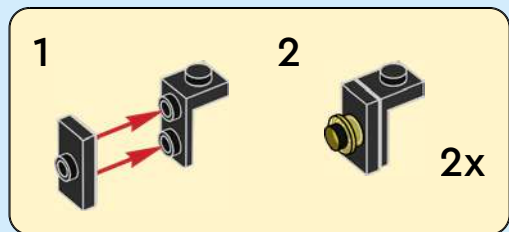

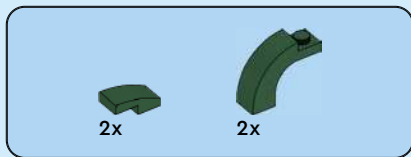

47

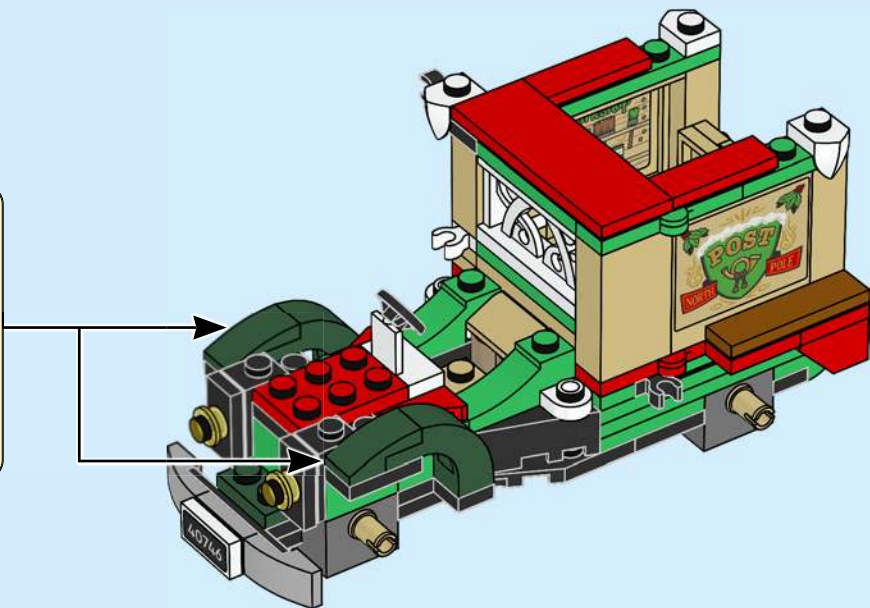
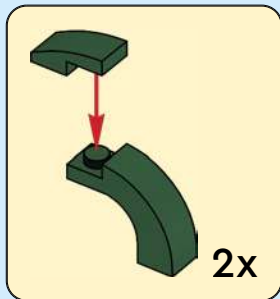



1x



1x

48

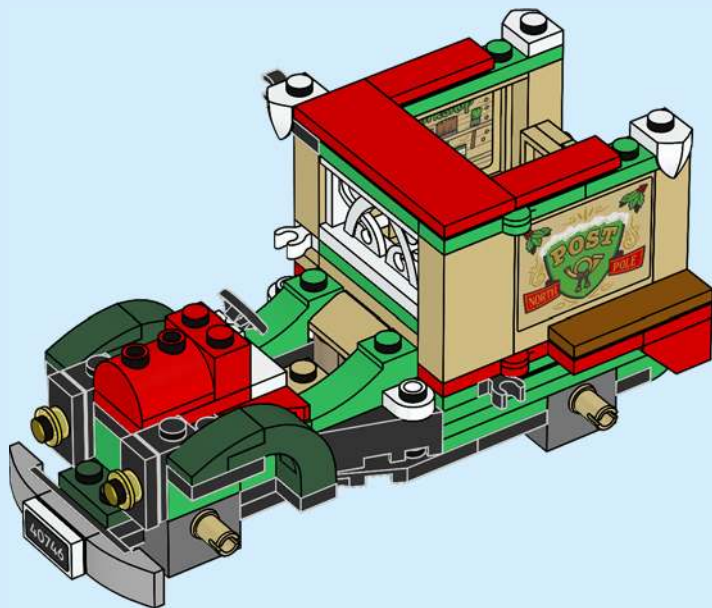

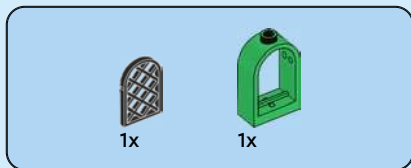

49

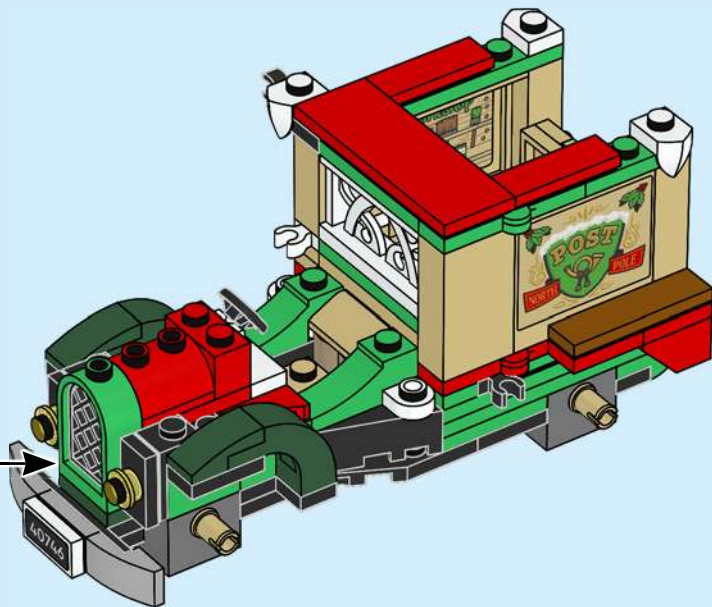
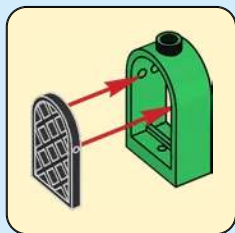



1x



1x

50

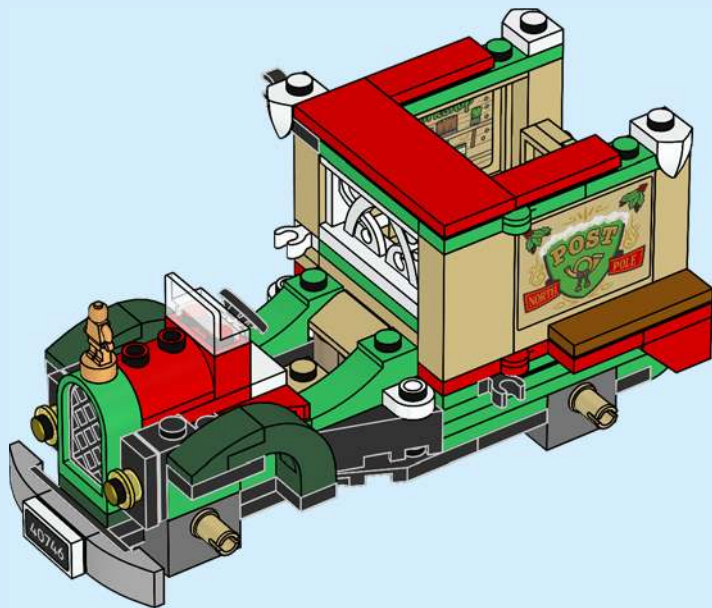



1x



1x

51

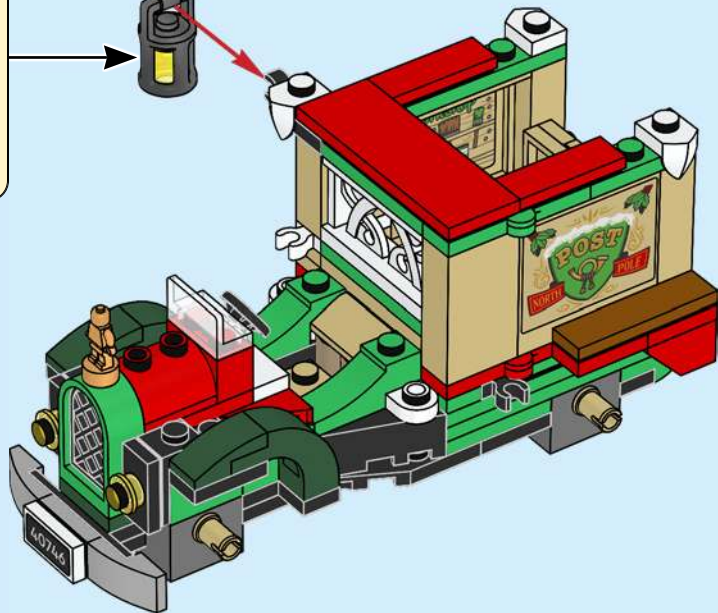
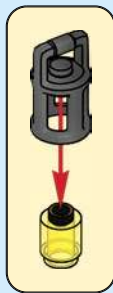



1x



1x

# 52





53

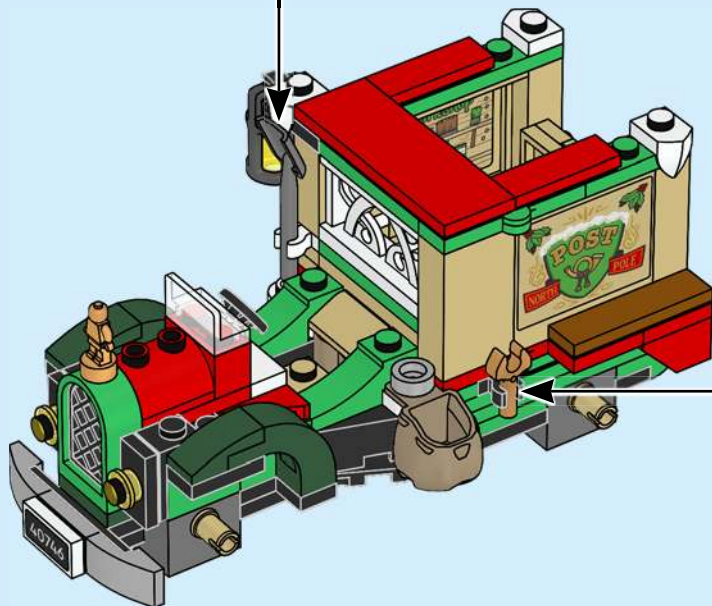



4x



4x

# 54

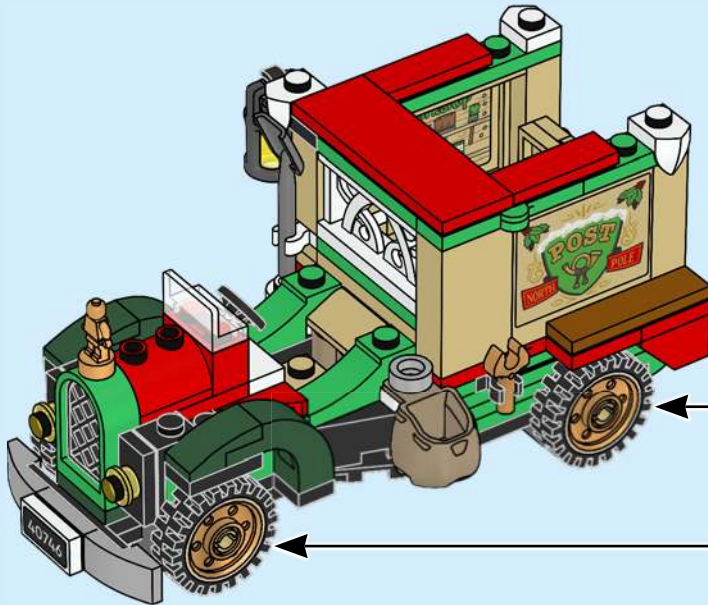

4x



55

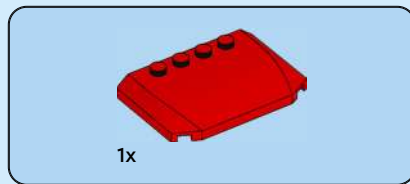

56

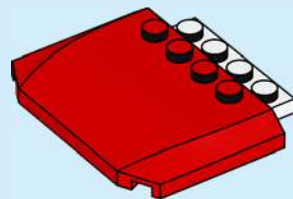

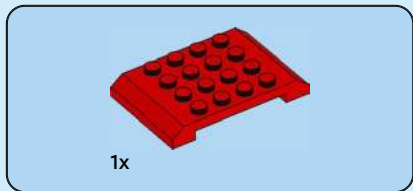

57

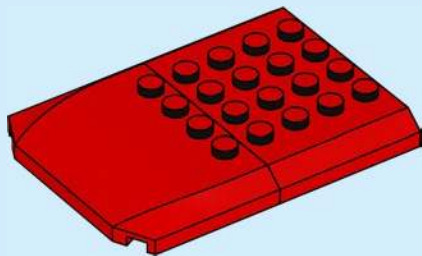

50

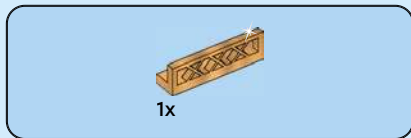

58

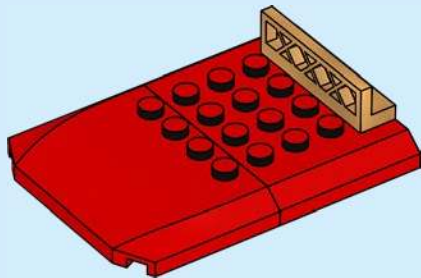

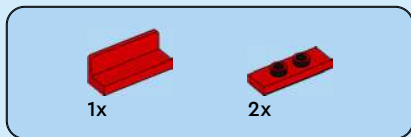

59

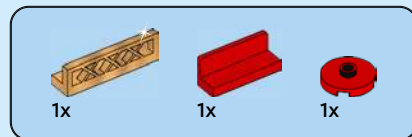
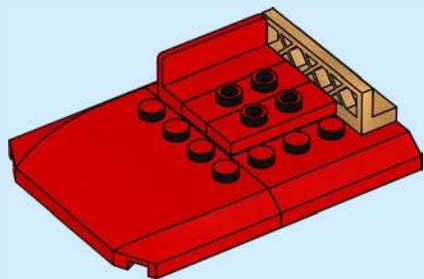

60

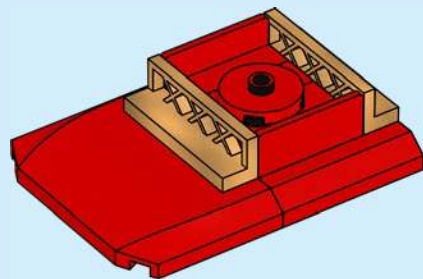

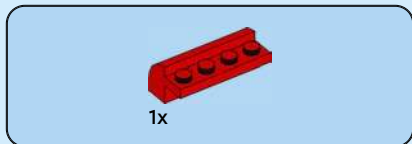

61

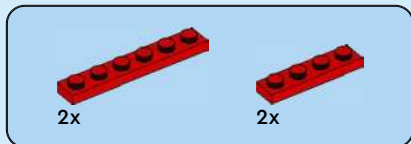
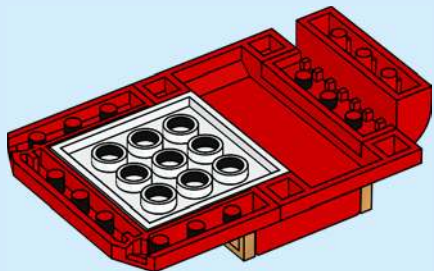

62

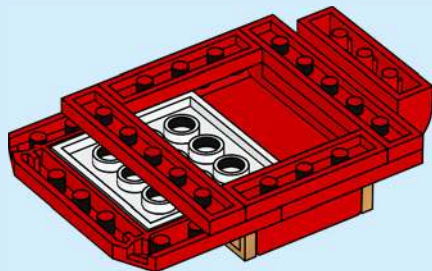

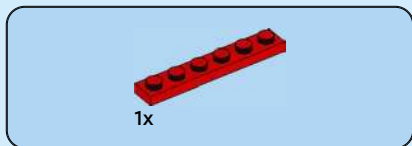

63

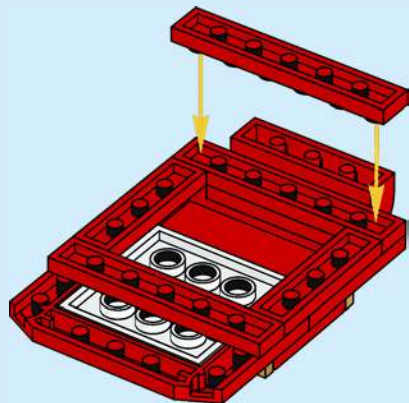

64

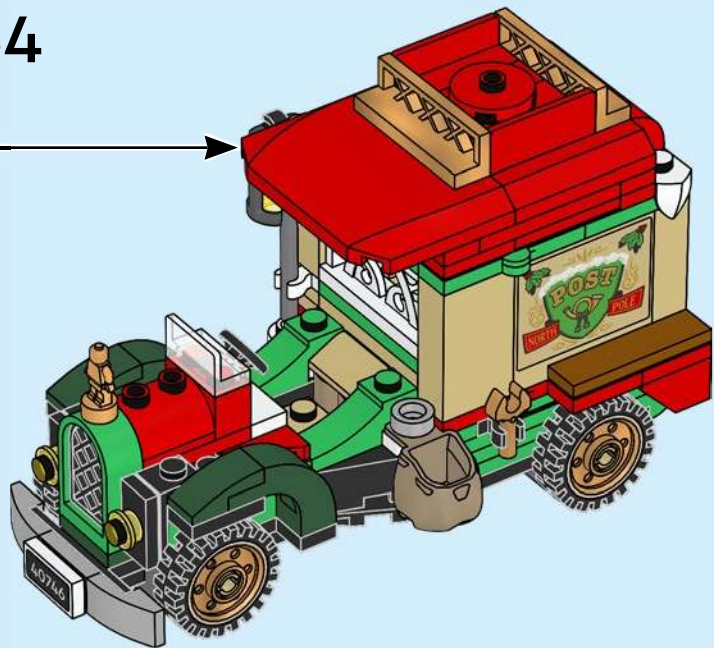

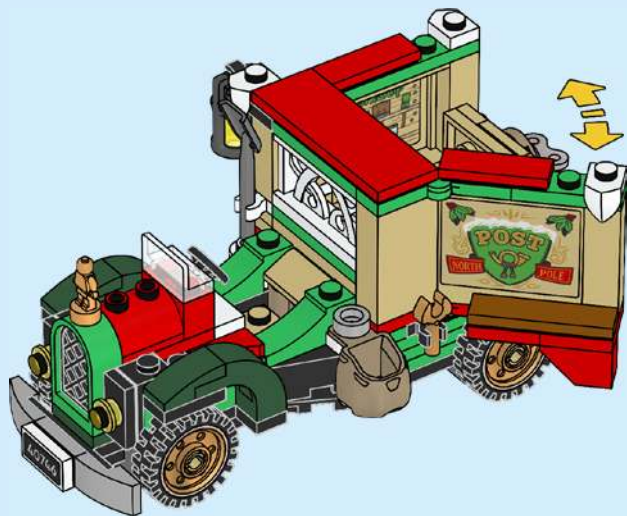
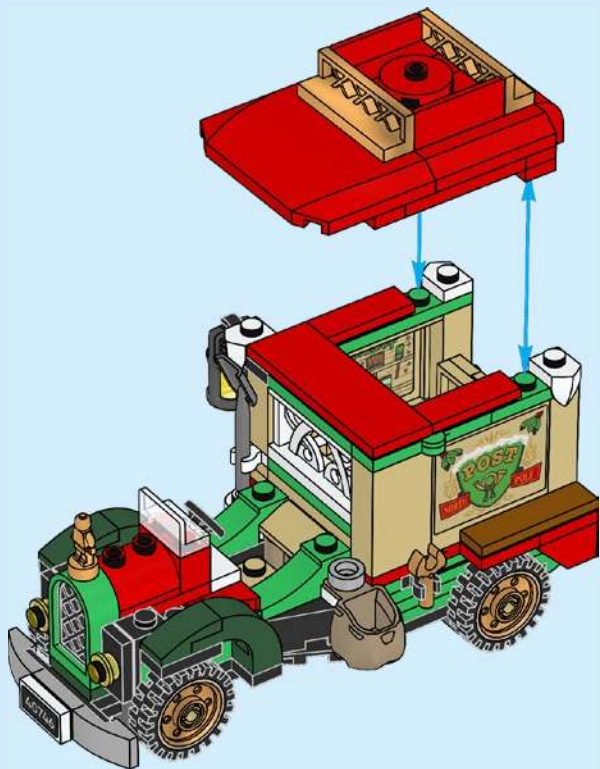



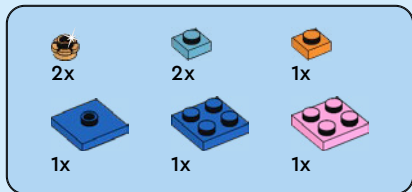

65

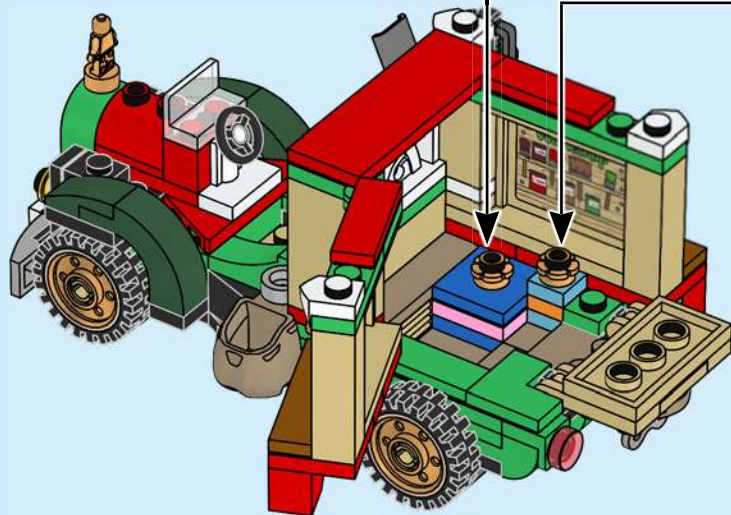
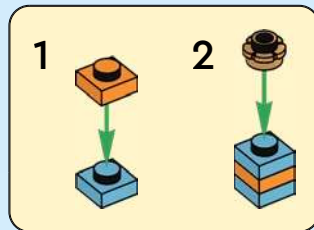
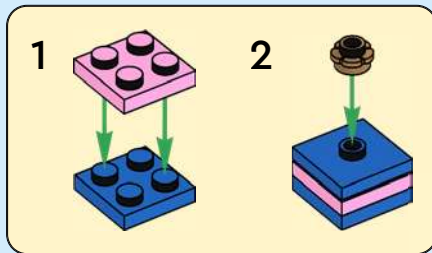

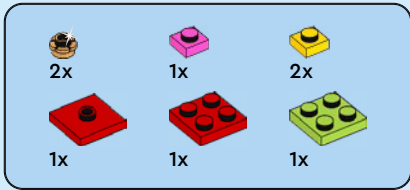

66

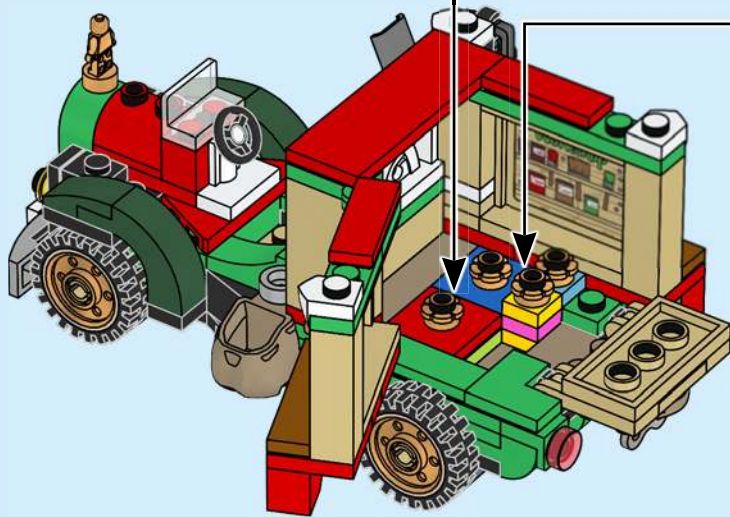
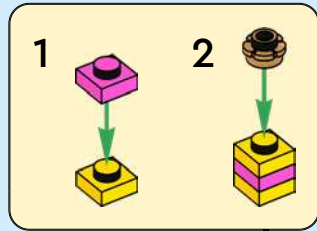
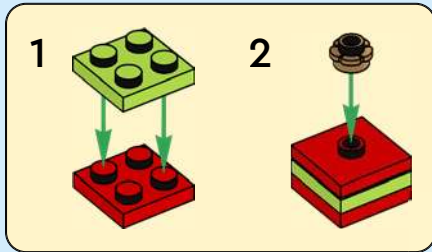

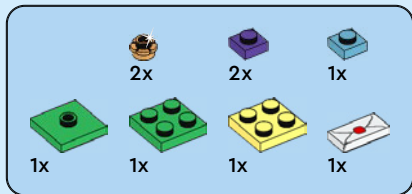

67

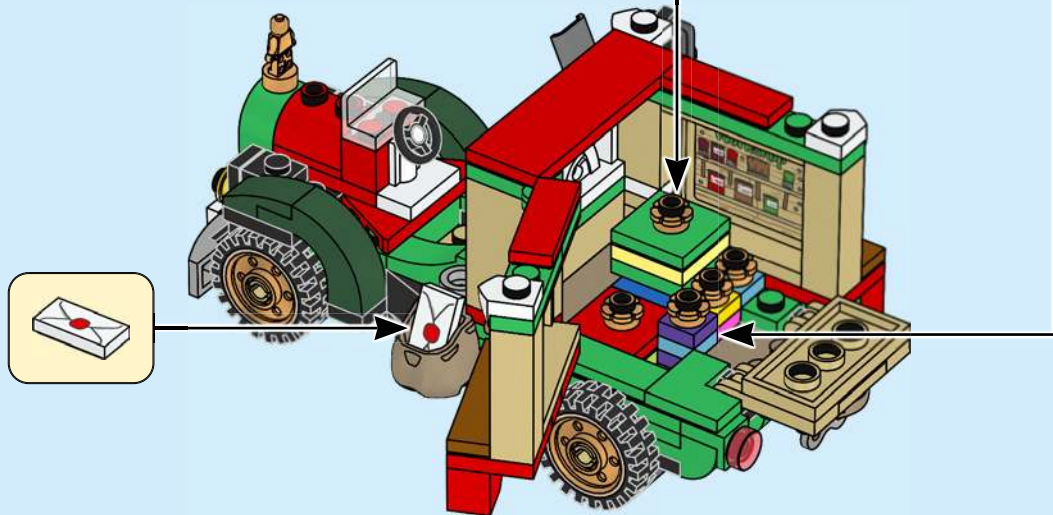
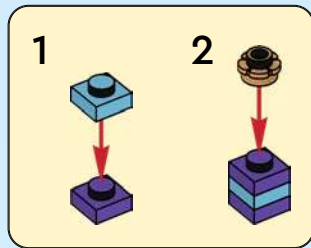
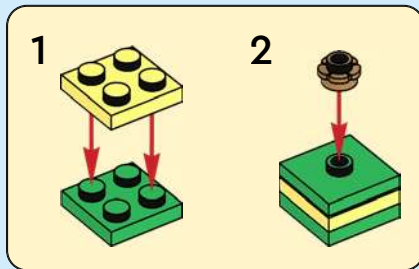



68

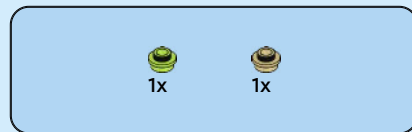

69





1x



1x



1x

70



1x



1x

71



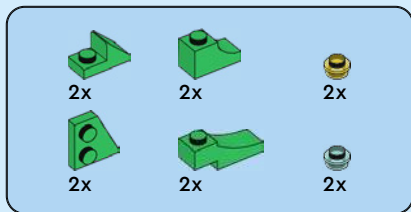

72

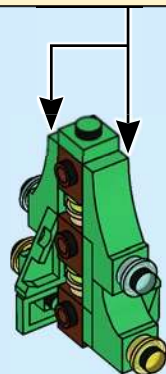
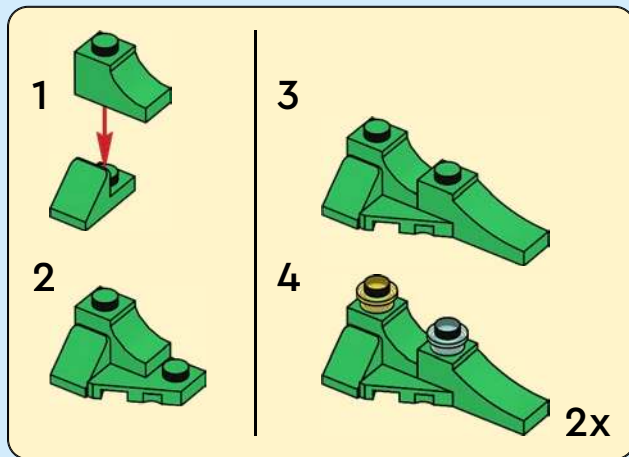

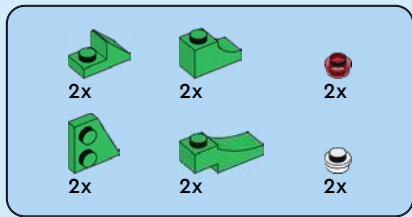

73

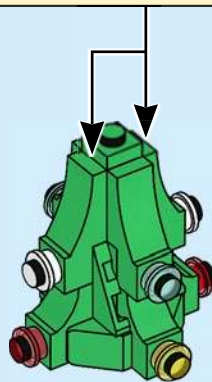
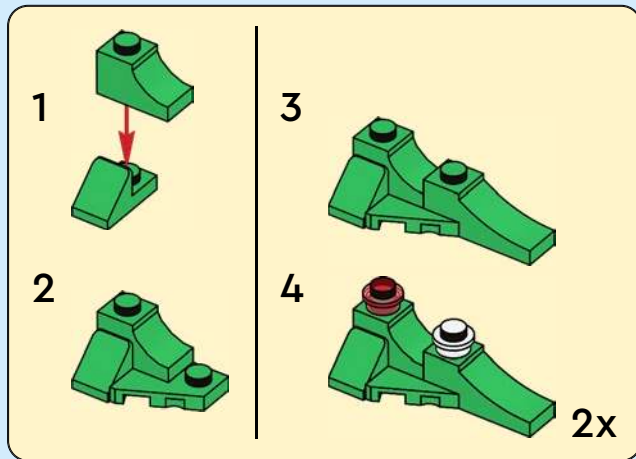



1x

74

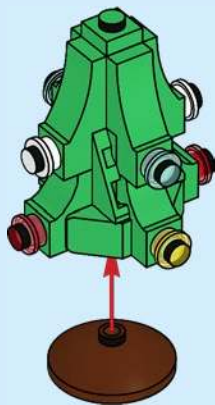

1x



1x

75

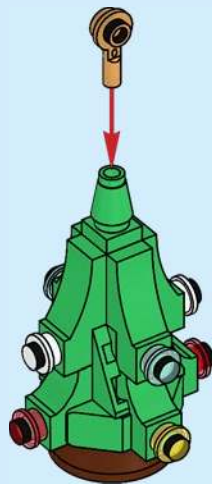



1x



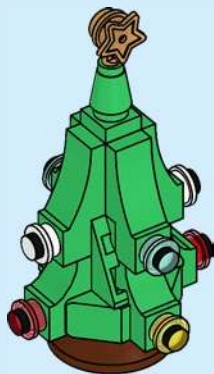

76

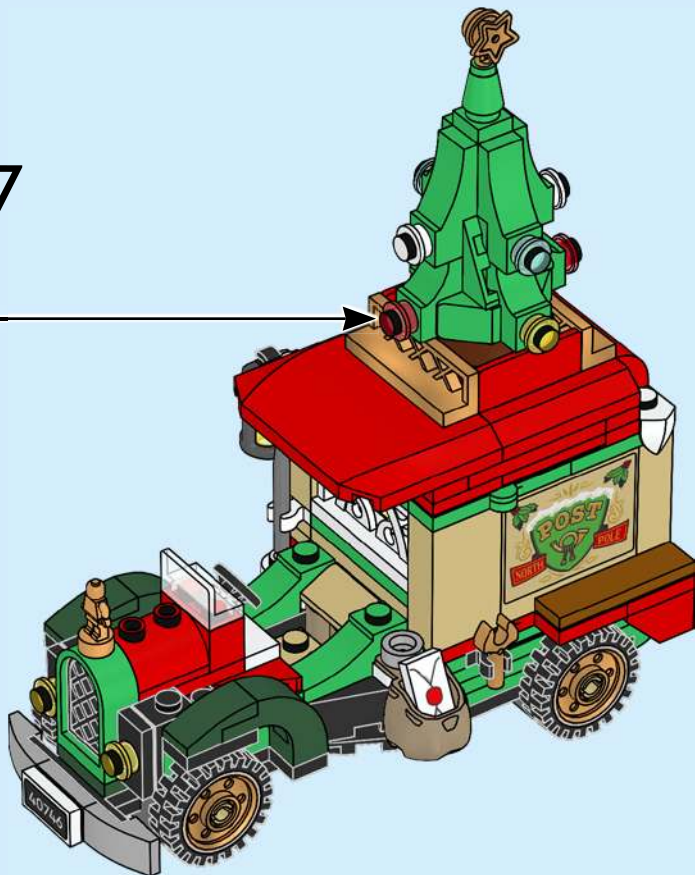

77





 2x 614101	 2x 6057517	 2x 6211975	 2x 302221	 1x 6416443	 1x 6126049	 1x 6330189	 1x 6168620
 3x 6046905	 1x 4624086	 1x 4113916	 1x 6126048	 3x 302021	 2x 302223	 2x 6347310	 1x 302026
 2x 6210272	 1x 6445058	 2x 6146877	 1x 362321	 1x 4116617	 1x 6153321	 1x 6336989	 2x 379526
 1x 306901	 1x 6445058	 1x 4114309	 2x 4533742	 3x 366621	 2x 302424	 2x 242026	 1x 4129572
 1x 6299836	 2x 4113917	 1x 6132541	 2x 6251410	 1x 6335578	 2x 302324	 4x 4541455	 1x 6001494
 1x 6372037	 1x 4159279	 1x 300421	 2x 6211447	 1x 4259903	 1x 6501719	 1x 4526931	 1x 4529239
 1x 6097236	 2x 6330903	 2x 366521	 1x 6023770	 1x 6173105	 1x 9551	 1x 6116604	 1x 302428
 1x 4243812	 1x 4114084	 1x 4521852	 1x 302121	 2x 6380236	 2x 6380236	 1x 4527766	 2x 6493339
 2x 6443061	 1x 6472370	 1x 242021	 2x 371021	 1x 6431017	 2x 6092585	 2x 6439175	 4x 6385279
 4x 4666579							



1x  
6493702



4x  
6226931



4x  
6399788



1x  
6389692



1x  
302228



1x  
4157120



3x  
6469900



1x  
6374049



6x  
6462444



3x  
4107758



1x  
6023083



3x  
371028



1x  
6416506



2x  
4106356

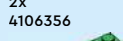

6x  
366628



1x  
6503677



1x  
6246888



2x  
6231376



2x  
6258607



2x  
6208450



1x  
6208450



1x  
6096589



1x  
6316265



2x  
6240225



4x  
6240216



1x  
6238674



1x  
4524929



2x  
6190251



1x  
4537937



1x  
4520257



1x  
6016059



1x  
4598955



1x  
6132767



3x  
6396392



1x  
6175927



1x  
4626904



1x  
6164288



2x  
6055225



2x  
6484766

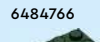

1x  
4586057



3x  
6133765



1x  
6488491



1x  
6258831



1x  
4540203



3x  
4211398



2x  
6028813



1x  
6217797



3x  
6097493



1x  
6335115



1x  
4211006



1x  
6454959



1x  
4210997



1x  
6335932



6x  
6209691



1x  
6335111



4x  
6435037



2x  
4536675



1x  
6453281



1x  
6184647



1x  
6363150



1x  
6234116



2x  
6332155



 [LEGO.com/service](https://www.LEGO.com/service)

YOU COULD **WIN**



Scan this QR code or go to **LEGO.COM/PRODUCTFEEDBACK** and give us your short feedback about this LEGO® set for a chance to win a cool LEGO prize.

Terms and Conditions apply\*



**EN: YOU COULD WIN.** Terms and Conditions apply\* **DE: Du könntest GEWINNEN.** Es gelten die Teilnahmebedingungen\* **FR: Tu pourrais GAGNER.** Des conditions s'appliquent\* **IT: Potresti VINCERE tu.** Termini e condizioni sono applicabili\* **ES: Puedes GANAR.** Aplican términos y condiciones\* **PT: Poderá GANHAR.** Aplicam-se termos e condições\* **ZH: 轻松获奖. 条款和条件适用\*** **PL: Szansa na WYGRANĄ.** Obowiązują warunki korzystania\* **CS: Máte šanci VYHRÁT.** Platí všeobecné smluvní podmínky\* **SK: Máte šancu VYHRAŤ.** Platia všeobecné zmluvné podmienky\* **HU: TE IS NYERHETSZ.** Felhasználási feltételek érvényesek\* **RO: Ai putea CÂȘTIGA.** Se aplică termenii și condiții\* **BG: Можете да СПЕЧЕЛИТЕ.** Има определени правила и условия\* **LV: Tu vari LAIMĒT.** Ir spēkā noteikumi un nosacījumi.\* **ET: Sul on võimalus VÕITA.** Kehtivad tingimused\* **LT: Jūs galite LAIMĖTI.** Taikomos sąlygos\*

\*[LEGO.com/productfeedback-terms](https://www.lego.com/productfeedback-terms)