





[LEGO.com/sustainable-packaging](https://LEGO.com/sustainable-packaging)



**FR**  
**DONNEZ**  
OU  
**RECYCLEZ**

 OU  OU 

ASSOCIATION MAGASIN DÉCHÈTERIE

Adresses sur [quefairedemesdechets.fr](https://quefairedemesdechets.fr)

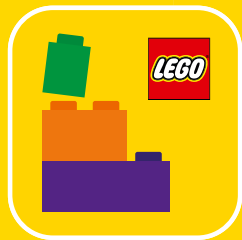

Q LEGO® Builder

# BUILDER



Apple and the Apple logo are trademarks of Apple Inc., registered in the U.S. and other countries and regions. App Store is a service mark of Apple Inc. Google Play and the Google Play logo are trademarks of Google LLC. Tencent and the Tencent logo are trademarks of Tencent Inc.

Q [LEGO.com/devicecheck](https://www.lego.com/devicecheck)

EN Ask parents' permission before going online | DE Eltern um Erlaubnis bitten, bevor du online gehst | FR Demande l'autorisation d'un parent avant d'aller en ligne | IT Chiedi il permesso ai tuoi genitori prima di andare online | ES Pídeles permiso a tus papás antes de conectarte a Internet | PT Pede autorização aos pais antes de acederes online | ZH 上网前应先征得父母的同意 | PL Poproś rodziców o zgodę, zanim wejdiesz do Internetu | CS Než půjdeš na internet, požádej rodiče o svolení | SK Skôr než pôjdeš na internet, vypýtaj si povolenie od rodičov | HU Kérj szülői engedélyt, mielőtt online csatlakoznál! | RO Cere permisiunea părinților înainte de a te conecta online | BG Поискайте разрешение от родител, преди да влезете онлайн | LV Pirms došanās tiešsaistē palūdz atļauju vecākiem | ET Enne Interneti kasutamist küsi vanematelt luba | LT Prieš prisijungdami prie interneto, atsiklauskite tėvų

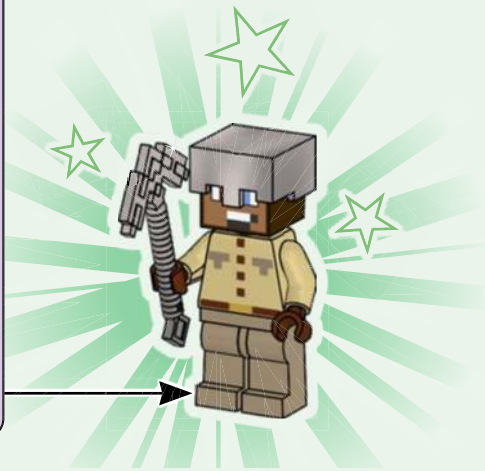
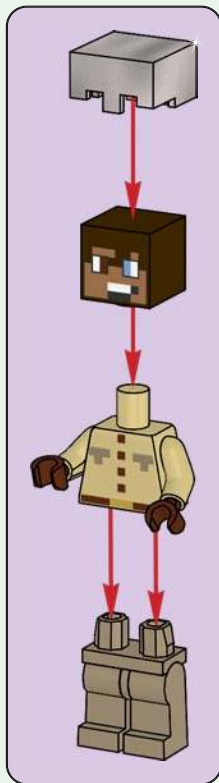

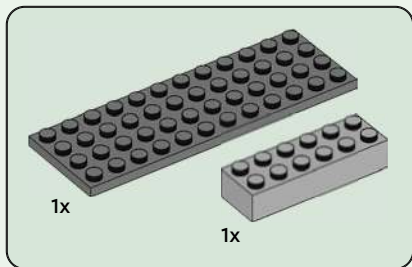

1

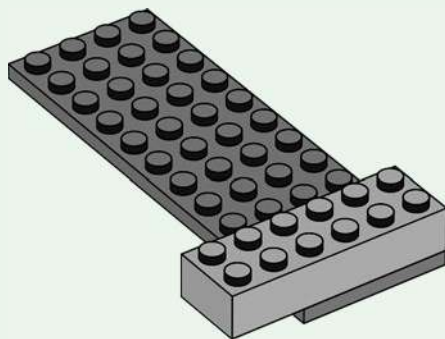

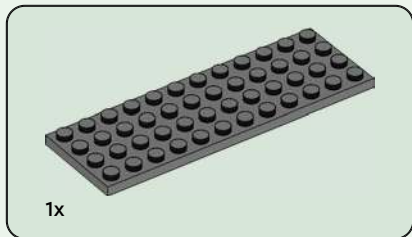

2

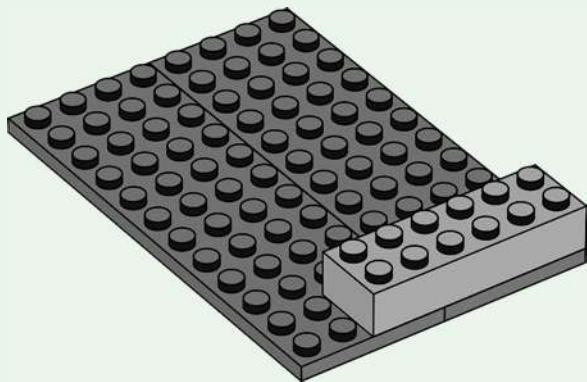

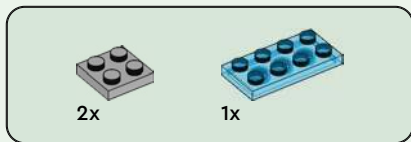

3

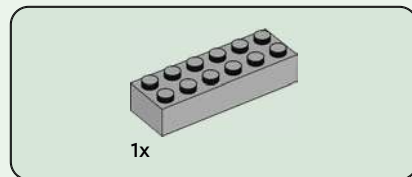
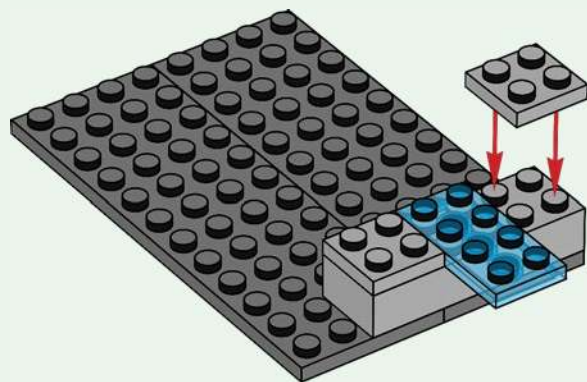

4

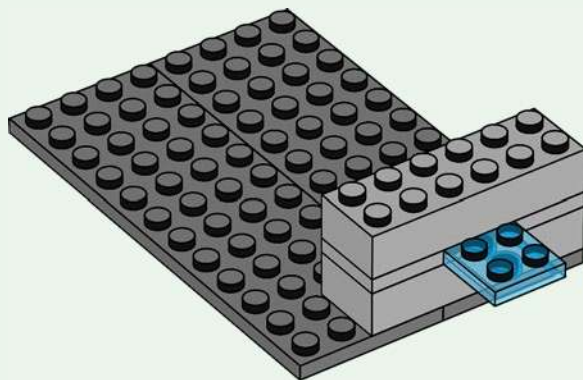

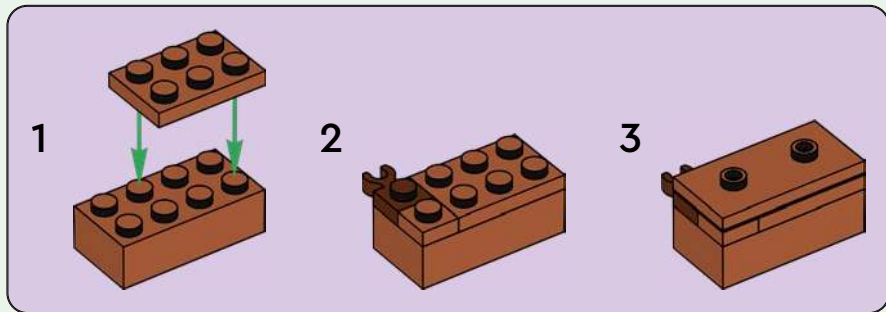
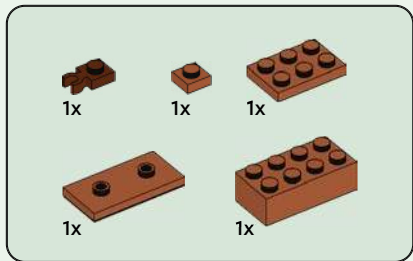

5

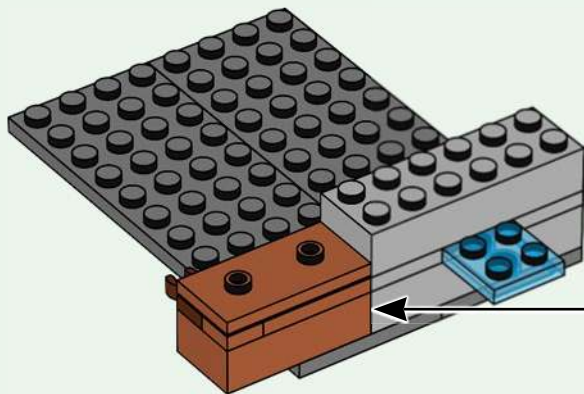

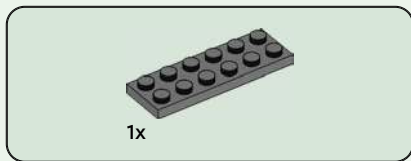

6

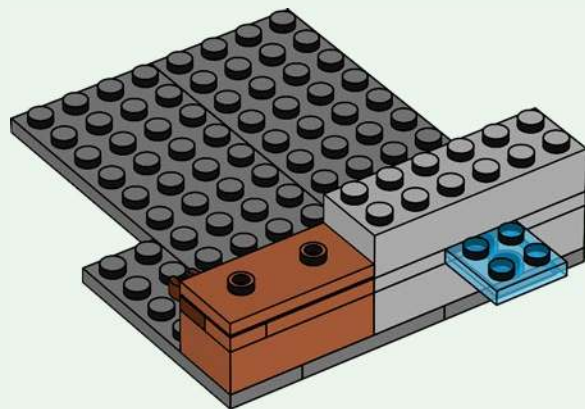



3x

7

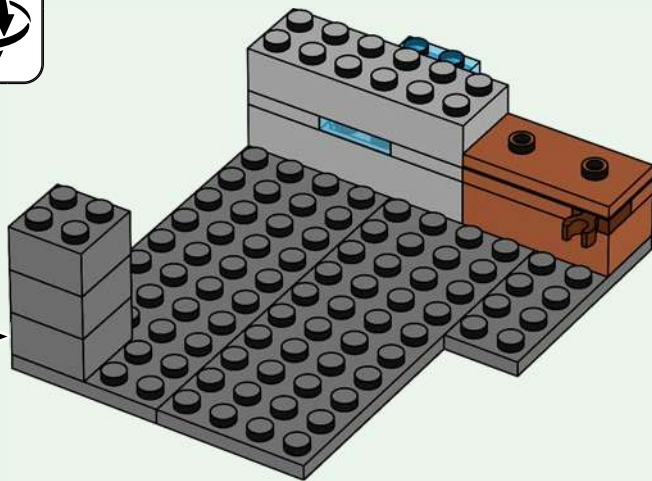
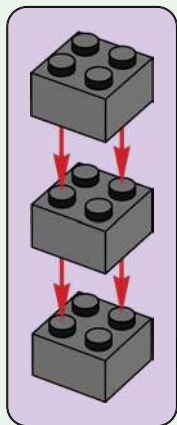



1x



1x

8

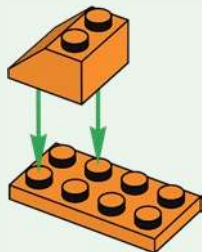

1x



1x

9

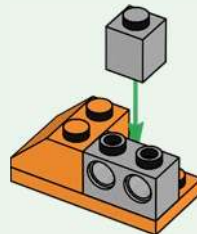

1x



2x

10

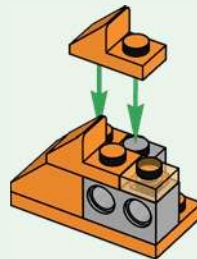



1x

11

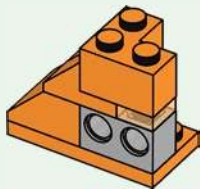

12



1x



1x

12

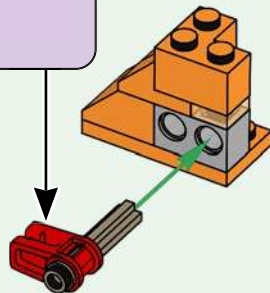
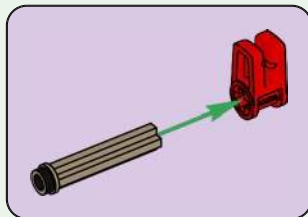

3,2

1:1



1x

13

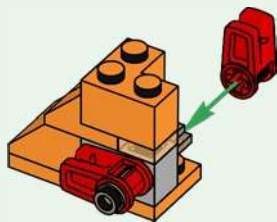

14

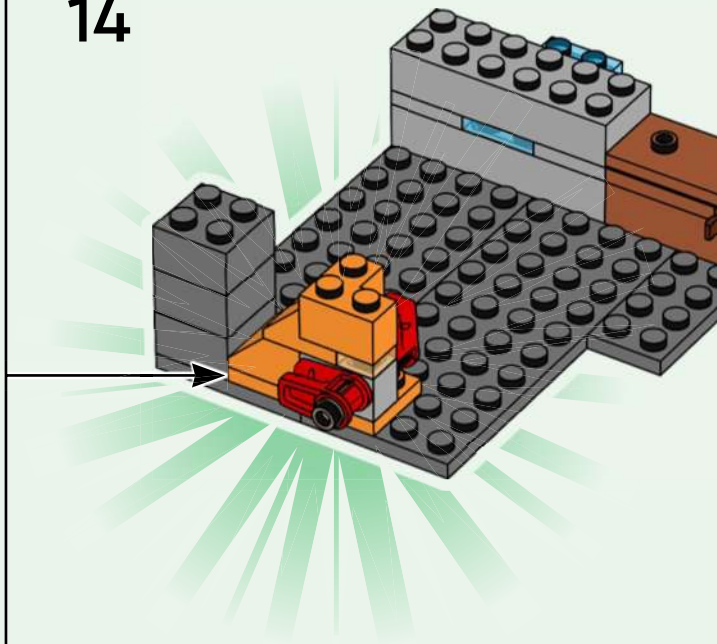

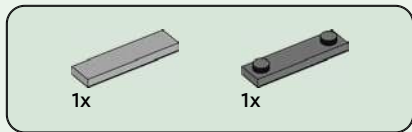

15

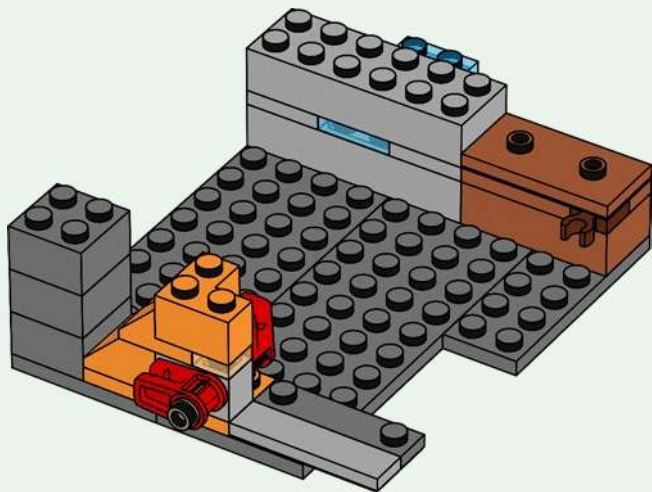

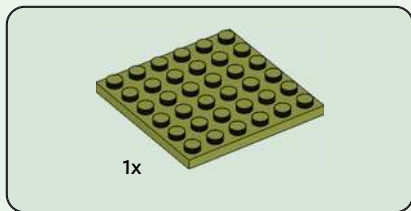

16

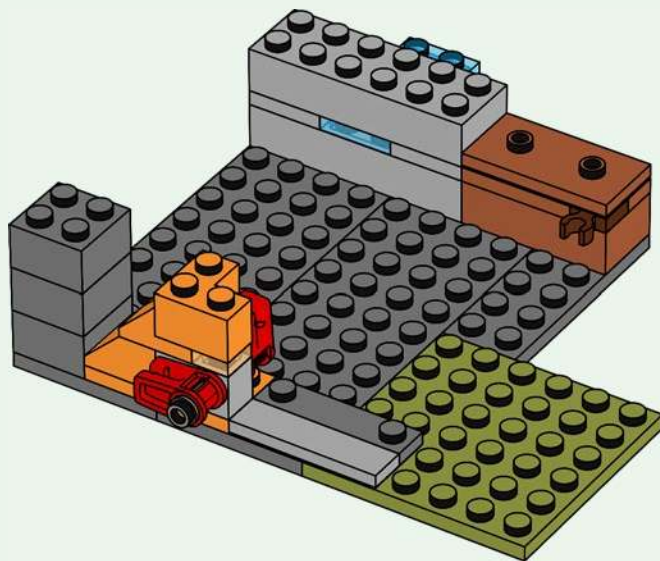

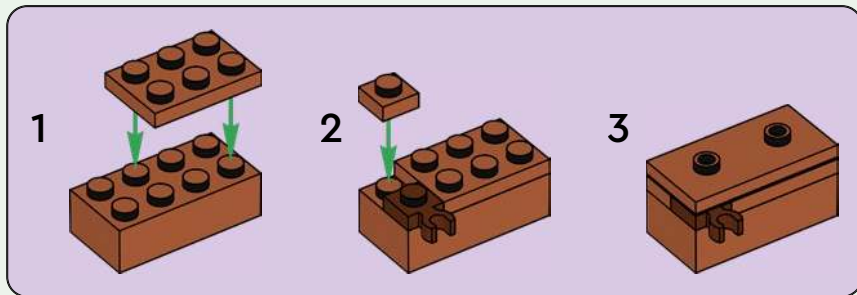
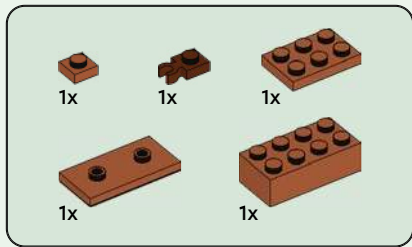

17

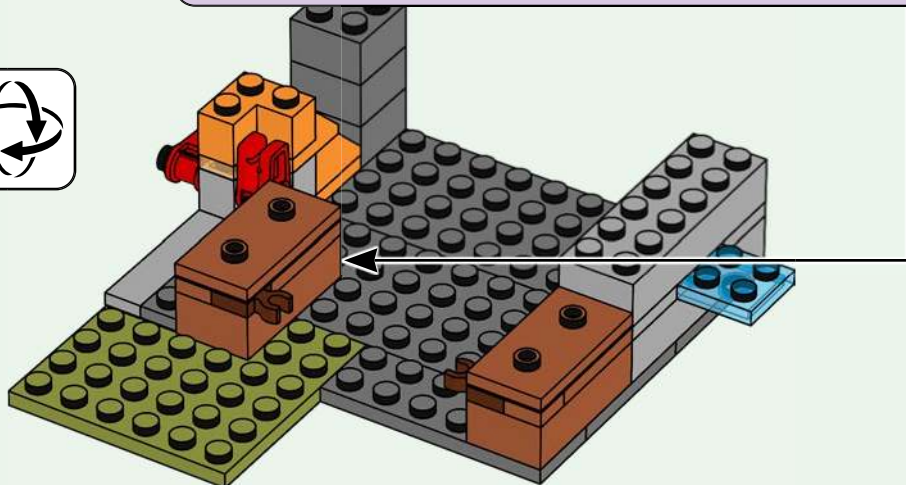

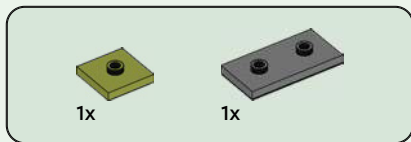

18

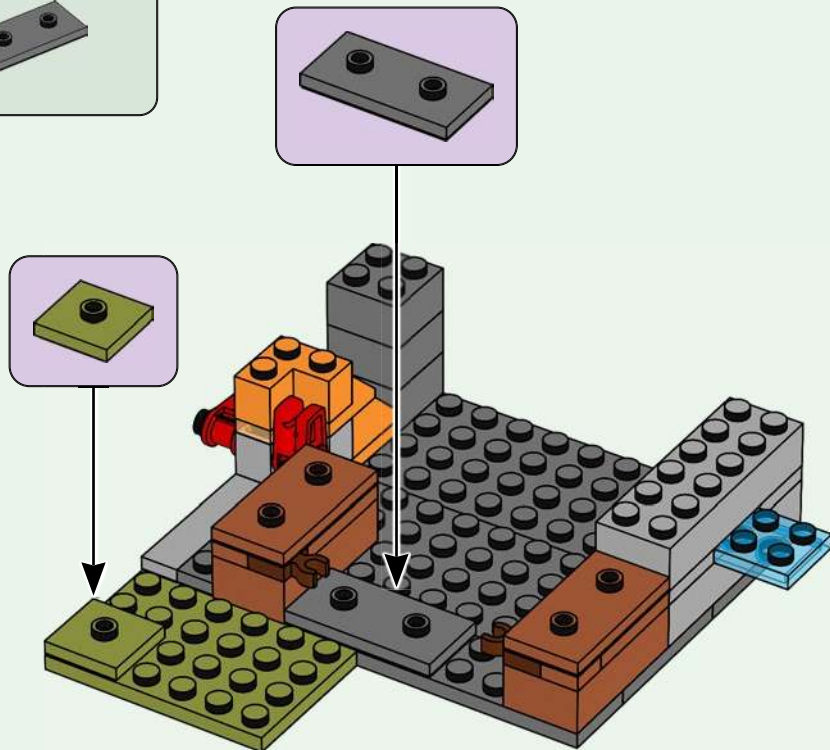

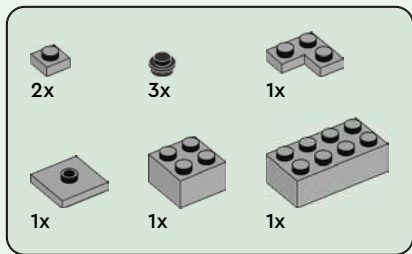

19

1

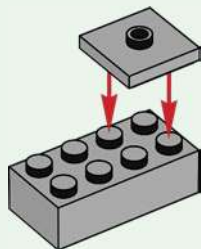

2

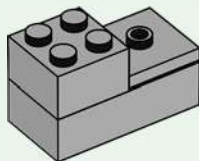

3

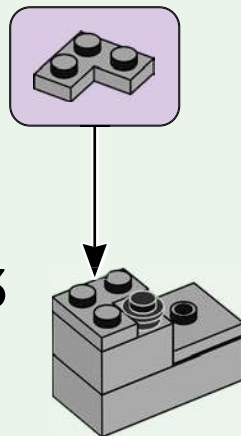

4

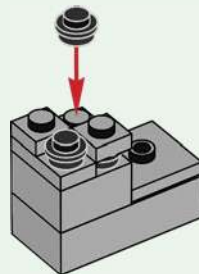

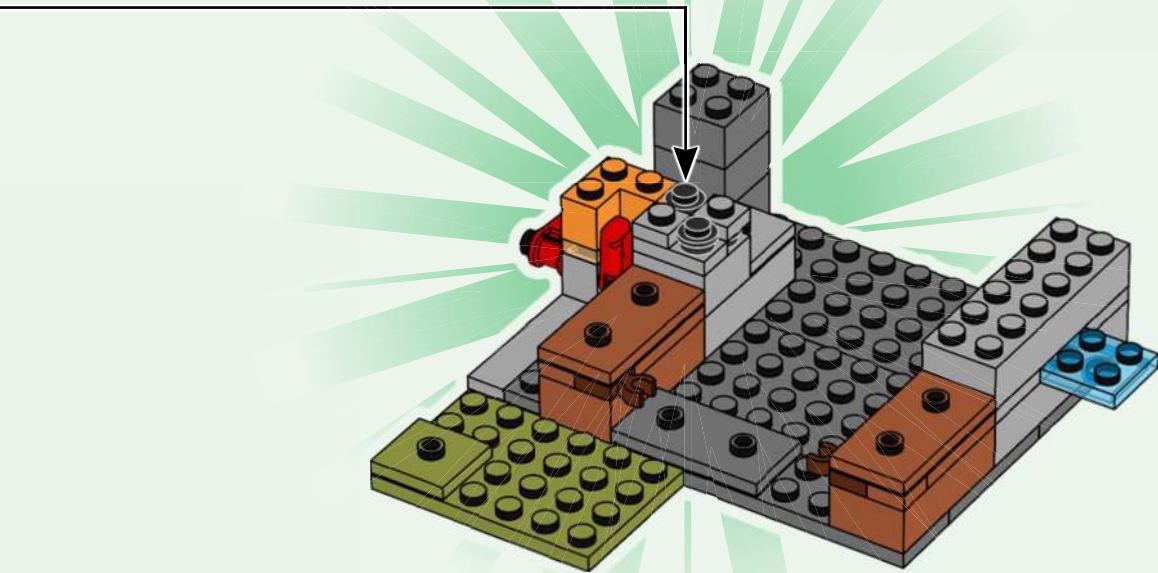

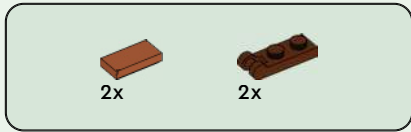

20

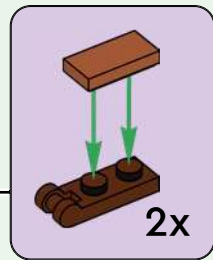
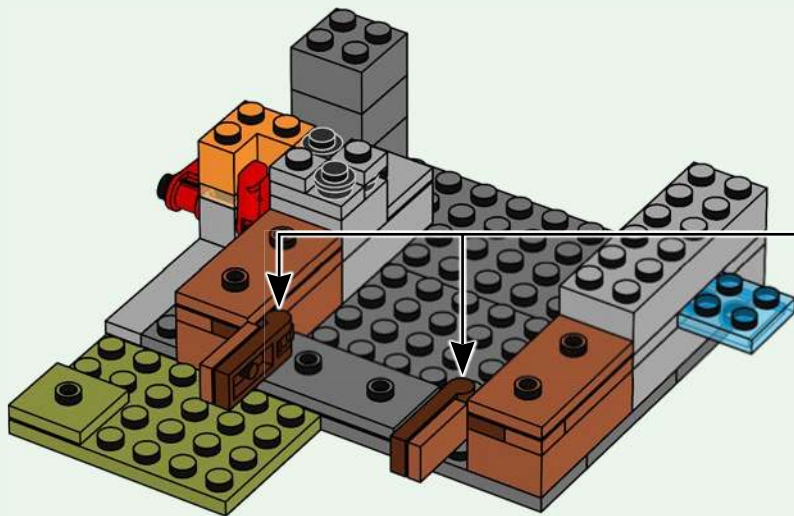



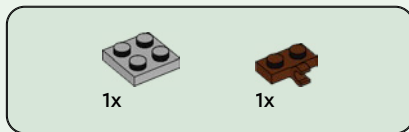

22

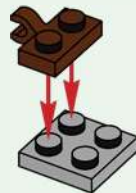

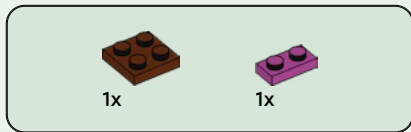

23

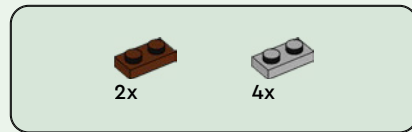
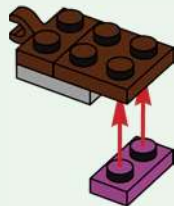

24

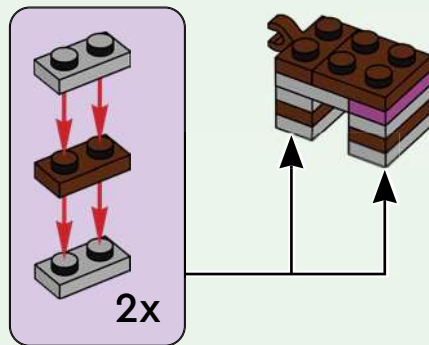

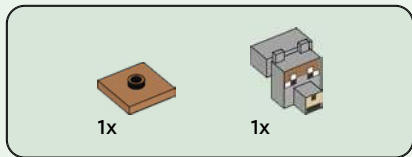

25

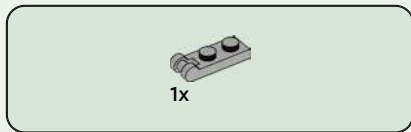
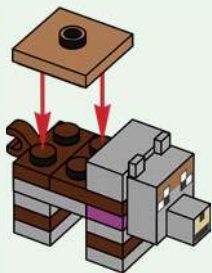

26

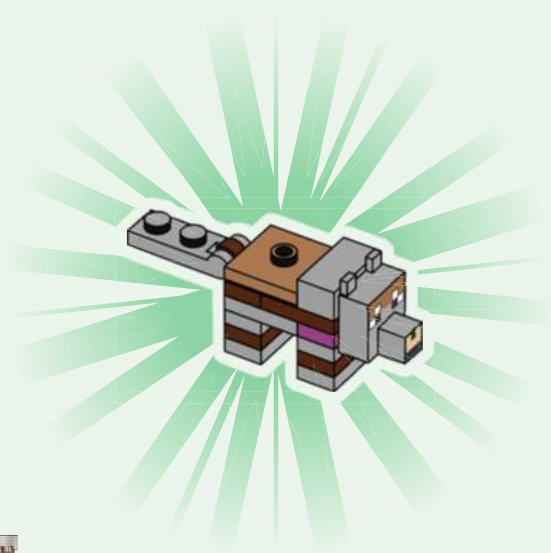





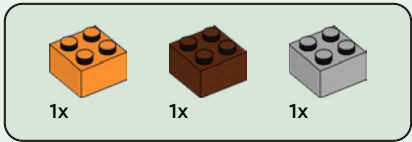

29

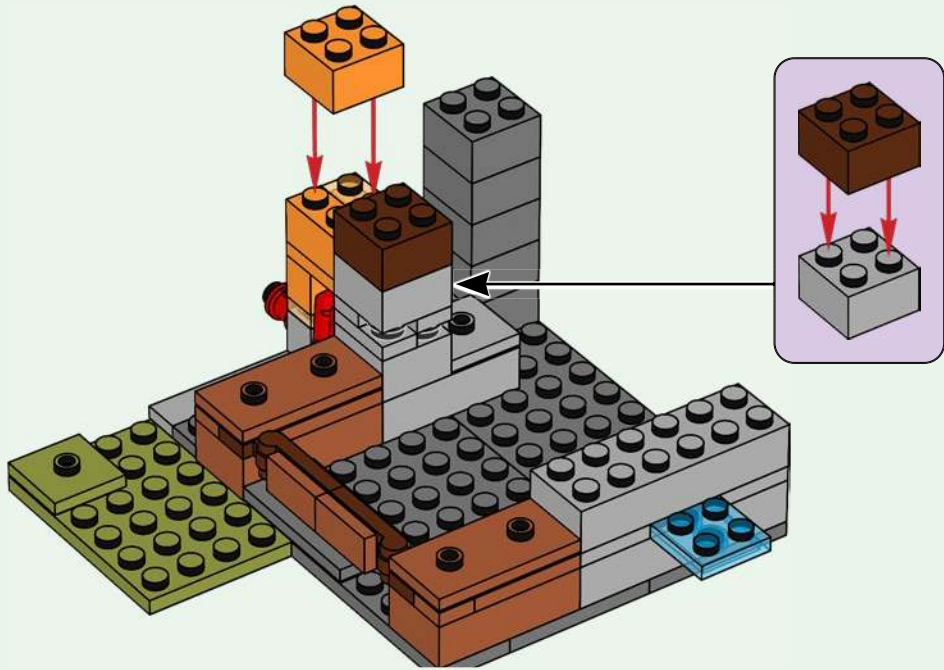

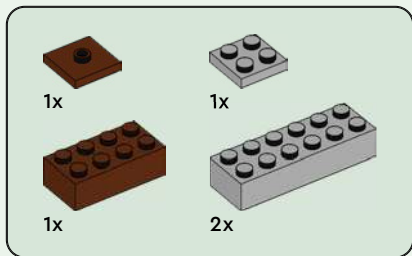

30

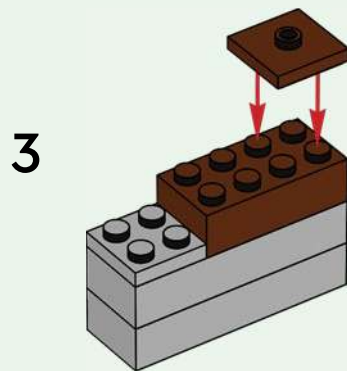
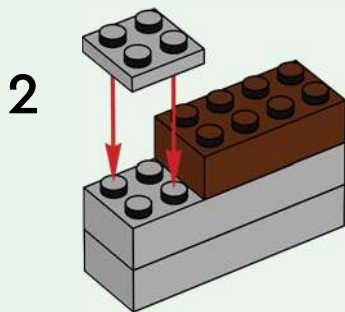
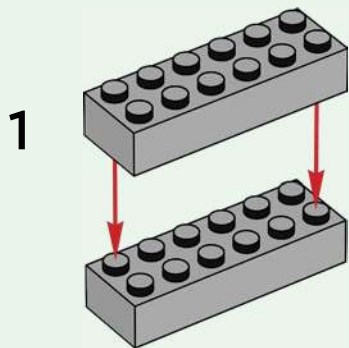







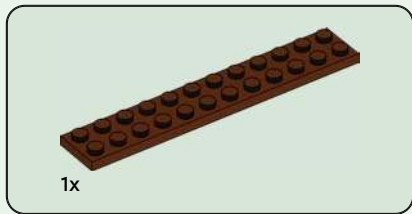

33

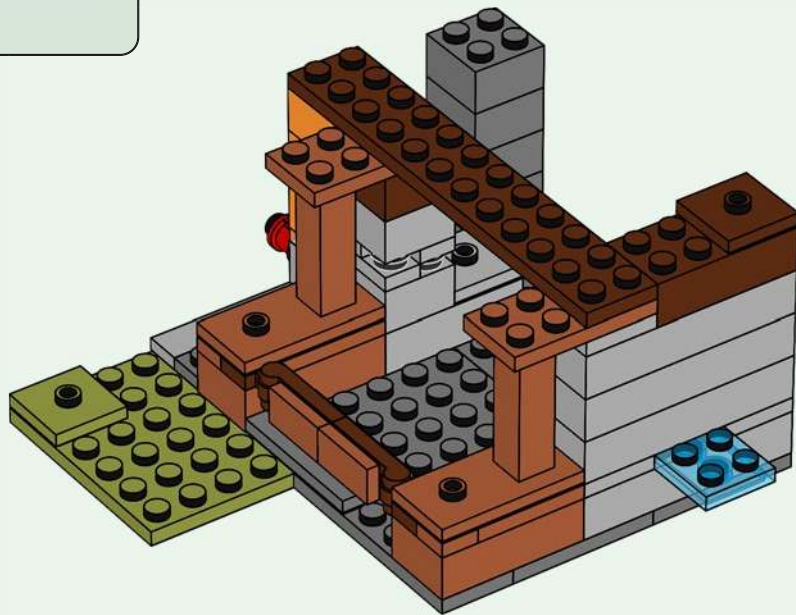

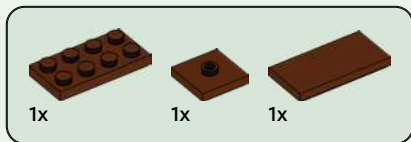

34

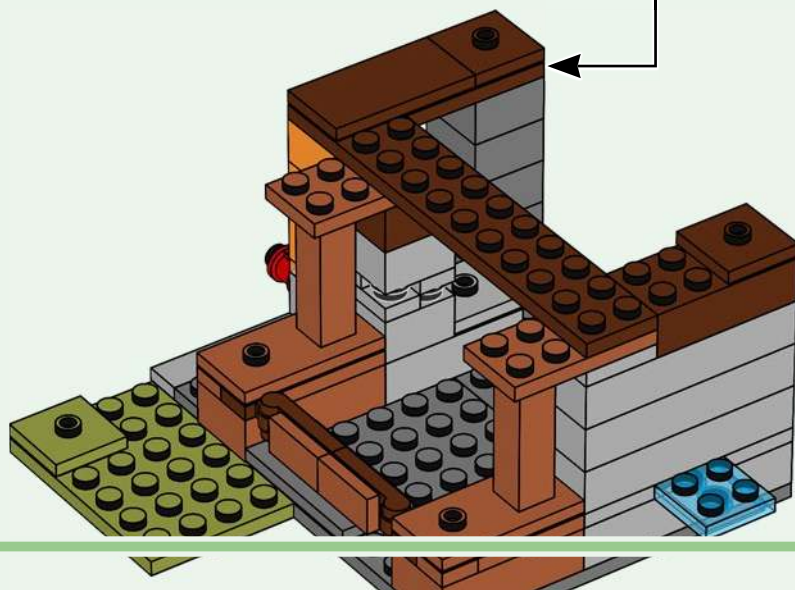
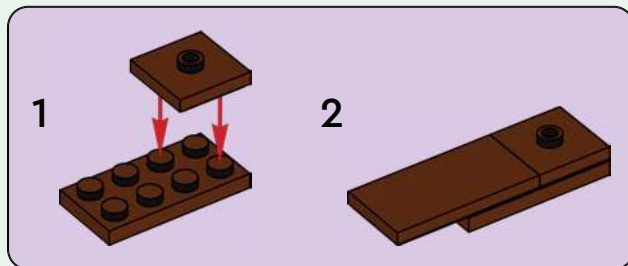



3x

35

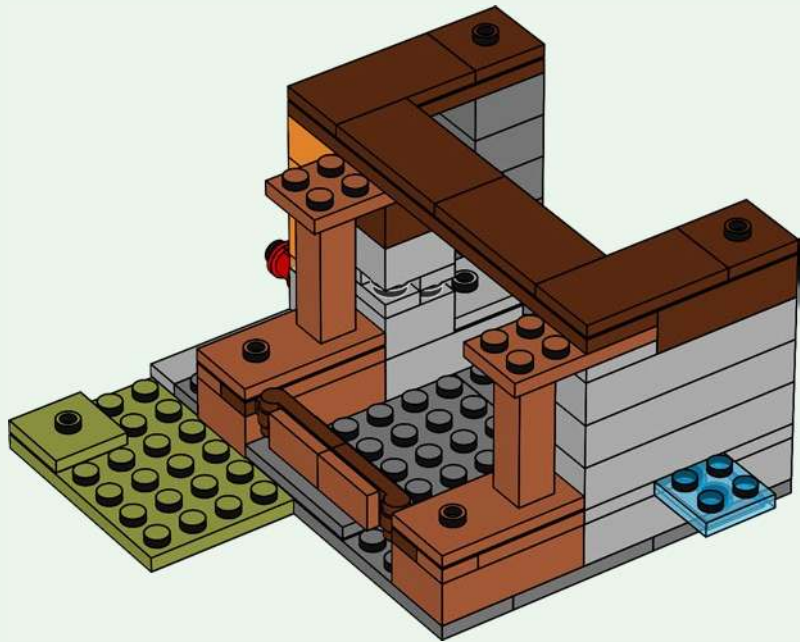

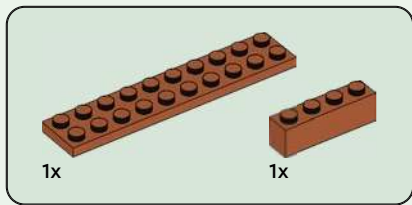

36

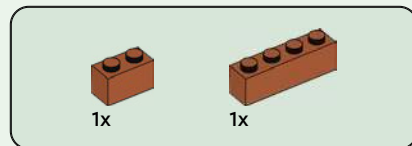
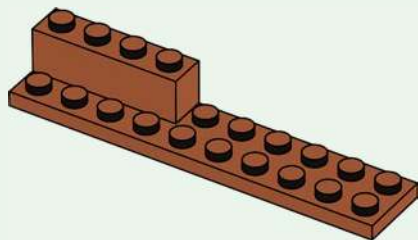

37

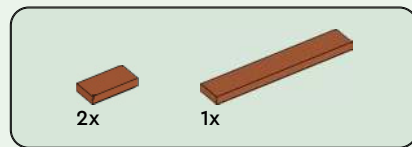
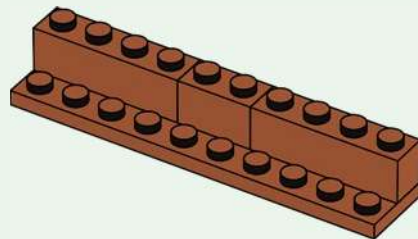

38

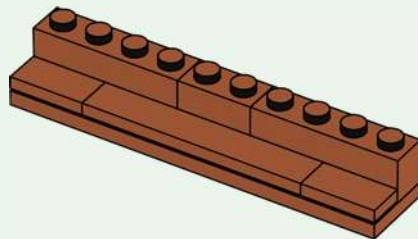

39

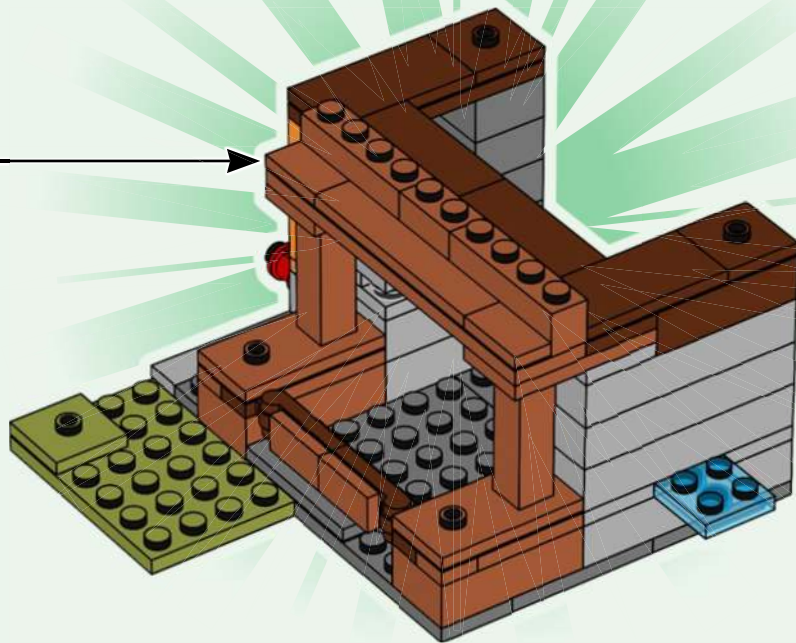

40

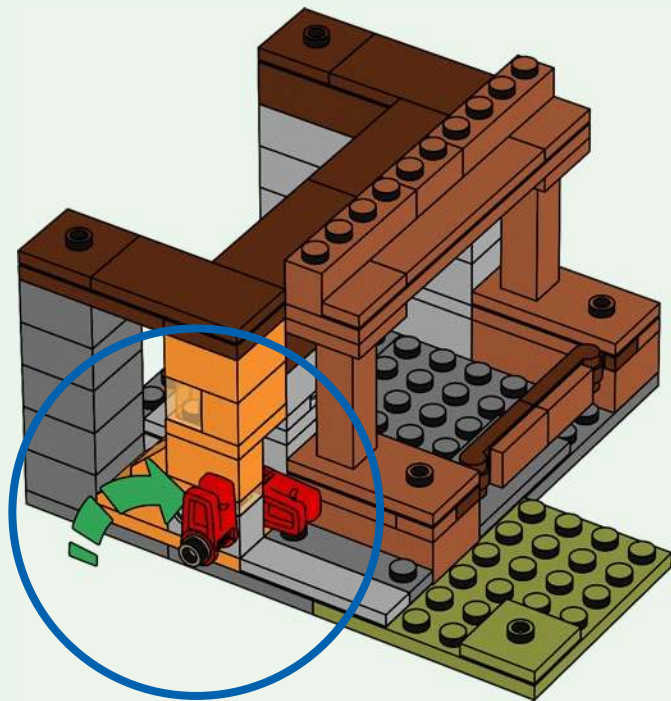
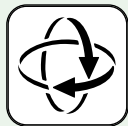

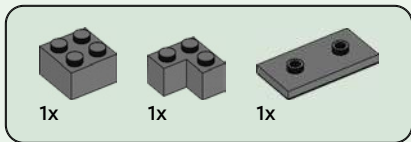

41

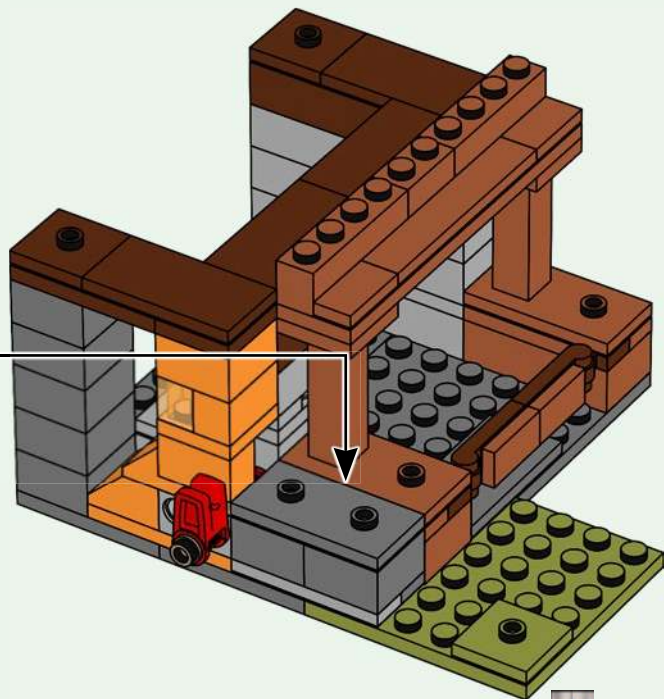
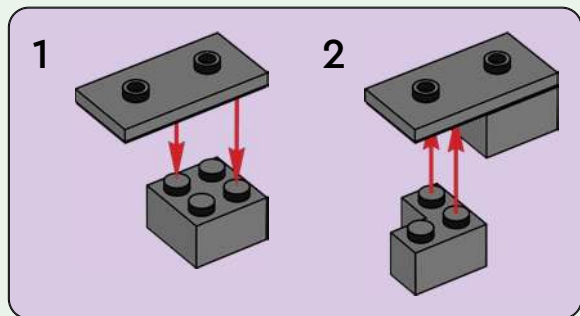



3x



1x

# 42

1

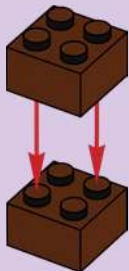

2

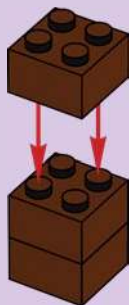

3

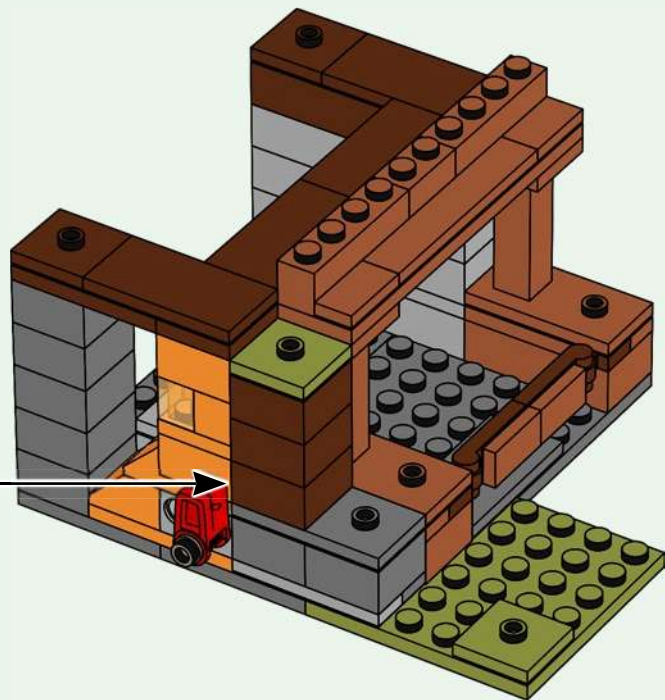

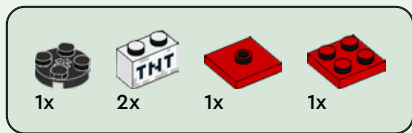

43

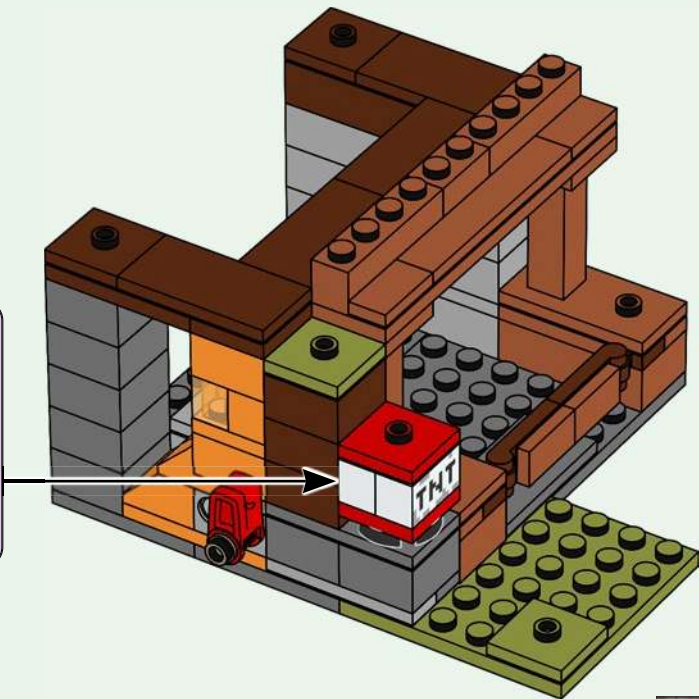
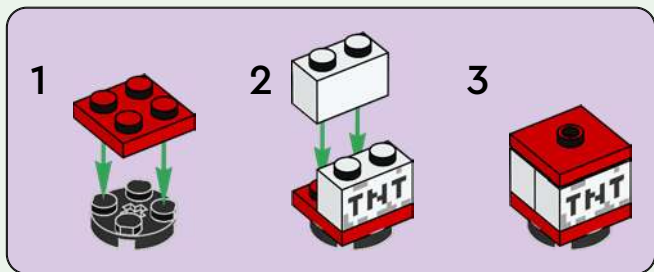

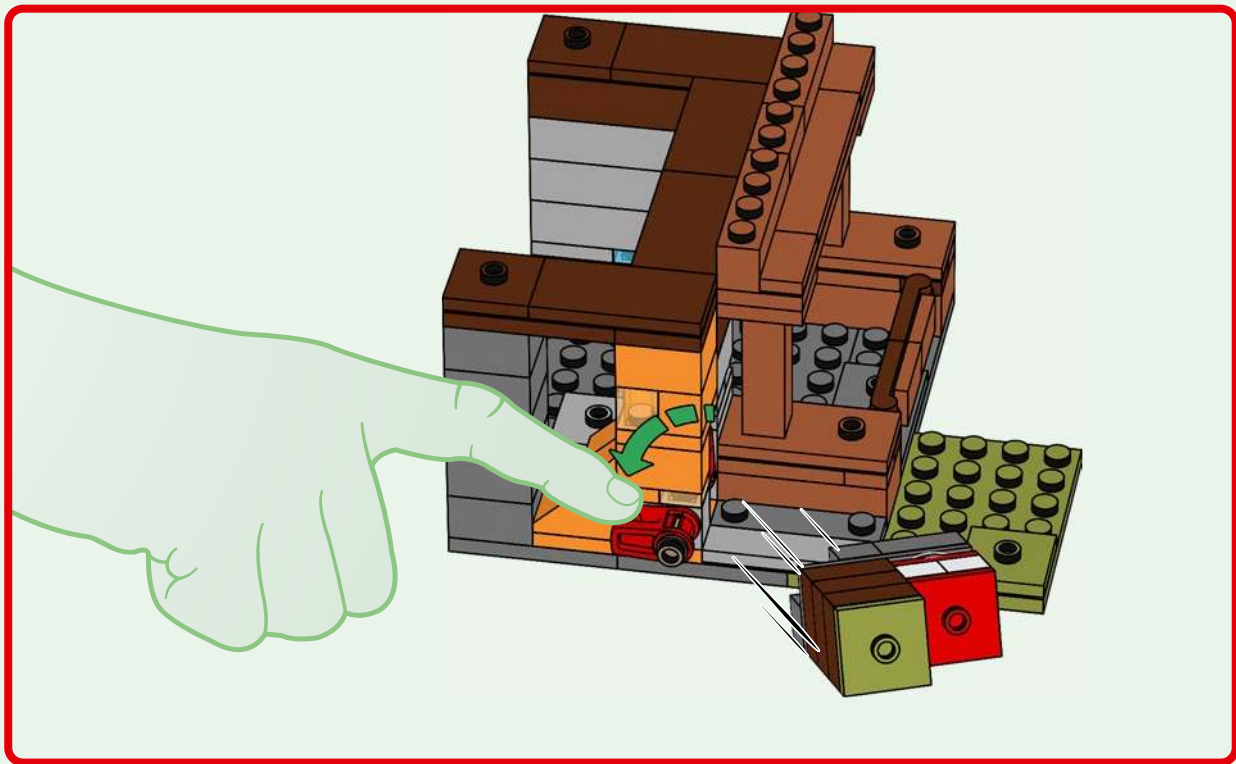

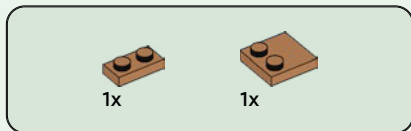

44

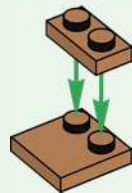



1x

45

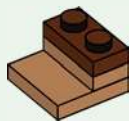

1x

46



1x

47





1x

48



1x

49

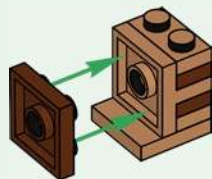

2x

50

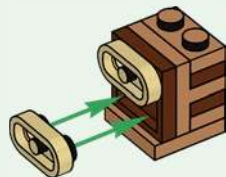



1x

51



1x

52



1x

53

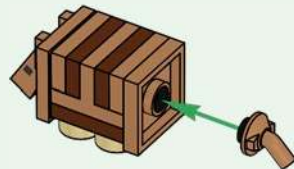

2x

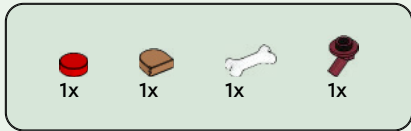

54

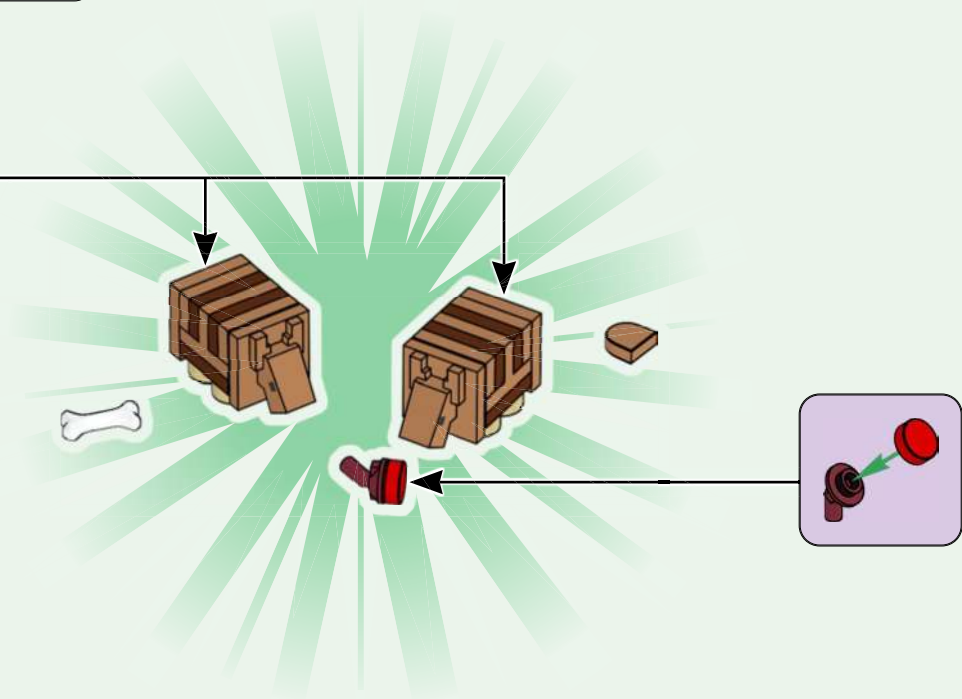



4x



2x



2x

# 55

1



2



3



2x

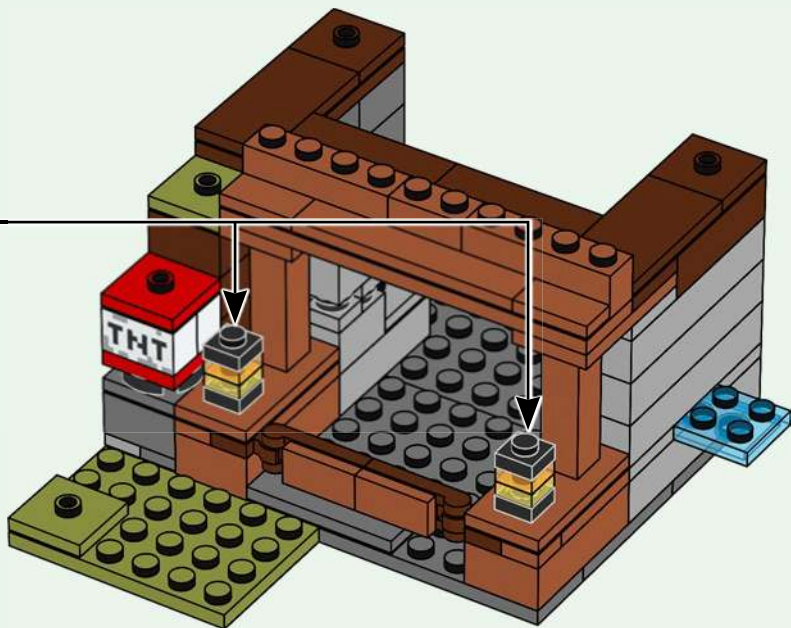

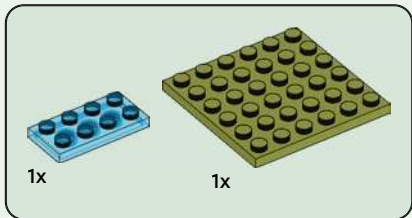
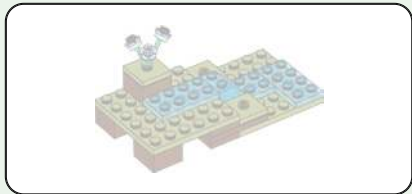

56

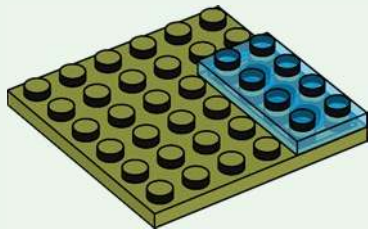



1x

57

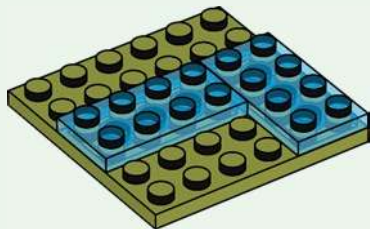

1x

58

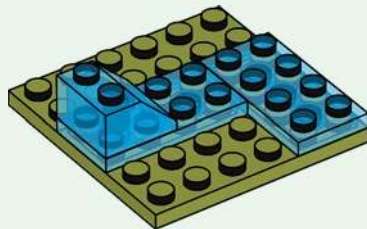

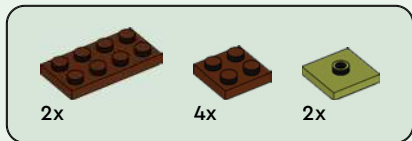

59

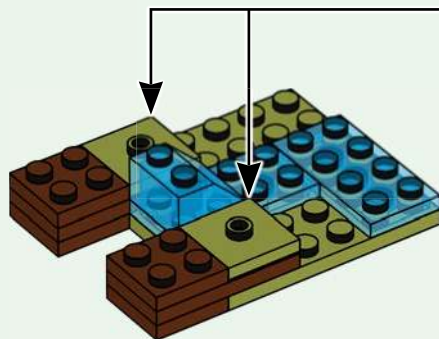
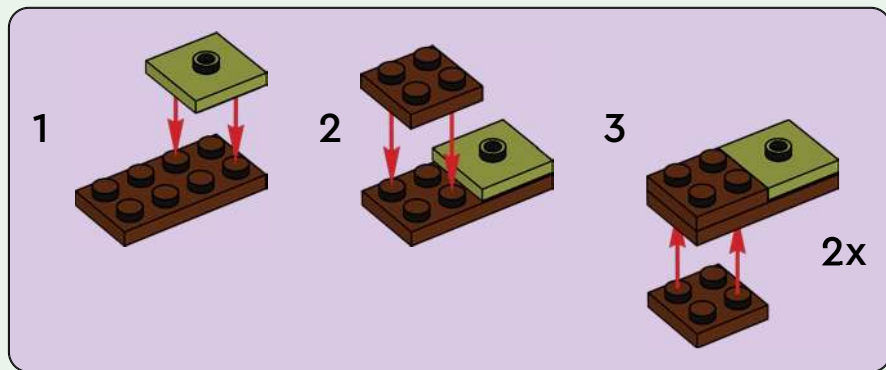

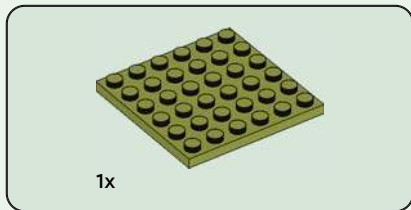

60

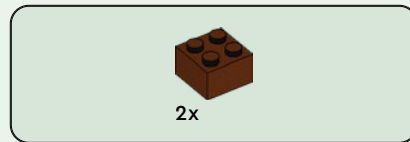
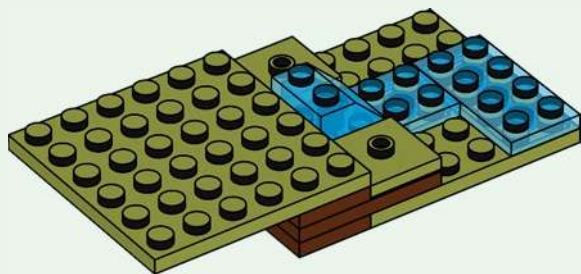

61

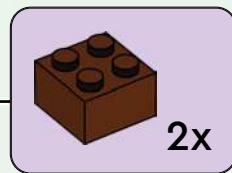
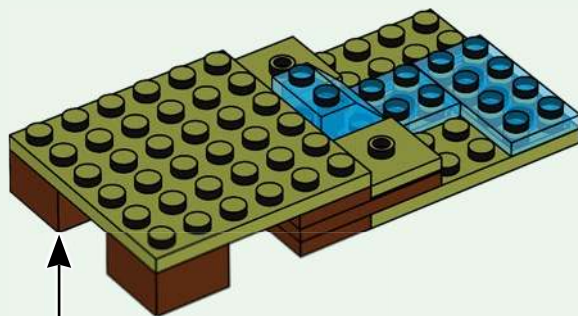



1x

62

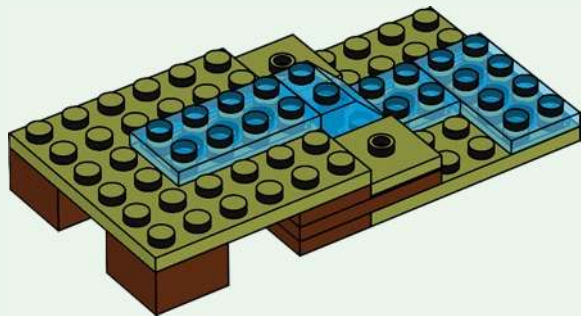

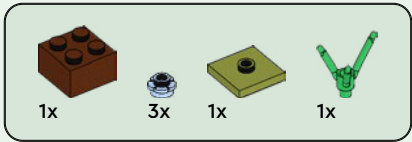

63

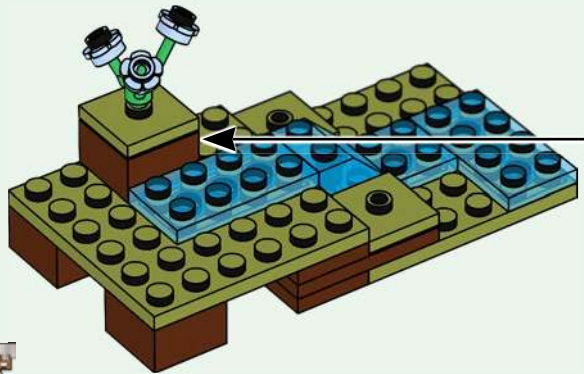
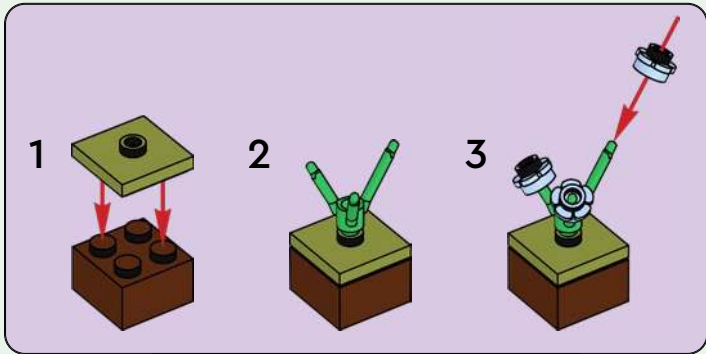

64

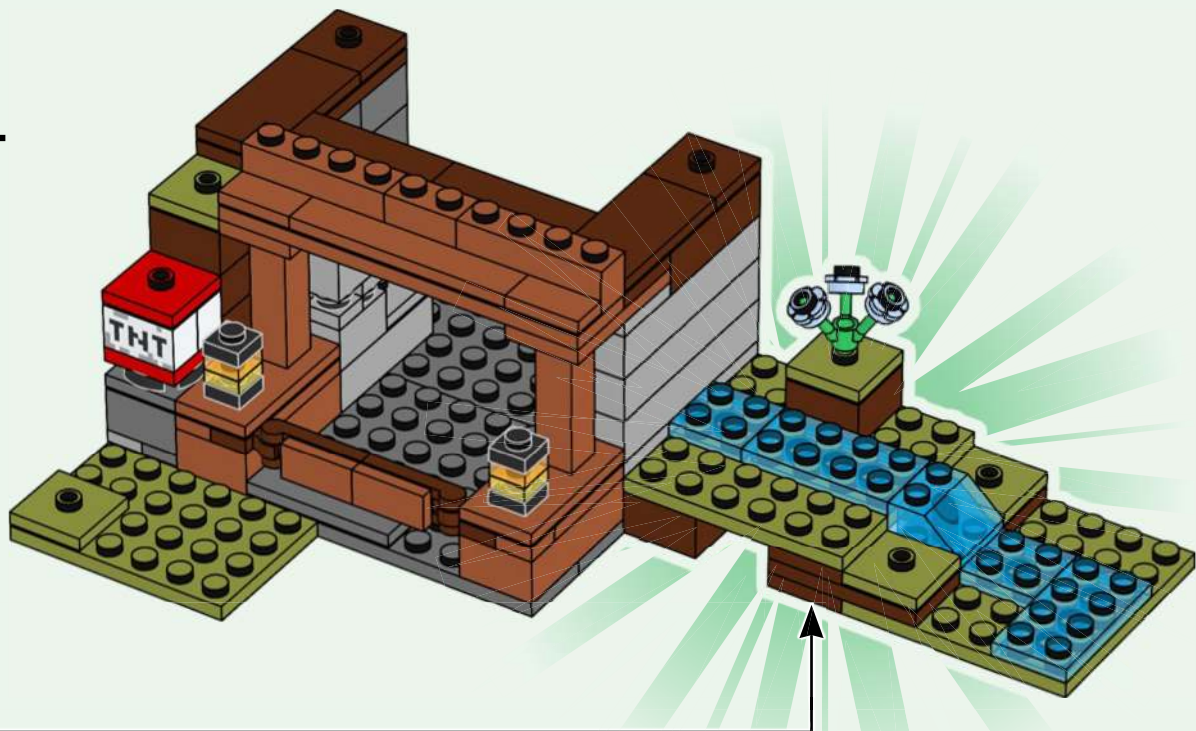



2x



1x

65



1



2

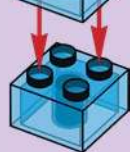

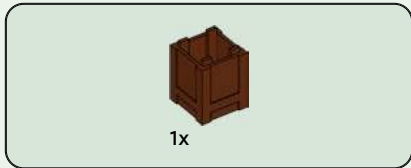

66

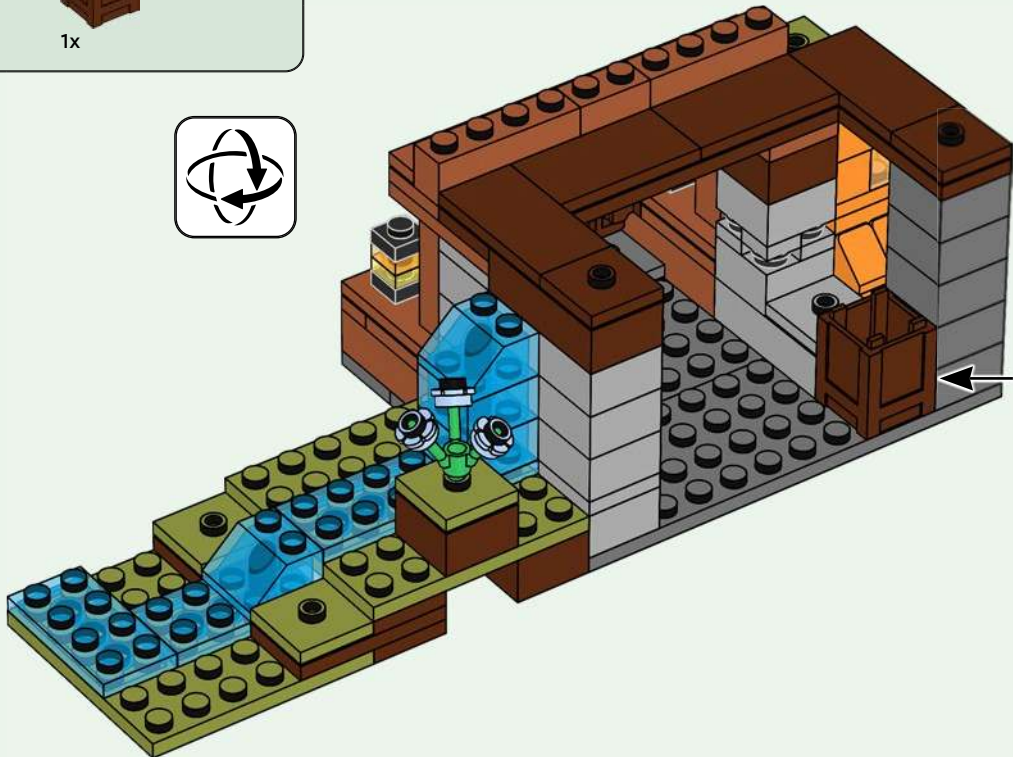
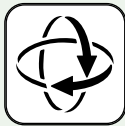

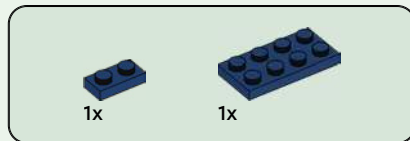

67

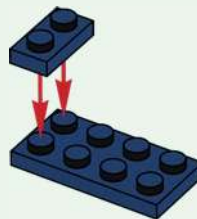



2x

68

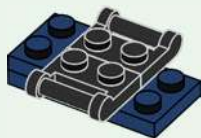

2x

69

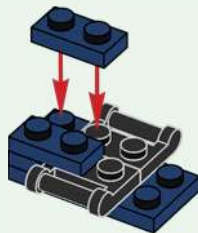

1x

70

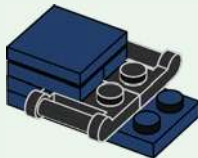



2x



2x

# 71

1



2



2x

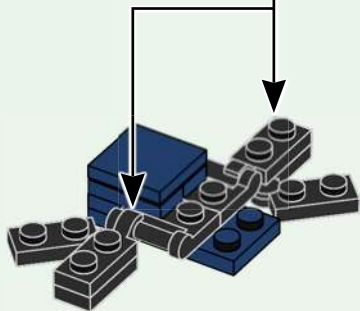

2x



2x

# 72

1

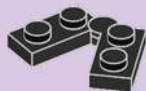

2



2x

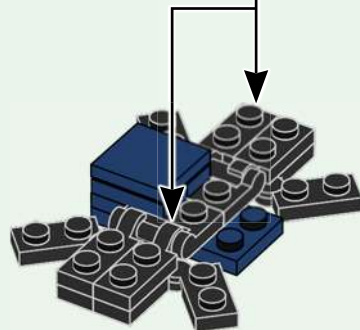



1x

73

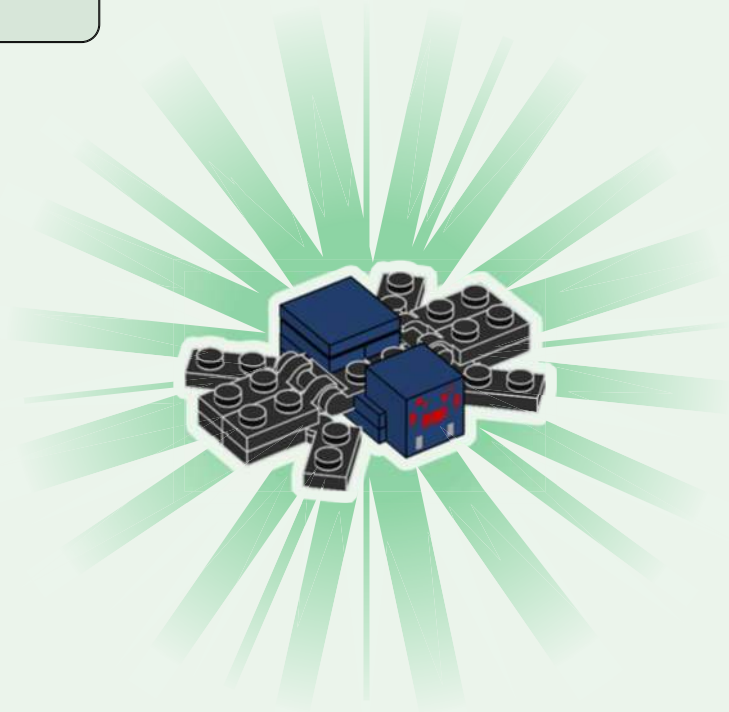

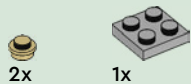

2x

1x

74

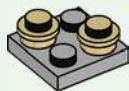

2x

75

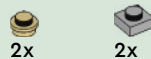
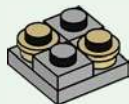

2x

2x

76

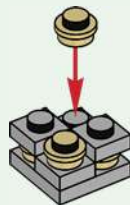

1x

77

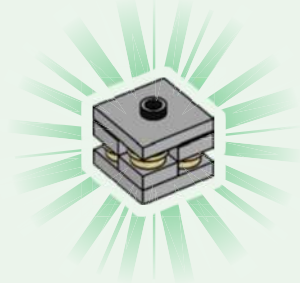

78

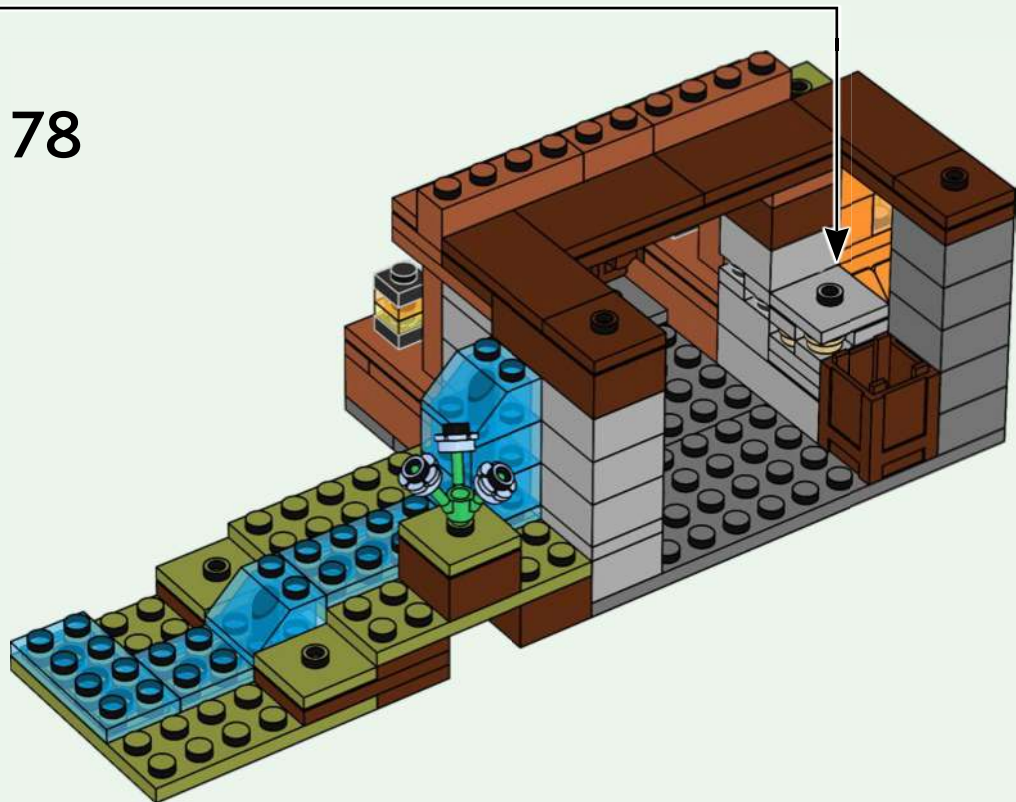



1x



2x

79



2x

80



2x



2x

81

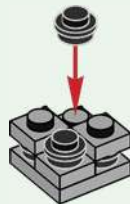

1x

82

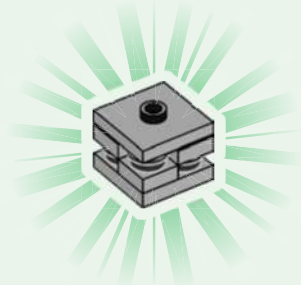

83

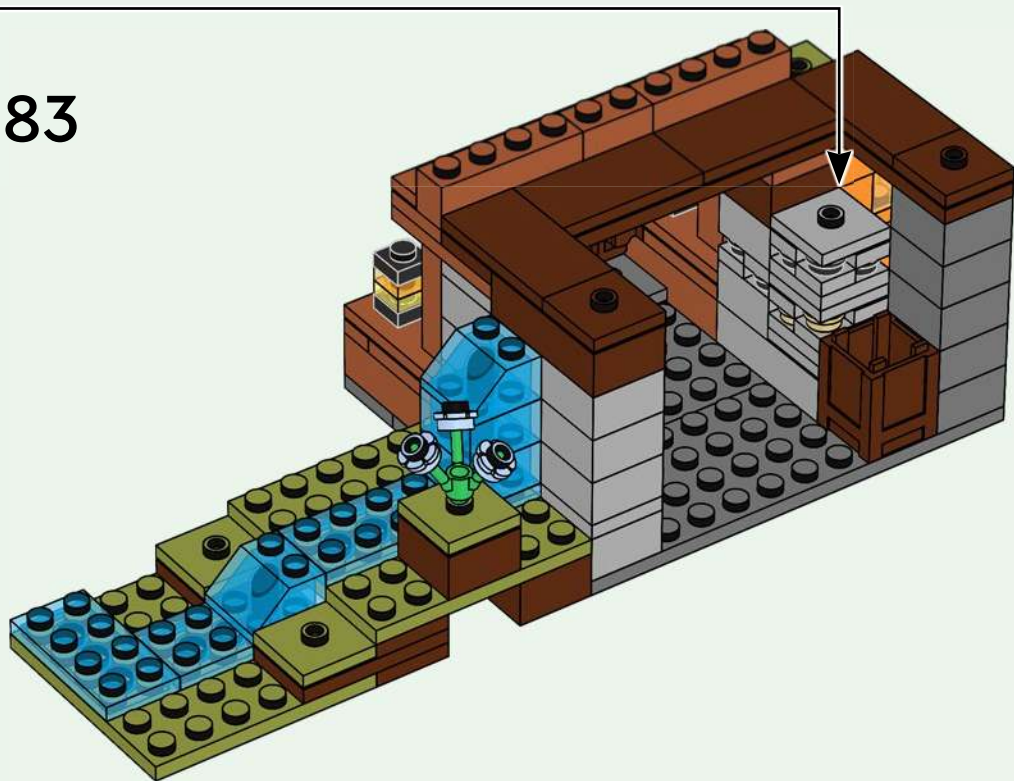



1x



1x

# 84

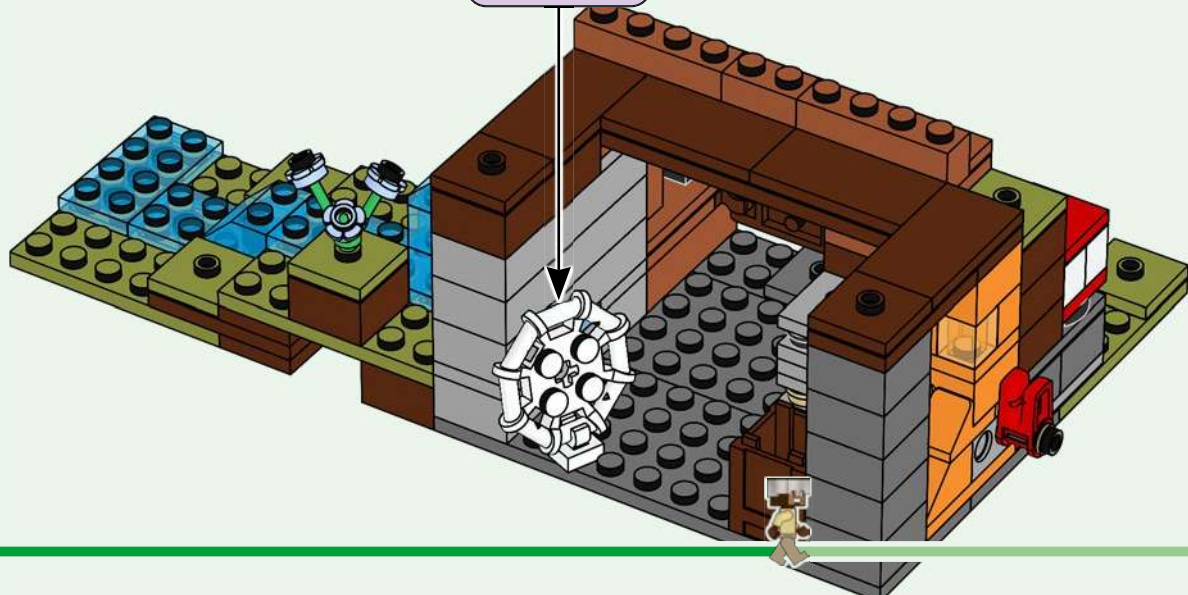
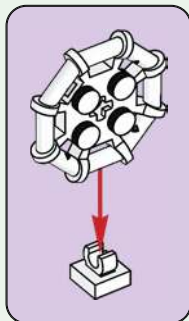

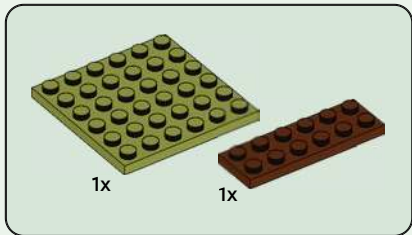
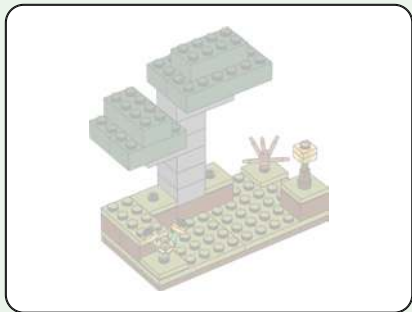

85

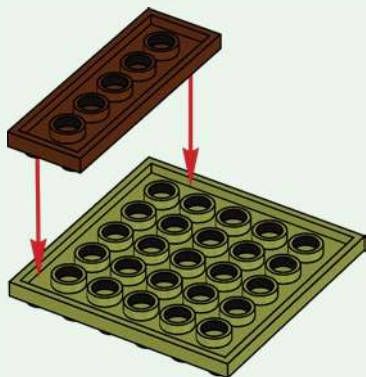

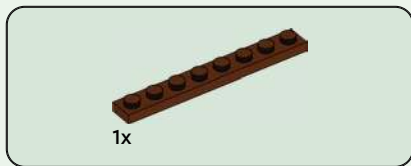

86

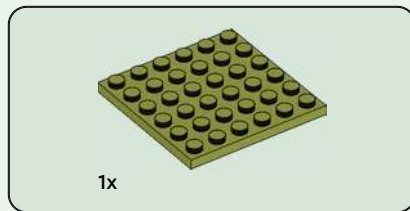
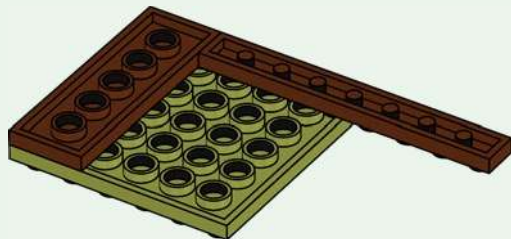

87

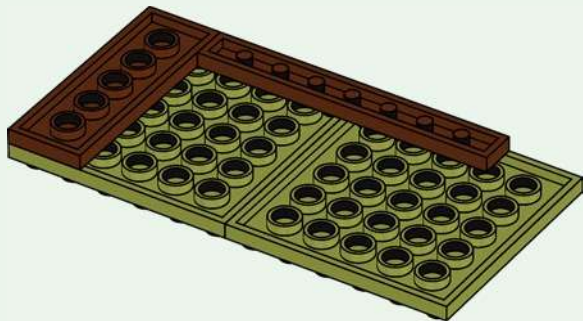

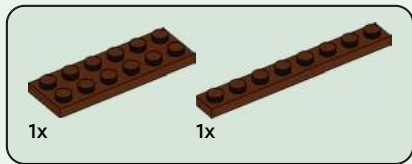

88

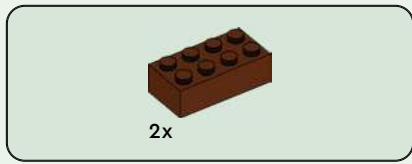
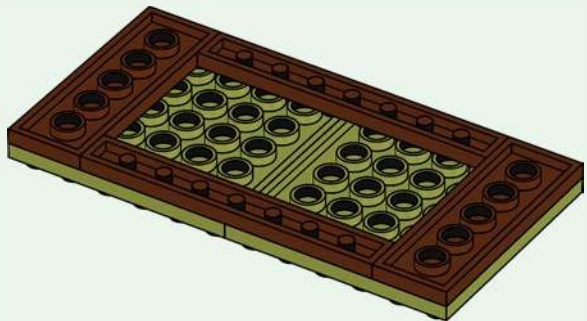

89

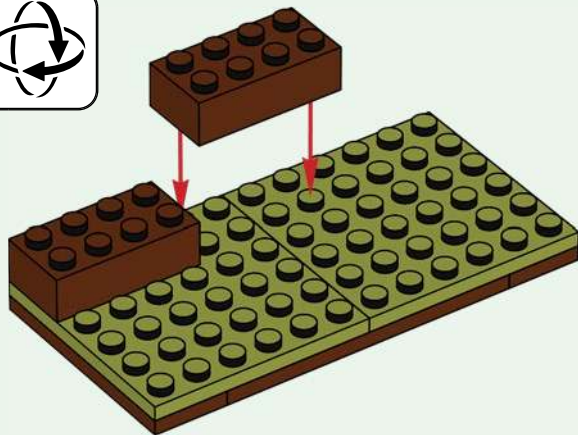

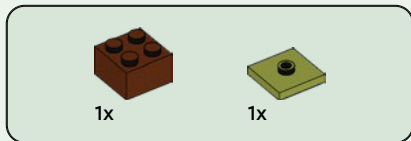

90

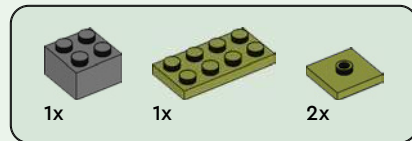
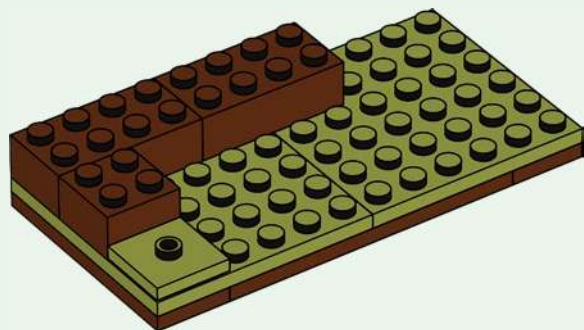

91

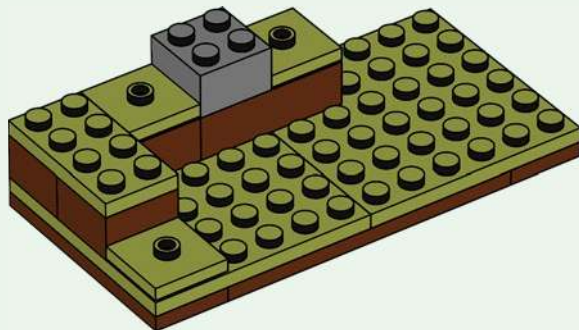

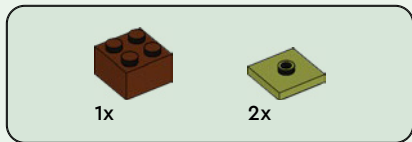

92

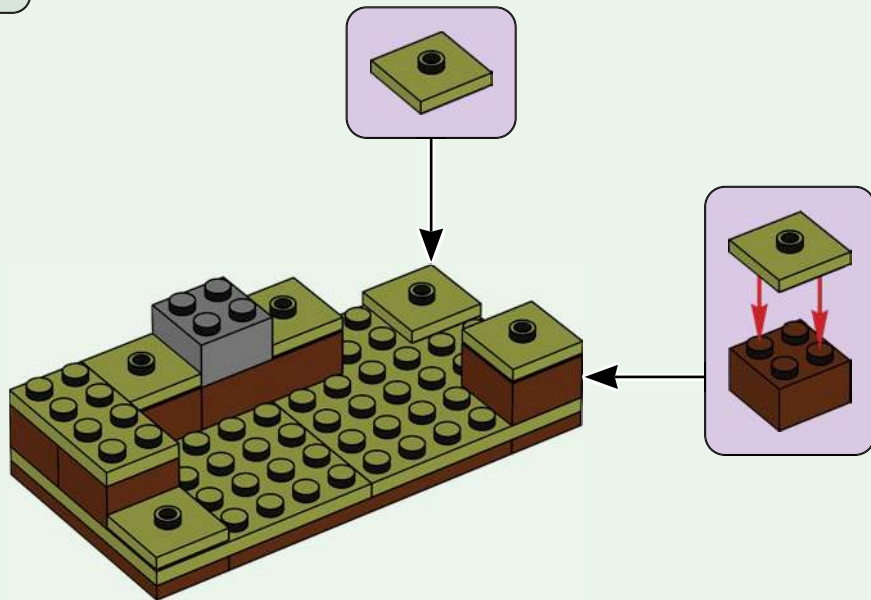

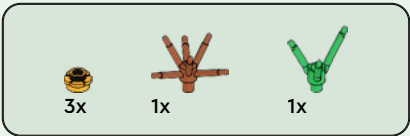

93

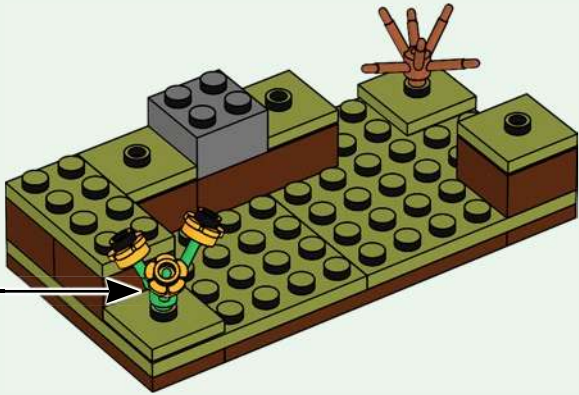
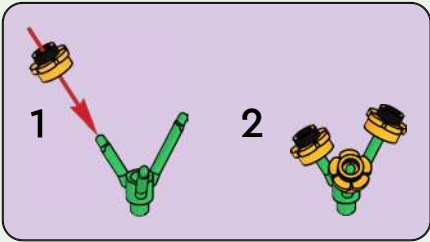



2x

94

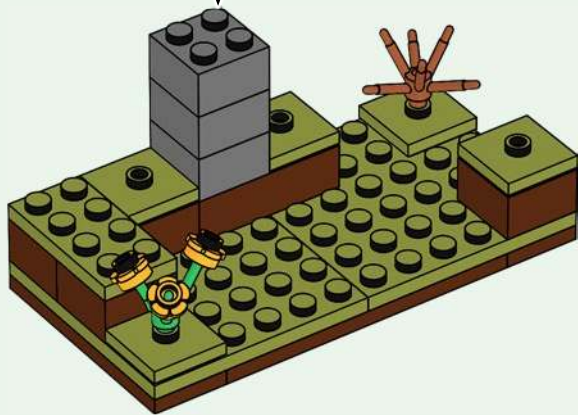
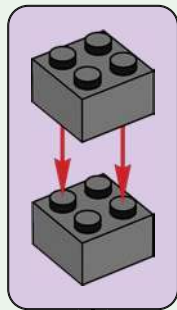

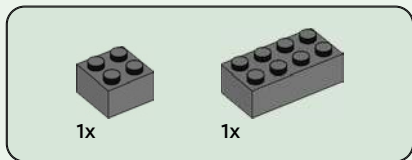

95

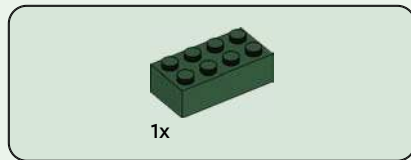
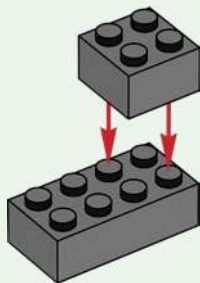

96

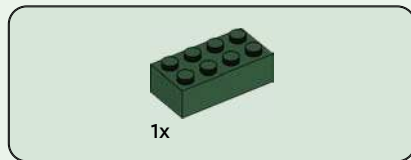
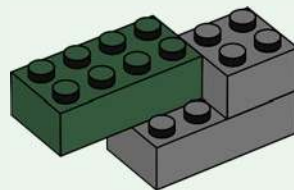

97

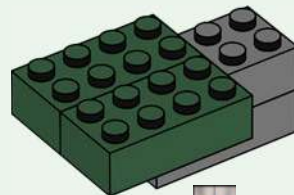

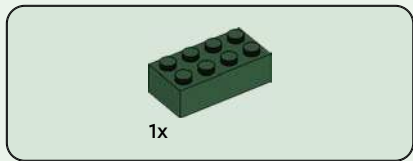

98

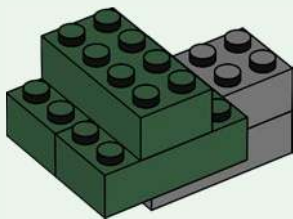

99

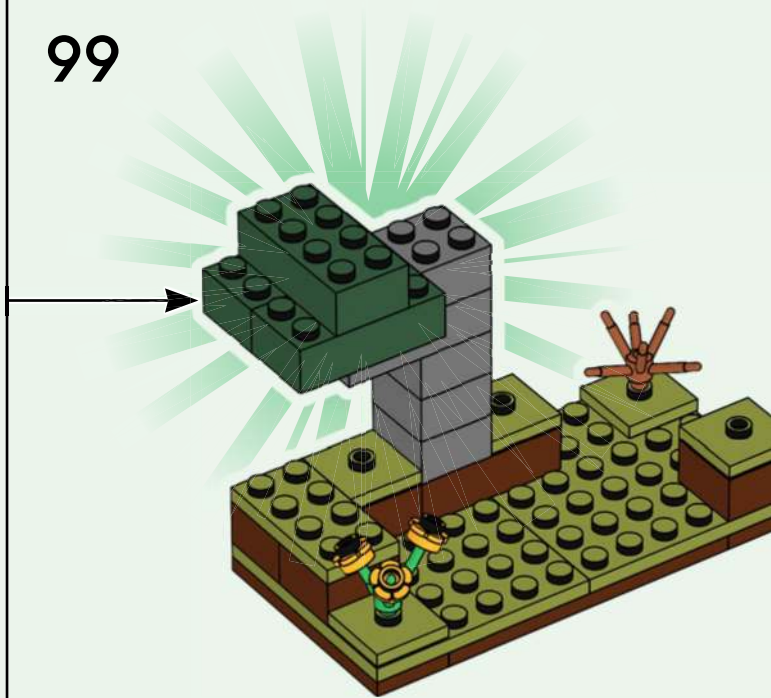

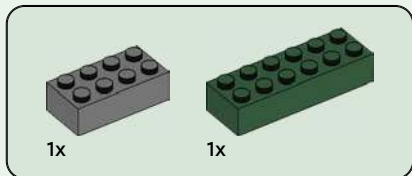

100

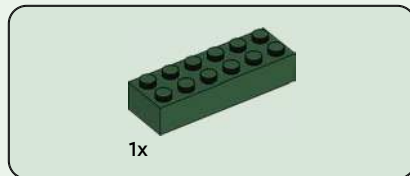
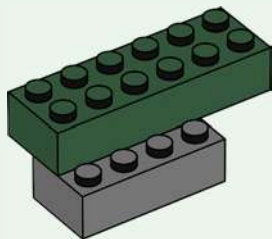

101

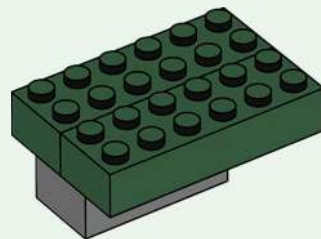

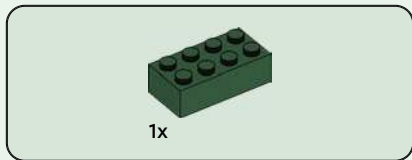

102

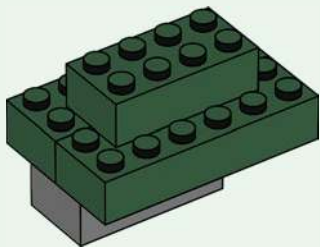

103

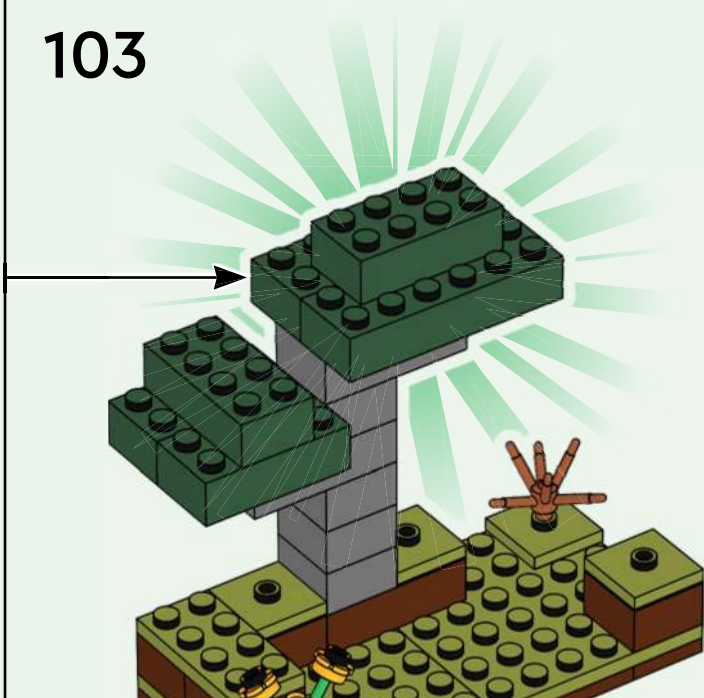



1x



1x



1x

# 104

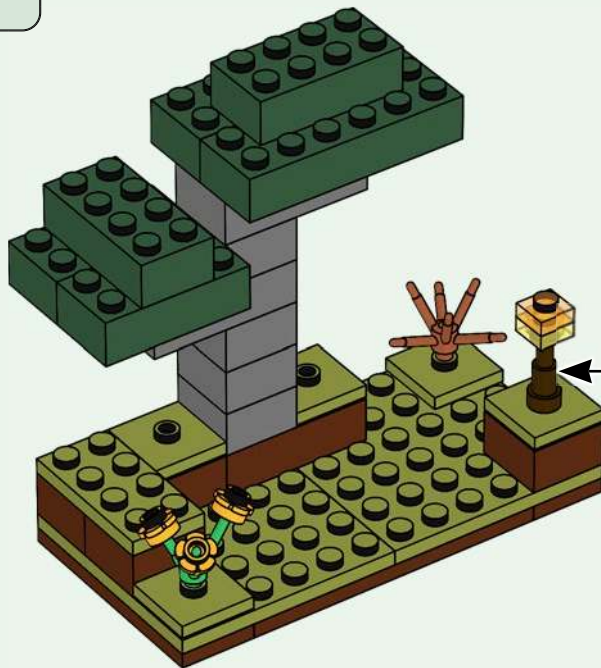

1



2



105

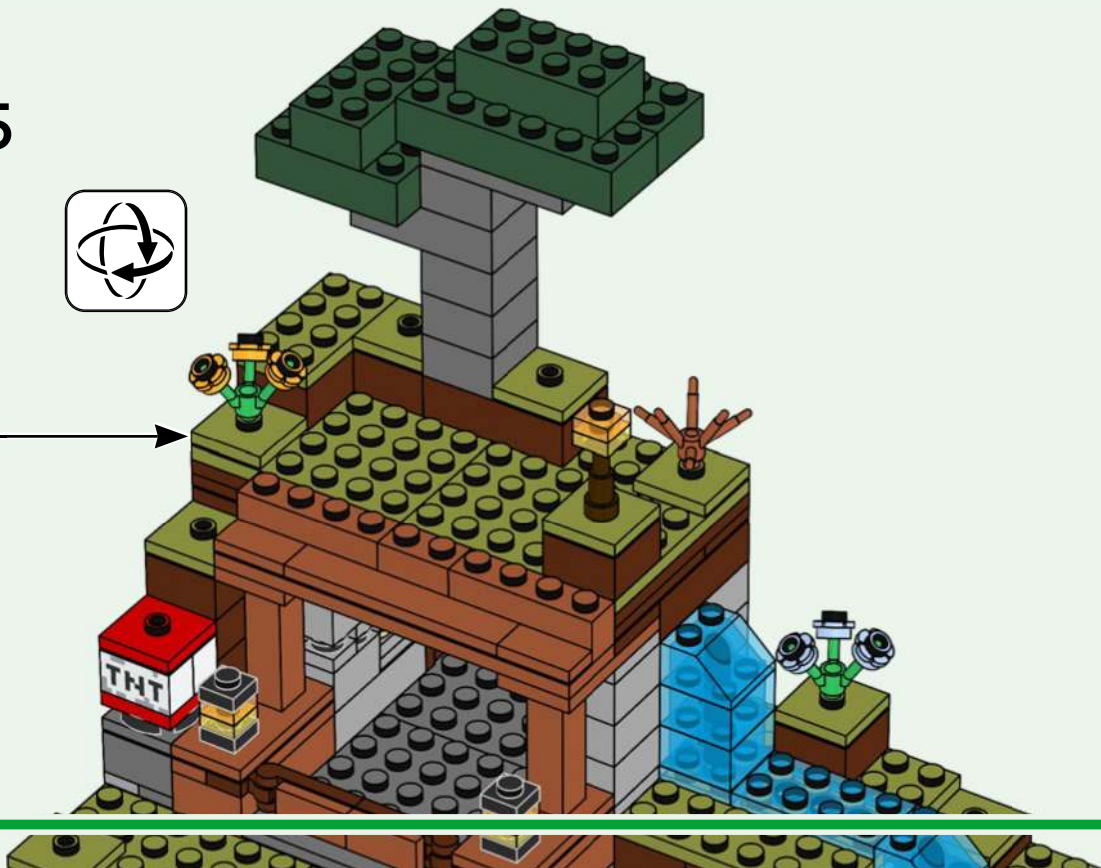





# MINECRAFT



21269



21268



21267





1x  
6348055



1x  
6360202



2x  
6097028



1x  
6009016



4x  
4161734



4x  
6212758



1x  
6529033



1x  
6284574



2x  
6263067



1x  
302221



1x  
6126048



7x  
614126



4x  
302426



1x  
403226



4x  
6336989



2x  
4225201



4x  
6416444



2x  
6269971



2x  
6397875



2x  
6186012



4x  
4614158



1x  
4579659



1x  
6269941



2x  
6359717



2x  
6223040



2x  
6288614



2x  
6487946



2x  
4535928



1x  
6359696



1x  
6351327



2x  
6514091



2x  
6514101



4x  
6513941



3x  
6513966



2x  
6445444



1x  
4153825



1x  
4159007



2x  
6212079



1x  
4118828



1x  
4158355



1x  
6103415



1x  
4524098



1x  
6031821



3x  
4528981



1x  
6528886



1x  
4205004



1x  
4667595



4x  
4260493

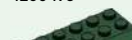

2x  
6215657



1x  
6510194



1x  
6240550



4x  
6513961



3x  
6209681



2x  
6337003



6x  
4211150



1x  
6313124



2x  
4565394



9x  
4211210



7x  
4216695



1x  
4520638



2x  
6102975



3x  
4211201



4x  
4579690



3x  
4211186



1x  
4225700



2x  
4216945



2x  
4211247



10x  
4211399



1x  
4211389



1x  
4211541



4x  
4211398



1x  
6528882



6x  
4211397



3x  
6126082



2x  
4211387



1x  
4211353



1x  
4515369



1x  
4211356



1x  
4211385

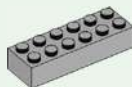

4x  
4211795



3x  
6209683



1x  
6528879



1x  
4538950



2x  
6510192



1x  
6349124



2x  
6528881



4x  
6218360



2x  
6313599



2x  
6528998



3x  
6102994



1x  
6104264



1x  
6214216



10x  
6212080



1x  
6020144



5x  
6528997



10x  
4211060



1x  
4211109



1x  
6257592



2x  
6307616



2x  
4211085



1x  
4211002

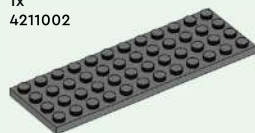

2x  
4210706



 [LEGO.com/service](https://www.LEGO.com/service)

YOU COULD  
**WIN**

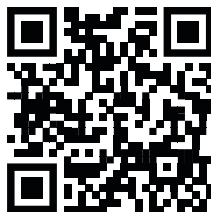

Scan this QR code or go to  
**LEGO.COM/PRODUCTFEEDBACK** and give  
us your short feedback about this LEGO® set  
for a chance to win a cool LEGO prize.

Terms and Conditions apply\*

**EN: YOU COULD WIN.** Terms and Conditions apply\* **DE: Du könntest GEWINNEN.** Es gelten die Teilnahmebedingungen\* **FR: Tu pourrais GAGNER.** Des conditions s'appliquent\* **IT: Potresti VINCERE tu.** Termini e condizioni sono applicabili\* **ES: Puedes GANAR.** Aplican términos y condiciones\* **PT: Poderá GANHAR.** Aplicam-se termos e condições\* **ZH: 轻松获奖. 条款和条件适用\*** **PL: Szansa na WYGRANĄ.** Obowiązują warunki korzystania\* **CS: Máte šanci VYHRÁT.** Platí všeobecné smluvní podmínky\* **SK: Máte šancu VYHRAŤ.** Platia všeobecné zmluvné podmienky\* **HU: TE IS NYERHETSZ.** Felhasználási feltételek érvényesek\* **RO: Ai putea CÂȘTIGA.** Se aplică termeni și condiții\* **BG: Можете да СПЕЧЕЛИТЕ.** Има определени правила и условия\* **LV: Tu vari LAIMĒT.** Ir spēkā noteikumi un nosacījumi.\* **ET: Sul on võimalus VÕITA.** Kehtivad tingimused\* **LT: Jūs galite LAIMĖTI.** Taikomos sąlygos\*

\*[LEGO.com/productfeedback-terms](https://www.lego.com/productfeedback-terms)

LEGO and the LEGO logo are trademarks of the LEGO Group. ©2025 The LEGO Group.

© 2025 Mojang AB. All Rights Reserved. Minecraft, the Minecraft logo, the Mojang Studios logo and the Creeper logo are trademarks of the Microsoft group of companies.

6556011