



# Friends

42646







LEGO® Builder



LEGO.com/sustainable-packaging



 **FR**  
**DONNEZ**  
OU  
**RECYCLEZ**

 OU  OU 

ASSOCIATION MAGASIN DÉCHÈTERIE

Adresses sur [quefairedemesdechets.fr](http://quefairedemesdechets.fr)

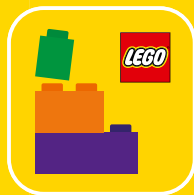

LEGO® Builder

# BUILDER



Apple and the Apple logo are trademarks of Apple Inc., registered in the U.S. and other countries and regions. App Store is a service mark of Apple Inc. Google Play and the Google Play logo are trademarks of Google LLC. Tencent and the Tencent logo are trademarks of Tencent Inc.

LEGO.com/devicecheck

**EN** Ask parents' permission before going online | **DE** Eltern um Erlaubnis bitten, bevor du online gehst | **FR** Demande l'autorisation d'un parent avant d'aller en ligne | **IT** Chiedi il permesso ai tuoi genitori prima di andare online | **ES** Pídeles permiso a tus papás antes de conectarte a Internet | **PT** Pede autorização aos pais antes de acederes online | **ZH** 上网前应先征得父母的同意 | **PL** Poproś rodziców o zgodę, zanim wejdiesz do Internetu | **CS** Než půjdeš na internet, požádej rodiče o svolení | **SK** Skôr než pôjdeš na internet, vypýtaj si povolenie od rodičov | **HU** Kérj szülői engedélyt, mielőtt online csatlakoznál! | **RO** Cere permisiunea părinților înainte de a te conecta online | **BG** Поискайте разрешение от родител, преди да влезете онлайн | **LV** Pirms došanās tiešsaistē palūdz atļauju vecākiem | **ET** Enne Interneti kasutamist küsi vanematelt luba | **LT** Prieš prisijungdami prie interneto, atsiklauskite tėvų



**BUILD IT  
YOUR  
WAY**

**EN** Build It Your Way | **DE** Bau, wie du willst | **FR** Construisez à votre façon | **IT** Costruiscilo come vuoi tu  
| **ES** Constrúyelo a tu manera | **PT** Constrói à Tua Maneira | **ZH** 自由拼搭 | **PL** Zbuduj po swojemu | **CS**  
Postavte to po svém | **SK** Postavte to po svojom | **HU** Építs kedved szerint! | **RO** Construięște așa cum dorești  
| **BG** Постройте го по своя начин | **LV** Būvē tieši tā, kā vēlies | **ET** Ehita enda moodi | **LT** Sukonstruokite savaip



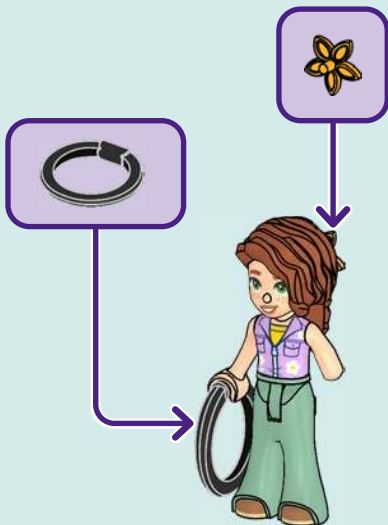
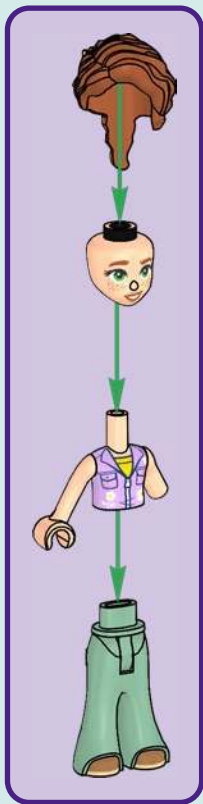

# AUTUMN





1x



1x

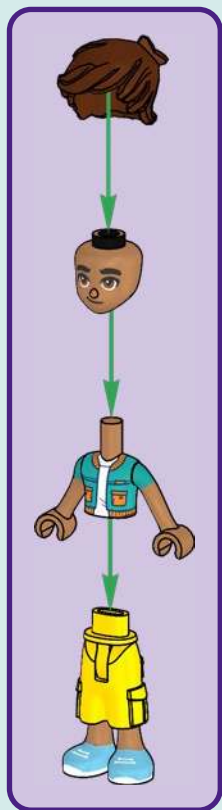

**LEO**



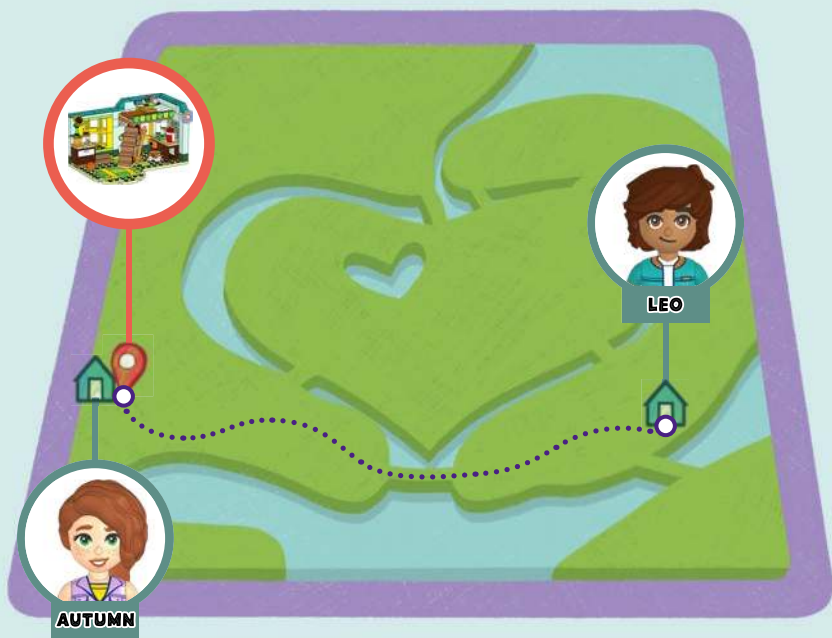

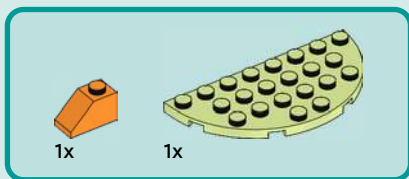

1

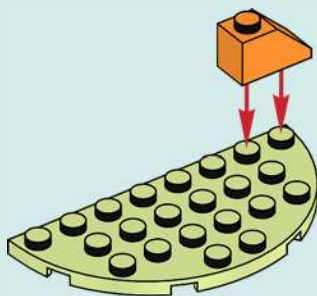



1x



1x

2

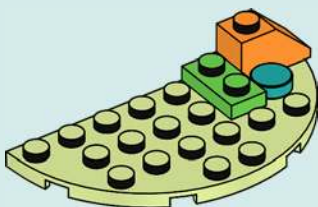

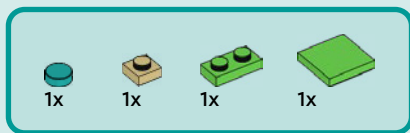

3

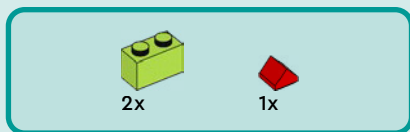
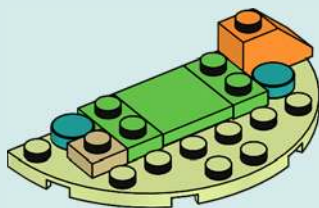

4

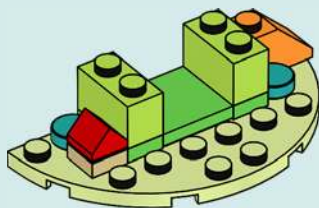



2x

5

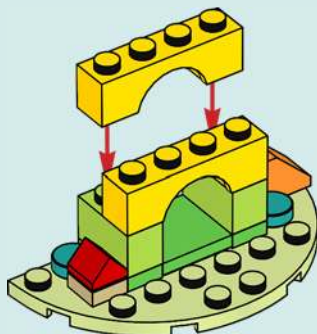



1x

6

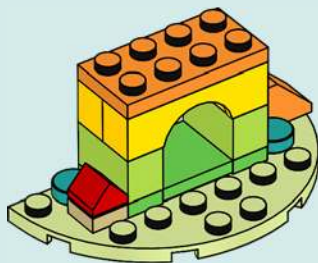

1x



2x

7

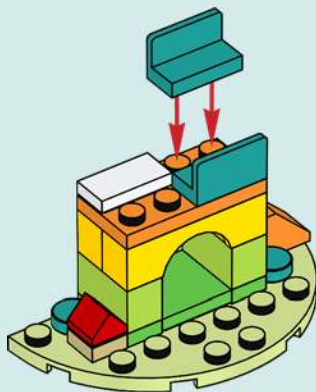



1x



1x

8

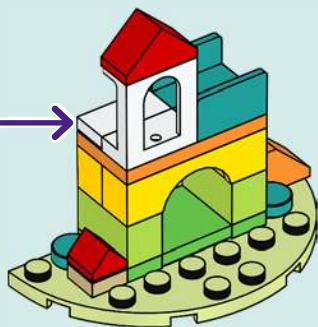
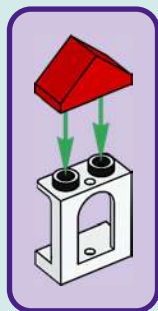



1x



1x

9

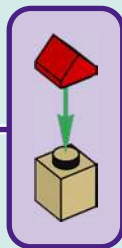
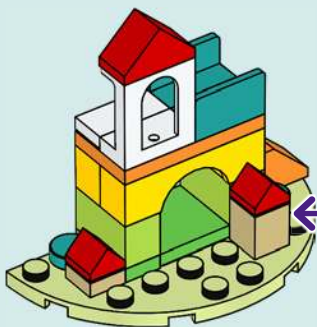



1x



1x

# 10

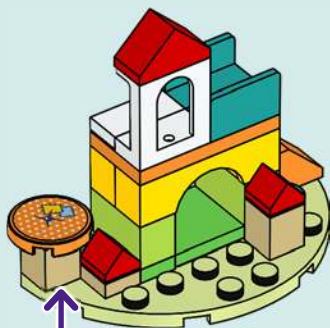

1



2





1x



1x



1x

# 11



1



2





1x

12

**BANDIT**



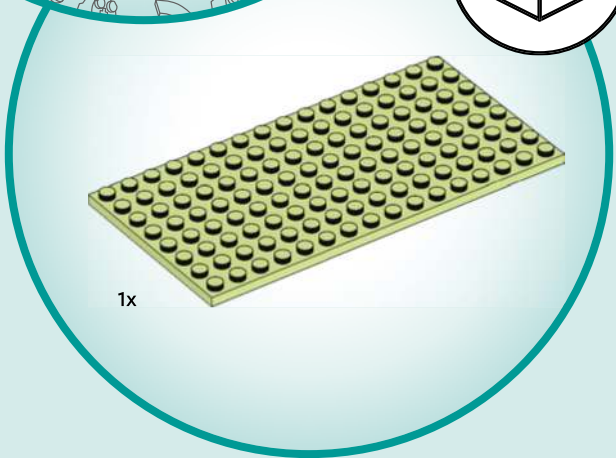
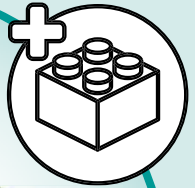
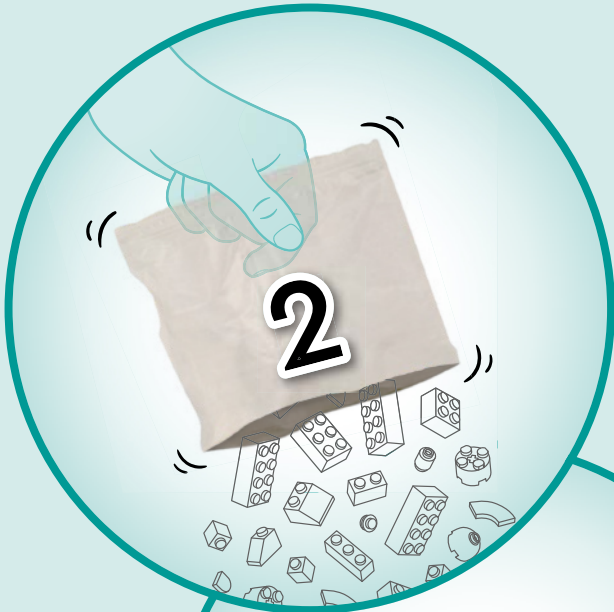

1x

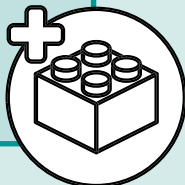
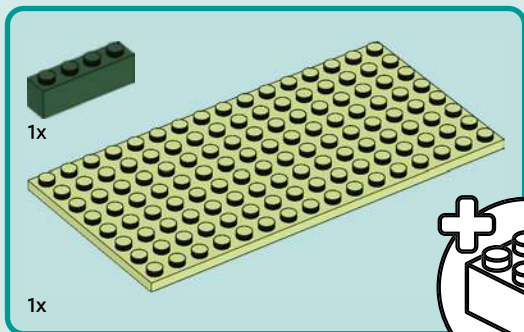

13

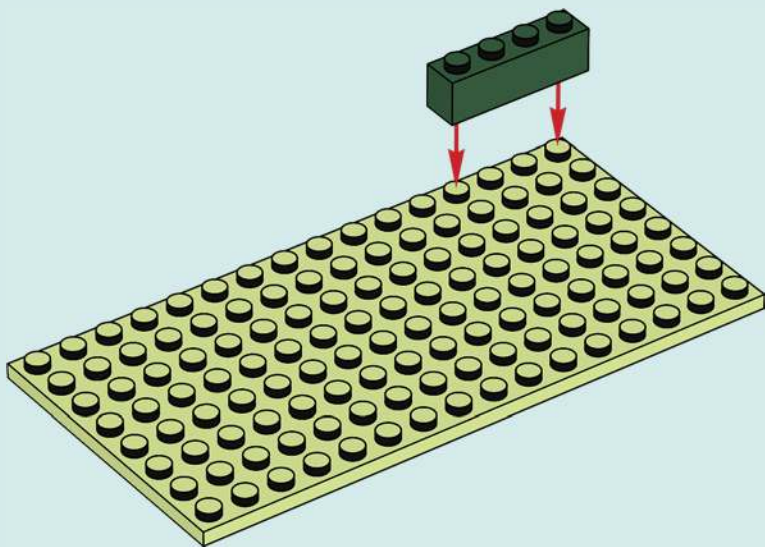

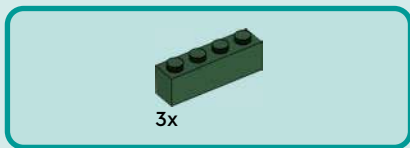

14

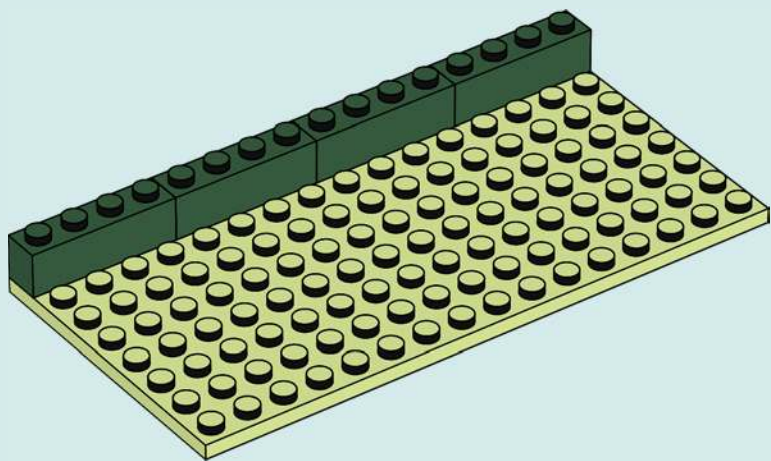

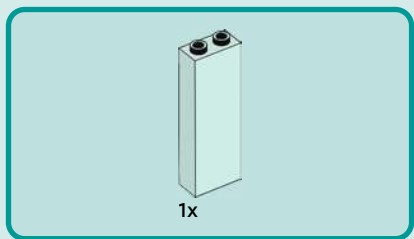

15

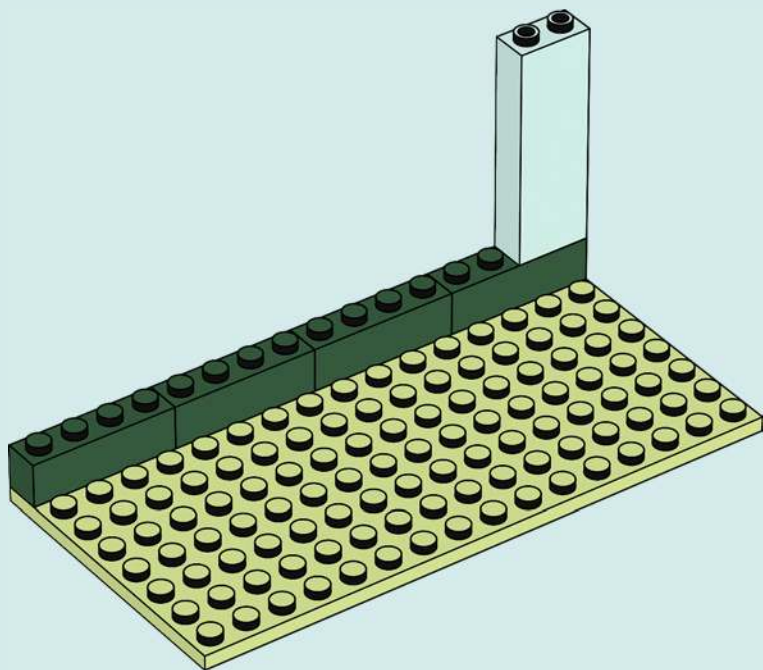

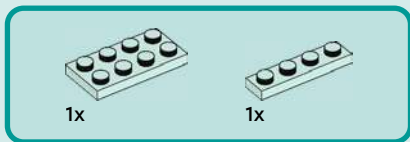

16

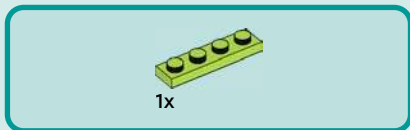
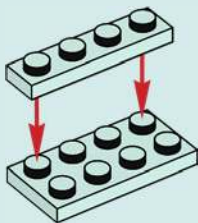

17

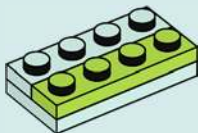

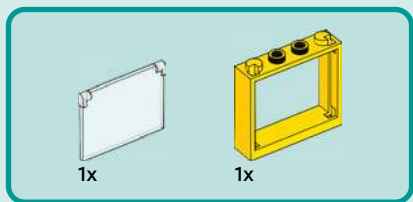

18

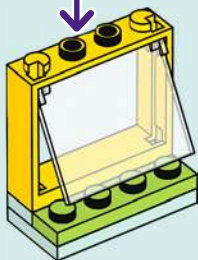
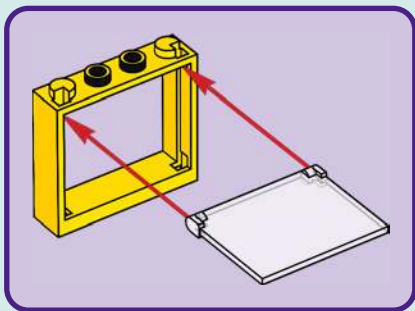



1x



1x

19





1x



1x

# 20

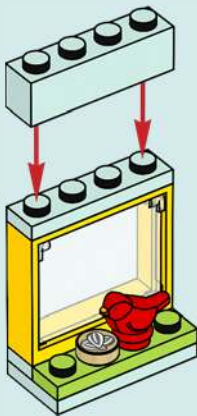

21

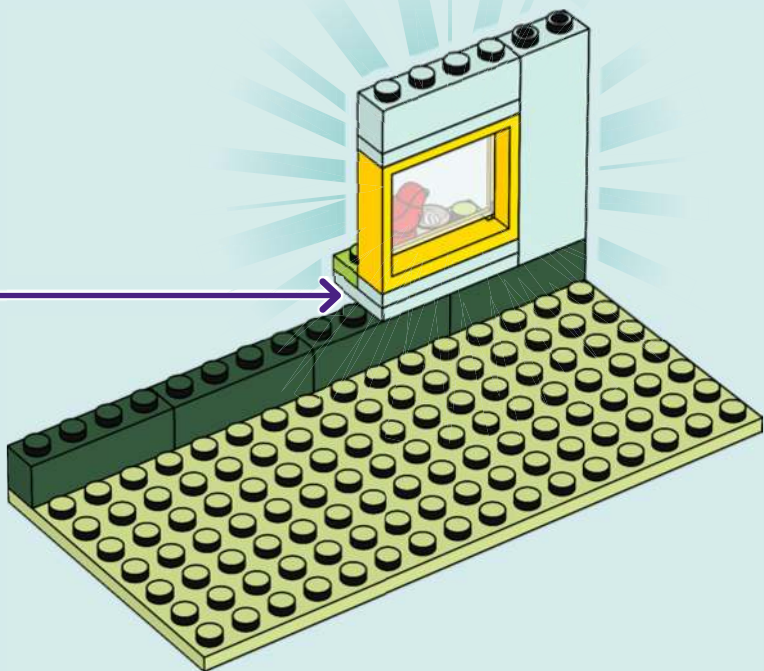

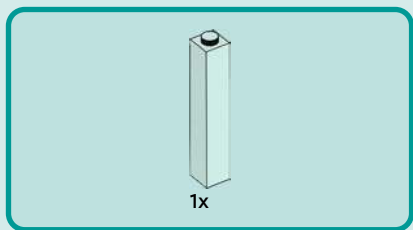

22

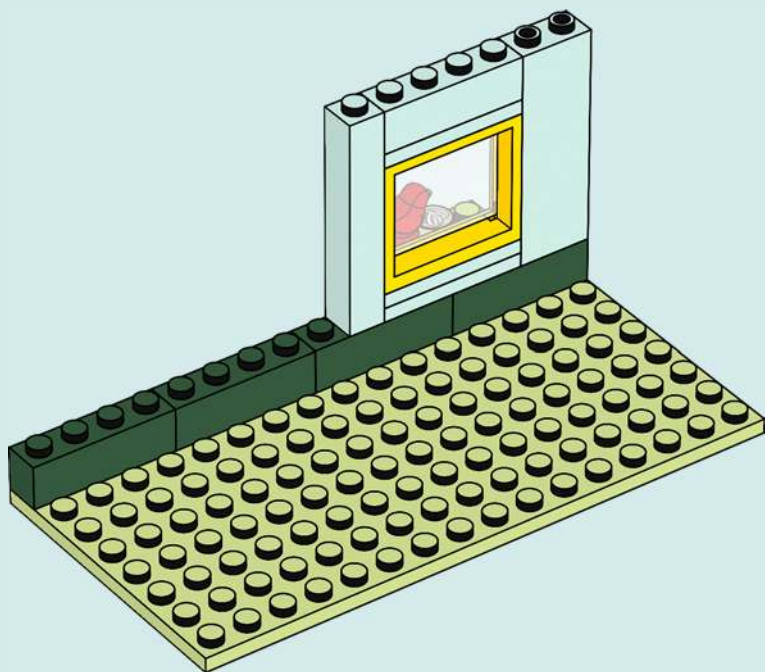

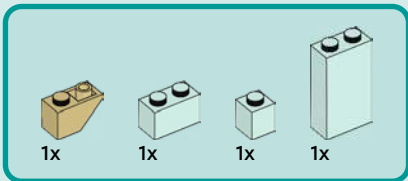
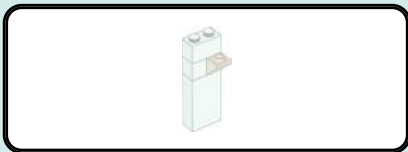

23

1

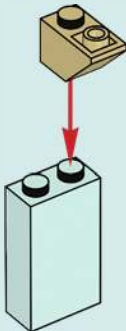

2

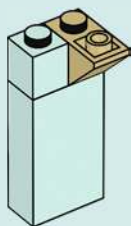

3

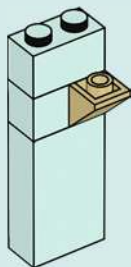

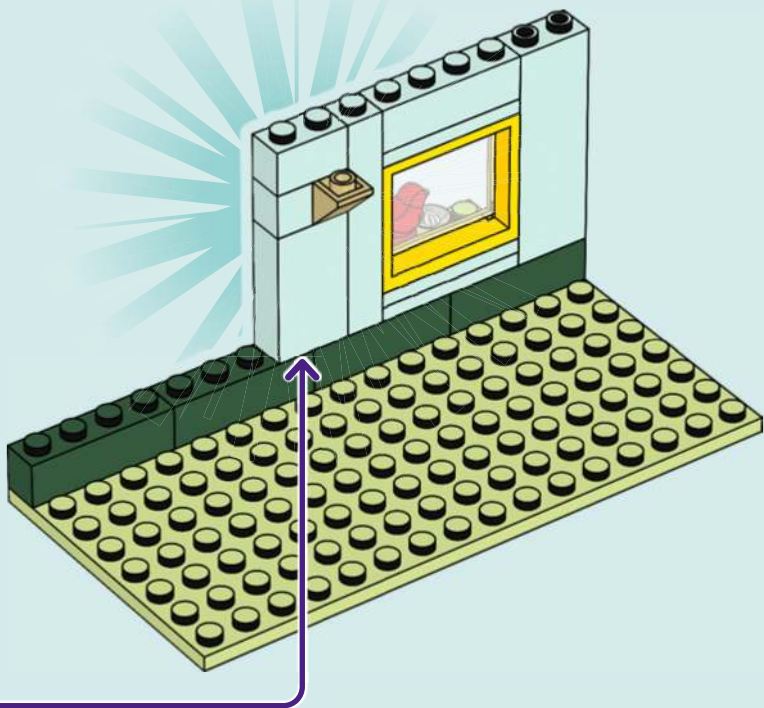

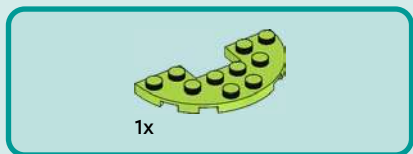
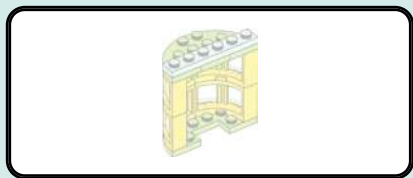

24

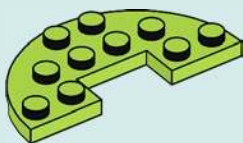

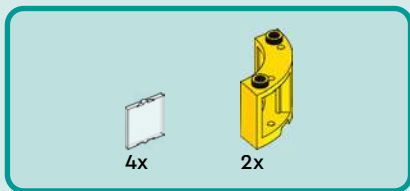

25

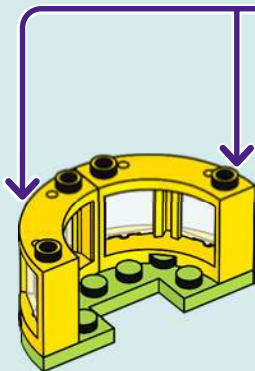
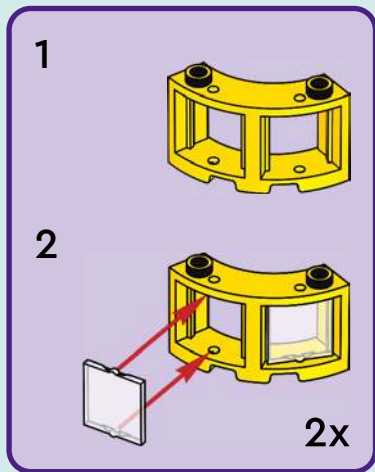

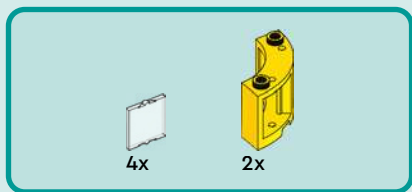

26

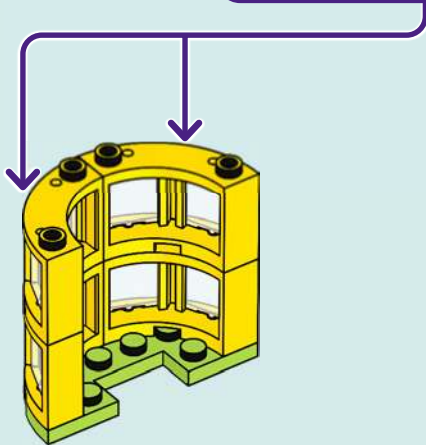
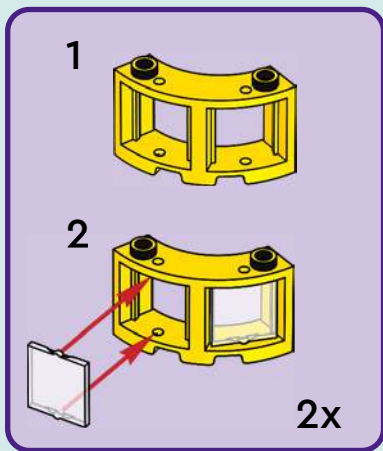



1x

27

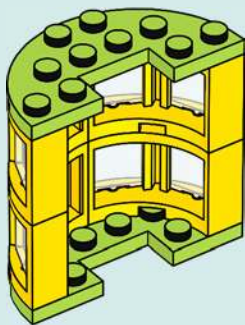

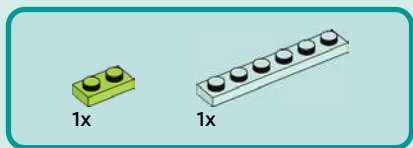

28

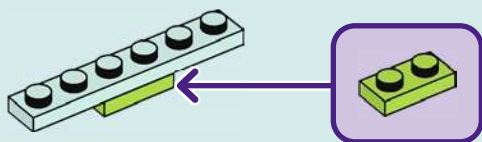

29

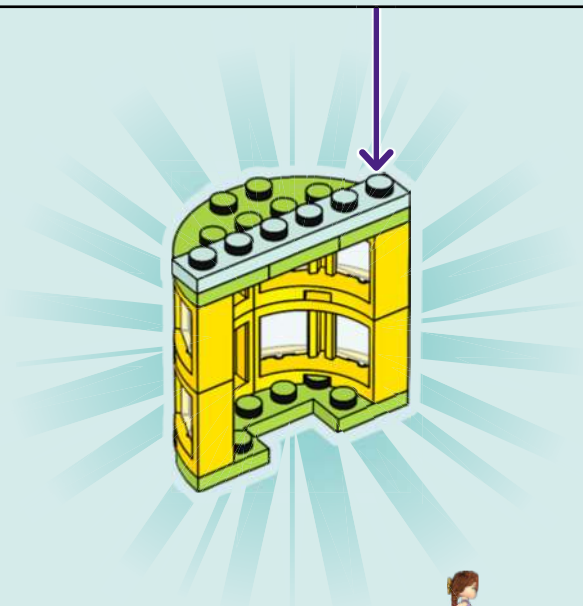

30

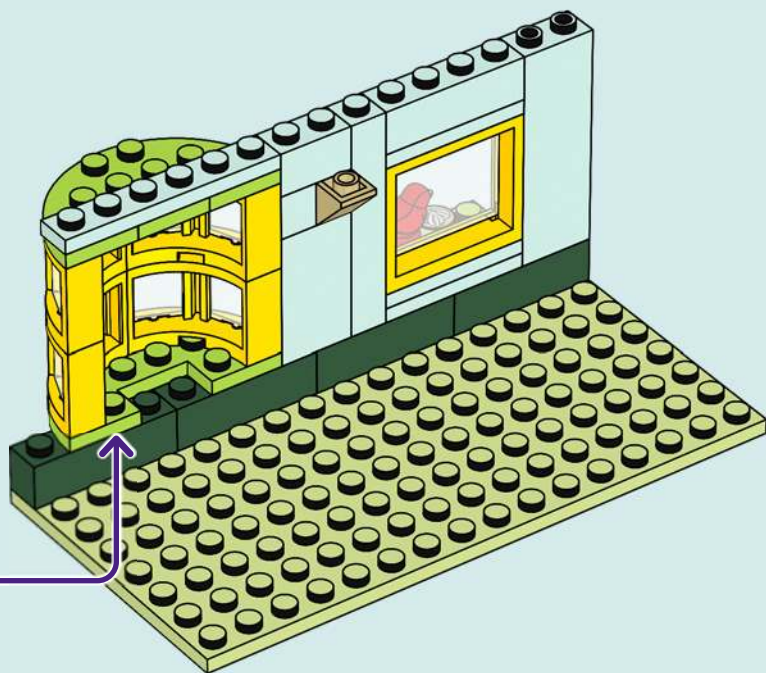



1x



1x

# 31

1

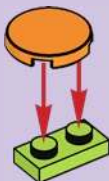

2

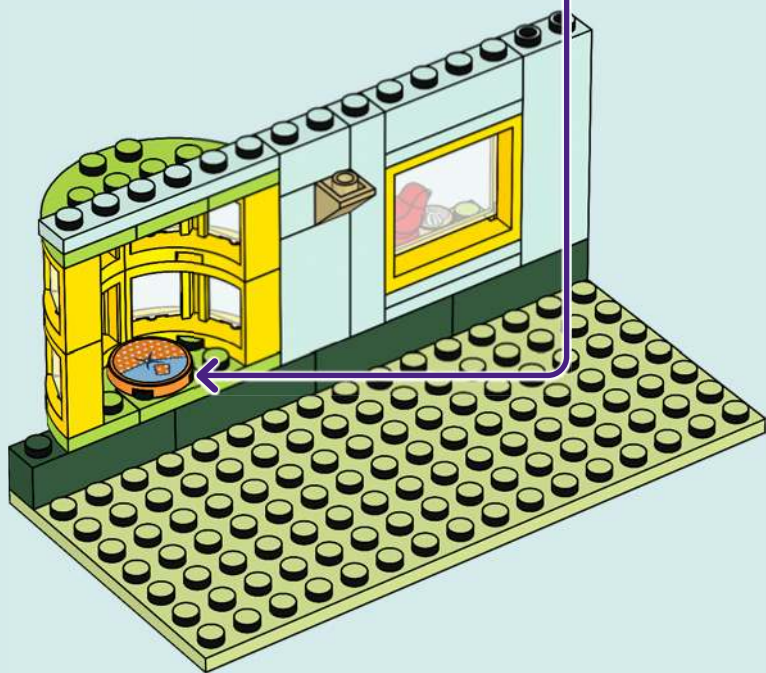
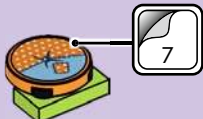

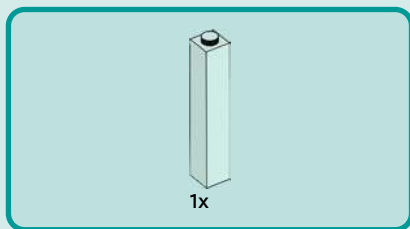

32

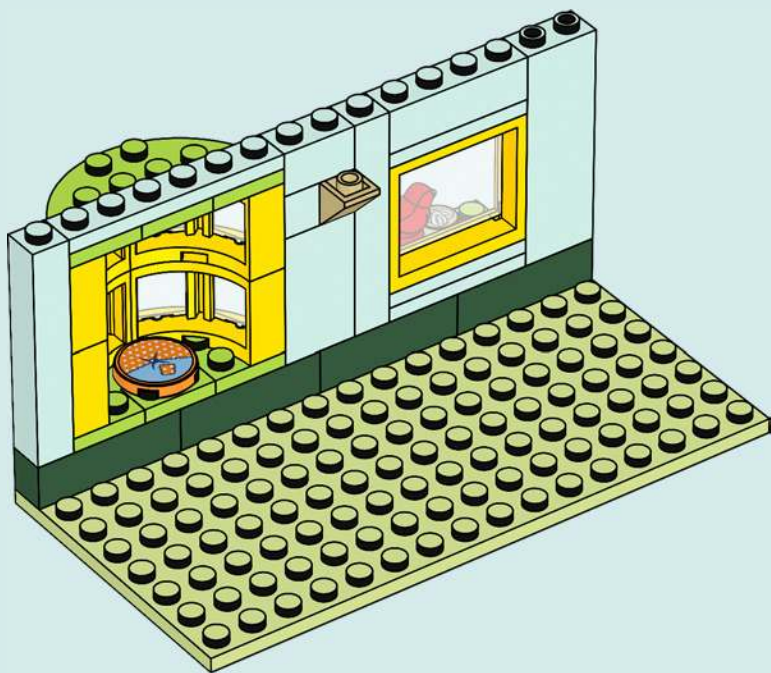



1x

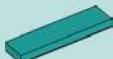

2x

# 33

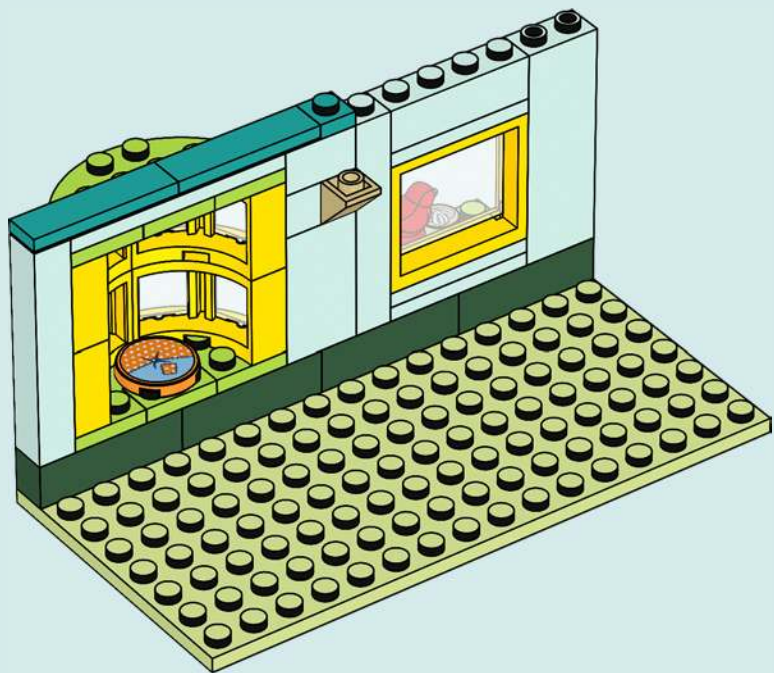

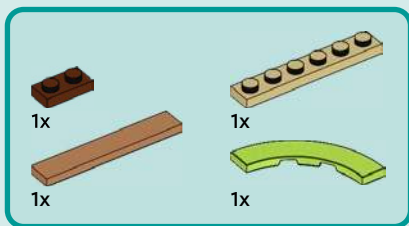

34

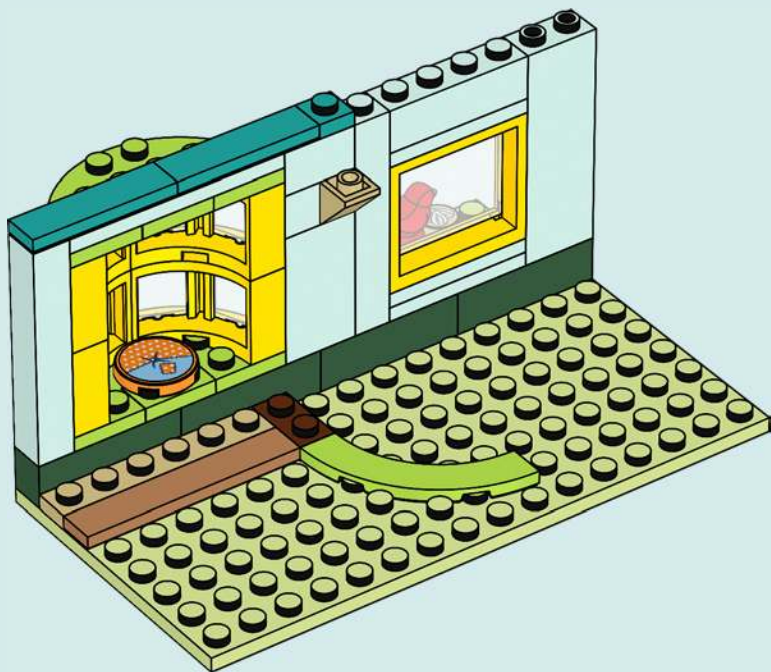



1x



2x



1x

# 35

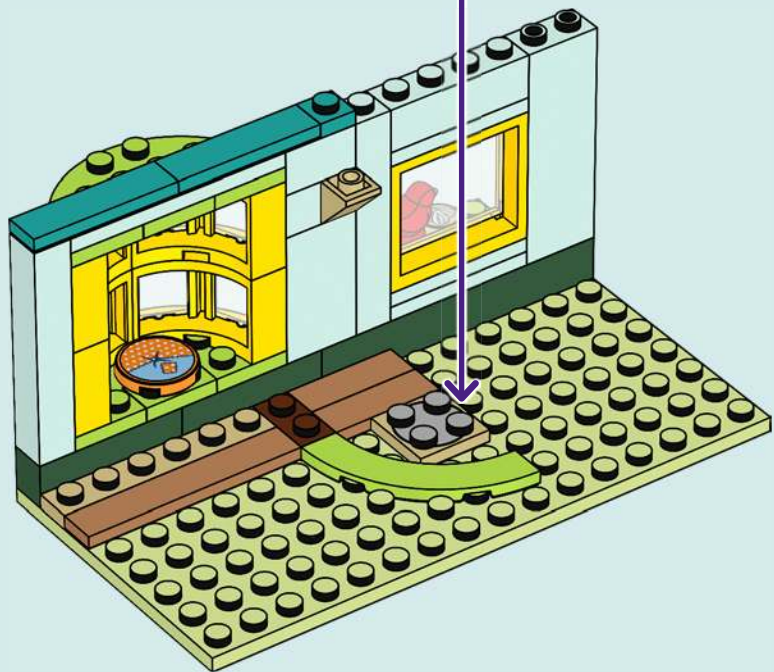
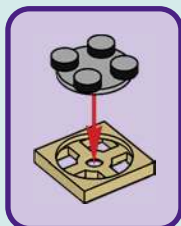



1x



1x

# 36

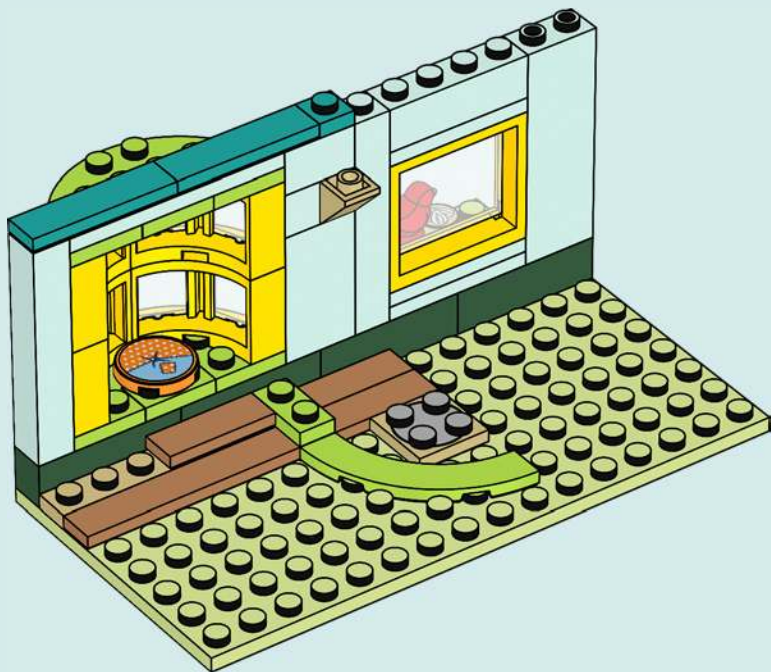

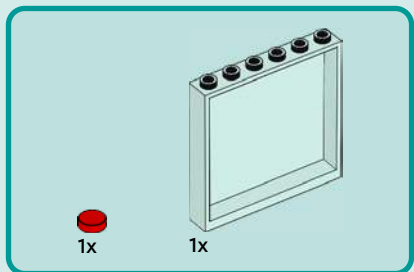

37

1

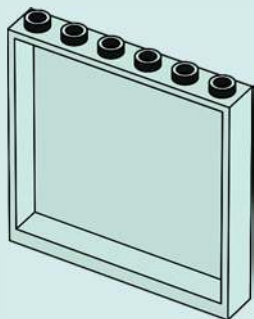

2



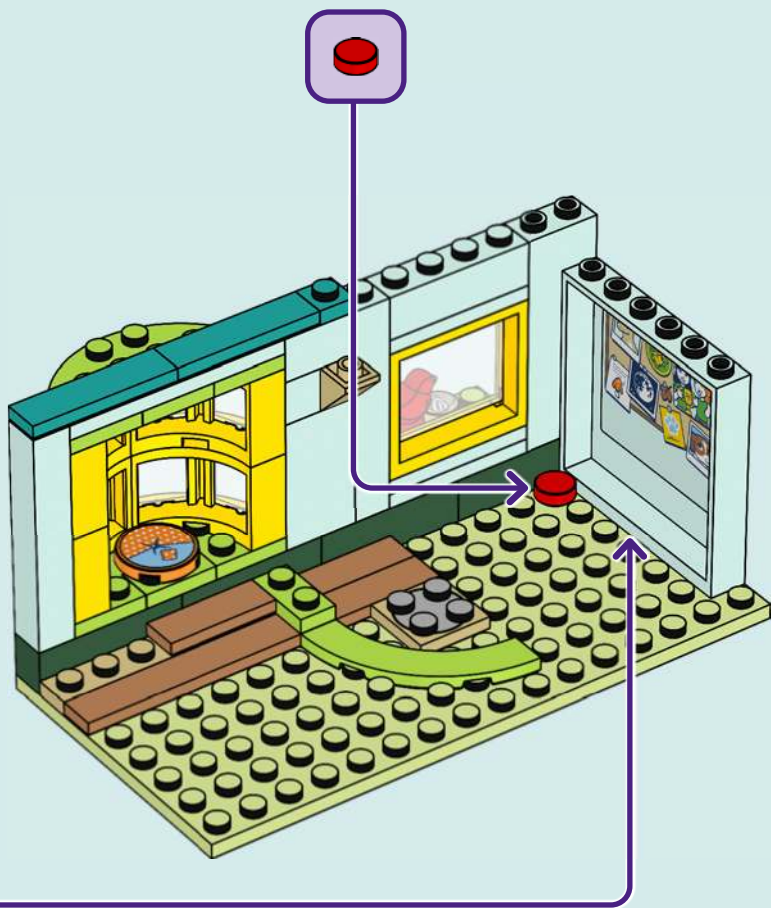

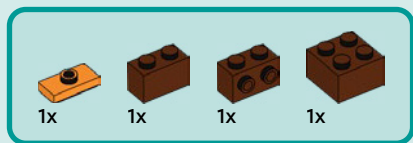

38

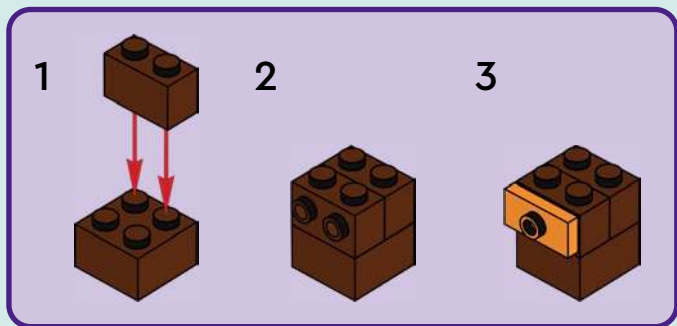



1x

39





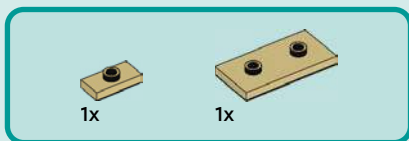

41



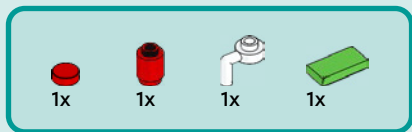

42

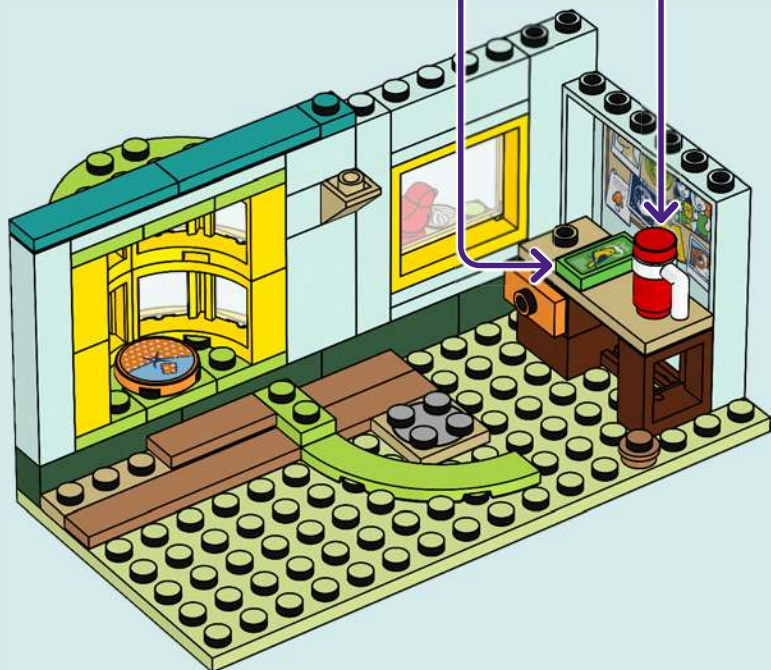
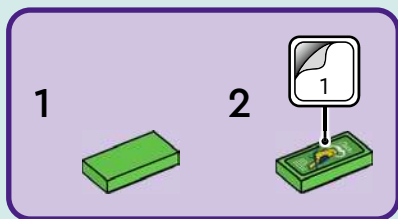

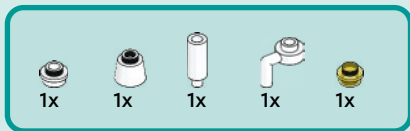

43

1



2



3

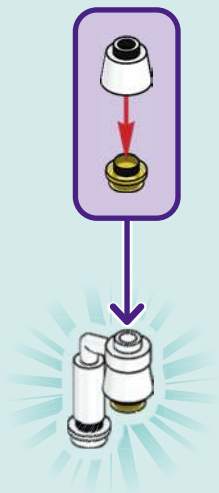

44



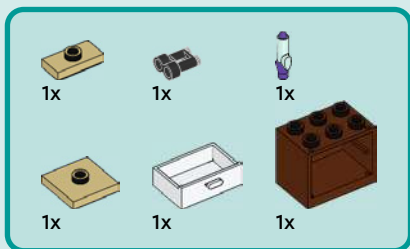

45

1



2

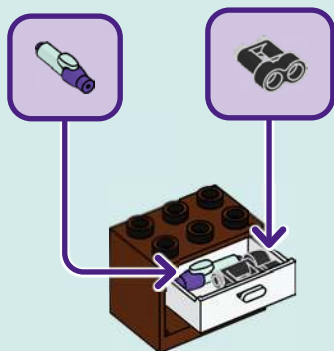

3







# 46



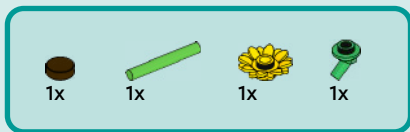

47

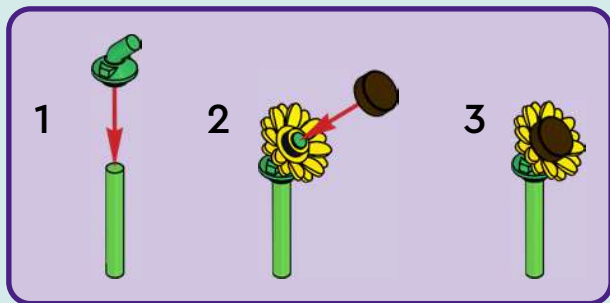





48

1

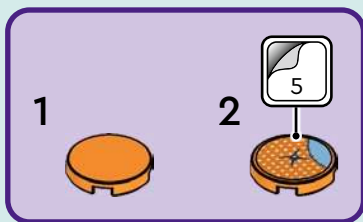
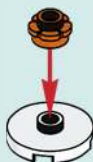

2





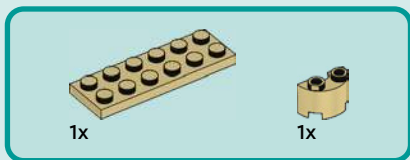
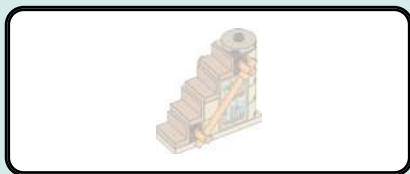

49

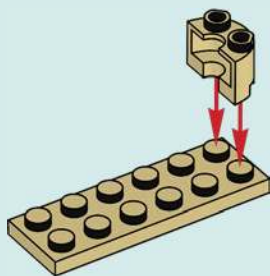

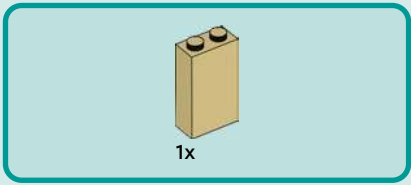

50

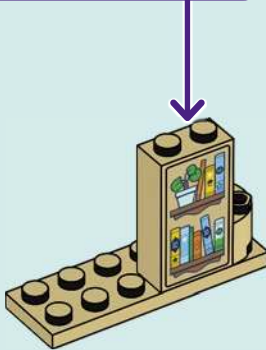
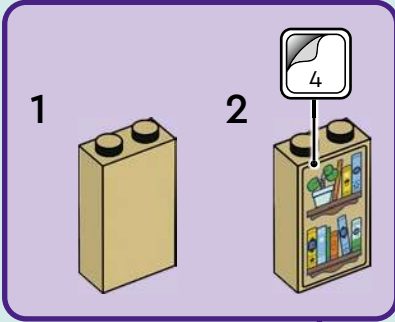



1x



1x

# 51



1x

# 52

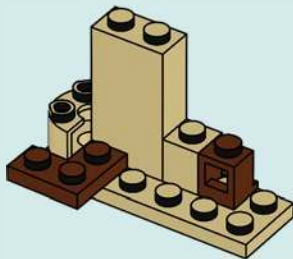
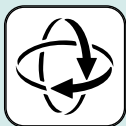



2x

# 53

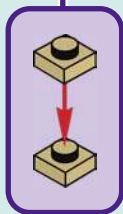
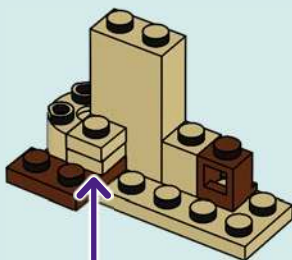



1x



1x

# 54

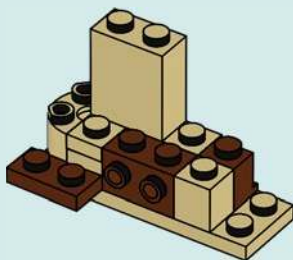



2x

55

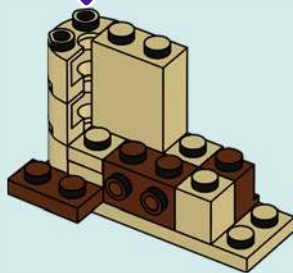
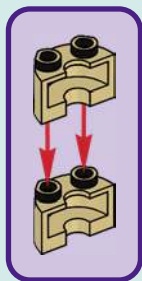



2x

# 56

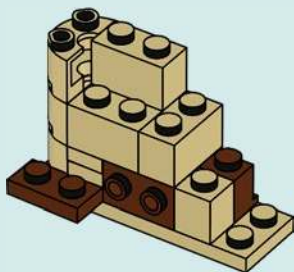

1x



1x



1x

# 57

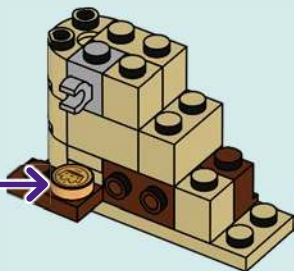



1x

# 58

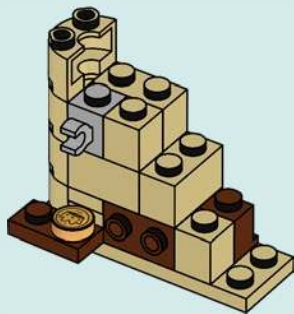



1x



1x

# 59

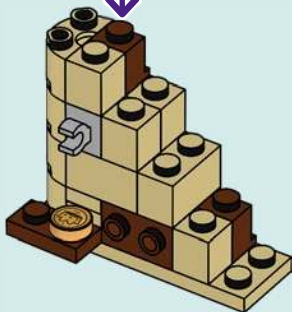



1x

60

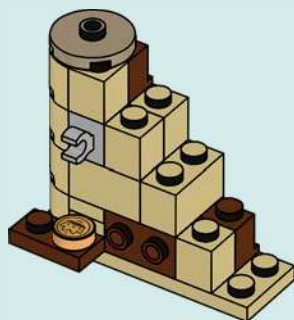



4x

61

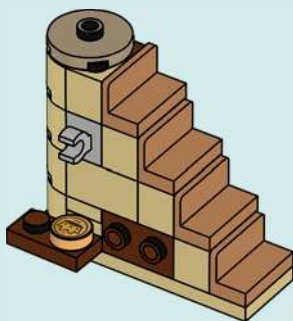



1x

62

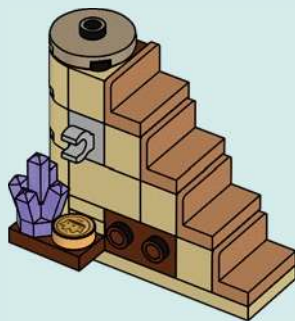



1x

# 63

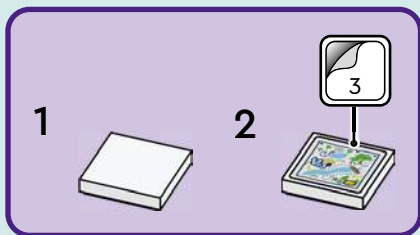



1x



1x

# 64

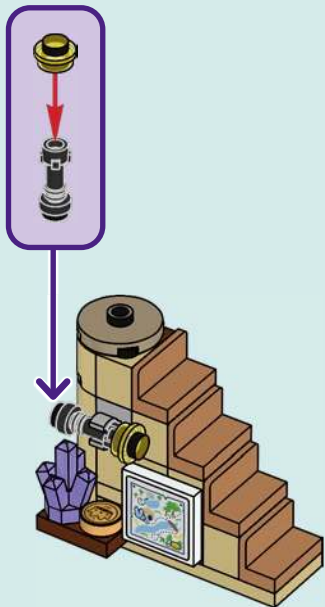



2x

65

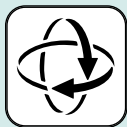

2x

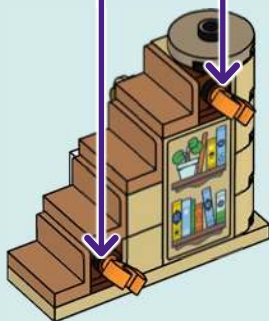



1x

66

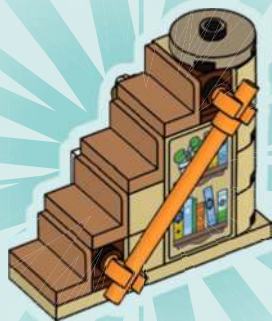

67



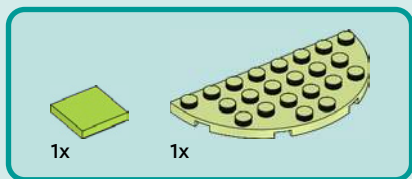

68

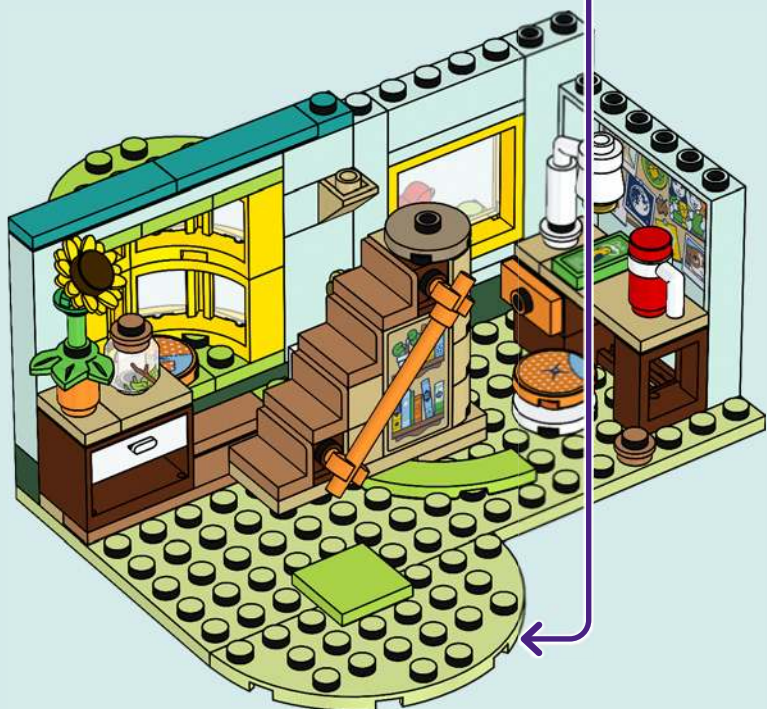
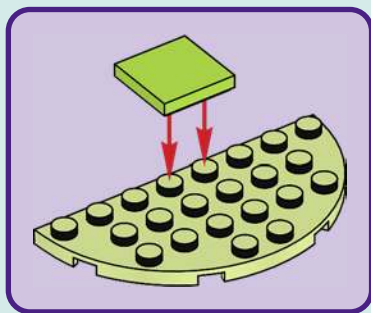

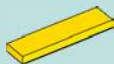

2x



2x

69

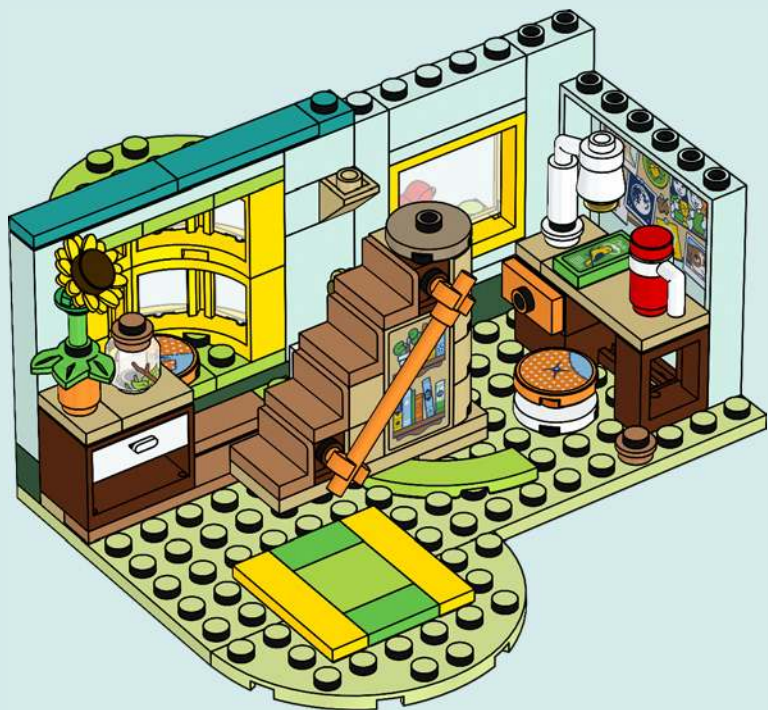



2x



4x

70

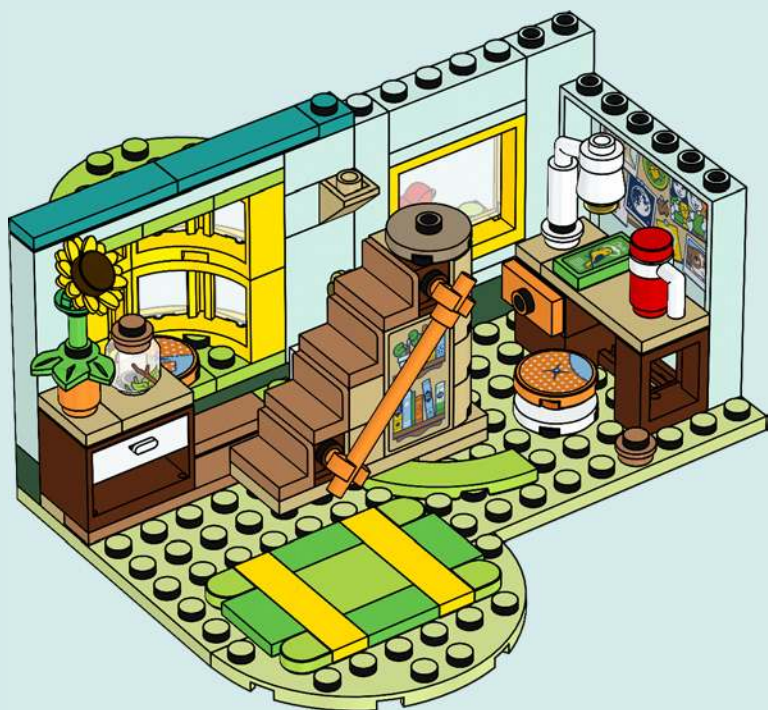

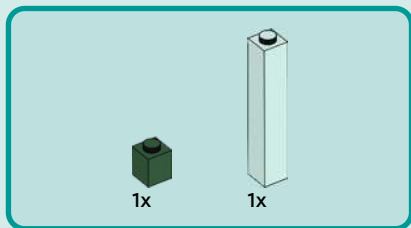

71

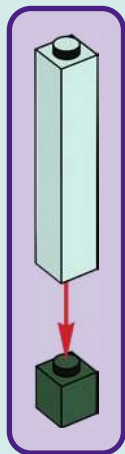



1x

72

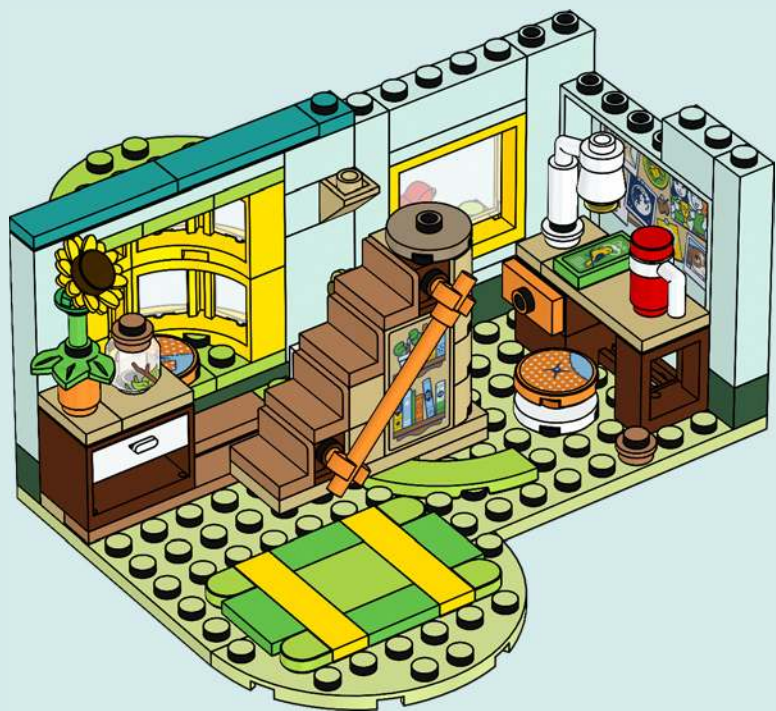

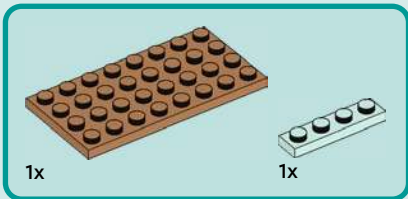
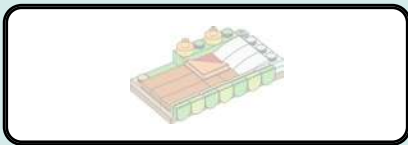

73

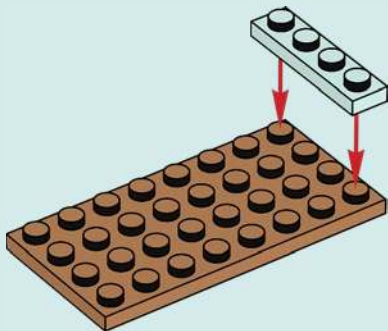

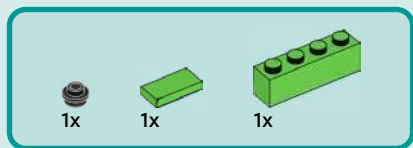

74

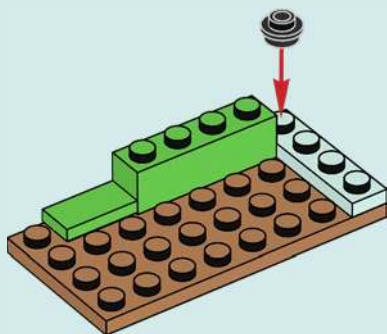

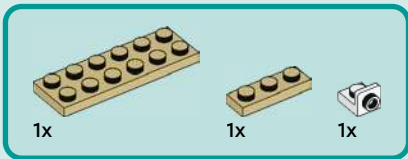

75

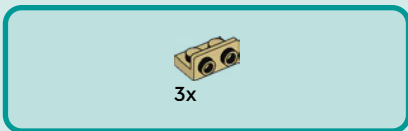
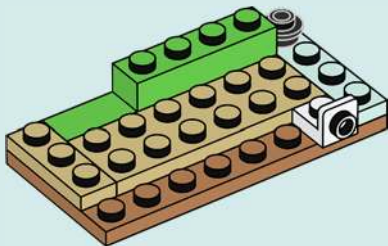

76

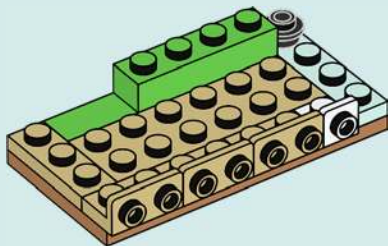



1x

77

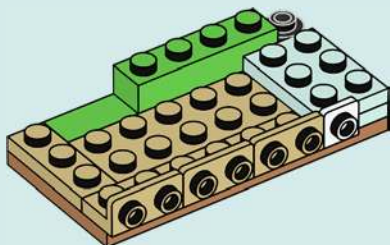



3x

# 78

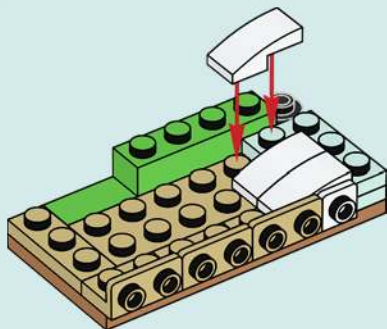

1x



2x

# 79

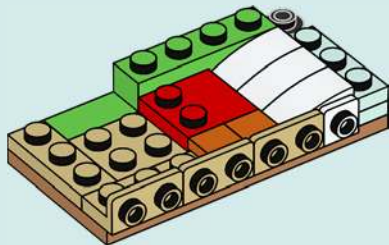



3x

80

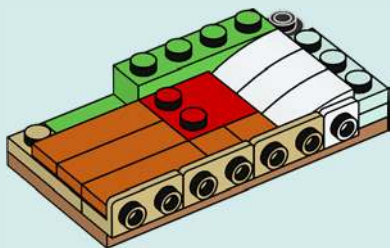



2x



1x

# 81

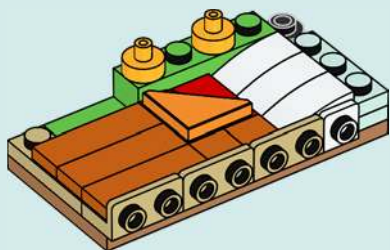



3x



4x

82

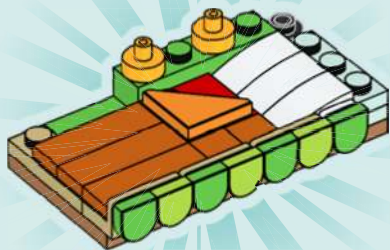

83

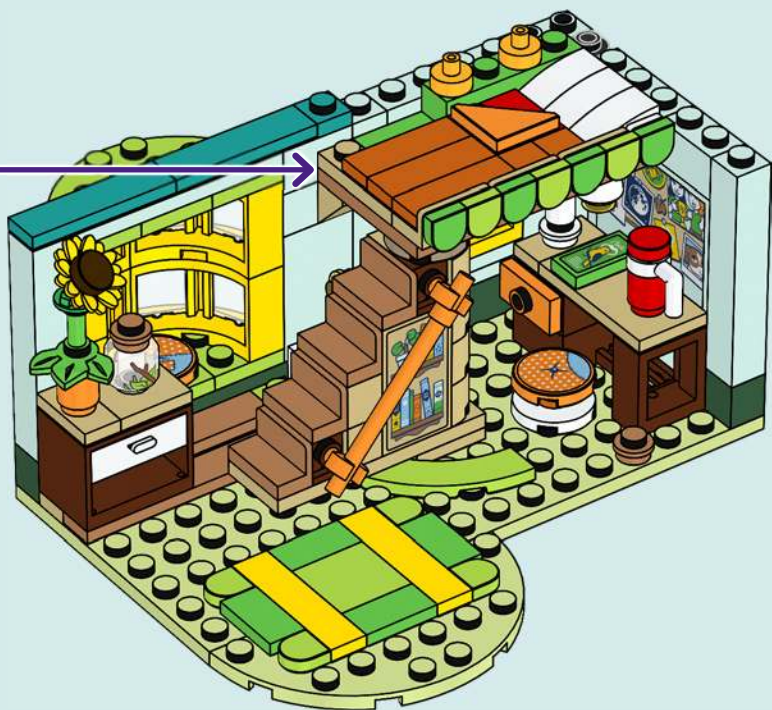

84



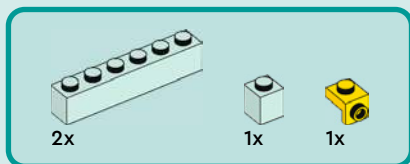

85



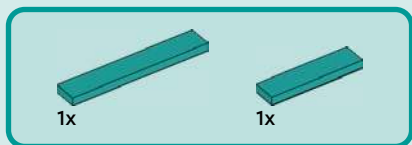

86





1x



2x

# 87





1x



1x

88





1x



1x



1x

# 89

1



2



3





1x

90





# LEGO Friends™

WATCH  
SERIES  
ONLINE



WATCH SERIES ONLINE / SCHAU DIR DIE SERIE ONLINE AN / REGARDE  
LA SÉRIE EN LIGNE / GUARDA LA SERIE ONLINE / MIRA LA SERIE EN  
INTERNET / ASSISTIR À SÉRIE ONLINE / 在线观看 / OGLAĐAJ SERIAL  
W INTERNECIE / SLEDUJ SERIÁL ONLINE / POZRI SI SERIÁL ONLINE  
/ NÉZD A SOROZATOT ONLINE / VIZIONEAZĂ SERIALUL ONLINE /  
ГЛЕДАЙТЕ СЕРИАЛА ОНЛАЙН / SKATĪES SĒRIĀLU TĪEŠSAĪSTĒ /  
VAATA SARJA VEEBIST / ŽIŪRĒK SERIALĀ INTERNETU

**LEGO**

**Friends**

**42663**



**42652**



**42650**



**42649**





# Friends



NOVA

OLLY

ALIYA

PAISLEY

ZAC

LIANN

LEO

AUTUMN



**Rebuild  
the  
World™** 

1x  
6234807

1x  
6168642

1x  
6173141

1x  
6242241

2x  
6508268

1x  
6139454

1x  
6093053

1x  
6322480

1x  
306901

3x  
6034044

1x  
306801

1x  
4520636

1x  
6466742

6x  
4113915

3x  
4159553

4x  
6351413

2x  
6092587

1x  
4159196

1x  
6445058

2x  
4109995

3x  
6313611

1x  
4565387

1x  
6472370

1x  
4121921

1x  
6294227

1x  
4124067

1x  
4121921

1x  
4124067

2x  
4113993

1x  
6515613

2x  
6284574

1x  
306221

1x  
6399031

2x  
6224794

1x  
4157124

1x  
6219819

1x  
6280475

1x  
6430246

4x  
6523878

1x  
6509767

2x  
6310246

2x  
243124

1x  
6316742

1x  
4598897

2x  
6168646

1x  
6391688

1x  
6003301

1x  
6476480

1x  
6510190

1x  
6476620

4x  
6375605

1x  
6182261

2x  
6343326

6x  
6195258

1x  
6161772

1x  
6294513

1x  
6310856

1x  
6409765

1x  
6514191

8x  
6254552

1x  
6514142

2x  
6514056

1x  
6220715

2x  
6439042

3x  
6092770

1x  
6329699

1x  
4121967

1x  
6092599

1x  
6346092

1x  
4158355

1x  
6472965

2x  
6311437

1x  
6213782

1x  
6213778

2x  
6430965

2x  
6491442

3x  
6292786

1x  
6264986

7x  
6250601

2x  
4164022

3x  
4164037

1x  
4518611

1x  
4187743

2x  
6109765

1x  
6458173

1x  
6132767



1x  
6481630



1x  
4521915



4x  
4245571



1x  
6481629



2x  
6223719



1x  
6097098



2x  
4225469



1x  
6424457



1x  
4211149



2x  
6397820



1x  
4224243



1x  
4211150



1x  
4211257



1x  
6382102



1x  
4211210



1x  
6132732



1x  
6320306



1x  
6248890



1x  
4540203



1x  
6416668



1x  
6527907



1x  
6375358



1x  
6322813



1x  
6287856



2x  
6167641



1x  
6416551



4x  
6226646



1x  
6527694



3x  
6365746



1x  
6102995



1x  
6218145



1x  
6467587



1x  
6507866



1x  
6475523



1x  
6491212



2x  
6475042



3x  
6483781



1x  
6213681



2x  
6236576



1x  
6426724



3x  
6141592



2x  
6022032



1x  
6218162



1x  
6138662



1x  
6146702



2x  
6227921



1x  
6329423



1x  
6329423



1x  
6523876



1x  
6514192



1x  
6328085



3x  
6298819



1x  
6135112



2x  
6523877

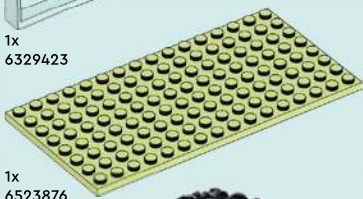

1x  
6523876



1x  
6514192



LEGO.com/service

YOU COULD

WIN



Scan this QR code or go to  
**LEGO.COM/PRODUCTFEEDBACK**  
and give us your short feedback  
about this LEGO® set for a chance  
to win a cool LEGO prize.

Terms and Conditions apply\*

**EN: YOU COULD WIN.** Terms and Conditions apply\* **DE: Du könntest GEWINNEN.** Es gelten die Teilnahmebedingungen\* **FR: Tu pourrais GAGNER.** Des conditions s'appliquent\* **IT: Potresti VINCERE tu.** Termini e condizioni sono applicabili\* **ES: Puedes GANAR.** Aplican términos y condiciones\* **PT: Poderá GANHAR.** Aplicam-se termos e condições\* **ZH: 轻松获奖. 条款和条件适用\*** **PL: Szansa na WYGRANĄ.** Obowiązują warunki korzystania\* **CS: Máte šanci VYHRÁT.** Platí všeobecné smluvní podmínky\* **SK: Máte šancu VYHRAŤ.** Platia všeobecné zmluvné podmienky\* **HU: TE IS NYERHETSZ.** Felhasználási feltételek érvényesek\* **RO: Ai putea CÂȘTIGA.** Se aplică termenii și condiții\* **BG: Можете да СПЕЧЕЛИТЕ.** Има определени правила и условия\* **LV: Tu vari LAIMĒT.** Ir spēkā noteikumi un nosacījumi.\* **ET: Sul on võimalus VÕITA.** Kehtivad tingimused\* **LT: Jūs galite LAIMĖTI.** Taikomos sąlygos\*

\*[LEGO.com/productfeedback-terms](https://www.lego.com/productfeedback-terms)