



# CREATOR™



31162



3in1	3 in 1	3合1	3 az 1-ben	3 ühes
3-in-1	3en1	3 w 1	3 in 1	„Trys viename“
3-en-1	3em1	3 v 1	„3 в 1“	



LEGO® Builder



[LEGO.com/sustainable-packaging](https://LEGO.com/sustainable-packaging)



**FR**  
**DONNEZ**  
OU  
**RECYCLEZ**

 OU  OU 

ASSOCIATION MAGASIN DÉCHÈTERIE

Adresses sur [quefairedemesdechets.fr](https://quefairedemesdechets.fr)



# CREATOR™

# 3 IN 1



31169

31159



31160





 1-3  
Builders

Build Together

Download now



Q LEGO® Builder



Apple and the Apple logo are trademarks of Apple Inc., registered in the U.S. and other countries and regions. App Store is a service mark of Apple Inc. Google Play and the Google Play logo are trademarks of Google LLC. Tencent and the Tencent logo are trademarks of Tencent Inc.

Q [LEGO.com/devicecheck](https://LEGO.com/devicecheck)

BUILD TOGETHER | GEMEINSAM BAUEN | CONSTRUIRE ENSEMBLE | COSTRUIRE INSIEME | CONSTRUYE EN COMPAÑÍA | CONSTRUIR JUNTOS | 一起来拼搭 | WSPÓLNE BUDOWANIE | STAVĚJTE SPOLEČNĚ | STAVAJTE SPOLOČNE | ÉPÍTSEK EGYÜTT! | CONSTRUIM ÎMPREUNĂ | ДА СТРОИМ ЗАЕДНО | BŮVĚJIET KOPĀ | EHITAGE KOOS | KONSTRUOKITE DRAUGE

DOWNLOAD NOW | JETZT HERUNTERLADEN | TÉLÉCHARGER MAINTENANT | SCARICALA SUBITO | DESCARGAR AHORA | DESCARREGAR JÁ | 立即下载 | POBIERZ TERAZ | STÁHNI HNED | STIAHNUŤ TERAZ | TÖLTSD LE MOST! | DESCARCĂ ACUM | ИЗТЕГЛЕТЕ СЕГА | LEJUPIELĀDĒT | LAADI KOHE ALLA | ATSISIŪSKITE DABAR

1-3 BUILDERS | 1-3 BAUMEISTER | 1-3 CONSTRUCTEURS | 1-3 COSTRUTTORI | 1-3 CONSTRUCTORES | 1 A 3 CONSTRUTORES | 1-3 名拼搭者 | 1-3 KONSTRUKTORÓW | 1 AŽ 3 STAVITELÉ | 1 AŽ 3 STAVITELIA | 1-3 ÉPÍTŐ | 1-3 CONSTRUCTORI | 1-3 СТРОИТЕЛИ | 1-3 BŮVĚTĀJI | 1-3 EHITAJAT | 1-3 KONSTRUOTOJAI

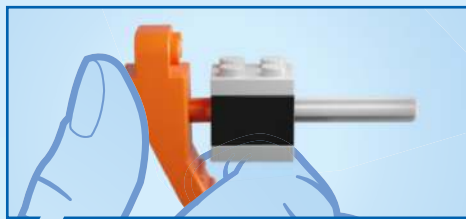

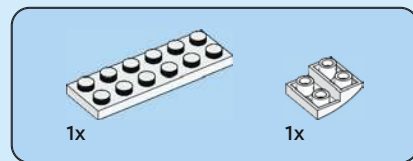
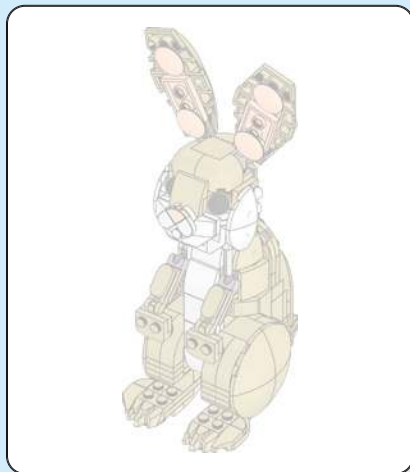

1

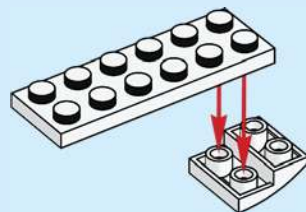



2x

2

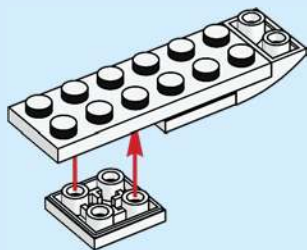



1x

3



1x



2x

4

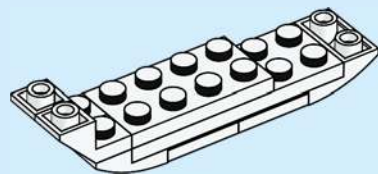

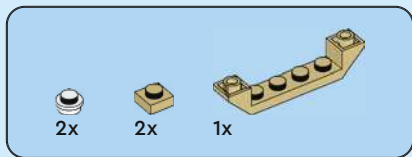

5

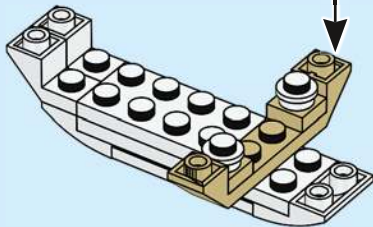
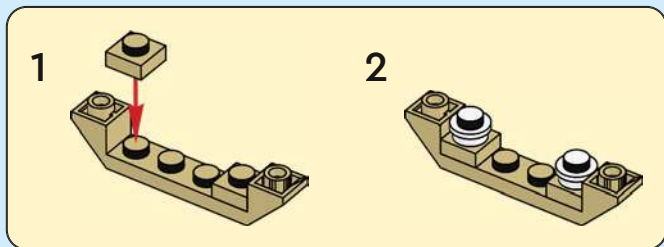



1x

6

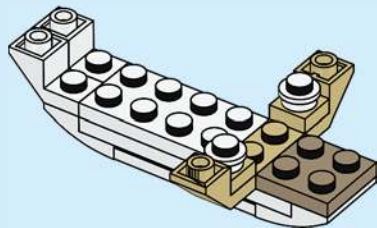

1x



1x



2x

7

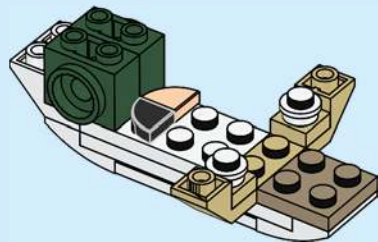



1x



1x

8

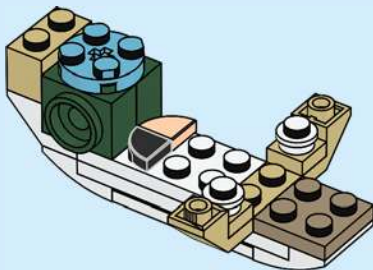



2x



1x

9

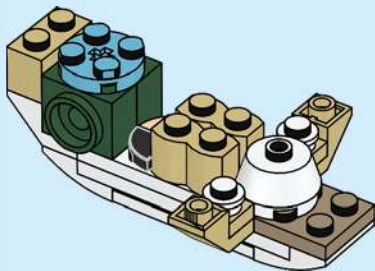

1x



2x



1x

10

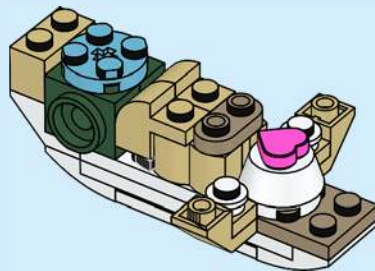



1x

11

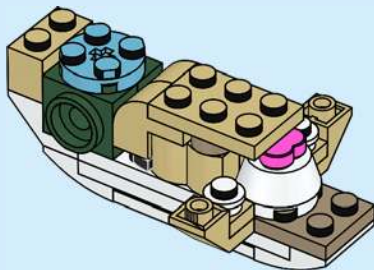

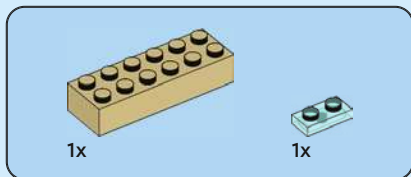

12

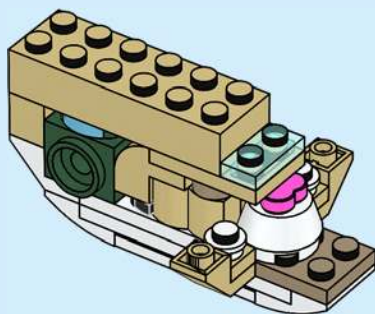



1x

13

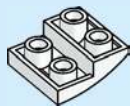

2x

14

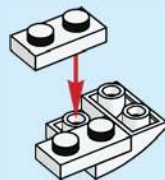

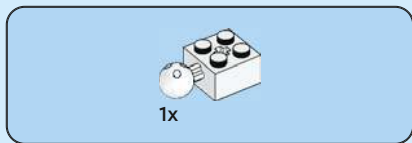

15

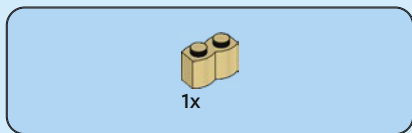
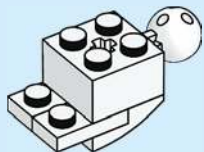

16

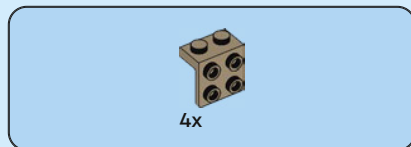

17

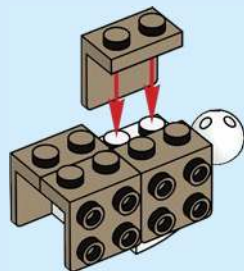

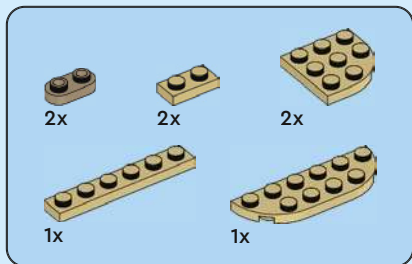

18

1

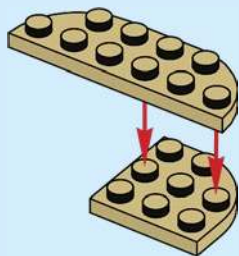

2

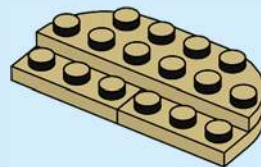

3

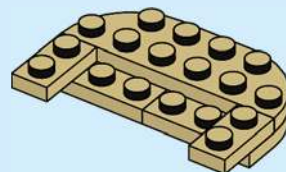

4

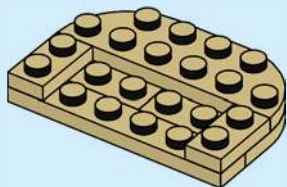

5

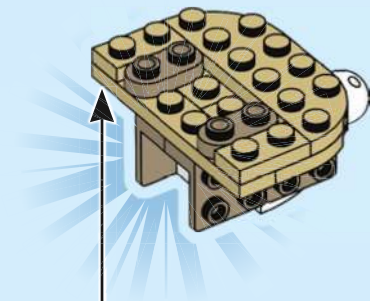
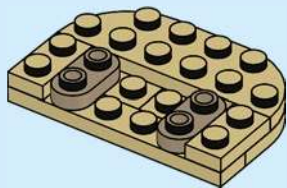

19

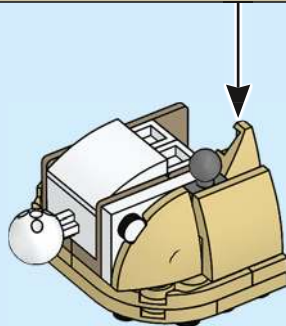
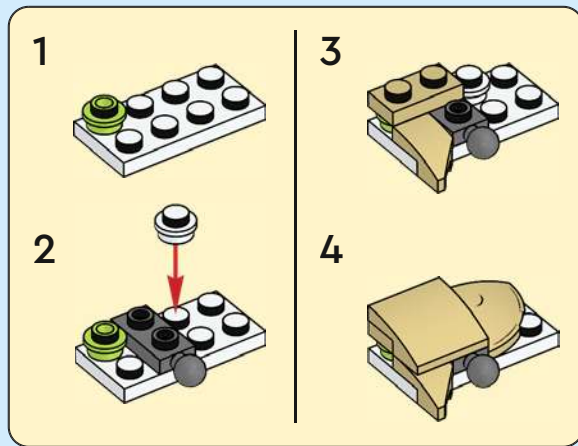
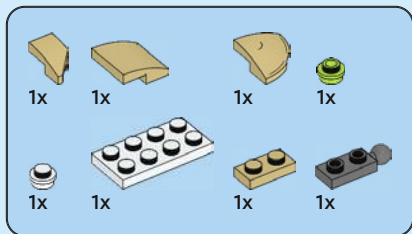

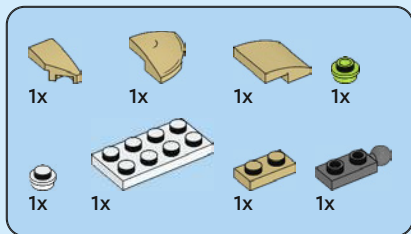

20

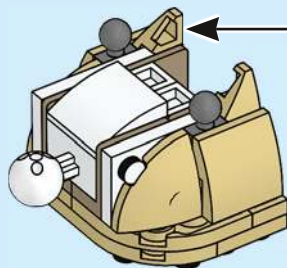
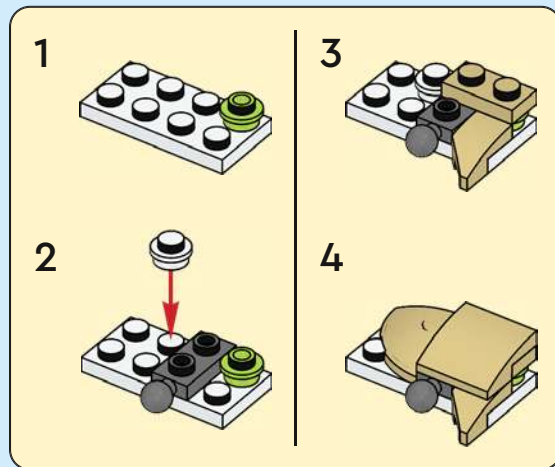

21

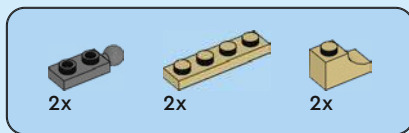
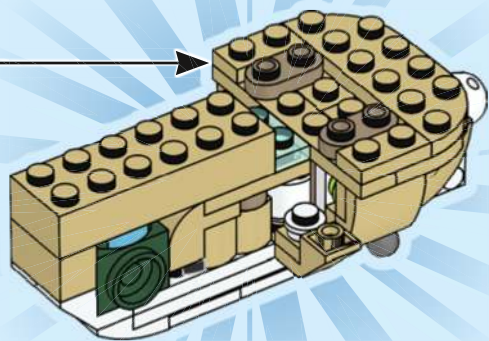

22

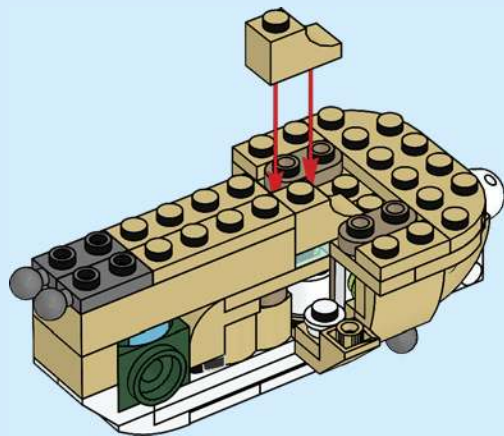

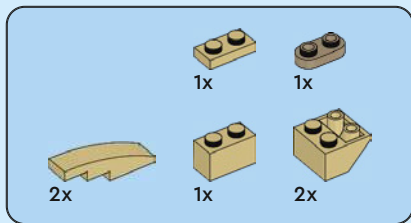

23

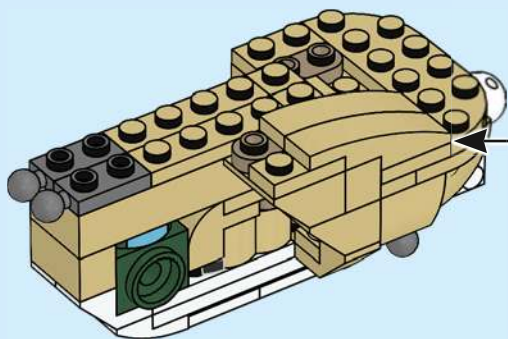
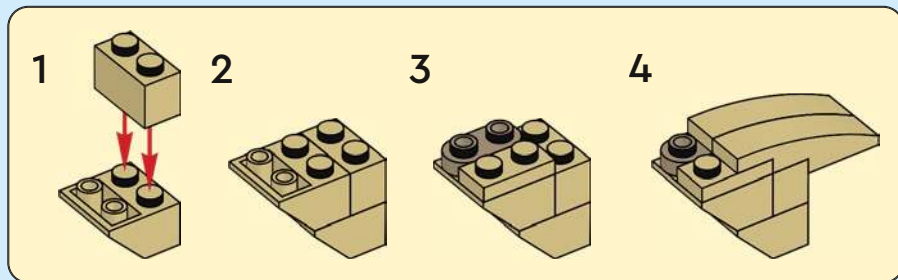

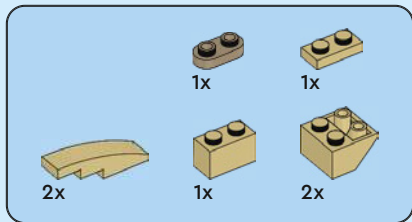

24

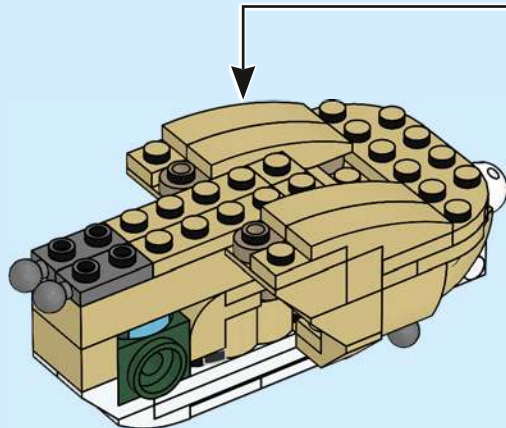
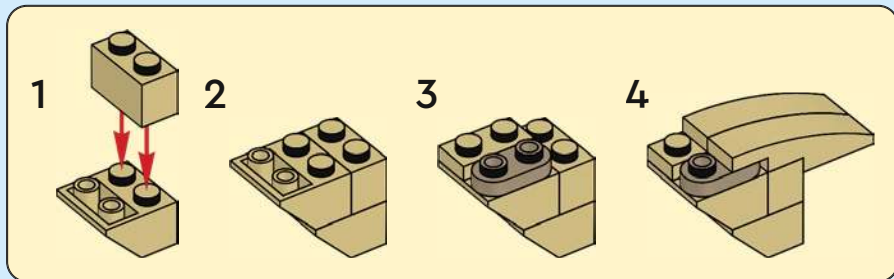

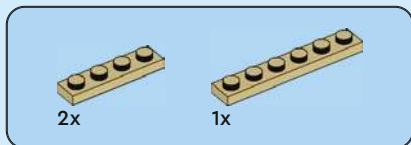

25

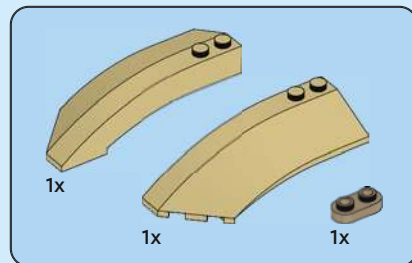
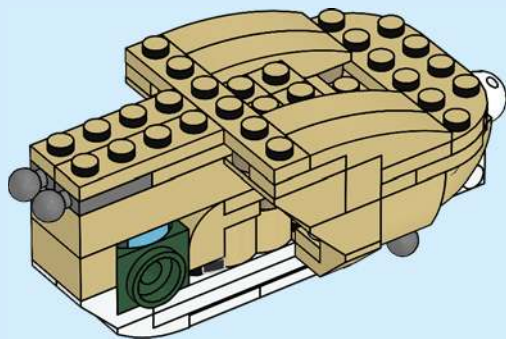

26

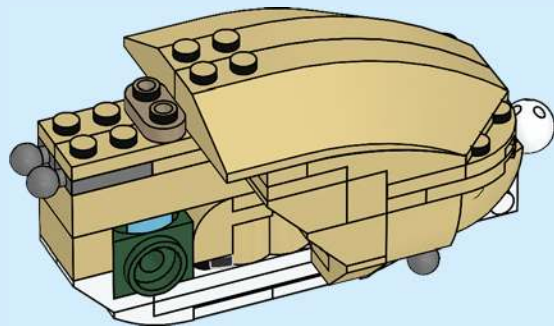



2x

27

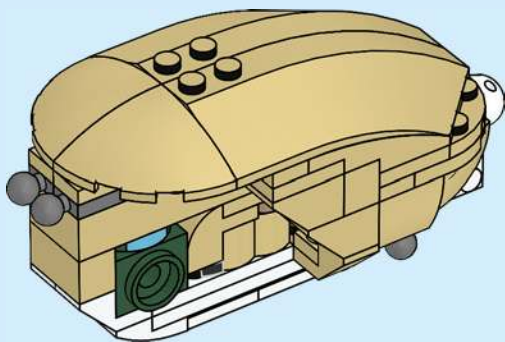

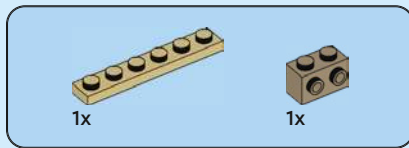

28

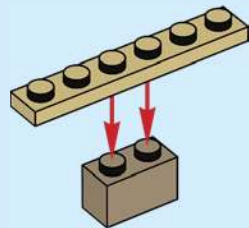



2x

29

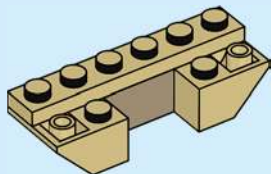

2x

30

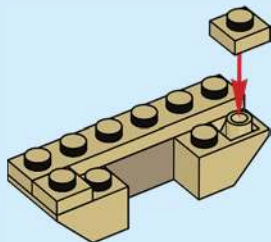

1x



2x

31

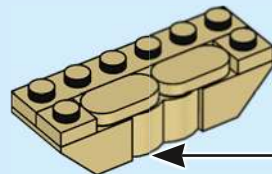
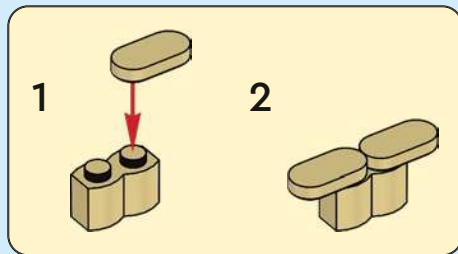



2x



1x

# 32

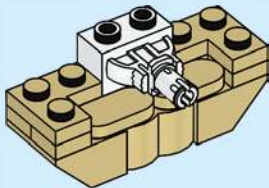

2x



2x

# 33

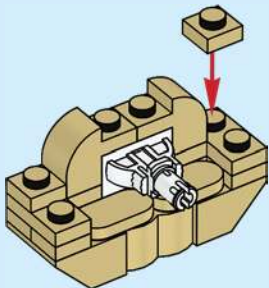

1x



1x

# 34

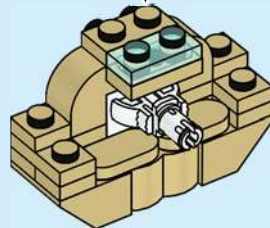
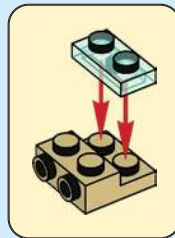

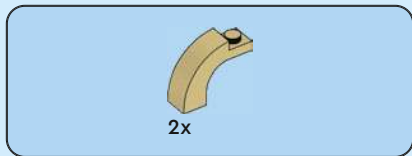

35

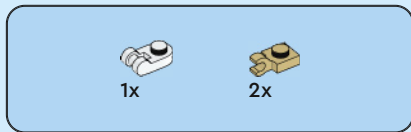
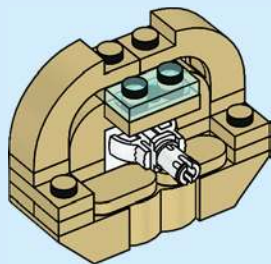

36

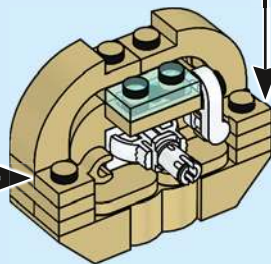
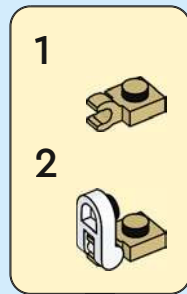

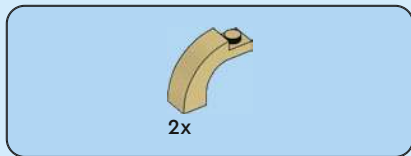

37

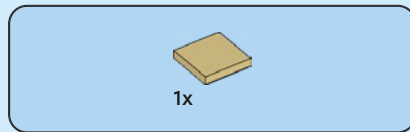
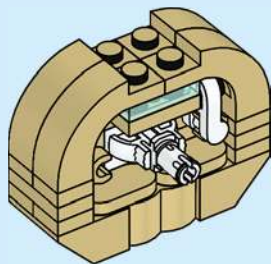

38

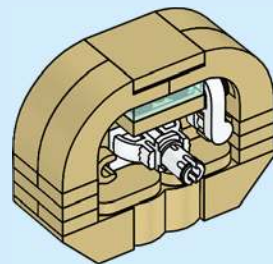



1x



1x

39



1x



1x

40





2x

# 41

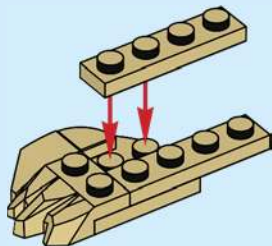

1x



1x



2x

# 42

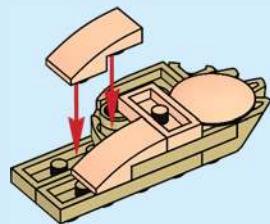
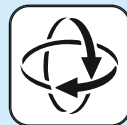

43

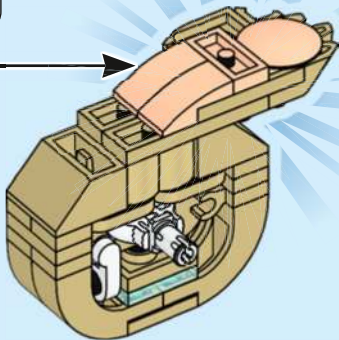

2x

44

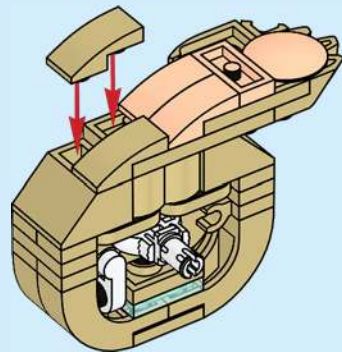

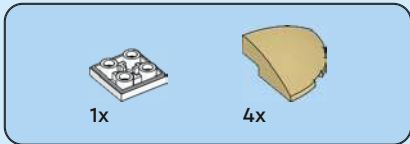

45

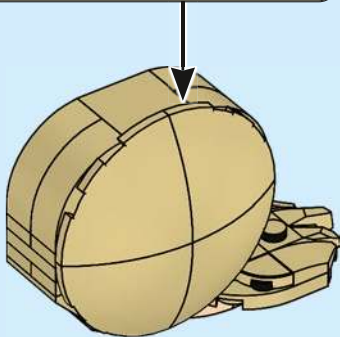
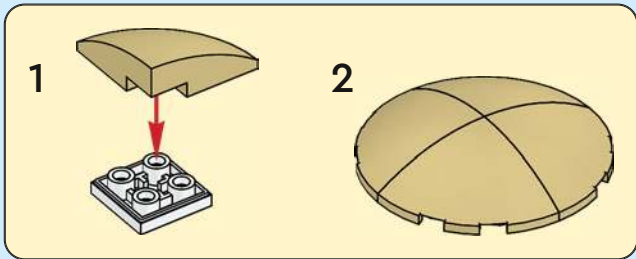

46

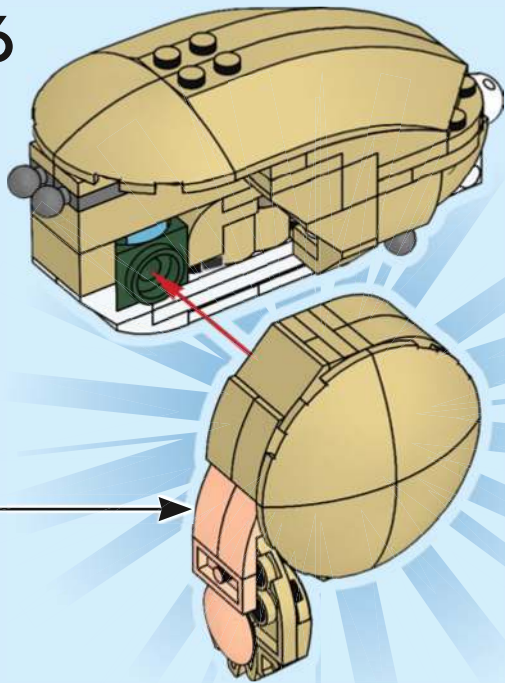

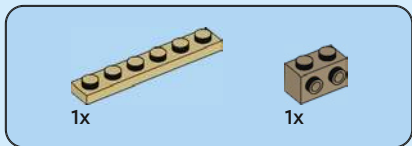
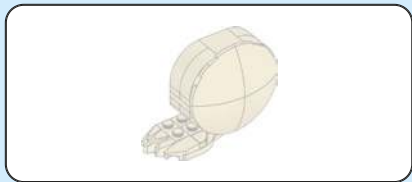

47

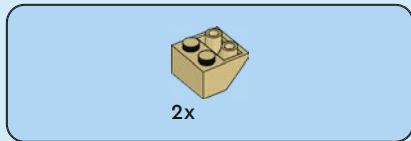
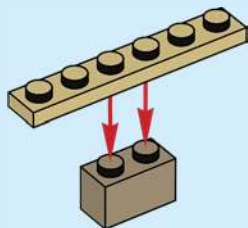

48

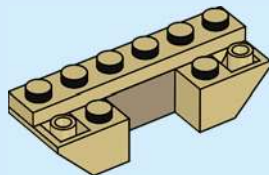

49

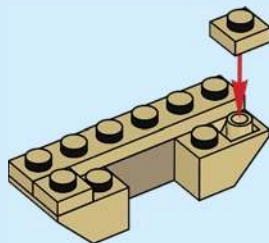



1x



2x

# 50

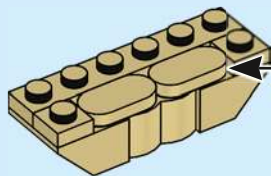
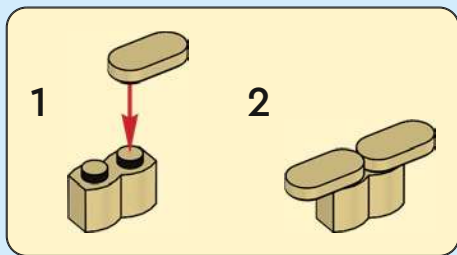

2x



1x

# 51

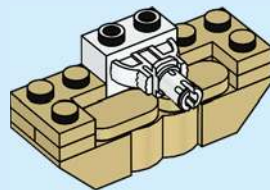



2x



2x

# 52

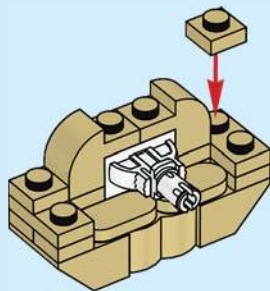

1x



1x

# 53

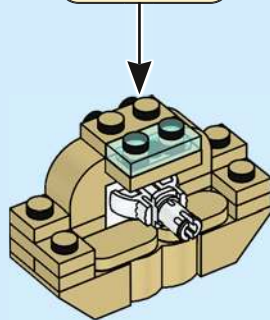
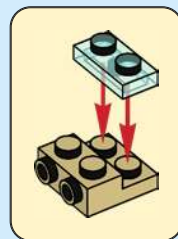



54

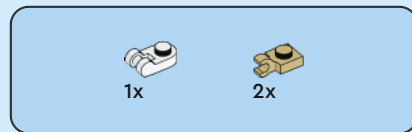
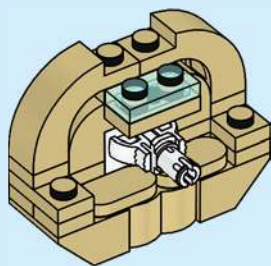

55

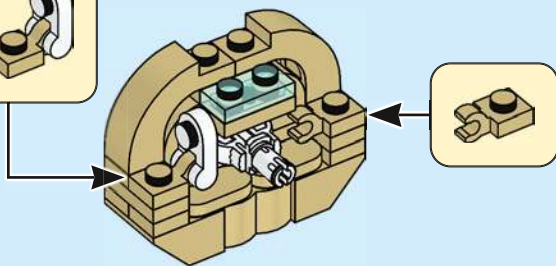
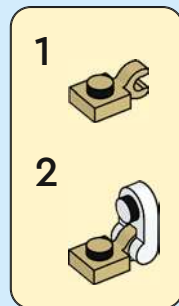



56

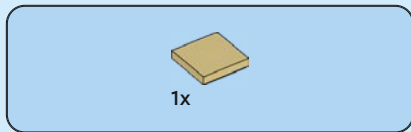
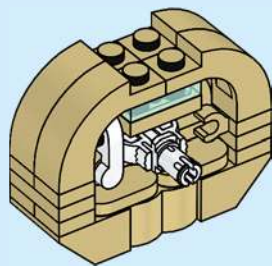

57

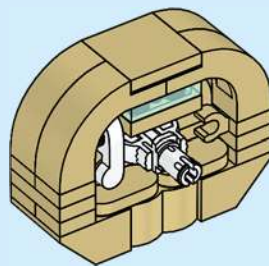



1x



1x

58

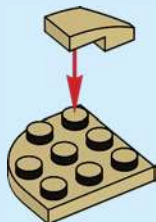

1x



1x

59





2x

60

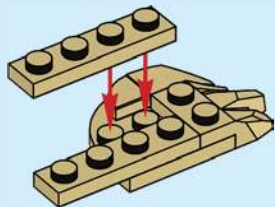

1x



1x



2x

61

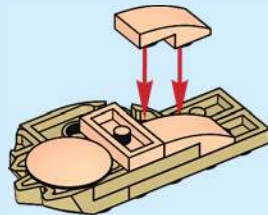
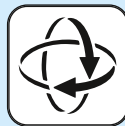

62

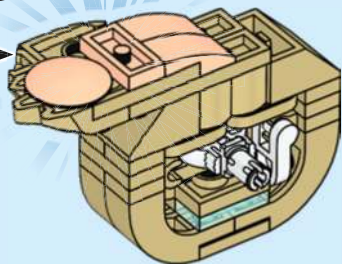

63



2x

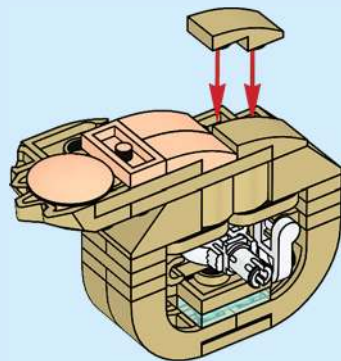

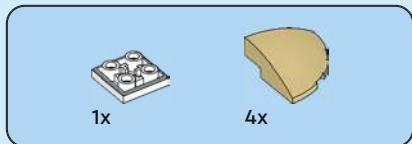

64

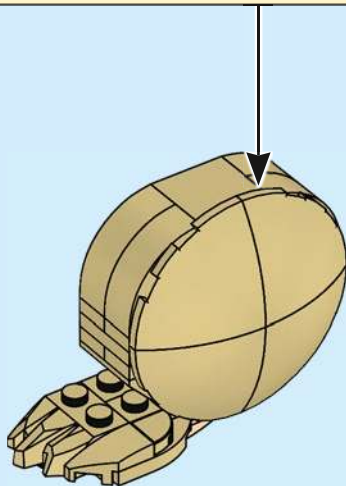
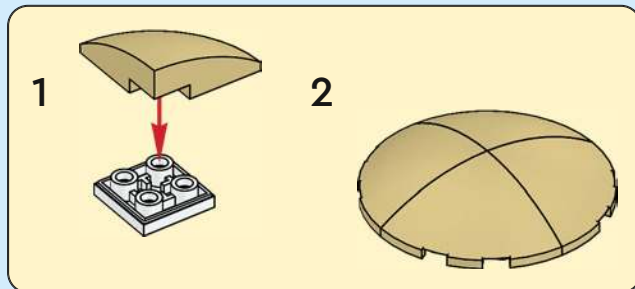

65

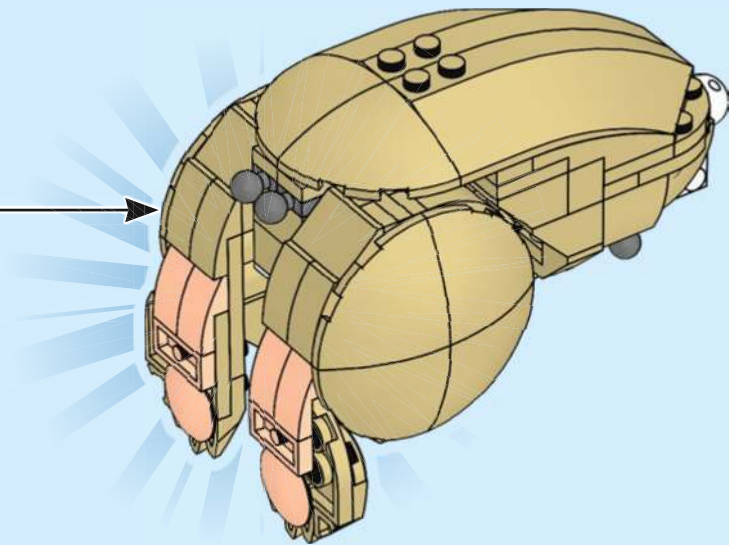



1x



1x

66

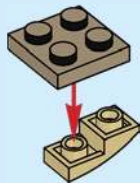

3x

67





1x

68



2x

69



2x

70



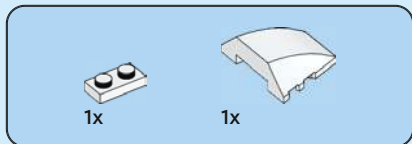

71

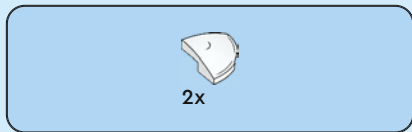
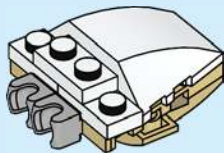

72



73

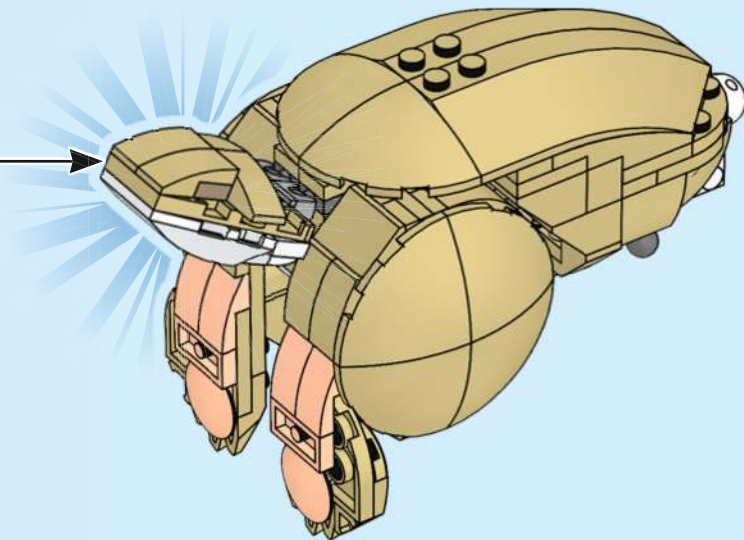



2x



2x



2x



2x



2x



2x



2x

74

1

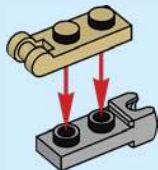

2



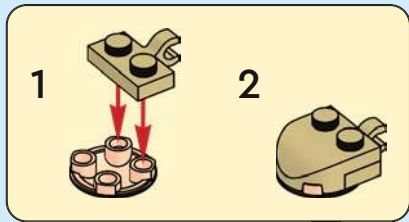

3

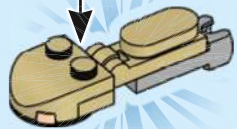

2x

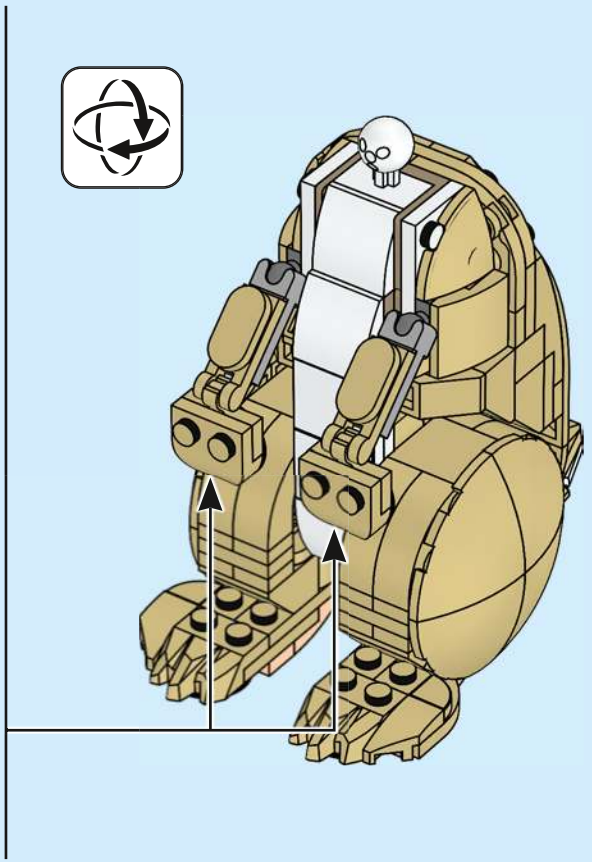

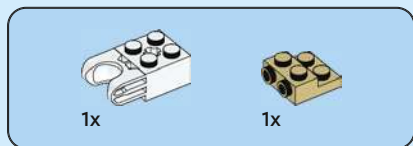

75

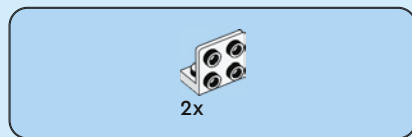
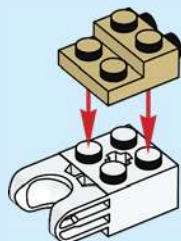

76

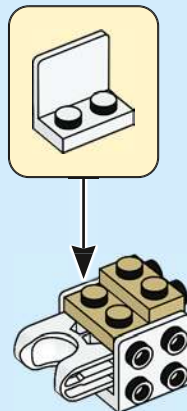



2x



2x

# 77

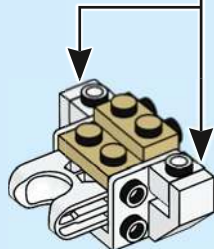
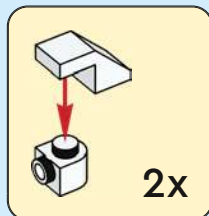

1x



1x



1x

# 78

1

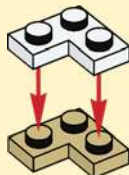

2

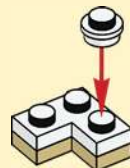

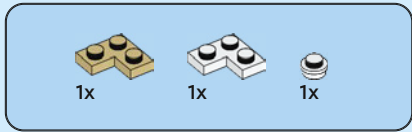

79

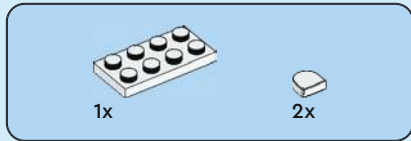
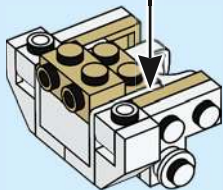
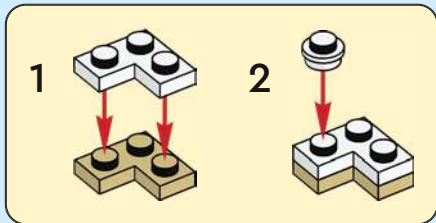

80





2x



1x

# 81

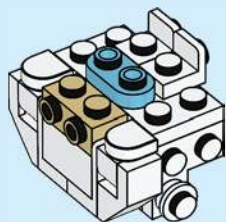

1x



2x

# 82





4x



2x

# 83

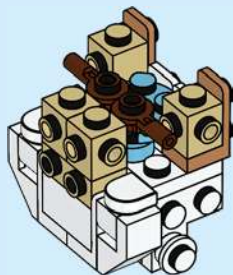

1x



1x

# 84

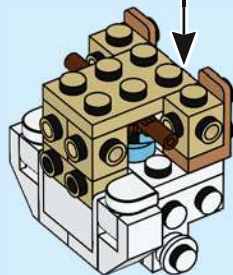
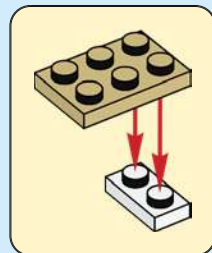





1x



2x

87

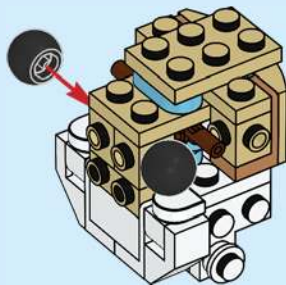



2x



2x

88

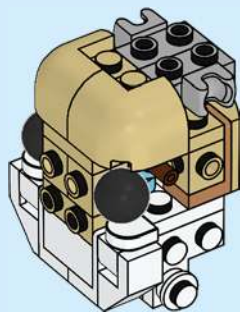

1x



1x

89

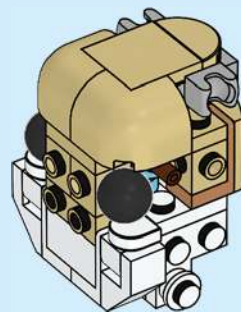

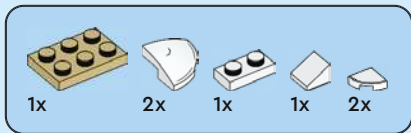

90

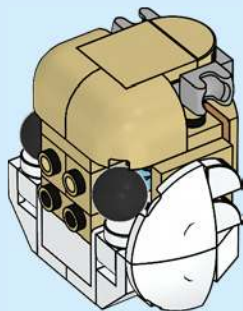
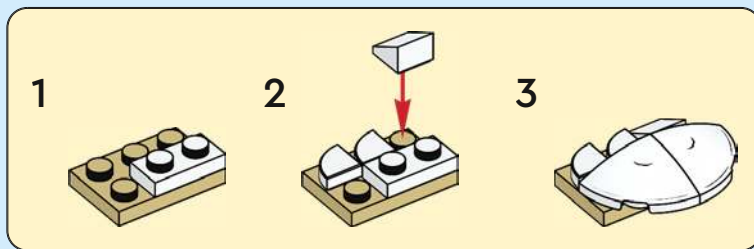

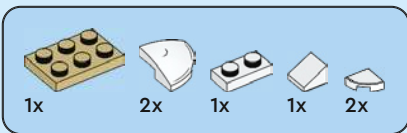

91

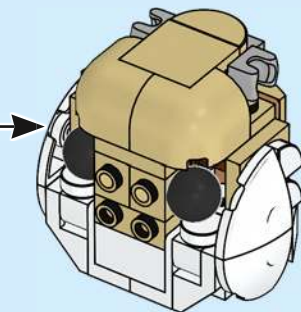
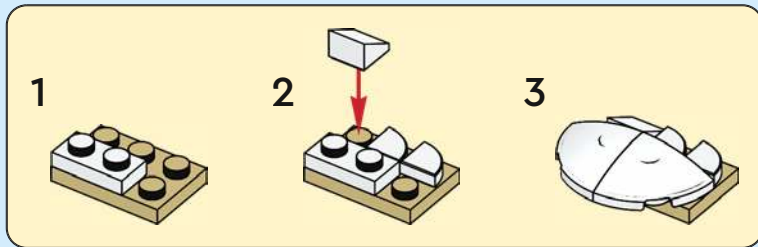

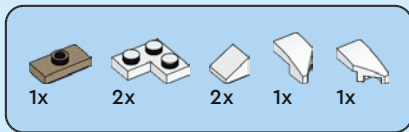

92

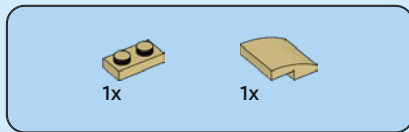
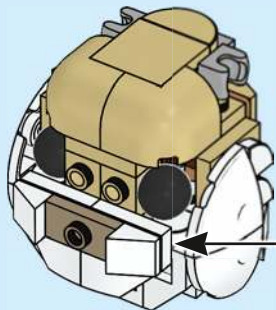
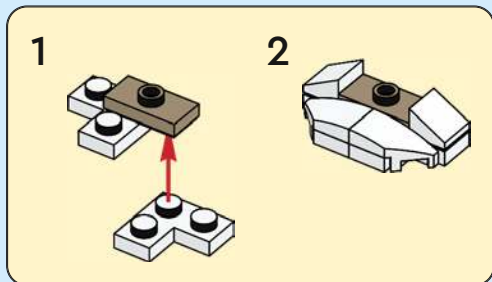

93

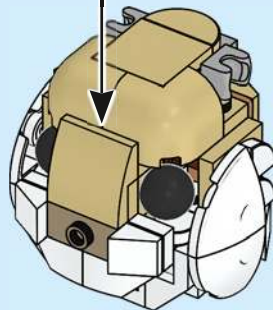
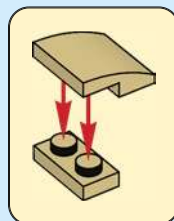



1x



2x



1x

# 94

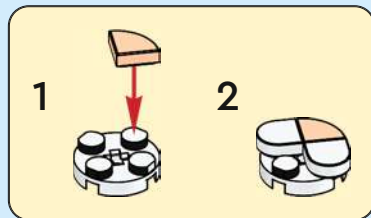

2

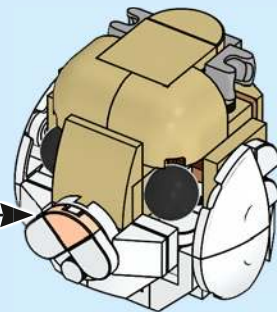

95

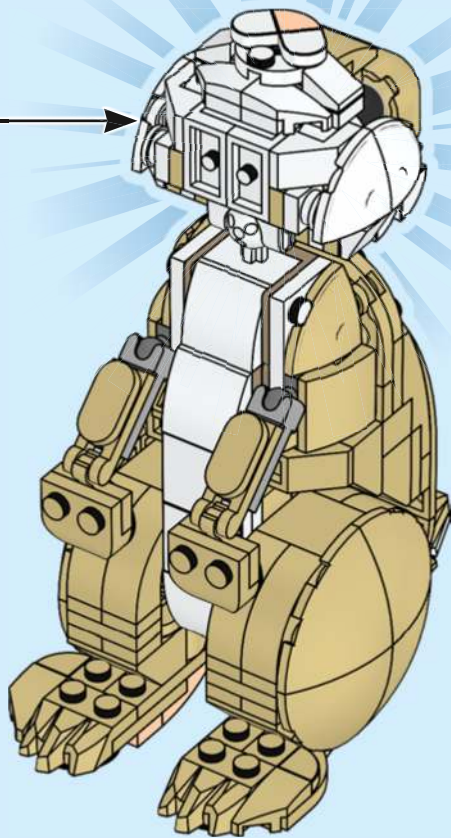



2x



1x



1x

96



2x

97

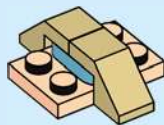



2x

98

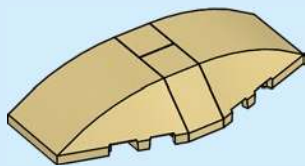

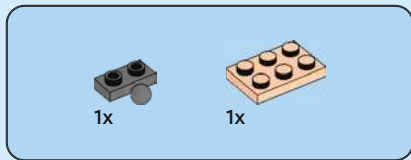

99

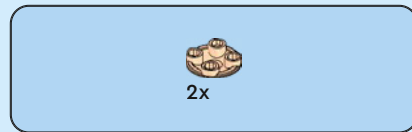
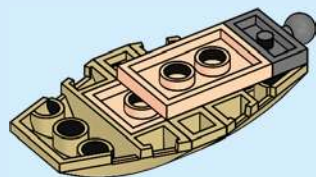

100

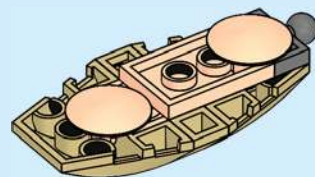

2x

101

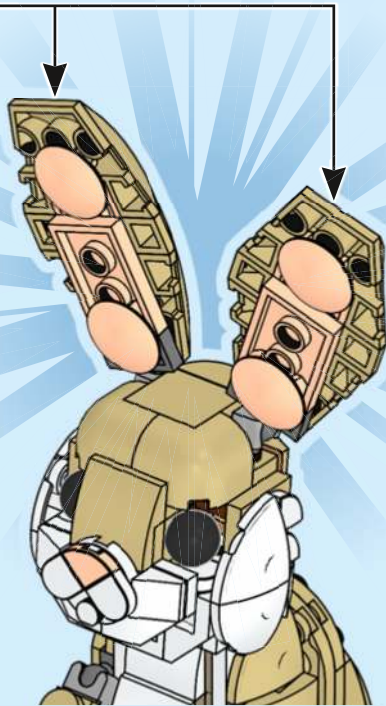



102

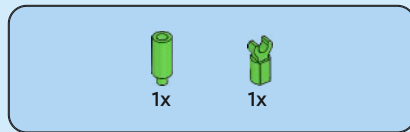

103

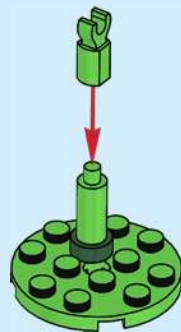



3x



1x

# 104

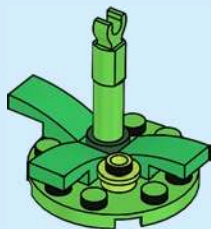



1x



4x



1x

# 105

1

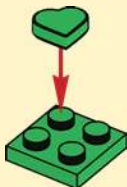

2



3

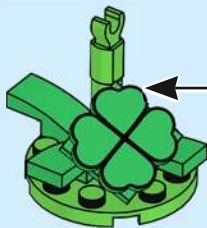

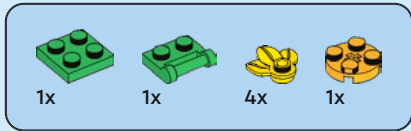

106

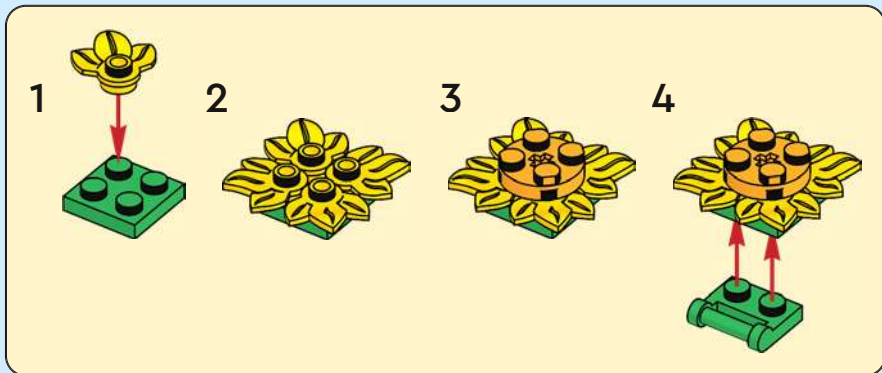

107

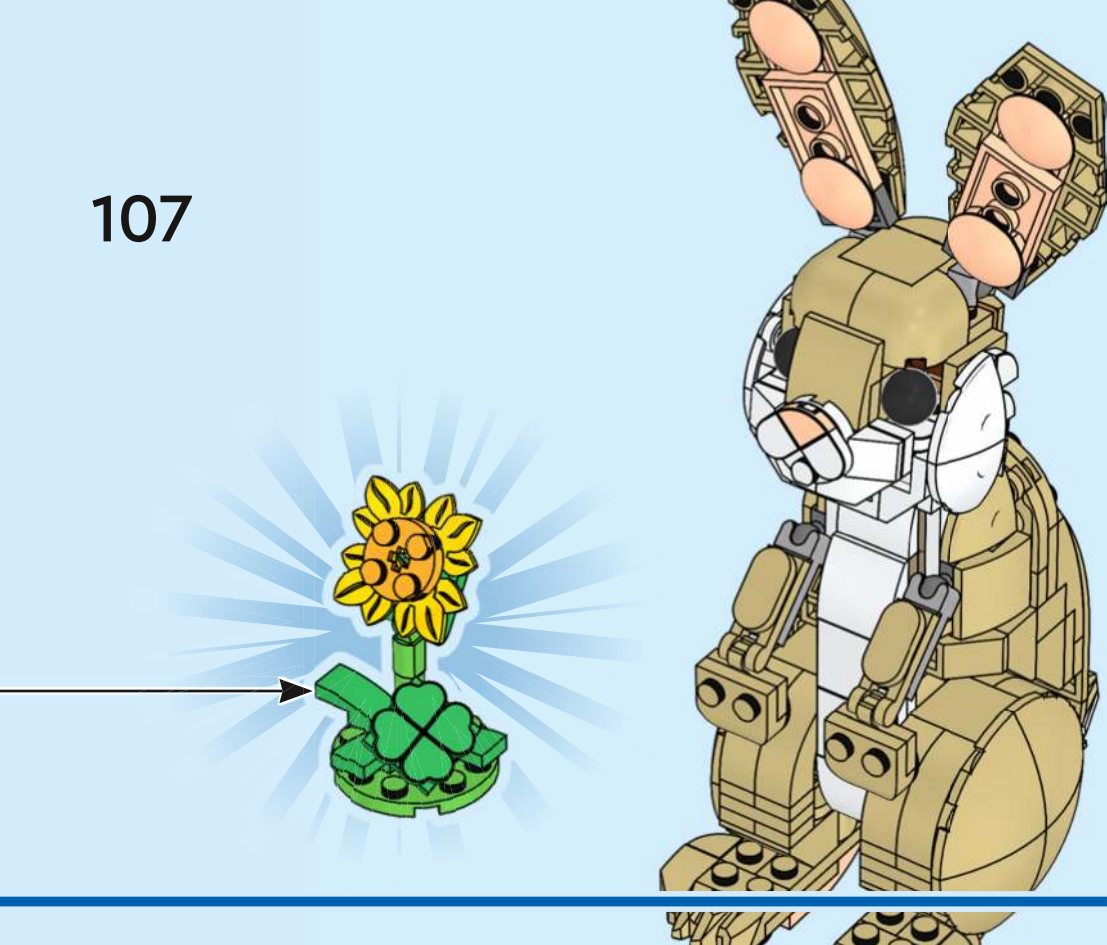

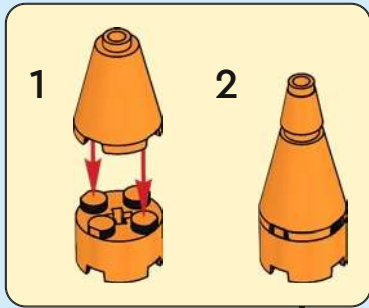
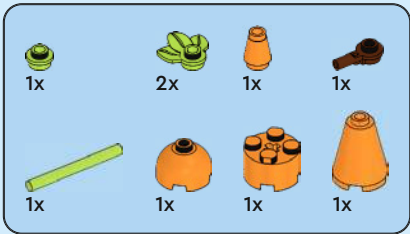

108

1



2



3



4



5



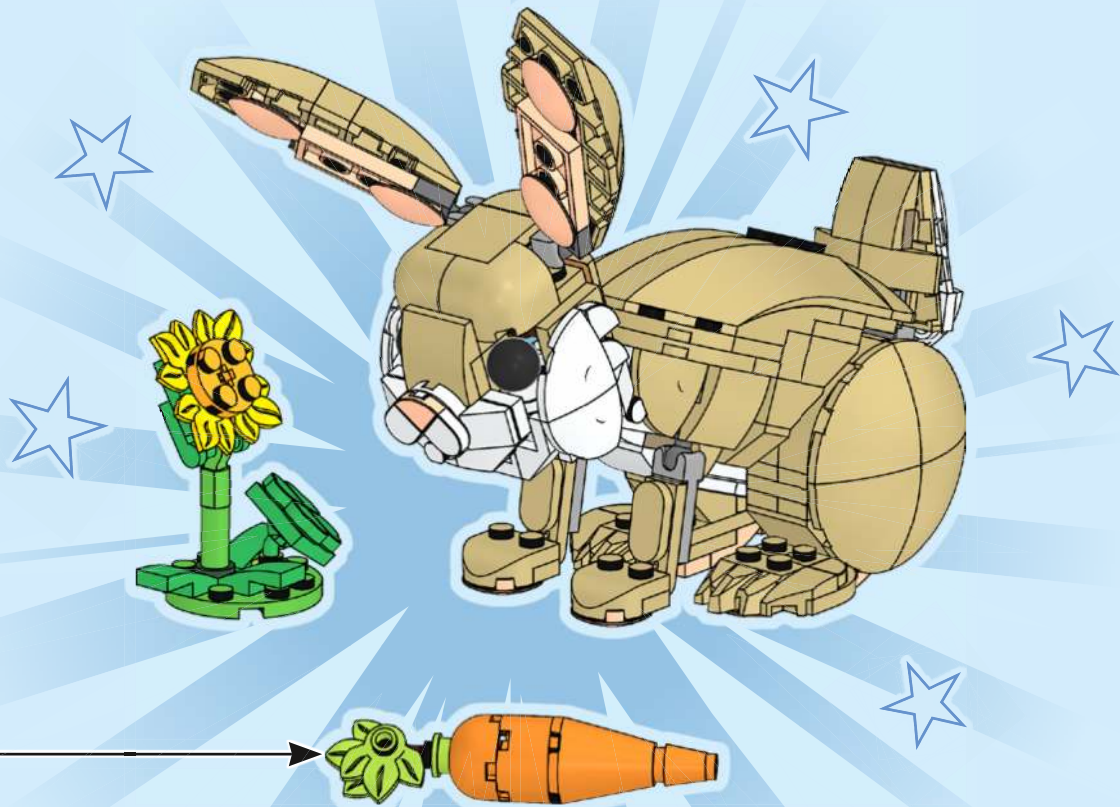

YOU COULD **WIN**



Scan this QR code or go to **LEGO.COM/PRODUCTFEEDBACK** and give us your short feedback about this LEGO® set for a chance to win a cool LEGO prize.

Terms and Conditions apply\*

**EN: YOU COULD WIN.** Terms and Conditions apply\* **DE: Du könntest GEWINNEN.** Es gelten die Teilnahmebedingungen\* **FR: Tu pourrais GAGNER.** Des conditions s'appliquent\* **IT: Potresti VINCERE tu.** Termini e condizioni sono applicabili\* **ES: Puedes GANAR.** Aplican términos y condiciones\* **PT: Poderá GANHAR.** Aplicam-se termos e condições\* **ZH: 轻松获奖. 条款和条件适用\*** **PL: Szansa na WYGRANĄ.** Obowiązują warunki korzystania\* **CS: Máte šanci VYHRÁT.** Platí všeobecné smluvní podmínky\* **SK: Máte šancu VYHRAŤ.** Platia všeobecné zmluvné podmienky\* **HU: TE IS NYERHETSZ.** Felhasználási feltételek érvényesek\* **RO: Ai putea CÂȘTIGA.** Se aplică termenii și condiții\* **BG: Можете да СПЕЧЕЛИТЕ.** Има определени правила и условия\* **LV: Tu vari LAIMĒT.** Ir spēkā noteikumi un nosacījumi.\* **ET: Sul on võimalus VÕITA.** Kehtivad tingimused\* **LT: Jūs galite LAIMĖTI.** Taikomos sąlygos\*

\*LEGO.com/productfeedback-terms