



# NINJAGO

DRAGONS RISING

71827



Q LEGO® Builder



[LEGO.com/sustainable-packaging](https://LEGO.com/sustainable-packaging)



**FR**  
**DONNEZ**  
OU  
**RECYCLEZ**

 OU  OU 

ASSOCIATION    MAGASIN    DÉCHÈTERIE

Adresses sur [quefairedemesdechets.fr](https://quefairedemesdechets.fr)



Q LEGO® Builder

# BUILDER



Apple and the Apple logo are trademarks of Apple Inc., registered in the U.S. and other countries and regions. App Store is a service mark of Apple Inc. Google Play and the Google Play logo are trademarks of Google LLC. Tencent and the Tencent logo are trademarks of Tencent Inc.

Q [LEGO.com/devicecheck](https://LEGO.com/devicecheck)

**EN** Ask parents' permission before going online | **DE** Eltern um Erlaubnis bitten, bevor du online gehst | **FR** Demande l'autorisation d'un parent avant d'aller en ligne | **IT** Chiedi il permesso ai tuoi genitori prima di andare online | **ES** Pídeles permiso a tus papás antes de conectarte a Internet | **PT** Peça autorização aos pais antes de acederes online | **ZH** 上网前应先征得父母的同意 | **PL** Poproś rodziców o zgodę, zanim wejdiesz do Internetu | **CS** Než půjdeš na internet, požádej rodiče o svolení | **SK** Skôr než pôjdeš na internet, vypýtaj si povolenie od rodičov | **HU** Kérj szülői engedélyt, mielőtt online csatlakoznál! | **RO** Cere permisiunea părinților înainte de a te conecta online | **BG** Поискайте разрешение от родител, преди да влезете онлайн | **LV** Pirms došanās tiešsaistē palūdz atļauju vecākiem | **ET** Enne Interneti kasutamist küsi vanematelt luba | **LT** Prieš prisijungdami prie interneto, atsiklauskite tėvų





**EN** Build It Your Way | **DE** Bau, wie du willst | **FR** Construisez à votre façon | **IT** Costruiscilo come vuoi tu  
| **ES** Constrúyelo a tu manera | **PT** Constrói à Tua Maneira | **ZH** 自由拼搭 | **PL** Zbuduj po swojemu | **CS** Postavte to po  
svém | **SK** Postavte to po svojom | **HU** Építs kedved szerint! | **RO** Construięte așa cum doreęti | **BG** Постройте го  
по своя начин | **LV** Būvē tieši tā, kā vēlies | **ET** Ehita enda moodi | **LT** Sukonstruokite savaip

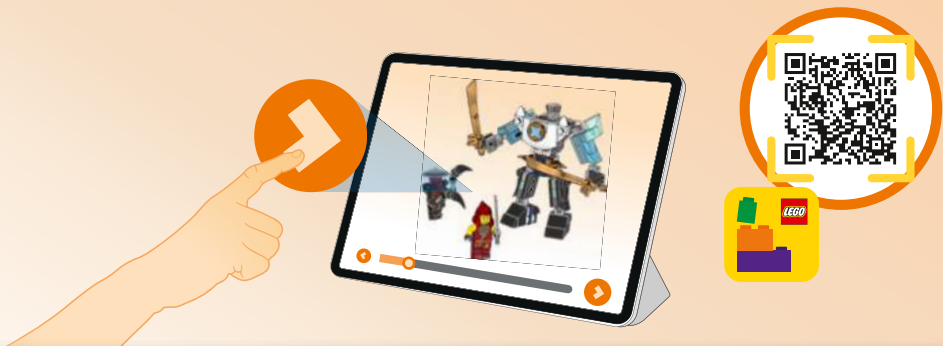

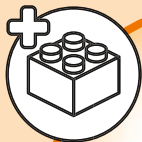

1x

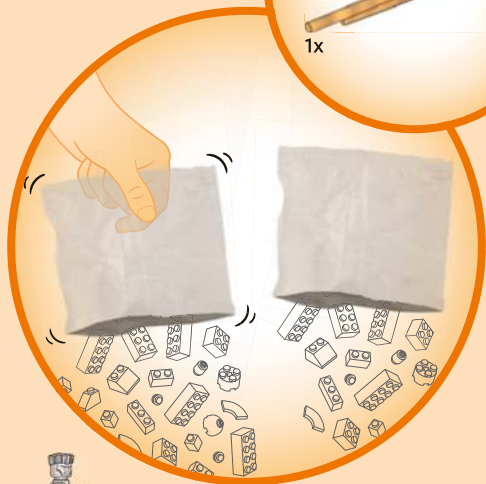

1

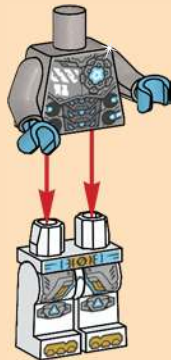

6



2



3

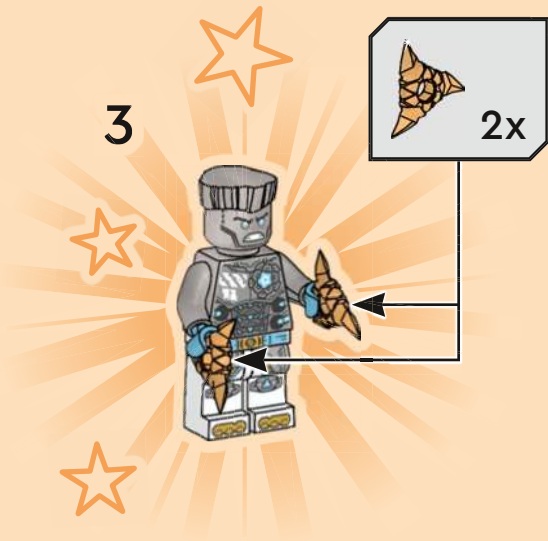

1

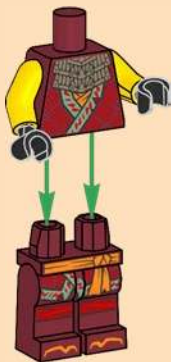

2



3



1

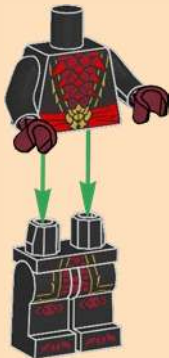

2



3



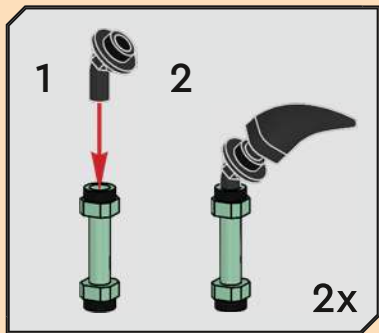

4



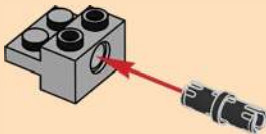
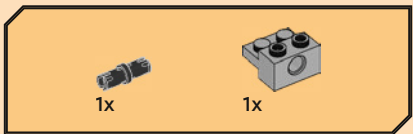

1





2

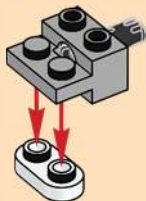

3

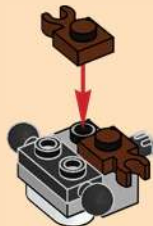



1x



1x

4





5



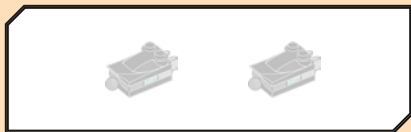

6





1x



1x

7

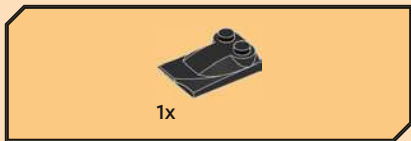

1x

8

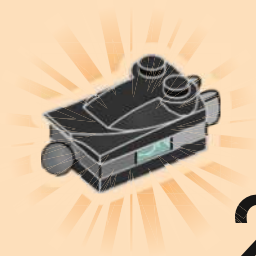

2x

9

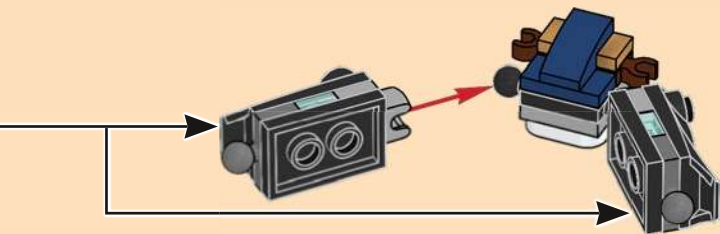



10



11





1x

12





1x

13



1x

14

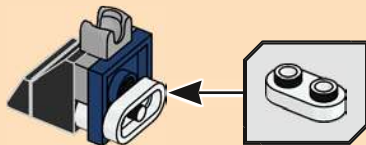



15

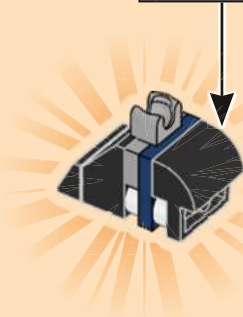
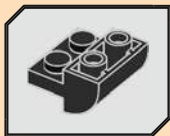

2x



16

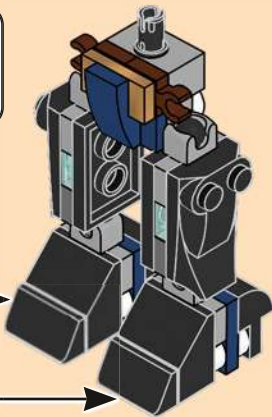

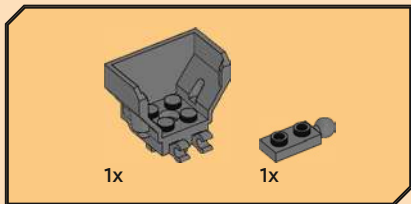
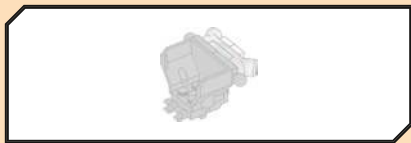

17

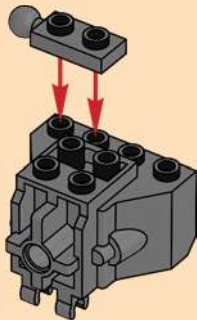



1x

18

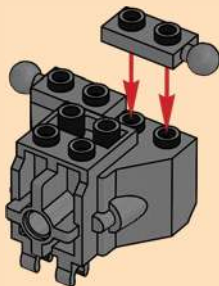

1x

19

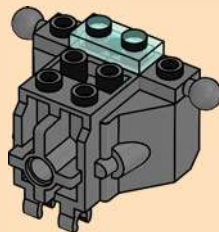

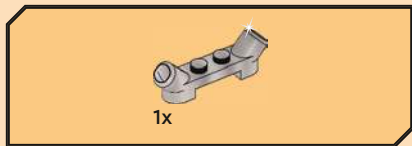

20

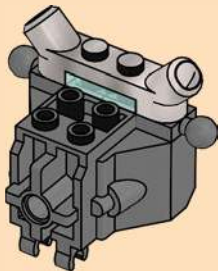



2x

21

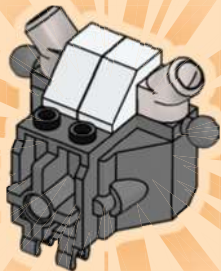

22

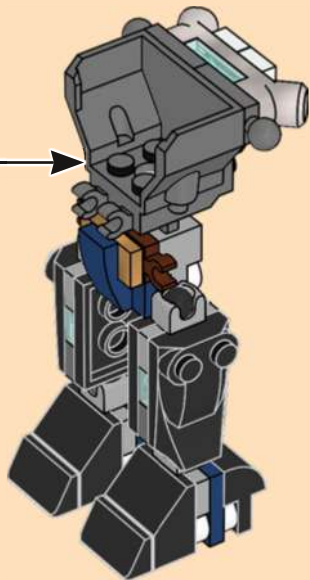



23



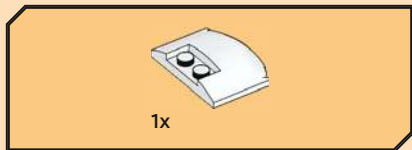

24





1x

25

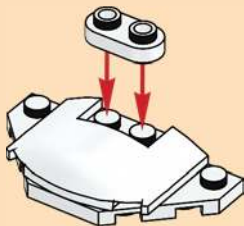

1x

26





2x

27

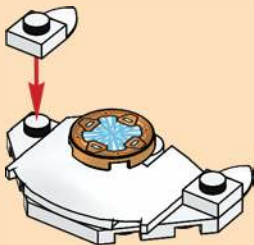



2x

28



1x

29



30

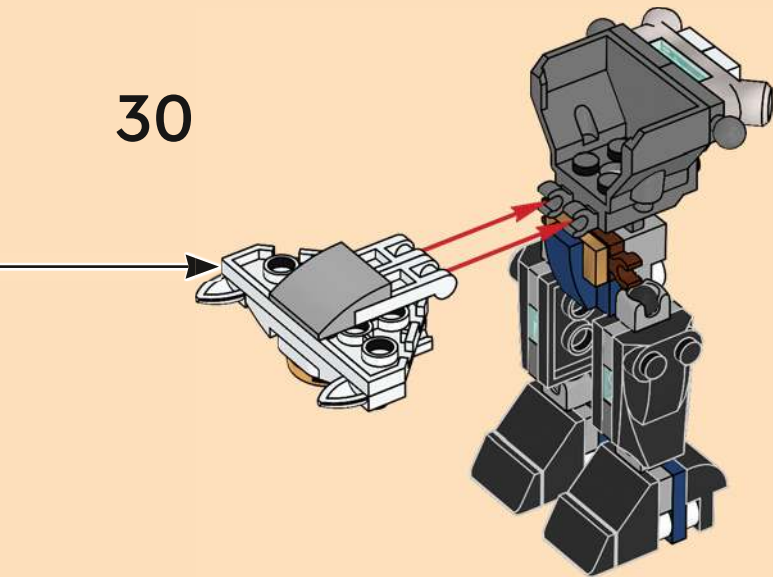

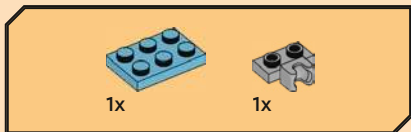

31

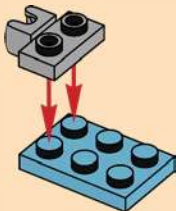

32



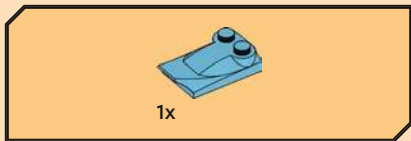

33

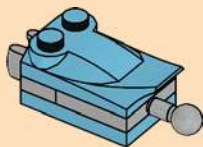

34

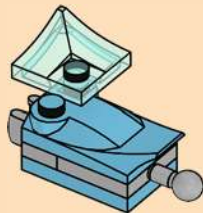



1x

35



1x



1x

36



37

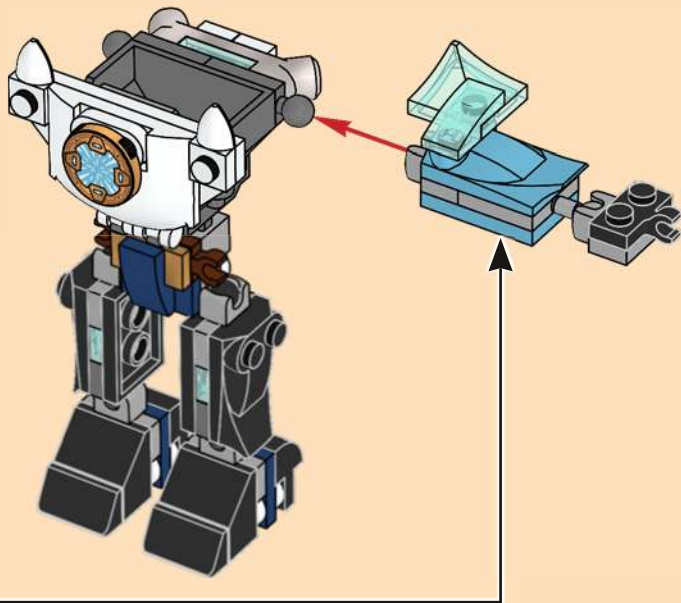

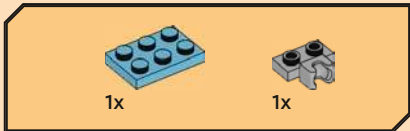

38



39



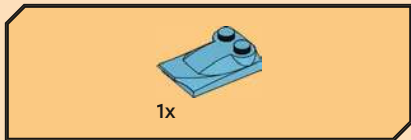

40

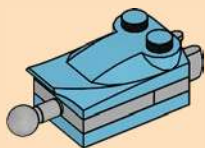

41

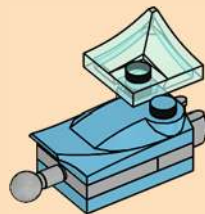



1x

42



1x



1x

43

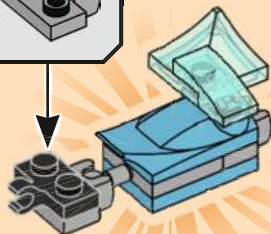
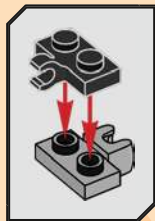

44

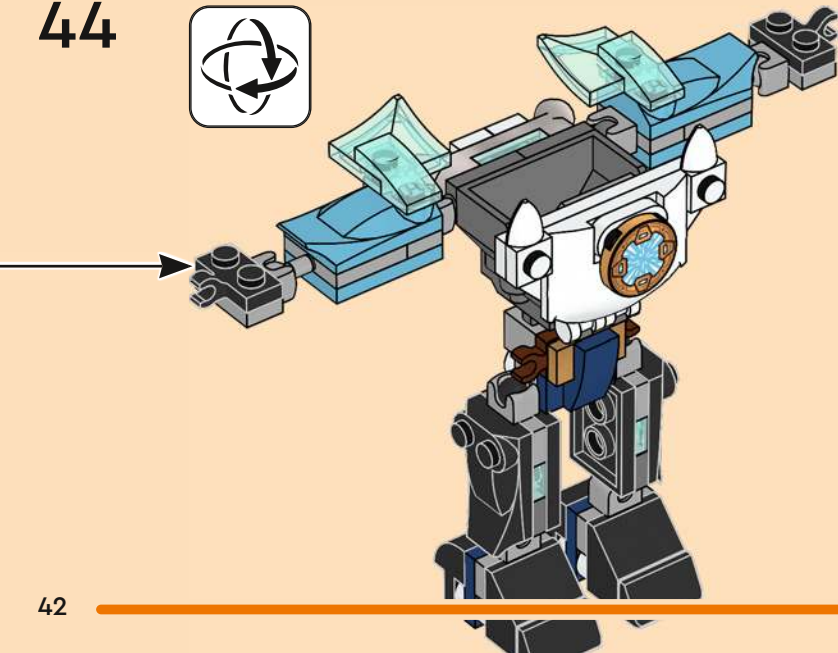



1x



1x

# 45

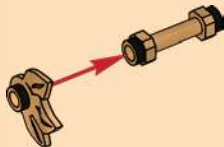

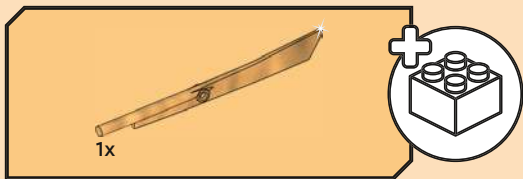

46



2x

47

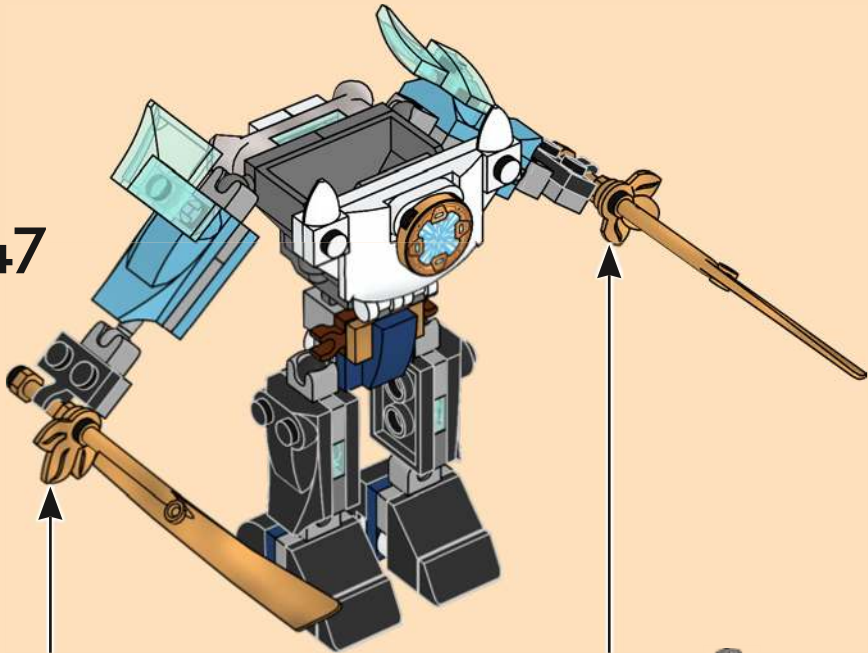

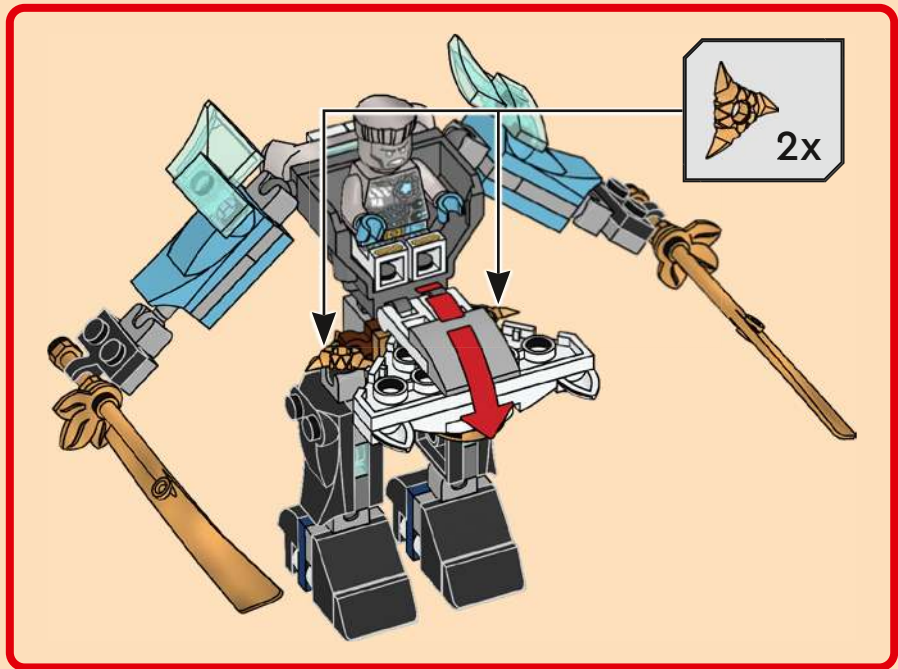







71823



71824



71826



71830



71834



71833



71841



2x  
4224792



6x  
6210272



1x  
6518755



2x  
6166894



2x  
4515364



1x  
6018101



1x  
241901

50



1x  
6478060



2x  
6510193



2x  
6270091



2x  
4548180



1x  
6279875



1x  
6518758



2x  
6313116



1x  
6416838



2x  
303926



2x  
6458098



1x  
6524932



1x  
6525595



2x  
302126



2x  
4285883



1x  
6474604



1x  
6215718



1x  
6320779



1x  
6525722



1x  
4632100



1x  
6092588



1x  
6094143



2x  
6037890



1x  
6521182



2x  
6378168



2x  
6219088



1x  
6518759



1x  
6092594



1x  
6114925



2x  
6270131



2x  
4619513



2x  
6439464



1x  
6434461



1x  
6518756



1x  
6473850



1x  
6482044



8x  
6043656



1x  
6326478



1x  
6185676



2x  
6448319



2x  
6039479



2x  
6123814



1x  
6397284



1x  
6384443



2x  
6337003



3x  
6514007



2x  
6508249



2x  
6527412



[LEGO.com/service](https://www.LEGO.com/service)

YOU COULD  
**WIN**



Scan this QR code or go to  
**LEGO.COM/PRODUCTFEEDBACK** and give us  
your short feedback about this LEGO® set  
for a chance to win a cool LEGO prize.

Terms and Conditions apply\*

**EN: YOU COULD WIN.** Terms and Conditions apply\* **DE: Du könntest GEWINNEN.** Es gelten die Teilnahmebedingungen\* **FR: Tu pourrais GAGNER.** Des conditions s'appliquent\* **IT: Potresti VINCERE tu.** Termini e condizioni sono applicabili\* **ES: Puedes GANAR.** Aplican términos y condiciones\* **PT: Poderá GANHAR.** Aplicam-se termos e condições\* **ZH: 轻松获奖.** 条款和条件适用\* **PL: Szansa na WYGRANĄ.** Obowiązują warunki korzystania\* **CS: Máte šanci VYHRÁT.** Platí všeobecné smluvní podmínky\* **SK: Máte šancu VYHRÁT.** Platia všeobecné zmluvné podmienky\* **HU: TE IS NYERHETSZ.** Felhasználási feltételek érvényesek\* **RO: Ai putea CÂȘTIGA.** Se aplică termenii și condiții\* **BG: Можете да СПЕЧЕЛИТЕ.** Има определени правила и условия\* **LV: Tu vari LAIMĒT.** Ir spēkā noteikumi un nosacījumi.\* **ET: Sul on võimalus VÕITA.** Kehtivad tingimused\* **LT: Jūs galite LAIMĖTI.** Taikomos sąlygos\*

\*[LEGO.com/productfeedback-terms](https://www.lego.com/productfeedback-terms)