

5.

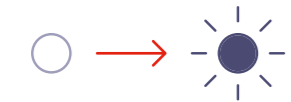

• clever you

# Trust.

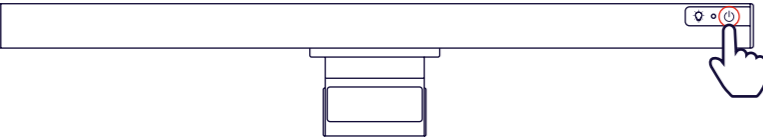
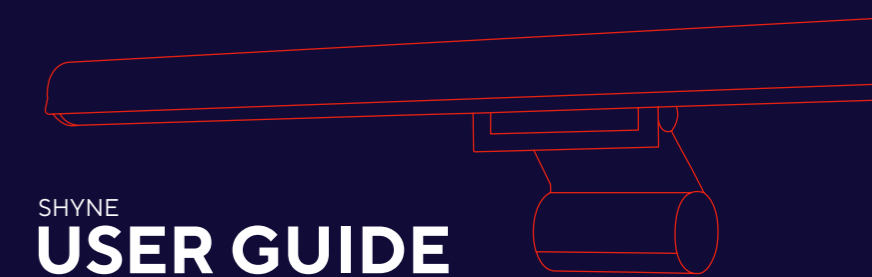

SHYNE  
**USER GUIDE**  
 Monitor light bar

**FAQ**

[WWW.TRUST.COM/25483/FAQ](http://WWW.TRUST.COM/25483/FAQ)  
 Trust International BV - Laan van Barcelona 600 - 3317DD, Dordrecht, The Netherlands  
 ©2024 Trust All rights reserved.

Bedienungsanleitung | Mode d'emploi | Gebruikershandleiding | Manuale utente | Manual del usuario | Guia do utilizador | Brukerveiledning |  
 Bruksanvisning | Käyttöopas | Brugsvejledning | Instrukcja obsługi | Návod k použití | Návod na používanie | Használati útmutató | Manual de  
 utilizare | Ръководство за потребителя | Εγχειρίδιο χρήσης | Kullanıcı kılavuzu | Руководство пользователя | Uporabniški priročnik | Korisnički  
 priručnik | Guia do usuário | Посібник користувача | مدد دسترس آسان

1.

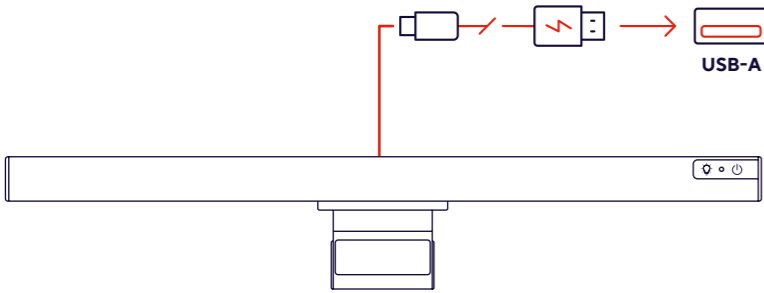

2.

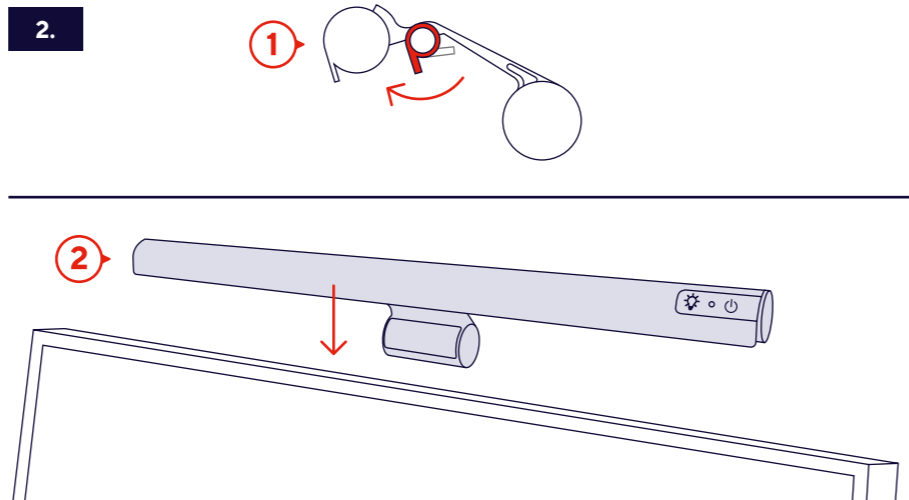

3.

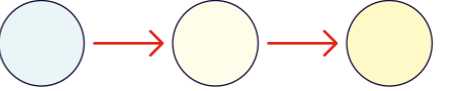
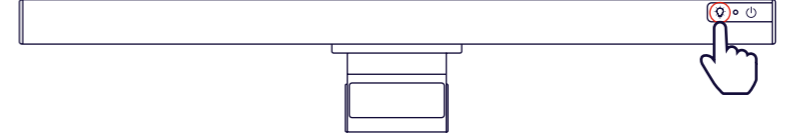

4.

