

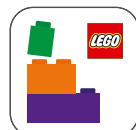

77246

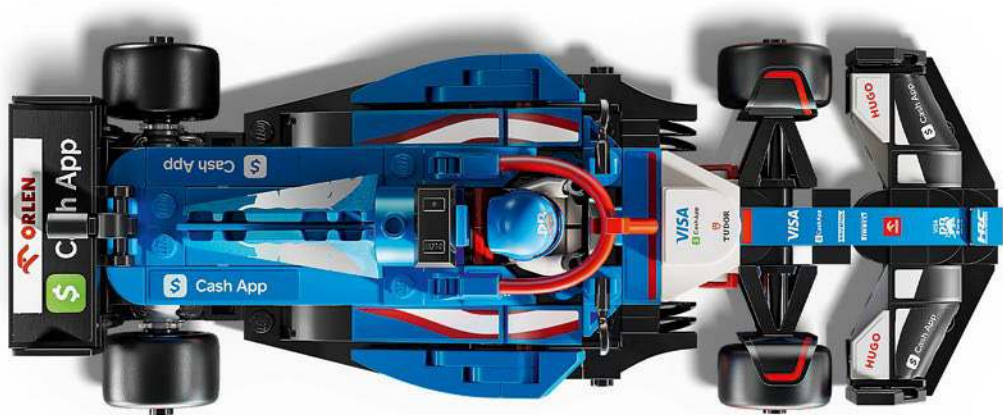

Q LEGO® Builder





LEGO.com/sustainable-packaging



 **FR**
DONNEZ
OU
RECYCLEZ

 OU  OU 

ASSOCIATION MAGASIN DÉCHÈTERIE

Adresses sur quefairedemesdechets.fr



BUILDER



Apple and the Apple logo are trademarks of Apple Inc., registered in the U.S. and other countries and regions. App Store is a service mark of Apple Inc. Google Play and the Google Play logo are trademarks of Google LLC. Tencent and the Tencent logo are trademarks of Tencent Inc.

Q LEGO.com/devicecheck



Q LEGO® Builder



Clutch power:
250 g (0.5 lbs)/LEGO® stud*



*The strength and stability with which
LEGO bricks connect and stay together.



Horsepower:
900+ BHP



Pferdestärke: 900+ Bremsleistung | Puissance : plus de 900 ch | Cavalli vapore: 900+ CV | Potencia: >900 BHP | Potência: +900 BHP | 马力:900+ 制动马力 | Moc: co najmniej 900 BHP | Výkon: Nad 900 BHP | Výkon: > 900 koní | Lóerő: 900+ féklóerő (BHP) | Cai putere: 900+ BHP | Конски сили: 900+ BHP | Zirgspēks: 900+ BHP | Hobujūd: 900+ BHP | Arklio galios: mažiausiai 900 BHP

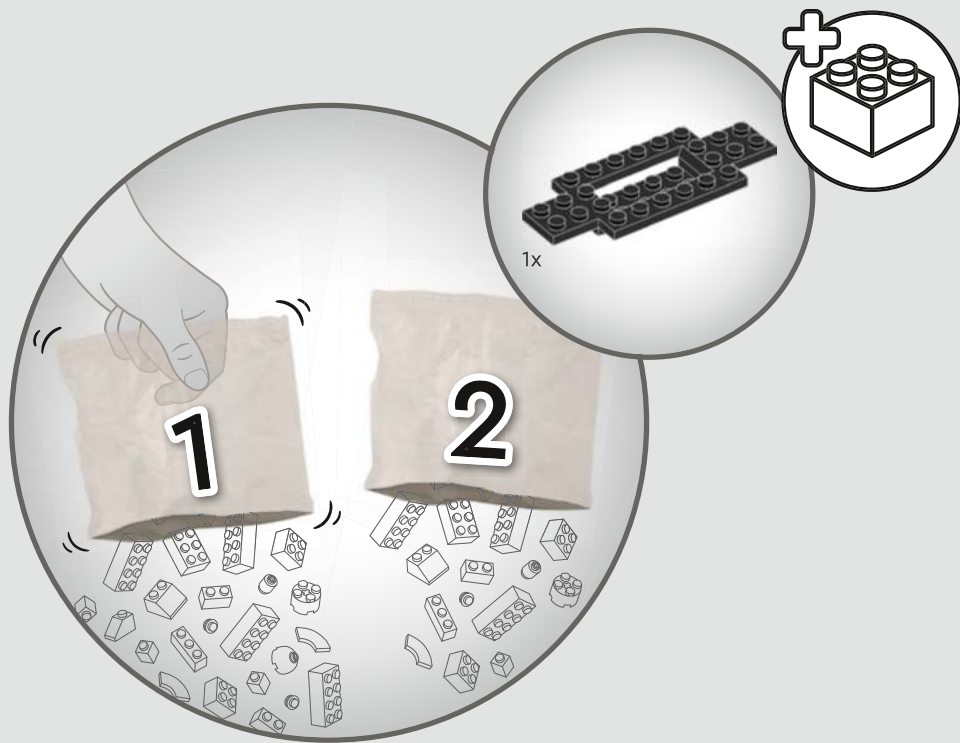

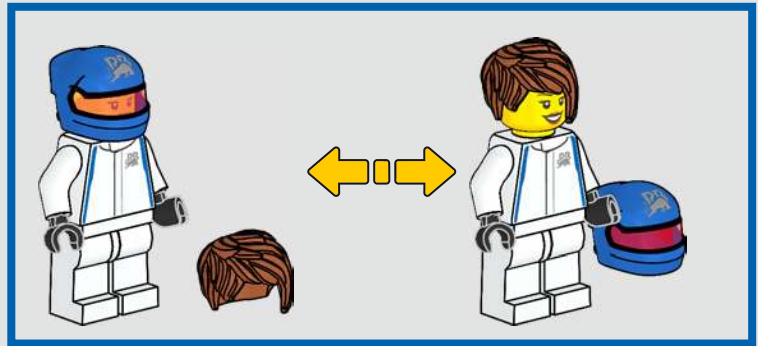

1

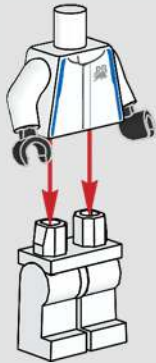

2

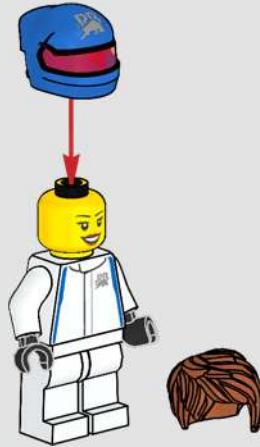

3



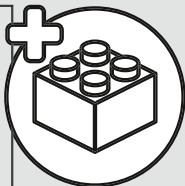
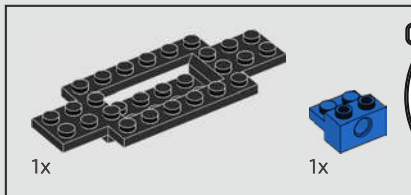

1

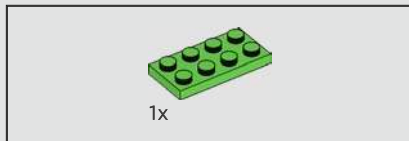
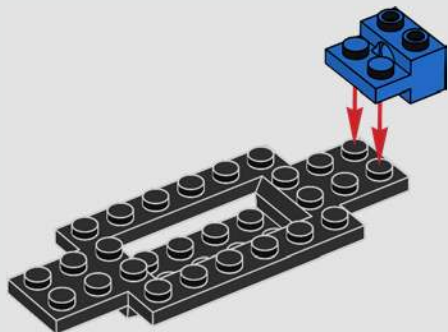

2

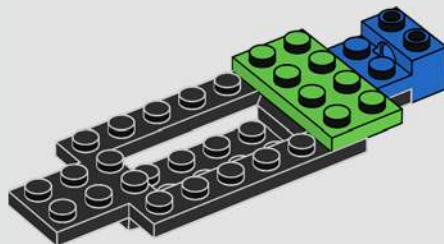

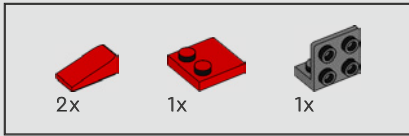

3

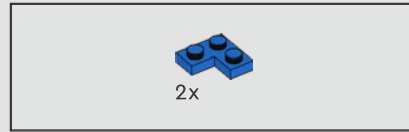
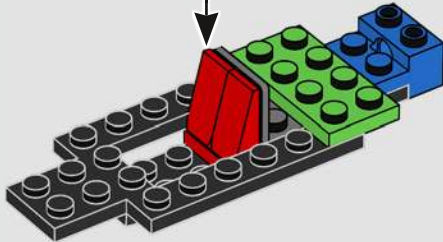
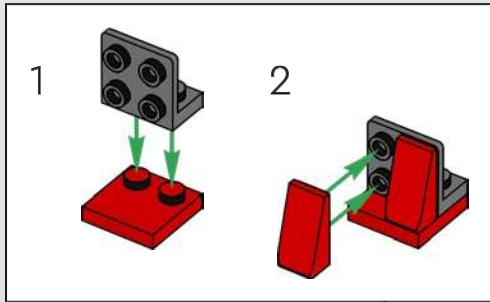

4

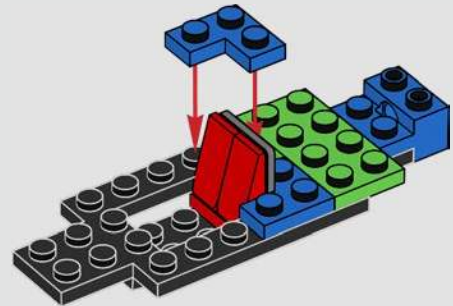

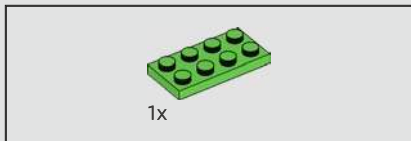

5

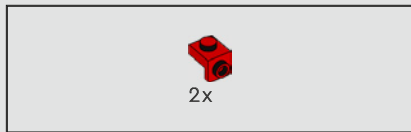
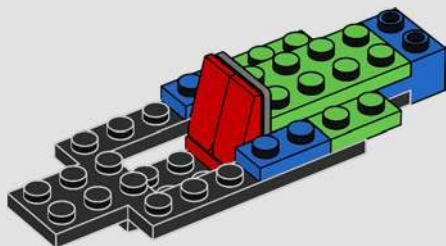

6

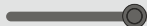
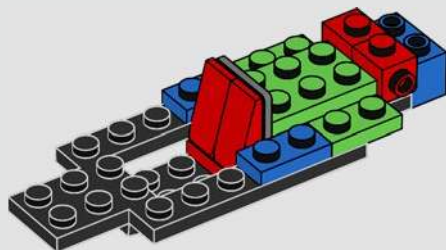



7

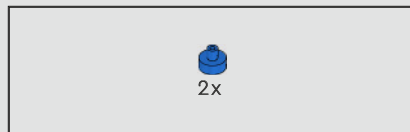
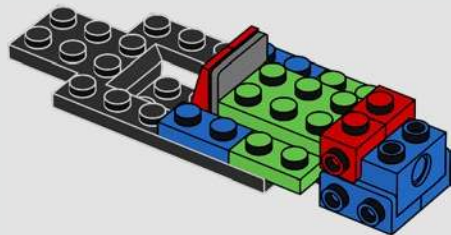

8

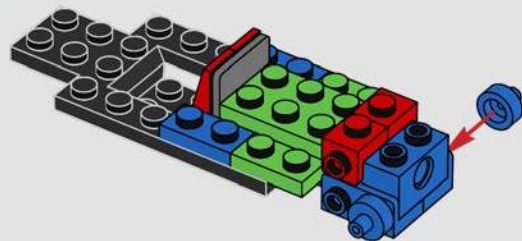

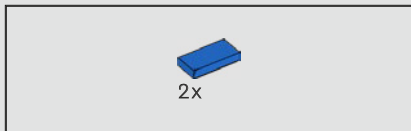

9

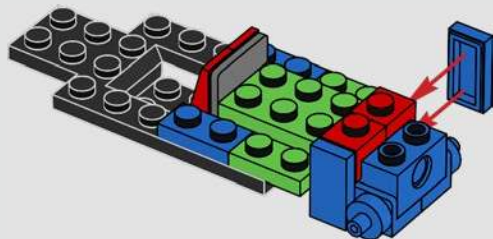

10

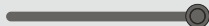
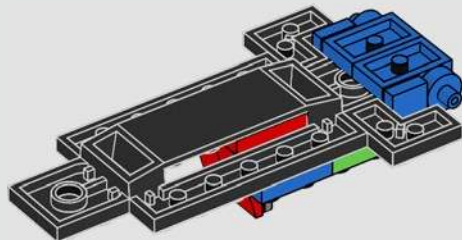

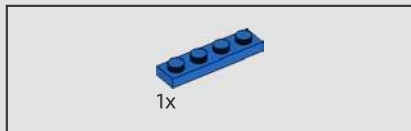

11

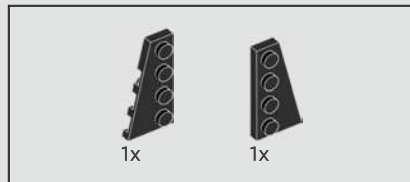
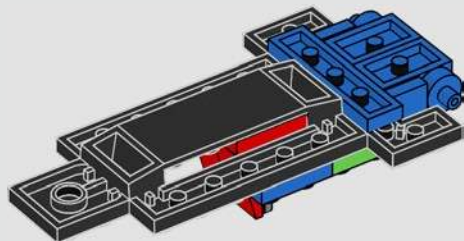

12

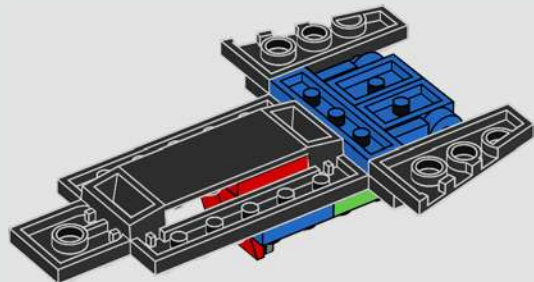

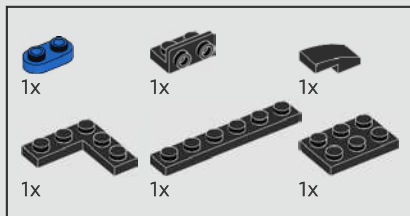

13

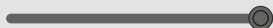
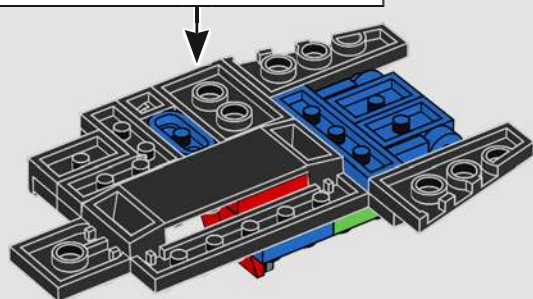
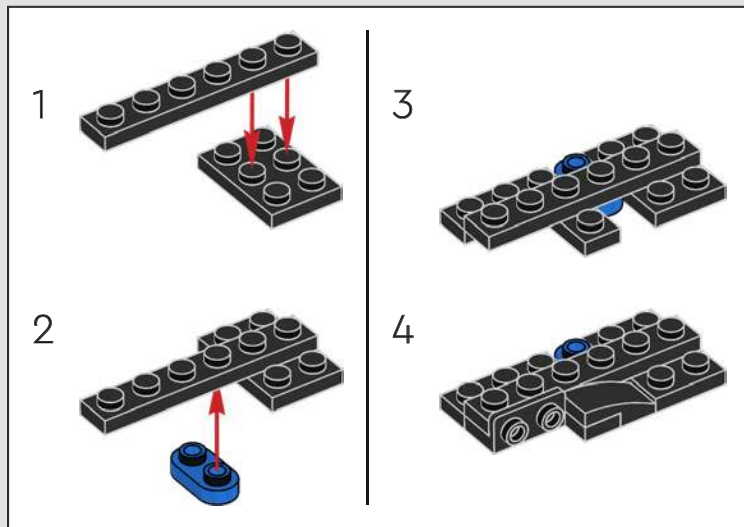

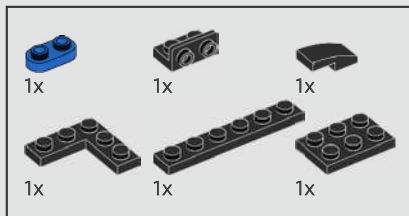

14

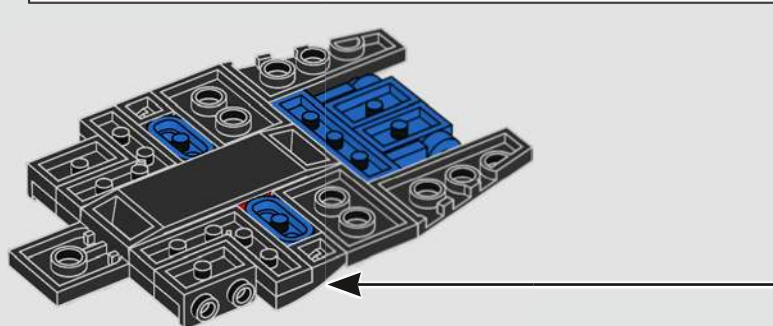
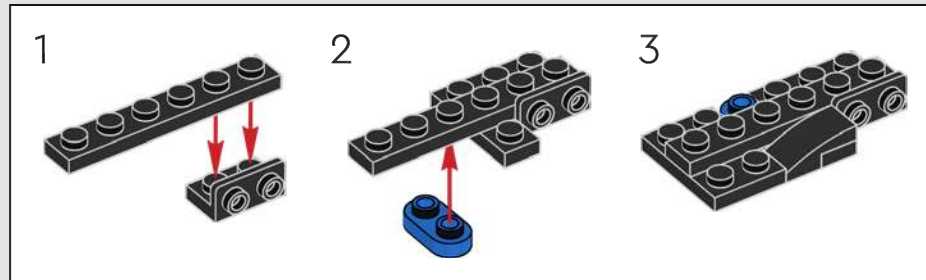

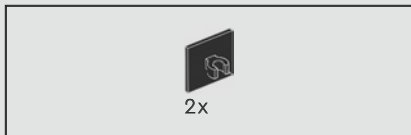

15

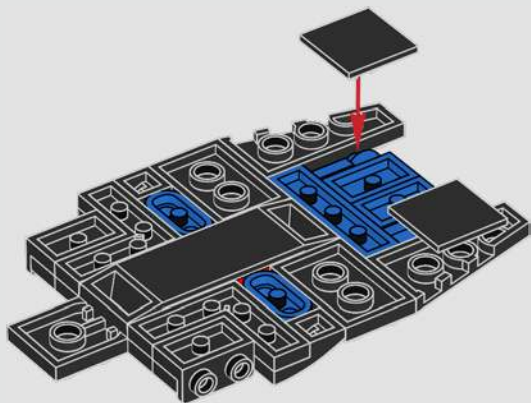

16

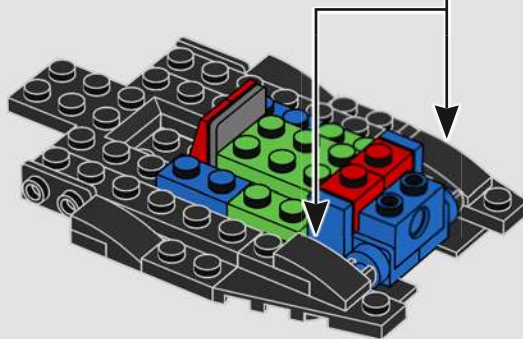

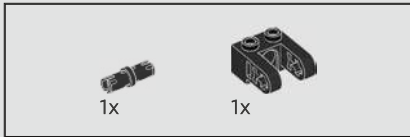

17

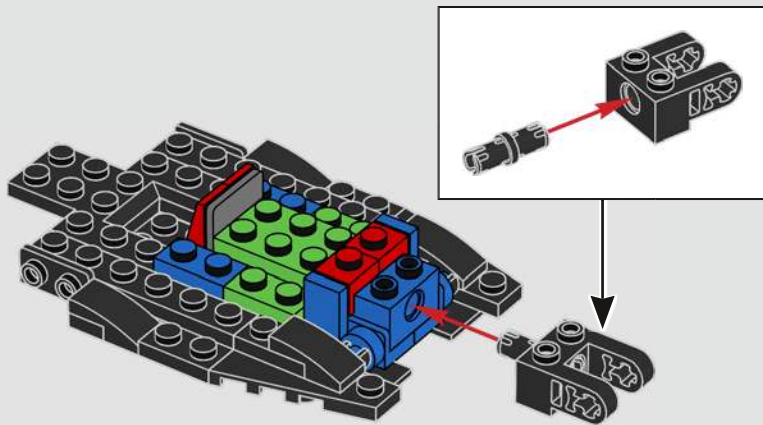



18

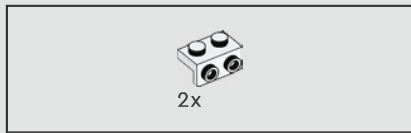
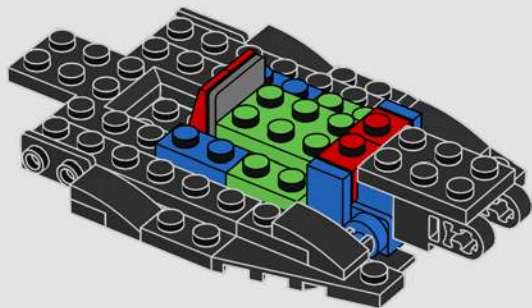

19

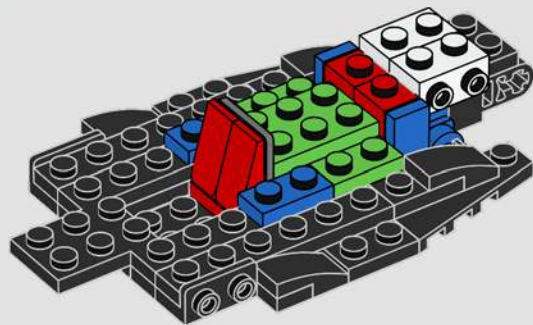

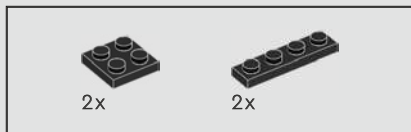

20

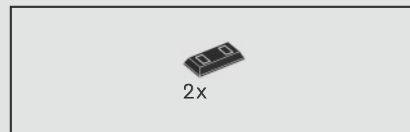
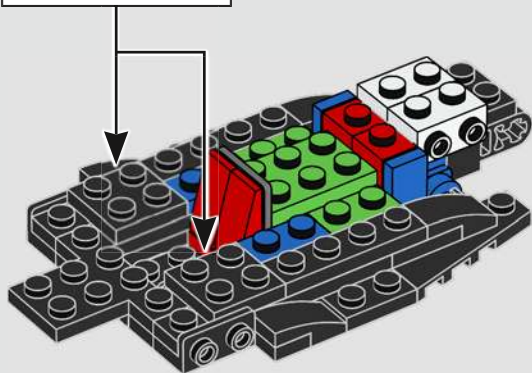

21

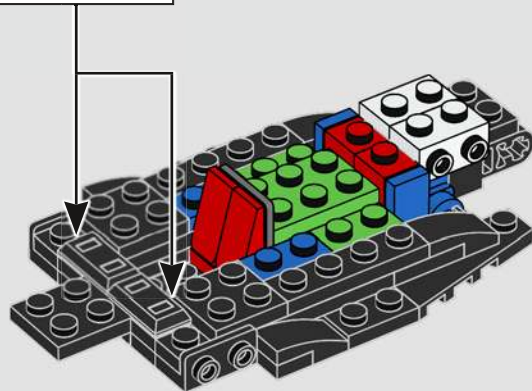

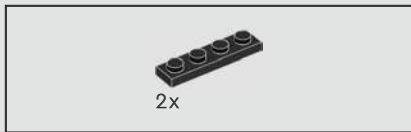

22

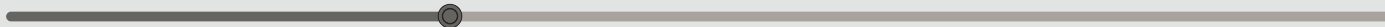
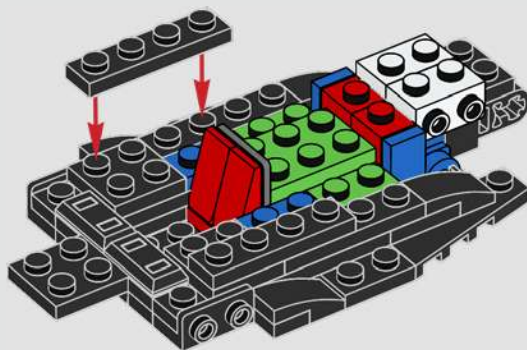



24

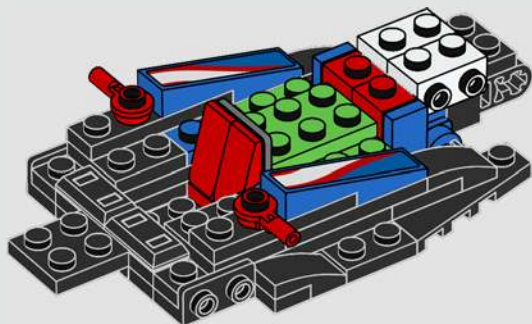

25

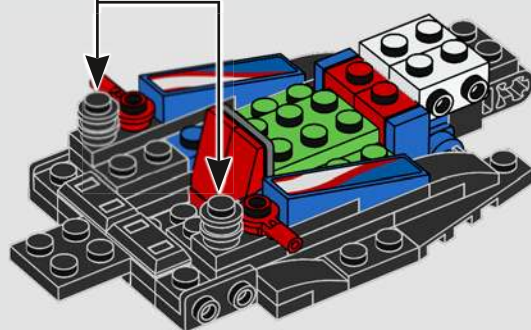
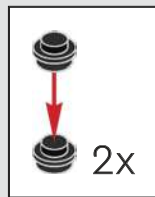

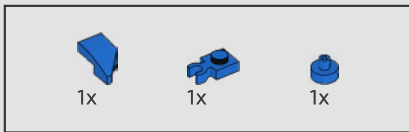

26

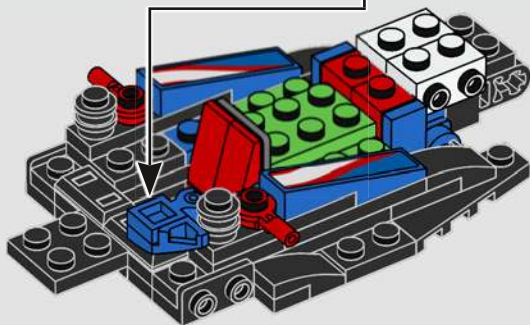
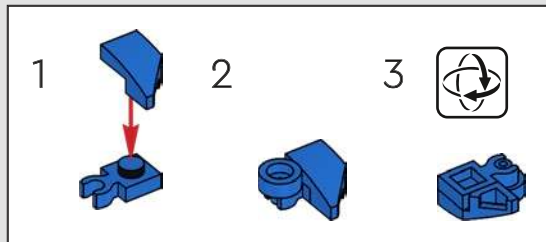

27

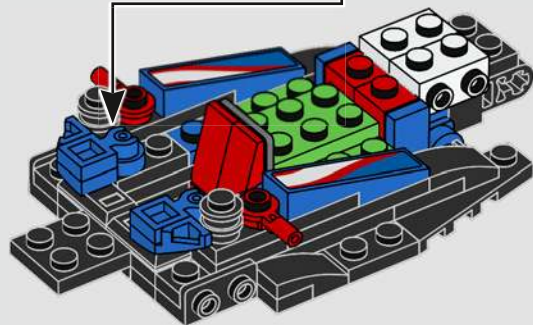
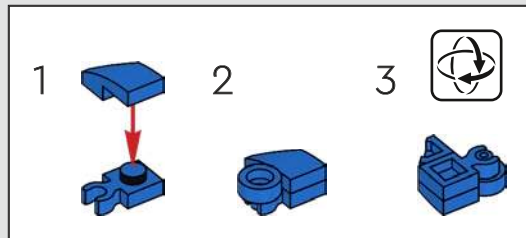

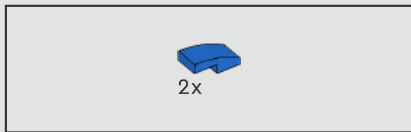

28

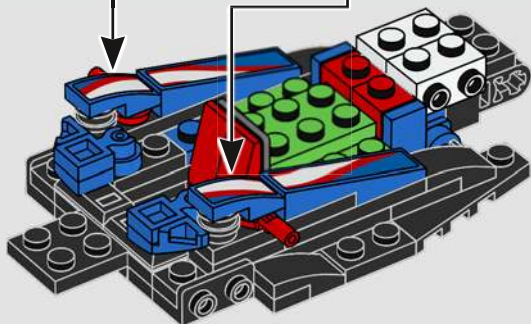
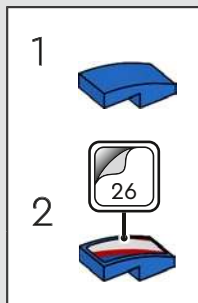
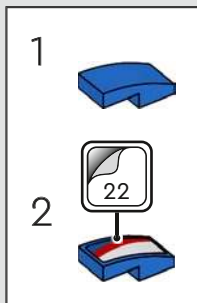

29

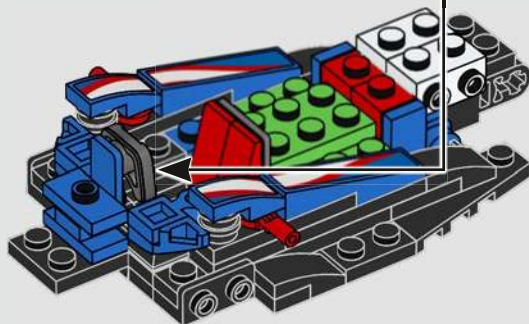
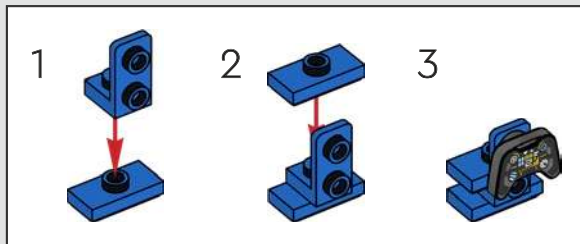

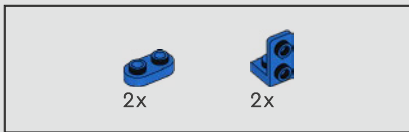

30

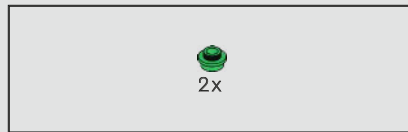
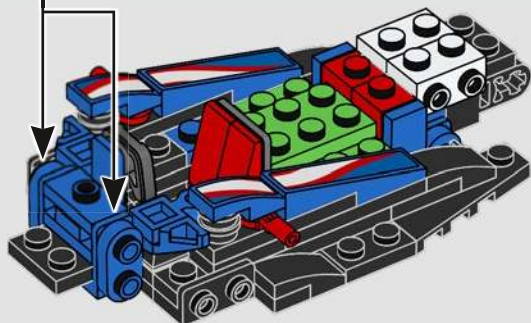
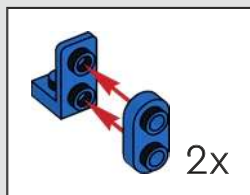

31

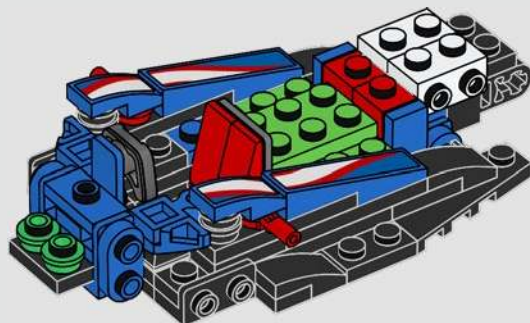



1x

32

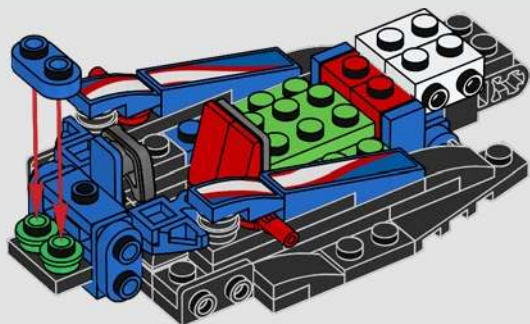

2x

33

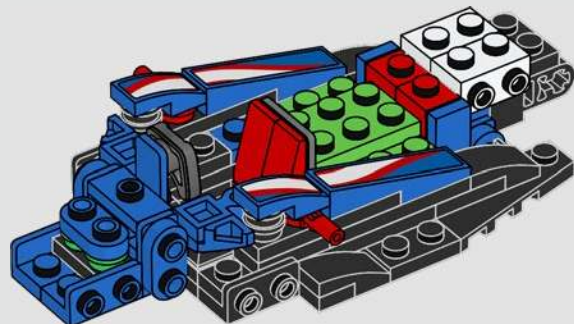



1x

34

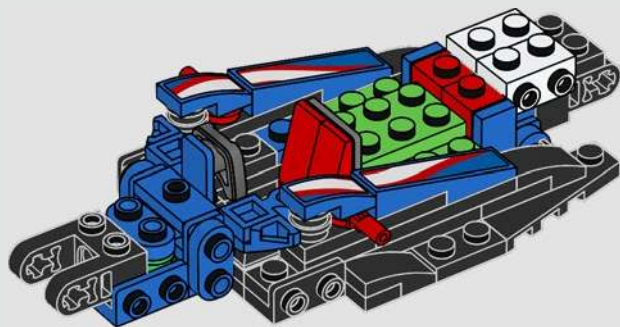

2x

35

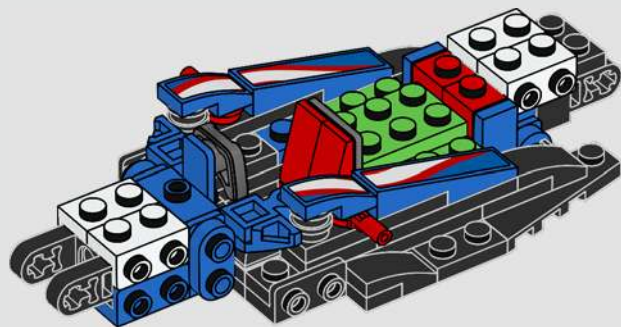

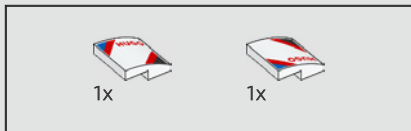

36

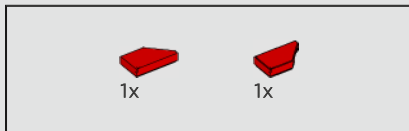
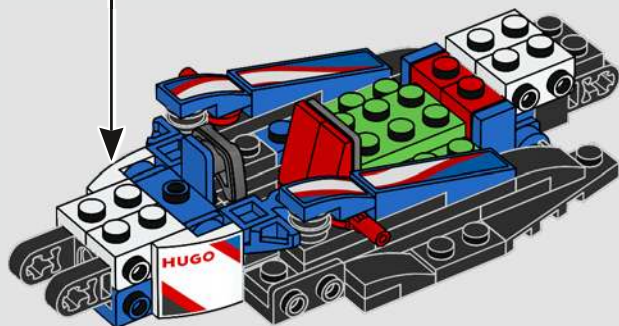

37

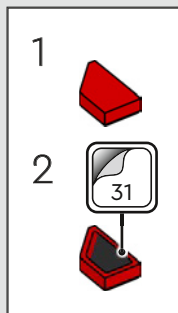

2

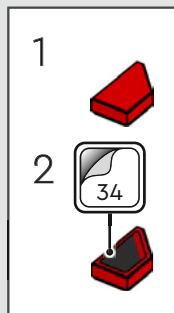

2

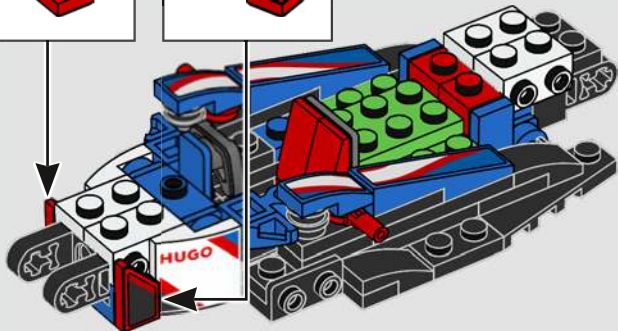

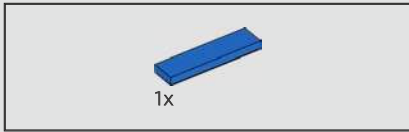

38

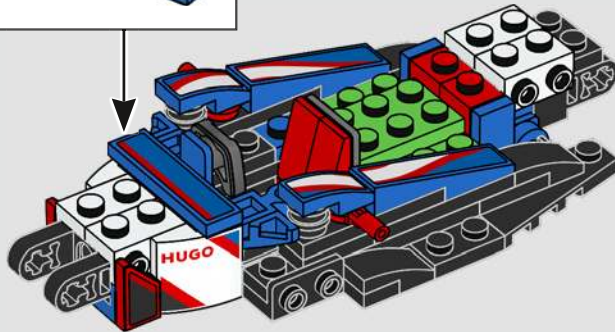
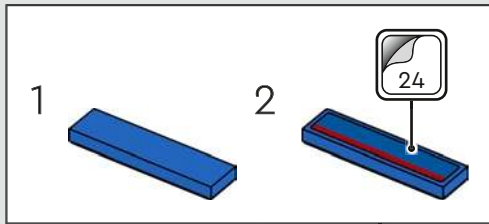

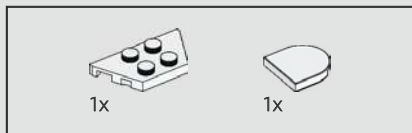

39

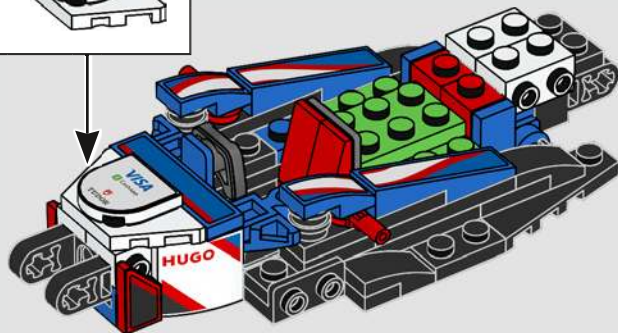
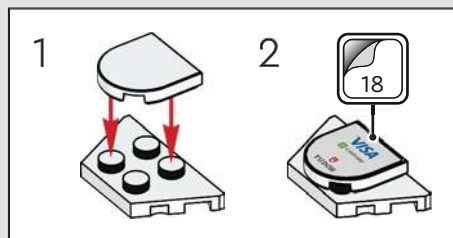



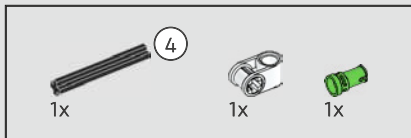

40

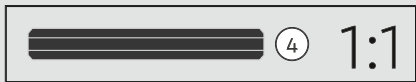
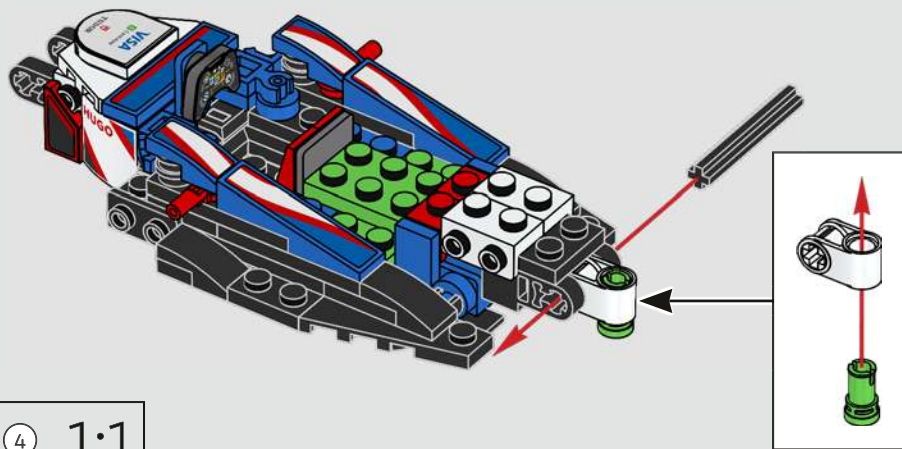



4x

41

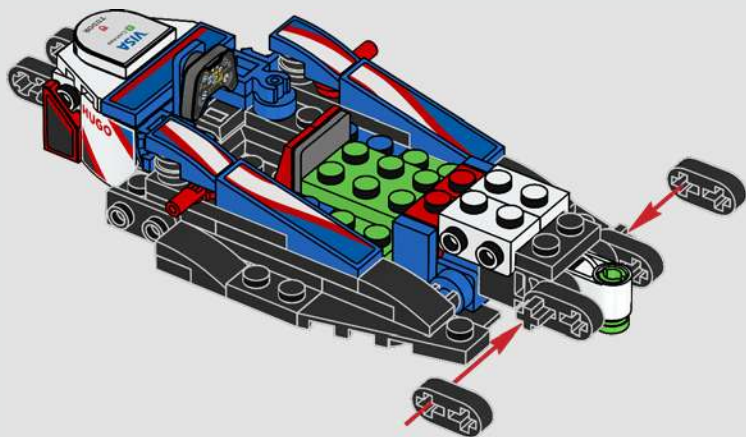

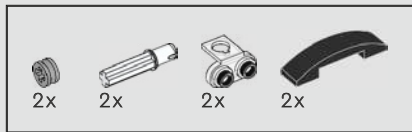

42

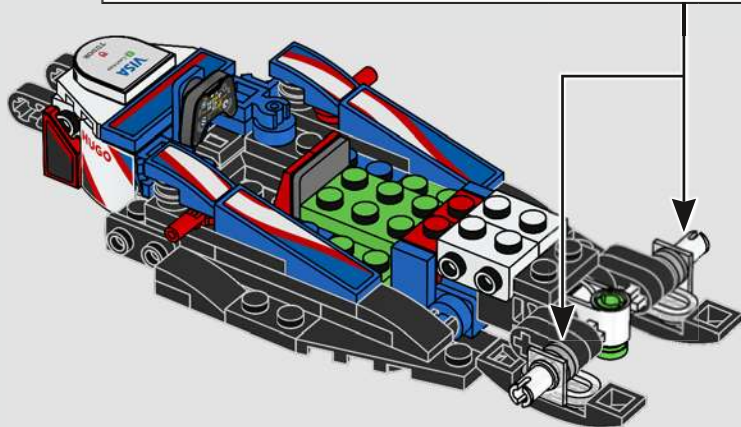
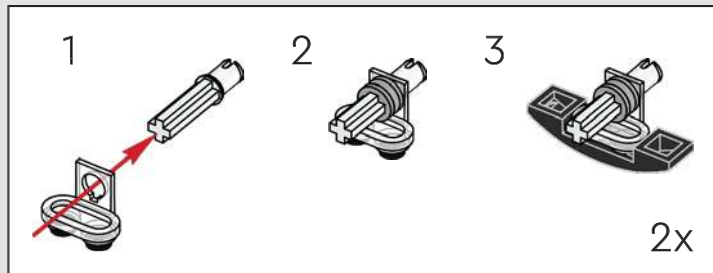



1x

43

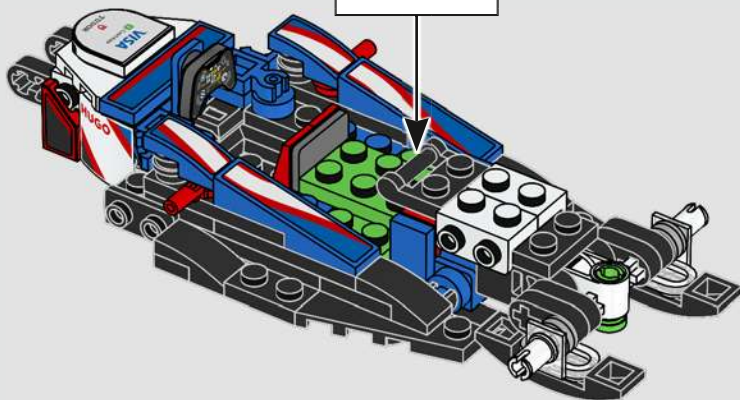



2x

44

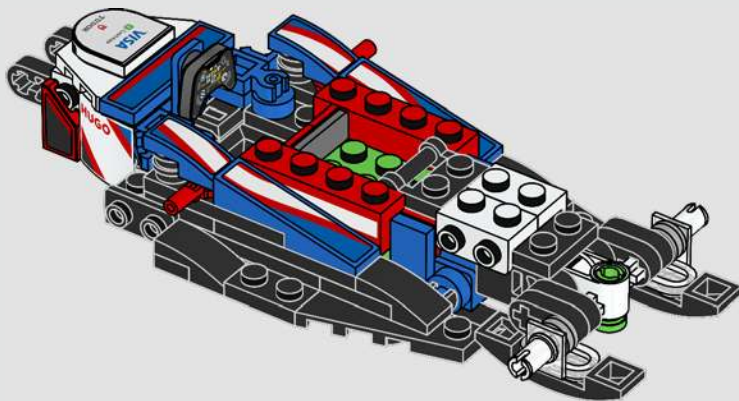

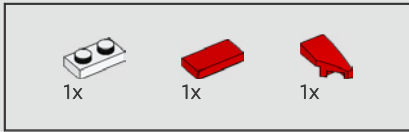

45

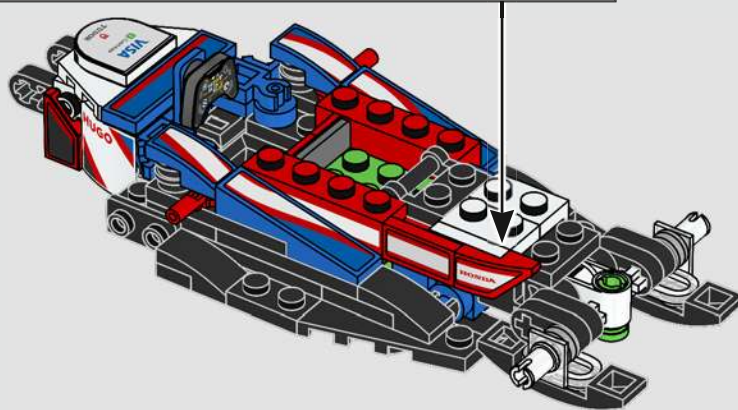
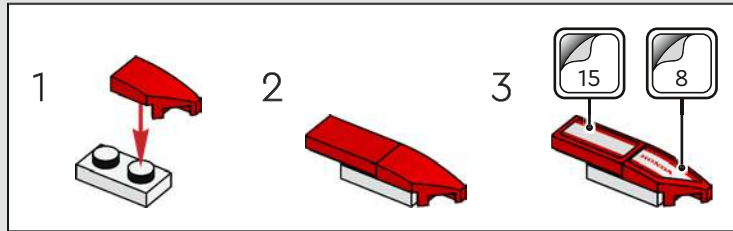

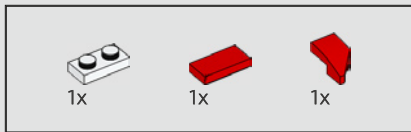

46

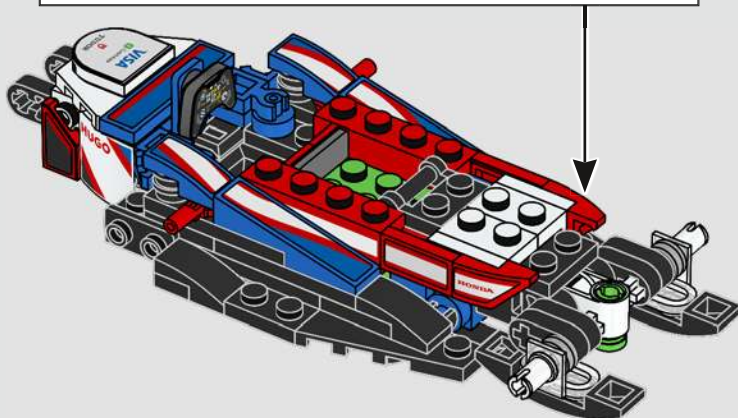
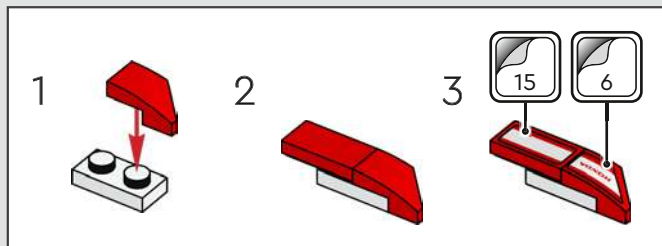

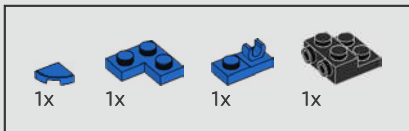

47

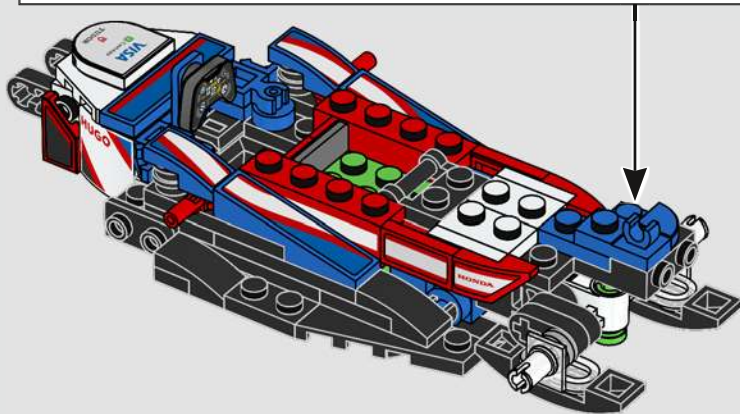
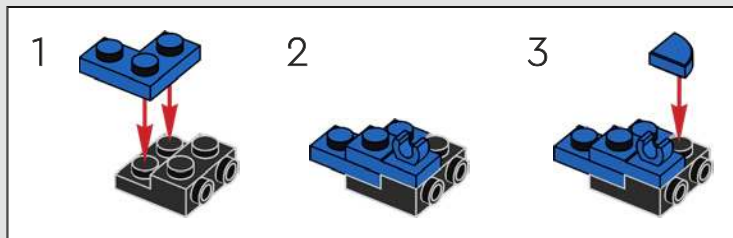

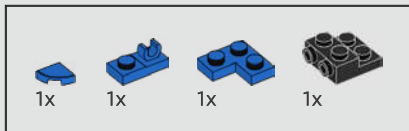

48

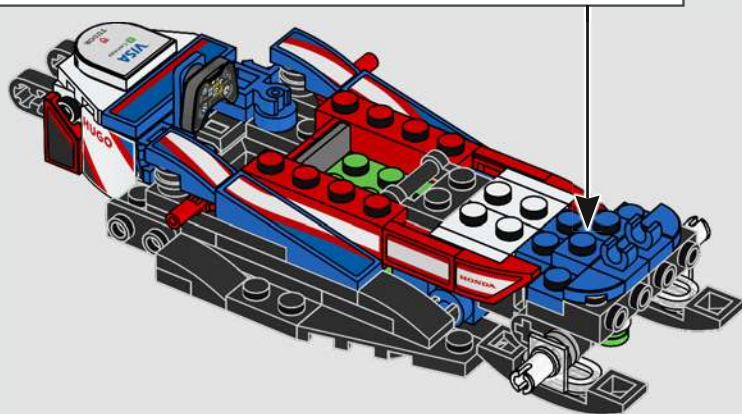
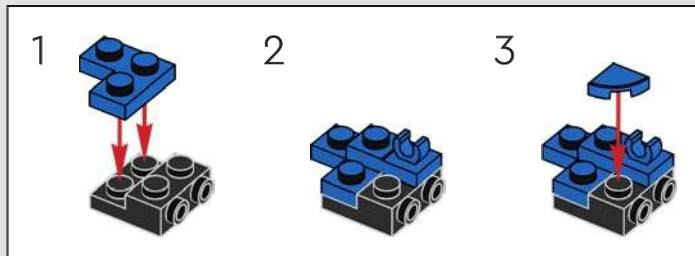

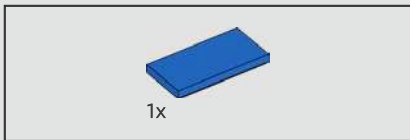

49

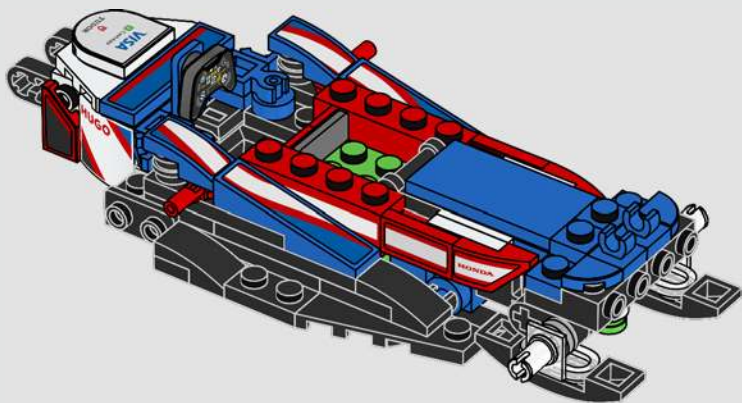

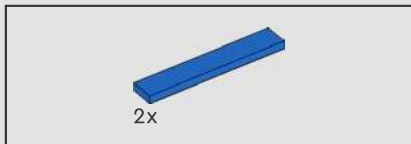

50

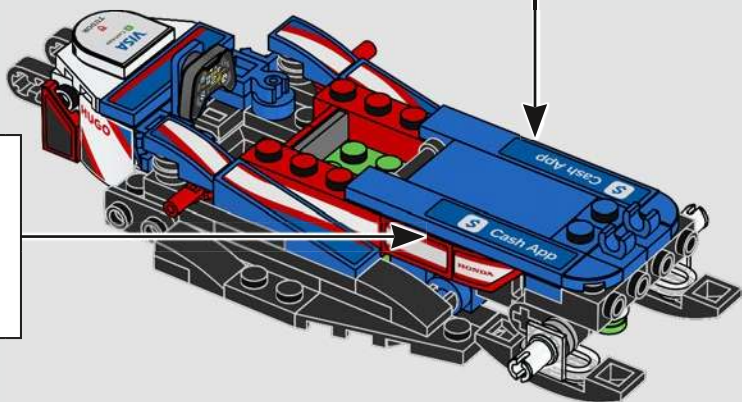
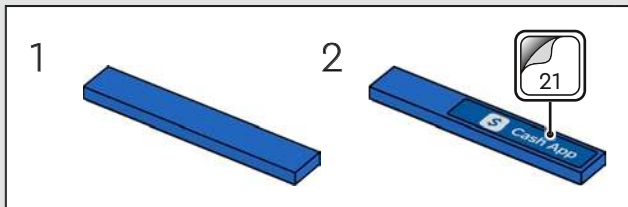
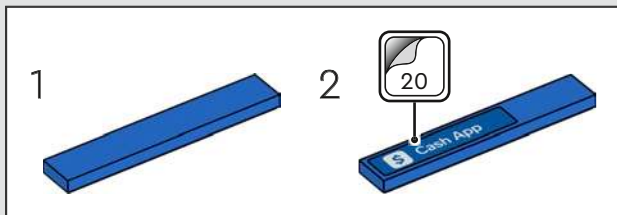



51

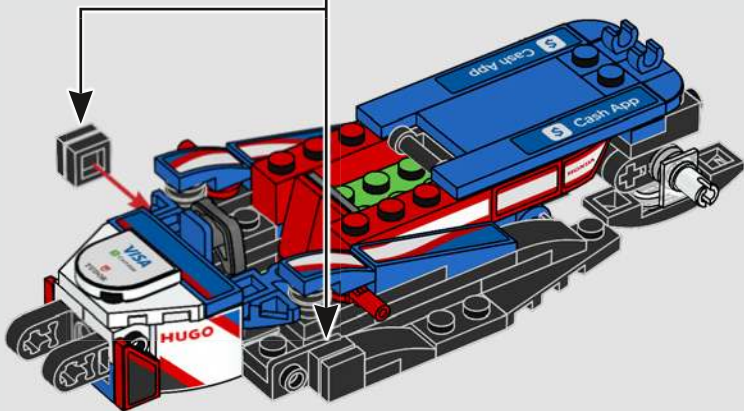
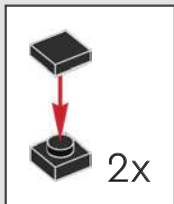



52

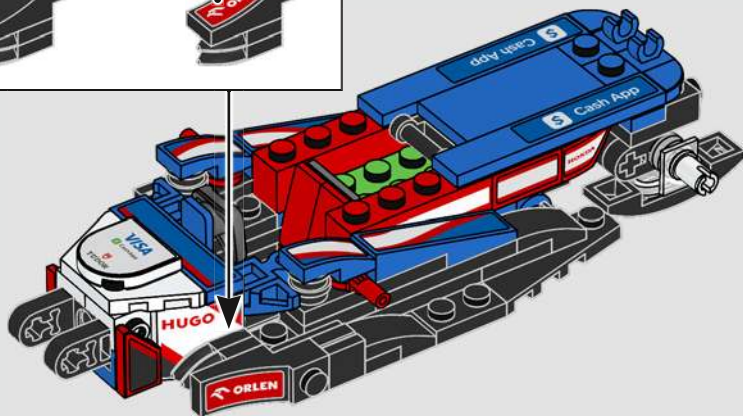
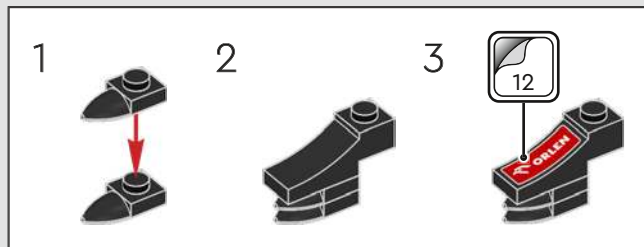



53

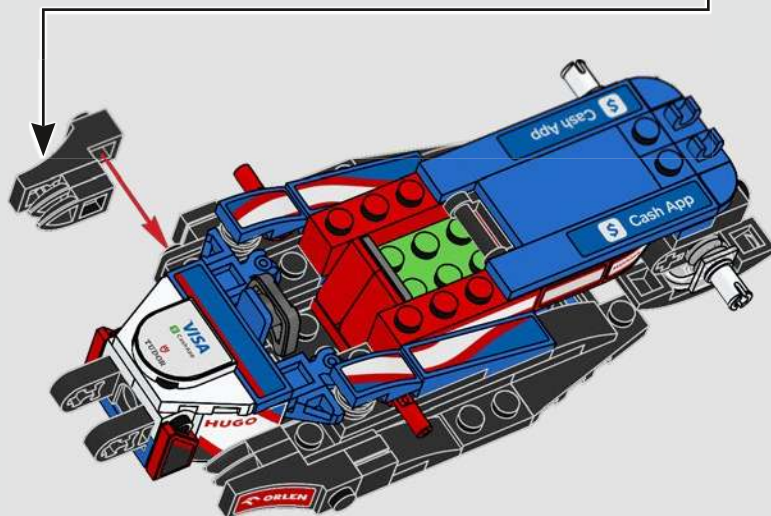
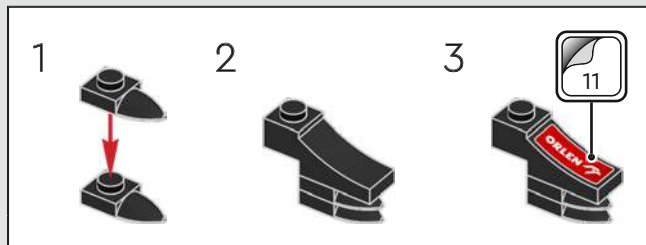



54

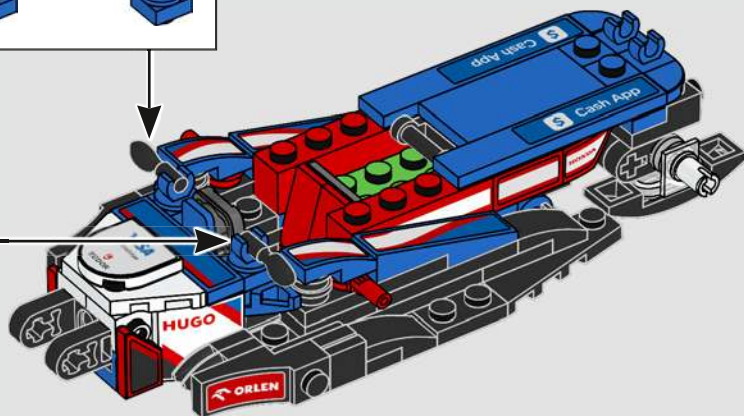
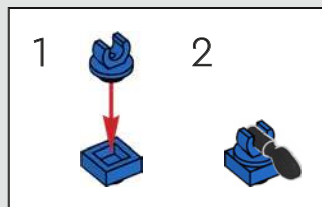
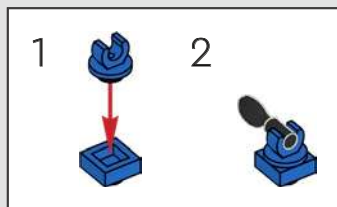

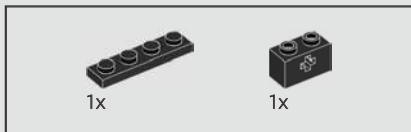
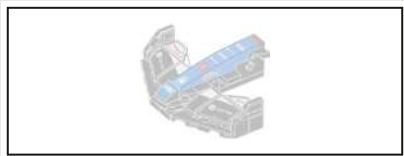

55

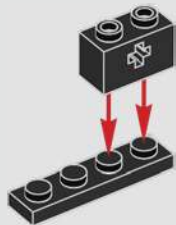

56

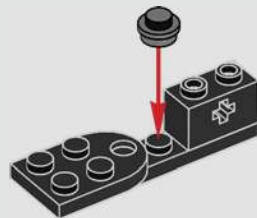



59

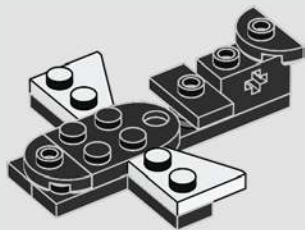

60

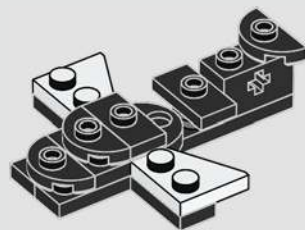



61

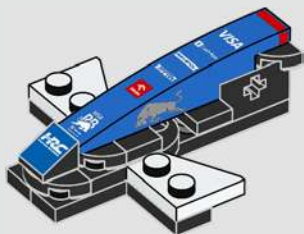



62

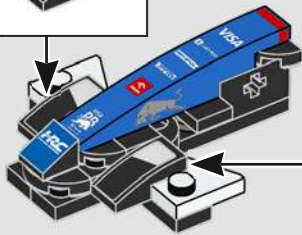
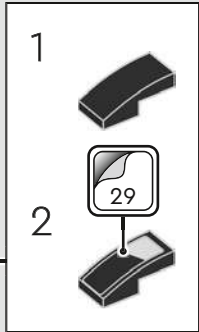
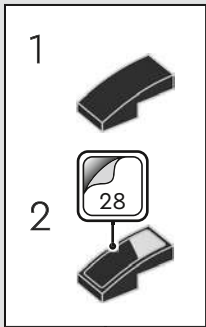



63

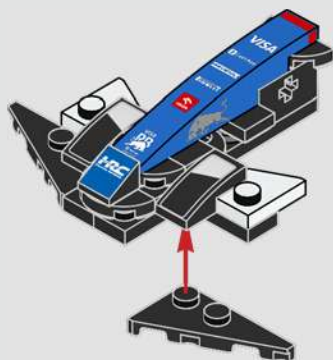



64

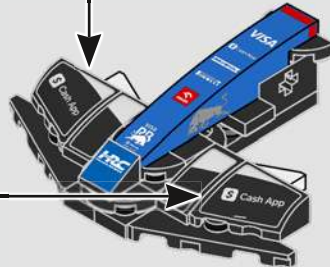
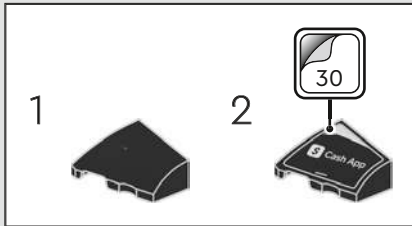
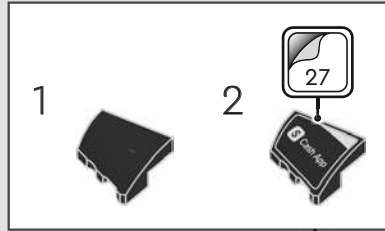

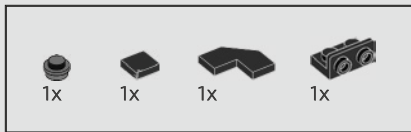

65

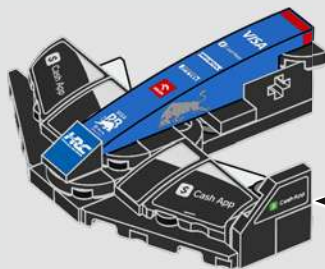
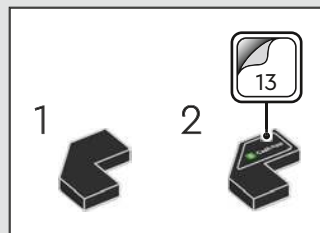
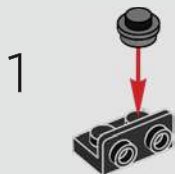

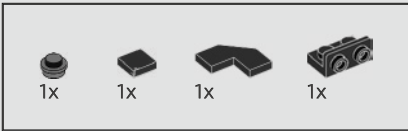

66

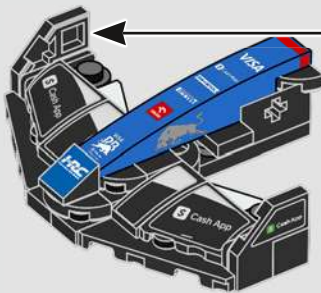
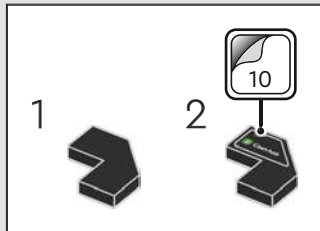
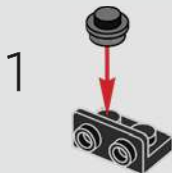

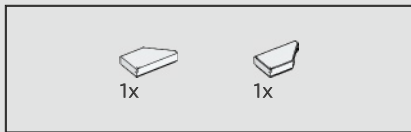

67

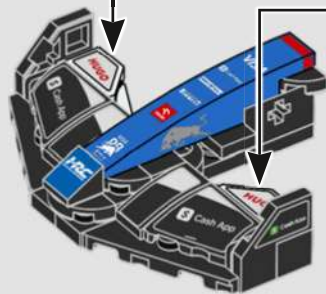
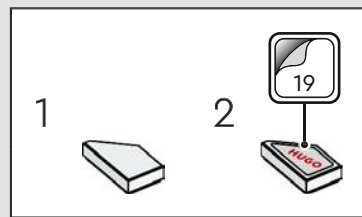
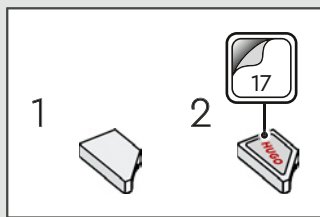

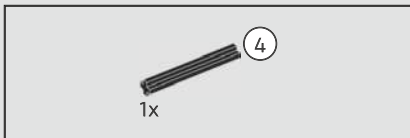

68

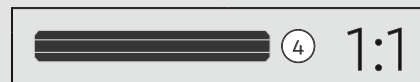
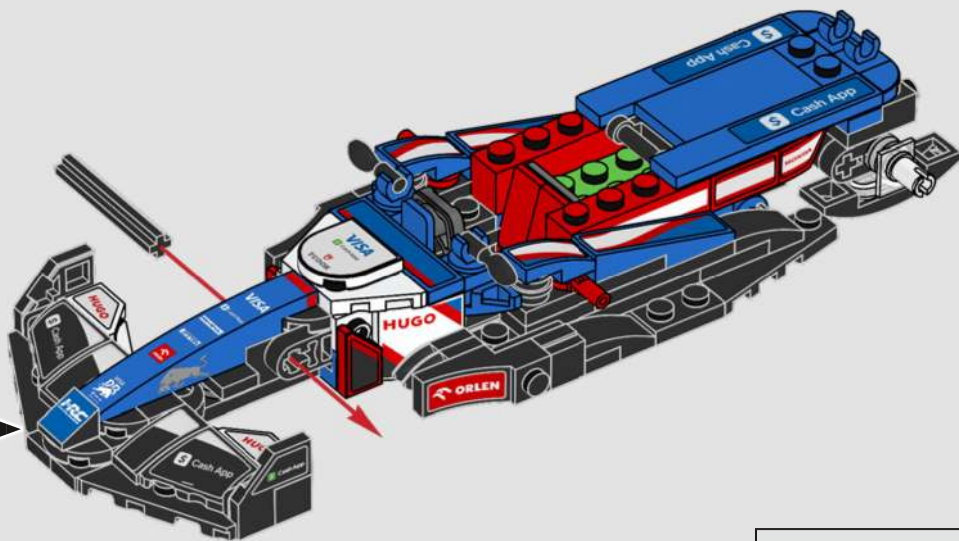





69

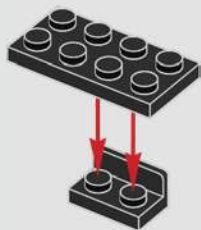

70

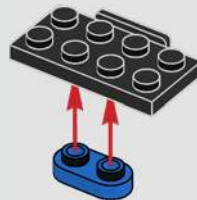

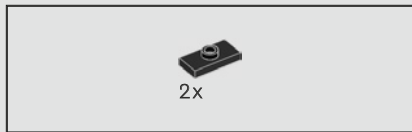

71

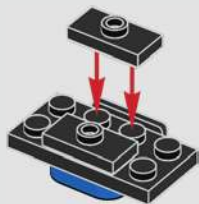

72

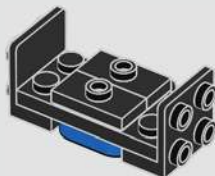



2x

73

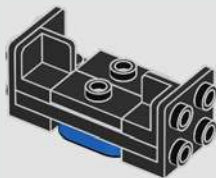

2x

74

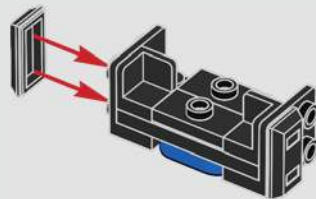



75

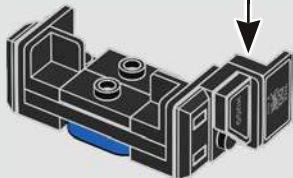
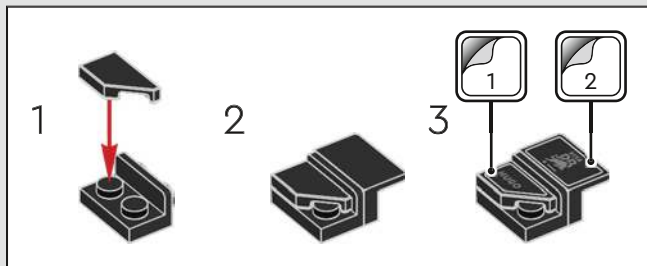



76

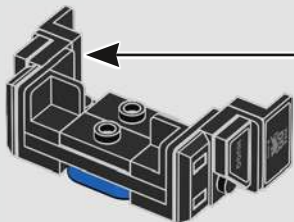
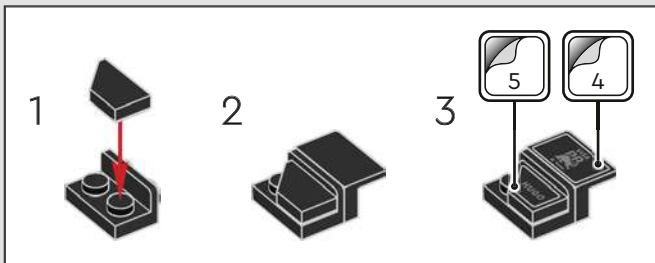

77

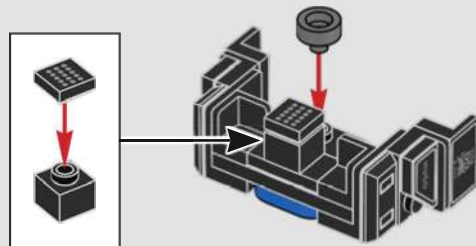

78

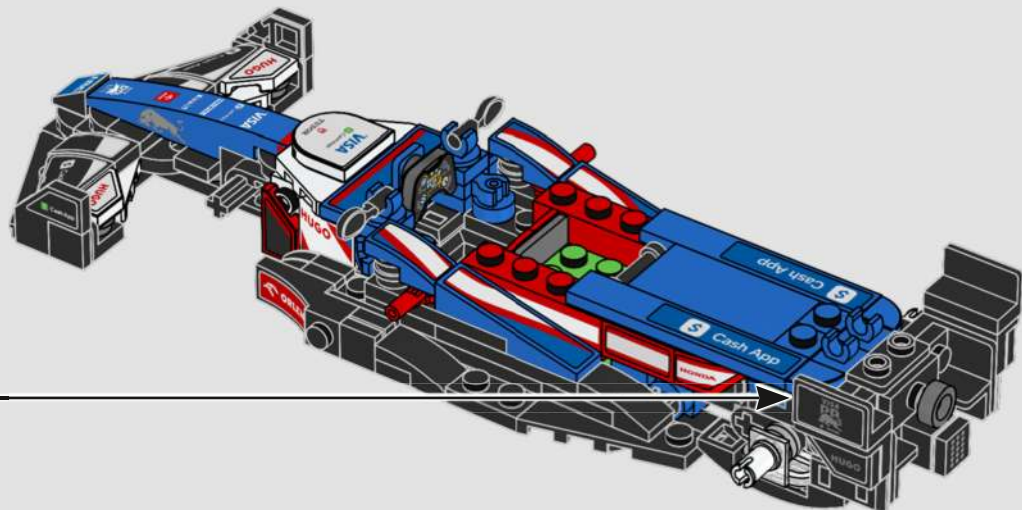



1x

79

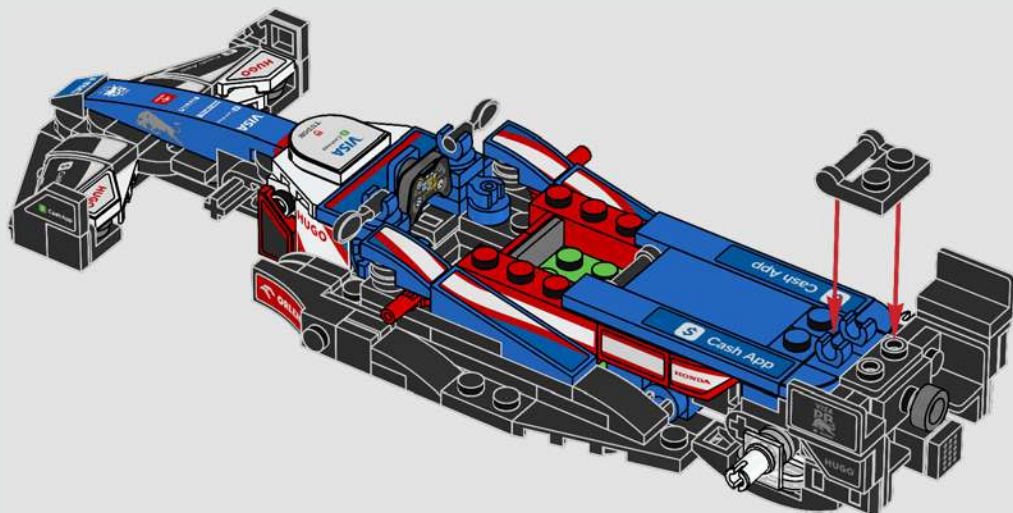

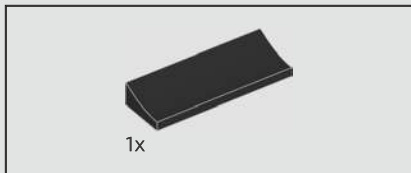

80

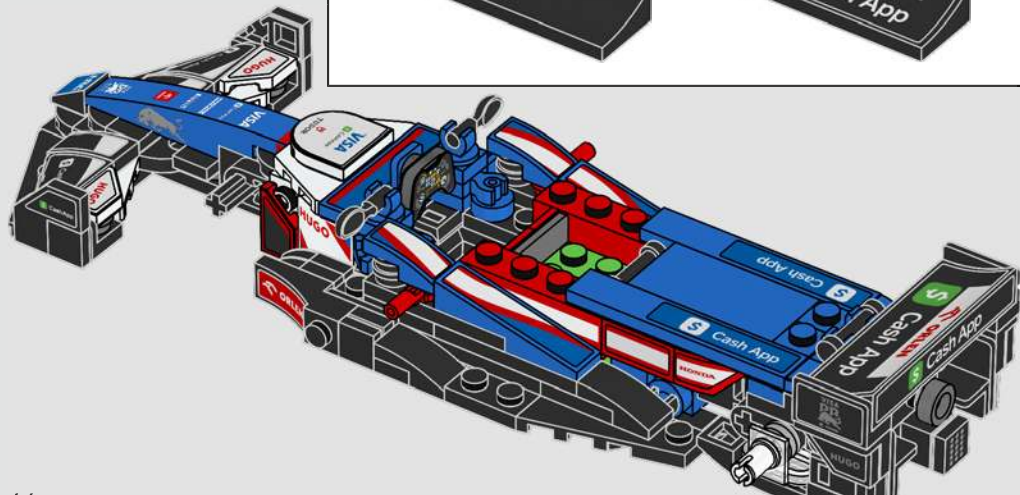



1x

81

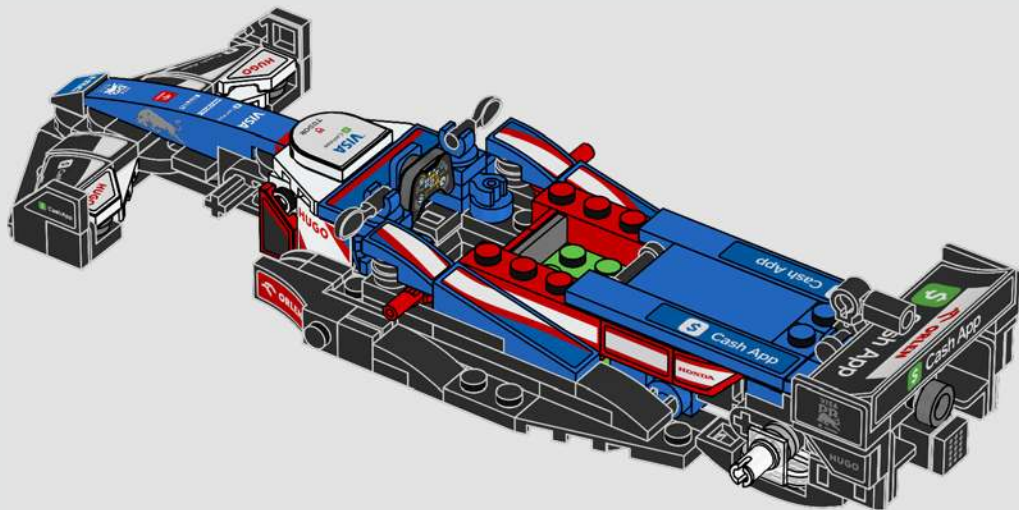



83

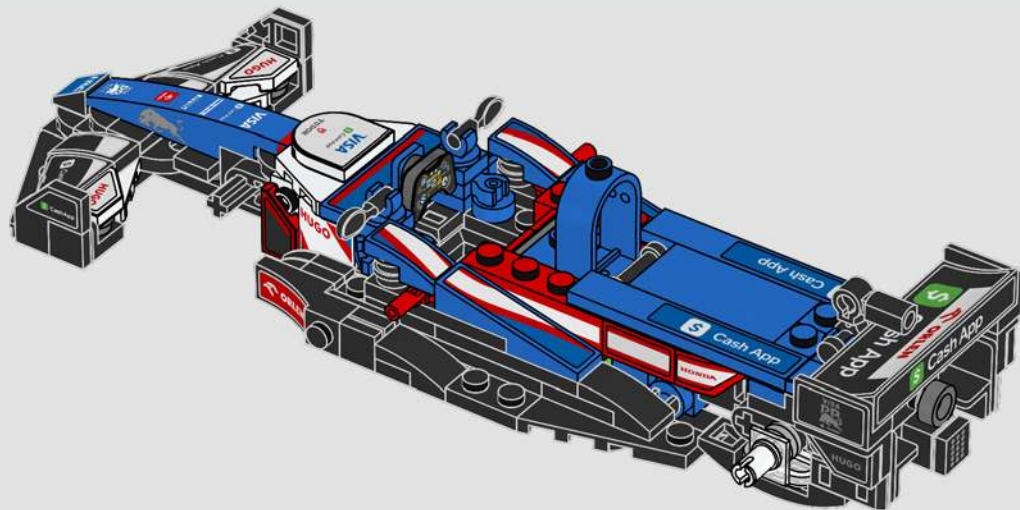

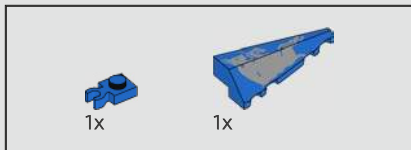

84

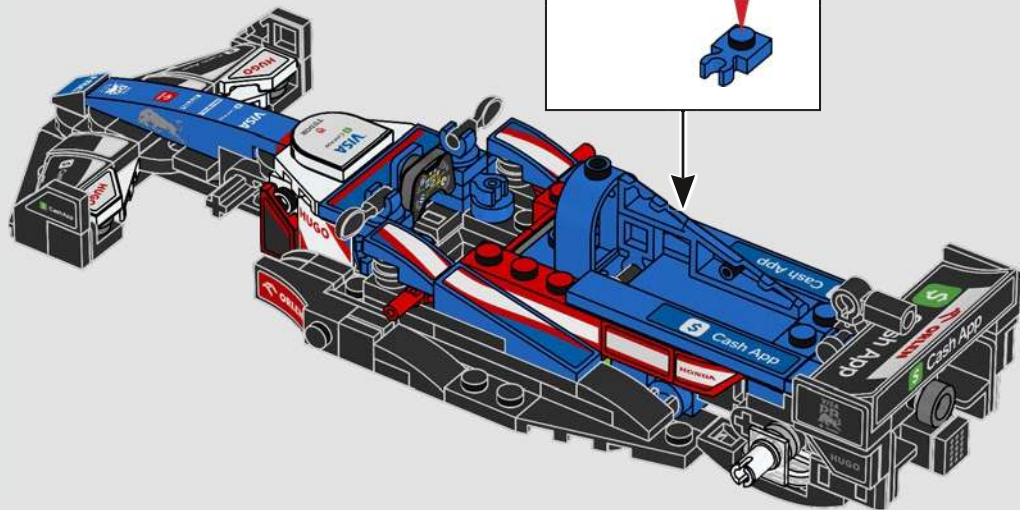
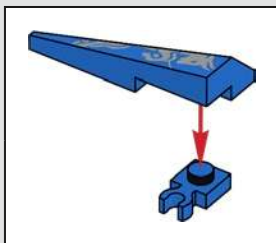

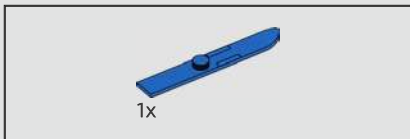

85

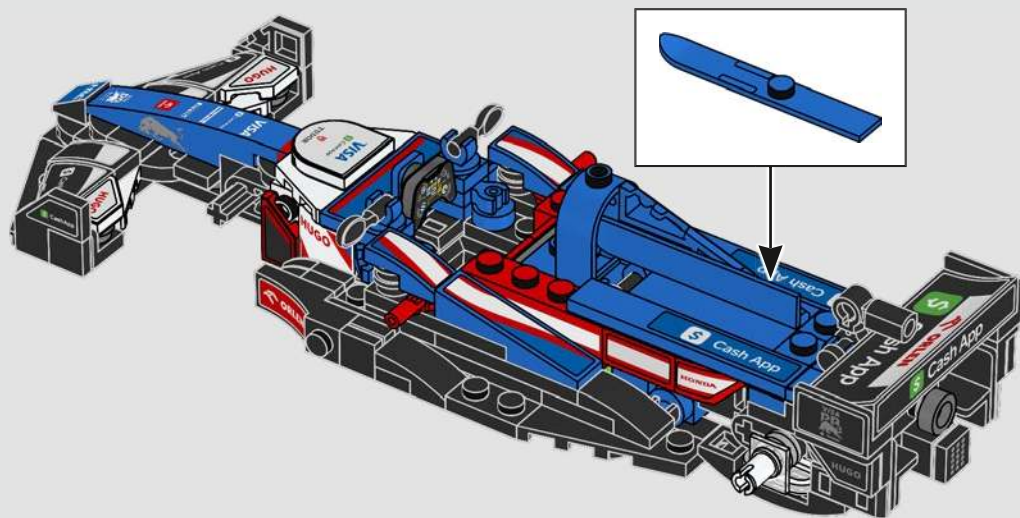

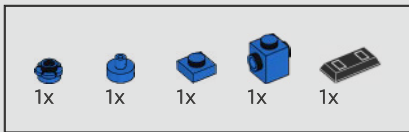

87

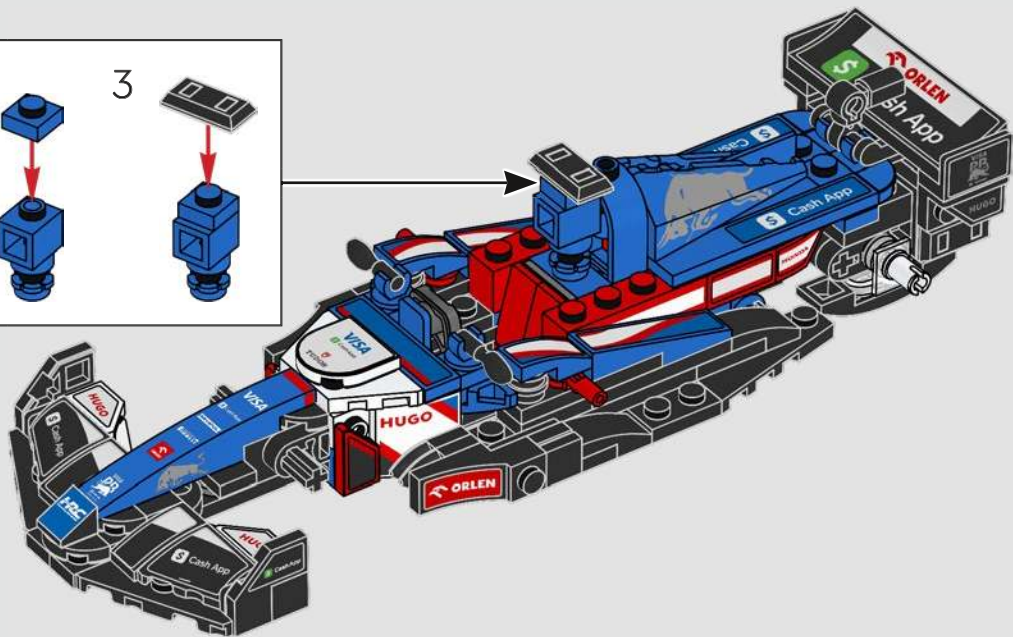
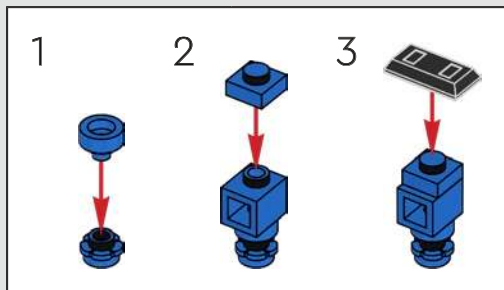



2x

88

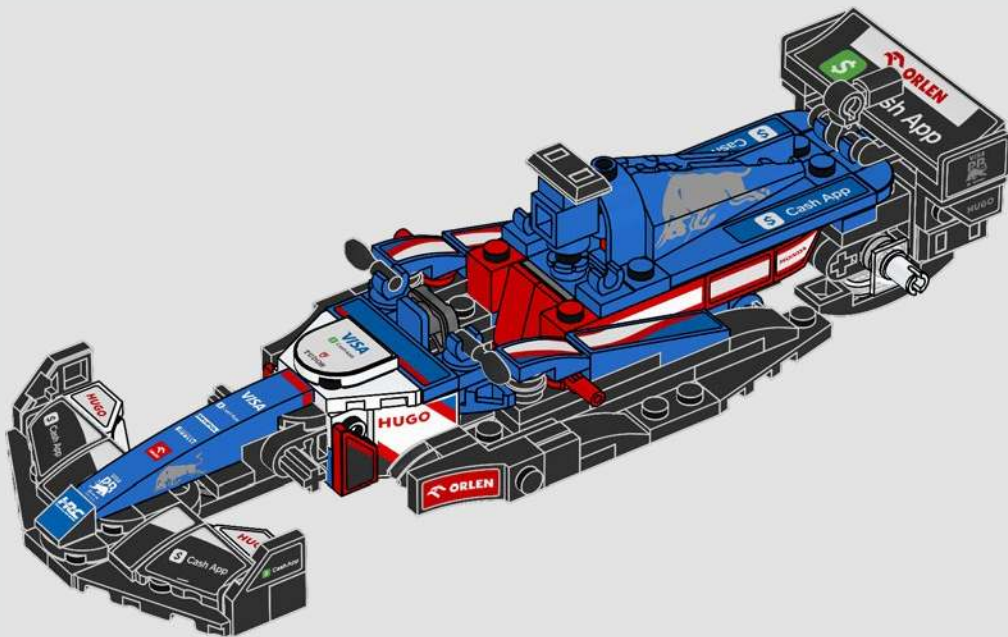



89

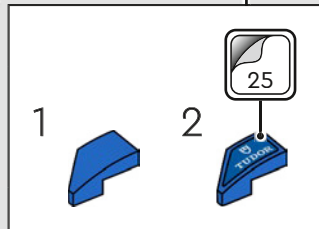
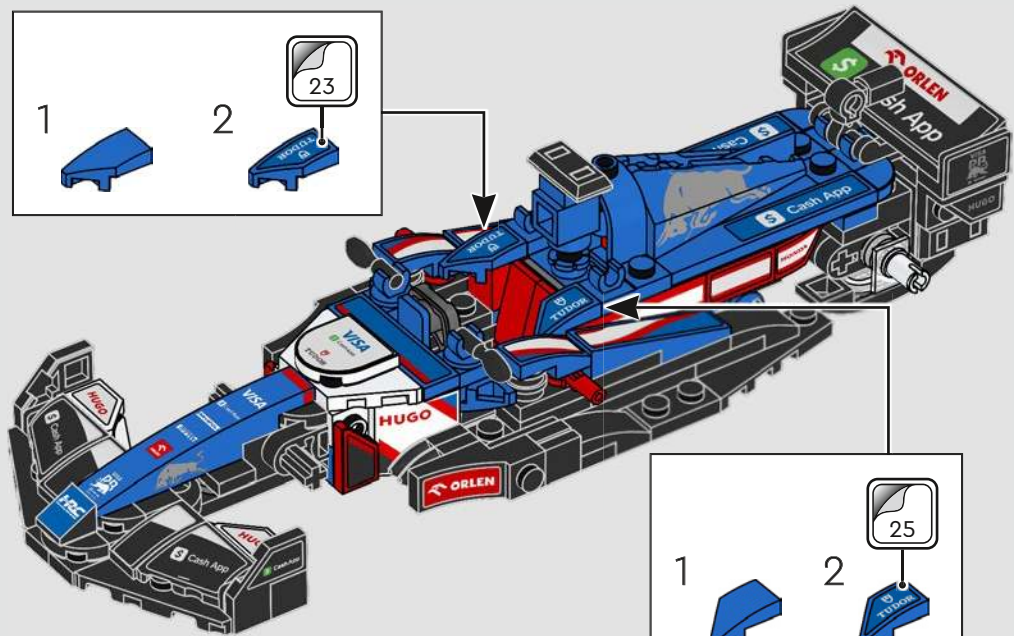
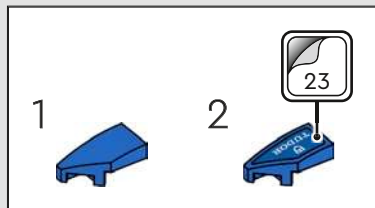

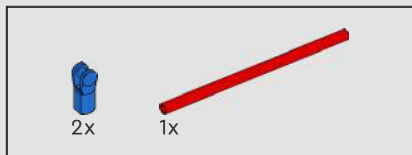

90

1



2

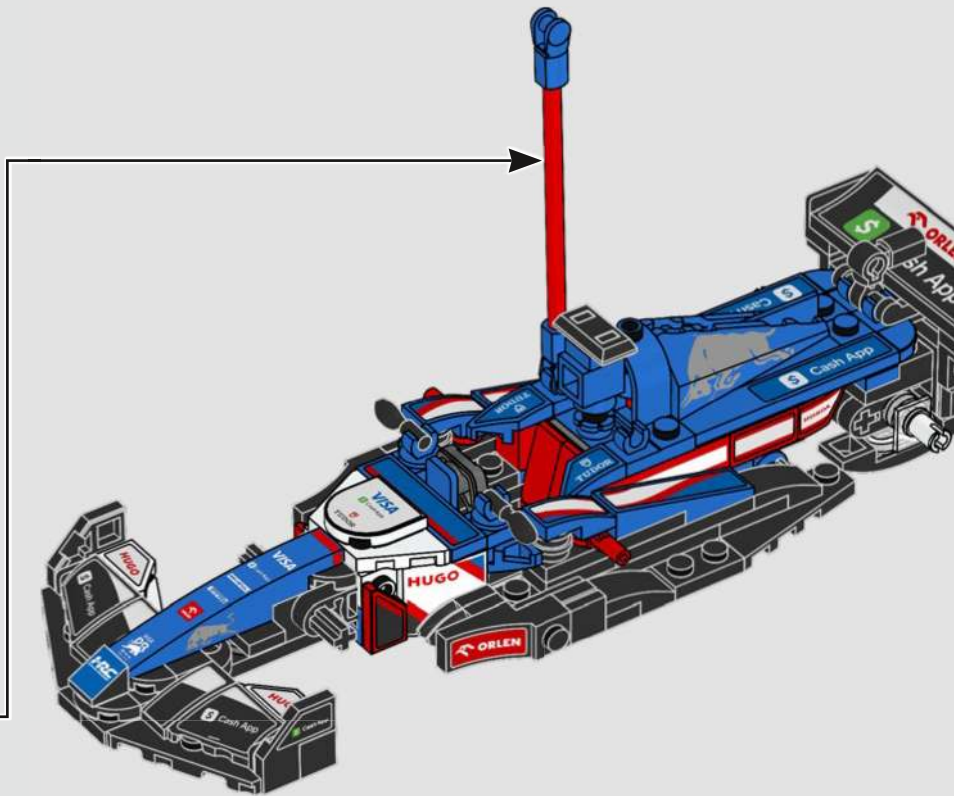
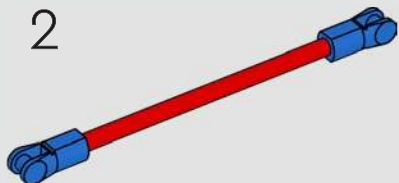

91

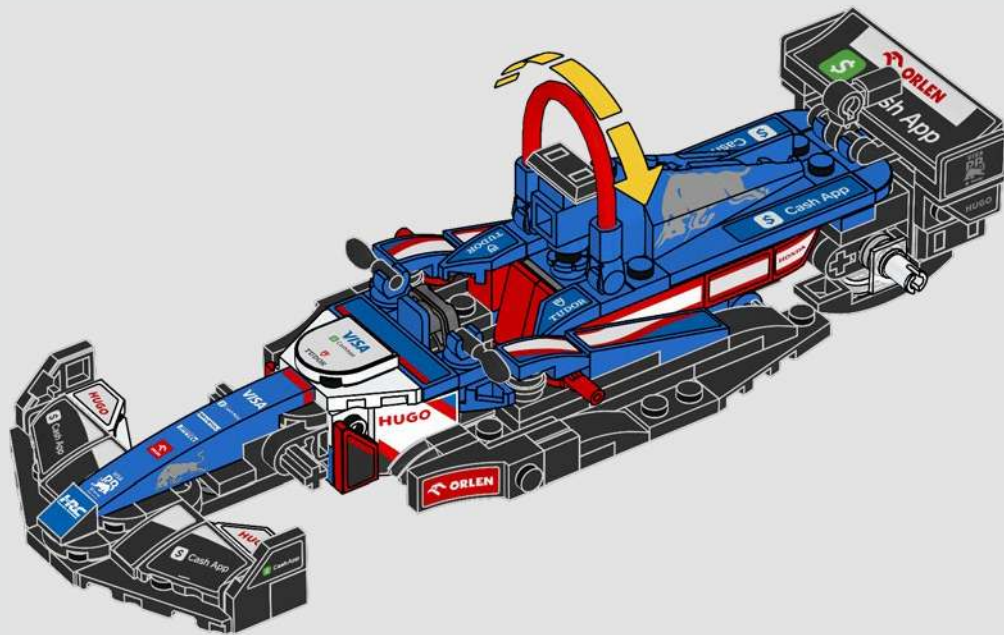



1x

92

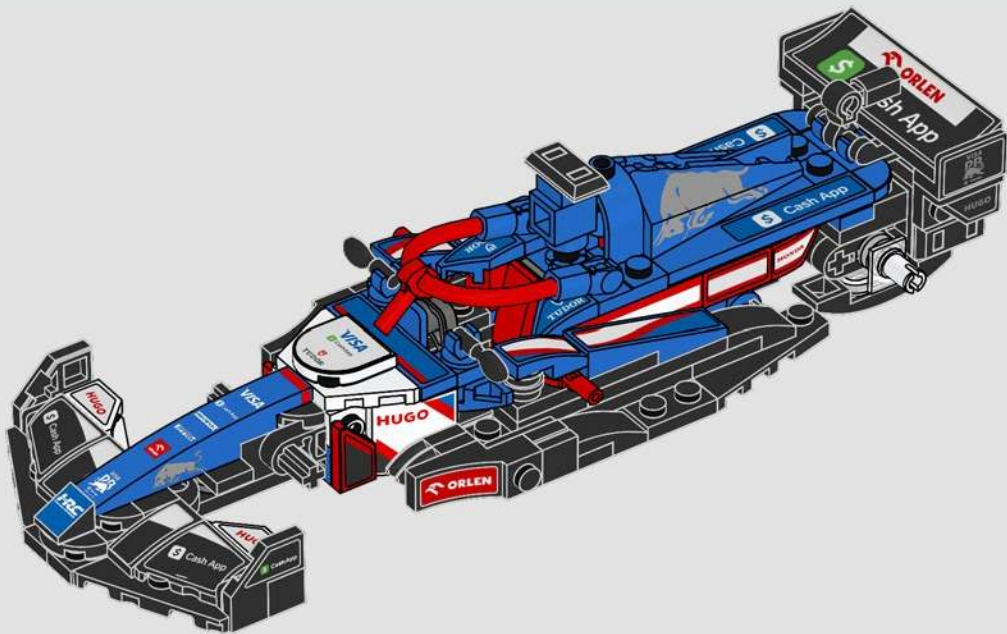

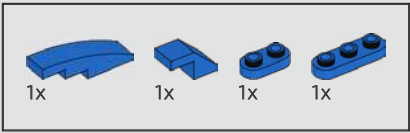

93

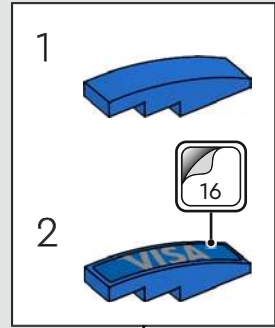
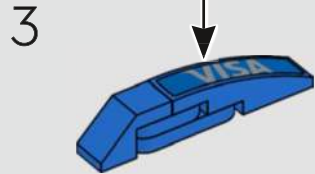
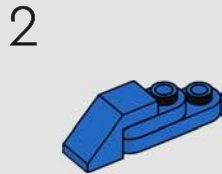
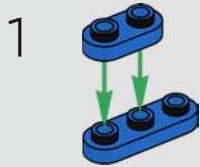

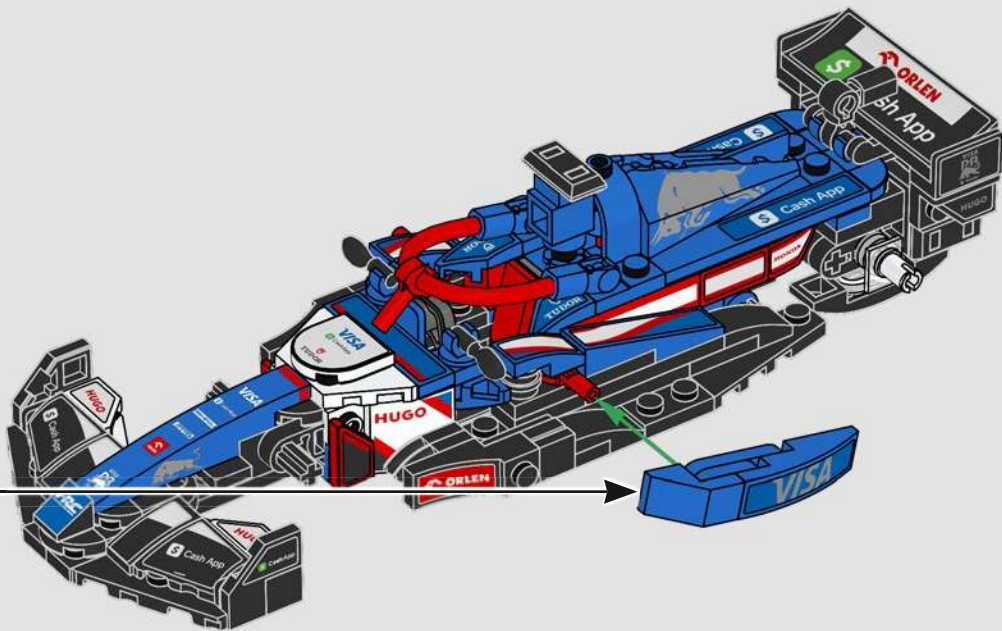

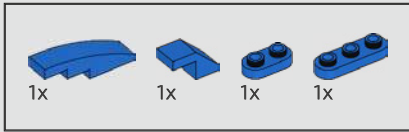

94

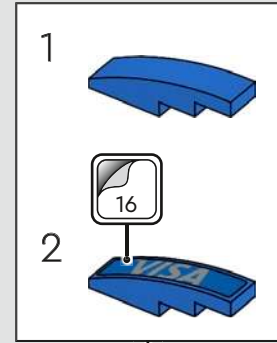
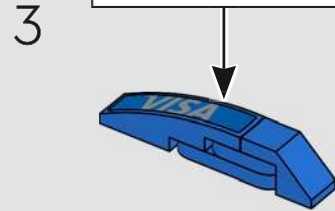
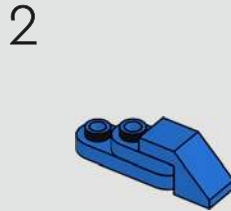
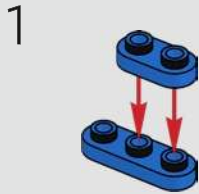

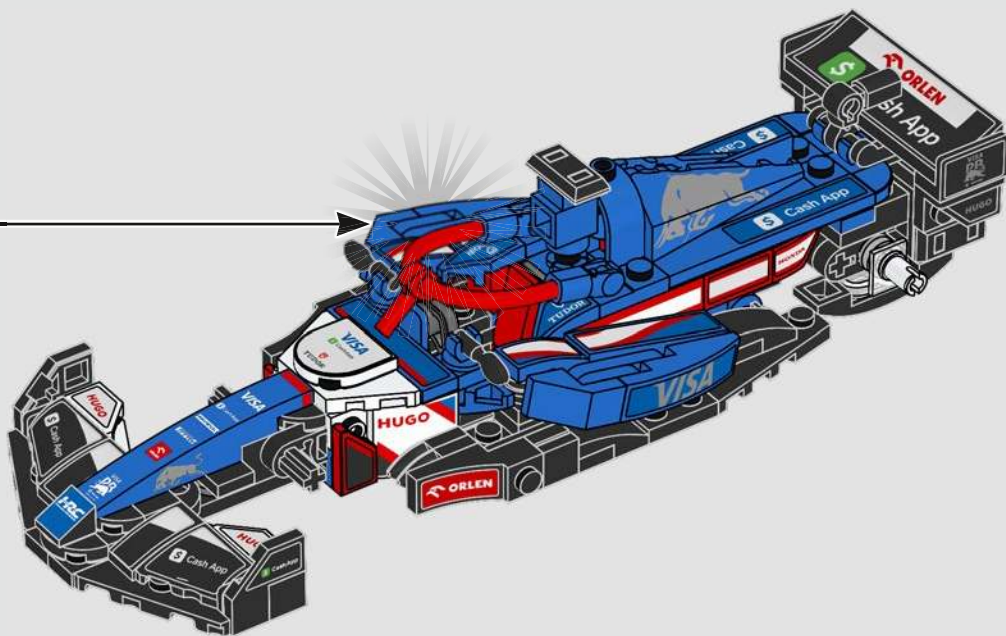



95

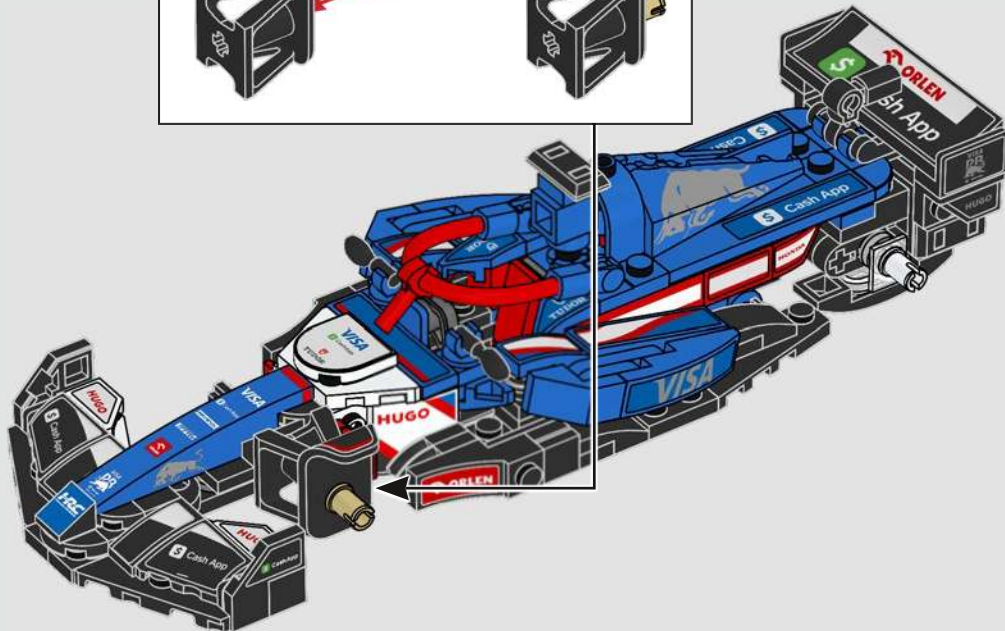
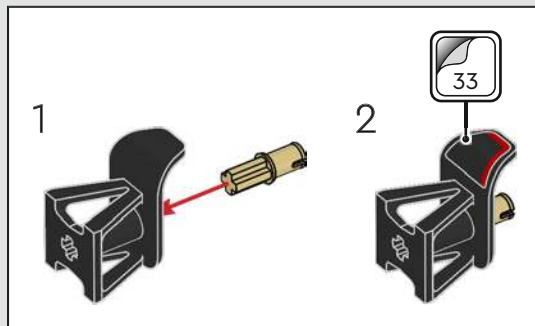



96

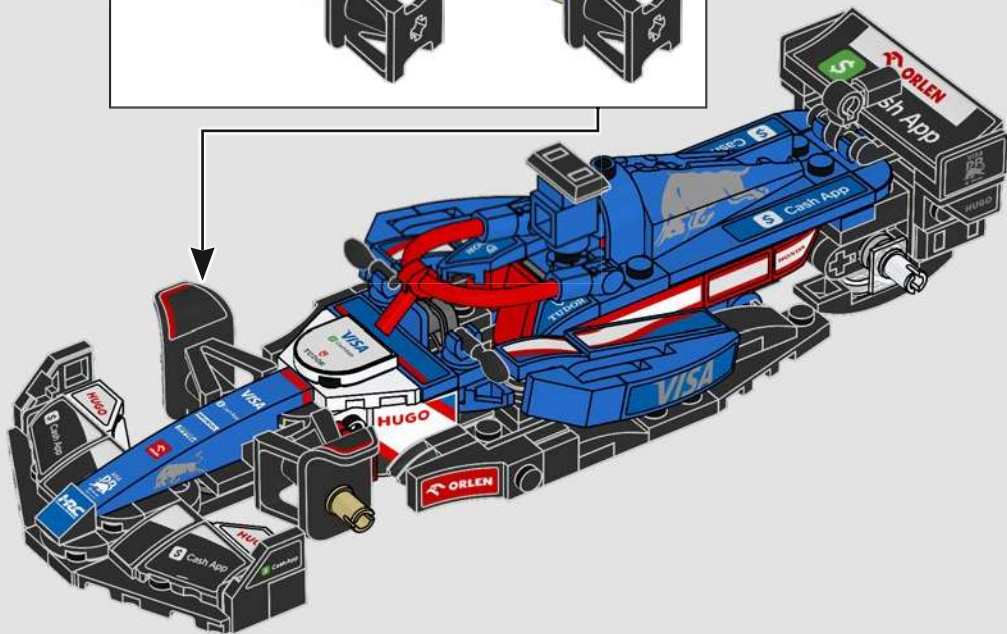
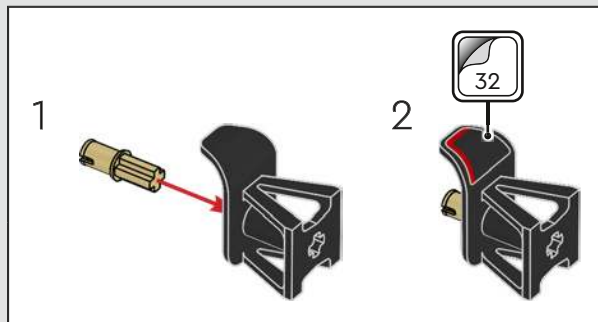

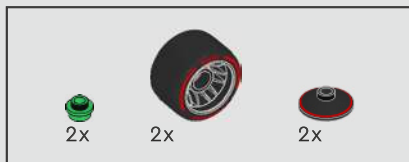

97



2

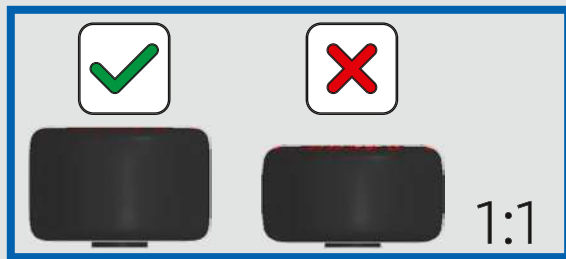

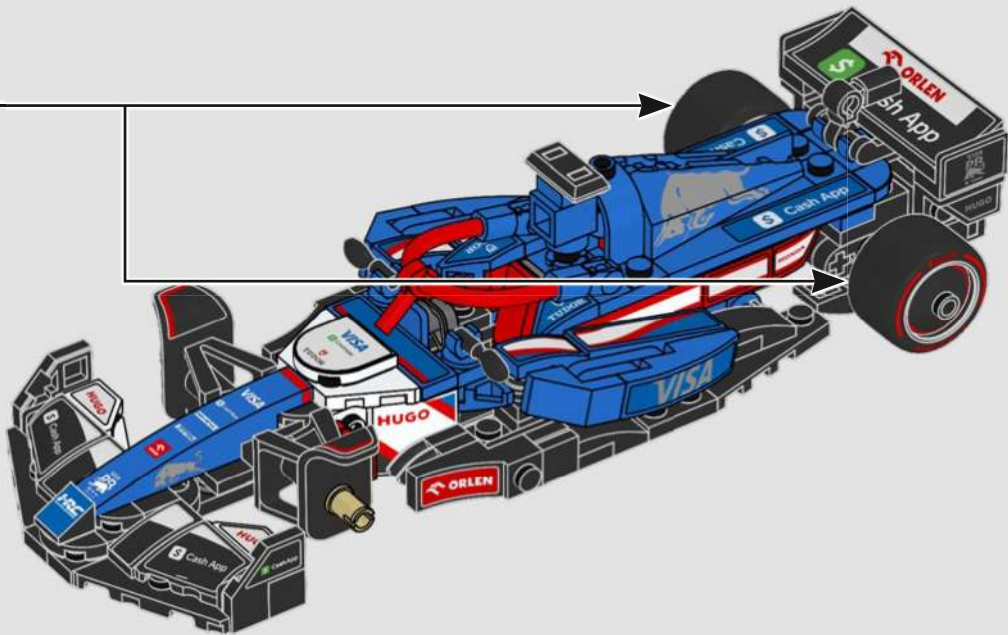



98

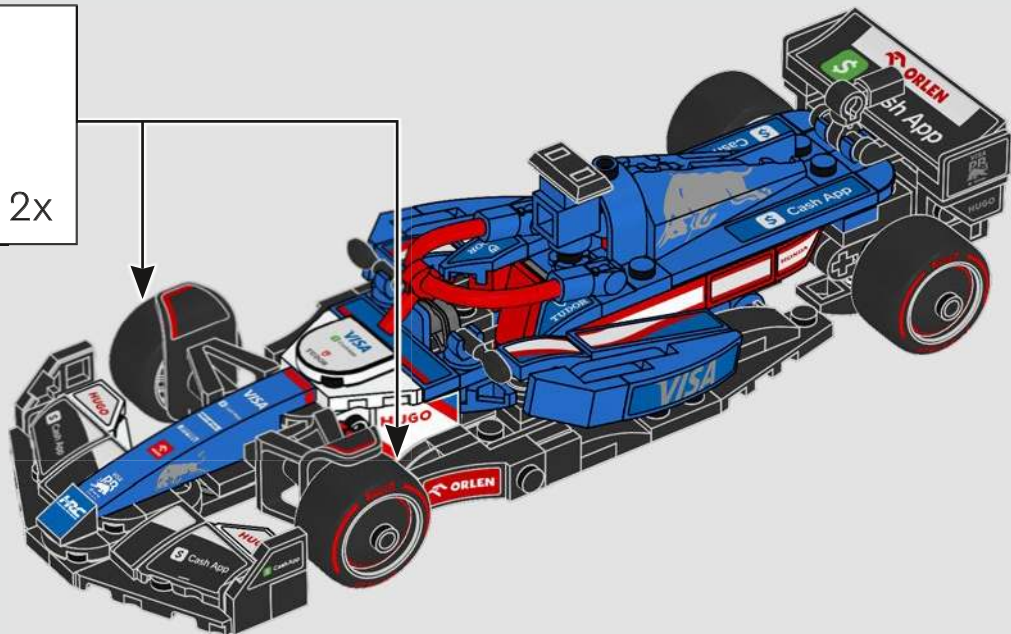
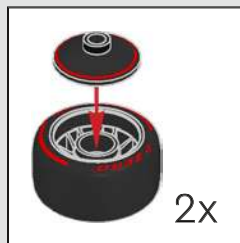

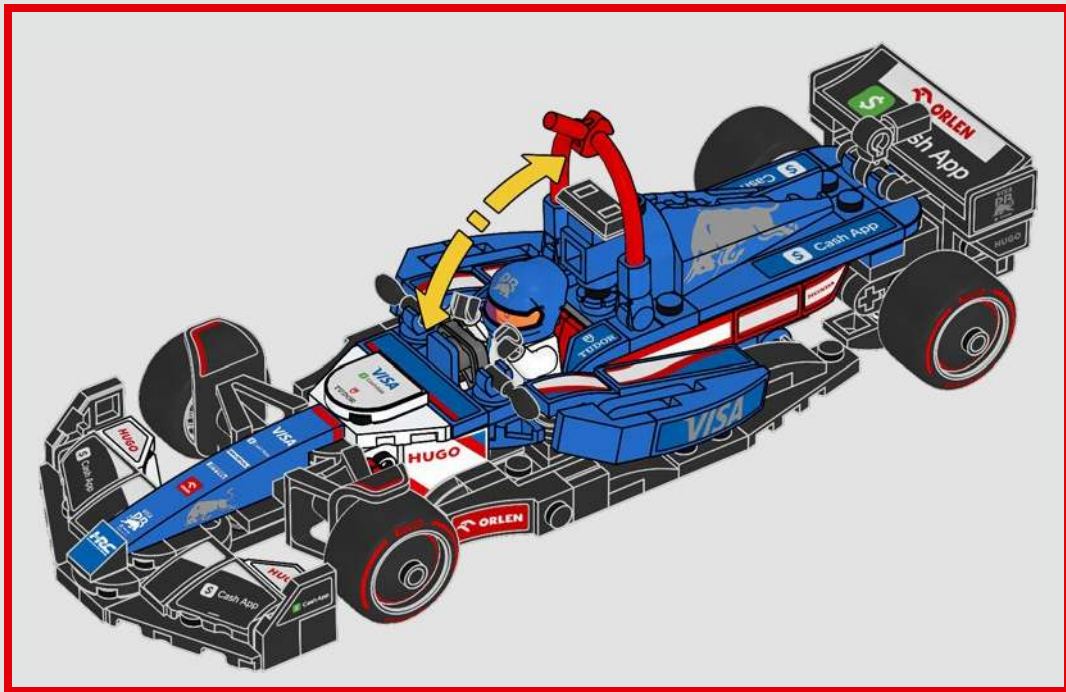

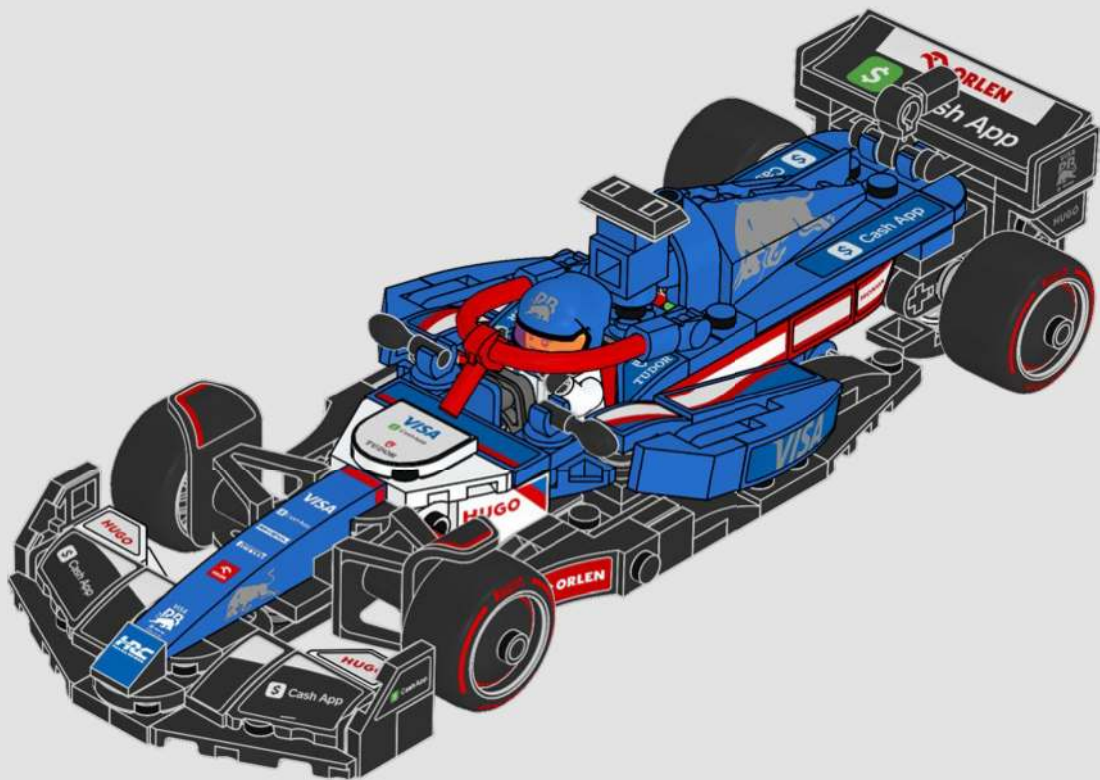

77243



77244



77242



77251



77245



77248



The F1 logo, FORMULA 1, F1, GRAND PRIX and related marks are trademarks of Formula One Licensing BV, a Formula 1 company. All other trademarks, logos and copyrights, including those of the teams featured, are the property of their respective owners. All rights reserved.

OFFICIAL LICENSEE OF FORMULA 1®



Formula 1®

77249



77246



77247



77250



Clutch power: 250 g (0.5 lbs)/LEGO® stud*

*The strength and stability with which LEGO bricks connect and stay together

Zusammenhalt: 250 g/LEGO® Noppe*

*Die Stärke und Stabilität, mit der LEGO Steine zusammengefügt werden und zusammenbleiben

Capacité d'imbrication : 250 g/tenon LEGO®*

*Correspond à la force et la stabilité avec lesquelles les briques LEGO s'imbriquent entre elles et restent accrochées

Forza prensile: 250 g/Bottoncino LEGO®*

*La forza e la stabilità con cui i mattoncini si connettono e rimangono connessi

Potencia de conexión: 250 g (0.5 lb)/espiga LEGO®*

*La fuerza y estabilidad con la que se conectan y se mantienen unidos los ladrillos LEGO.

Poder de encaixe: 250 g (0.5 lbs)/peça LEGO®*

*A força e estabilidade com que as peças LEGO se encaixam e mantêm juntas

抓合力: 250 克 (0.5 磅) / 乐高® 凸粒*

*乐高积木连接和保持在一起的强度和稳定性

Siła łączenia: 250 g na wypustkę LEGO®*

*Moc, z jaką stabilnie się łączą i nie rozpadają klocki LEGO

Siła spoje: 250 g/výstupek LEGO®*

*Pevnosť a stabilita, s jakou se kostky LEGO spojí a s jakou drží pohromadě.

Siła spoja: 250 g/výstupok LEGO®*

*Pevnosť a stabilita, ktorou sa spájajú a držia pohromade kocky LEGO.

Összetartó erő: 250 g/ LEGO® bűtyök*

*Az erő és stabilitás, amely összekapcsolja és összetartja a LEGO kockákat

Putere de atașare: 250 g/buton LEGO®*

*Forța și stabilitatea cu care cărămizile LEGO se conectează și rămân unite

Мощност на съединителя: 250 г /кръгла плоска тухличка LEGO®*

*Силата и стабилността, с които тухличките LEGO се свързват и остават заедно

Savienojuma spēks: 250 g/LEGO® izcilnis*















































































*Spēks un stabilitāte, ar kādu LEGO klucīši savienojas un paliek savienoti

Siduri vöimsus: 250 g / LEGO® nups*

*Tugevus ja stabiilsus, millega LEGO klotsid ühenduvad ja koos püsivad

Suspaudimo galia: 250 g vienai LEGO® iškyšai*

*LEGO kaladėlių susijungimo stiprumą ir stabilumą nusakantis dydis

 1x 6510140	 1x 6539365	 2x 6384112	 1x 6382540	 3x 6092582	 2x 6366181	 1x 4651443	 1x 6510139
 1x 6132203	 1x 6539364	 1x 6177507	 5x 6482748	 4x 6537693	 2x 6537695	 2x 6475201	 4x 4273590
 1x 6132204	 2x 6289797	 1x 6510127	 2x 6302961	 2x 306923	 1x 243123	 4x 614126	 2x 6323189
 1x 6261372	 1x 6540777	 2x 6500115	 3x 302423	 1x 6535152	 1x 6539366	 4x 307026	 1x 6295295
 1x 6510126	 1x 4249506	 2x 306921	 2x 6172414	 2x 6055065	 1x 4560180	 1x 6545851	 3x 6510061
 1x 9327	 2x 4666579	 1x 6219819	 3x 6344218	 4x 6133721	 1x 6535153	 2x 4106347	 3x 6510061
 2x 302301	 1x 6439048	 2x 6539363	 1x 6531923	 2x 6537694	 1x 6535153	 2x 302426	 4x 6338428
 4x 6018774	 1x 6177505	 1x 6456646	 8x 6315482	 4x 242023	 1x 6539958	 1x 6539347	 1x 6513908
 1x 6541091	 2x 6372478	 1x 371023	 2x 6172411	 1x 6488776	 1x 6535240	 1x 6388352	 1x 6279875
	 1x 6510141	 2x 6045938	 2x 6228601	 2x 6538390	 2x 4118785	 1x 6338384	 1x 6295293

6x
6047276

2x
6146220

7x
6020193

1x
6178922

5x
6156991

4x
6539346

1x
6507846

1x
6510125

2x
6166859

4x
6092585

2x
6000650

2x
4225201

2x
302226

2x
4613153

2x
242026

2x
6469445

1x
4161332

1x
4160869

2x
6508991

2x
6328095

2x
6517676

1x
400626

1x
317626

3x
302126

2x
6538246

2x
6538247

2x
370526

5x
371026

4x
6439175

1x
302026

2x
366626

1x
6508988

1x
4656764

1x
6417264

2x
6271165

3x
4210633

1x
6271752

1x
6308045

1x
6472255

2x
6166106

1x
6535238

6x
6338221

1x
6301284

2x
6141590



 [LEGO.com/service](https://www.LEGO.com/service)



YOU COULD WIN



YOU COULD WIN

Your feedback will help shape the future development of this product series.

Visit:

DU KÖNNTEST GEWINNEN

Dein Feedback trägt zur Weiterentwicklung dieser Produktreihe bei.

Geh auf:

VOUS POURRIEZ GAGNER

Vos commentaires nous aideront à concevoir les futurs produits de cette gamme.

Visitez :

POTRESTI VINCERE TU

La tua opinione ci aiuterà a migliorare la creazione futura di questa linea di prodotti.

Visita:

PUEDES GANAR

Tu opinión contribuirá al futuro de esta serie de productos.

Visita:

轻松获奖

您的反馈将有助于我们在今后改进本产品系列。

请访问:

LEGO.com/productfeedback

You also have the chance to win a LEGO® set.

Terms and conditions apply.*

Außerdem hast du die Chance, ein LEGO® Set zu gewinnen.

Es gelten die Teilnahmebedingungen.*

Vous pourriez également gagner un ensemble LEGO®.

Des conditions s'appliquent.*

Hai anche la possibilità di vincere un set LEGO®.

Termini e condizioni sono applicabili.*

También tienes la oportunidad de ganar un set LEGO®.

Aplican términos y condiciones.*

您还有机会赢取乐高®套装。

条款和条件适用。*

*LEGO.com/productfeedback-terms



LEGO and the LEGO logo are trademarks of the LEGO Group. ©2025 The LEGO Group. 6566092

Red Bull® Marks and the Visa Cash App RB Logo are licensed by Red Bull GmbH/Austria

The F1 logo, FORMULA 1, F1, GRAND PRIX and related marks are trademarks of Formula One Licensing BV, a Formula 1 company. All rights reserved.

OFFICIAL LICENSEE OF FORMULA 1®