



# CREATOR™



31170



3in1	3 in 1	3 合 1	3 az 1-ben	3 ühes
3-in-1	3en1	3 w 1	3 in 1	„Trys viename“
3-en-1	3em1	3 v 1	„3 в 1“	



LEGO® Builder



[LEGO.com/sustainable-packaging](https://LEGO.com/sustainable-packaging)



**FR**  
**DONNEZ**  
OU  
**RECYCLEZ**

 OU  OU 

ASSOCIATION MAGASIN DÉCHÈTERIE

Adresses sur [quefairedemesdechets.fr](https://quefairedemesdechets.fr)

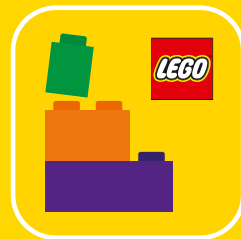

Q LEGO® Builder

# BUILDER



Apple and the Apple logo are trademarks of Apple Inc., registered in the U.S. and other countries and regions. App Store is a service mark of Apple Inc. Google Play and the Google Play logo are trademarks of Google LLC. Tencent and the Tencent logo are trademarks of Tencent Inc.

Q [LEGO.com/devicecheck](https://www.lego.com/devicecheck)

EN Ask parents' permission before going online | DE Eltern um Erlaubnis bitten, bevor du online gehst | FR Demande l'autorisation d'un parent avant d'aller en ligne | IT Chiedi il permesso ai tuoi genitori prima di andare online | ES Pídeles permiso a tus papás antes de conectarte a Internet | PT Pede autorização aos pais antes de acederes online | ZH 上网前应先征得父母的同意 | PL Poproś rodziców o zgodę, zanim wejdiesz do Internetu | CS Než půjdeš na internet, požádej rodiče o svolení | SK Skôr než pôjdeš na internet, vypýtaj si povolenie od rodičov | HU Kérj szülői engedélyt, mielőtt online csatlakoznál! | RO Cere permisiunea părinților înainte de a te conecta online | BG Поискайте разрешение от родител, преди да влезете онлайн | LV Pirms došanās tiešsaistē palūdz atļauju vecākiem | ET Enne Interneti kasutamist küsi vanematelt luba | LT Prieš prisijungdami prie interneto, atsiklauskite tėvų

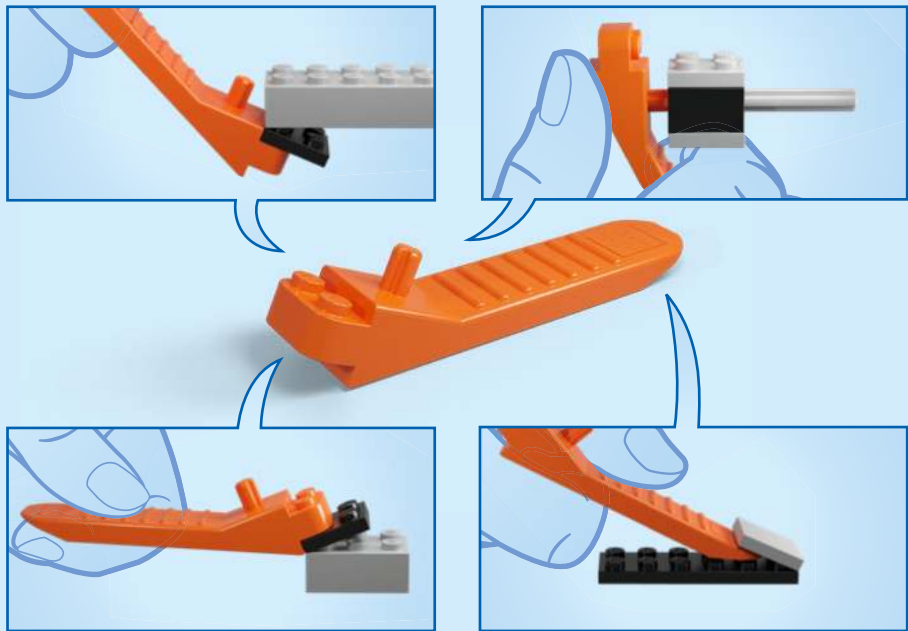



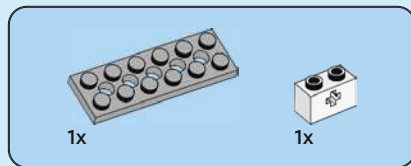

1

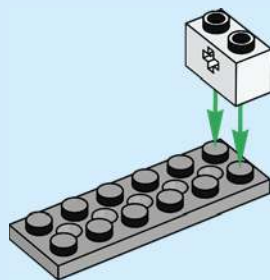



2

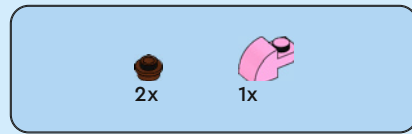
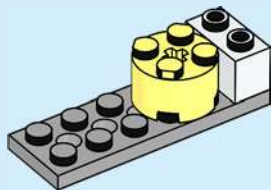

3

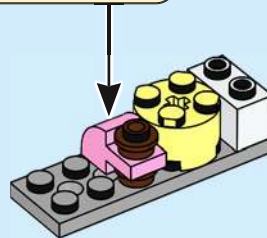
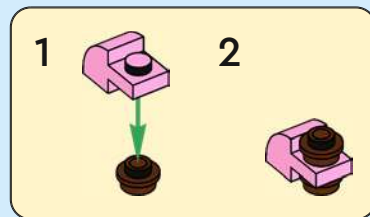

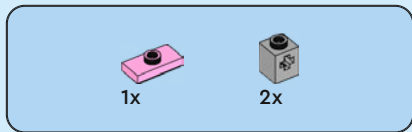

4

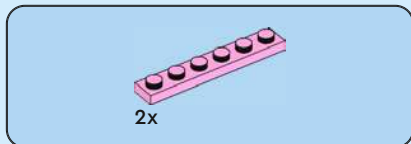
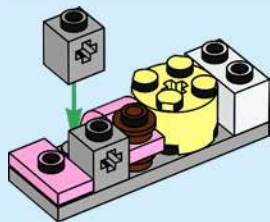

5

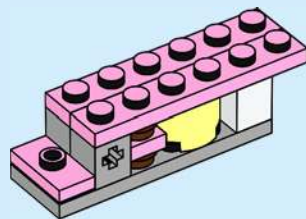



1x

6

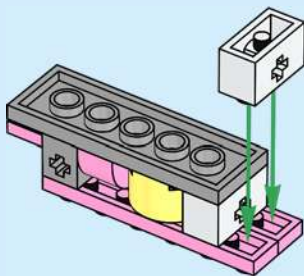

1x



1x

7

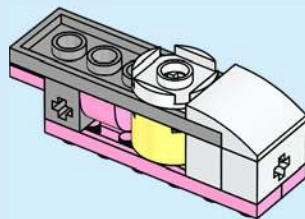



1x



1x

8

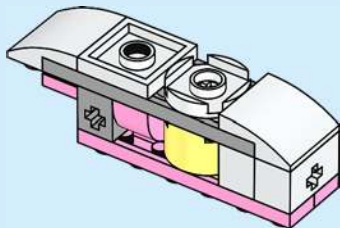

1x

9

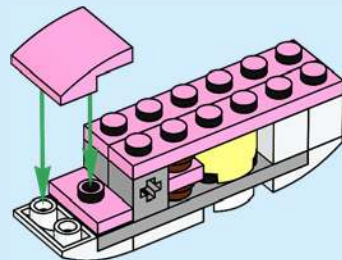

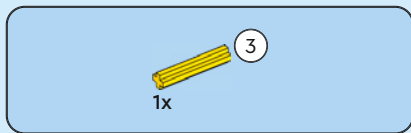

10

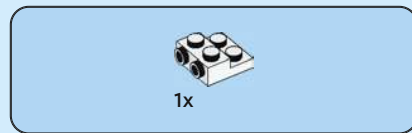
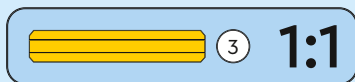
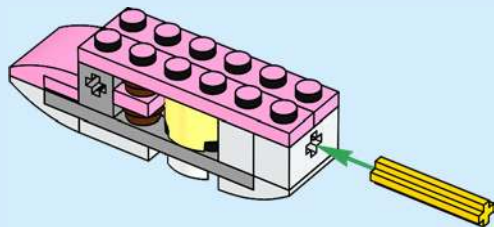

11

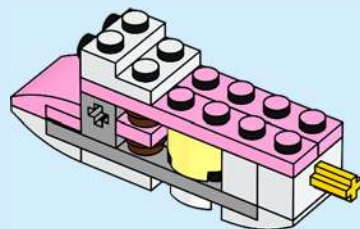



2x

12

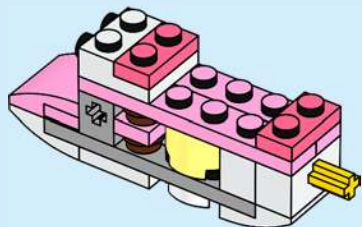

1x



1x

13

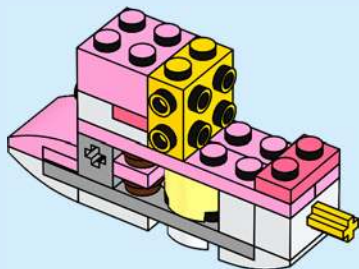

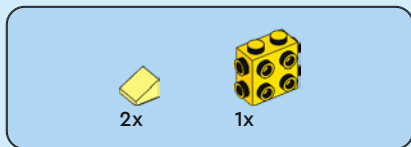

14

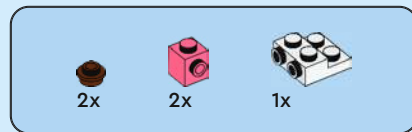
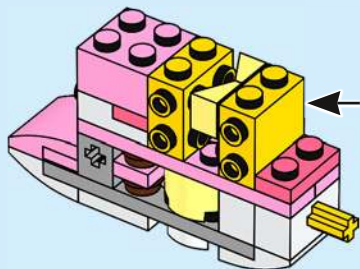
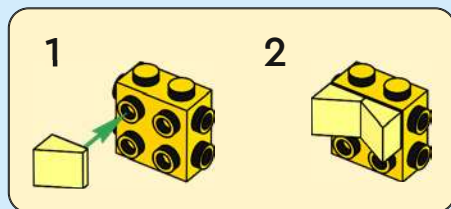

15

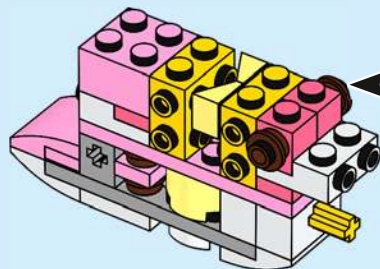
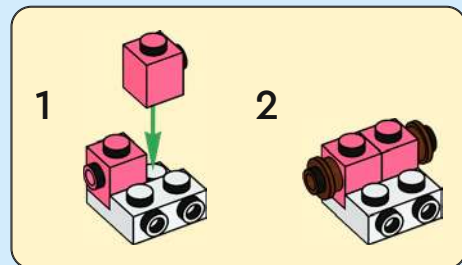

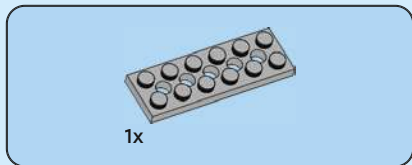

16

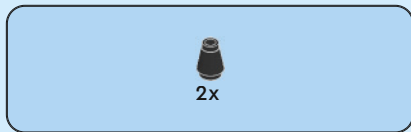
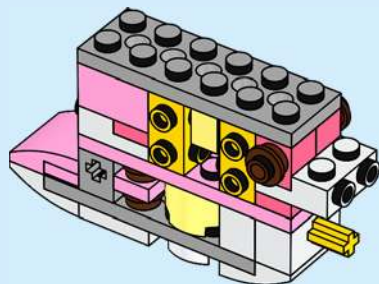

17

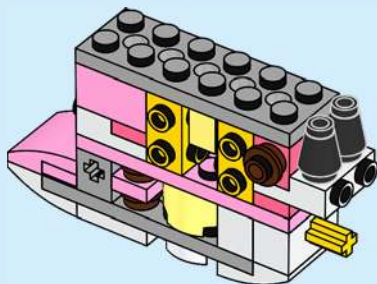

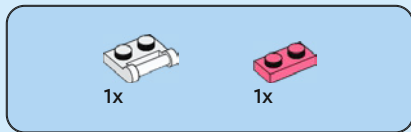

18

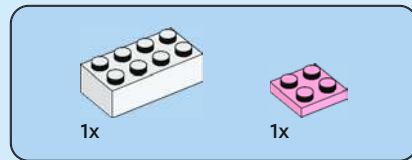
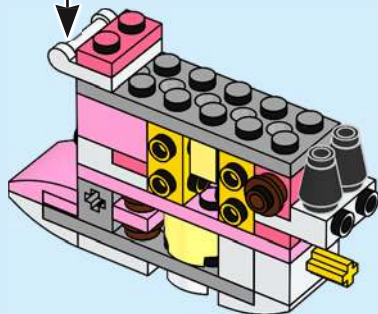
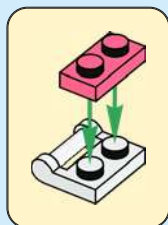

19

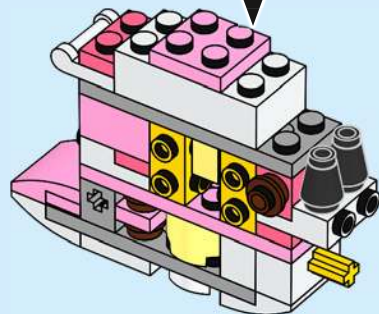
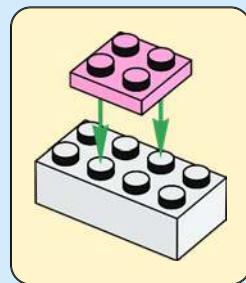



1x



1x

20

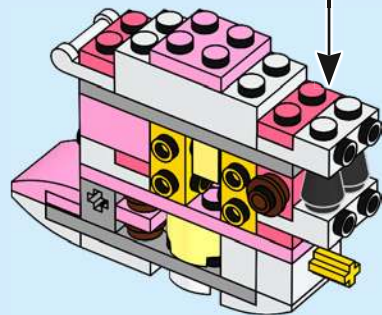
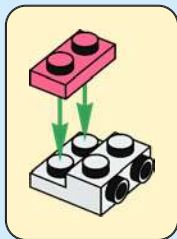

2x

21

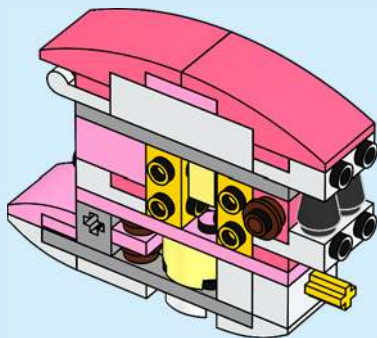

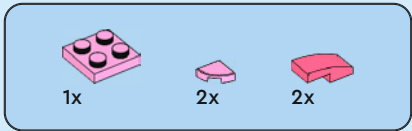

22

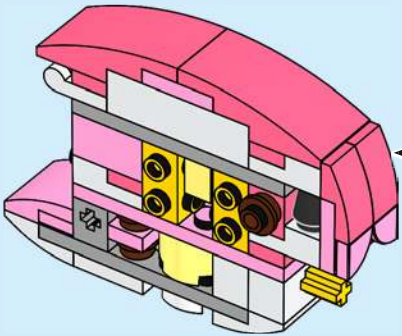
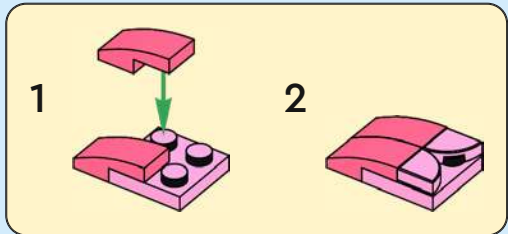

23

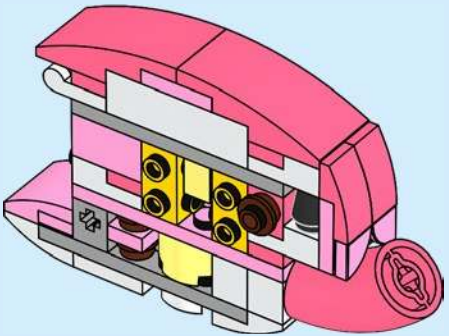

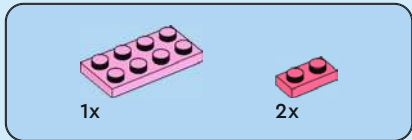
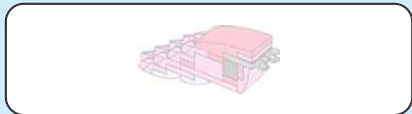

24

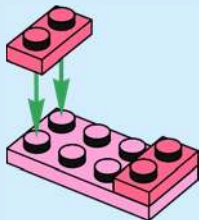

25

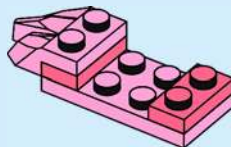

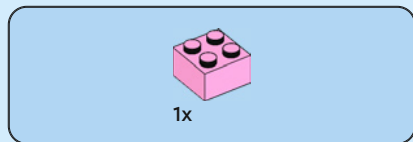

26

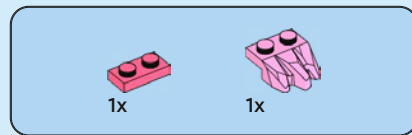
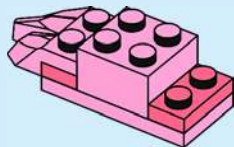

27

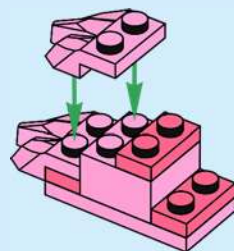



1x

28

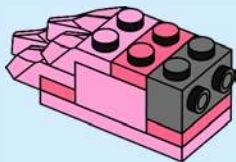

1x



1x

29

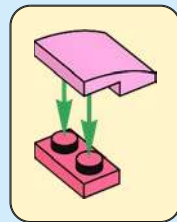

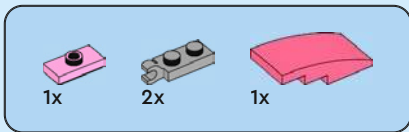

30

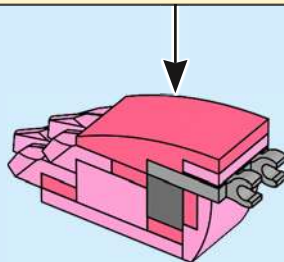
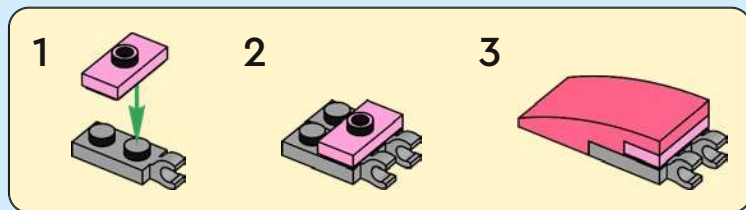



31

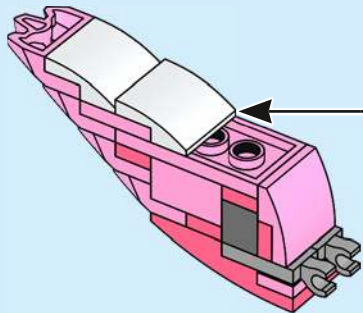
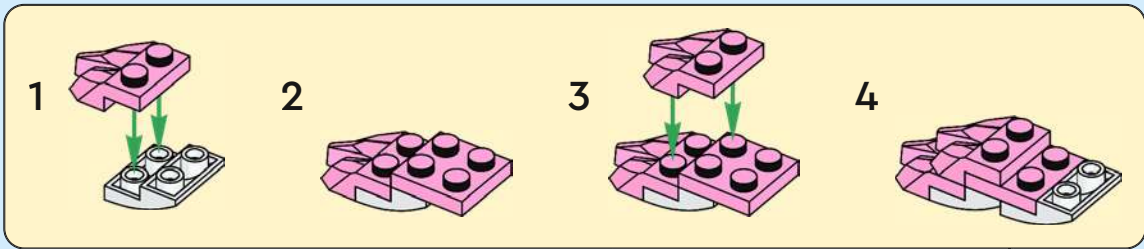

32

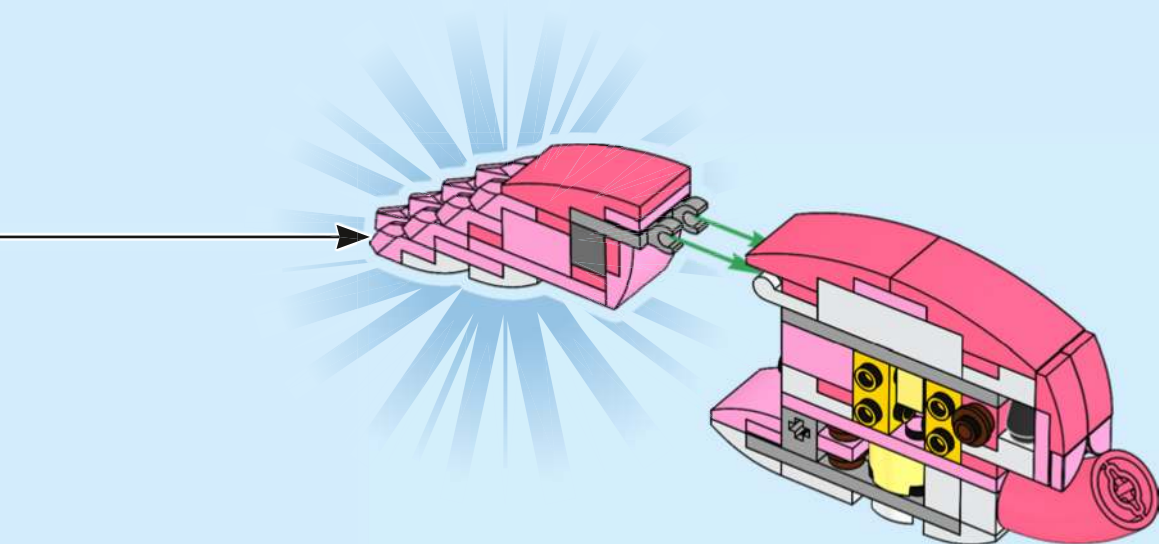

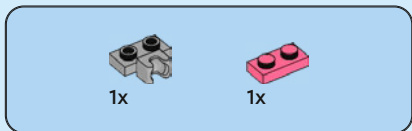
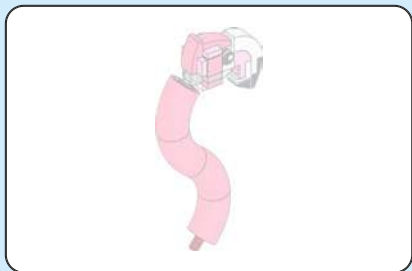

33

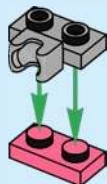

34





2x

# 35



2x



1x



1x



1x

# 36

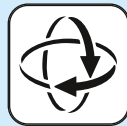
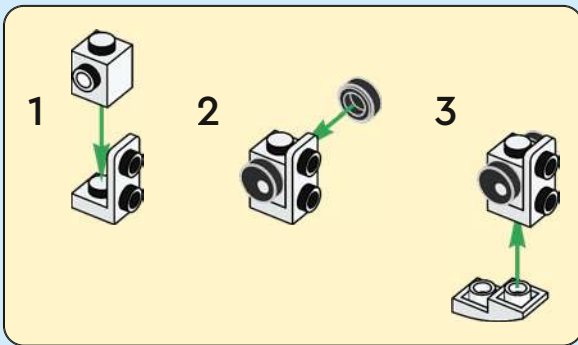



1x

37



1x

38



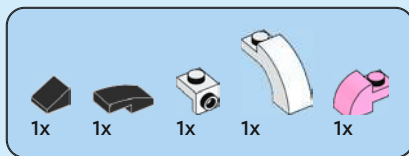

39

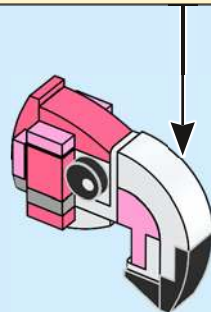
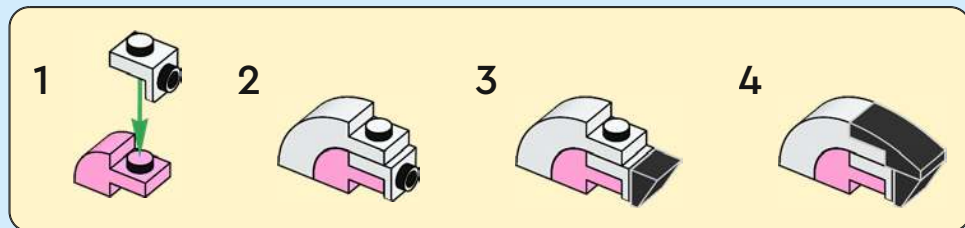

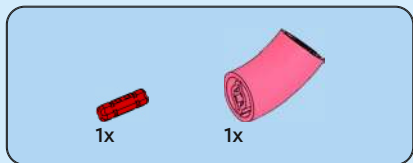

40

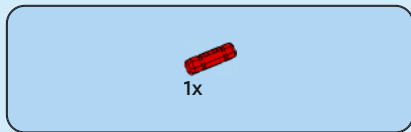
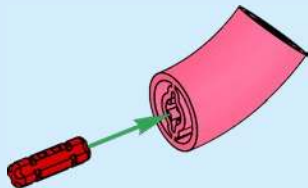

41



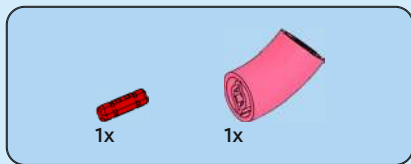

42

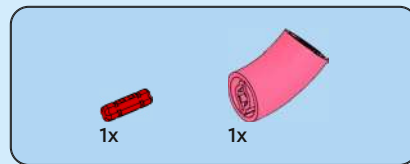
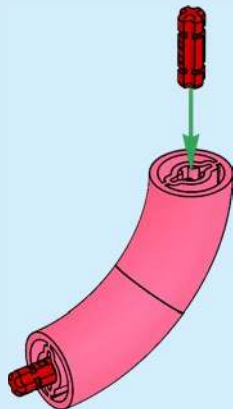

43

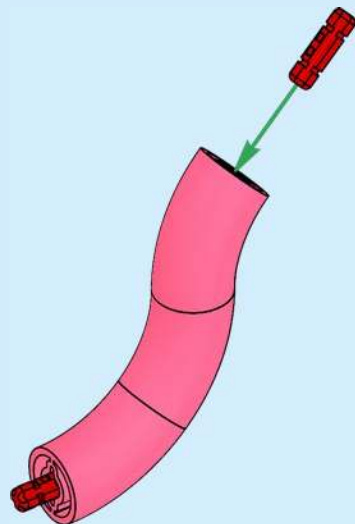

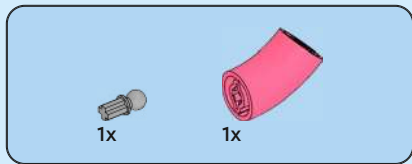

44

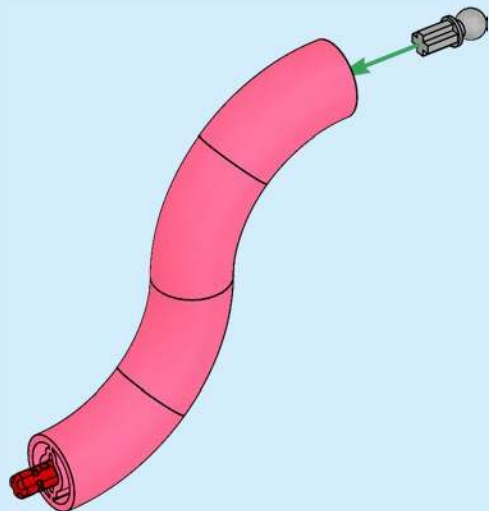

45

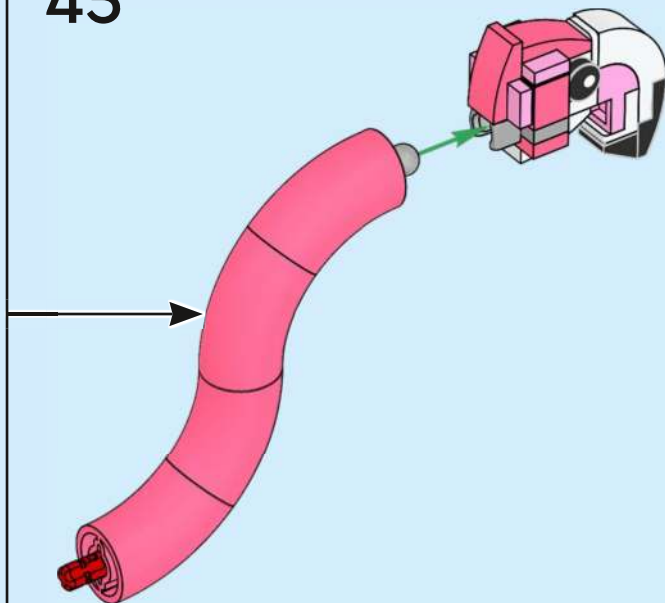

46

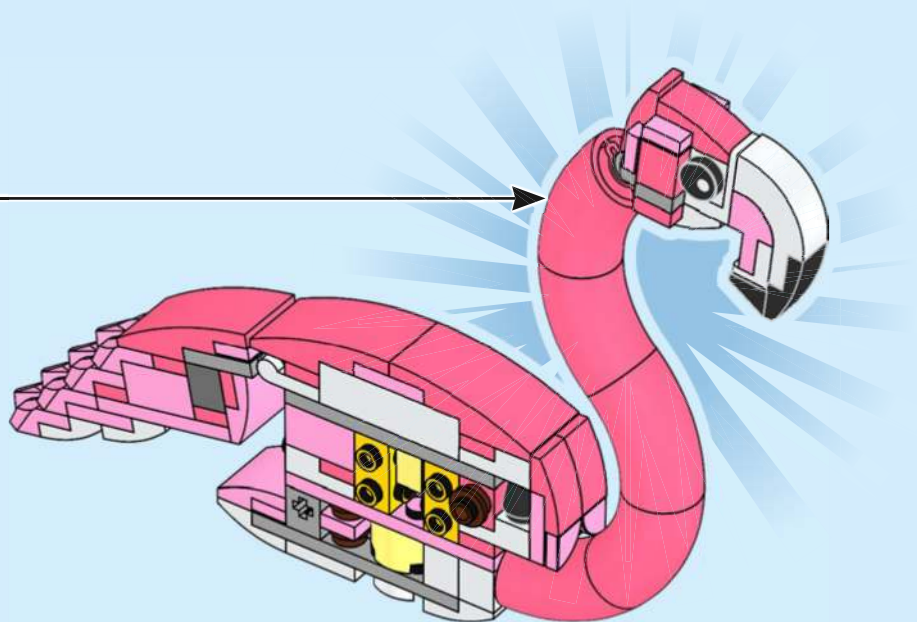

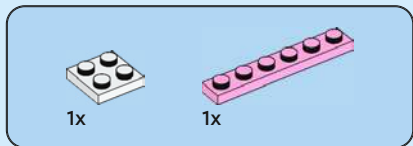
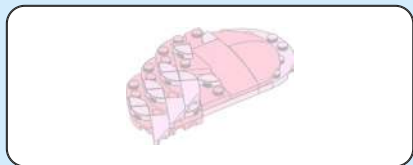

47

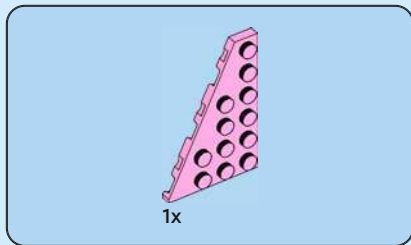

48

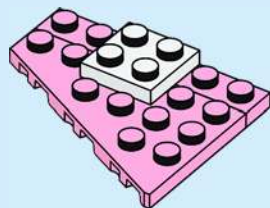



2x

49

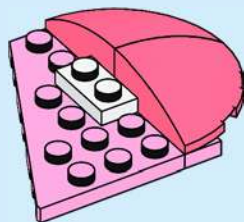

1x

50

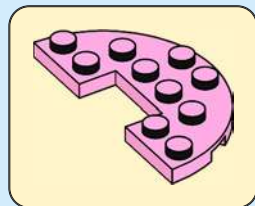
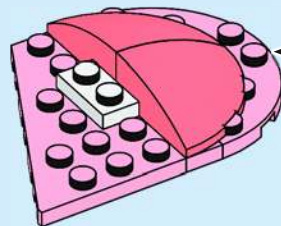



1x

51

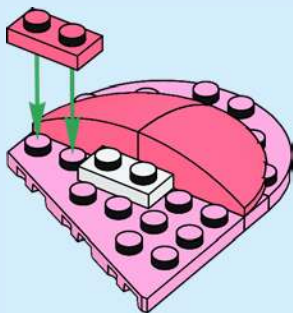

1x

52

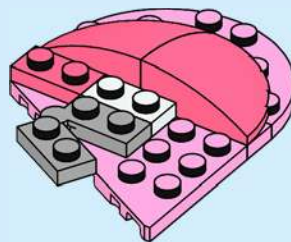

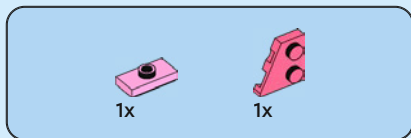

53

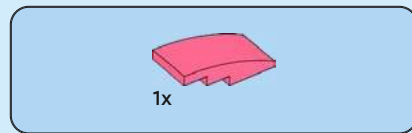
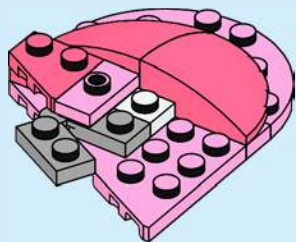

54

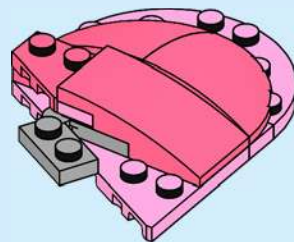



1x

55

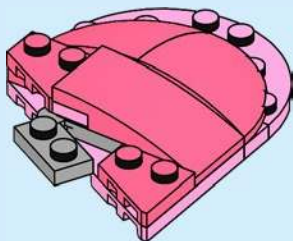

2x

56



2x

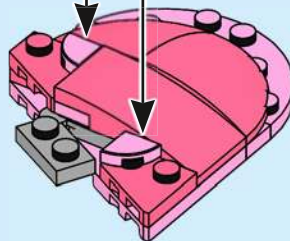

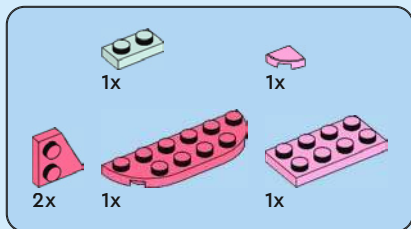

57

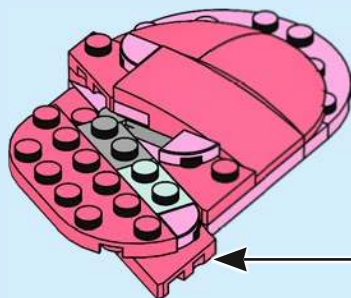
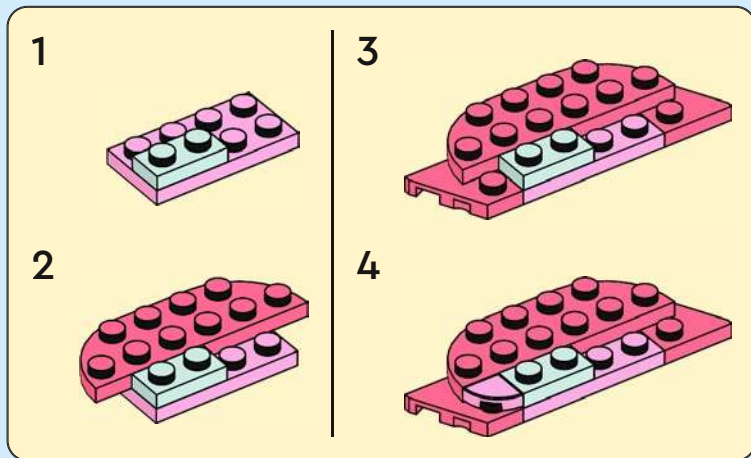

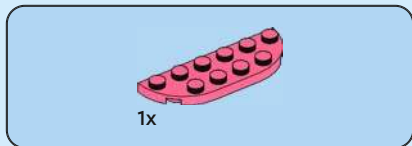

58

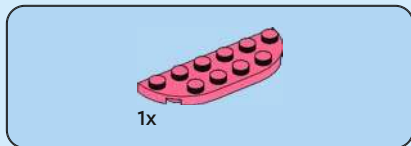

59

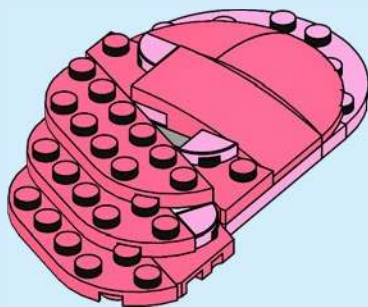



1x



3x

60

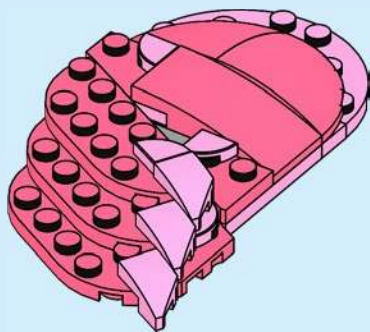

1x



1x

61

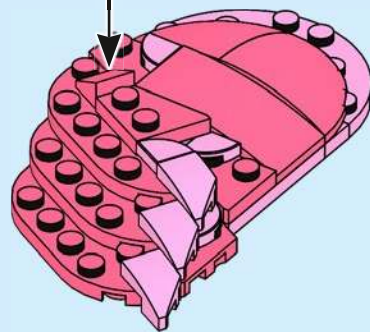



62

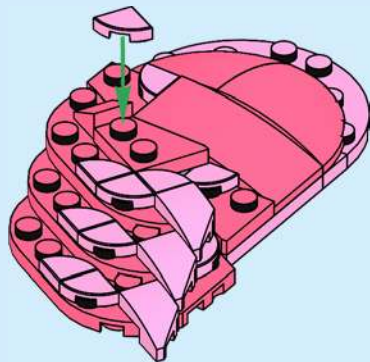

63

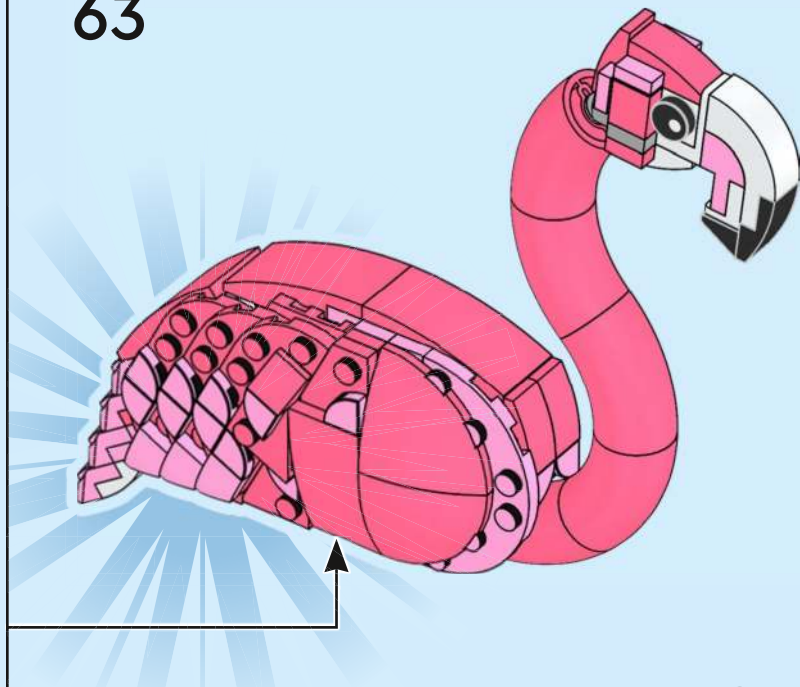



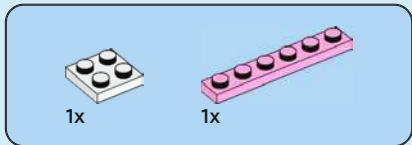
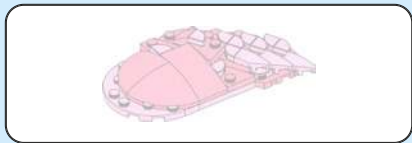

64

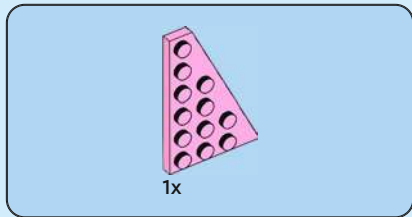
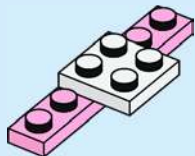

65

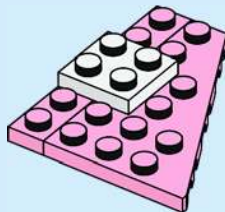



2x

66

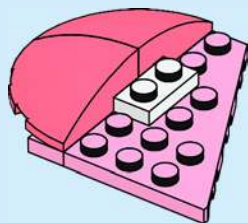

1x

67

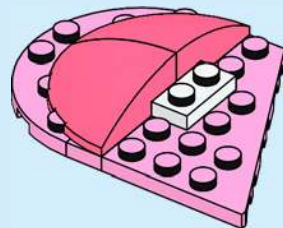



1x

68

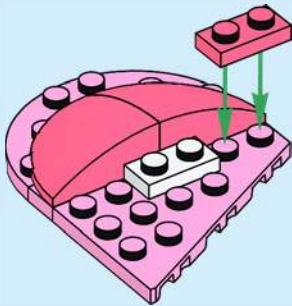

1x

69

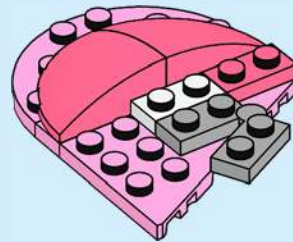



1x



1x

70

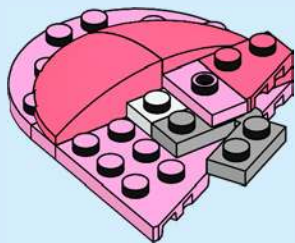

1x

71

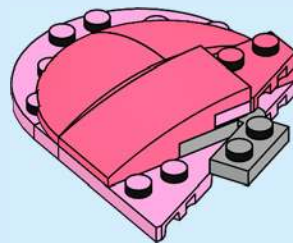



1x

72

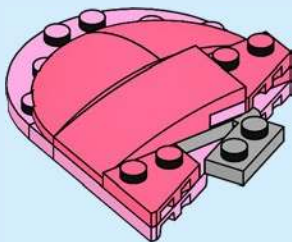

2x

73



2x

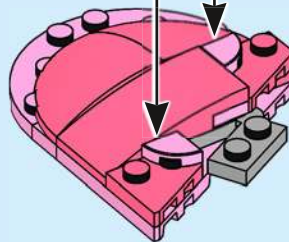

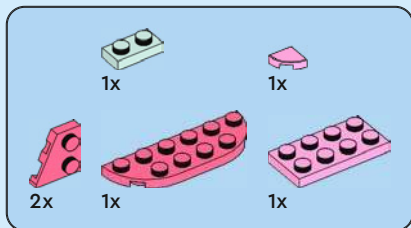

74

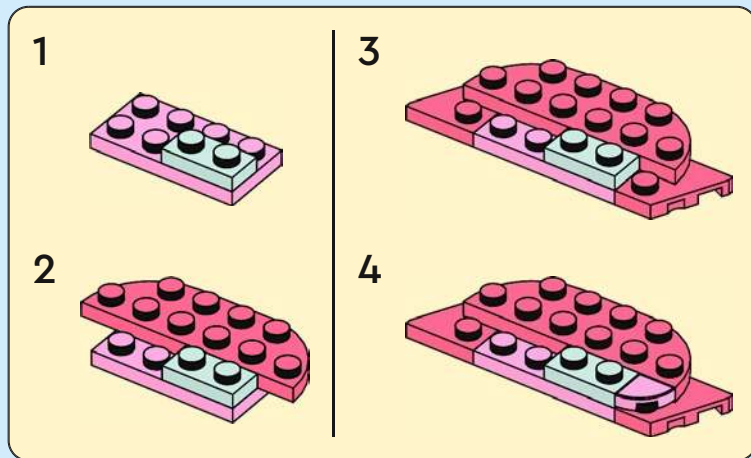

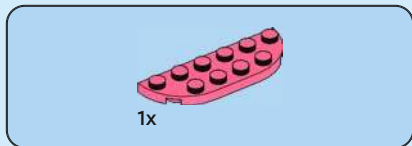

75

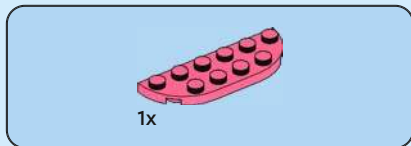

76

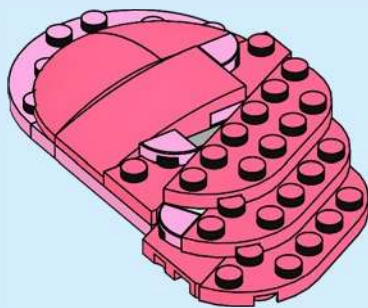



1x



3x

77

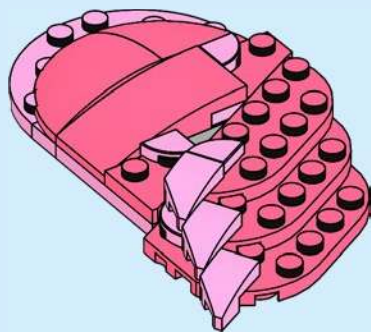

1x



1x

78

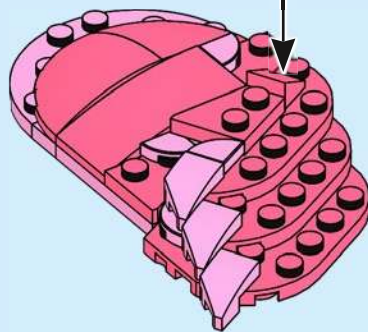
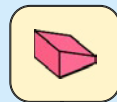



7x

79

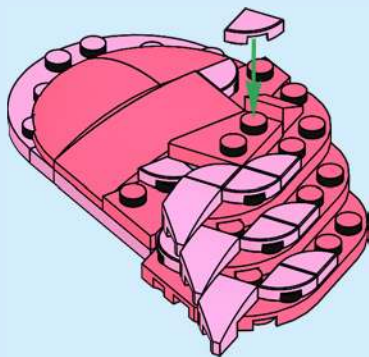

80

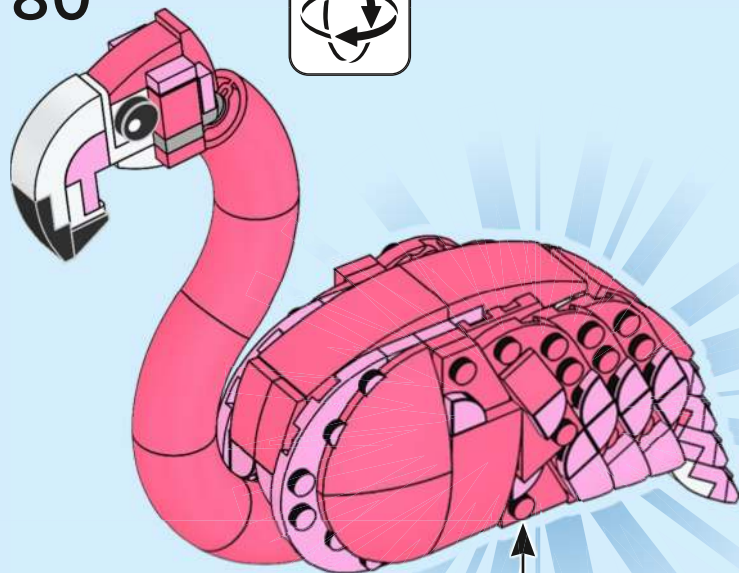

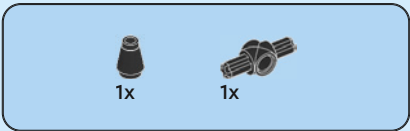

81

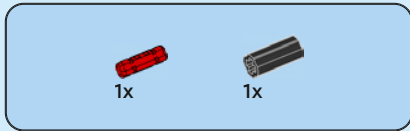
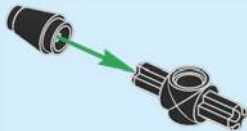

82

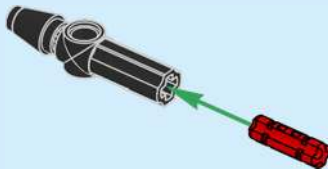



1x

83



1x

84

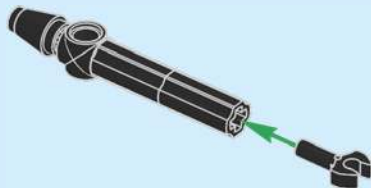



1x

85



1x

86

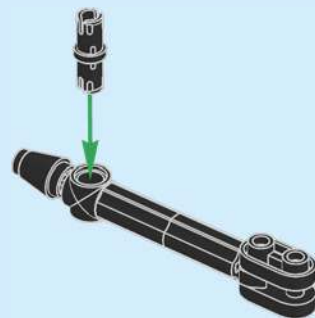

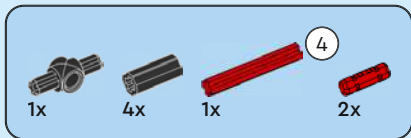
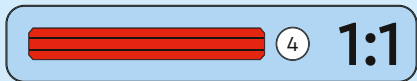

87

1

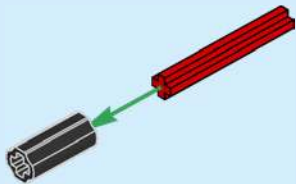

2



3

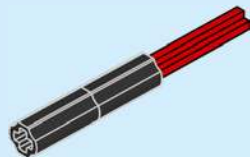

4

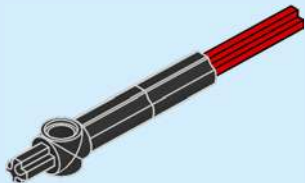

5

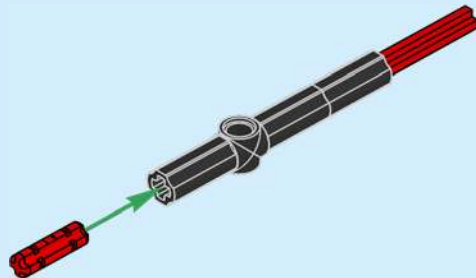

6

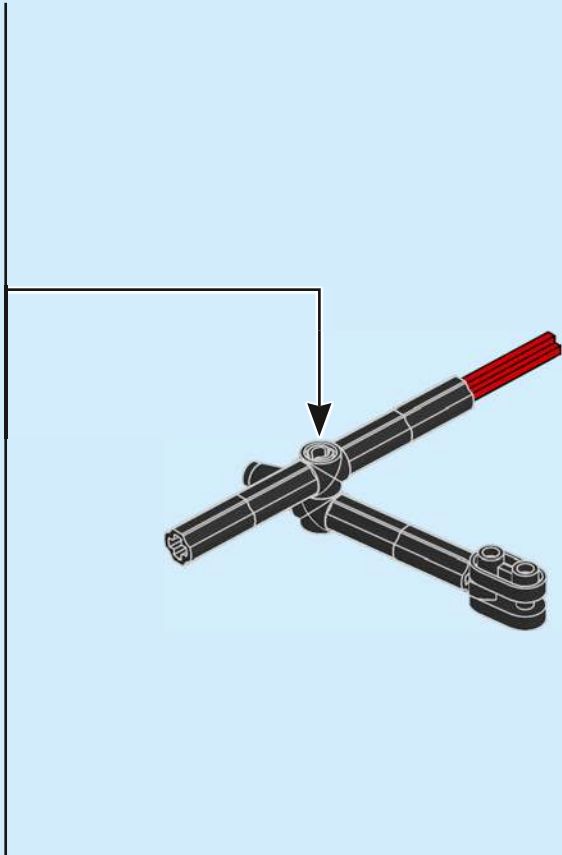
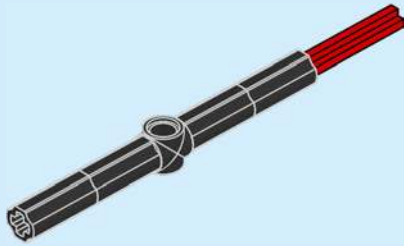



88

1

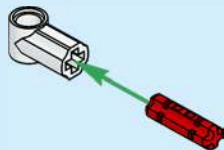

2

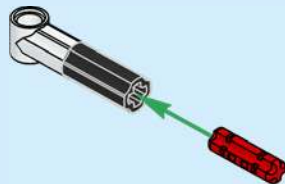

3



4

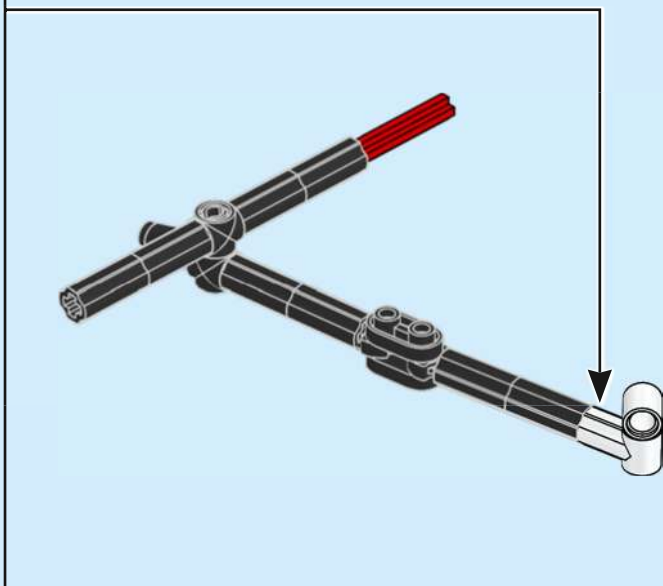
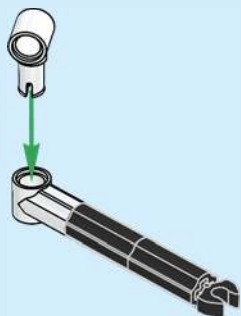

89

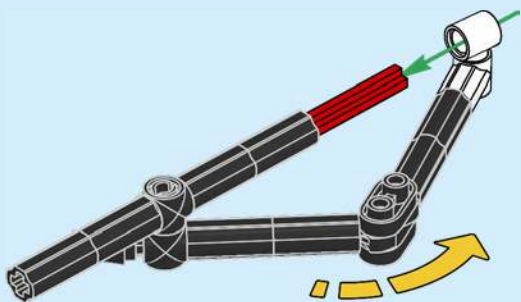

90

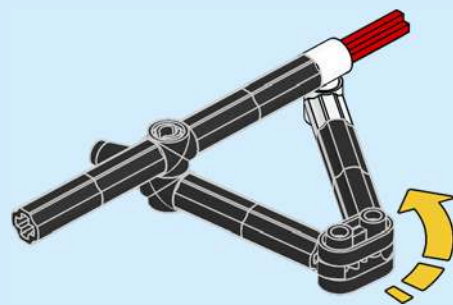

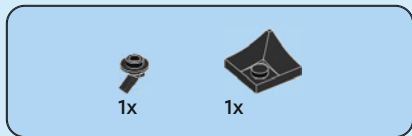

91

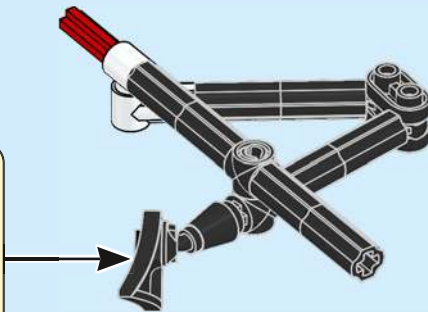
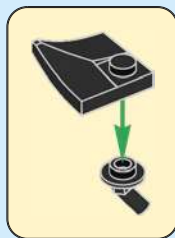

92

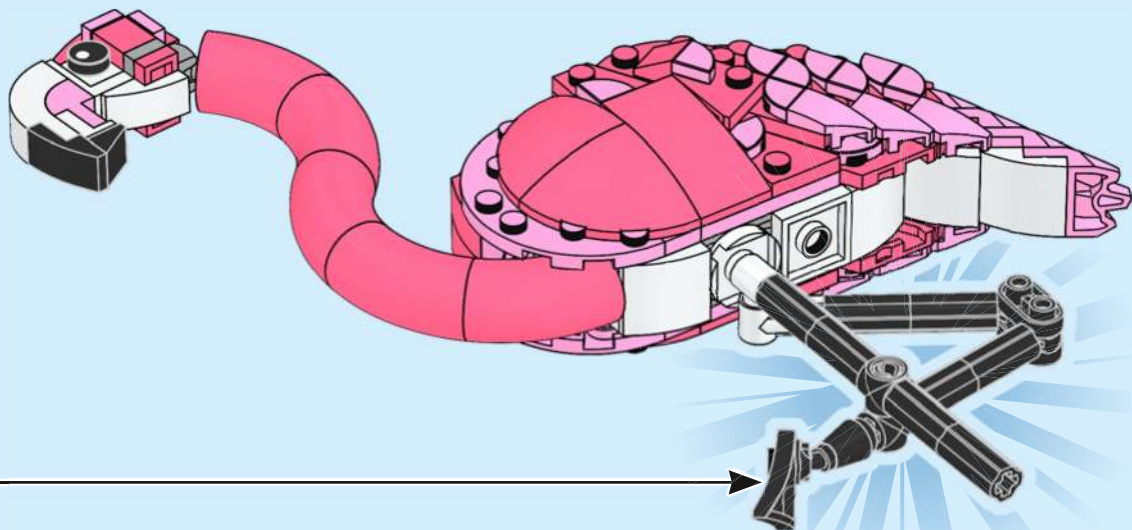
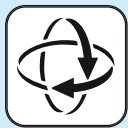

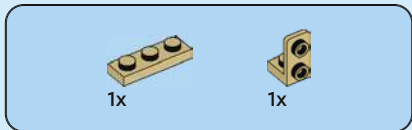

93

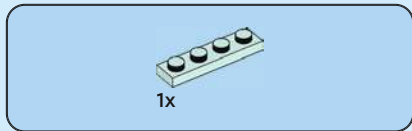
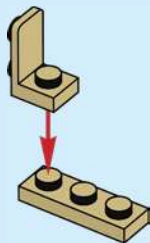

94

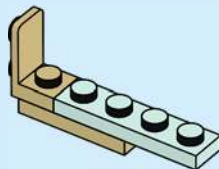



1x

95

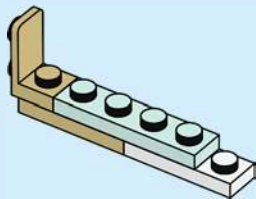

1x

96

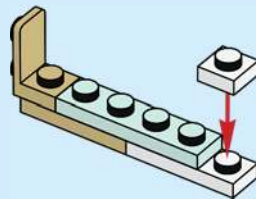

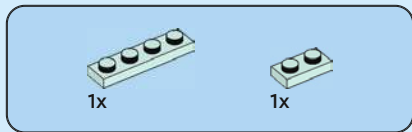

97

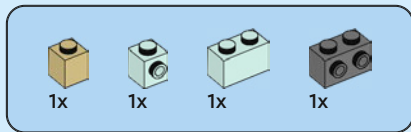
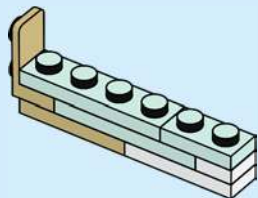

98

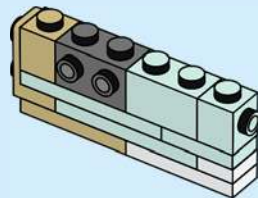

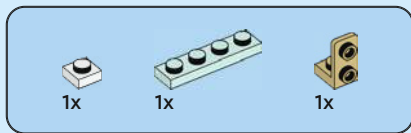

99

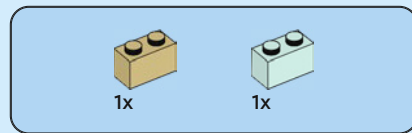
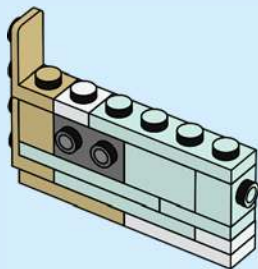

100

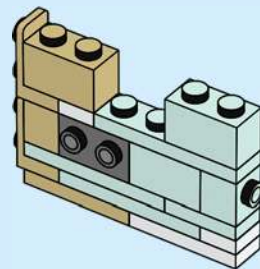

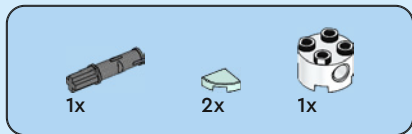

101

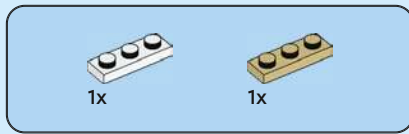
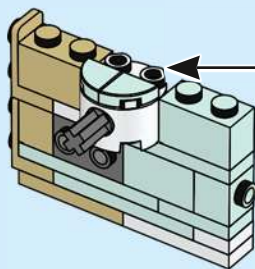
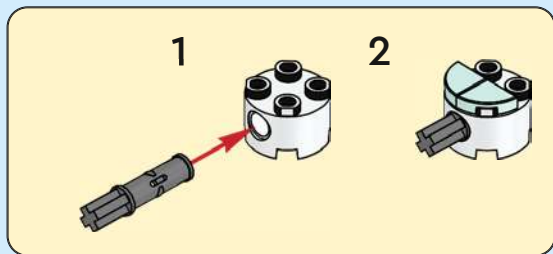

102

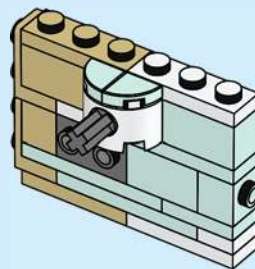

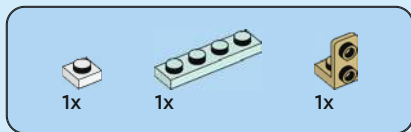

103

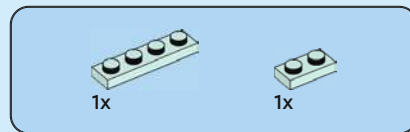
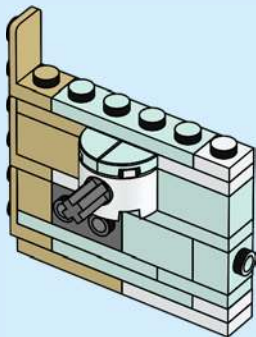

104

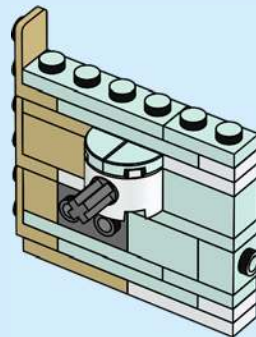

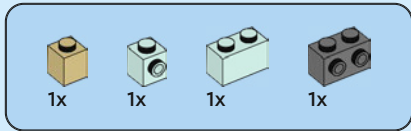

105

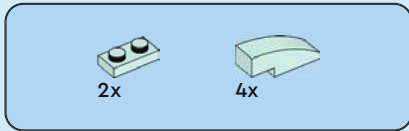
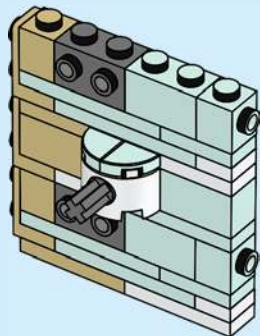

106

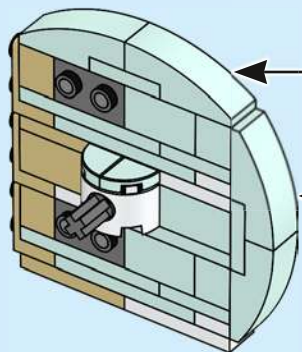
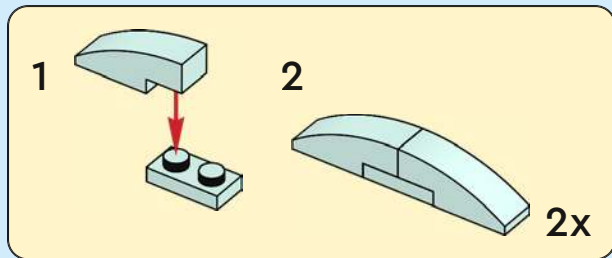

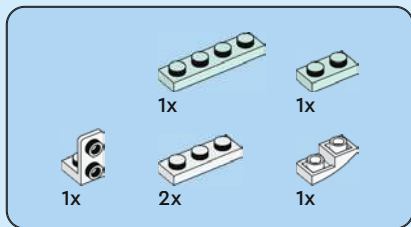

107

1

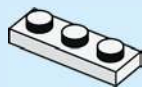

2

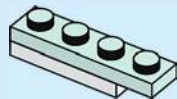

3

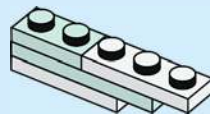

4

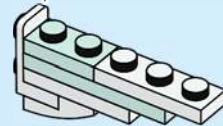
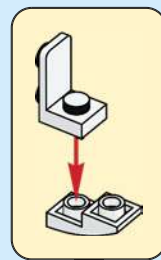

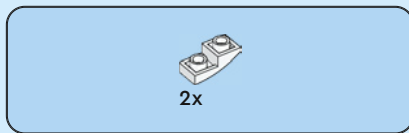
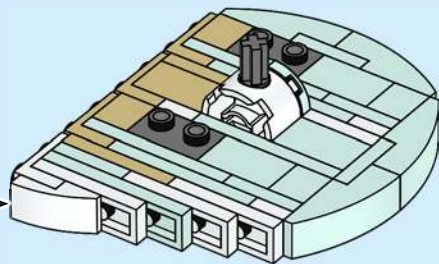

108

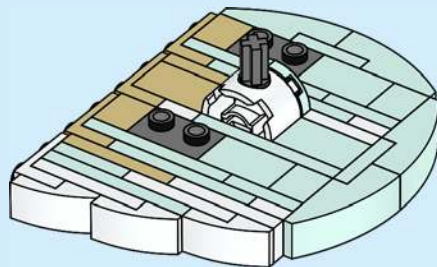

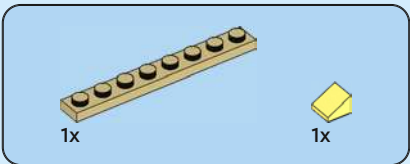

109

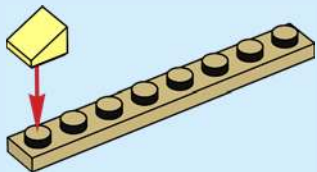

110

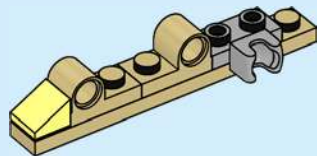



1x



1x



1x

# 111

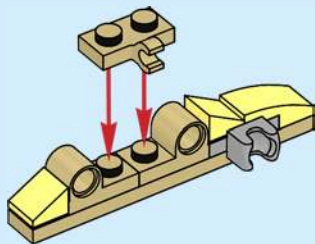

2x

# 112

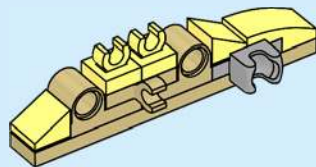



2x

113

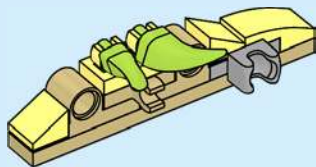

114

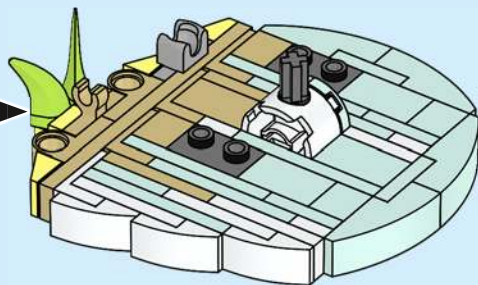

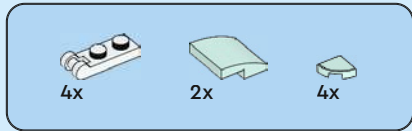

115

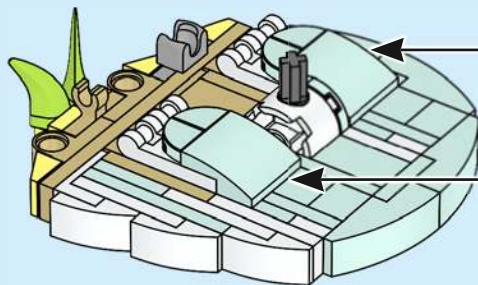
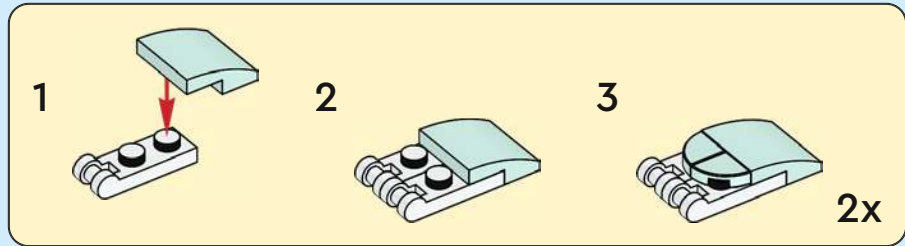



116

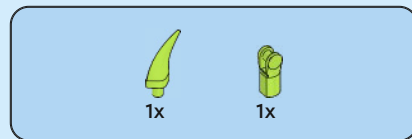
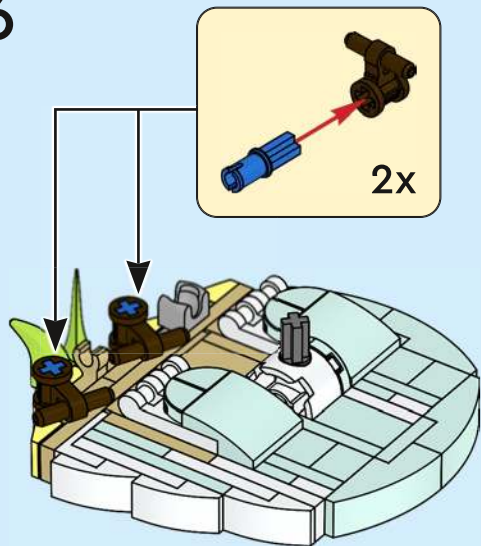

117

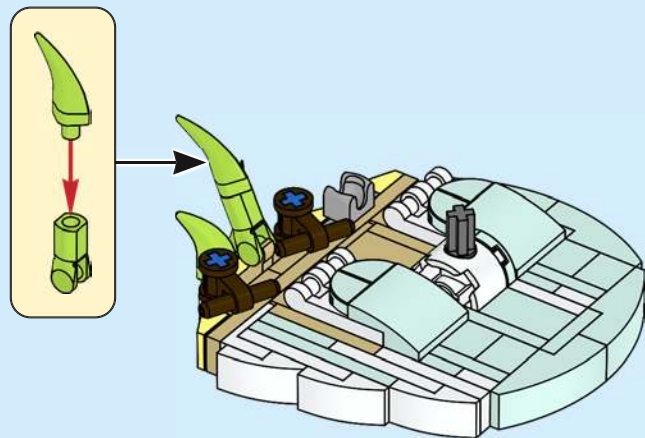



2x



2x



6x



2x



2x

118

1



2



3



4



5



2x

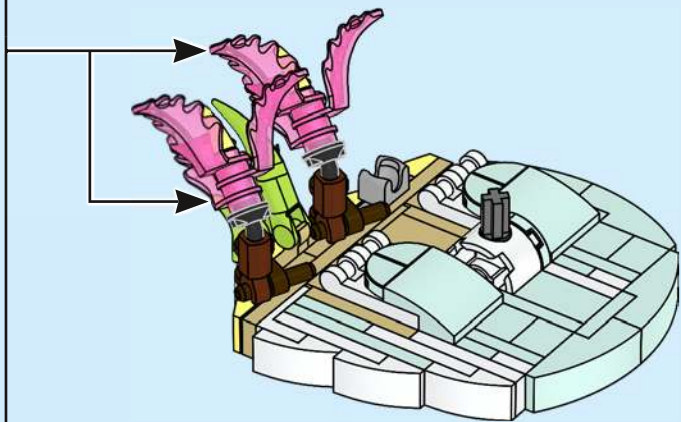



119

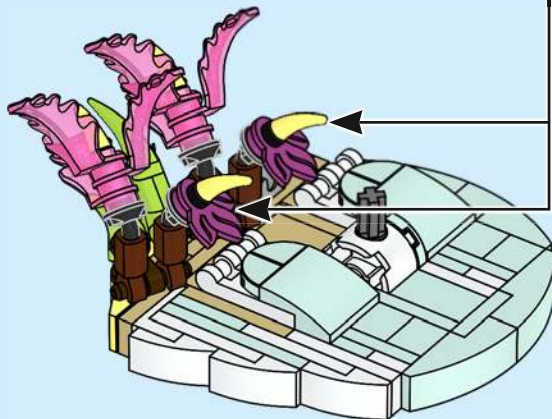
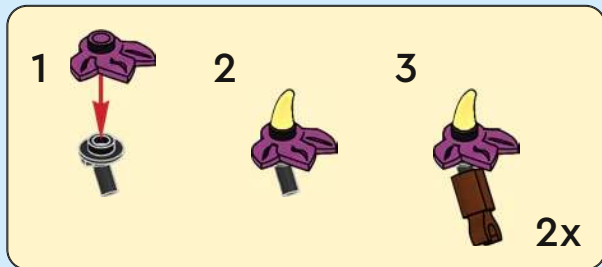



120

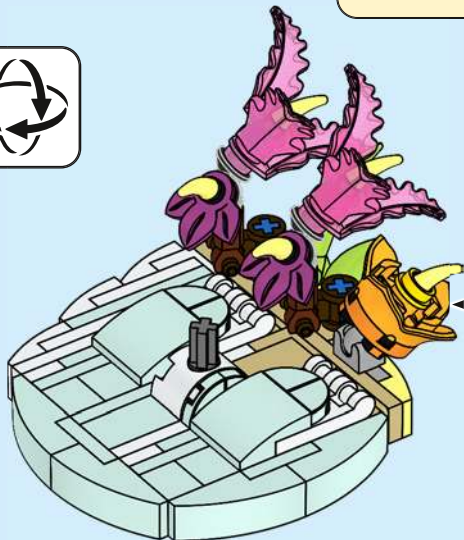

121

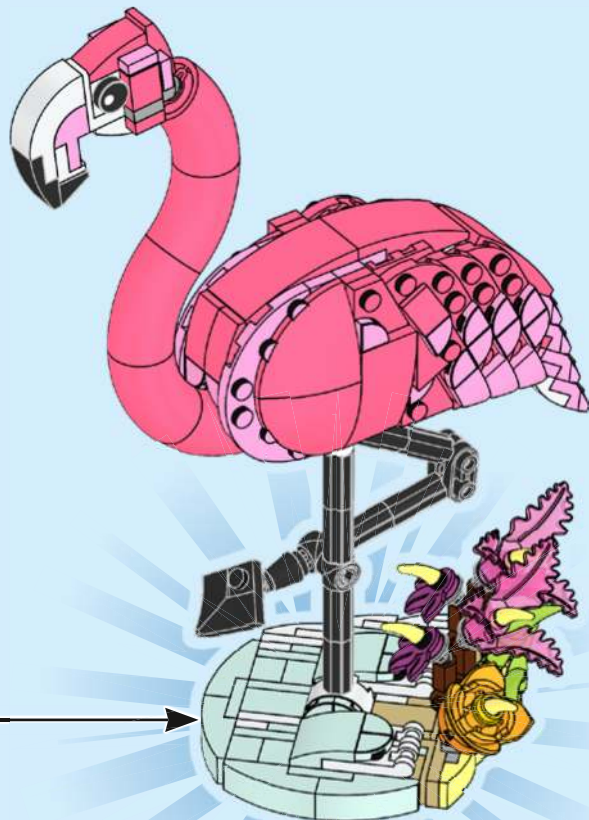



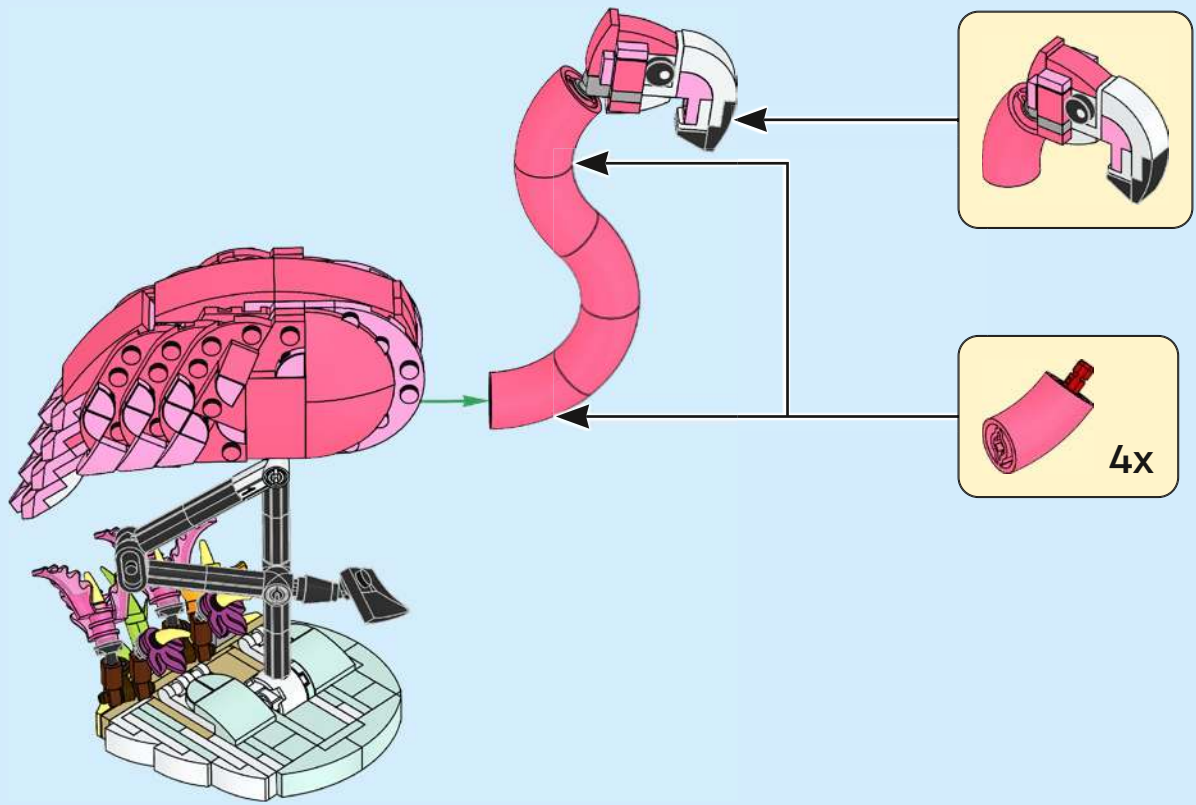

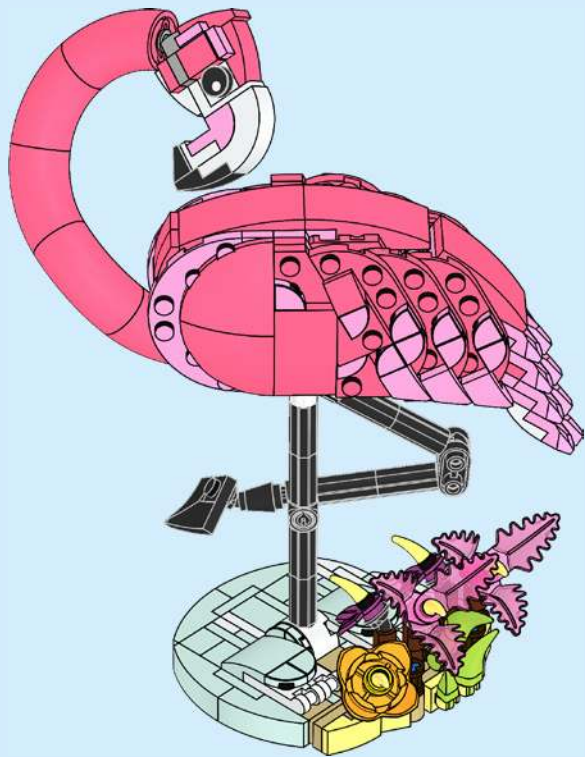
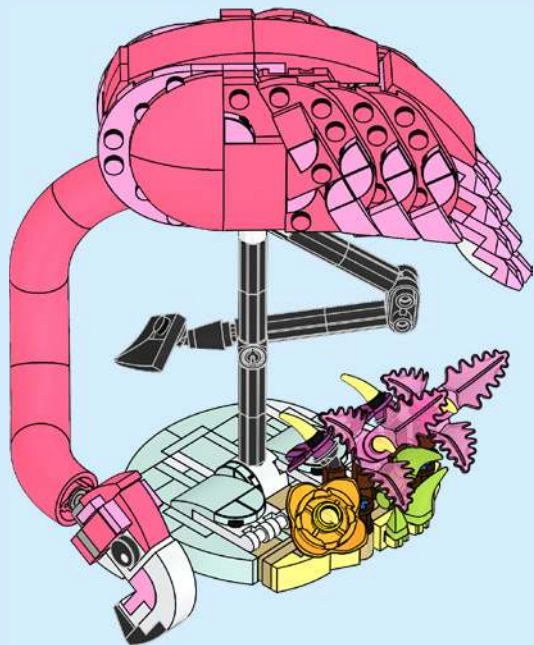

YOU COULD  
**WIN**



Scan this QR code or go to  
**LEGO.COM/PRODUCTFEEDBACK** and give us  
your short feedback about this LEGO® set  
for a chance to win a cool LEGO prize.

Terms and Conditions apply\*

**EN: YOU COULD WIN.** Terms and Conditions apply\* **DE: Du könntest GEWINNEN.** Es gelten die Teilnahmebedingungen\* **FR: Tu pourrais GAGNER.** Des conditions s'appliquent\* **IT: Potresti VINCERE tu.** Termini e condizioni sono applicabili\* **ES: Puedes GANAR.** Aplican términos y condiciones\* **PT: PODERÁ GANHAR.** Aplicam-se Termos e Condições\* **ZH: 轻松获奖.** 条款和条件适用\* **PL: Szansa na WYGRANĄ.** Obowiązuje regulamin\* **CS: Máte šanci VYHRÁT.** Platí všeobecné smluvní podmínky\* **SK: Máte šancu VYHRAŤ.** Platia všeobecné zmluvné podmienky\* **HU: TE IS NYERHETSZ.** Felhasználási feltételek érvényesek\* **UA: ВИ МОЖЕТЕ ВИГРАТИ.** Застосовуються загальні положення та умови\* **RO: Ai putea CÂȘTIGA.** Se aplică termeni și condiții\* **BG: Можете да СПЕЧЕЛИТЕ.** Има определени правила и условия\* **LV: Tu vari LAIMĒT.** Ir spēkā noteikumi un nosacījumi.\* **ET: Sul on võimalus VÕITA.** Kehtivad tingimused\* **LT: Jūs galite LAIMĖTI.** Taikomos sąlygos\*

\*[LEGO.com/productfeedback-terms](https://www.lego.com/productfeedback-terms)