



76970





LEGO® Builder



LEGO.com/sustainable-packaging



FR
DONNEZ
OU
RECYCLEZ

 OU  OU 

ASSOCIATION MAGASIN DÉCHÈTERIE

Adresses sur quefairedemesdechets.fr

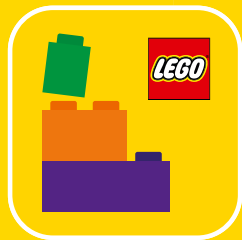

Q LEGO® Builder

BUILDER



Apple and the Apple logo are trademarks of Apple Inc., registered in the U.S. and other countries and regions. App Store is a service mark of Apple Inc. Google Play and the Google Play logo are trademarks of Google LLC. Tencent and the Tencent logo are trademarks of Tencent Inc.

Q [LEGO.com/devicecheck](https://www.lego.com/devicecheck)

EN Ask parents' permission before going online | DE Eltern um Erlaubnis bitten, bevor du online gehst | FR Demande l'autorisation d'un parent avant d'aller en ligne | IT Chiedi il permesso ai tuoi genitori prima di andare online | ES Pídeles permiso a tus papás antes de conectarte a Internet | PT pede autorização aos pais antes de acederes online | ZH 上网前应先征得父母的同意 | PL Poproś rodziców o zgodę, zanim wejdiesz do Internetu | CS Než půjdeš na internet, požádej rodiče o svolení | SK Skôr než pôjdeš na internet, vypýtaj si povolenie od rodičov | HU Kérj szülői engedélyt, mielőtt online csatlakoznál! | UA Запитуйте дозволу батьків, перш ніж користуватися інтернетом | RO Cere permisiunea părinților înainte de a te conecta online | BG Поискайте разрешение от родител, преди да влезете онлайн | LV Pirms došanās tiešsaistē palūdz atļauju vecākiem | ET Enne Interneti kasutamist küsi vanematelt luba | LT Prieš prisijungdami prie interneto, atsiklauskite tėvų

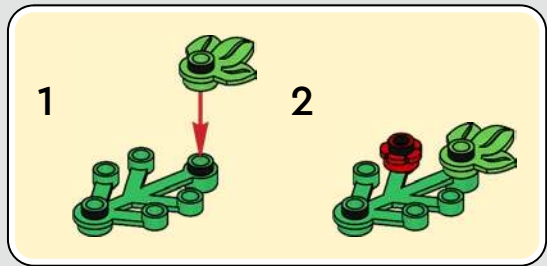
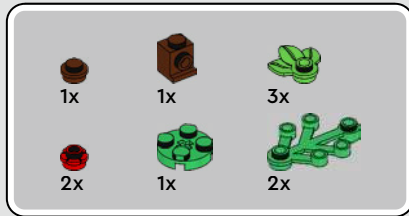

1



2



3



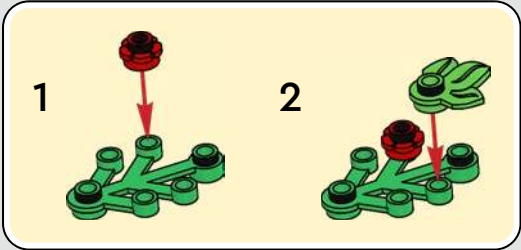

4

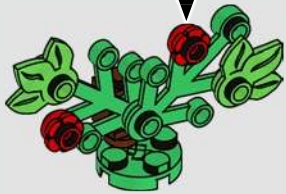

5

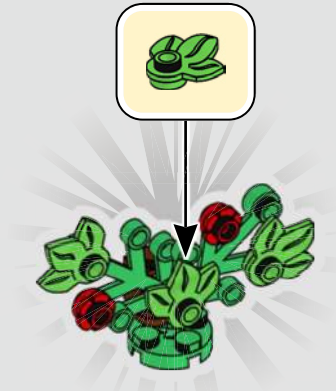

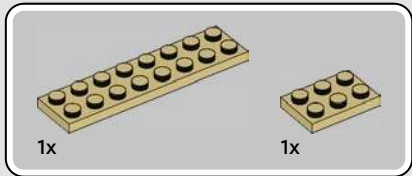
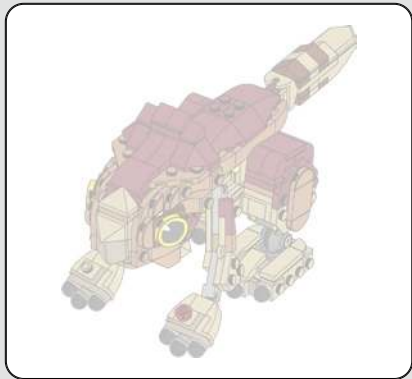

1

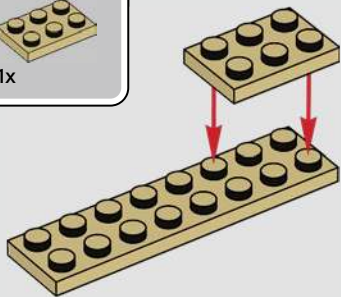

2

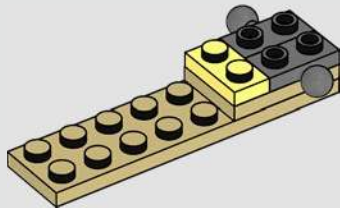



1x

3

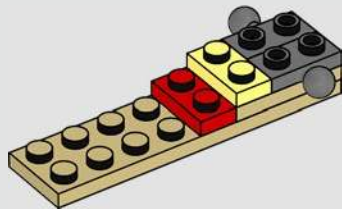

2x

4

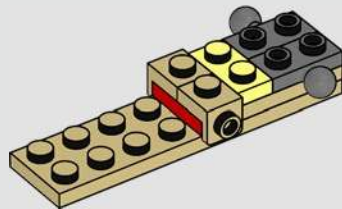



2x

5

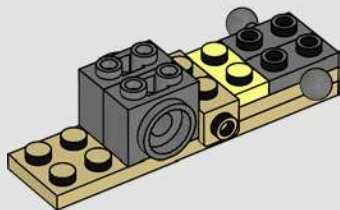

1x

6

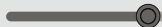
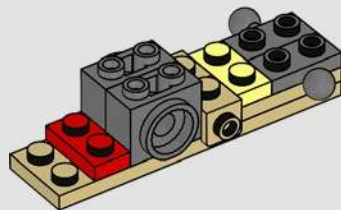



2x

7

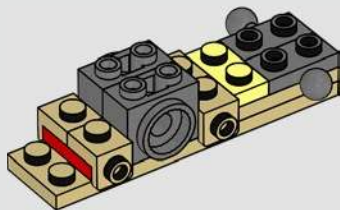

1x

8

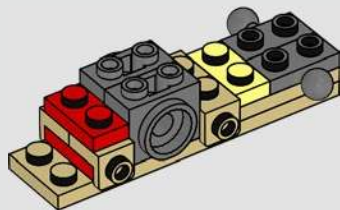



1x

9

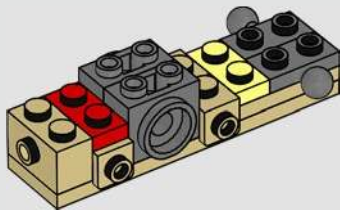

1x

10

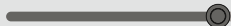
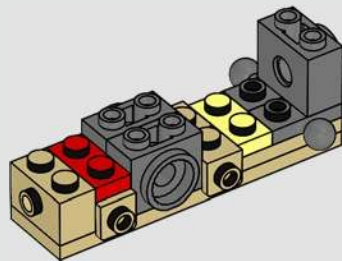



2x

11

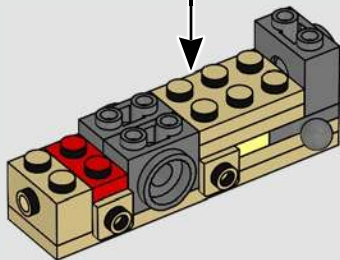
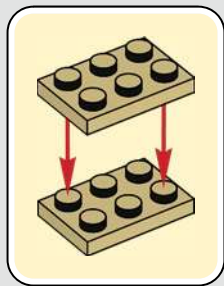

1x



2x

12

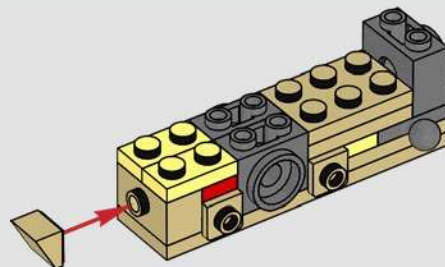

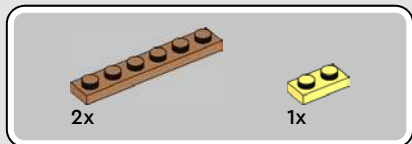

13

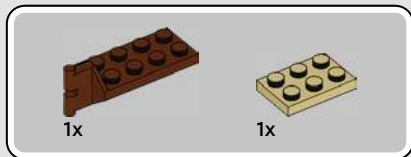
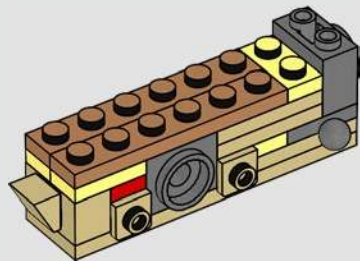

14

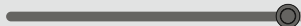
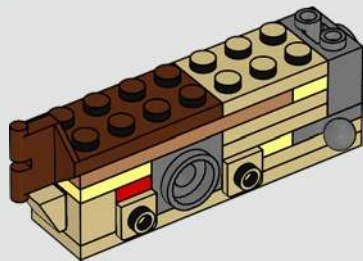

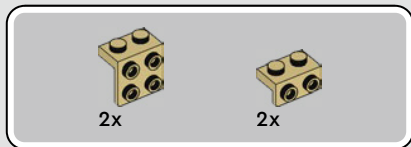

15

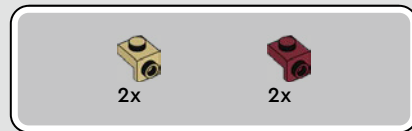
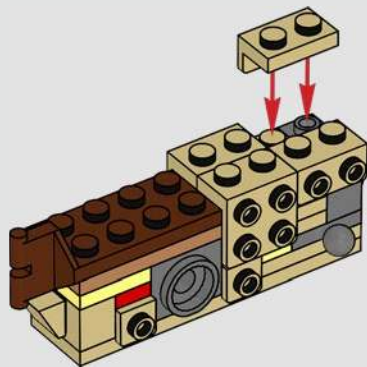

16

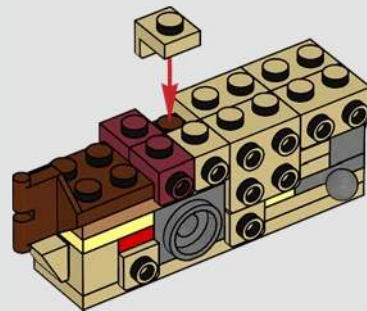



2x

19

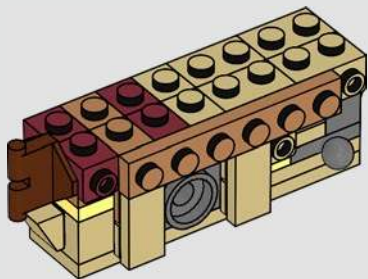

1x

20

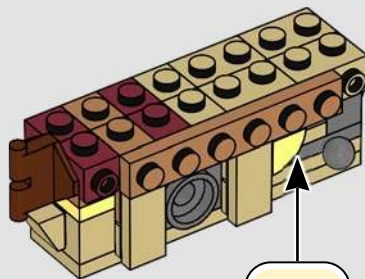

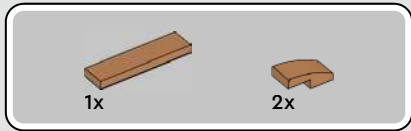

21

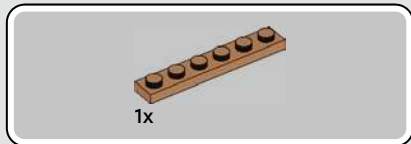
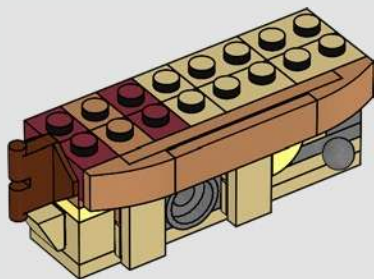

22

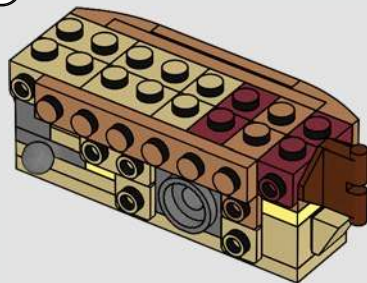



2x

23

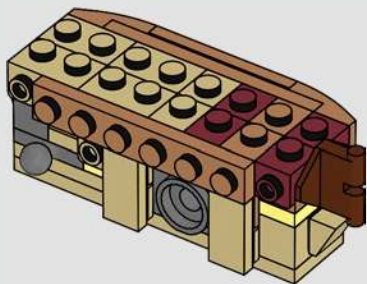

1x

24

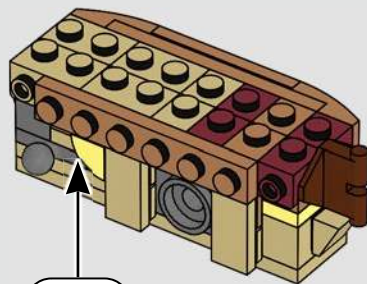

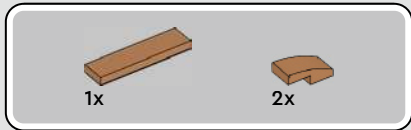

25

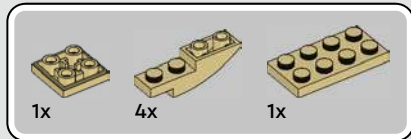
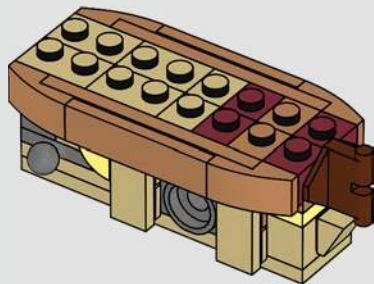

26

1



2

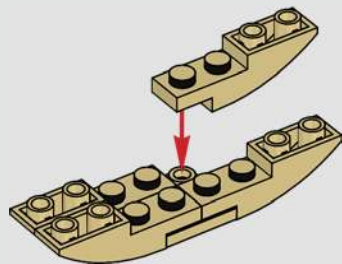

3

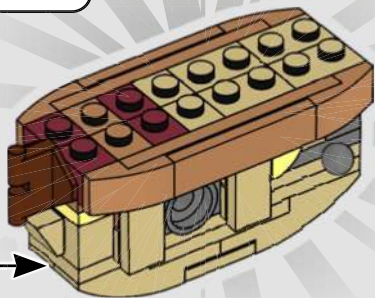
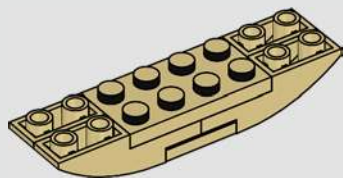

27



1x

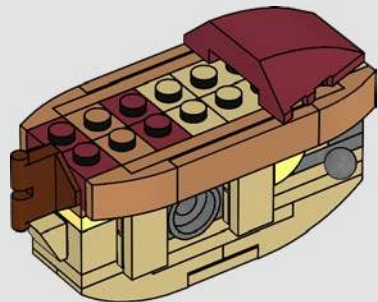



2x

28

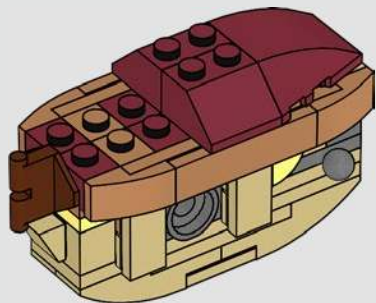

1x

29

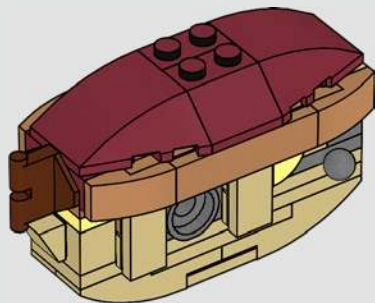



30

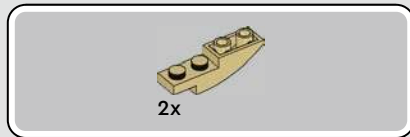
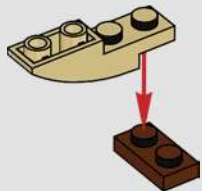

31

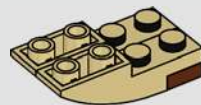

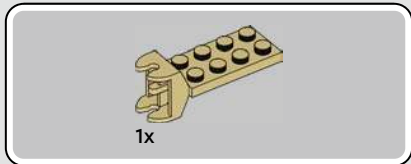

32

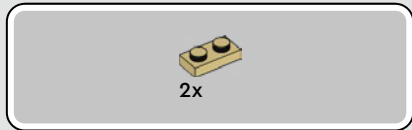
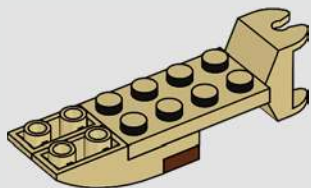

33

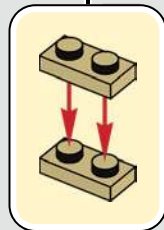
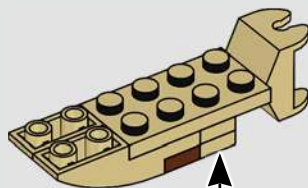



4x



2x

36

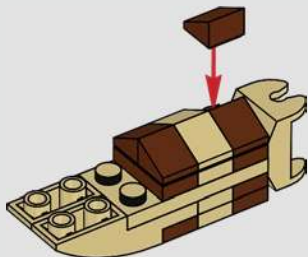

2x

37

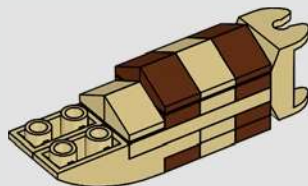

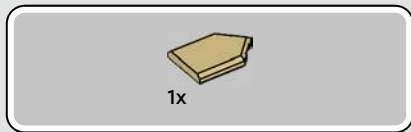

38

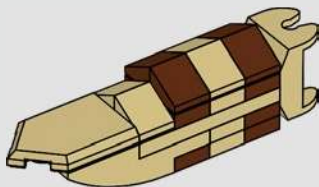

39

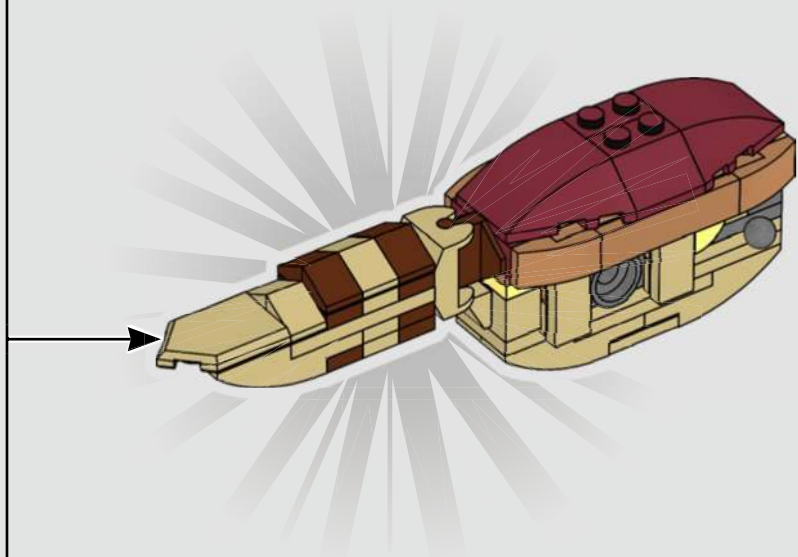

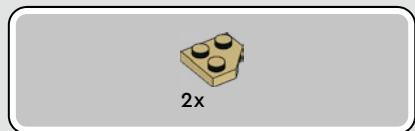

40

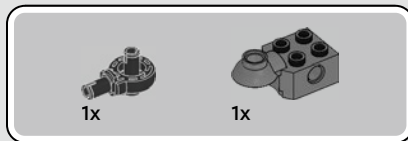
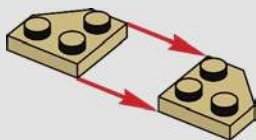

41

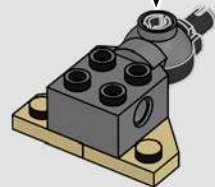
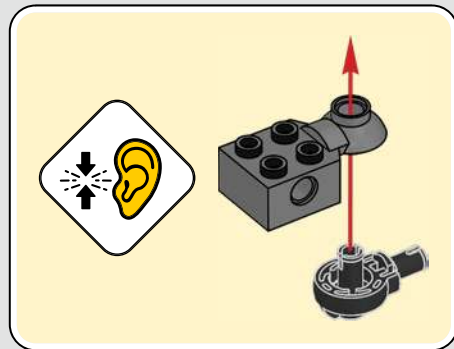



2x

42

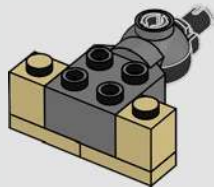

1x



2x

43

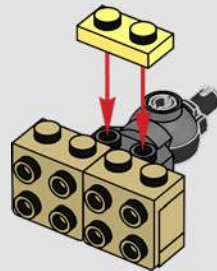

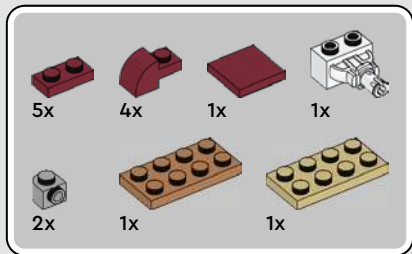

44

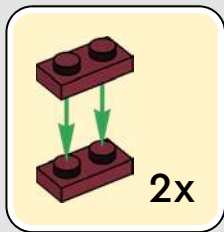

1

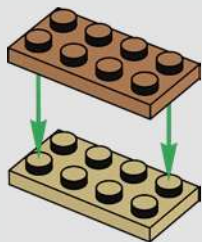

2

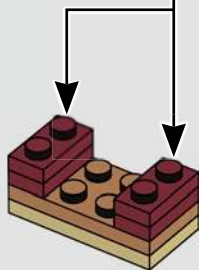

3

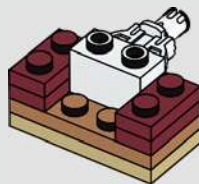

4

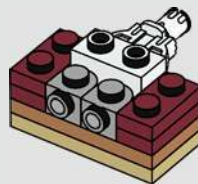

5

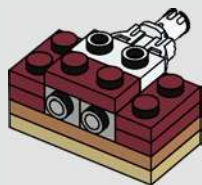

6

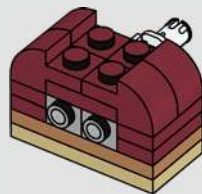

7

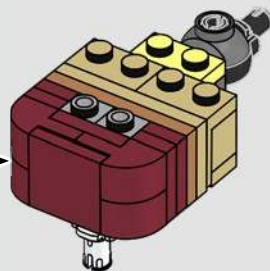
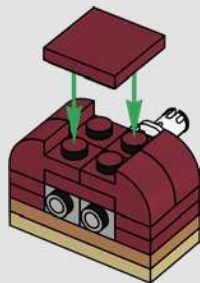



2x



2x

45

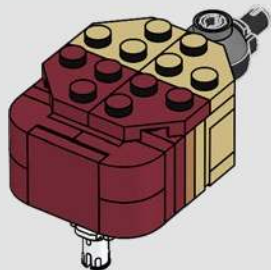

1x



2x

46

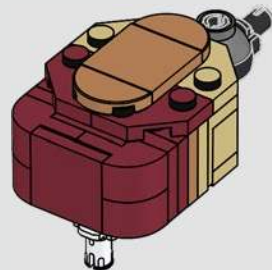

2x

47

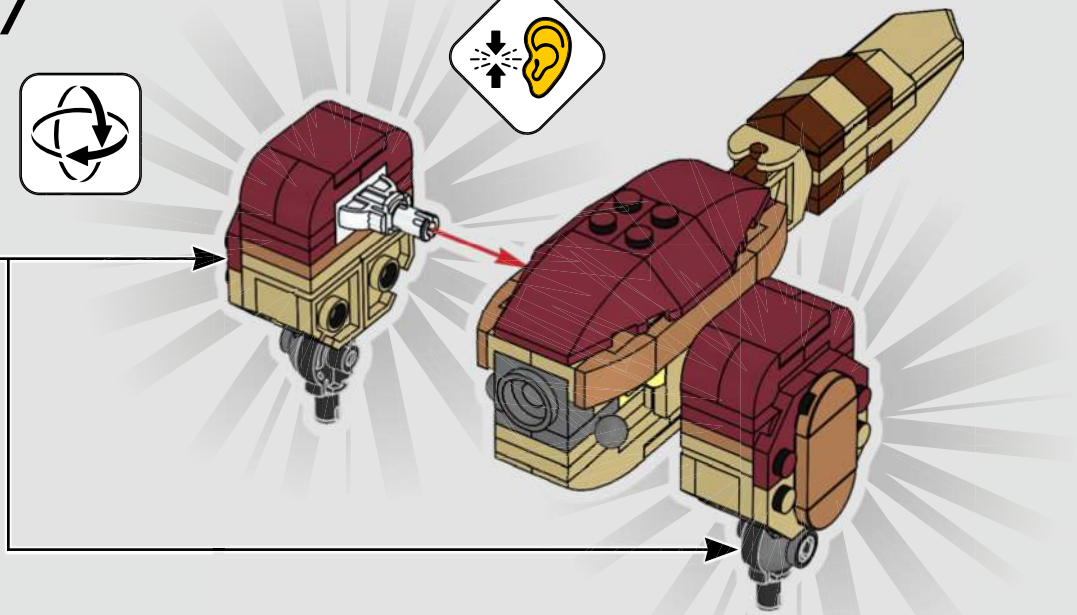



2x



1x

48



2x

49





1x

50



1x



1x

51

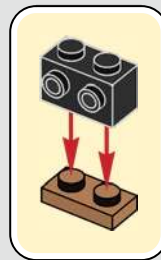



2x

52



2x

53

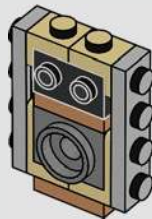



2x

54

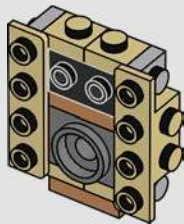

2x

55



2x



2x

56

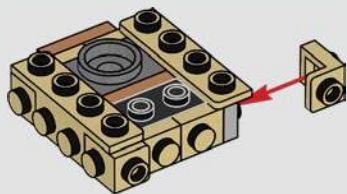

1x



1x

57

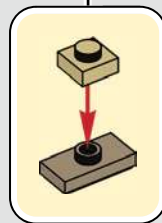
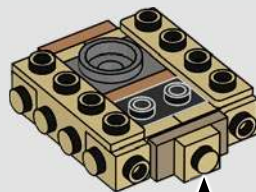



1x

58

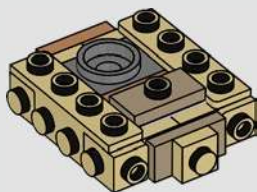

2x



1x

59

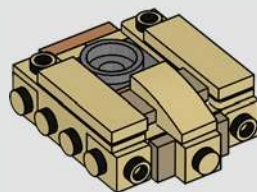



2x

60

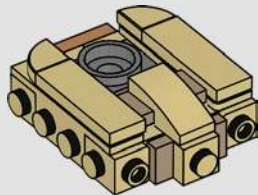

3x

61

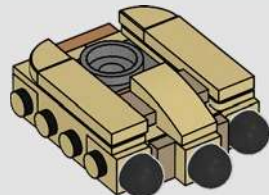

2x

62

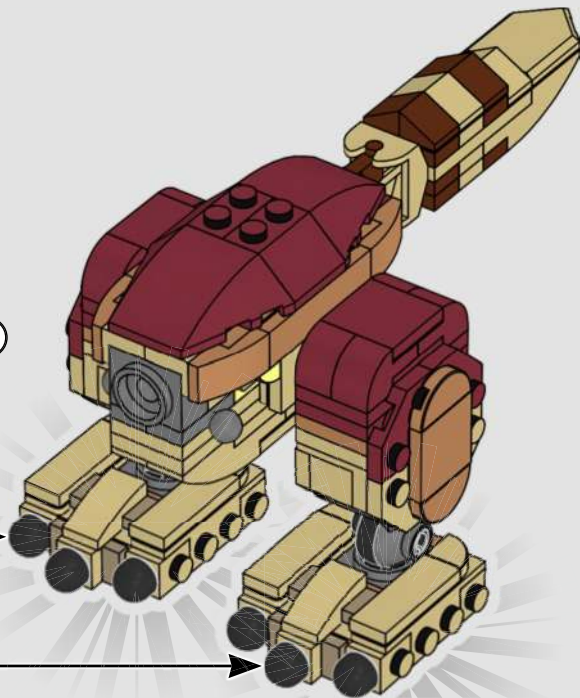

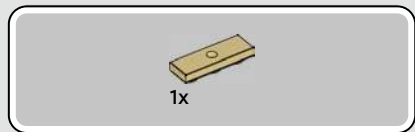

63

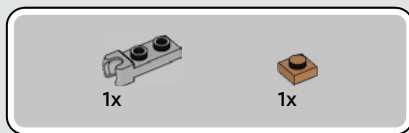
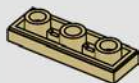

64

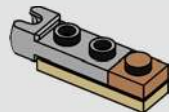



1x

65

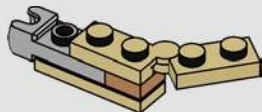

1x



1x

66





1x

67

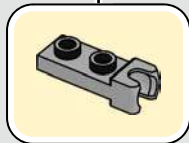
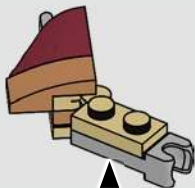

1x



1x

68

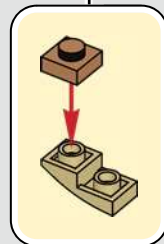
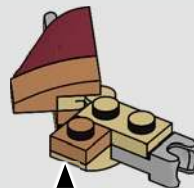



1x

69

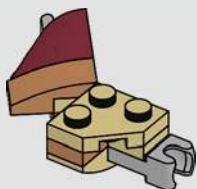

70

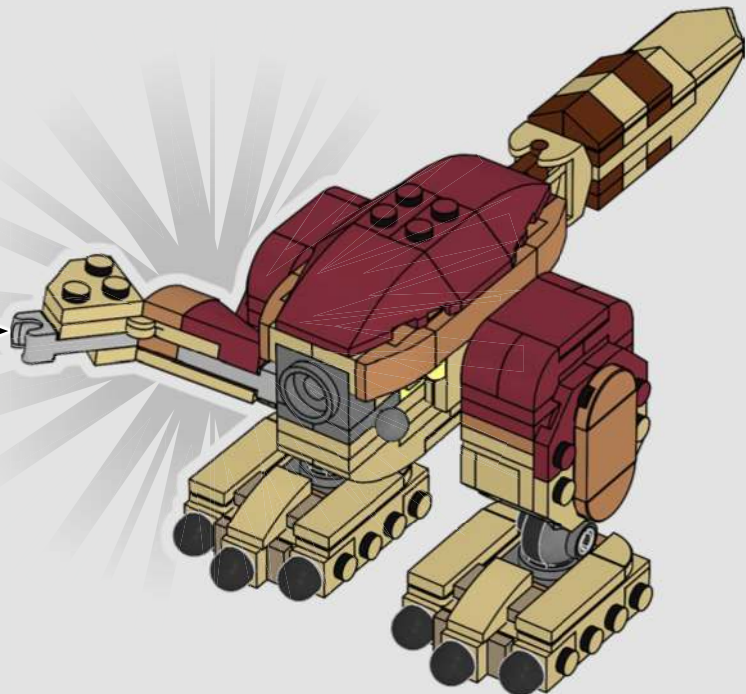



1x

71

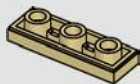

1x



1x

72

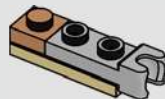



1x

73

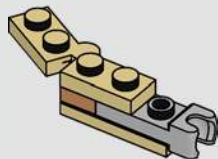

1x



1x

74

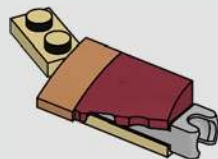



1x

75

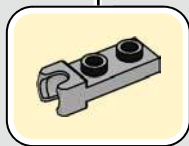
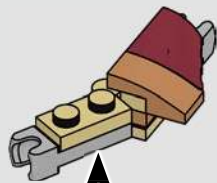

1x



1x

76

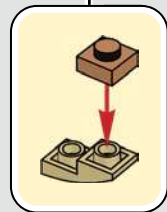
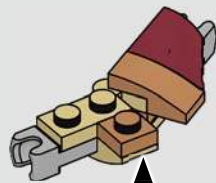



1x

77

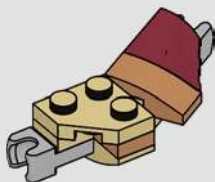

78

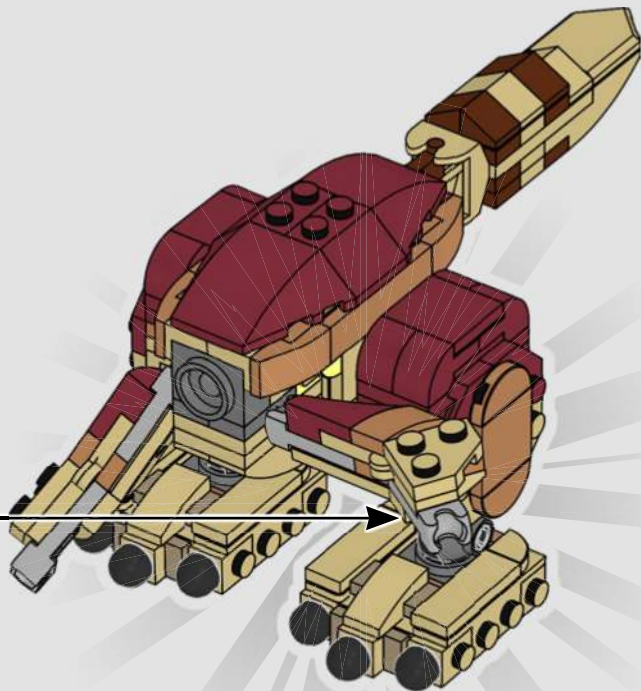



2x



1x

79



1x

80





1x

81

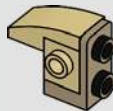

1x



1x

82

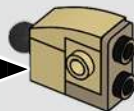
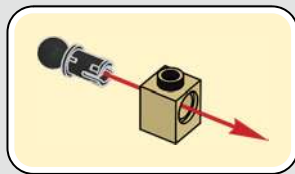



1x

83



1x

84



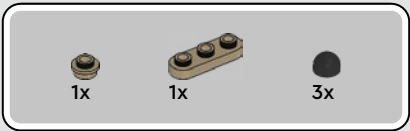

85

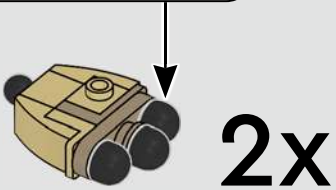
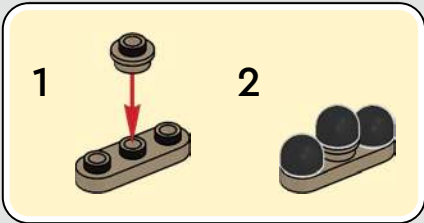

86

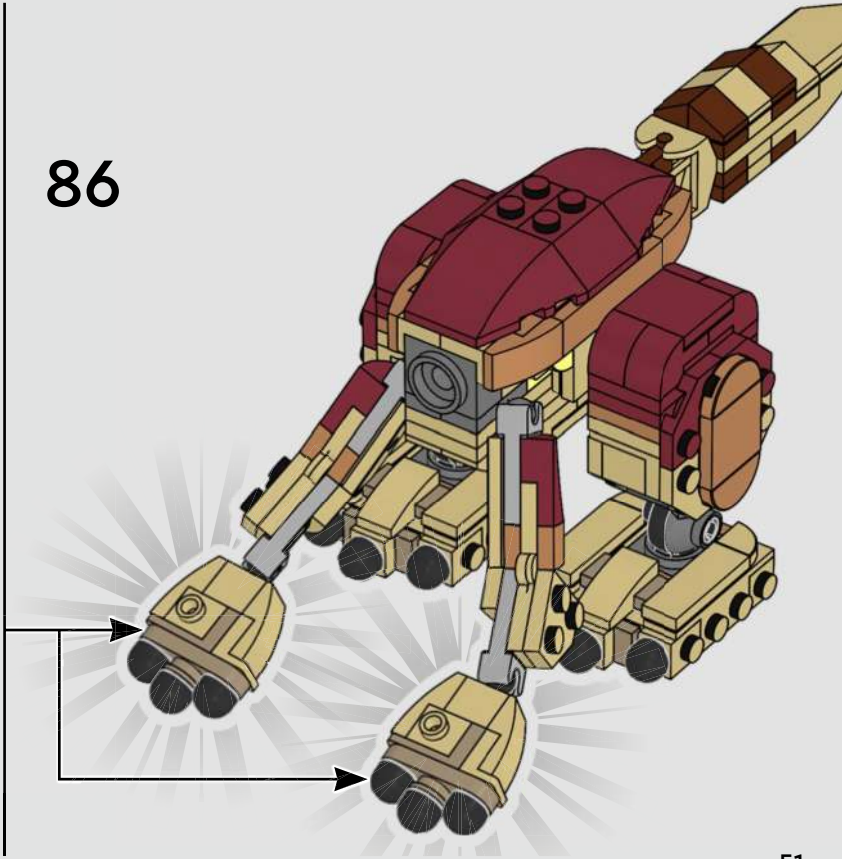

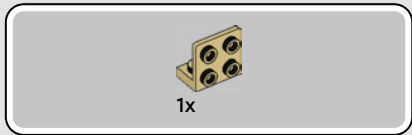
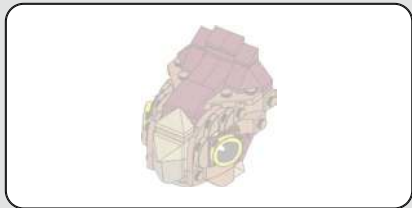

87

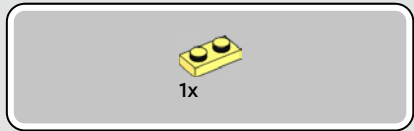

88





1x

89



1x



1x

90

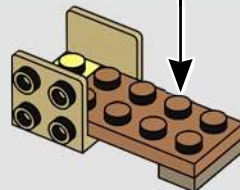
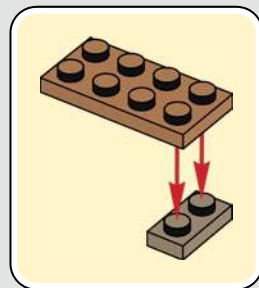

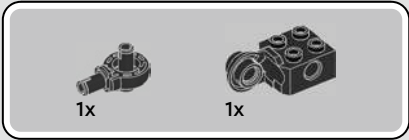

91

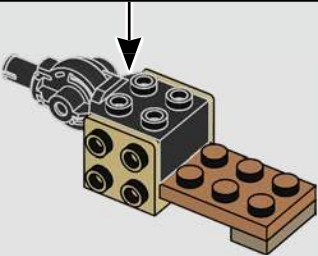
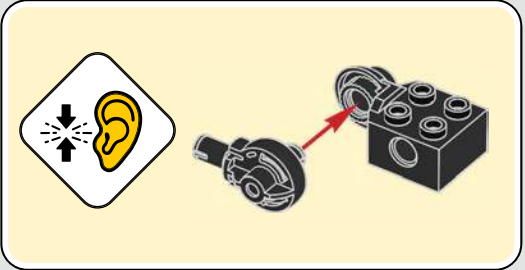

92

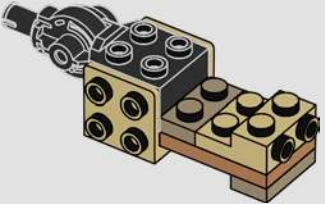



1x

93

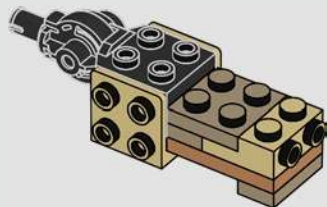

2x

94

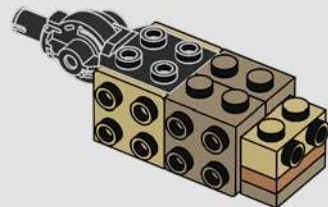



1x

95

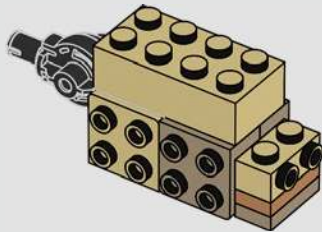

1x



1x

96

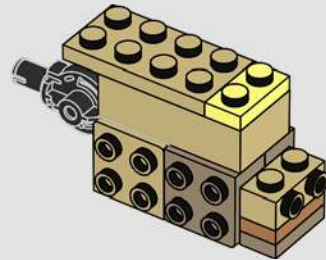



2x



2x

97

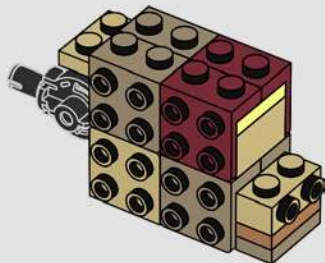

1x

98

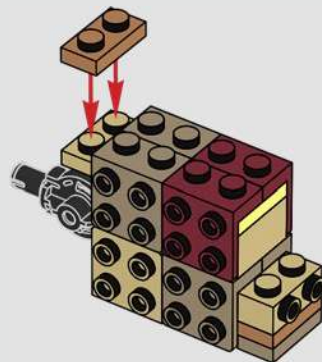



1x



1x

99

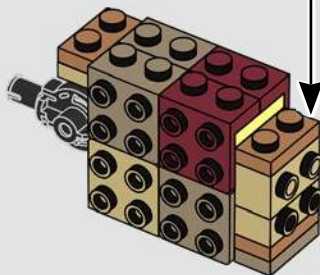
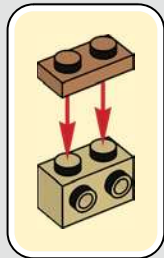

1x



1x

100

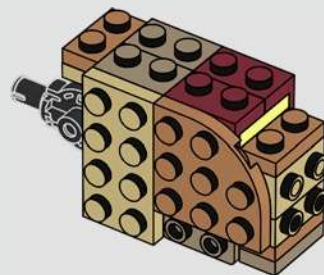



1x



1x

101

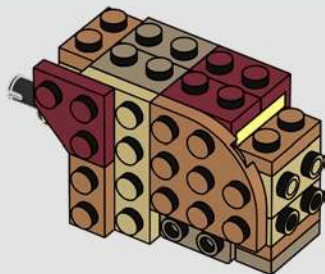

1x



1x



1x

102

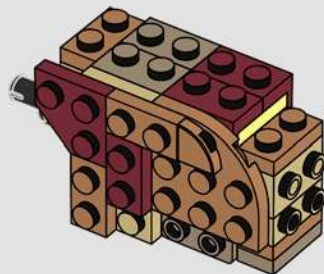



1x



1x



1x

103

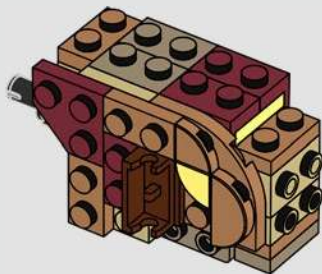

1x

104

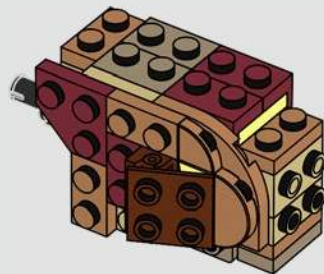



1x

105

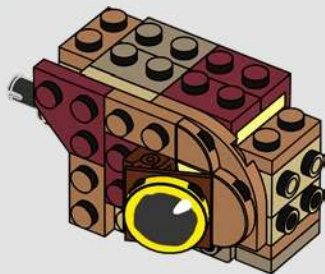

1x

106

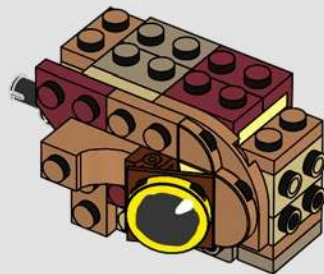



107

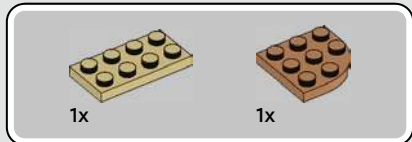
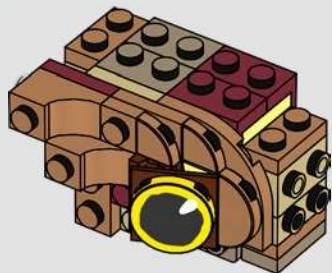

108

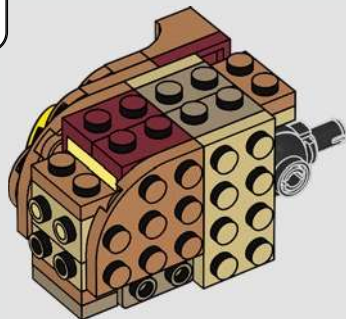



1x



1x

109

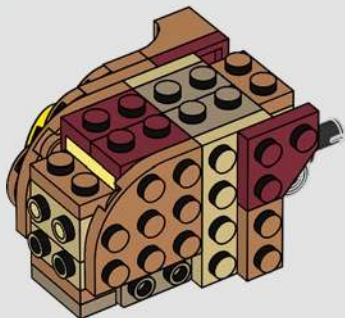

1x



1x



1x

110

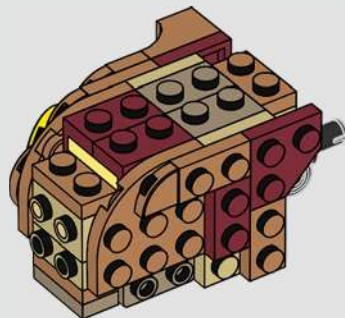



1x



1x



1x

111

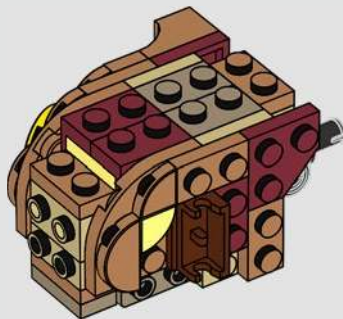

1x

112

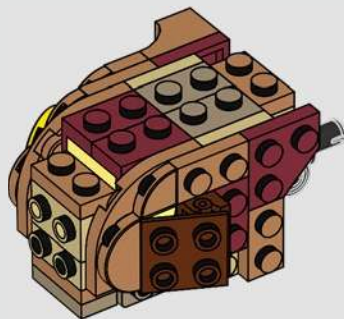



1x

113

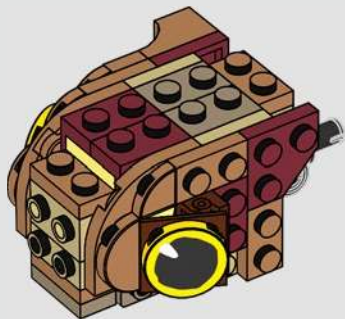

1x

114

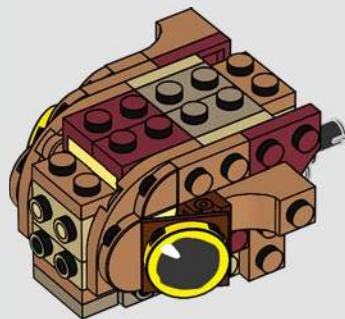



1x



1x



1x

115

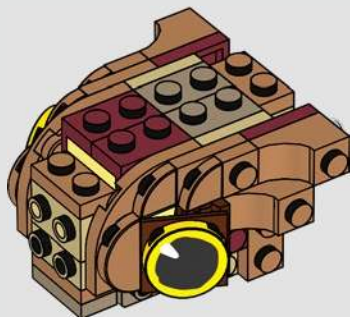



1x



1x

116

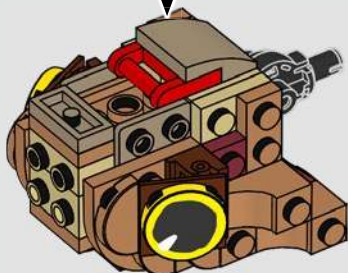
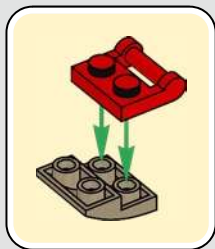
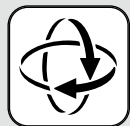

1x



1x

117

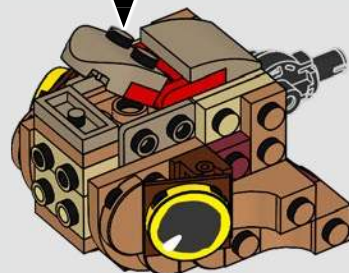
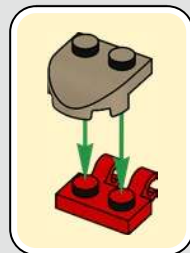



1x

118

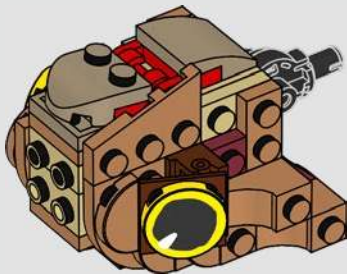

1x

119

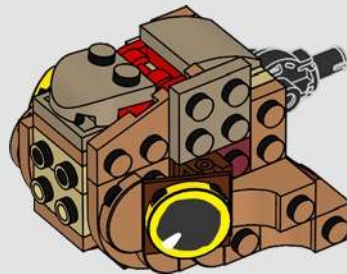



1x

122

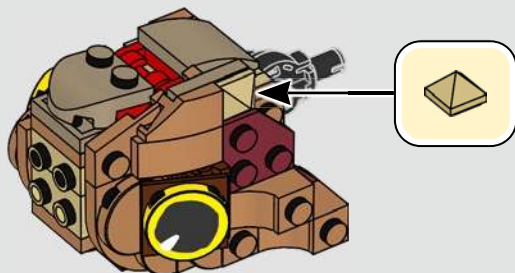

1x

123

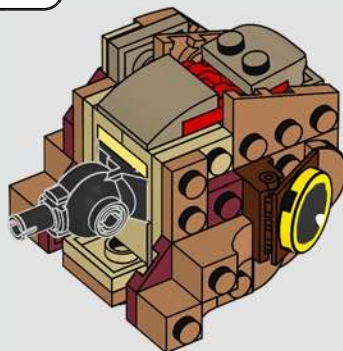



1x

124

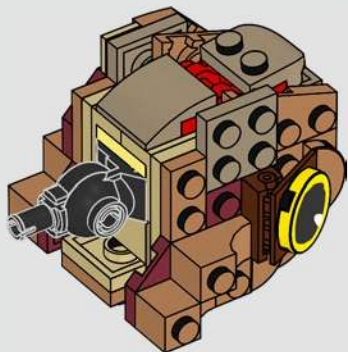

1x

125

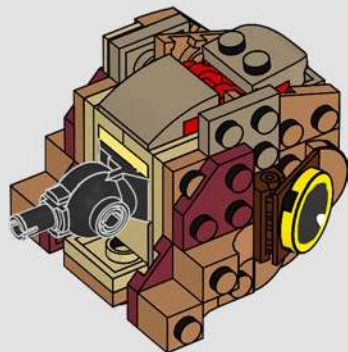



1x



1x

126

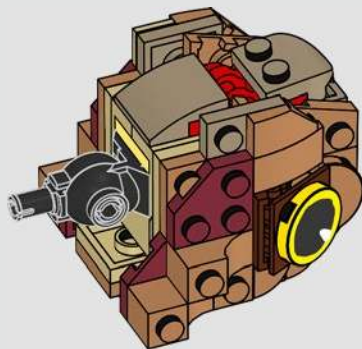



1x

127

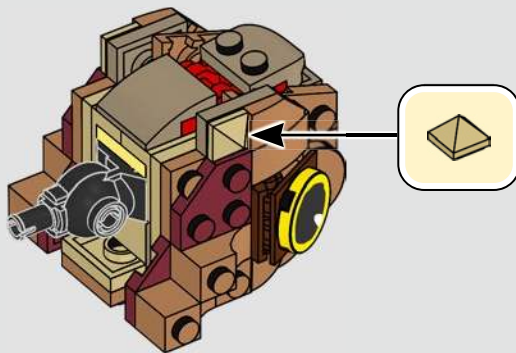

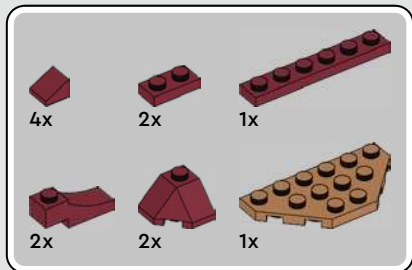

128

1

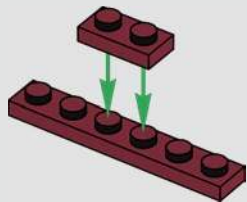

2

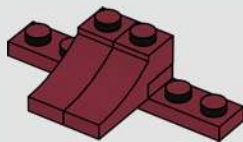

3

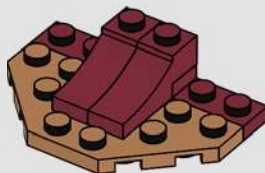

4

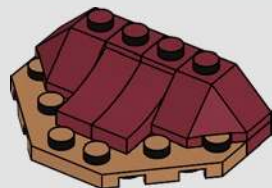

5



6

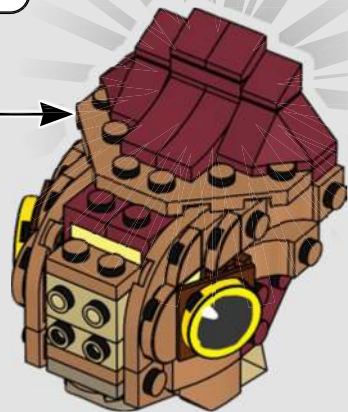
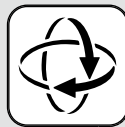



1x

129



2x

130

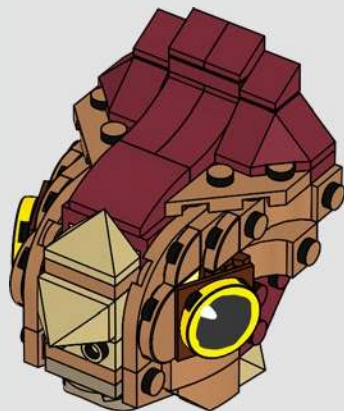

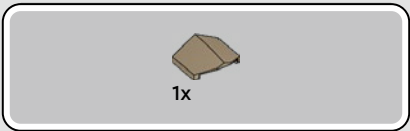

131

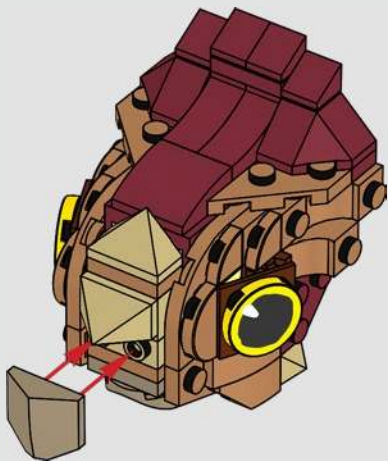

132

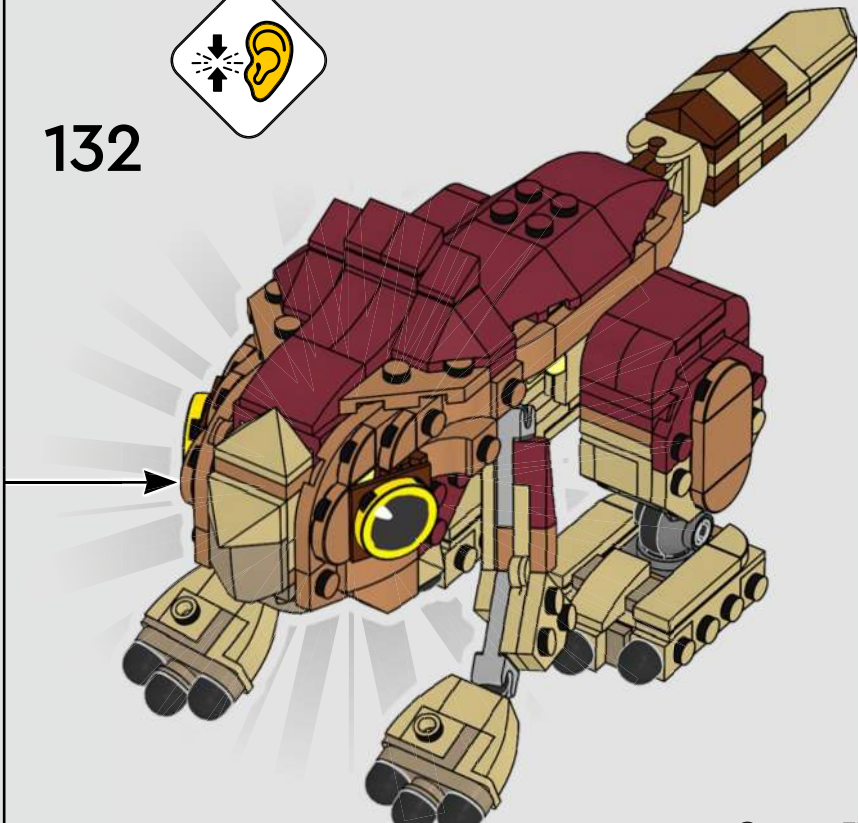



1x

133

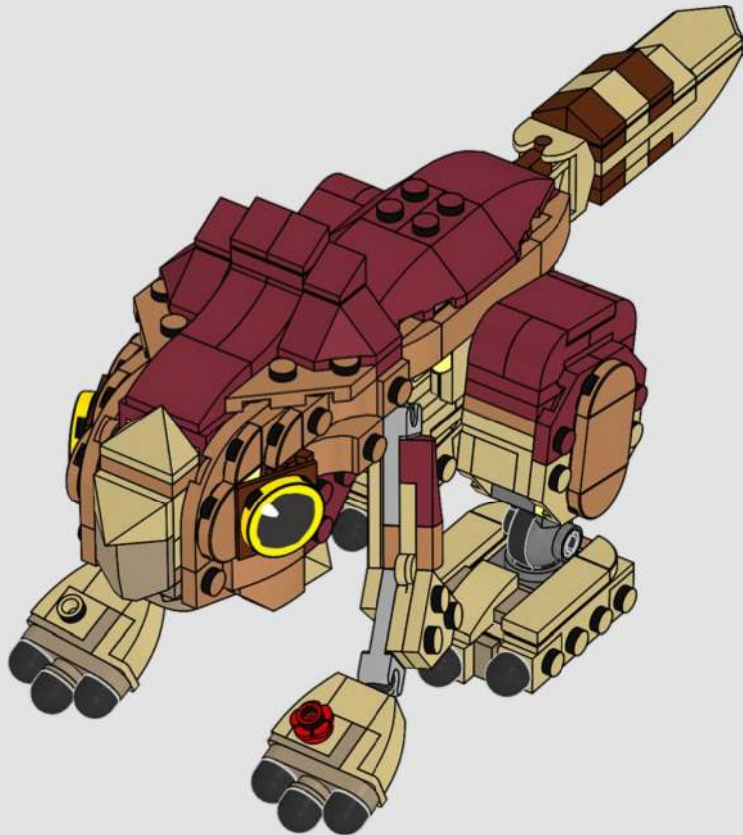







2x
6249125



16x
6374192



2x
6410762



2x
6174925



6x
4114309



4x
6145570



4x
6357613



2x
6312460



6x
6117975



6x
6273851



6x
4159553



4x
6251252



4x
4114026



2x
6249809



4x
6318084



5x
4516055



4x
6046922



3x
4113917



1x
6013081



1x
4114319



2x
4213568



1x
6478176



1x
6469454



1x
6013081



1x
6485750



2x
4179771



1x
6024495



10x
6236914



4x
4118790



4x
4113915



4x
6131896



1x
6245271



2x
6416525



1x
4113988

				
3x 6206148	12x 6560654	2x 6300322	4x 4531415	2x 6337786
				
3x 302321	2x 6344752	2x 6530972	4x 6384234	2x 6267486
				
1x 6360036	2x 6138173	4x 6092591	14x 4539097	2x 6426640
		2x 4528604		
1x 4226876	3x 4213374	1x 6564886	2x 4539105	2x 4609925
				
2x 6523604	1x 6302828	1x 6356427	8x 6560653	2x 6175314
		1x 6564888		
3x 6182261	4x 6228969	2x 6449564	1x 6544518	1x 4539062
				
4x 6448793	8x 6201647	3x 6047415	1x 6545155	4x 6248536
		4x 6275485		
4x 6043639	1x 403228		8x 6210310	6x 6215606
				
4x 4211445	2x 6268814		1x 6107758	6x 6510072



10x
6218360



1x
6454169



1x
6454171



8x
6356566



2x
6474266



4x
6499713



2x
6102990



2x
6102998



3x
6093494



1x
6417962



1x
6417963



2x
6252194



1x
6564882



4x
6295464



1x
4216581



1x
4225469



4x
4504376



5x
4211150



2x
6186045



2x
6167644



1x
6560656



2x
6472887



2x
6039479



5x
6398662



2x
6279898



 LEGO.com/service

YOU COULD
WIN



Scan this QR code or go to
LEGO.COM/PRODUCTFEEDBACK and give us
your short feedback about this LEGO® set
for a chance to win a cool LEGO prize.

Terms and Conditions apply*



EN: YOU COULD WIN. Terms and Conditions apply* **DE: Du könntest GEWINNEN.** Es gelten die Teilnahmebedingungen* **FR: Tu pourrais GAGNER.** Des conditions s'appliquent* **IT: Potresti VINCERE tu.** Termini e condizioni sono applicabili* **ES: Puedes GANAR.** Aplican términos y condiciones* **PT: PODERÁ GANHAR.** Aplicam-se Termos e Condições* **ZH: 轻松获奖.** 条款和条件适用* **PL: Szansa na WYGRANĄ.** Obowiązuje regulamin* **CS: Máte šanci VYHRÁT.** Platí všeobecné smluvní podmínky* **SK: Máte šancu VYHRAŤ.** Platia všeobecné zmluvné podmienky* **HU: TE IS NYERHETSZ.** Felhasználási feltételek érvényesek* **UA: ВИ МОЖЕТЕ ВИГРАТИ.** Застосовуються загальні положення та умови* **RO: Ai putea CÂȘTIGA.** Se aplică termeni și condiții* **BG: Можете да СПЕЧЕЛИТЕ.** Има определени правила и условия* **LV: Tu vari LAIMĒT.** Ir spēkā noteikumi un nosacījumi.* **ET: Sul on võimalus VÕITA.** Kehtivad tingimused* **LT: Jūs galite LAIMĖTI.** Taikomos sąlygos*

*[LEGO.com/productfeedback-terms](https://www.lego.com/productfeedback-terms)

