



76973



4

5

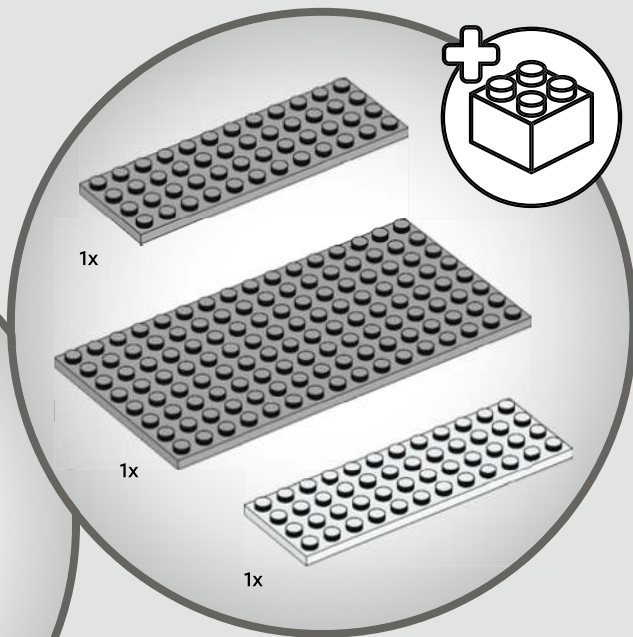
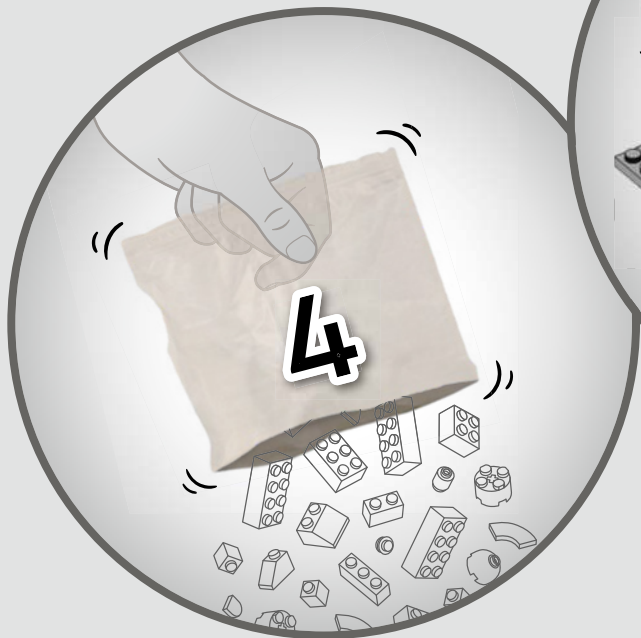

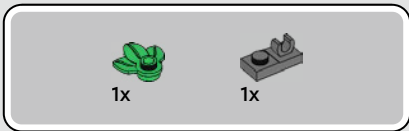

1

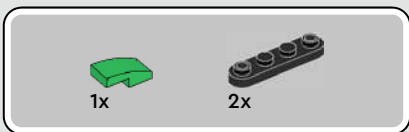
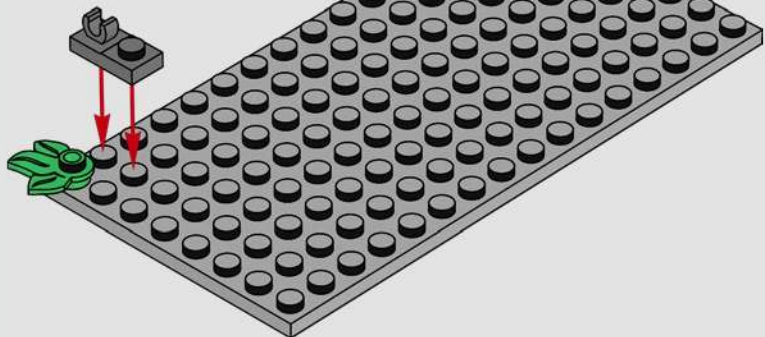

2

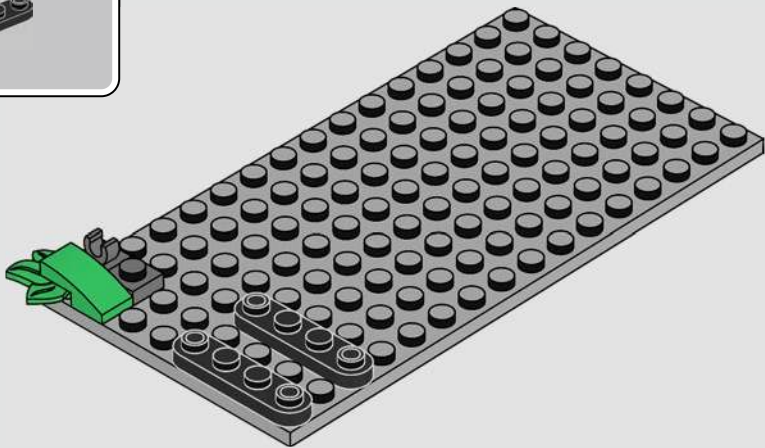

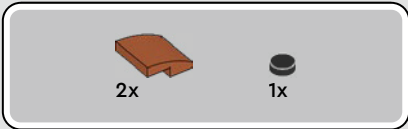

3

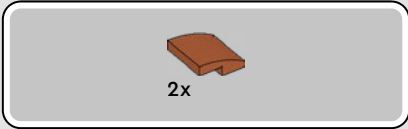
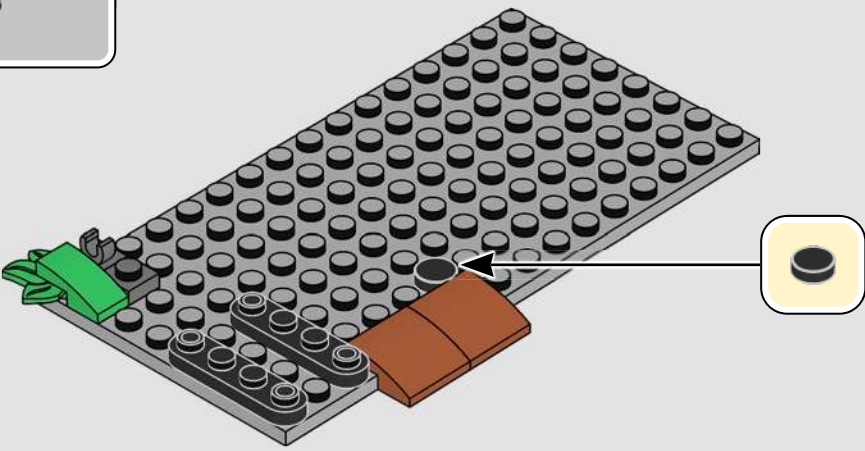

4

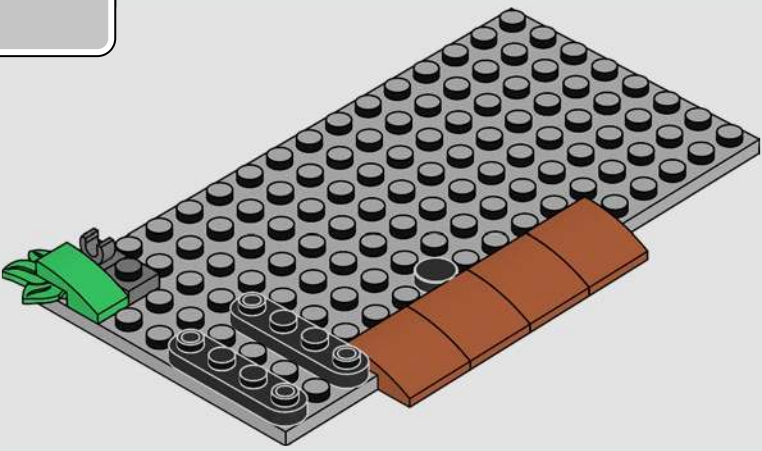



2x



1x

5

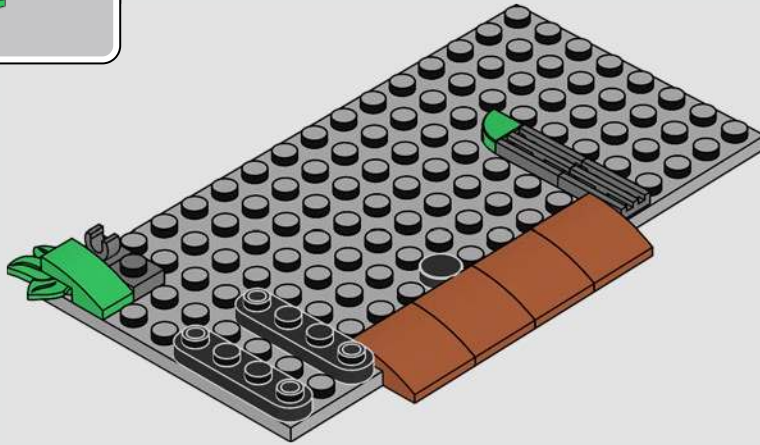

1x



1x

6

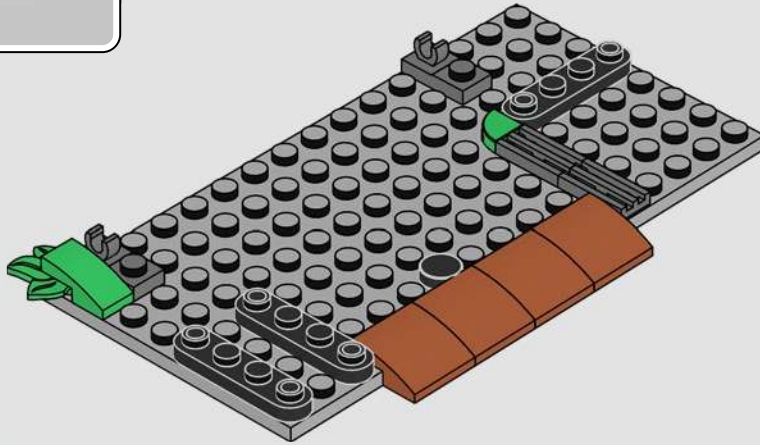



7

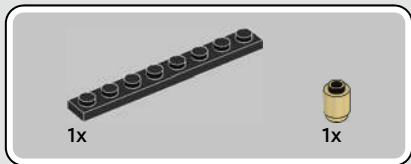
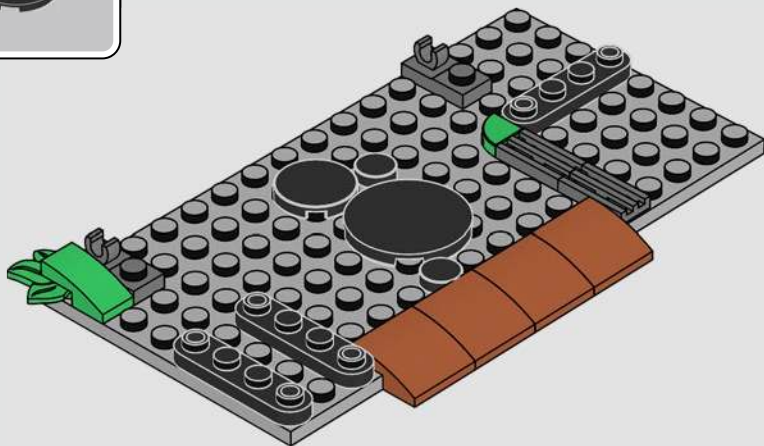

8



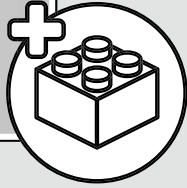
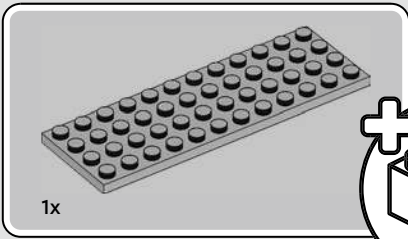

9



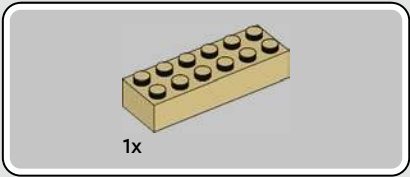

10



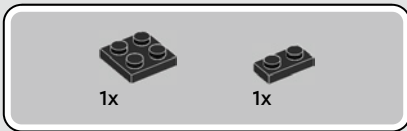

11

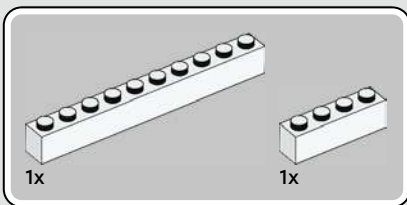
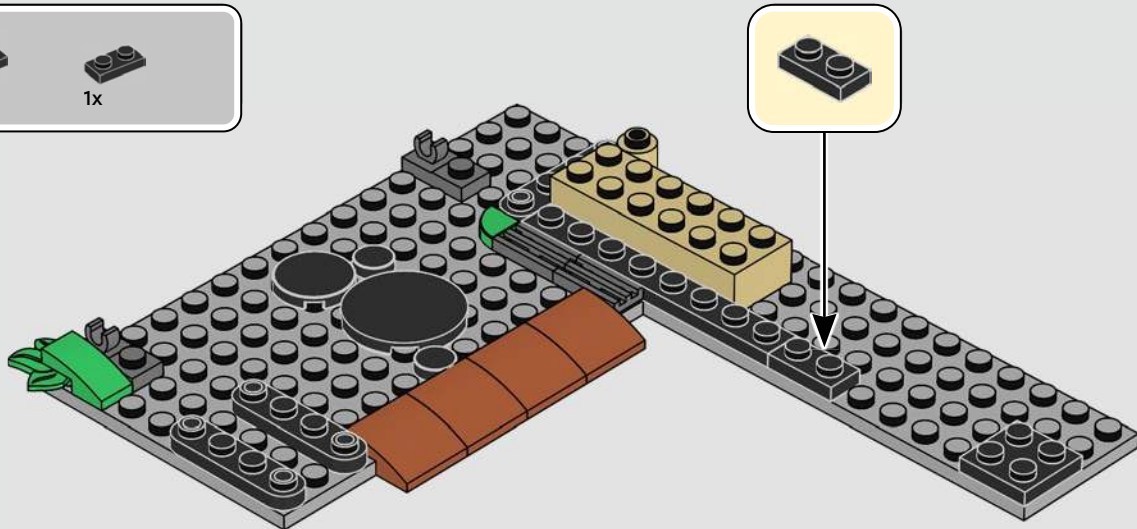

12



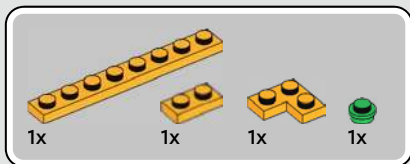

13

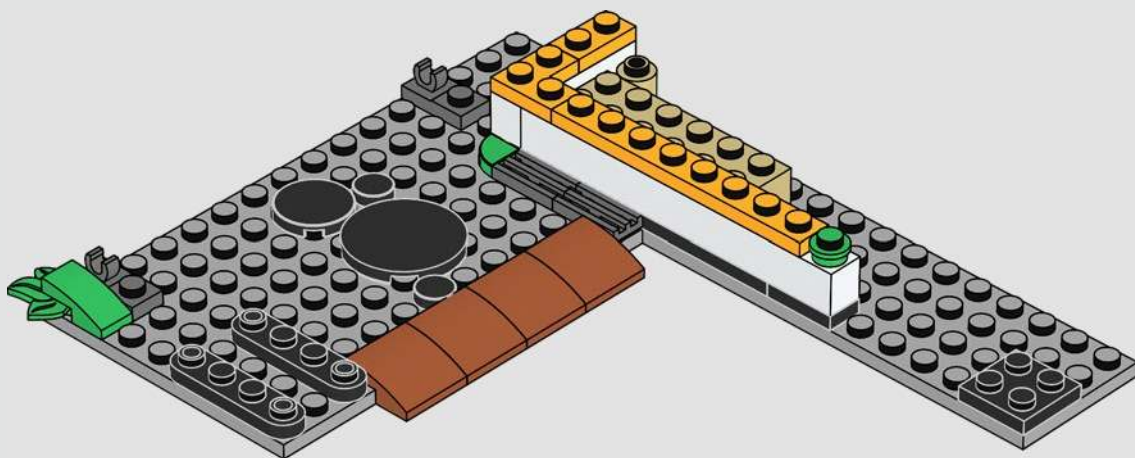

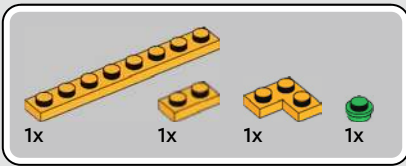

14



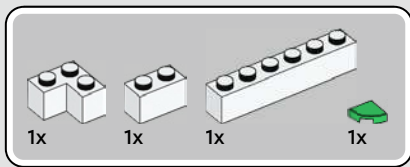

15

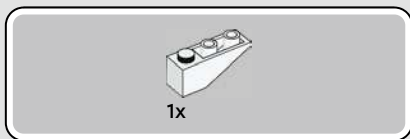
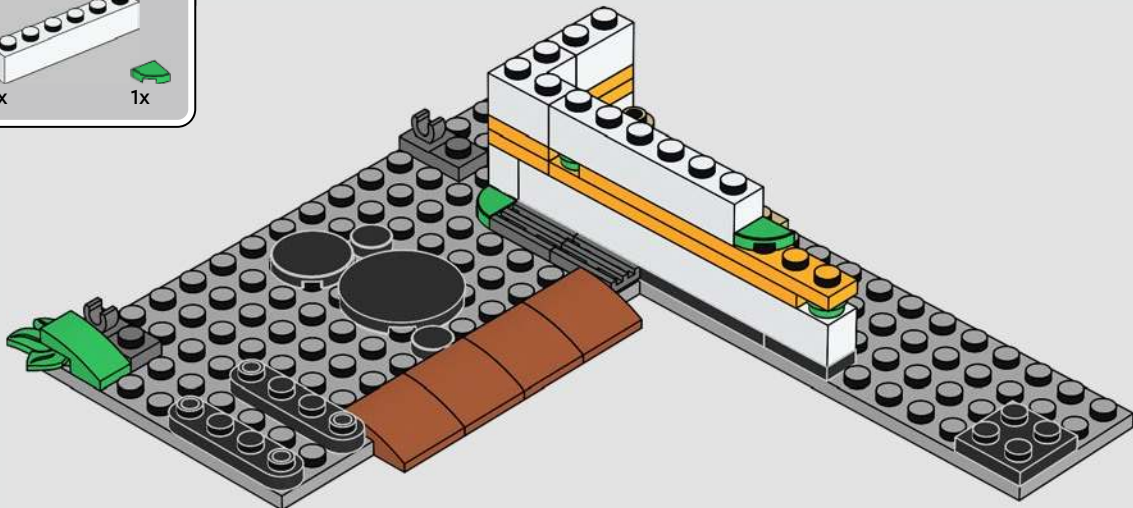

16

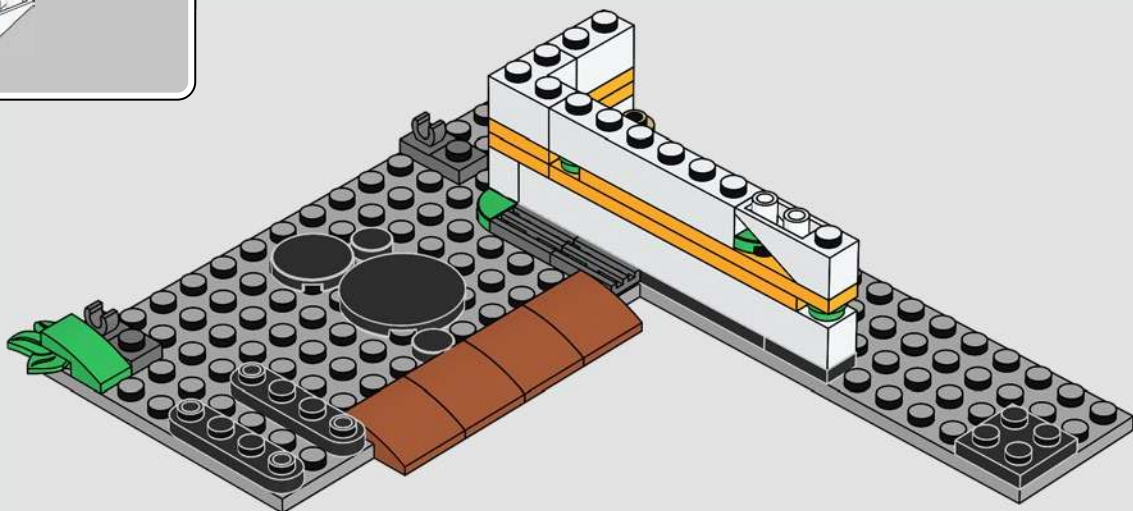

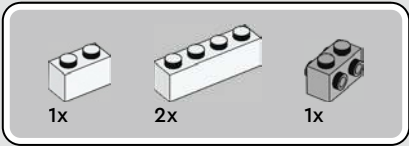

17

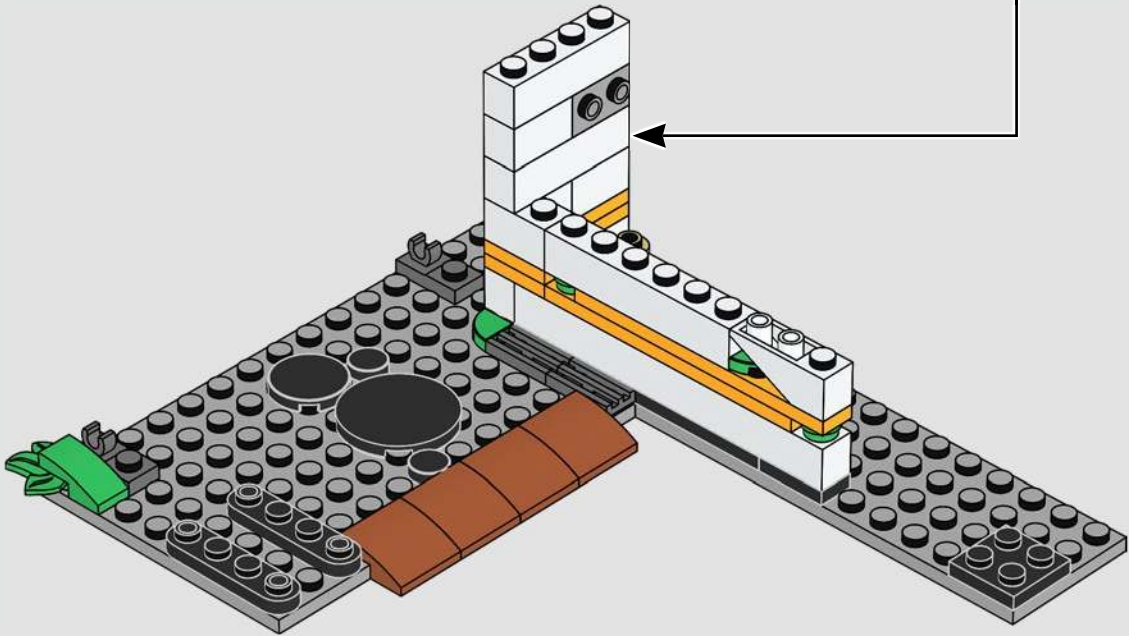
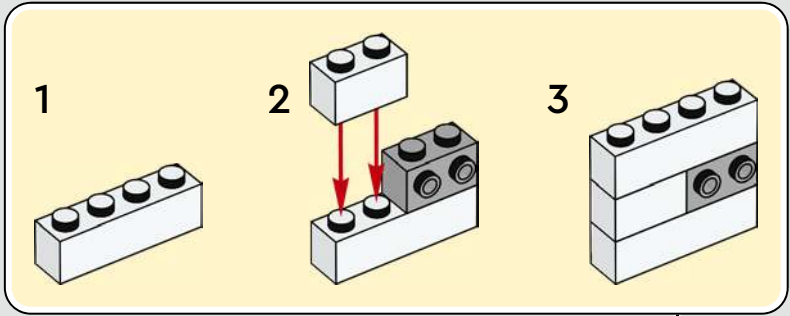

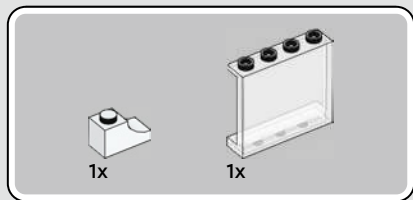

18

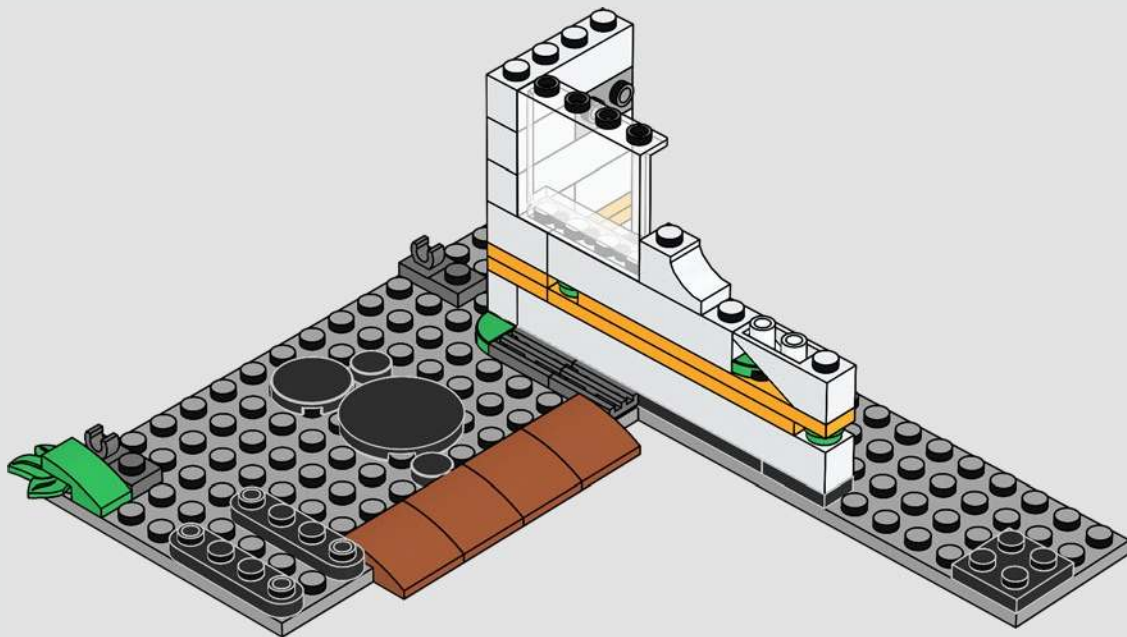

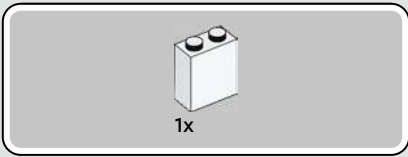

19



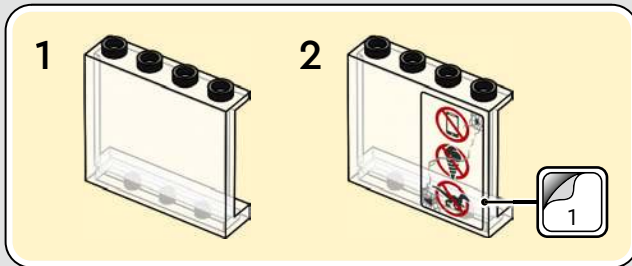
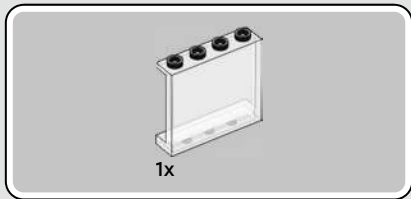

20





1x



2x

21





1x

22

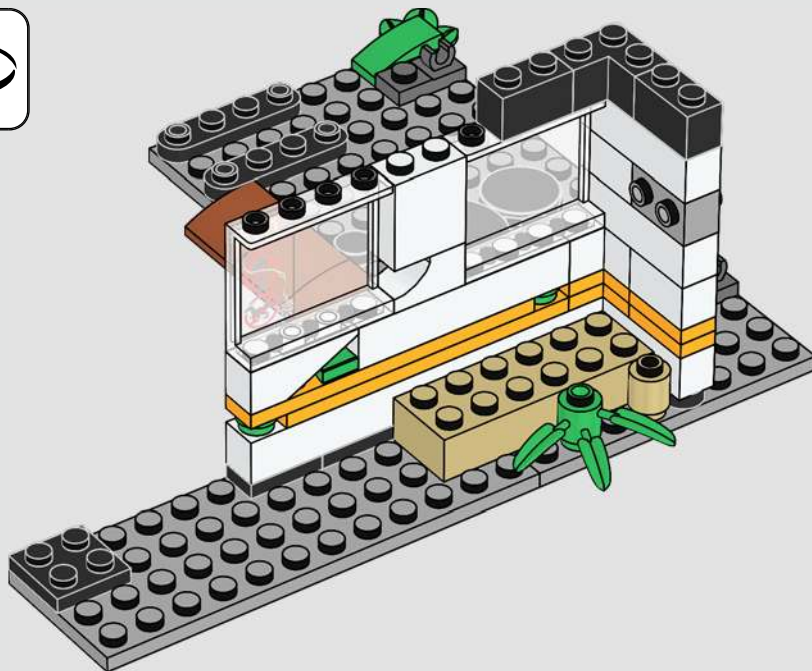
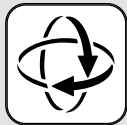

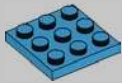

1x

23

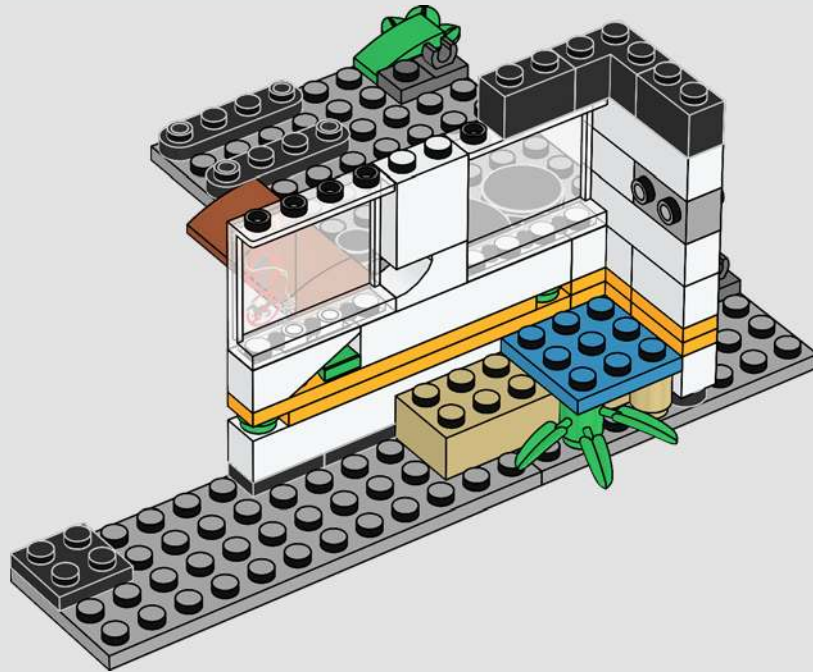

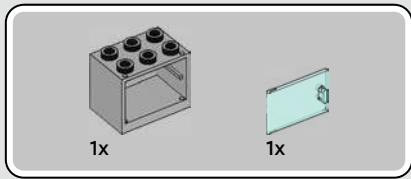

24

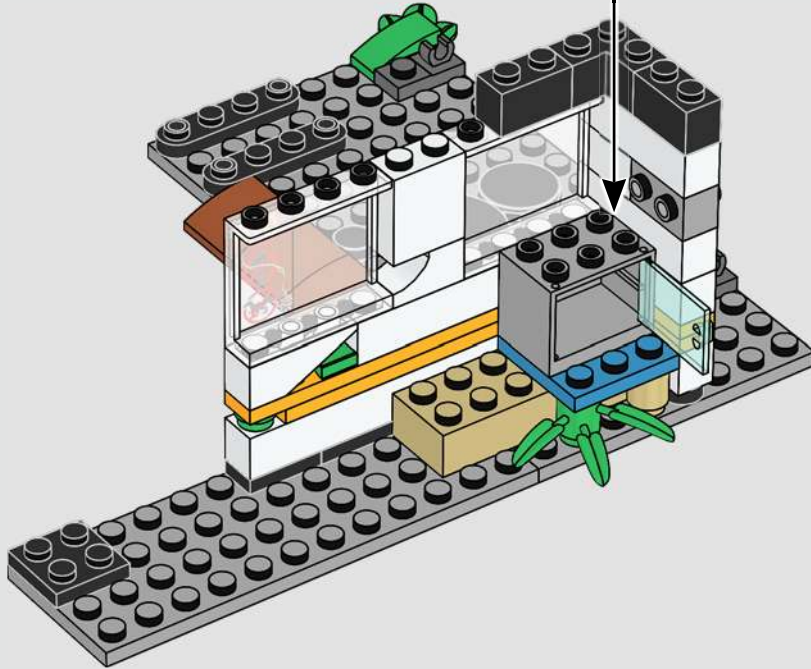
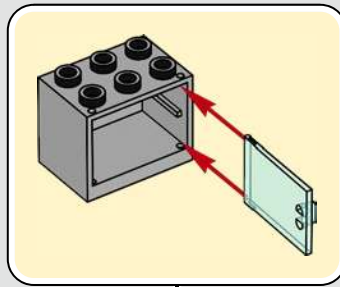



1x



1x

25

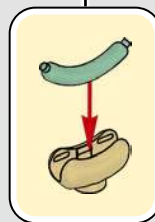
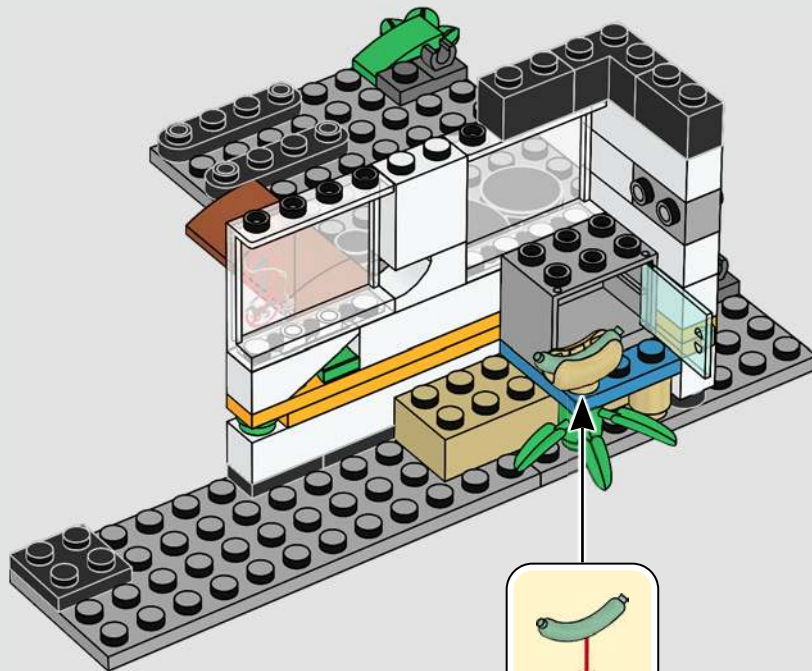

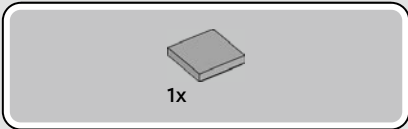

26

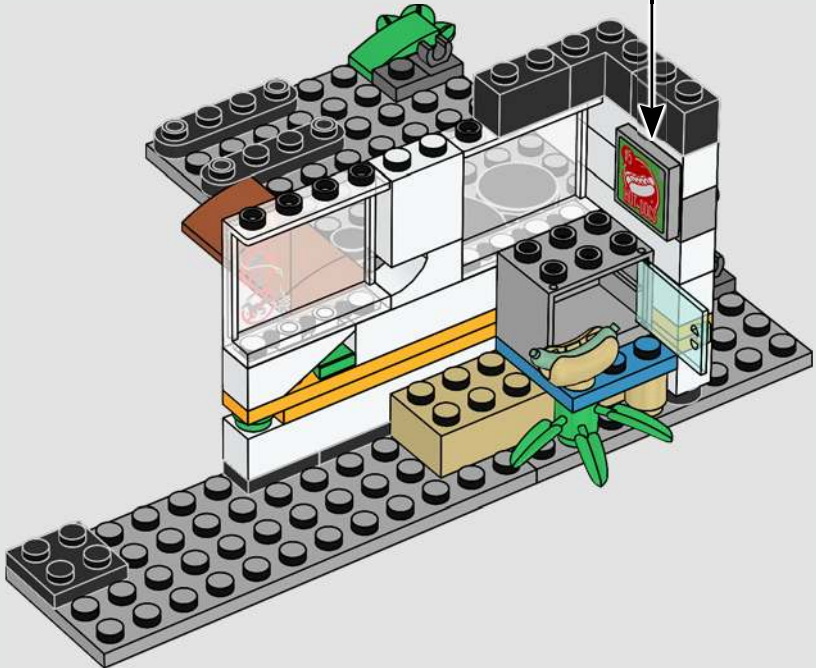
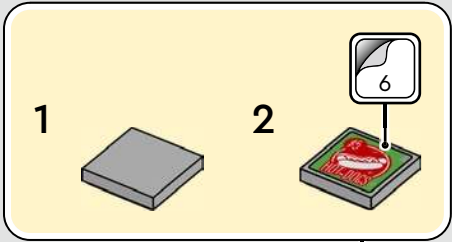



1x



2x

29

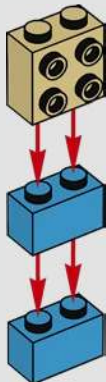

1x

30

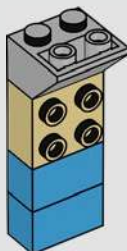

2x



1x



1x



1x

31

1



2



3

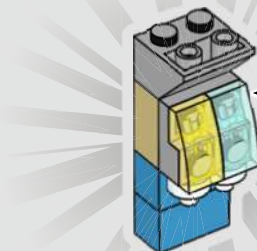

32

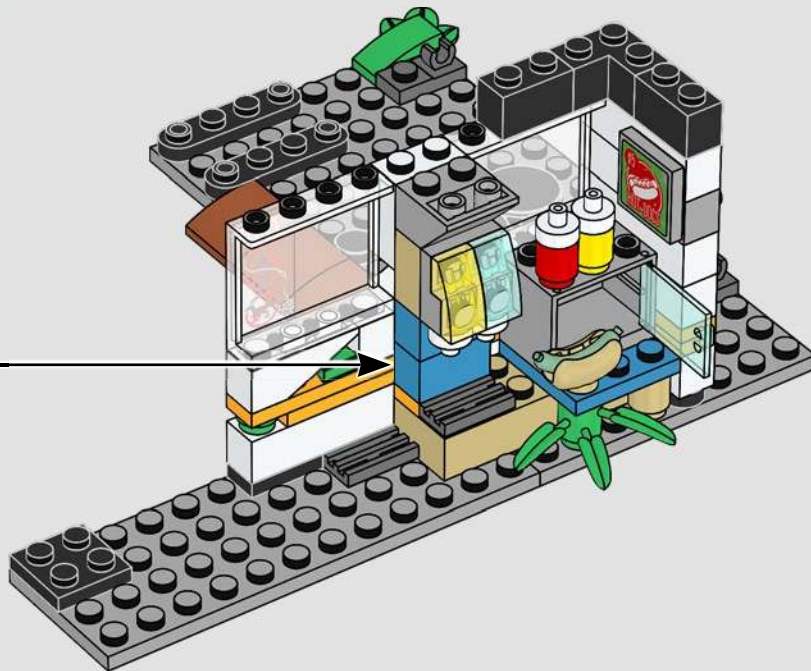



2x

33

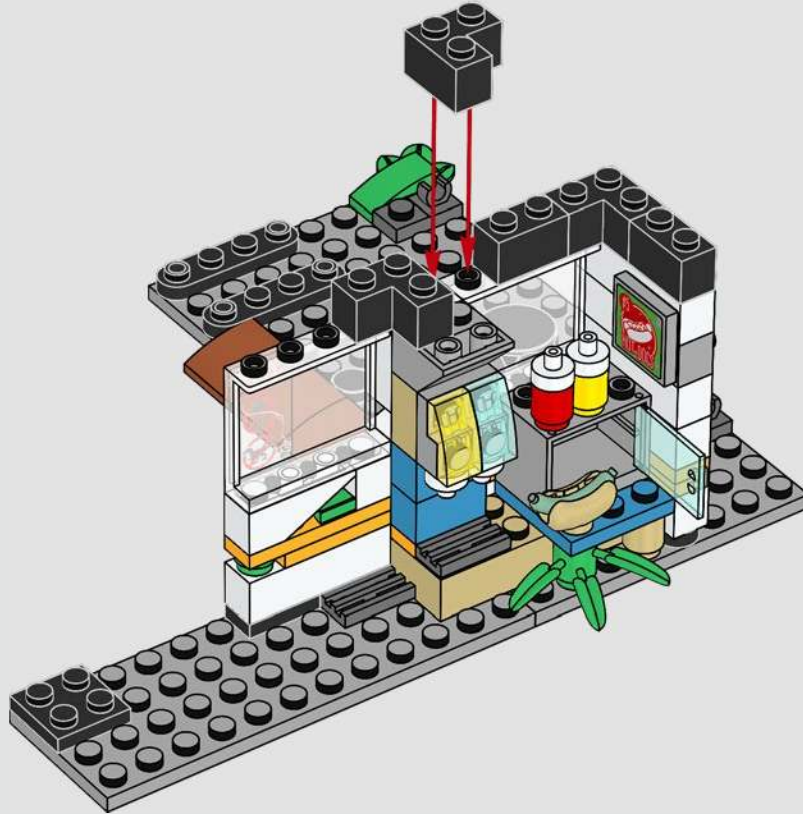



1x

34

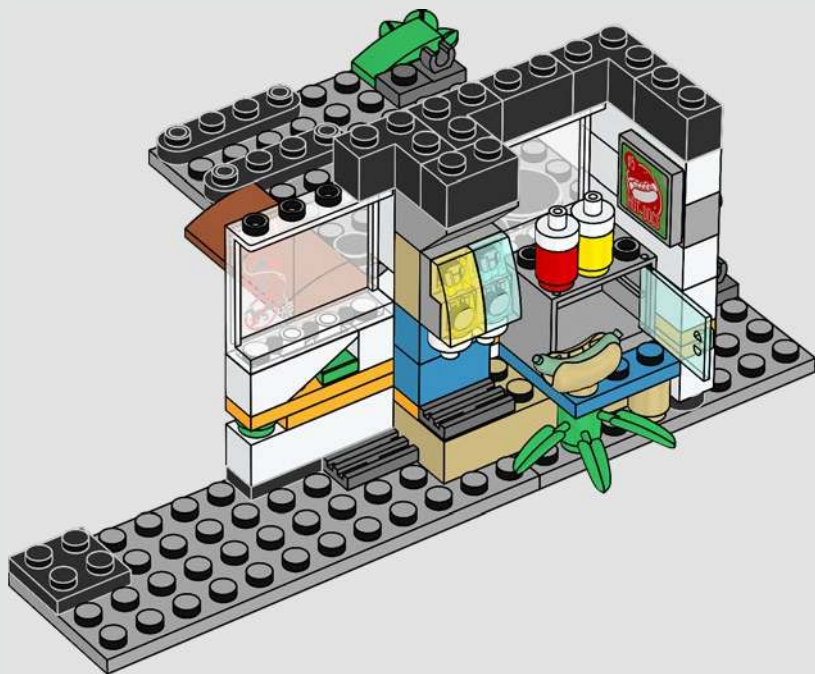



2x



2x

35



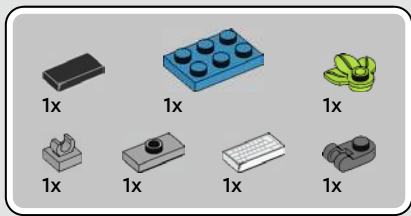

36

1



2



3



1

2



4



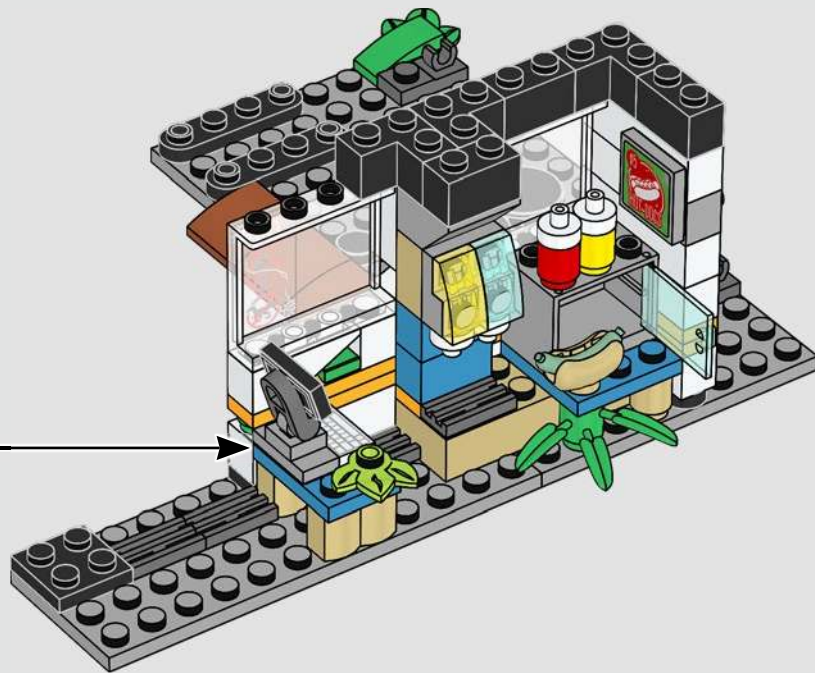



1x



1x

37

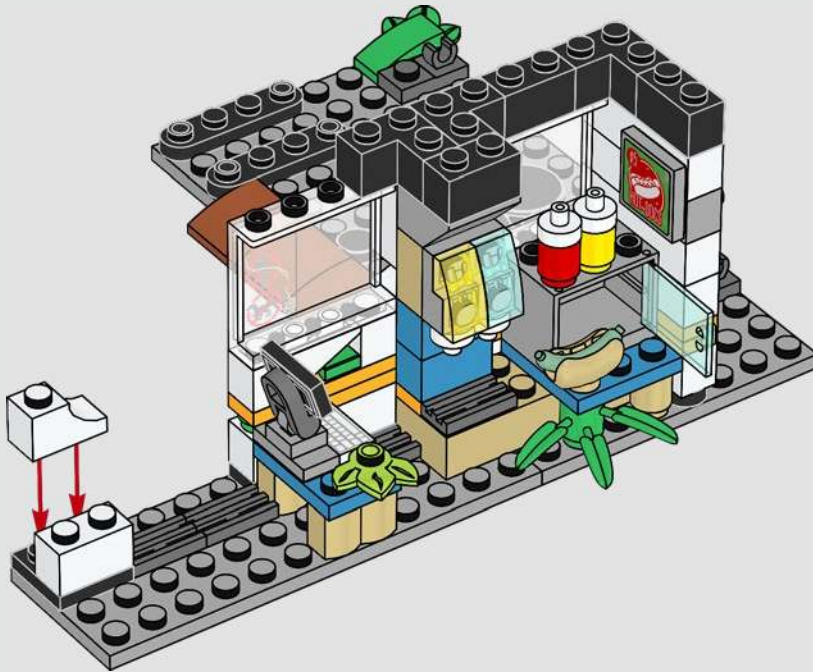



2x

38

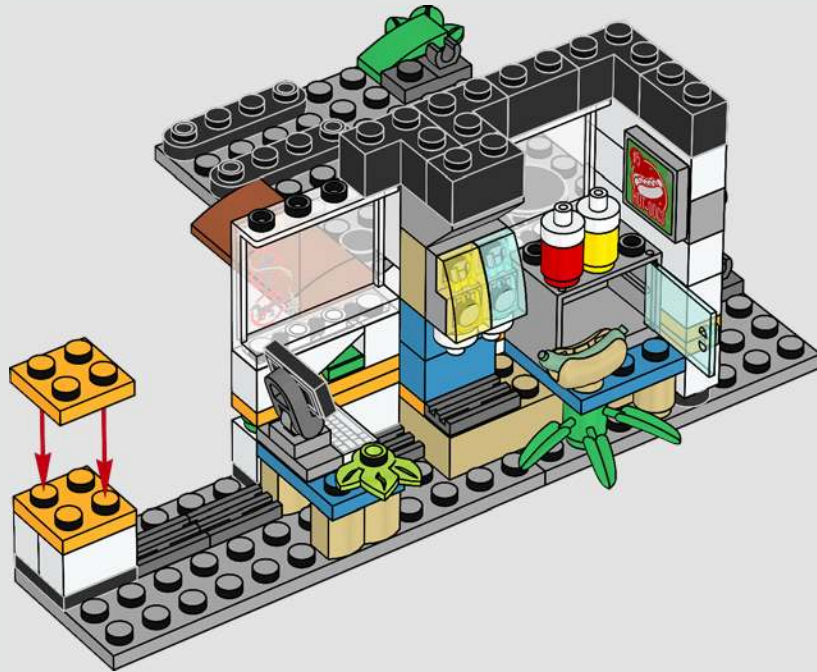

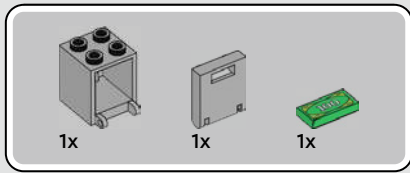

39

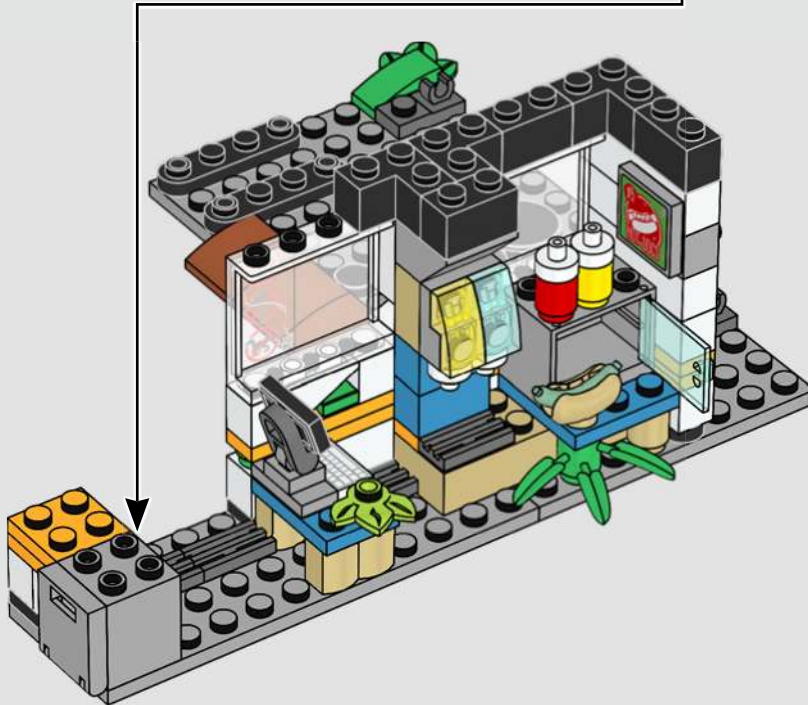
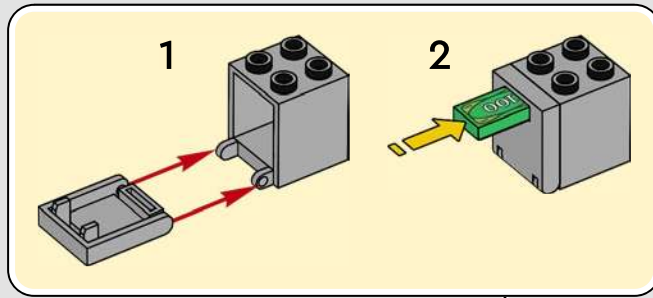

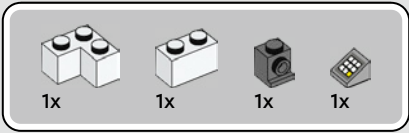

40

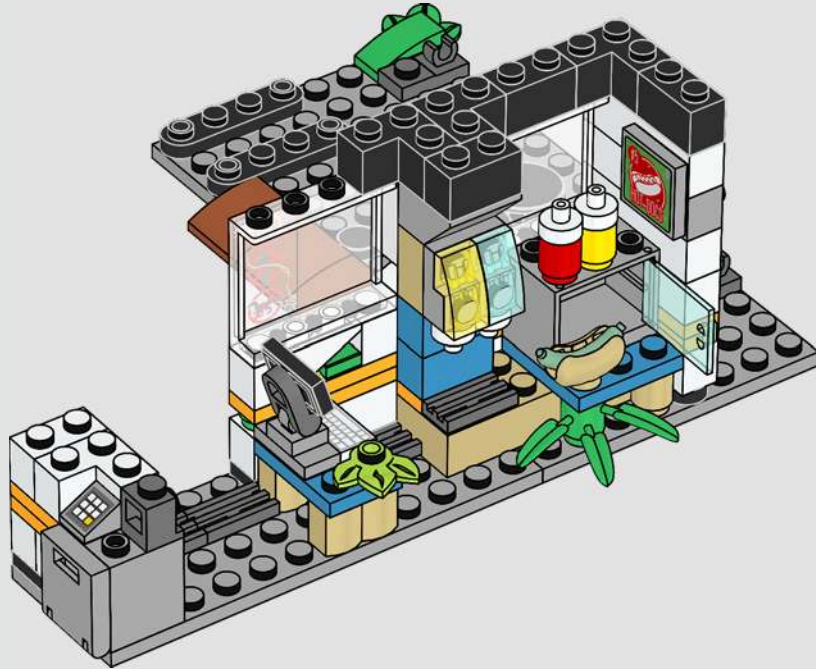

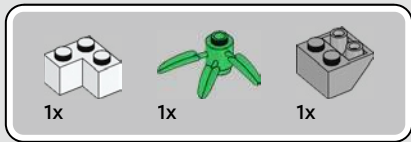

41

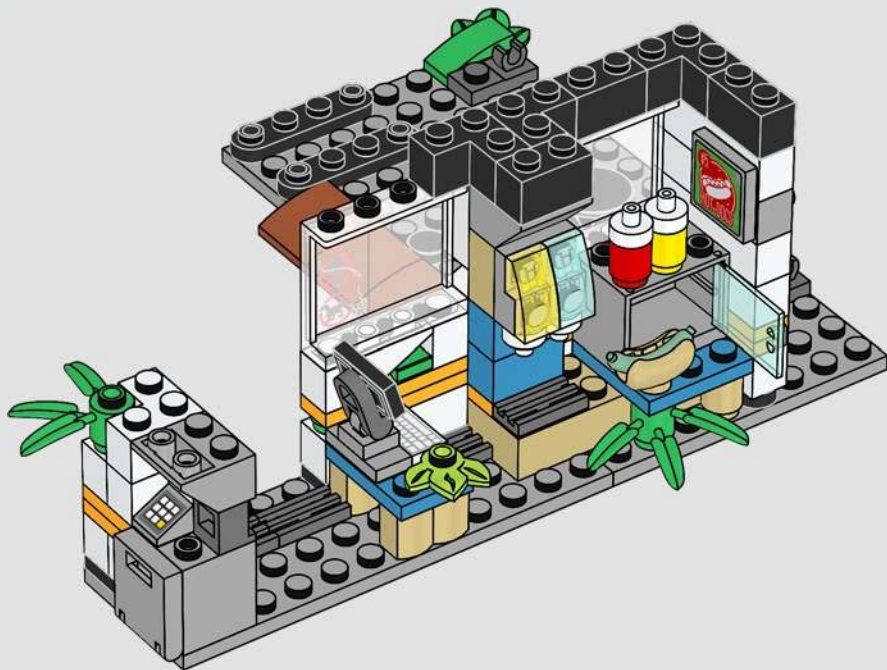

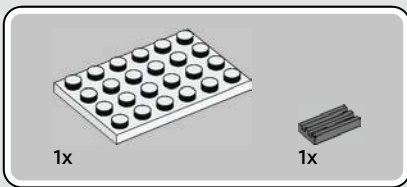

42

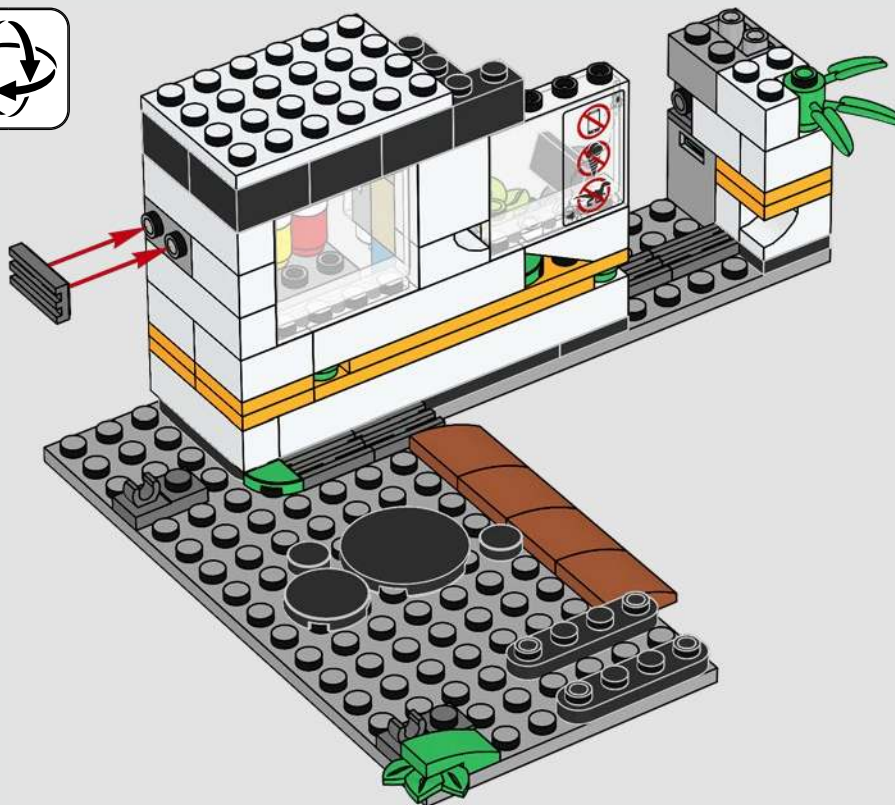
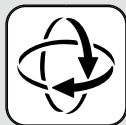

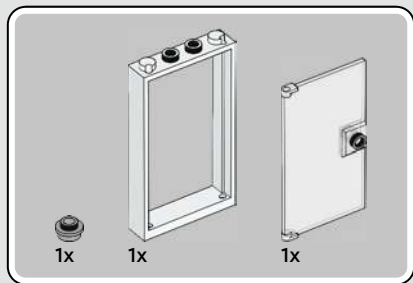

43

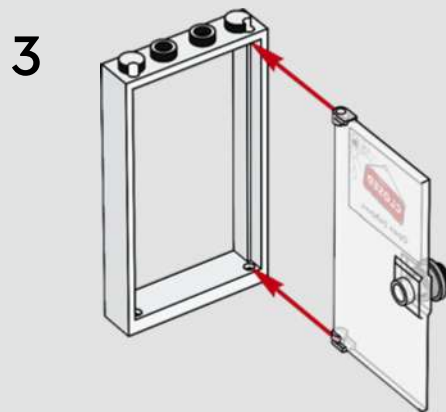
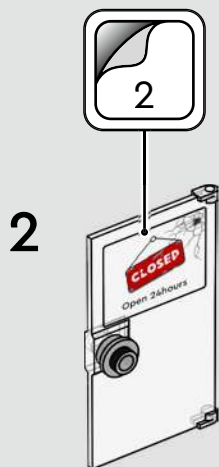
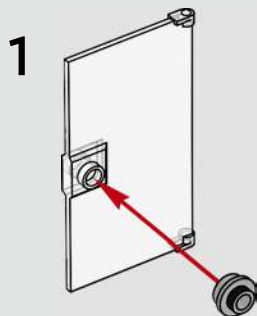

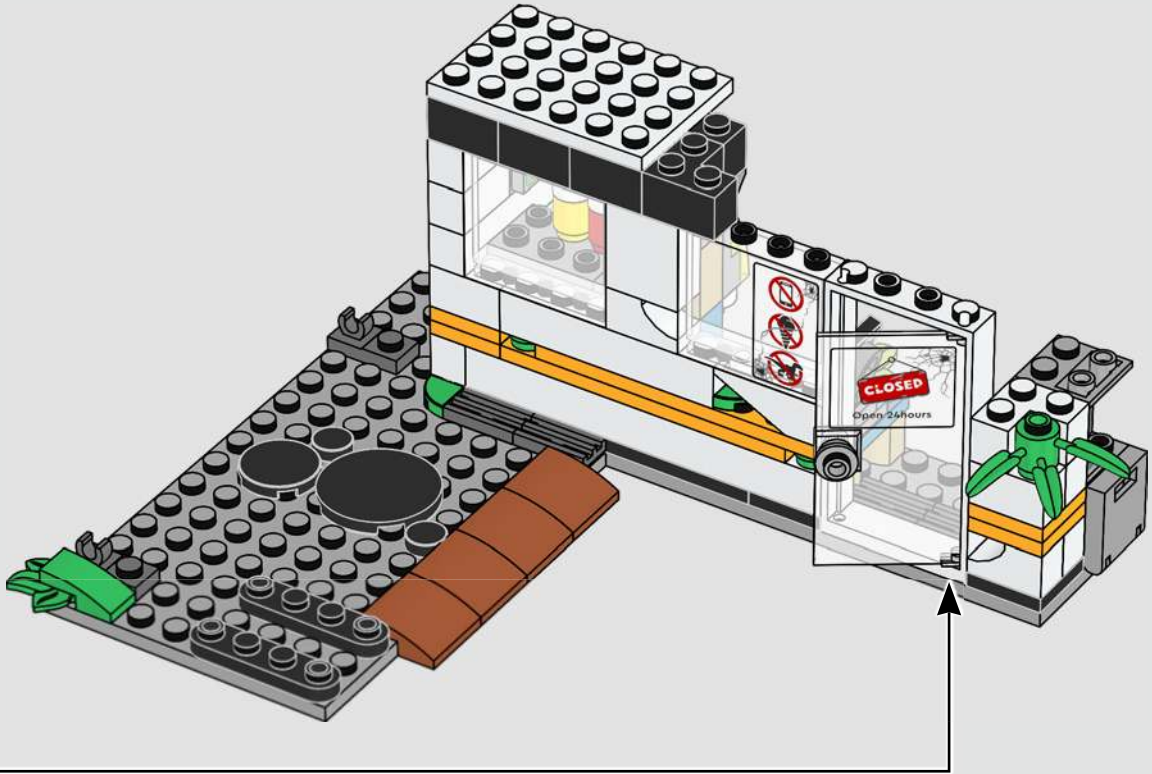



2x

44

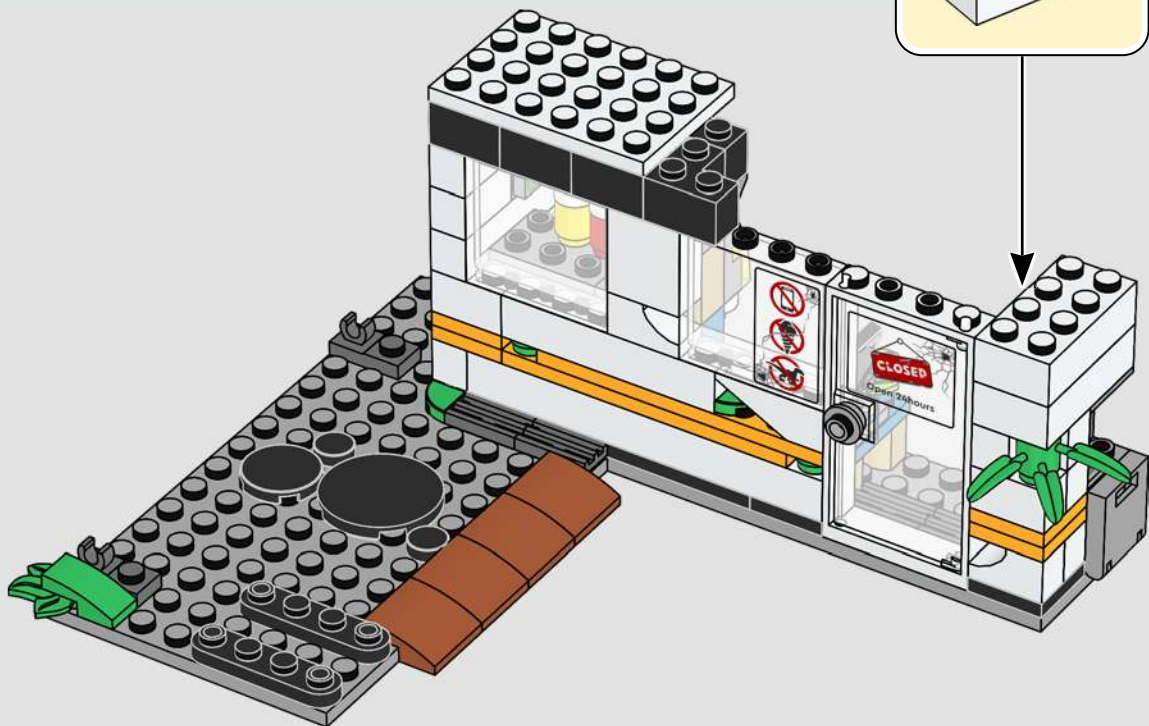
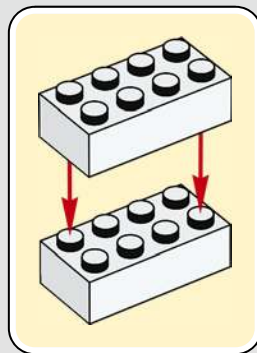

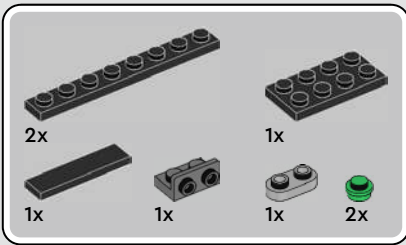

45

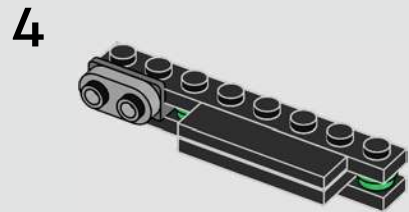
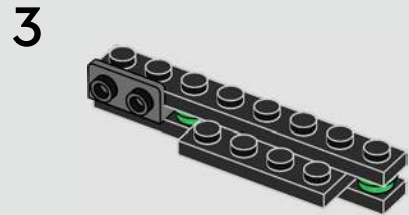
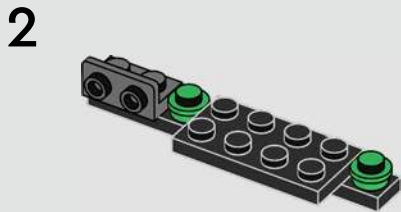
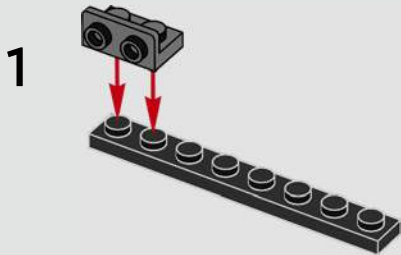





1x

46

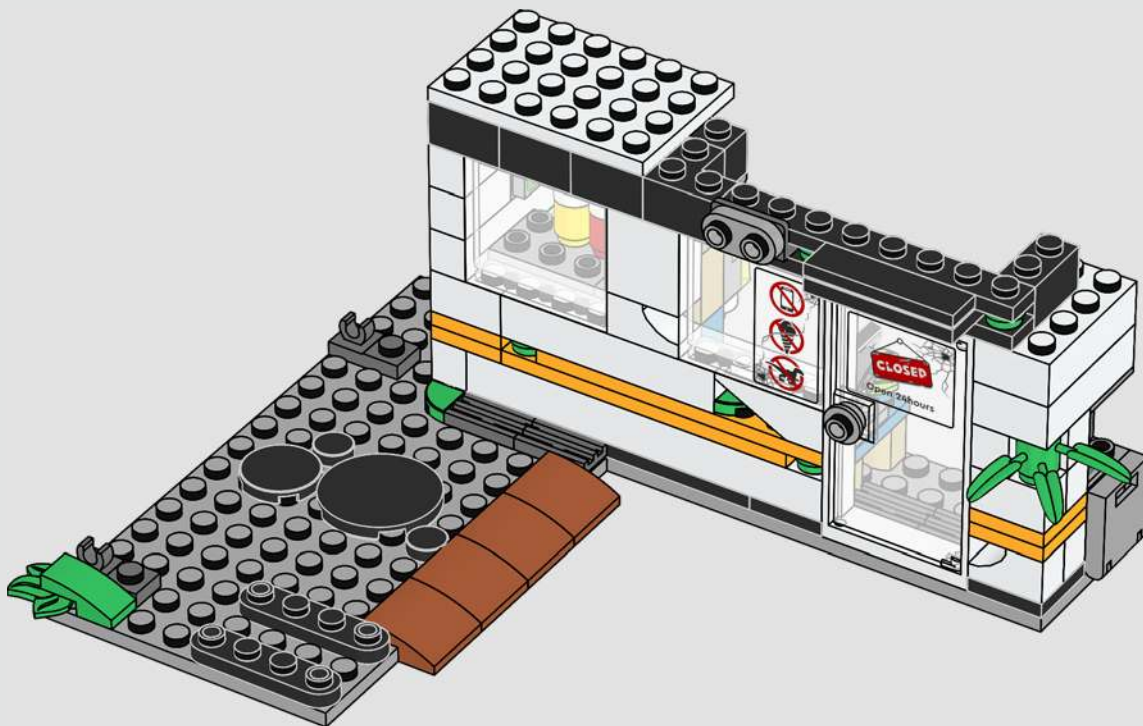



1x



2x

47



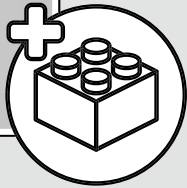
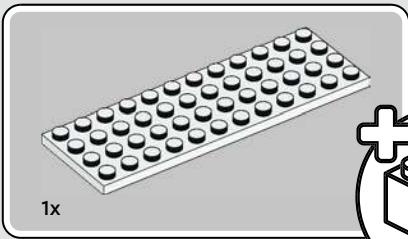

48

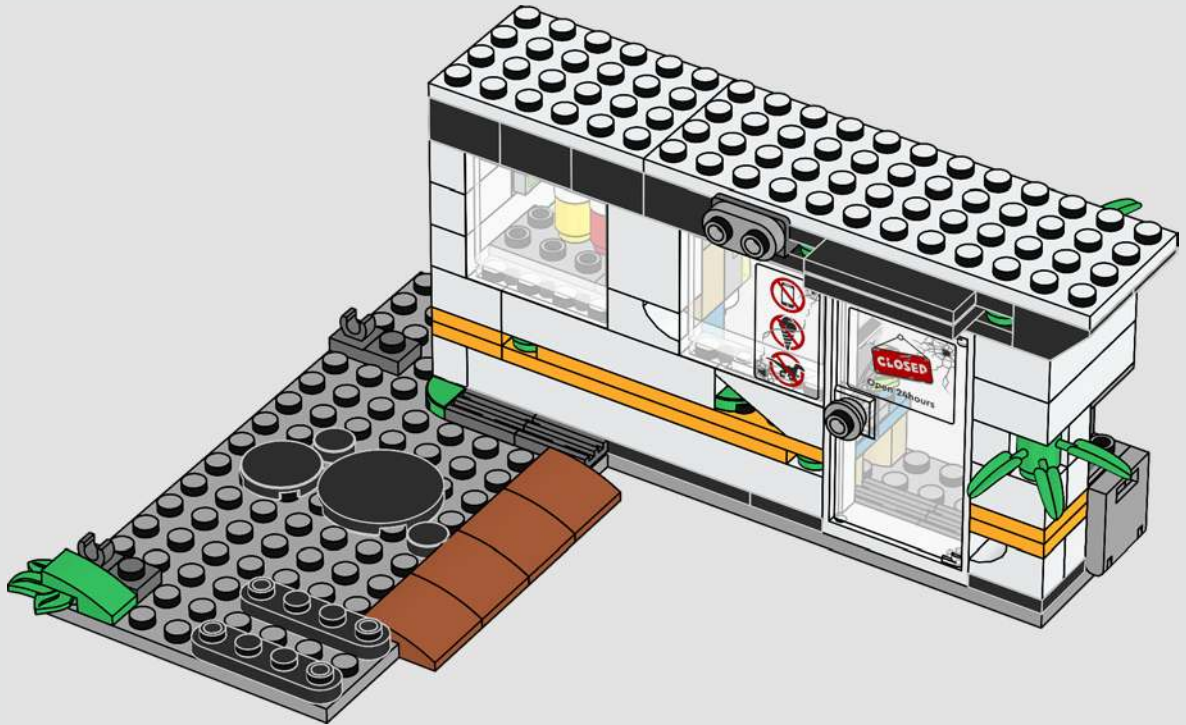



2x



2x



2x

49

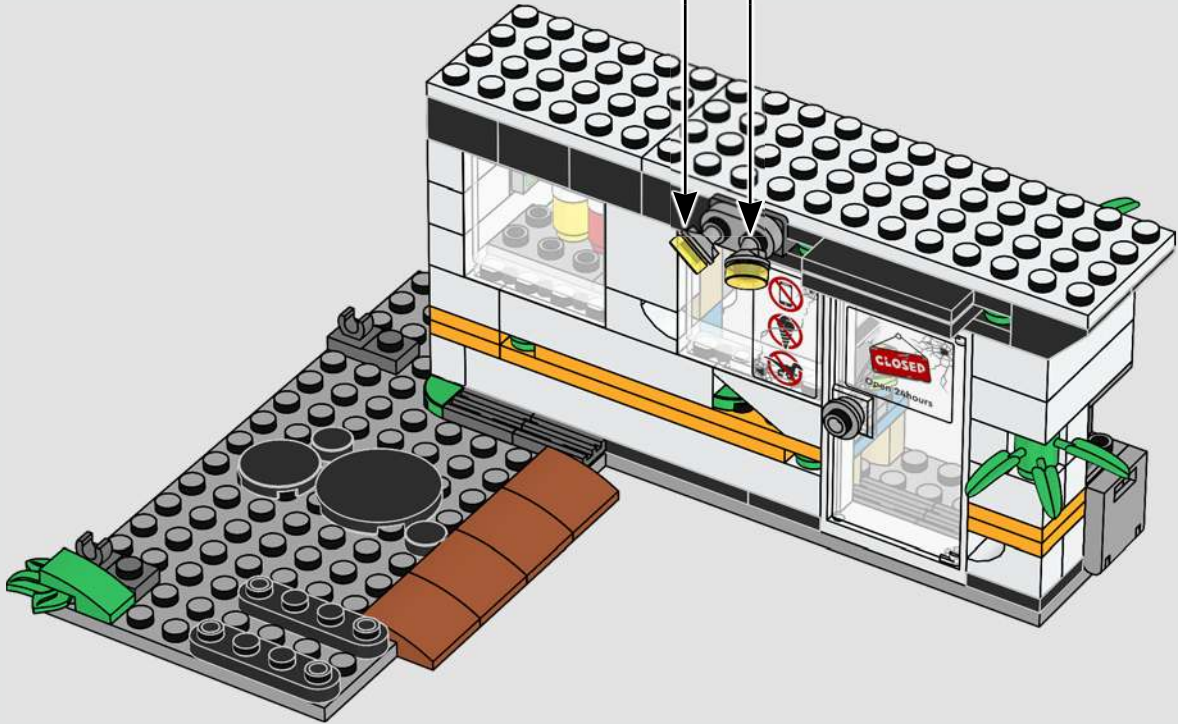

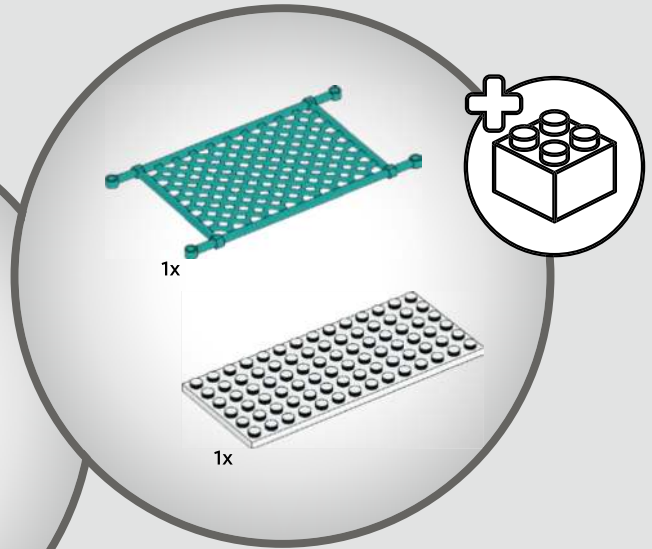



6x

50

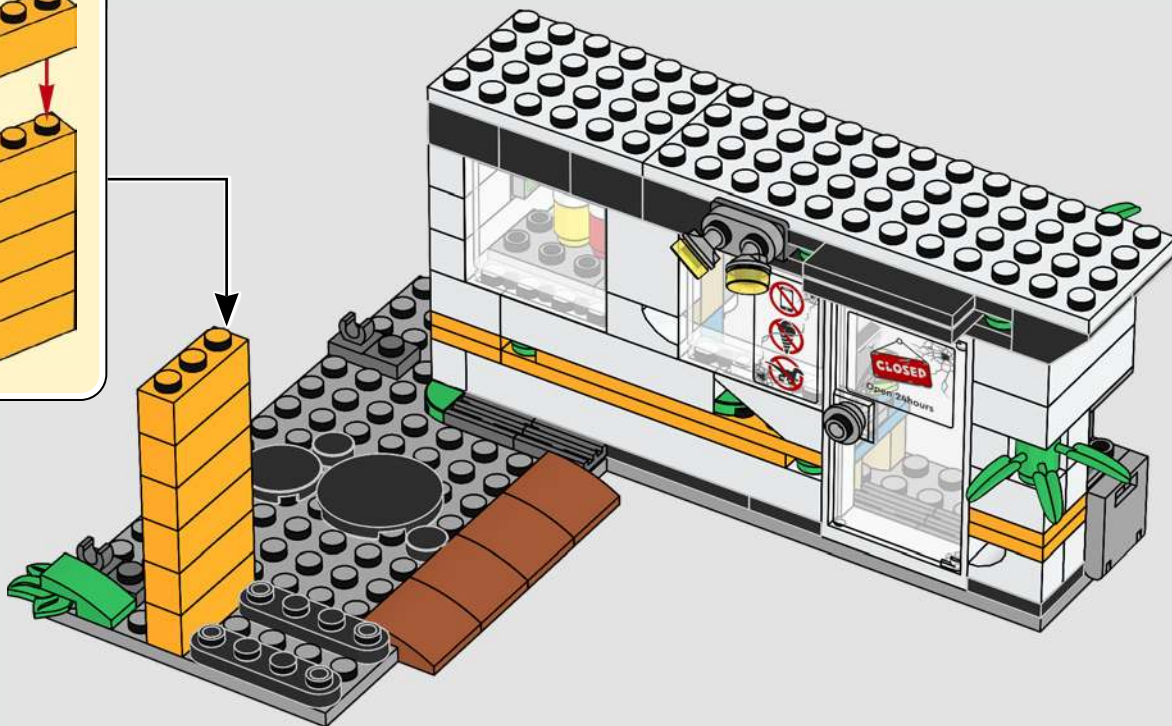
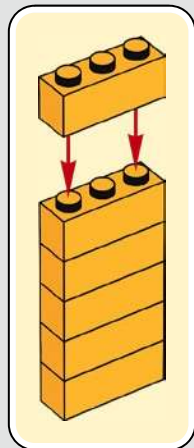

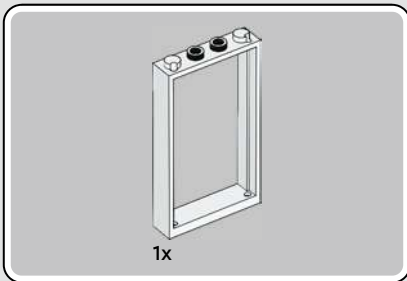

51

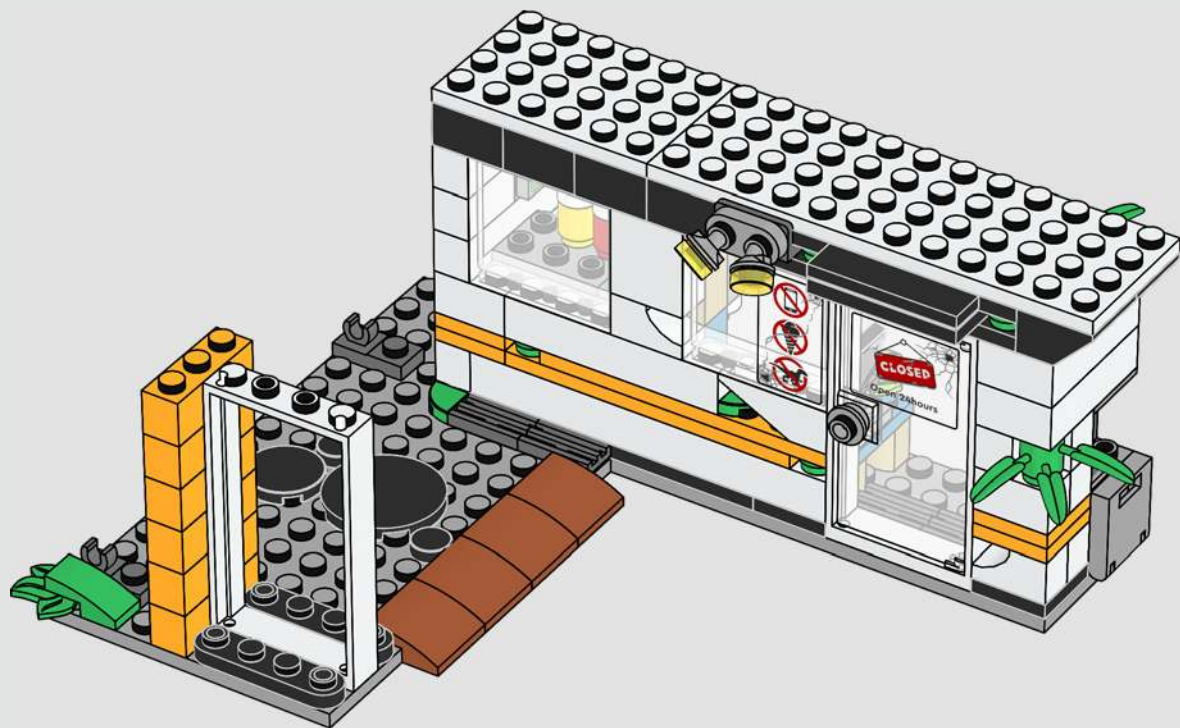

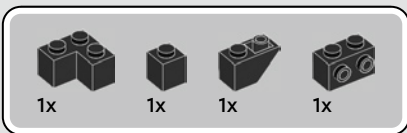

52





1x

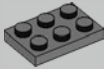

1x

53

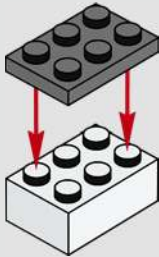

4x

54

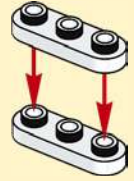
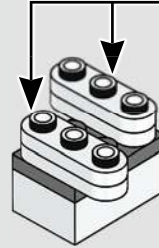

2x



2x



2x

55

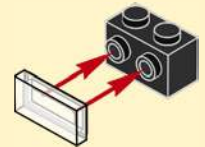
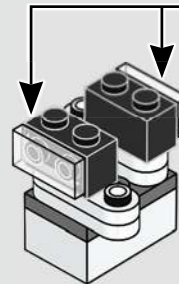

2x

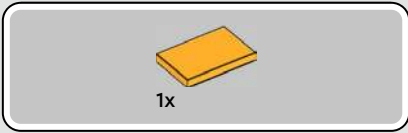

56

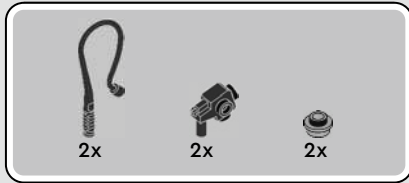
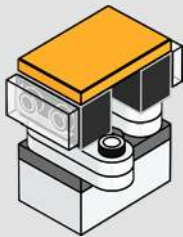

57

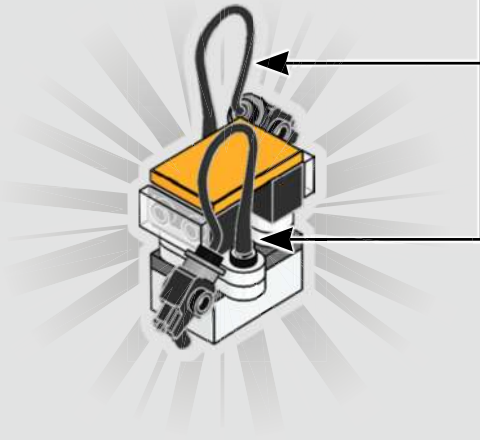
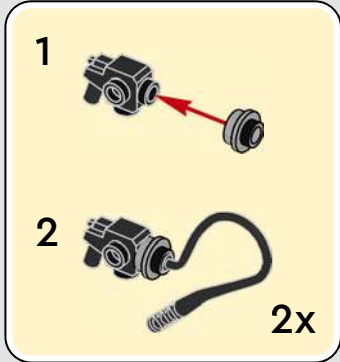

58

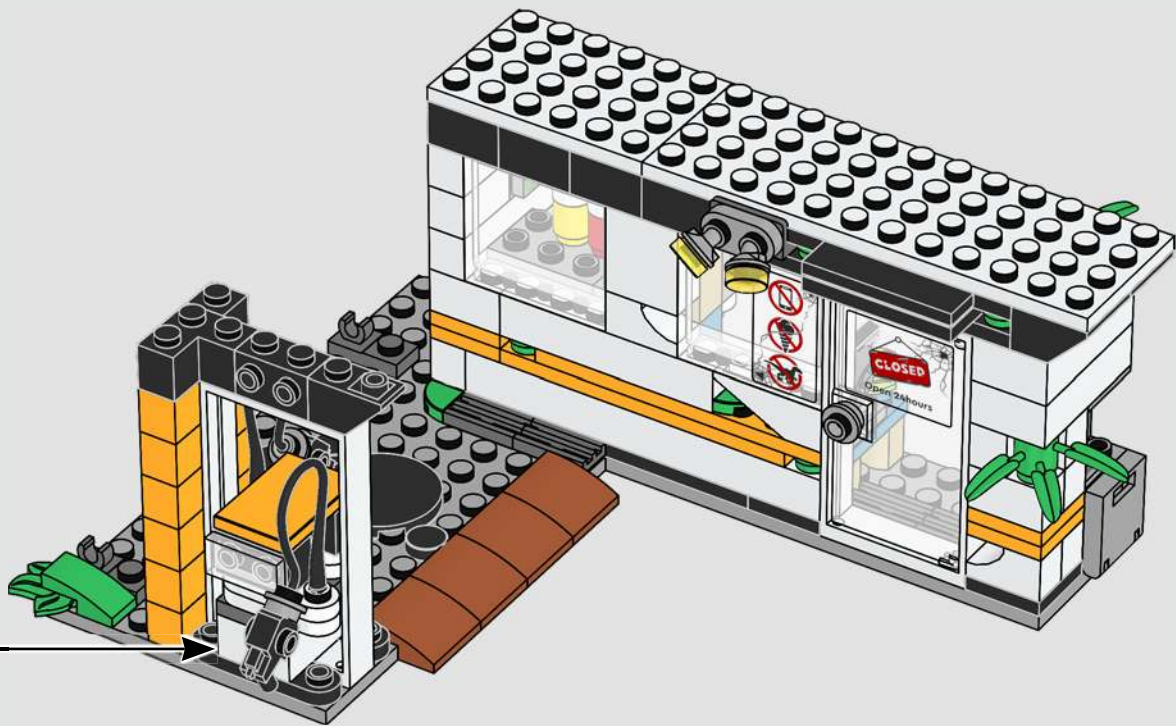

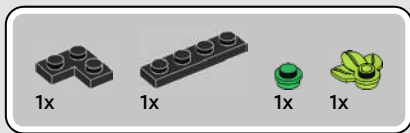

59

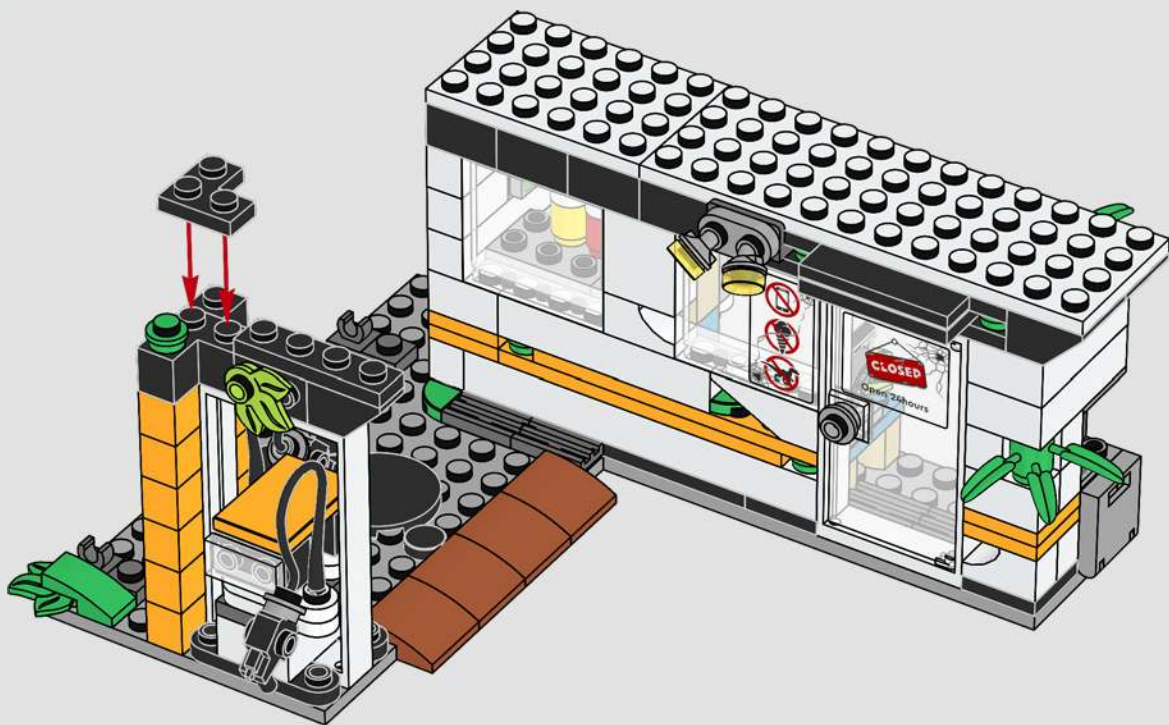



1x

60



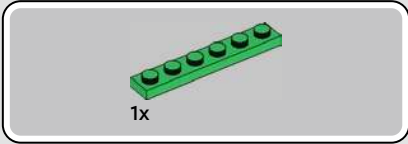
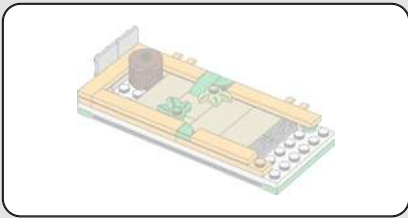

61

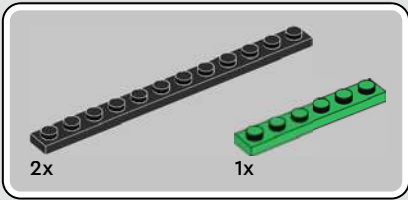
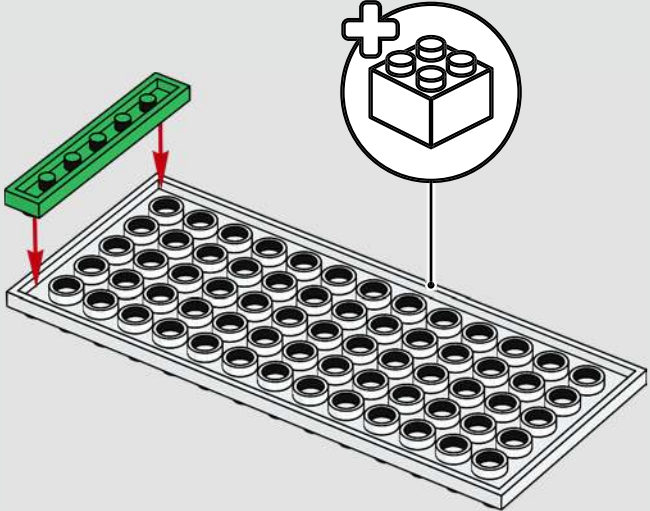

62

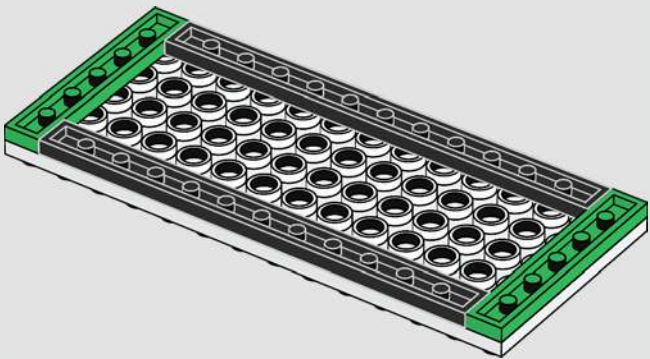

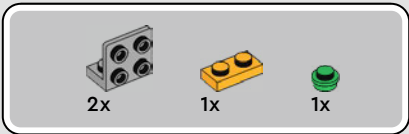

63

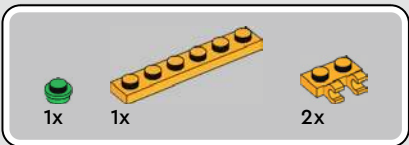
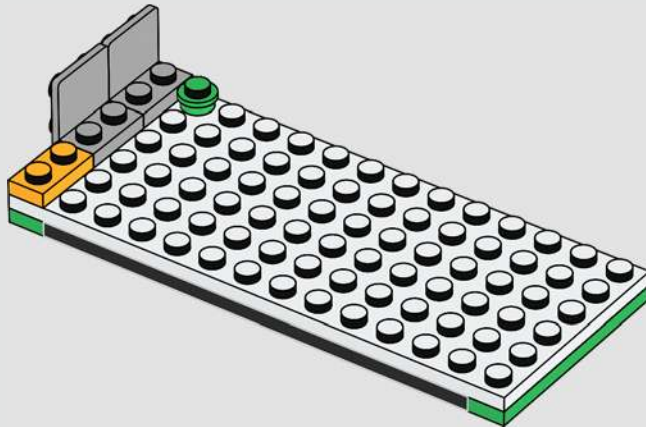

64

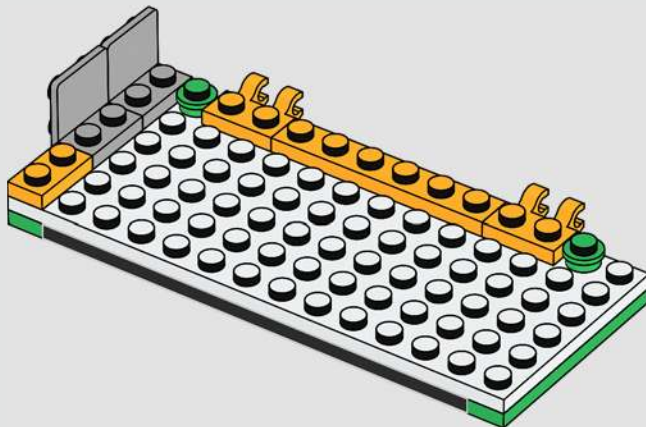

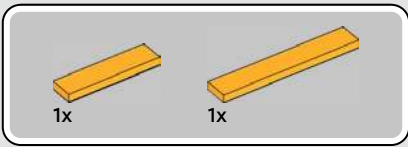

66

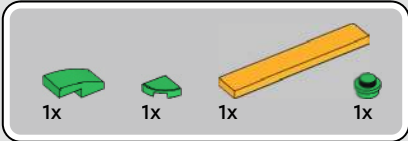
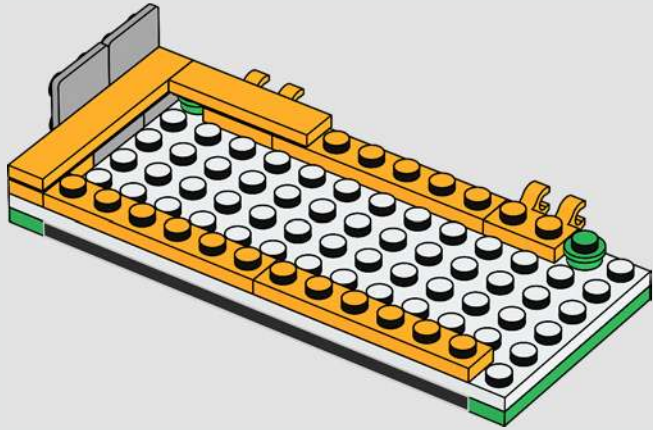

67

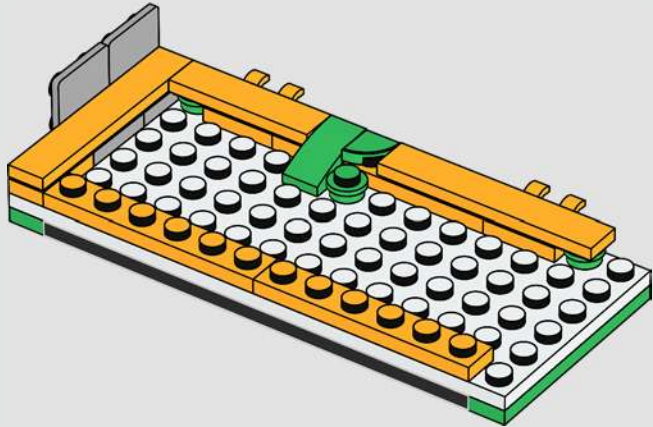

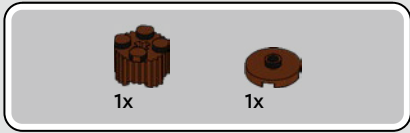

68

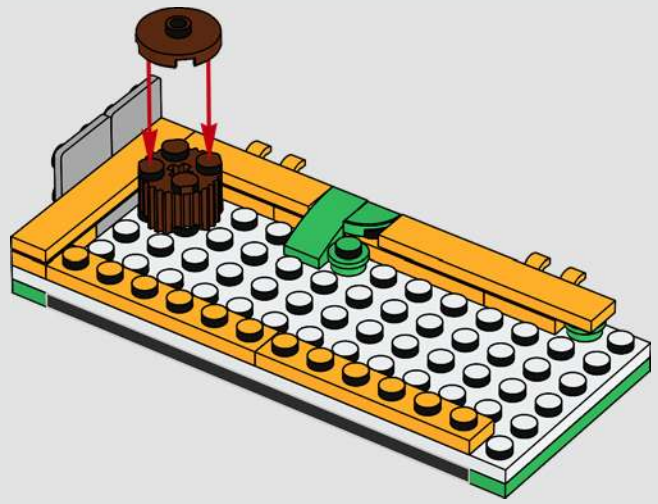

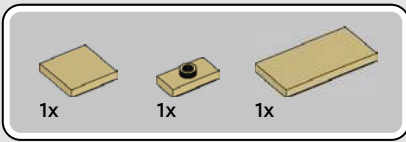

69

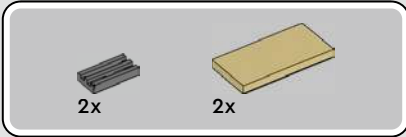
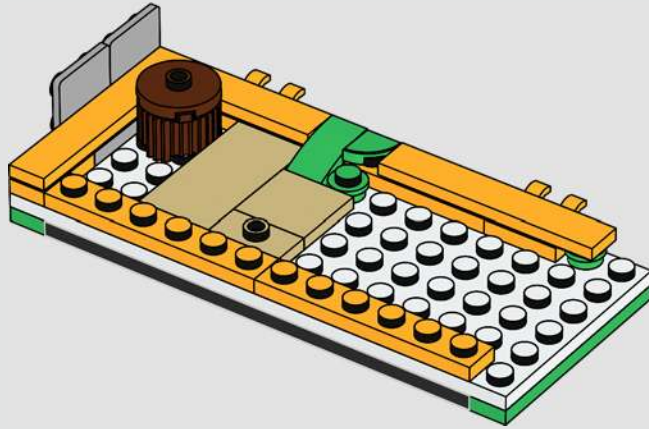

70

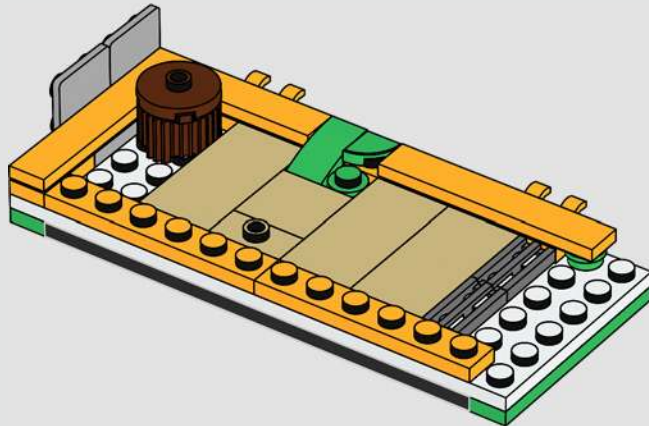

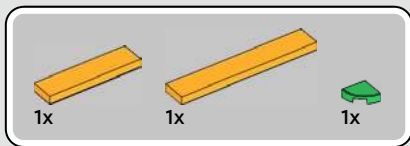

71

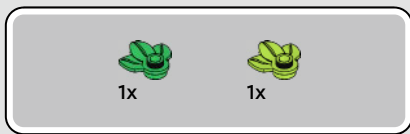
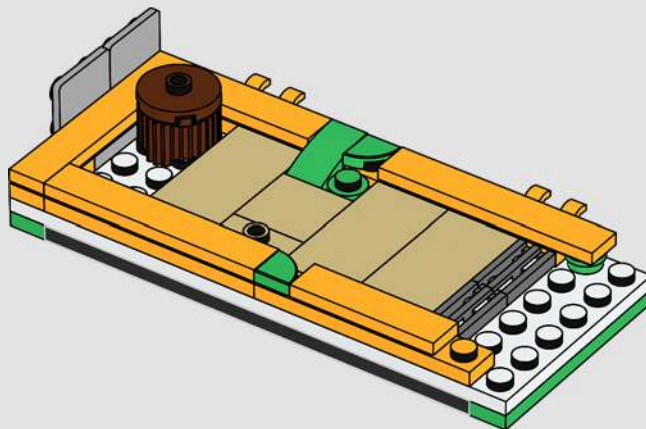

72

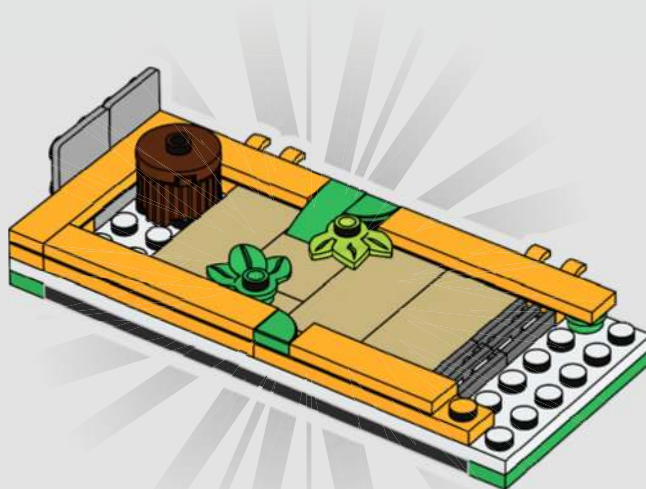

73





1x

74

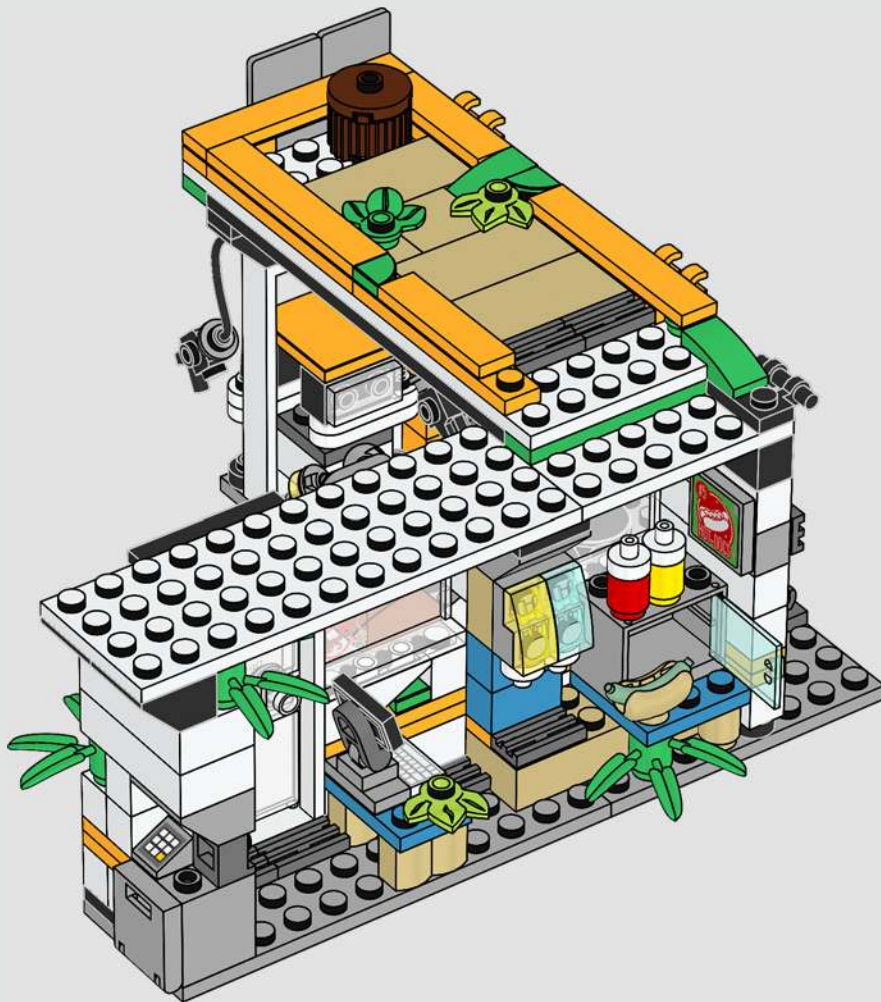

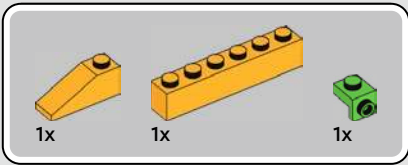

75





1x



1x

76

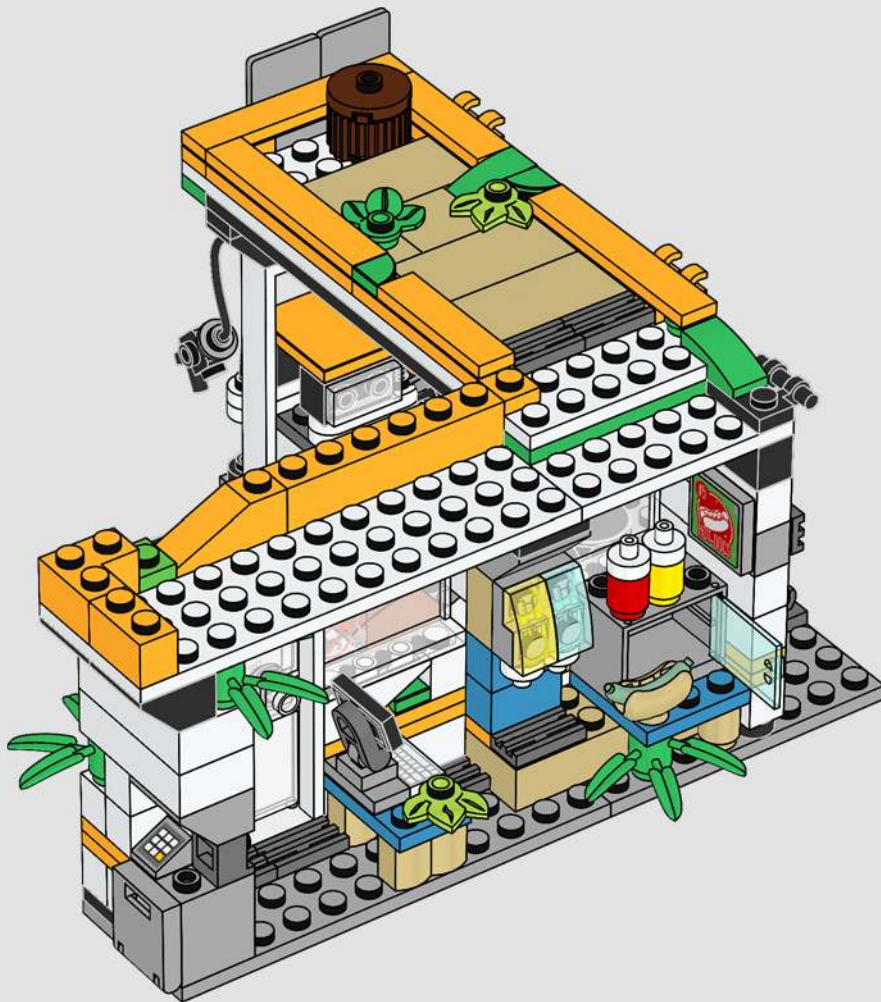



1x



1x

77



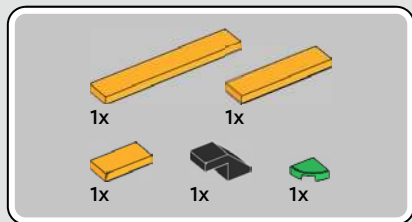

78



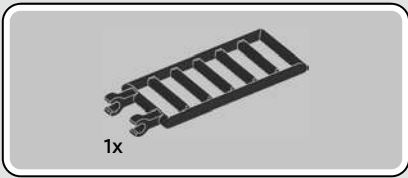

79

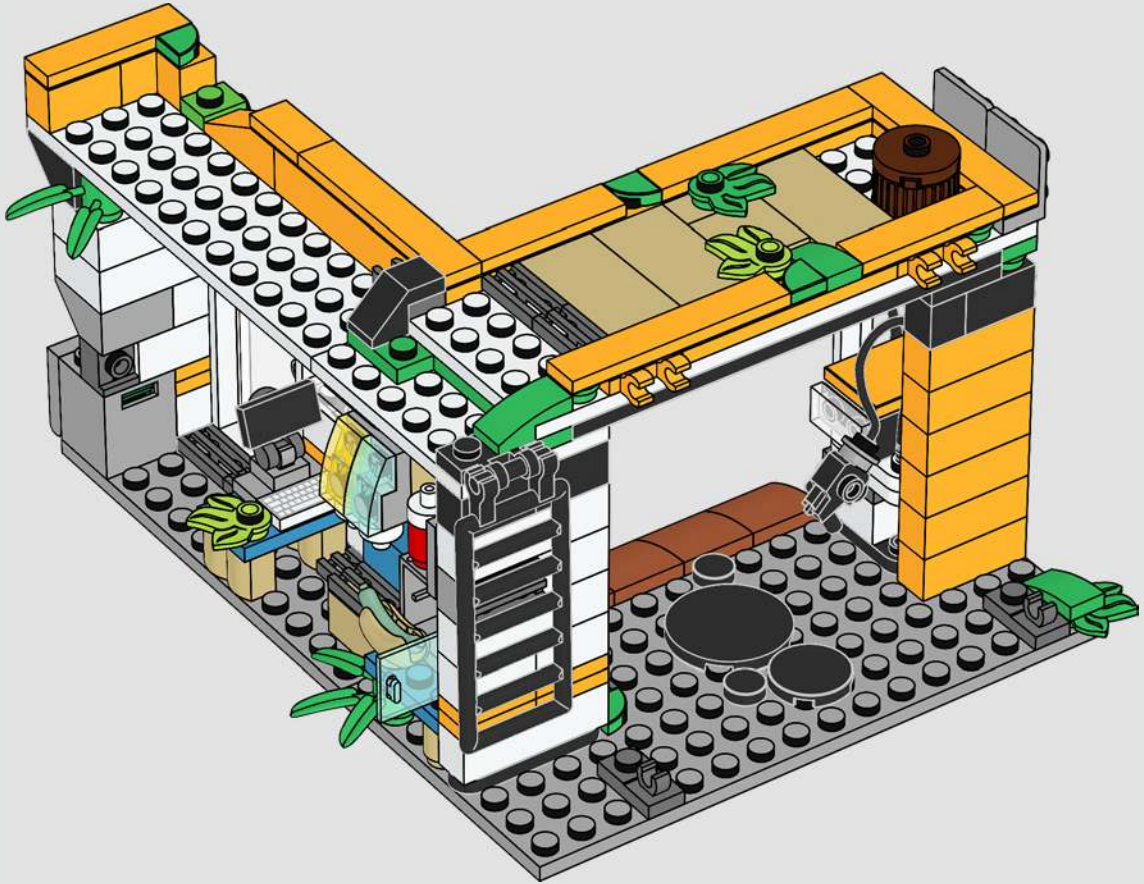

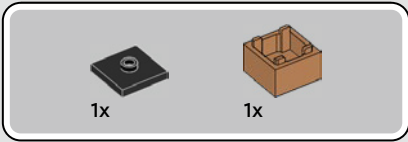

80

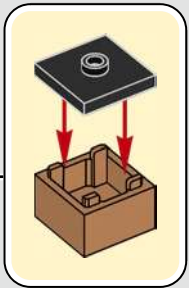
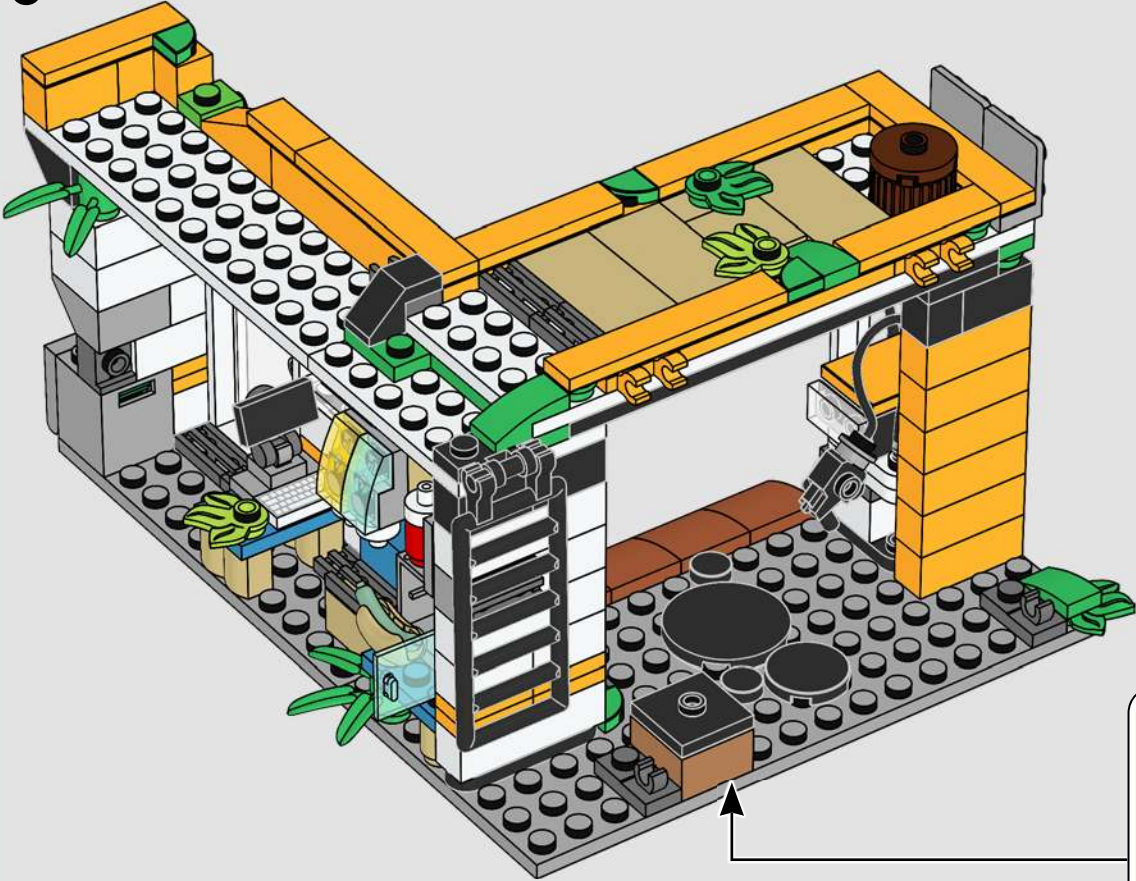



81

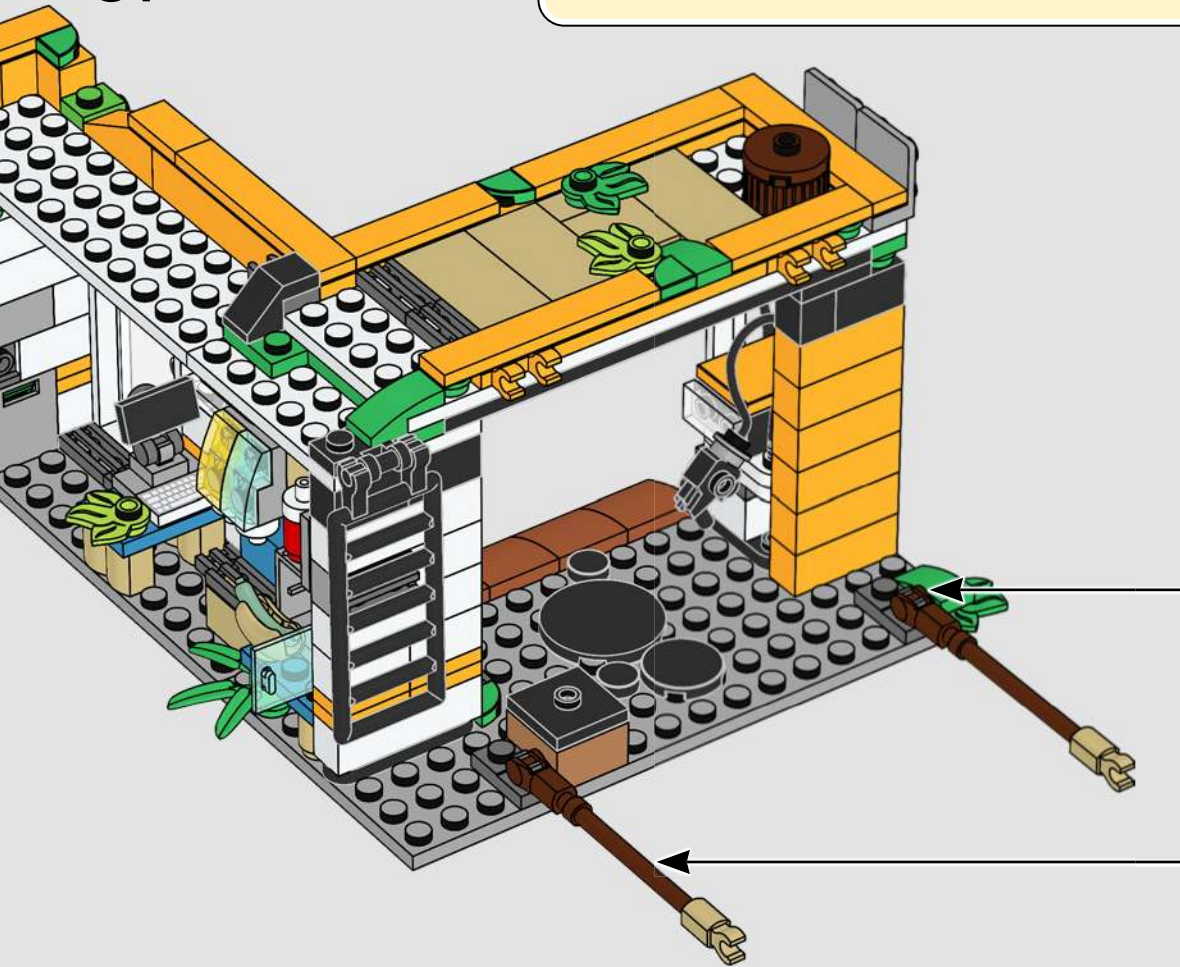
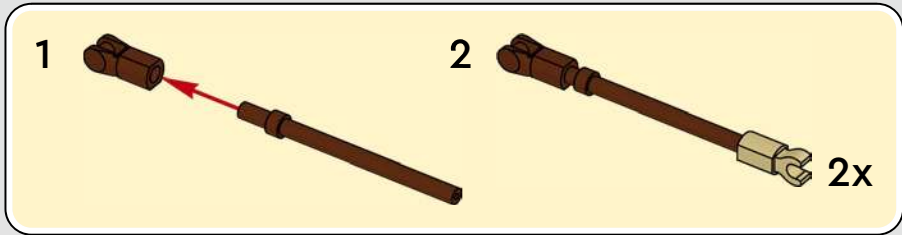

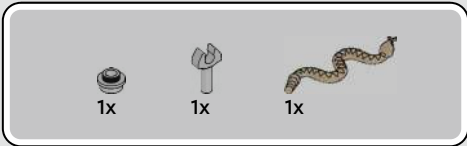

82

1

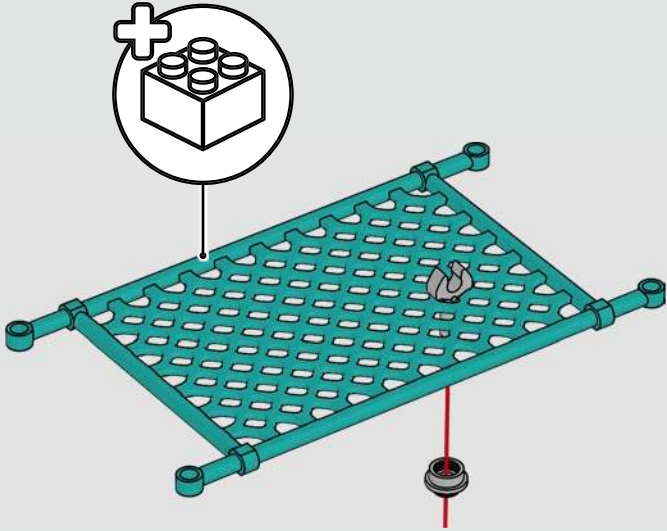

2

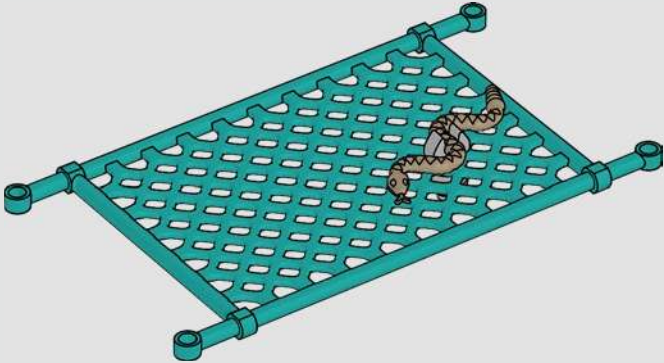

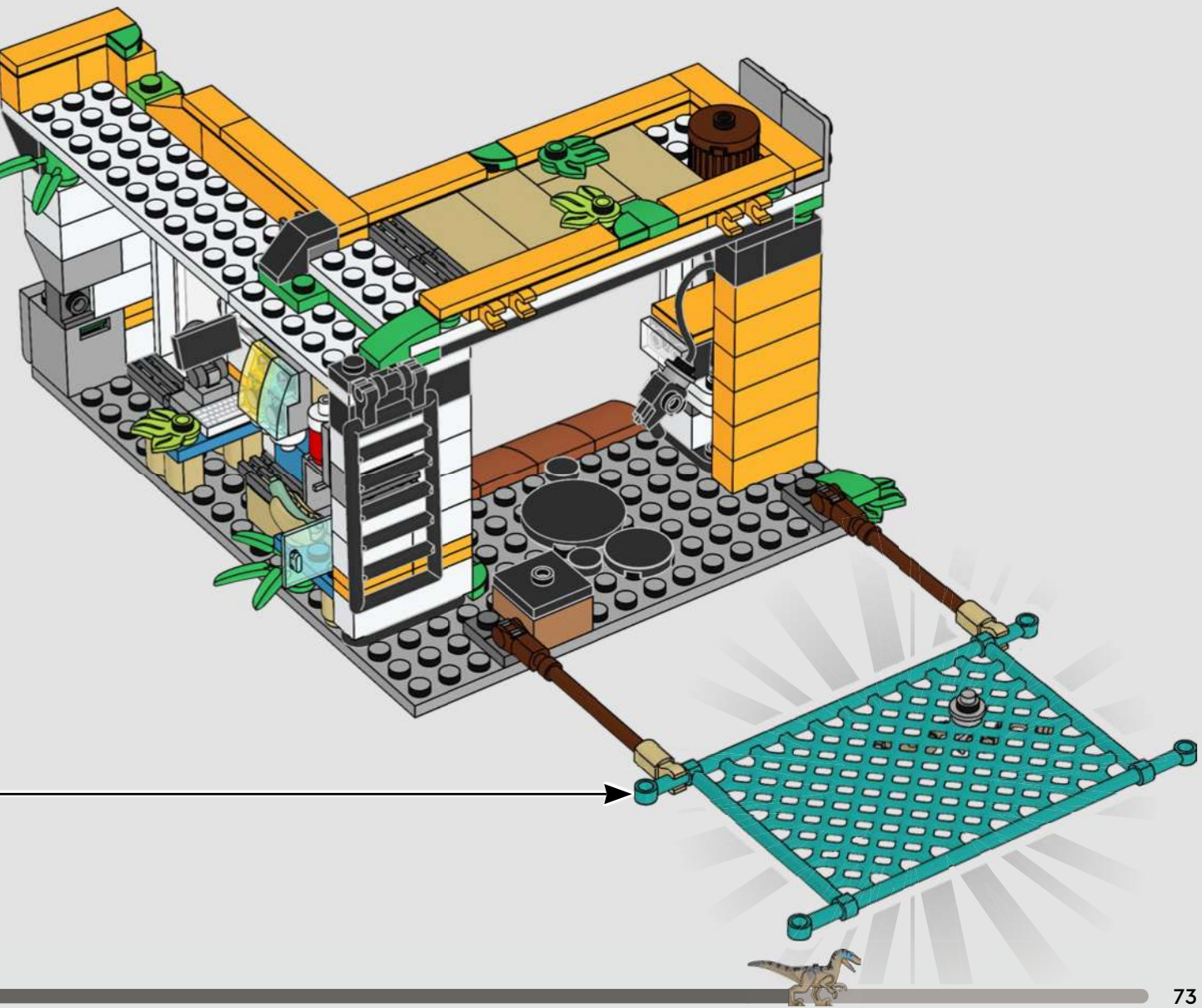

83

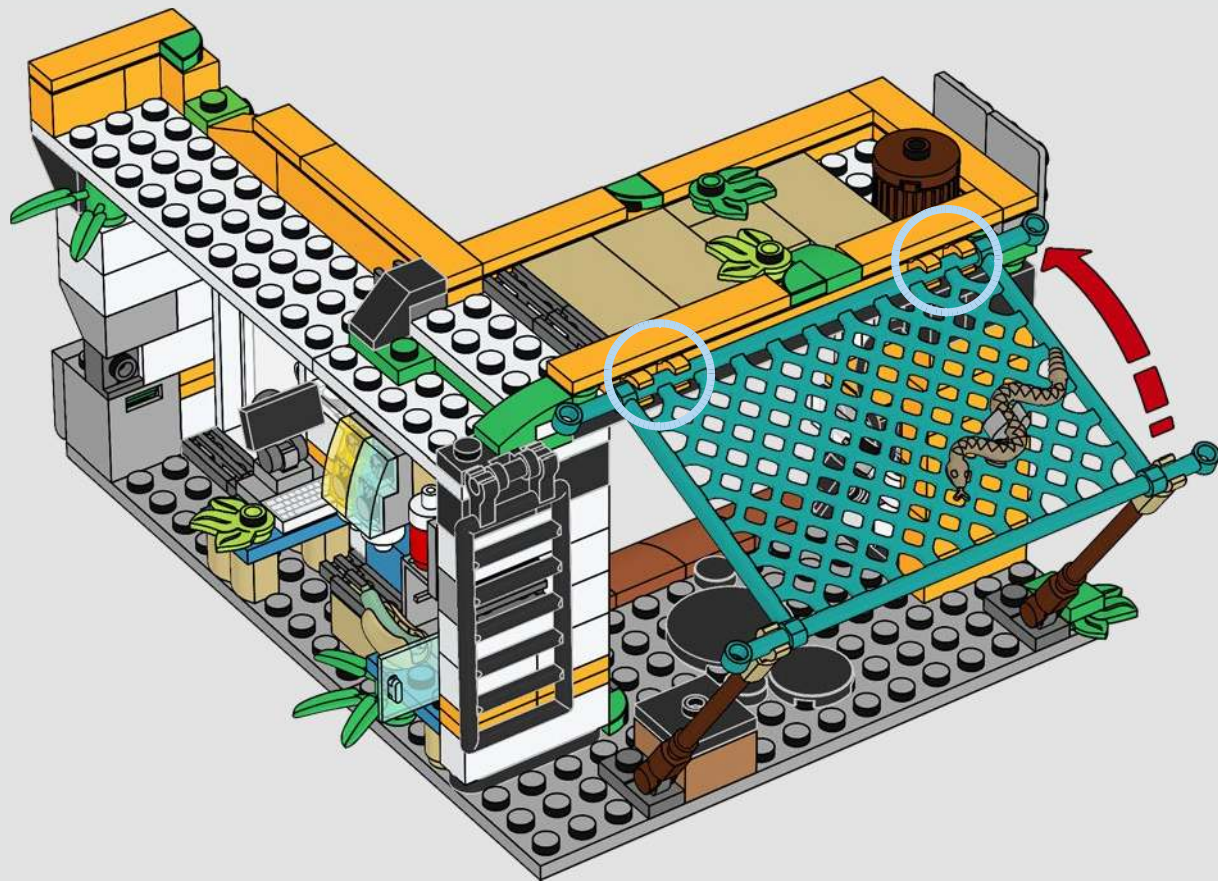



1x



1x



1x

84

1

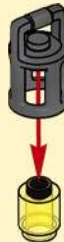

2



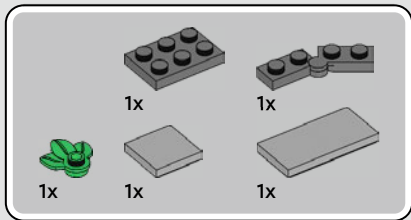

85

1

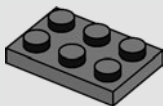

2

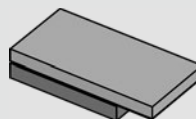

3

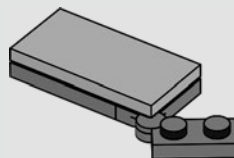

4

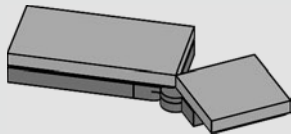

5

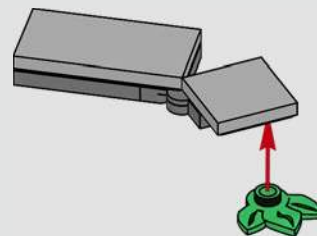

6



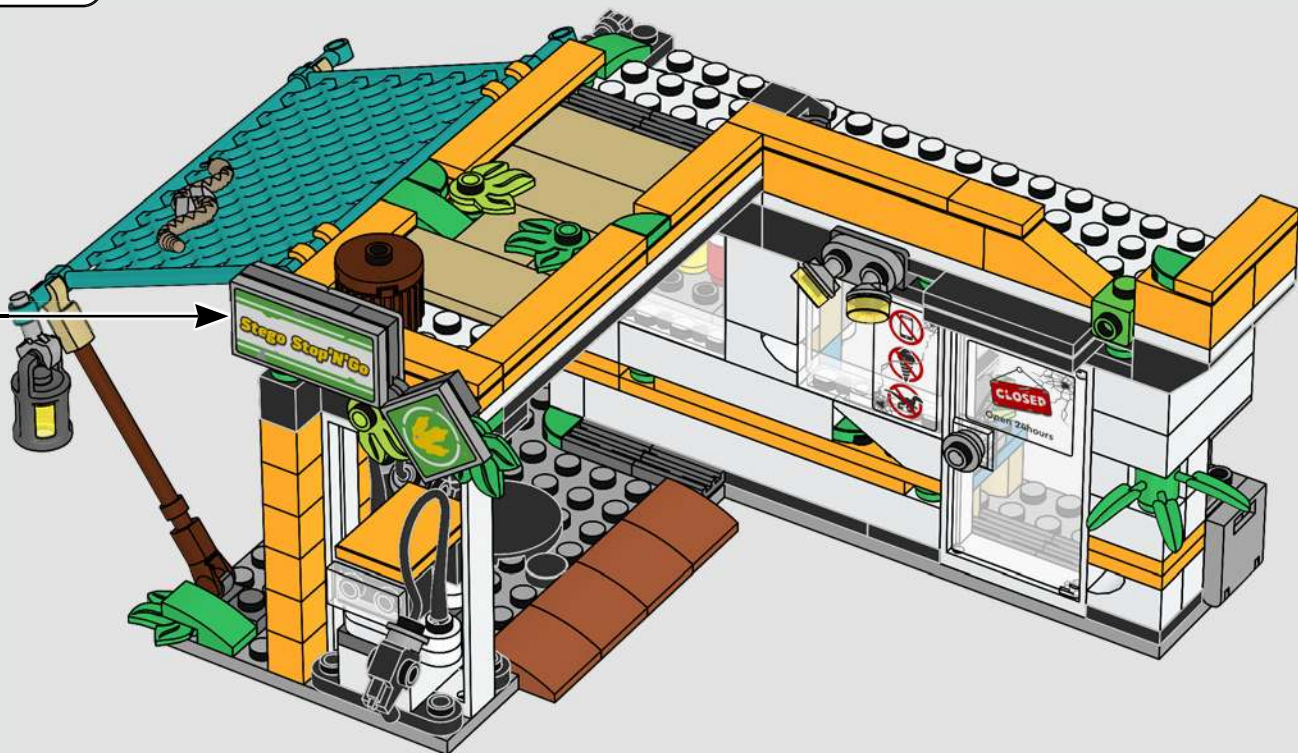

1x

86

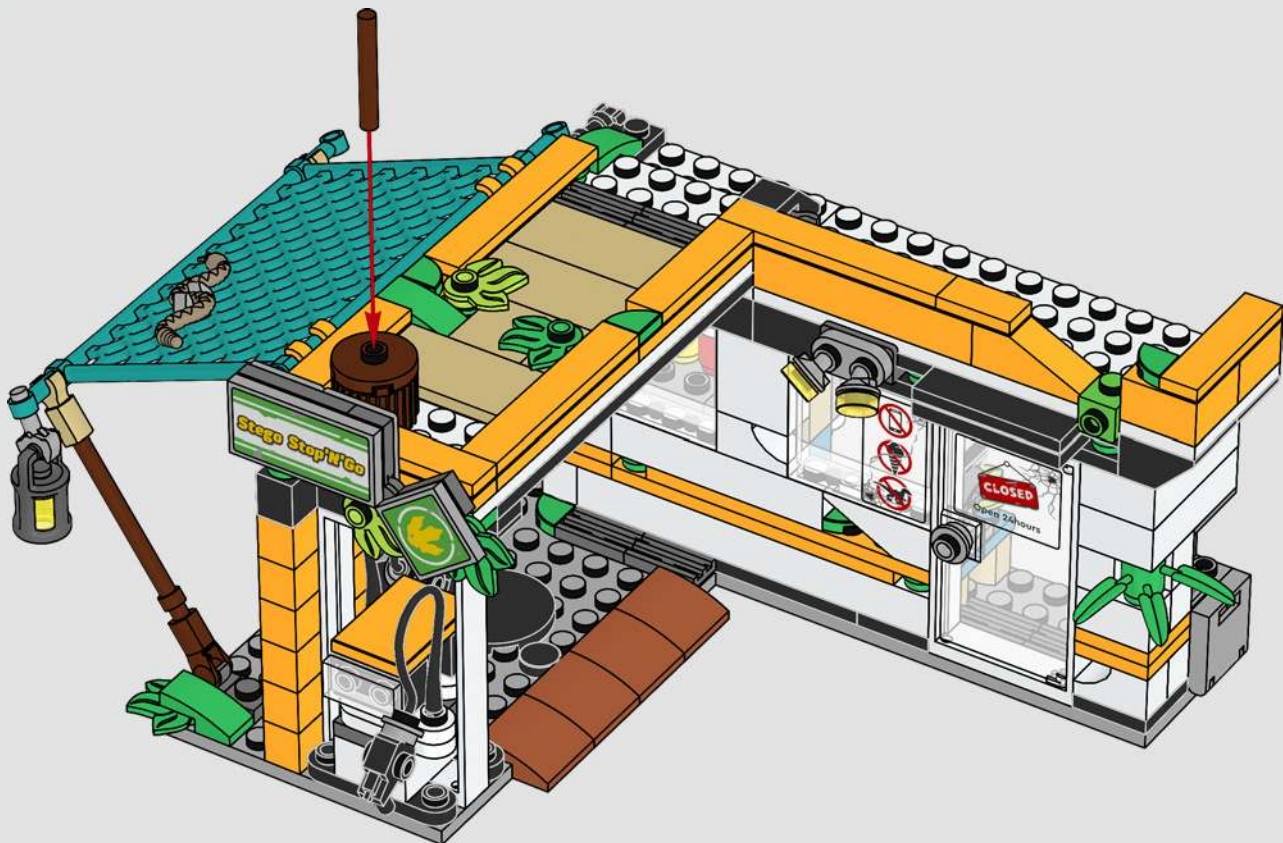



2x

87

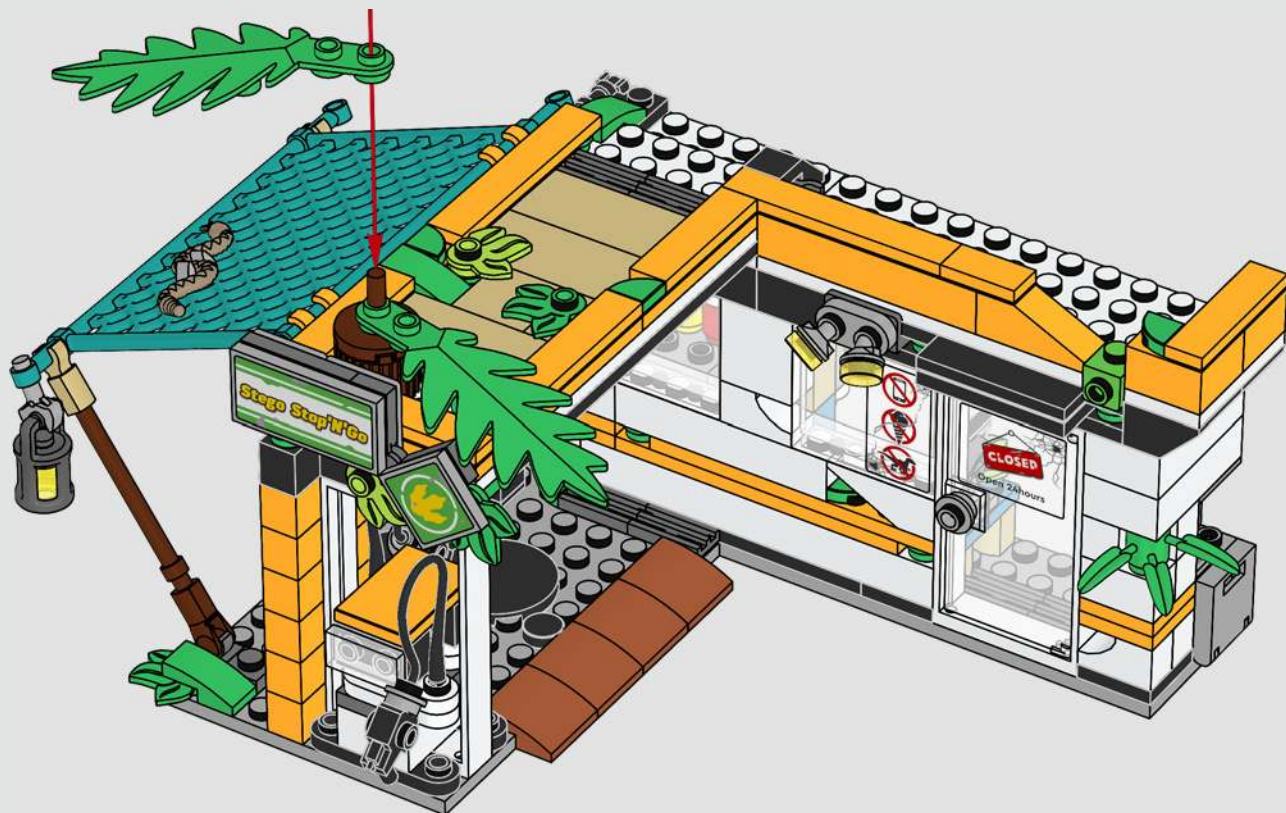

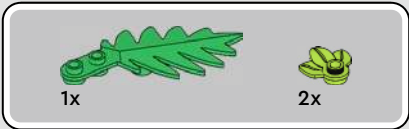

88

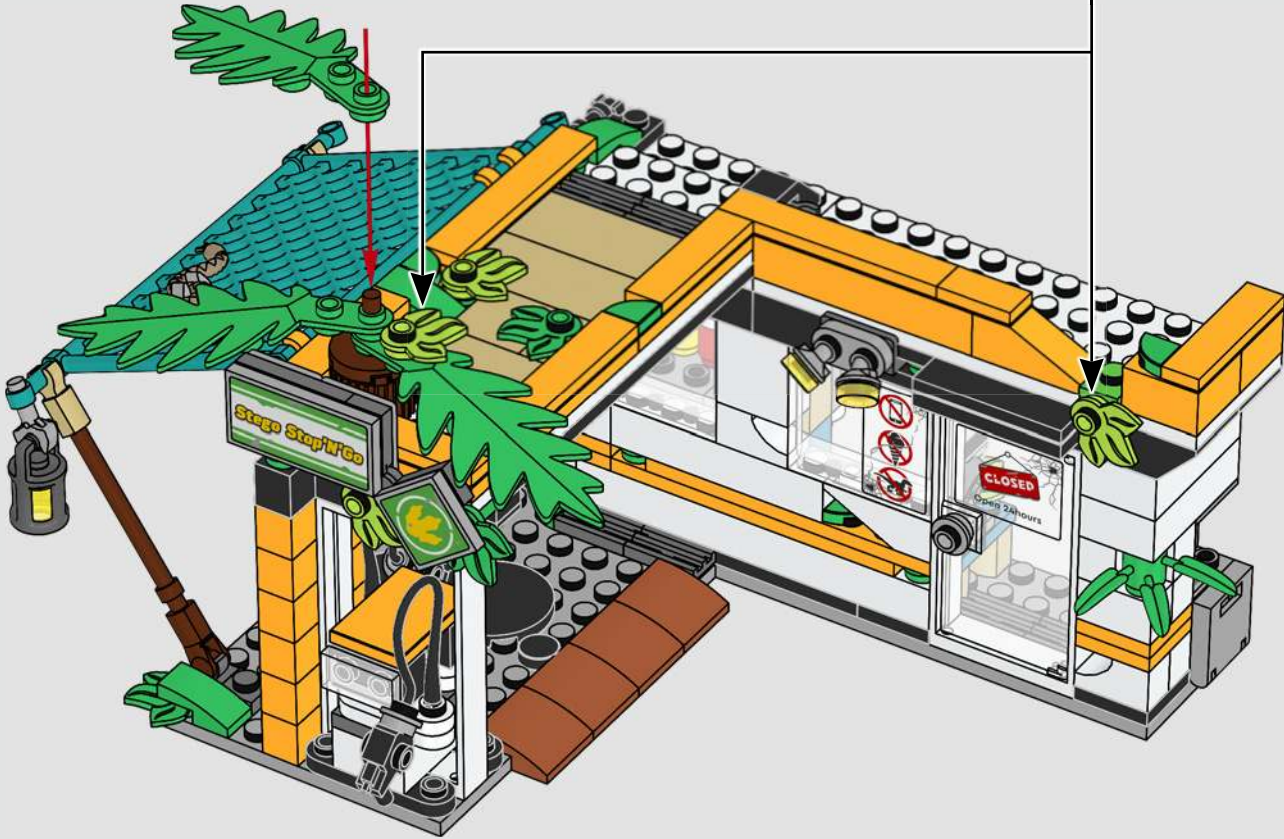
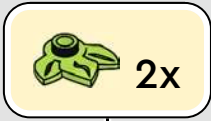

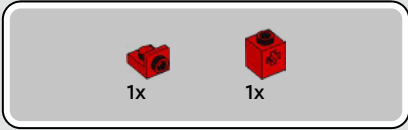
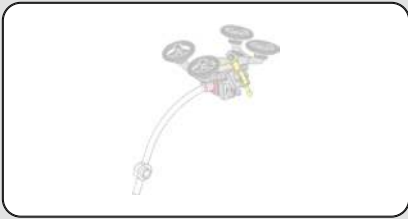

89

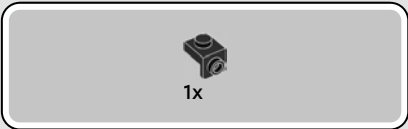
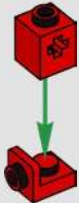

90

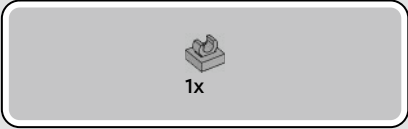

91



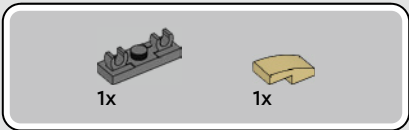

92

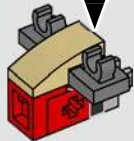
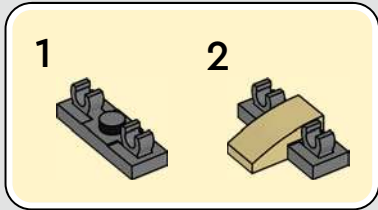

93

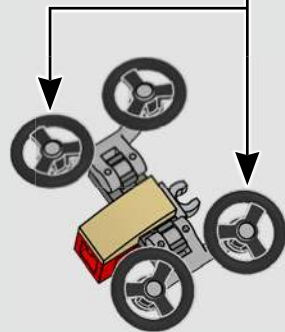
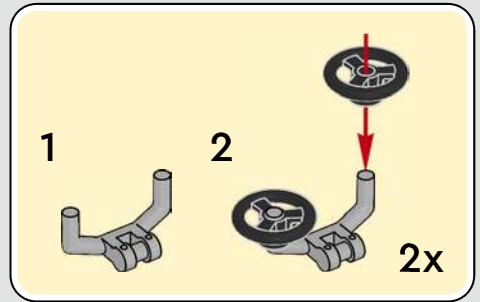



94

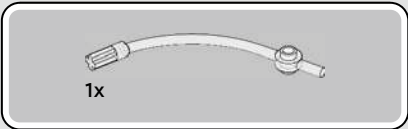
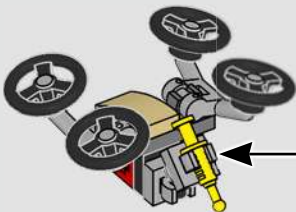
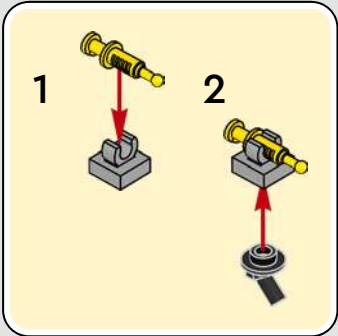

95

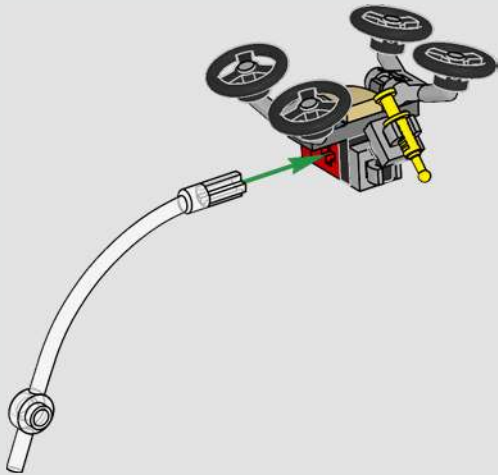

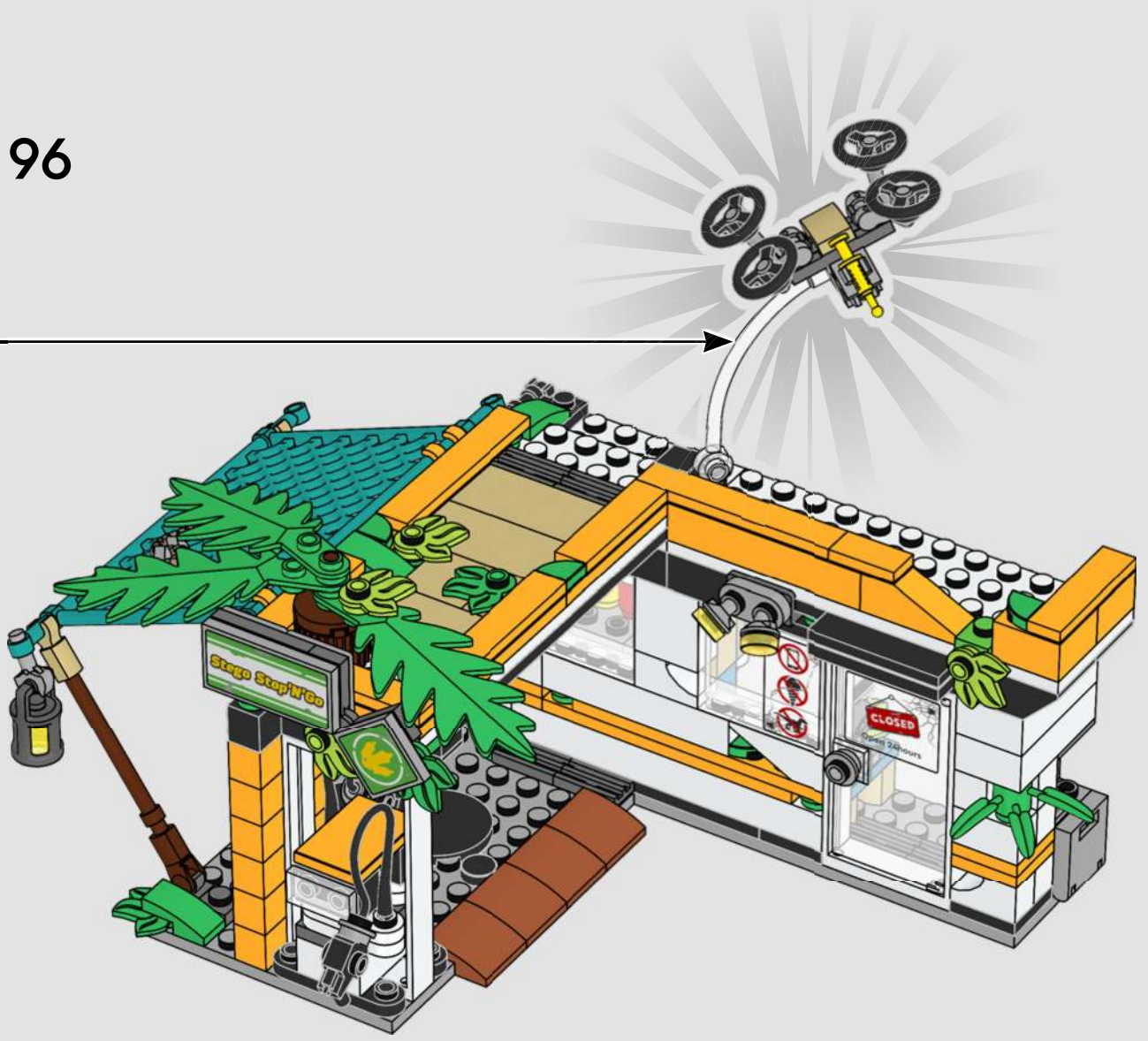





76970



76972



76975



76973



76976

1x
6322489

4x
6186681

6x
6452532

1x
6360202

1x
4547489

2x
6346616

4x
300401

1x
6329575

1x
4113261

4x
6450820

3x
235701

1x
428701

1x
6560437

1x
300201

88

3x
301001

2x
6262945

2x
300101

1x
6110023

1x
300901

1x
303201

1x
611101

1x
4168072

1x
6256981

2x
6337525

1x
4117070

1x
6507789

1x
6147214

3x
4218749

1x
4107623

1x
6565035

4x
6271228

3x
6092587

1x
6214334

1x
6046922

1x
6174925

1x
4185177

4x
4121921

2x
6257600

1x
4114309

3x
6122047

2x
6254770

1x
4181134

1x
4125217

1x
4509897

1x
6287328

1x
6551250

2x
4515365

2x
4533742

1x
306221

1x
6473604

1x
389921

1x
6249907

4x
6337002

5x
4142865

1x
4651524

1x
614321

1x
6390264

1x
243221

1x
6534944

2x
6544439

2x
6347308

2x
6219819

1x
6361953

1x
306224

3x
4201587

1x
6299764

1x
241224

3x
6146219

3x
302224

1x
6411332

2x
362324

1x
6257598

2x
6218360

1x
6021997

1x
6435640

1x
6167599

8x
4569058

5x
6150607

1x
6384591

6x
6229130

1x
302328

3x
6047426

1x
4295260

3x
6270003

2x
366628

3x
6269040

6x
6266964

2x
6142505

1x
6360331

4x
6104344

1x
6315887

2x
6168646

2x
6284070

1x
6510193

1x
6332148

1x
300526

1x
6299338

2x
6359865

2x
6253695

2x
6308000

4x
6210270

6x
6286850

1x
6070695

1x
6195325

4x
6057397

1x
6476480

1x
452826

1x
6267487

5x
302326

1x
9552

2x
6174243

4x
300426

1x
366526

3x
6138173

1x
306926

2x
6064174

1x
3003126

1x
6390386

1x
4140588

1x
4225201

1x
6234806

1x
6093525

1x
306826

1x
6273226

3x
242026

4x
235726

1x
4565323

1x
302226

2x
6425507

2x
4568644

2x
6469445

1x
6376695

2x
6328095

3x
6428167

4x
6162541

1x
6099483

2x
243126

1x
371026

1x
302026

1x
6338416

2x
6369923

1x
6256116

1x
4274405

1x
6509833

1x
6298539

3x
346026

1x
6551217



1x
6551218



1x
6551219



1x
6551220

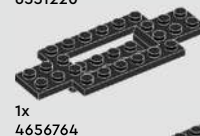

1x
4656764



2x
4514845

5x
6055225



1x
4543949



5x
6286831



1x
6565036



1x
4211044



1x
6388119



9x
4210631



3x
6029948

1x
6000606



3x
6191976



1x
4210865



1x
6365692



2x
6271127



3x
4211043



2x
6083620



1x
6416526

4

1x
6561519



1x
6328445



1x
6560177



1x
6344864



1x
6565239



1x
6564520



1x
6522351



1x
6522351



1x
4570111



3x
6020074



1x
6186542

2x
6514059



2x
6514197



4x
6028736



1x
6003003



1x
4622062



2x
6337271



2x
6099714



2x
6003033

1x
6034175



1x
6131583



6x
6061688



1x
6286881

1x
6286881



3x
6072668



4x
6365966



4x
6365966

4x
6514189



1x
6508249



1x
6514073



1x
6514236



5x
6514193



1x
6508250



6x
6476174



2x
4529242

4x
6439053



6x
6348057



1x
6267760



1x
6539446

6x
6451002



2x
6036503



1x
6268828



1x
6268828

1x
6102360



1x
6092568



1x
6459423



4x
4531751



2x
6151461



1x
6428805



2x
4211200



1x
4652624

3

1x
6135494



5x
6261388



3x
4211190



1x
6497747

2x
6084573



2x
6084573



3x
6170468



3x
6170468



1x
6551216



1x
6163442



1x
6223932



2x
6520665



1x
6361354



2x
6413492



1x
6234116



2x
6004943



1x
6144149



1x
6496808



1x
6511987



2x
6504188



1x
6361902



1x
4539481



1x
6347715



2x
4211525



4x
6168647



2x
6439041



2x
6510189



1x
6343004



3x
6308012



4x
6335328



1x
4550170



1x
6344702



3x
6248890



1x
6225246



1x
4211492



1x
4278273



1x
4657459



3x
6213378



3x
6329662



4x
4211350



1x
6066097



2x
4211614



4x
4211398



1x
6186657



2x
4211440



2x
6004990



2x
4654580



1x
4211632



2x
6354568



2x
6065824



2x
4211413



2x
6435857



2x
4211815



1x
6469440



4x
4515369



1x
4211491



2x
4644102



1x
4211396



1x
4610112



1x
4211445



2x
4211395



2x
4560183



1x
4211837

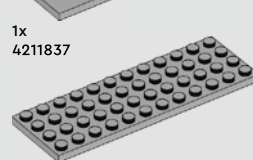

1x
4211401

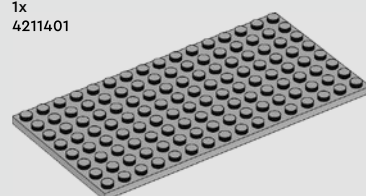

1x
4598522

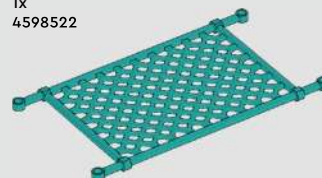

1x
6481121



1x
6551205



1x
6240515



2x
6361949



2x
6514191



2x
6245250



2x
6514223



1x
6514119



2x
6514156



1x
6510119

 [LEGO.com/service](https://www.LEGO.com/service)

YOU COULD **WIN**



Scan this QR code or go to
LEGO.COM/PRODUCTFEEDBACK and give us
your short feedback about this LEGO® set
for a chance to win a cool LEGO prize.

Terms and Conditions apply*

EN: YOU COULD WIN. Terms and Conditions apply* **DE: Du könntest GEWINNEN.** Es gelten die Teilnahmebedingungen* **FR: Tu pourrais GAGNER.** Des conditions s'appliquent* **IT: Potresti VINCERE tu.** Termini e condizioni sono applicabili* **ES: Puedes GANAR.** Aplican términos y condiciones* **PT: PODERÁ GANHAR.** Aplicam-se Termos e Condições* **ZH: 轻松获奖.** 条款和条件适用* **PL: Szansa na WYGRANĄ.** Obowiązuje regulamin* **CS: Máte šanci VYHRÁT.** Platí všeobecné smluvní podmínky* **SK: Máte šancu VYHRAŤ.** Platia všeobecné zmluvné podmienky* **HU: TE IS NYERHETSZ.** Felhasználási feltételek érvényesek* **UA: ВИ МОЖЕТЕ ВИГРАТИ.** Застосовуються загальні положення та умови* **RO: Ai putea CÂȘTIGA.** Se aplică termeni și condiții* **BG: Можете да СПЕЧЕЛИТЕ.** Има определени правила и условия* **LV: Tu vari LAIMĒT.** Ir spēkā noteikumi un nosacījumi.* **ET: Sul on võimalus VÕITA.** Kehtivad tingimused* **LT: Jūs galite LAIMĖTI.** Taikomos sąlygos*
**LEGO.com/productfeedback-terms*