

Dangbei

Google TV

Freedom
Portable Projector

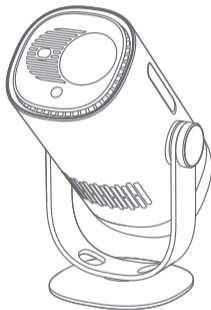

User Manual

Language

English	01-24
Deutsch	25-48
Français	49-72
Italiano	73-96
Español	97-120
日本語	121-143

Contents

Read before Use	01
Important Precautions	02
Packing List	03
Projector Overview	04
Power Button LED Indicator Guide	06
Remote Control Overview	08
Getting Started	09
Network Settings	12
Focus Settings	12
Image Correction Settings	13
Bluetooth Speaker Mode	14
Battery Mode	14
Charging with a Power Bank	15
Google Assistant	15
Google Cast™	16
Screen Mirroring	16
Inputs	17
More Settings	17
Specifications	18
Troubleshooting	19
Statement	21

Read before Use

Please read the product instructions carefully:

Thank you for purchasing and using these products.

For your safety and interests, please read the Product Instructions carefully before using the product.

About the Product Instructions:

The trademarks and names mentioned in the Product Instructions are the property of their respective owners.

All Product Instructions shown are for illustration purposes only. The actual product may vary due to product enhancements.

We shall not be liable for any personal injury, property damage, or other damages caused by the failure of the user to comply with the Product Instructions or precautions.

* Dangbei reserves the right to interpret and modify the Product Instructions.

Important Precautions



- As with any bright source, do not stare into the direct beam, RG2 IEC 62471-5:2015
- Users are aware of the risk of skin or corneal burns. CLASS 1 LASER PRODUCT, Comply with IEC 60825-1:2014.
- Do not block or cover the heat dissipation holes of the device to avoid affecting the heat dissipation of the internal parts, and damaging the device.
- Keep away from humidity, exposure, high temperature, low pressure, and magnetic environments.
- Do not place the device in areas susceptible to excessive dust and dirt.
- Place the device in a flat and stable station, and do not place the device on a surface that is prone to vibration.
- Do not allow children to handle the device without supervision.
- Do not place heavy or sharp objects on the device.
- Avoid extreme vibrations, because these may damage the internal components.
- Please use the correct type of battery for the remote control.
- Only use attachments/accessories specified or provided by the manufacturer (such as the exclusive power adapter, bracket, etc.).
- Do not disassemble the device. The device should only be repaired by staff authorized by the manufacturer.
- Place and use the device in a 5-35°C environment.
- The metal casing is coated with insulating paint.
- The plug is considered as a disconnected device of the adapter.
- The adapter should be installed near the equipment, and should be easily accessible.
- Protect the power cord from being walked on or pinched, particularly at the plugs, convenience receptacles, and the point where this exits from the device.
- Unplug this device if there are lightning storms or when unused for a long period of time.
- Where the power plug or an appliance coupler is used to disconnect the device, the disconnected device would remain readily operable.
- Never touch the power cable or power connector with wet hands.
- Risk of explosion if battery is replaced by an incorrect type. Dispose of used batteries according to local regulations.

Packing List

Before using this product, please check that all items are included in the box.



Projector



Remote Control



AAA Batteries

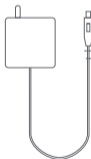

Power Adapter

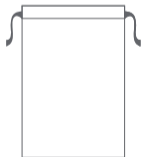

Portable Bag



User Manual

Projector Overview

Overview and interface description.

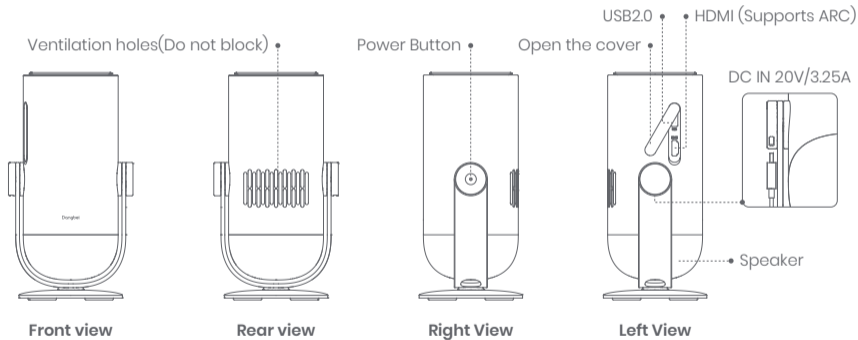

PTZ bracket socket

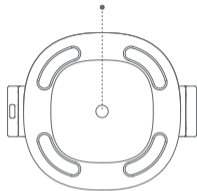

Bottom View

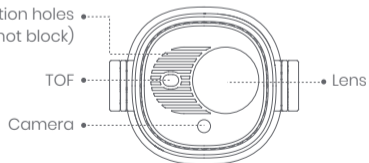
Ventilation holes
(Do not block)

Top View

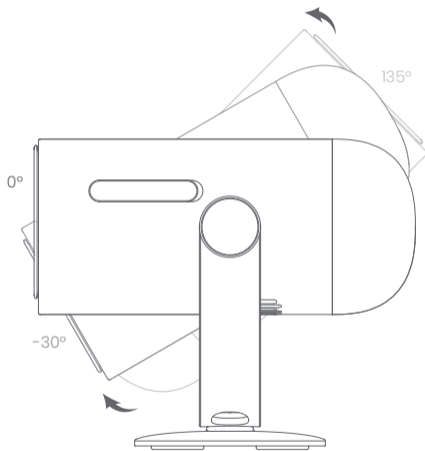

Tilt Angle Range: -30° to +135°

Power Button LED Indicator Guide

Scenario		Device Status	Battery Level	LED Behavior
Projection mode	Charging with adapter	Standby mode	=100%	White: breathing
			=70%-99%	Green: flashing
			=20%-69%	Orange: flashing
			≤19%	Red: flashing
		Power off	=100%	Off
			=70%-99%	Green: flashing
			=20%-69%	Orange: flashing
			≤19%	Red: flashing
		Power on	=100%	White: solid
			=70%-99%	
			=20%-69%	
			≤19%	

Scenario		Device Status	Battery Level	LED Behavior
Projection mode	Battery mode (unplugged)	Power off	=100%	Off
			=70%-99%	Off
			=20%-69%	Off
			≤19%	Off
		Power on	=100%	Off
			=70%-99%	Green: solid
			=20%-69%	Orange: solid
			≤19%	Red: flashing
	Battery level check (short press the projector power button in battery mode)	Power off	=70%-100%	Green: lights up once per press
			=20%-69%	Orange: lights up once per press
≤19%			Red: lights up once per press	
Bluetooth speaker mode	Switching to Bluetooth speaker mode	N/A	Blue: breathing	
	Waiting for pairing	N/A	Blue: breathing	
	Connected successfully	N/A	Blue: solid	
	Switching to projection mode	N/A	Refer to the projection mode LED behavior	

Remote Control Overview

- Open the battery compartment cover of the remote control.
- Install 2 AAA batteries *.
- Put back the battery compartment cover.

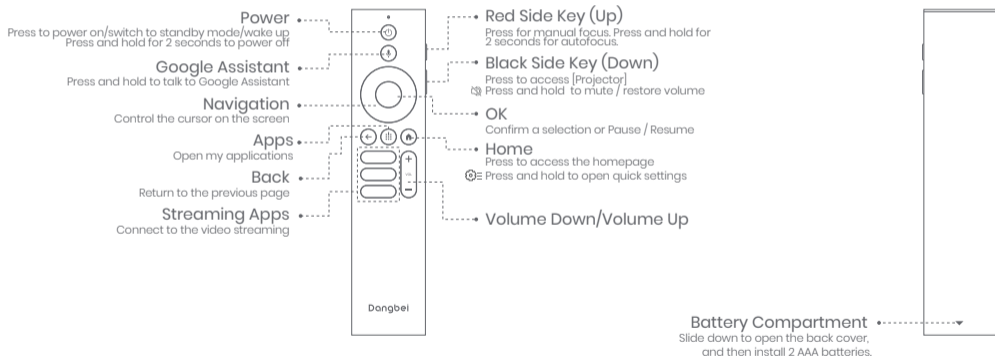

* Please insert new batteries according to the polarity indication.

Getting Started

1. Placement

Position the projector on a stable, flat surface in front of the projection surface. A flat and white projection surface is recommended. Please follow the instructions below to determine the distance between the projector and the projection surface, and the corresponding projection size:

Size	Screen (Length x Width)
60 inches	133 x 75 cm 4.36x2.46 ft
80 inches	177 x 100 cm 5.8x 3.28 ft
100 inches	221 x 124 cm 7.25 x 4.06 ft
120 inches	265 x 149 cm 8.69 x 4.88 ft



The best recommended projection size is 80 inches.

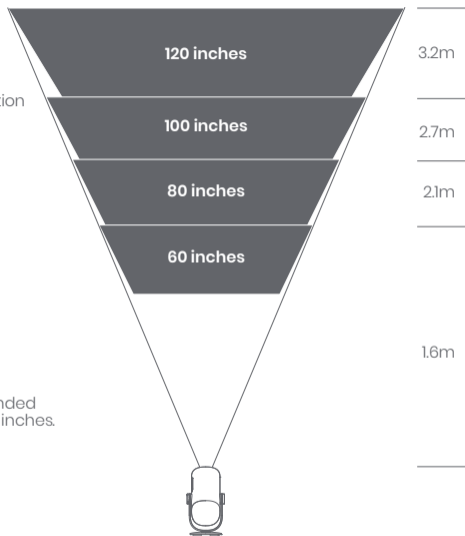

2. Power on (For first-time use, please fully charge your projector using the provided adapter.)

2.1 When Using the Adapter

- Connect the projector to the adapter and plug it into a power outlet.
- Press the power button on the projector or the remote control to turn it on.
- * Before pairing the remote control, the projector can only be turned on using the power button on the projector.

2.2 In Battery Mode (Unplugged)

- Press and hold the power button on the projector for 2 seconds to turn it on.
- * The power button on the remote control cannot be used to turn on the projector in battery mode.

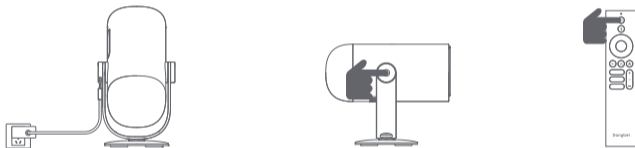

3. Standby Mode / Power off



3.1 When Using the Adapter

- Press the power button on the projector or the remote control to enter standby mode.
- Press and hold the power button on the projector or the remote control for 2 seconds to turn it off.

3.2 In Battery Mode (Unplugged)

- Press the power button on the projector or the remote control to turn it off.
- * Standby mode is not supported in battery mode.

4. Remote Control Pairing

- Turn on the projector and wait for the Bluetooth pairing prompt on the screen.
- Bring the remote control within 10 cm / 0.33 ft of the projector.
- Simultaneously press and hold the  and  keys.
- Release the keys after the indicator light starts flashing.
- Wait until you hear two "beep" sounds, indicating a successful pairing.

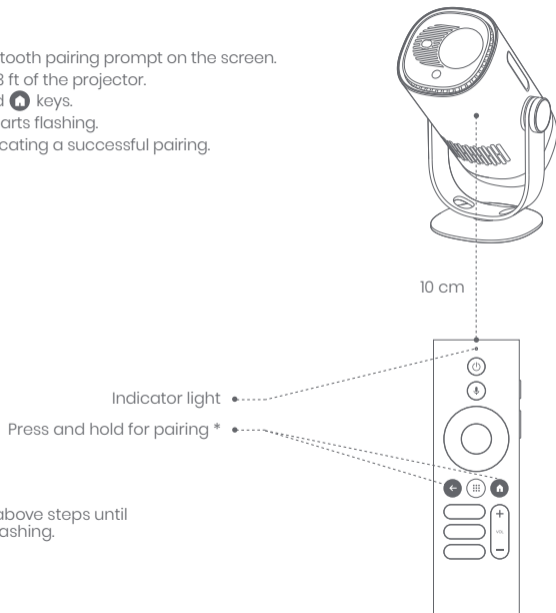

* If the pairing is unsuccessful, repeat the above steps until the remote control indicator light stops flashing.

Network Settings

- Go to [Settings], select [Network & Internet], and turn on Wi-Fi.
- Choose your network and enter the correct password.

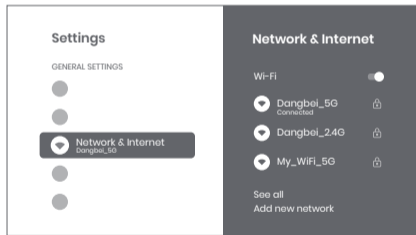

Focus Settings

Method 1: Press the red side key (up) for manual focus. Press and hold for 2 seconds for autofocus.

Method 2: Go to [Projector], select [Focus], and choose either manual focus or autofocus.

Autofocus

Select [Auto Focus] to trigger the autofocus function. The image will automatically become clear.

Manual focus

Select [Manual Focus] and use the navigation keys (up/down) on the remote control to adjust the focus distance and make the image clear.

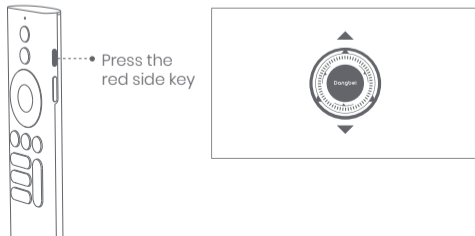
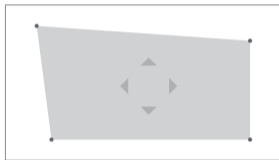

Image Correction Settings

1. Keystone Correction

- Go to [Projector] -- [Image Correction].
- Select [Auto Keystone Correction], and the screen will automatically be corrected.
- Select [Manual Keystone Correction], and use navigation keys to adjust the four points and the image shape.



2. Intelligent Screen Fit

- Go to [Projector] -- [Image Correction], and turn on [Fit to Screen].
- Follow the on-screen instructions to automatically adjust the projected image to fit the screen.
- This feature only supports 16:9 screens.

3. Intelligent Obstacle Avoidance

- Go to [Projector] -- [Image Correction] -- [Advanced], and turn on [Avoid Obstacles].
- Follow the on-screen instructions to automatically adjust the projected image to avoid any objects on the projection surface.

Bluetooth Speaker Mode

- Go to [Settings], select [Projector], and click on [Bluetooth speaker mode].
- Connect your phone to a device with the Bluetooth name containing "DBOD03". After modifying the device name, the Bluetooth name will also be synchronized accordingly.
- When you hear "Bluetooth connection successful", the projector can play music from your phone.
- Press and hold the  key on the remote control for 2 seconds to exit the [Bluetooth speaker mode].

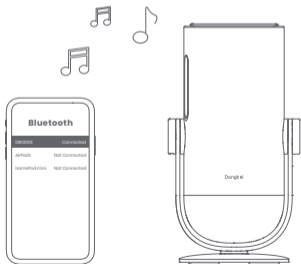

Battery Mode

- Unplug the power adapter.
- The projector will be powered by the built-in battery. The brightness will automatically switch to ECO mode to extend battery life.
* You can switch to other brightness modes, but this may affect battery life.

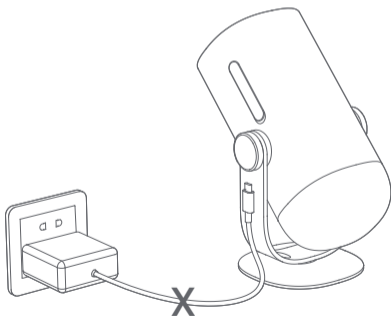

Charging with a Power Bank

- Unplug the power adapter.
- Use a USB-C power cable to connect the projector to a power bank.
- * Ensure the power bank supports PD3.0 65W, and the USB-C power cable supports PD 65W and E-mark.

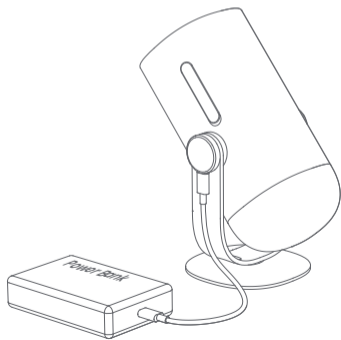

Google Assistant

Your TV is more helpful than ever. Use your voice to find movies, stream apps, play music and control the TV. Ask Google Assistant to find a specific title, search by genre, or get personalized recommendations. Even get answers on screen, control smart home devices, and more. Press the Google Assistant button on the remote to get started.

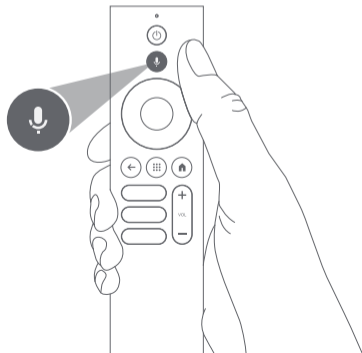

Google Cast™

Easily cast your favorite movies, music, and more to your TV with Google Cast.

To cast in-app content:

Simply tap the Cast button from apps you already know and love. No new logins or downloads required.

1. Connect your device and the projector to the same wireless network.
2. Open the streaming app on your device.
3. Play a video and tap the Cast button on the video screen. 
4. Select "DBOD03" to connect. The projector will display the video from your device.

* Due to copyright restrictions, certain content cannot be cast to the projector. You can stream the content on the projector by installing the same application on it.

Screen Mirroring

You can project the entire screen from your device to the projector.

To cast the device screen:

1. Ensure that both your device and the projector are connected to the same wireless network.
2. Install the AirScreen app on the projector.
3. Open the AirScreen app and follow the on-screen instructions to complete the process.

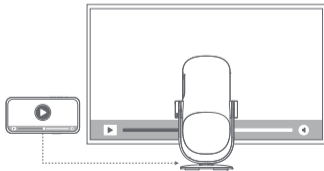

Inputs

HDMI

Insert the HDMI device into the HDMI port.
Press and hold the Home button on the remote control to open the quick settings menu from the right side of the screen.

Go to [Inputs] and select HDMI.

USB Drive

Download the File Explorer app from Google Play.
Insert a USB-A drive into the USB port.
Open the File Explorer app, find the USB drive, and select the content you want to watch.

* Supported USB formats: FAT32, NTFS

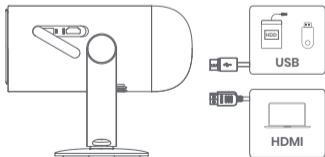

More Settings

1. Projection Mode

Go to [Settings] -- [Projector] -- [Advanced Settings] -- [Projection Mode] to choose the placement method of the projector.

2. Zoom

Go to [Settings] -- [Projector] -- [Image Correction] -- [Image Adaption] to decrease the image size from 100% to 50%.

3. System & Product Info

Go to [Settings] -- [System] -- [About] to check the System & Product information.

* To ensure a smooth system upgrade, please use the power adapter to supply power to prevent any issues caused by unexpected power failure.

Specifications

Display Technology	0.23 in, DLP	Bluetooth Version	5.1
Display Resolution	1920 x 1080	Wi-Fi	Dual Frequency 2.4/5.0 GHz
Throw Ratio	1.2 : 1	Dimensions (L x W x H)	131 x 109 x 239 mm 5.16 x 4.29 x 9.4 inches
Speaker	6W	Weight	1.4kg / 3.08lb

Troubleshooting

1. No audio output

- Check if you have double-clicked the black side key on the remote control to put the projector in mute mode.
- Check if the projector interface "HDMI 1 (eARC)" or Bluetooth is connected to an external audio device.

2. No image output

- Press the power button located on the rear of the projector. The power button indicator light will turn off if the projector enters projection mode successfully.
- Ensure that the power adaptor has power output.

3. No network

- Enter settings, and check the network connection status in the network option.
- Ensure that the network cable is correctly inserted to the projector interface "LAN".
- Ensure that the router is correctly configured.

4. Blurry Image

- Adjust the focus or keystone.
- The projector and screen/wall must be positioned with an effective distance.
- Projector lens is not clean.

5. Non-rectangular Image

- Place the projector perpendicular to the screen/wall if keystone correction function is not used.
- Use the keystone correction function to adjust the display.

6. Automatic keystone correction failed

- Ensure that the Camera/TOF on the front panel is not blocked or dirty.
- The best automatic keystone correction distance is 2.0-4.0m, horizontal $\pm 30^\circ$.

7. Autofocus failure

- a. Ensure that the Camera/TOF on the front panel is not blocked or dirty.
- b. The best autofocus distance is 2.0–3.5m, horizontal $\pm 20^\circ$.

8. Smart Eye Protection failed

- a. Ensure that the Camera/TOF on the front panel is not blocked or dirty
- b. The optimal sensing range is located around the center of the image. Being too close to the edges may result in the eye protection feature not triggering.

9. Intelligent Screen Fit failure

- a. Ensure that the projector is correctly positioned, so that the projected image extends beyond the edges of the screen.
- b. Ensure that the projection screen has a colored border/frame on all four sides, so that the projector can recognize the frame.
- c. Ensure that the red box pattern is within the screen frame, and is not blocked.

10. The Remote Control is unresponsive

- a. Ensure that the remote control is successfully paired via Bluetooth. If the pairing is successful, the LED light will flash once when you press any button. When you press and hold any button, the LED light will remain solid.
- b. If the pairing is unsuccessful, the LED light will flash three times when you press any button. When you press and hold any button, the LED light will flash three times and then remain solid.
- c. Check if the power indicator is still on without pressing any buttons. If it is, check the status of the remote control buttons to ensure they are not being pressed.
- d. Ensure that there are no interferences or obstructions between the projector and remote control.
- e. Check the battery and installation polarity.

11. How to connect other devices via Bluetooth

Go to Settings, and select [Remotes & Accessories] to pair with other Bluetooth devices.

12. Others

Please feel free to contact us at support@dangbei.com

Statement

Google TV is the name of this device's software experience and a trademark of Google LLC. Google, YouTube and Google Cast are trademarks of Google LLC.

This equipment has been tested and found to comply with the limits for a Class B digital device, pursuant to Part 15 of the FCC Rules. These limits are designed to provide reasonable protection against harmful interference in a residential installation.

This equipment generates uses and can radiate radio frequency energy and, if not installed and used in accordance with the instructions, may cause harmful interference to radio communications. However, there is no guarantee that interference will not occur in a particular installation. If this equipment does cause harmful interference to radio or television reception, which can be determined by turning the equipment off and on, the user is encouraged to try to correct the interference by one or more of the following measures:

- Reorient or relocate the receiving antenna.
- Increase the separation between the equipment and receiver.
- Connect the equipment to an outlet on a circuit different from that to which the receiver is connected.
- Consult the dealer or an experienced radio/TV technician for help.

Changes or modifications not expressly approved by the party responsible for compliance could void the user's authority to operate the equipment.

This device operating frequency: 2402-2480MHz (EIRP < 20dBm), 2412-2472MHz (EIRP < 20dBm), 5150-5250MHz (EIRP < 23dBm), 5250-5350MHz (EIRP < 20dBm), 5470-5725MHz (EIRP < 27dBm), 5725-5850MHz (EIRP < 13.98dBm).

 We declares that this device is in compliance with the essential requirements and other relevant provisions of Directive 2014/53/EU.

 Satisfies all the technical regulations applicable to the product within the scope of UK Radio Equipment Regulations (SI 2017/1206); UK Electrical Equipment (Safety) Regulations (SI 2016/1101); and UK Electromagnetic Compatibility Regulations (SI 2016/1091).

 Netflix is a trademark of Netflix, Inc.

 Manufactured under license from Dolby Laboratories. Dolby, Dolby Audio, and the double-D symbol are trademarks of Dolby Laboratories Licensing Corporation.

 The terms HDMI, HDMI High-Definition Multimedia Interface, HDMI Trade dress and the HDMI Logos are trademarks or registered trademarks of HDMI Licensing Administrator, Inc.

THIS DEVICE COMPLIES WITH DHHS RULES 21 CFR CHAPTER I SUBCHAPTER J.
CAN ICES-3 (B)/NMB-3 (B)

This Class B digital apparatus complies with Canadian ICES-003.

Cet appareil numérique de classe B est conforme à la norme canadienne ICES-003.

This device contains licence-exempt transmitter(s)/receiver(s) that comply with Innovation, Science and Economic Development Canada's licence-exempt RSS(s). Operation is subject to the following two conditions:

(1) This device may not cause interference.

(2) This device must accept any interference, including interference that may cause undesired operation of the device

L'émetteur/récepteur exempt de licence contenu dans le présent appareil est conforme aux CNR d'Innovation, Sciences et Développement économique Canada applicables aux appareils radio exempts de licence. L'exploitation est autorisée aux deux conditions suivantes :

1.L'appareil ne doit pas produire de brouillage;

2.L'appareil doit accepter tout brouillage radioélectrique subi, même si le brouillage est susceptible d'en compromettre le fonctionnement.

For projectors only

The distance between user and products should be no less than 20cm.

La distance entre l'utilisateur et le produit ne doit pas être inférieure à 20 cm.

5150-5350MHz band is restricted to indoor use only.

La bande de 5150-5350MHz est réservée à l'usage intérieur.



WARNING: This product can expose you to Lead, which is known to the State of California to cause cancer and birth defects or other reproductive harm. For more information go to www.P65Warnings.ca.gov



OST_UK_20220817000004

EVATOST CONSULTING LTD

Office 101 32 Threadneedle Street, London,
United Kingdom, EC2R 8AY
contact@evatmaster.com

We simply act as UK representative for cross-border sellers, and are not manufacturers/importers/distributors for the product, nor involved in the manufacture/import/sale of the product. Therefore, we are not responsible for any after-sales services related to the product. In case of any product quality or infringement issues, the manufacturer/importer/seller shall be solely held responsible.



OST_UK_202208170000037

eVatmaster Consulting GmbH

Bettinaser.30
60325 Frankfurt am Main, Germany
contact@evatmaster.com

We simply act as EU representative for cross-border sellers, and are not manufacturers/importers/distributors for the product, nor involved in the manufacture/import/sale of the product. Therefore, we are not responsible for any after-sales services related to the product. In case of any product quality or infringement issues, the manufacturer/importer/seller shall be solely held responsible.

EU DECLARATION OF CONFORMITY



Product : Portable Projector

Trademark : Dangbei

Model Designation : DBOD03

Manufacturer's Name : Shenzhen Dangs Science and Technology Co., Ltd.

Manufacturer's Address : 901, GDC Building, Gaoxin Mid 3rd Road, Maling Community, Yuehai Sub-district, Nanshan District, Shenzhen, China.

Manufacturer's Phone : 86-755-26907499

We, Shenzhen Dangs Science and Technology Co., Ltd. declare under our sole responsibility that the above referenced product is in conformity with the applicable requirements of the following directives:

RED Directive : 2014/53/EU

RoHS Directive : 2011/65/EU

(EU) 2015/863

WEEE Directive : 2012/19/EU

REACH Regulation : 2006/1907/EC

Conformity with these directives has been assessed for the product by demonstrating compliance to the following harmonized standards and/or regulations:

EN 62311:2008

EN IEC 62368-1:2020+A11:2020

EN 301489-1 V2.2.3 (2019-11)

EN 301489-3 V2.3.2 (2023-01)

EN 301489-17 V3.2.4 (2020-09)

EN 55032:2015+A11:2020

EN 55035:2017+A11:2020

EN 61000-3-2:2019+A1:2021

EN 61000-3-3:2013+A2:2021

EN 301893 V2.1.1 (2017-05)

EN 300440 V2.1.1 (2017-03)

EN 300328 V2.2.2 (2019-07)

2011/65/EU, (EU) 2015/863

2006/1907/EC

2012/19/EU

Signed for and on behalf of: Shenzhen Dangs Science and Technology Co., Ltd.

Place: Shenzhen, China

Date: 2024-02-07

Name: Libing Zhang

Position: Certification Engineer

Signature:

Libing Zhang

UKCA DECLARATION OF CONFORMITY

Product : Portable Projector

Trademark : Dangbei

Model Designation : DBOD03

Manufacturer's Name : Shenzhen Dangs Science and Technology Co., Ltd.

Manufacturer's Address : 901, GDC Building, Gaoxin Mid 3rd Road, Maling Community, Yuehai Sub-district, Nanshan District, Shenzhen, China.

Manufacturer's Phone : 86-755-26907499

We, Shenzhen Dangs Science and Technology Co., Ltd. declare under our sole responsibility that the above referenced product is in conformity with the applicable requirements of the following directives:

RoHS Directive : SI 2022 No.622

REACH Directive : SI 2019 No.758

RED Directive : SI 2017 No.1206

PSTI Directive : SI 2023 No.1007

Conformity with these directives has been assessed for the product by demonstrating compliance to the following harmonized standards and/or regulations:

BS EN IEC 62311:2008

ETSI EN 301489-3 V2.3.2 (2023-01)

BS EN 55035:2017+A11:2020

ETSI EN 301893 V2.1.1 (2017-05)

SI 2022 No.622

ISO/IEC 29147:2018

BS EN IEC 62368-1:2020+A11:2020

ETSI EN 301489-17 V3.2.4 (2020-09)

BS EN 61000-3-2:2019+A1:2021

ETSI EN 300440 V2.1.1 (2017-03)

SI 2019 No.758 and its amendment (UK REACH)

ETSI EN 301489-1 V2.2.3 (2019-11)

BS EN 55032:2015+A11:2020

BS EN 61000-3-3:2013+A2:2021

ETSI EN 300328 V2.2.2 (2019-07)

EI SI EN 303 645 V2.1.1 (2020-06)

Signed for and on behalf of: Shenzhen Dangs Science and Technology Co., Ltd.

Place : Shenzhen, China

Date : 2024-02-07

Name : Libing Zhang

Position : Certification Engineer

Signature : 

Sprache

English	01-24
Deutsch	25-48
Français	49-72
Italiano	73-96
Español	97-120
日本語	121-143

Inhalt

Vor gebrauch lesen	26
Wichtige Vorsichtsmaßnahmen	27
Lieferumfang	28
Projektorübersicht	29
Anleitung zur LED-Anzeige der Ein-/Austaste	31
Überblick über die Fernbedienung	33
Erste Schritte	34
Netzwerkeinstellungen	37
Einstellung des Fokus	37
Bildkorrektureinstellungen	38
Bluetooth-Lautsprechermodus	39
Akkumodus	39
Mit Powerbank aufladen	40
Google Assistant	40
Google Cast™	41
Bildschirmspiegelung	41
Eingangsquellen	42
Weitere Einstellungen	42
Technische Daten	43
Fehlersuche	44
Erklärung	46

Vor gebrauch lesen

Bitte lesen Sie die Produktanweisungen sorgfältig durch:

Wir danken Ihnen für den Kauf und die Verwendung unserer Produkte.

Für Ihre Sicherheit und zu Ihrer Information, lesen Sie bitte die Anleitung sorgfältig durch, bevor Sie das Produkt verwenden.

Über die Produktanweisungen:

Alle in den Produktanweisungen erwähnten Marken und Namen sind Eigentum der jeweiligen Inhaber.

Alle abgebildeten Produktabbildungen dienen nur zu Illustrationszwecken. Das tatsächliche Produkt kann aufgrund von Produktverbesserungen abweichen.

Wir haften nicht für Personen-, Sach- oder sonstige Schäden, die durch die Nichtbeachtung der Produktanweisungen bzw. Vorsichtsmaßnahmen seitens des Benutzers verursacht werden.

* Dangbei behält sich das Recht zur Auslegung und Änderung der Produktanweisungen vor.

Wichtige Vorsichtsmaßnahmen



- Wie bei jeder hellen Lichtquelle sollte man nicht direkt in den Strahl sehen, RG2 IEC 62471-5:2015.
 - Benutzer sind sich der Gefahr von Haut- oder Hornhautverbrennungen bewusst. LASERPRODUKT DER KLASSE 1, entspricht IEC 60825-1:2014.
 - Blockieren oder decken Sie nicht die Wärmeabgabeöffnungen des Geräts ab, um die Wärmeabführung der internen Teile nicht zu beeinträchtigen und das Gerät nicht zu beschädigen.
 - Halten Sie das Gerät vor Feuchtigkeit, hohen Temperaturen, niedrigem Druck und magnetischen Umgebungen fern.
 - Stellen Sie das Gerät nicht an Orten auf, die anfällig für eine übermäßige Staub- und Schmutzansammlung sind.
 - Stellen Sie das Gerät auf einer ebenen und stabilen Fläche auf und nicht auf einer Oberfläche, die zu Vibrationen neigt.
 - Erlauben Sie Kindern nicht, das Gerät unbeaufsichtigt zu benutzen.
 - Stellen Sie keine schweren oder scharfen Gegenstände auf das Gerät.
 - Vermeiden Sie extreme Erschütterungen, da diese die internen Komponenten beschädigen könnten.
 - Bitte verwenden Sie den richtigen Batterietyp für die Fernbedienung.
 - Verwenden Sie nur vom Hersteller angegebenes oder mitgeliefertes Zubehör (z. B. das exklusive Netzteil, die Halterung usw.).
 - Das Gerät darf nicht zerlegt werden. Das Gerät darf nur durch vom Hersteller autorisiertes Personal repariert werden.
 - Betreiben Sie das Gerät in einer Betriebsumgebung von 5–35°C.
 - Das Metallgehäuse ist mit isolierender Farbe beschichtet.
 - Der Stecker wird als ein vom Netzteil getrenntes Gerät betrachtet.
 - Das Netzteil muss sich in der Nähe des Geräts befinden und leicht zugänglich sein.
 - Zum Schutz des Netzkabels, positionieren Sie es nicht in einer Weise, dass darauf getreten oder es eingeklemmt werden kann, insbesondere an den Steckern, den Steckdosen und an der Geräteaustrittsstelle.
 - Trennen Sie das Gerät bei einem Gewitter oder längerer Nichtbenutzung vom Stromnetz ab.
 - Falls die Steckdose oder eine Gerätesteckvorrichtung zum Abtrennen des Geräts verwendet wird, sollten Sie sicherstellen, dass Sie jederzeit auf den Stecker zugreifen können.
 - Fassen Sie das Netzkabel oder den Netzstecker niemals mit nassen Händen an.
 - Explosionsgefahr, wenn die Batterie durch einen falschen Typ ersetzt wird.
- Entsorgen Sie verbrauchte Batterien gemäß den örtlichen Vorschriften.

Lieferumfang

Before using this product, please check that all items are included in the box.

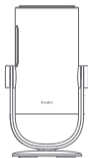

Projektor



Fernbedienung



AAA-Batterien

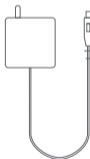

Netzteil

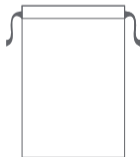

Tragetasche



Bedienungsanleitung

Projektorübersicht

Übersicht und Schnittstellenbeschreibung.

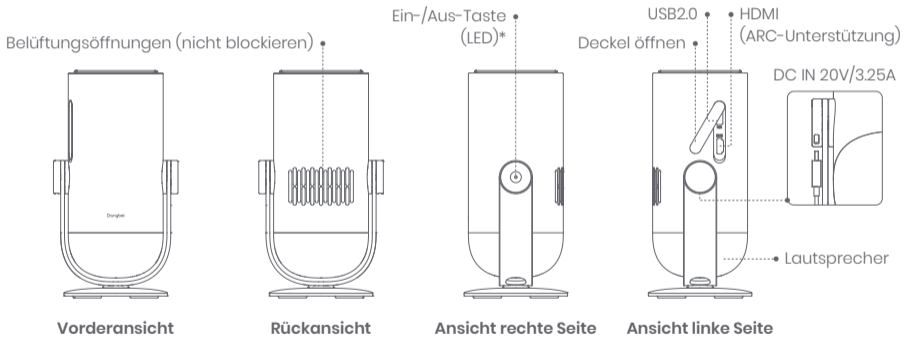

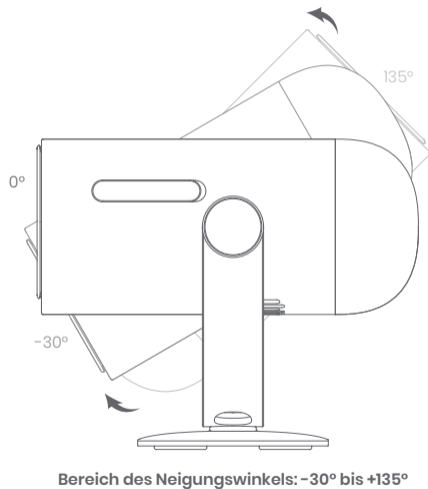
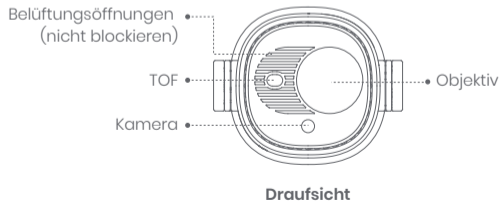
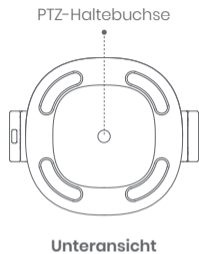

Anleitung zur LED-Anzeige der Ein-/Austaste

Szenario		Gerätstatus	Akkukapazität	LED-Anzeige
Projektionsmodus	Mit Netzteil aufladen	Bereitschaftsmodus	=100%	Weiß: Pulsiert
			=70 bis 99%	Grün: Blinkt
			=20 bis 69%	Orange: Blinkt
			≤19%	Rot: Blinkt
		Ausschalten	=100%	Aus
			=70 bis 99%	Grün: Blinkt
			=20 bis 69%	Orange: Blinkt
			≤19%	Rot: Blinkt
		Einschalten	=100%	Weiß: Leuchtet
			=70 bis 99%	
			=20 bis 69%	
			≤19%	

Szenario		Gerätestatus	Akkukapazität	LED-Anzeige
Projektionsmodus	Akkumodus (wenn getrennt)	Ausschalten	=100%	Aus
			=70 bis 99%	Aus
			=20% bis 69%	Aus
			≤19%	Aus
		Einschalten	=100%	Aus
			=70 bis 99%	Grün: Leuchtet
			=20% bis 69%	Orange: Leuchtet
			≤19%	Rot: Blinkt
	Akkukapazität prüfen (Ein-/Austaste am Projektor kurz drücken; nur im Akkumodus)	Ausschalten	=70 bis 100%	Grün: leuchtet einmal pro Druck
			=20% bis 69%	Orange: leuchtet einmal pro Druck
≤19%			Rot: leuchtet einmal pro Druck	
Bluetooth-Audiomodus	Switching to Bluetooth speaker mode	Nicht zutreffend	Blau: Pulsiert	
	Waiting for pairing	Nicht zutreffend	Blau: Pulsiert	
	Connected successfully	Nicht zutreffend	Blau: Leuchtet	
	Switching to projection mode	Nicht zutreffend	Referenz zu LED-Anzeige im Projektionsmodus	

Überblick über die Fernbedienung

- Öffnen Sie die Abdeckung des Batteriefachs an der Fernbedienung.
- Legen Sie 2 AAA-Batterien ein *.
- Schließen Sie die Abdeckung des Batteriefachs wieder.

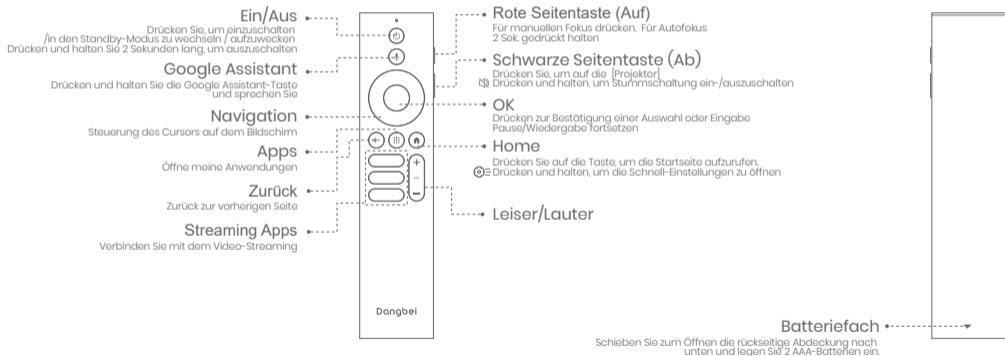

* Bitte legen Sie neue Batterien entsprechend der Polaritätskennzeichnung ein.

Erste Schritte

1. Aufstellung

Stellen Sie den Projektor auf eine stabile, ebene Fläche vor der Projektionsfläche. Es wird eine glatte, weiße Projektionsfläche empfohlen. Bitte befolgen Sie die nachstehenden Anweisungen zur Bestimmung des Abstands zwischen Projektor und Projektionsfläche sowie der entsprechenden Projektionsgröße:

Größe	Bildfläche (Länge x Breite)
60 Zoll	133 x 75 cm 4.36x2.46 ft
80 Zoll	177 x 100 cm 5.8x 3.28 ft
100 Zoll	221 x 124 cm 7.25 x 4.06 ft
120 Zoll	265 x 149 cm 8.69 x 4.88 ft



Die beste empfohlene Projektionsgröße ist 100 Zoll.

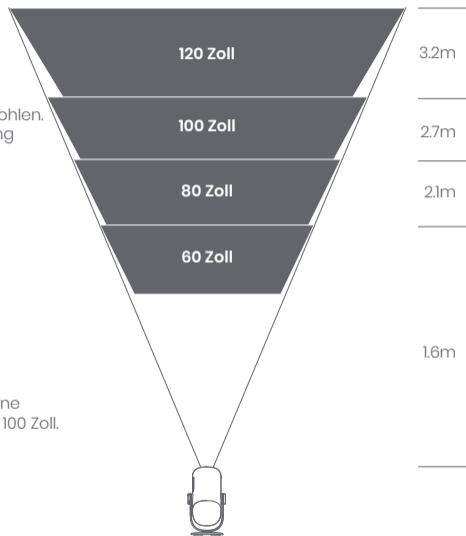

2. Einschalten (Laden Sie den Projektor bei der ersten Benutzung mit dem mitgelieferten Netzteil vollständig auf.)

2.1 Wenn das Netzteil eingesteckt wird

- Schließen Sie das Netzteil des Projektors an die Steckdose an.
- Drücken Sie zum Einschalten die Ein-/Austaste am Projektorgehäuse oder an der Fernbedienung.
- * Vor der Kopplung der Fernbedienung kann er nur über die Ein-/Austaste am Projektorgehäuse eingeschaltet werden.

2.2 Akkumodus (wenn getrennt)

- Halten Sie die Ein-/Austaste am Projektorgehäuse zum Einschalten 2 Sekunden lang gedrückt.
- * Akkumodus unterstützt keine Einschaltung über die Ein-/Austaste an der Fernbedienung.

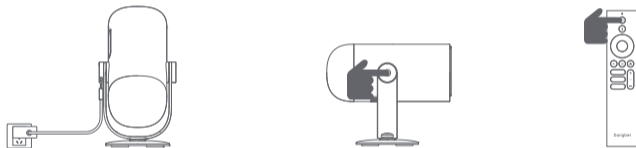

3. Standby-Modus / Ausschalten



3.1 Wenn das Netzteil eingesteckt wird

- Drücken Sie zum Aufrufen des Bereitschaftsmodus die Ein-/Austaste am Projektor oder an der Fernbedienung.
- Halten Sie die Ein-/Austaste am Projektorgehäuse oder an der Fernbedienung zum Ausschalten 2 Sekunden lang gedrückt.

3.2 Akkumodus (wenn getrennt)

- Drücken Sie zum Einschalten die Ein-/Austaste am Projektorgehäuse oder an der Fernbedienung.
- * Akkumodus unterstützt Bereitschaftsmodus nicht.

4. Kopplung mit der Fernbedienung

- Schalten Sie den Projektor ein und warten Sie auf die Aufforderung zur Bluetooth-Kopplung auf dem Bildschirm.
- Halten Sie die Fernbedienung in einer Entfernung von 10 cm / 0,33 ft zum Projektor.
- Halten Sie gleichzeitig die Tasten  und  gedrückt.
- Lassen Sie die Tasten los, wenn die Kontrollanzeige zu blinken beginnt.
- Warten Sie, bis zwei "Pieptöne" zur Bestätigung der erfolgreichen Kopplung ausgegeben werden.

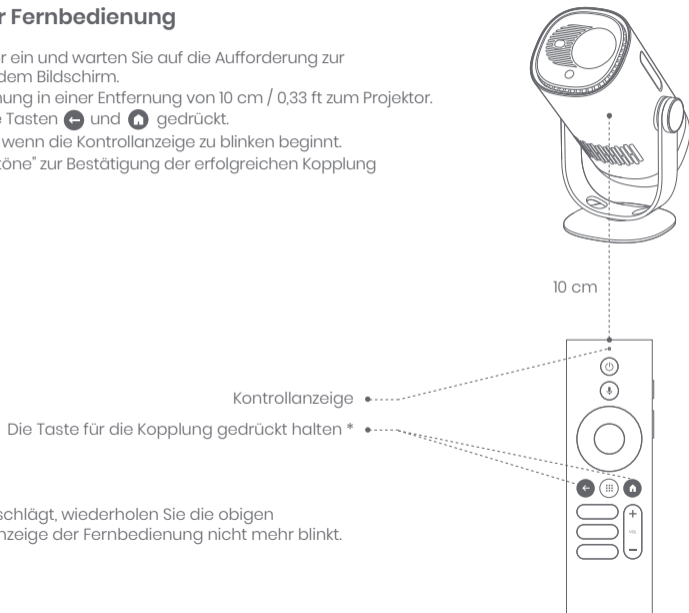

* Wenn die Kopplung fehlschlägt, wiederholen Sie die obigen Schritte, bis die Kontrollanzeige der Fernbedienung nicht mehr blinkt.

Netzwerkeinstellungen

- Gehen Sie auf [Einstellungen], wählen Sie [Netzwerk & Internet], und schalten Sie das WLAN ein.
- Wählen Sie Ihr Netzwerk aus und geben Sie das richtige Passwort ein.

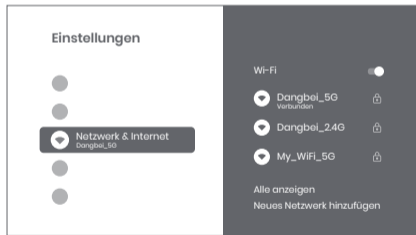

Einstellung des Fokus

Method 1: Drücken Sie für den manuellen Fokus die rote Seitentaste (Auf). Halten Sie für den Autofokus die Taste für 2 Sek. gedrückt.

Method 2: Gehen Sie auf [Projektor], wählen Sie [Fokus], und wählen Sie entweder manuellen Fokus oder Autofokus.

Autofocus

Wählen Sie [Autofokus], um die Autofokusfunktion zu aktivieren. Das Bild wird automatisch scharf gestellt.

Manual focus

Wählen Sie [Manueller Fokus] und verwenden Sie die Navigationstasten (Auf/Ab) der Fernbedienung, um den Fokusabstand zu regulieren und das Bild scharf zu stellen.



Bildkorrektureinstellungen

1. Trapezkorrektur

- Gehen Sie auf [Projektor] -- [Bildkorrektur].
- Wählen Sie [Automatische Trapezkorrektur], und der Bildschirm wird automatisch korrigiert.
- Wählen Sie [Manuelle Trapezkorrektur], und verwenden Sie die Navigations-Tasten, um die vier Punkte und die Bildform anzupassen.



2. Intelligente Bildgrößenanpassung

- Gehen Sie auf [Projektor] -- [Bildkorrektur] und aktivieren Sie [An Projektionsfläche anpassen].
- Follow the on-screen instructions to automatically adjust the projected image to fit the screen.
- Diese Funktion unterstützt nur 16:9-Leinwände. Diese Funktion unterstützt nur 16:9-Leinwände.

3. Intelligente Hindernisvermeidung

- Gehen Sie auf [Projektor] -- [Image Correction] -- [Erweitert] und aktivieren Sie [Hindernisvermeidung].
- Befolgen Sie die Anweisungen auf der Projektionsfläche, um das projizierte Bild automatisch so anzupassen, dass Objekte auf der Projektionsfläche gemieden werden.

Bluetooth-Lautsprechermodus

- Gehen Sie auf [Einstellungen], wählen Sie [Projektor] und klicken Sie auf [Bluetooth-Lautsprechermodus].
- Verbinden Sie Ihr Handy mit dem Gerät mit Bluetooth-Namen "DBOD03". Nachdem Sie den Gerätenamen geändert haben, wird auch der Bluetooth-Name entsprechend synchronisiert.
- Wenn Sie "Bluetooth-Verbindung erfolgreich" hören, kann der Projektor Musik von Ihrem Handy wiedergeben.
- Halten Sie die -Taste auf der Fernbedienung für 2 Sek. gedrückt, um den [Bluetooth-Lautsprechermodus] zu beenden.

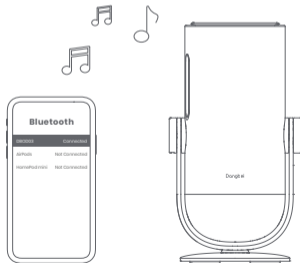

Akkumodus

- Trennen Sie das Netzteil.
- Der Projektor wird über einen integrierte Akku mit Strom versorgt. Die Projektorhelligkeit wechselt automatisch in den Energiesparmodus, was die Laufzeit verlängert.
- * Der Akkumodus unterstützt die Anpassung anderer Helligkeitsmodus-Optionen, beeinträchtigt jedoch die Laufzeit.

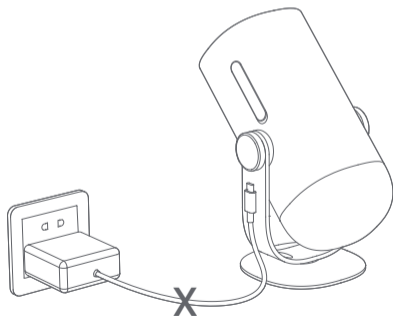

Mit Powerbank aufladen

- Trennen Sie das Netzteil.
 - Schließen Sie den Projektor über ein USB-C-Stromkabel an die Powerbank an.
- * Stellen Sie sicher, dass die Powerbank PD3.0 65 W und das USB-C-Netzkabel PD 65 W und E-Mark unterstützt.

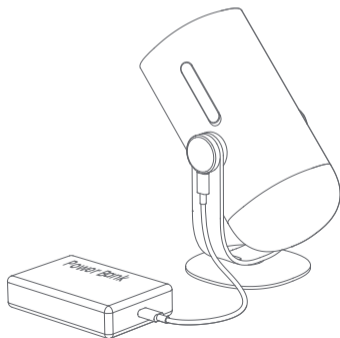

Google Assistant

Ihr Fernseher ist jetzt noch hilfreicher. Nutzen Sie Ihre Stimme, um Filme zu finden, Apps zu streamen, Musik abzuspielen und den Fernseher zu steuern. Fragen Sie den Google Assistant nach einem bestimmten Titel, suchen Sie nach Genre oder erhalten Sie personalisierte Empfehlungen. Sie können sogar Antworten auf dem Bildschirm erhalten, Smart-Home-Geräte steuern und vieles mehr. Drücken Sie die Google Assistant-Taste auf der Fernbedienung und legen Sie los.

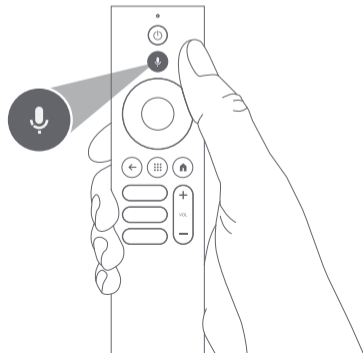

Google Cast™

Übertragen Sie ganz einfach Ihre Lieblingsfilme, Musik und mehr auf Ihren Fernseher mit Google Cast.

Um Inhalte aus der App zu übertragen :

Tippen Sie einfach auf die Cast-Schaltfläche in den Apps, die Sie bereits kennen und mögen. Keine neuen Anmeldungen oder Downloads erforderlich.

1. Verbinden Sie Ihr Gerät und den Projektor mit demselben drahtlosen Netzwerk.
 2. Öffnen Sie die Streaming-App auf Ihrem Gerät.
 3. Spielen Sie ein Video ab und tippen Sie auf dem Videobildschirm auf die Schaltfläche "Cast". 
 4. Wählen Sie "DBOD03" aus, um eine Verbindung herzustellen. Der Projektor zeigt das Video von Ihrem Gerät an.
- * Aufgrund von Urheberrechtsbeschränkungen kann bestimmter Inhalt nicht auf den Projektor übertragen werden. Sie können den Inhalt auf dem Projektor streamen, indem Sie dieselbe Anwendung darauf installieren.

Bildschirmspiegelung

Sie können den gesamten Bildschirm von Ihrem Gerät auf den Projektor projizieren.

Um den Bildschirm des Geräts zu übertragen :

1. Stellen Sie sicher, dass sowohl Ihr Gerät als auch der Projektor mit demselben drahtlosen Netzwerk verbunden sind.
2. Installieren Sie die AirScreen-App auf dem Projektor.
3. Öffnen Sie die AirScreen-App und befolgen Sie die Anweisungen auf dem Bildschirm, um den Vorgang abzuschließen.

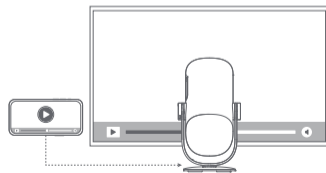

Eingangsquelle

HDMI

Schließen Sie das HDMI-Gerät an den HDMI-Anschluss an.
Halten Sie zum Einblenden des Bedienfelds rechts oben die Startseite-Taste der Fernbedienung gedrückt.
Rufen Sie [Eingänge] auf und wählen Sie HDMI.

USB-Datenträger

Laden Sie die App Dateimanager von Google Play herunter.
Stecken Sie das USB-A-Laufwerk in den USB-Anschluss.
Öffnen Sie die App Dateimanager, suchen Sie nach dem USB-Stick und wählen Sie den Inhalt, den Sie öffnen möchten.
* Unterstützte USB-Formate: FAT32, NTFS.

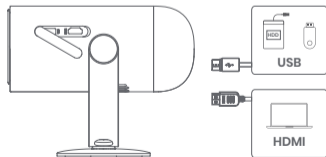

Weitere Einstellungen

1. Projektionsmodus

Gehen Sie auf [Einstellungen] -- [Projektor] -- [Erweiterte Einstellungen] -- [Projektionsmodus], um die Aufstellungsmethode des Projektors auszuwählen.

2. Zoom

Gehen Sie auf [Einstellungen] -- [Projektor] -- [Bildkorrektur] -- [Bildanpassung] -- [Zoom], um die Bildgröße von 100% auf 50% zu verringern.

3. System- und Produktinformationen

Gehen Sie auf [Einstellungen] -- [System] -- [Info], um die System- und Produktinformationen zu prüfen.

* Um ein reibungsloses Upgrade zu gewährleisten, verwenden Sie bitte das Netzteil, um Probleme durch unerwarteten Stromausfall zu vermeiden.

Technische Daten

Display-Technologie	0.23 Zoll, DLP	Bluetooth-Version	5.1
Bildauflösung	1920 x 1080	Wi-Fi	Doppelfrequenz 2.4/5.0 GHz
Projektionsverhältnis	1.2 : 1	Abmessungen (L x B x H)	131 x 109 x 239 mm 5.16 x 4.29 x 9.4 Zoll
Lautsprecher	6W	Gewicht	1.4kg / 3.08lb

Fehlersuche

1. Keine Audioausgabe

- Überprüfen Sie, ob Sie die schwarze Seitentaste auf der Fernbedienung doppelt gedrückt haben, da dadurch der Projektor stummgeschaltet werden kann.
- Prüfen Sie, ob die Projektorschnittstelle "HDMI 1 (eARC)" oder das Bluetooth mit einem externen Audiogerät verbunden ist.

2. Keine Bildausgabe

- Drücken Sie die Ein-/Aus-Taste auf der Rückseite des Projektors. Die Anzeigeleuchte der Ein-/Aus-Taste erlischt, wenn der Projektor erfolgreich in den Projektionsmodus wechselt.
- Vergewissern Sie sich, dass das Netzteil Strom ausgibt.

3. Kein Netzwerk

- Rufen Sie die Einstellungen auf und überprüfen Sie den Netzwerkverbindungsstatus unter der Option Netzwerk.
- Achten Sie darauf, dass das Netzkabel ordnungsgemäß an der Projektorschnittstelle "LAN" angeschlossen ist.
- Stellen Sie sicher, dass der Router ordnungsgemäß konfiguriert ist.

4. Verschwommenes Bild

- Nehmen Sie Einstellungen für den Fokus bzw. die Trapezkorrektur vor.
- Der Projektor und die Leinwand/Wand müssen sich in einem ordnungsgemäßen Abstand zueinander befinden.
- Das Objektiv des Projektors ist nicht sauber.

5. Nicht rechtwinkliges Bild

- Falls die Trapezkorrekturfunktion nicht verwendet wird, stellen Sie den Projektor senkrecht zur Leinwand/Wand auf.
- Verwenden Sie die Funktion Trapezkorrektur zur Anpassung der Bildfläche.

6. Automatische Trapezkorrektur schlägt fehl

- Vergewissern Sie sich, dass die Kamera/TOF an der Vorderseite nicht blockiert oder verschmutzt ist.
- Der beste Abstand für die automatische Trapezkorrektur beträgt 2,0–4,0m, horizontal $\pm 30^\circ$.

7. Autofokus-Fehler

- Stellen Sie sicher, dass die Kamera/TOF an der Vorderseite nicht blockiert oder verschmutzt ist.
- Die beste Entfernung für die Funktion Autofokus beträgt 2,0–3,5m, horizontal $\pm 20^\circ$.

8. Fehler intelligenter Augenschutz

- Stellen Sie sicher, dass die Kamera/TOF an der Vorderseite nicht blockiert oder verschmutzt ist.
- Der optimale Erfassungsbereich befindet sich in der Bildmitte. Falls Sie sich zu nahe am Bildrand befinden, könnte die Augenschutzfunktion möglicherweise nicht ausgelöst werden.

9. Fehler bei der intelligenten Bildgrößenanpassung

- Achten Sie darauf, dass der Projektor richtig aufgestellt ist, so dass das projizierte Bild über die Kanten der Projektionsfläche hinausreicht.
- Stellen Sie sicher, dass die Projektionsfläche an allen vier Seiten einen farbigen Rand/Rahmen hat, damit der Projektor den Rahmen erkennen kann.
- Vergewissern Sie sich, dass sich das rote Kastenmuster innerhalb der Projektionsfläche befindet und nicht blockiert wird.

10. Die Fernbedienung reagiert nicht

- Stellen Sie sicher, dass die Fernbedienung erfolgreich über Bluetooth gekoppelt ist. Bei erfolgreicher Kopplung blinkt die LED-Anzeige einmal, wenn Sie eine beliebige Taste drücken. Beim Gedrückthalten einer beliebigen Taste, leuchtet die LED-Anzeige konstant.
- Bei einer fehlgeschlagenen Kopplung, blinkt die LED-Anzeige dreimal, sobald Sie eine beliebige Taste drücken. Beim Gedrückthalten einer beliebigen Taste, blinkt die LED-Leuchte dreimal und leuchtet daraufhin konstant.
- Überprüfen Sie, ob die Betriebsanzeige eingeschaltet bleibt, ohne dass Sie irgendwelche Tasten drücken. Wenn dies der Fall ist, prüfen Sie, ob Tasten auf der Fernbedienung blockiert sind.
- Achten Sie darauf, dass sich keine Störquellen oder Hindernisse zwischen dem Projektor und der Fernbedienung befinden.
- Überprüfen Sie die Batterieleistung sowie die Polarität der eingelegten Batterien.

11. Wie stelle ich über Bluetooth eine Verbindung zu anderen Geräten her

Geben Sie die Einstellungen ein und öffnen Sie [ernbedienungen&Zubehör], um weitere Bluetooth-Geräte zu koppeln.

12. Sonstiges

Bitte kontaktieren Sie uns unter support@dangbei.com

Erklärung

Google TV ist der Name der Benutzeroberfläche dieses Geräts und eine Marke von Google LLC. Google, YouTube und Google Cast sind Marken von Google LLC.

This equipment has been tested and found to comply with the limits for a Class B digital device, pursuant to Part 15 of the FCC Rules. These limits are designed to provide reasonable protection against harmful interference in a residential installation.

This equipment generates uses and can radiate radio frequency energy and, if not installed and used in accordance with the instructions, may cause harmful interference to radio communications. However, there is no guarantee that interference will not occur in a particular installation. If this equipment does cause harmful interference to radio or television reception, which can be determined by turning the equipment off and on, the user is encouraged to try to correct the interference by one or more of the following measures:

- Reorient or relocate the receiving antenna.
- Increase the separation between the equipment and receiver.
- Connect the equipment to an outlet on a circuit different from that to which the receiver is connected.
- Consult the dealer or an experienced radio/TV technician for help.

Changes or modifications not expressly approved by the party responsible for compliance could void the user's authority to operate the equipment.

This device operating frequency: 2402-2480MHz (EIRP < 20dBm), 2412-2472MHz (EIRP < 20dBm), 5150-5250MHz (EIRP < 23dBm), 5250-5350MHz (EIRP < 20dBm), 5470-5725MHz (EIRP < 27dBm), 5725-5850MHz (EIRP < 13.98dBm).

CE We declares that this device is in compliance with the essential requirements and other relevant provisions of Directive 2014/53/EU.

UK CA Satisfies all the technical regulations applicable to the product within the scope of UK Radio Equipment Regulations (SI 2017/1206); UK Electrical Equipment (Safety) Regulations (SI 2016/1101); and UK Electromagnetic Compatibility Regulations (SI 2016/1091).

NETFLIX Netflix is a trademark of Netflix, Inc.

Dolby Audio In Lizenz von Dolby Laboratories gefertigt. Dolby, Dolby Audio und das Doppel-D-Symbol sind eingetragene Marken der Dolby Laboratories Licensing Corporation.

HDMI Die Begriffe HDMI, HDMI High-Definition Multimedia Interface, HDMI-Aufmachung (HDMI Trade Dress) und die HDMI-Logos sind Marken oder eingetragene Marken von HDMI Licensing Administrator, Inc.

THIS DEVICE COMPLIES WITH DHHS RULES 21 CFR CHAPTER I SUBCHAPTER J.
CAN ICES-3 (B)/NMB-3 (B)

This Class B digital apparatus complies with Canadian ICES-003.

Cet appareil numérique de classe B est conforme à la norme canadienne ICES-003.

This device contains licence-exempt transmitter(s)/receiver(s) that comply with Innovation, Science and Economic Development Canada's licence-exempt RSS(s). Operation is subject to the following two conditions:

(1) This device may not cause interference.

(2) This device must accept any interference, including interference that may cause undesired operation of the device

L'émetteur/récepteur exempt de licence contenu dans le présent appareil est conforme aux CNR d'Innovation, Sciences et Développement économique Canada applicables aux appareils radio exempts de licence. L'exploitation est autorisée aux deux conditions suivantes :

1.L'appareil ne doit pas produire de brouillage;

2.L'appareil doit accepter tout brouillage radioélectrique subi, même si le brouillage est susceptible d'en compromettre le fonctionnement.

For projectors only

The distance between user and products should be no less than 20cm.

La distance entre l'utilisateur et le produit ne doit pas être inférieure à 20 cm.

5150-5350MHz band is restricted to indoor use only.

La bande de 5150-5350MHz est réservée à l'usage intérieur.



WARNING: This product can expose you to Lead, which is known to the State of California to cause cancer and birth defects or other reproductive harm. For more information go to www.P65Warnings.ca.gov



OST_UK_20220817000004

EVATOST CONSULTING LTD

Office 101 32 Threadneedle Street, London,
United Kingdom, EC2R 8AY
contact@evatmaster.com

We simply act as UK representative for cross-border sellers, and are not manufacturers/importers/distributors for the product, nor involved in the manufacture/import/sale of the product. Therefore, we are not responsible for any after-sales services related to the product. In case of any product quality or infringement issues, the manufacturer/importer/seller shall be solely held responsible.



OST_UK_20220817000007

eVatmaster Consulting GmbH

Bettlinaser.30
60325 Frankfurt am Main, Germany
contact@evatmaster.com

We simply act as EU representative for cross-border sellers, and are not manufacturers/importers/distributors for the product, nor involved in the manufacture/import/sale of the product. Therefore, we are not responsible for any after-sales services related to the product. In case of any product quality or infringement issues, the manufacturer/importer/seller shall be solely held responsible.



EU DECLARATION OF CONFORMITY

Product : Portable Projector

Trademark : Dangbei

Model Designation : DBOD03

Manufacturer's Name : Shenzhen Dangs Science and Technology Co., Ltd.

Manufacturer's Address : 901, GDC Building, Gaoxin Mid 3rd Road, Maling Community, Yuehai Sub-district, Nanshan District, Shenzhen, China.

Manufacturer's Phone : 86-755-26907499

We, Shenzhen Dangs Science and Technology Co., Ltd. declare under our sole responsibility that the above referenced product is in conformity with the applicable requirements of the following directives:

RED Directive : 2014/53/EU

RoHS Directive : 2011/65/EU

(EU) 2015/863

WEEE Directive : 2012/19/EU

REACH Regulation : 2006/1907/EC

Conformity with these directives has been assessed for the product by demonstrating compliance to the following harmonized standards and/or regulations:

EN 62311:2008

EN IEC 62368-1:2020+A11:2020

EN 301489-1 V2.2.3 (2019-11)

EN 301489-3 V2.3.2 (2023-01)

EN 301489-17 V3.2.4 (2020-09)

EN 55032:2015+A11:2020

EN 55035:2017+A11:2020

EN 61000-3-2:2019+A1:2021

EN 61000-3-3:2013+A2:2021

EN 301893 V2.1.1 (2017-05)

EN 300440 V2.1.1 (2017-03)

EN 300328 V2.2.2 (2019-07)

2011/65/EU, (EU) 2015/863

2006/1907/EC

2012/19/EU

Signed for and on behalf of: Shenzhen Dangs Science and Technology Co., Ltd.

Place: Shenzhen, China

Date: 2024-02-07

Name: Libing Zhang

Position: Certification Engineer

Signature:

Libing Zhang

Langue

English	01-24
Deutsch	25-48
Français	49-72
Italiano	73-96
Español	97-120
日本語	121-143

Contenu

Lire avant toute utilisation	50
Précautions importantes	51
Liste de colisage	52
Présentation du projecteur	53
Guide sur l'indicateur LED du bouton d'alimentation	55
Présentation de la télécommande	57
Comment démarrer	58
Paramètres réseau	61
Paramètres de mise au point	61
Paramètres de correction de l'image	62
Mode haut-parleur Bluetooth	63
Mode Batterie	63
Rechargez avec une batterie externe	64
Assistant Google	64
Google Cast™	65
Miroir de l'écran	65
Entrées	66
Autres paramètres	66
Spécifications	67
Dépannage	68
Déclaration	70

Lire avant toute utilisation

Veillez lire attentivement les instructions relatives au produit:

Nous vous remercions d'avoir acheté et d'utiliser nos produits.

Pour votre sécurité et dans votre intérêt, veuillez lire attentivement les instructions du produit avant de l'utiliser.

A propos des instructions du produit:

Les marques et les noms mentionnés dans les instructions du produit sont la propriété de leurs détenteurs respectifs.

Toutes les instructions du produit sont présentées uniquement à des fins d'illustration. Le produit réel peut varier en raison des améliorations apportées au produit.

Nous ne serons pas tenus responsables de toute blessure corporelle, de tout dommage matériel ou de tout autre dommage causé par le non-respect des instructions ou des précautions du produit par l'utilisateur.

* Dangbei se réserve le droit d'interpréter et de modifier les instructions du produit.

Précautions importantes

- Comme avec toute source lumineuse intense, ne regardez pas directement dans le faisceau, RG2 IEC 62471-5:2015.
- Les utilisateurs sont conscients du risque de brûlures cutanées ou cornéennes. PRODUIT LASER DE CLASSE 1, Conforme à la norme IEC 60825-1:2014.
- Do not block or cover the heat dissipation holes of the device to avoid affecting the heat dissipation of the internal parts, and damaging the device.
- Keep away from humidity, exposure, high temperature, low pressure, and magnetic environments.
- Do not place the device in areas susceptible to excessive dust and dirt.
- Place the device in a flat and stable station, and do not place the device on a surface that is prone to vibration.
- Do not allow children to handle the device without supervision.
- Do not place heavy or sharp objects on the device.
- Avoid extreme vibrations, because these may damage the internal components.
- Please use the correct type of battery for the remote control.
- Only use attachments/accessories specified or provided by the manufacturer (such as the exclusive power adapter, bracket, etc.).
- Do not disassemble the device. The device should only be repaired by staff authorized by the manufacturer.
- Place and use the device in a 5-35°C environment.
- Le boîtier en métal est revêtu de peinture isolante.
- The plug is considered as a disconnected device of the adapter.
- The adapter should be installed near the equipment, and should be easily accessible.
- Protect the power cord from being walked on or pinched, particularly at the plugs, convenience receptacles, and the point where this exits from the device.
- Unplug this device if there are lightning storms or when unused for a long period of time.
- Where the power plug or an appliance coupler is used to disconnect the device, the disconnected device would remain readily operable.
- Never touch the power cable or power connector with wet hands.
- Risk of explosion if battery is replaced by an incorrect type. Dispose of used batteries according to local regulations.



Liste d'emballage

Avant d'utiliser le produit, veuillez vérifier que tous les éléments se trouvent bien dans la boîte.

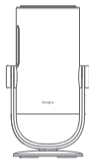

Projecteur



Télécommande



Piles AAA

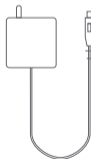

Adaptateur d'alimentation

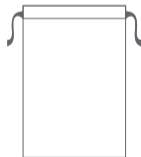

Pochette portable



Manuel d'utilisation

Présentation du projecteur

Présentation et description de l'interface.

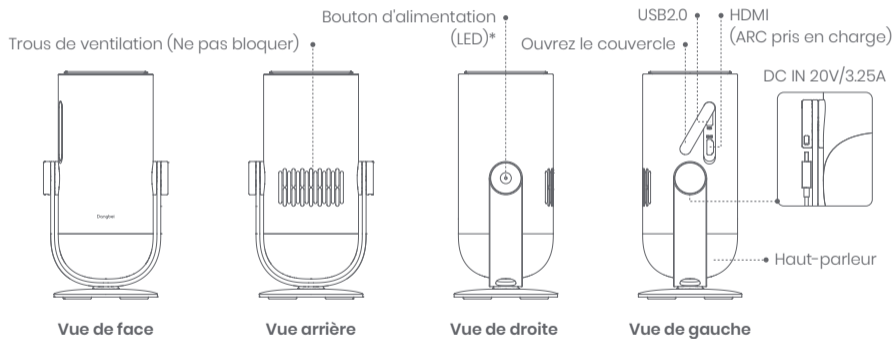

Prise du support PTZ

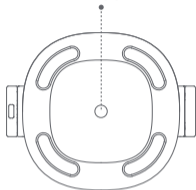

Vue du bas

Trous de ventilation
(Ne pas bloquer)

TOF

Caméra

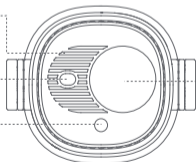

Objectif

Vue de dessus

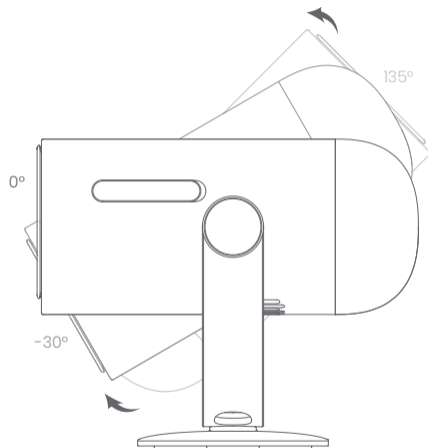

Gamme d'angles d'inclinaison: -30° à +135°

Guide sur l'indicateur LED du bouton d'alimentation

Scénario		État de l'appareil	Capacité de la batterie	Voyant LED
Mode Projection	Rechargez avec l'adaptateur	Mode Veille	=100%	Blanc : lumière respirante
			=entre 70 % et 99 %	Vert : clignotant
			=entre 20 % et 69 %	Orange : clignotant
			≤19%	Rouge : clignotant
		Hors tension	=100%	Éteint
			=entre 70 % et 99 %	Vert : clignotant
			=entre 20 % et 69 %	Orange: flashing
			≤19%	Rouge : clignotant
		Sous tension	=100%	Blanc : toujours allumé
			=entre 70 % et 99 %	
			=entre 20 % et 69 %	
			≤19%	

Scénario		État de l'appareil	Capacité de la batterie	Voyant LED
Mode Projection	Mode batterie (lorsque l'appareil est débranché)	Hors tension	=100%	Éteint
			=entre 70 % et 99 %	Éteint
			=entre 20 % et 69 %	Éteint
			≤19%	Éteint
		Sous tension	=100%	Éteint
			=entre 70 % et 99 %	Vert : toujours allumé
			=entre 20 % et 69 %	Orange : toujours allumé
			≤19%	Rouge : clignotant
	Vérification de la capacité de la batterie (appuyez brièvement sur le bouton d'alimentation du projecteur, uniquement pour le mode batterie)	Hors tension	=entre 70 % et 100%	Vert : s'allume une fois par pression
			=entre 20 % et 69 %	Orange : s'allume une fois par pression
≤19%			Rouge : s'allume une fois par pression	
Mode audio Bluetooth	Passage au mode audio Bluetooth	N/A	Bleu : lumière respirante	
	En attente de l'appariement	N/A	Bleu : lumière respirante	
	La connexion est réussie	N/A	Bleu : toujours allumé	
	Passage au mode Projection	N/A	Consultez l'indicateur LED en mode Projection	

Présentation de la télécommande

- Ouvrir le couvercle du compartiment à piles de la télécommande.
- Installer 2 piles du type AAA *.
- Remettre en place le couvercle du compartiment à piles.

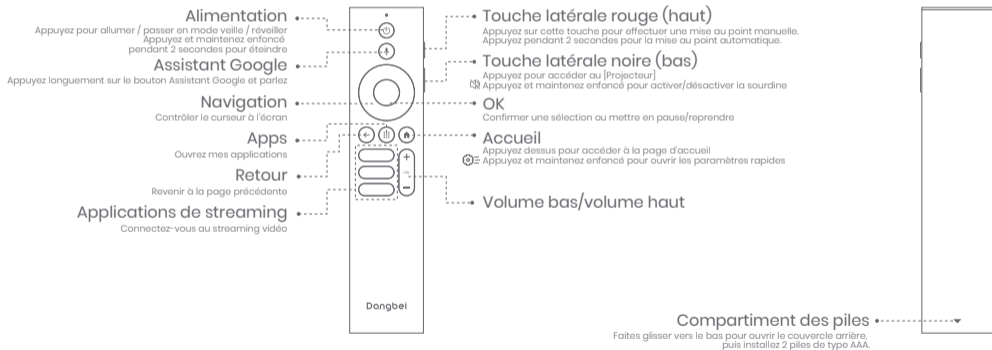

* Veuillez mettre en place des piles neuves en respectant les indications de polarité.

Comment démarrer

1. Emplacement

Placez le projecteur sur une surface stable et plate, devant la surface de projection. Une surface de projection lisse et blanche est recommandée. Veuillez suivre les instructions ci-dessous pour déterminer la distance entre le projecteur et la surface de projection, ainsi que la taille de projection correspondante :

Taille	Écran (Longueur x Largeur)
60 pouces	133 x 75 cm 4.36 x 2.46 ft
80 pouces	177 x 100 cm 5.8 x 3.28 ft
100 pouces	221 x 124 cm 7.25 x 4.06 ft
120 pouces	265 x 149 cm 8.69 x 4.88 ft



La meilleure taille de projection recommandée est de 100 pouces.

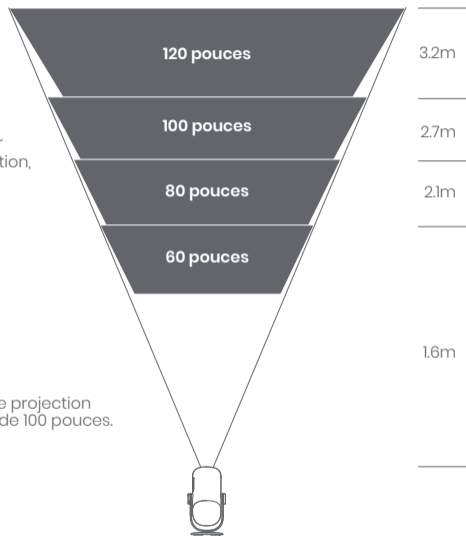

2. Mise sous tension (La première fois, utilisez l'adaptateur fourni pour recharger complètement le projecteur.)

2.1 Lors du branchement de l'adaptateur

- Branchez l'adaptateur de connexion du projecteur à l'alimentation électrique.
- Appuyez sur le bouton d'alimentation du projecteur ou de la télécommande pour l'allumer.
- * Avant de coupler la télécommande, elle peut uniquement être mise sous tension avec le bouton d'alimentation du corps du projecteur.

2.2 Mode batterie (lorsque l'appareil est débranché)

- Appuyez sur le bouton d'alimentation du corps du projecteur 2 secondes pour l'allumer.
- * Le mode batterie ne permet pas d'allumer le projecteur avec le bouton d'alimentation de la télécommande.

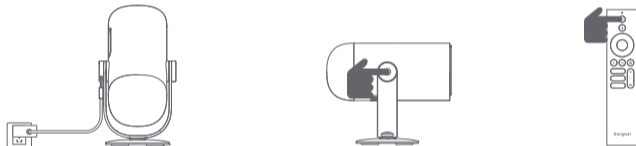

3. Mode veille / Éteindre

3.1 Lors du branchement de l'adaptateur

- Appuyez sur le bouton d'alimentation du projecteur ou de la télécommande pour entrer en mode veille.
- Appuyez et maintenez enfoncé le bouton d'alimentation sur le boîtier du projecteur ou sur la télécommande pendant 2 secondes pour l'éteindre.

3.2 Mode batterie (lorsque l'appareil est débranché)

- Appuyez sur le bouton d'alimentation du projecteur ou de la télécommande pour l'éteindre.
- * Le mode batterie ne prend pas en charge la mise en veille.

4. Jumelage de la télécommande

- Allumez le projecteur et attendez que l'invite d'appairage Bluetooth s'affiche à l'écran.
- Approchez la télécommande à moins de 10 cm du projecteur.
- Appuyez simultanément sur les touches  et  et maintenez-les enfoncées.
- Relâchez les touches lorsque le voyant commence à clignoter.
- Attendez jusqu'à ce que vous entendiez deux "bips", ce qui indique que l'appairage a réussi.

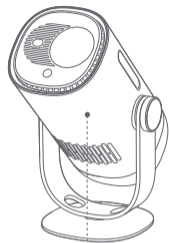

10 cm

Voyant lumineux •
Appuyez et maintenez enfoncé le bouton pour le jumelage *

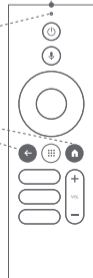

* Si le jumelage ne réussit pas, répétez les étapes ci-dessus jusqu'à ce que le voyant de la télécommande cesse de clignoter.

Paramètres du réseau

- Allez dans [Paramètres], sélectionnez [Réseau et Internet] et activez le Wi-Fi.
- Choisissez votre réseau et entrez le bon mot de passe.



Paramètres de mise au point

Méthode 1: Appuyez sur la touche latérale rouge (haut) pour la mise au point manuelle. Appuyez sur cette touche pendant 2 secondes pour la mise au point automatique.
Méthode 2: Allez dans [projecteur], sélectionnez [Mise au point] et choisissez entre la mise au point manuelle et la mise au point automatique.
Allez dans [Réglages du projecteur], sélectionnez [Réglages de la mise au point] et choisissez entre la mise au point manuelle et la mise au point automatique.

Mise au point automatique

Sélectionnez [Autofocus (Mise au point automatique)] pour déclencher la fonction autofocus. L'image devient alors nette automatiquement.

Mise au point manuelle

Sélectionnez [Mise au point manuelle] et utilisez les touches de navigation (haut/bas) de la télécommande pour régler la distance de mise au point et obtenir une image claire.

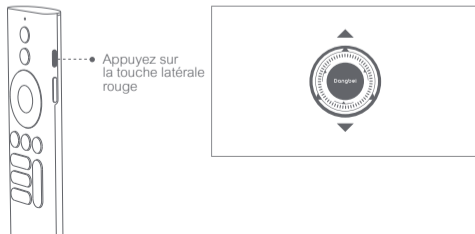

Paramètres de correction de l'image

1. Correction de la distorsion trapézoïdale

- Allez dans [Projecteur] -- [Correction de l'image].
- Sélectionnez [Correction automatique de la distorsion trapézoïdale], et l'écran sera automatiquement corrigé.
- Sélectionnez [Correction manuelle de la distorsion trapézoïdale], et utilisez les touches de navigation pour ajuster les quatre points et la forme de l'image.



2. Ajustement intelligent de l'image sur l'écran

- Allez dans [Projecteur] -- [Correction de l'image] et activez [Ajuster à l'écran].
- Suivez les instructions à l'écran pour ajuster automatiquement l'image en fonction de l'écran.
- Cette fonction prend uniquement en charge le format 16:9.

3. Évitement intelligent des obstacles

- Allez dans [Projecteur] -- [Correction de l'image] -- [Avancé], et activez [Évitement des obstacles].
- Suivez les instructions à l'écran pour régler automatiquement l'image projetée afin d'éviter tout objet se trouvant sur la surface de projection.

Mode haut-parleur Bluetooth

- Go to [Se]Allez dans [Paramètres], sélectionnez [Projecteur] et cliquez sur [Mode haut-parleur Bluetooth].
- Connectez votre téléphone à un appareil dont le nom Bluetooth contient "DBOD03". Après avoir modifié le nom de l'appareil, le nom Bluetooth sera lui aussi synchronisé en conséquence.
- Lorsque vous entendez " Connexion Bluetooth réussie ", le projecteur peut alors lire de la musique à partir de votre téléphone.
- Appuyez sur la touche  de la télécommande pendant 2 secondes pour quitter le [Mode haut-parleur Bluetooth].

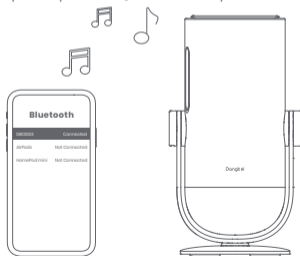

Mode Batterie

- Débranchez l'adaptateur secteur.
- Le projecteur est alimenté par une batterie intégrée. La luminosité du projecteur bascule automatiquement en mode ECO, ce qui prolonge la durée de vie.
 - * Le mode Batterie permet d'ajuster les options de mode Luminosité, mais cela peut affecter la durée de vie de la batterie.

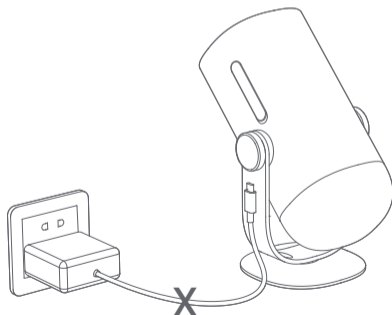

Rechargez avec une batterie externe

- Débranchez l'adaptateur secteur.
 - Connectez le projecteur à la batterie externe avec un cordon d'alimentation USB-C.
- * Assurez-vous que la batterie externe prend en charge le PD3.0 65W et que le cordon d'alimentation USB-C prend en charge le PD 65W et est marqué d'un « E ».

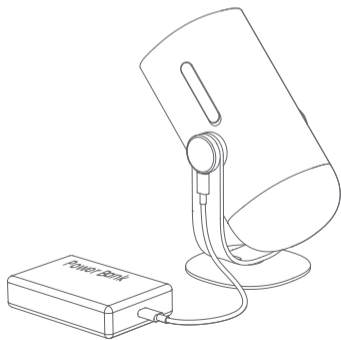

Assistant Google

Votre téléviseur est plus utile que jamais. Utilisez votre voix pour trouver des films, diffuser des applications, écouter de la musique et contrôler la télévision. Demandez à Assistant Google de trouver un titre spécifique, de rechercher par genre ou d'obtenir des recommandations personnalisées. Obtenez même des réponses à l'écran, contrôlez des appareils connectés de la maison, et bien plus. Appuyez sur le bouton Assistant Google de votre télécommande pour commencer.

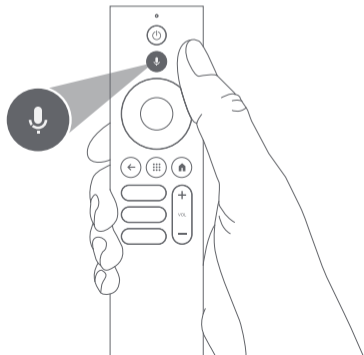

Google Cast™

Diffusez facilement vos films, musiques et plus encore sur votre TV avec Google Cast.

Pour diffuser du contenu depuis une application :

Appuyez simplement sur le bouton Cast depuis les applications que vous connaissez déjà et que vous aimez. Aucune nouvelle connexion ni aucun téléchargement requis.

1. Connectez votre appareil et le projecteur au même réseau sans fil.
2. Ouvrez l'application de streaming sur votre appareil.
3. Lisez une vidéo et appuyez sur le bouton Cast sur l'écran vidéo. 
4. Sélectionnez "DBOD03" pour vous connecter. Le projecteur affichera la vidéo depuis votre appareil.

* En raison de restrictions de droits d'auteur, certains contenus ne peuvent pas être diffusés sur le projecteur. Vous pouvez diffuser le contenu sur le projecteur en installant la même application dessus.

Miroir d'écran

Vous pouvez projeter l'intégralité de l'écran de votre appareil sur le projecteur.

Pour diffuser l'écran de l'appareil :

1. Assurez-vous que votre appareil et le projecteur sont connectés au même réseau sans fil."
2. Installez l'application AirScreen sur le projecteur.
3. Ouvrez l'application AirScreen et suivez les instructions à l'écran pour terminer le processus.

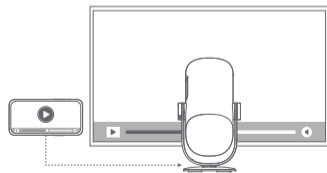

Entrées

HDMI

Branchez le périphérique HDMI au port HDMI.

Appuyez et maintenez enfoncé le bouton Accueil de la télécommande pour faire apparaître le panneau de contrôle du coin supérieur droit de l'écran.

Accédez à [Entrées] et sélectionnez HDMI.

Disque USB

Téléchargez l'application Gestionnaire de fichiers depuis Google Play.

Insérez la clé USB-A dans le port USB.

Ouvrez l'application Gestionnaire de fichiers, trouvez la clé USB, puis sélectionnez le contenu que vous souhaitez ouvrir.

* Formats USB pris en charge : FAT32, NTFS.

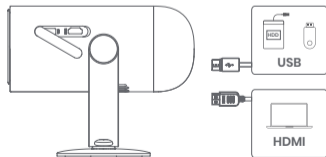

Autres Paramétrages

1. Mode de projection

Allez dans [Paramètres] -- [Projecteur] -- [Paramètres avancés] -- [Mode de projection] pour choisir la méthode de placement du projecteur.

2. Zoom

Allez dans [Paramètres] -- [Projecteur] -- [Correction d'image] -- [Adaptation de d'image] -- [Zoom] pour réduire la taille de l'image de 100 % à 50 %.

3. Informations sur le système et le produit

Allez dans [Paramètres] -- [Système] -- [À propos] pour vérifier les informations sur le système et le produit.

* Pour garantir une mise à jour en douceur, veuillez utiliser l'adaptateur secteur pour éviter tout problème dû à une coupure de courant imprévue.

Spécifications

Technologie d'affichage	0.23 pouces, DLP	Version Bluetooth	5.1
Résolution de l'écran	1920 x 1080	Wi-Fi	Double fréquence 2.4/5.0 GHz
Rapport de projection	1.2 : 1	Dimensions (LxIxH)	131 x 109 x 239 mm 5.16 x 4.29 x 9.4 pouces
Haut-parleur	6W	Poids	1.4kg / 3.08lb

Dépannage

1. Aucune sortie audio

- Vérifiez si vous avez appuyé deux fois sur la touche noire située sur le côté de la télécommande, cela pourrait avoir mis le projecteur en mode silencieux.
- Vérifiez si l'interface du projecteur "HDMI 1 (eARC)" ou Bluetooth est connectée à un appareil audio externe.

2. Aucune sortie d'image

- Appuyez sur le bouton d'alimentation situé à l'arrière du projecteur. Le témoin lumineux du bouton d'alimentation s'éteindra si le projecteur passe en mode de projection avec succès.
- Assurez-vous que l'adaptateur d'alimentation a une sortie d'alimentation.

3. Pas de réseau

- Entrez dans les paramètres, et vérifiez l'état de la connexion réseau dans l'option réseau.
- Assurez-vous que le câble réseau est correctement inséré dans l'interface "LAN" du projecteur.
- Assurez-vous que le routeur est correctement configuré.

4. Image floue

- Réglez la mise au point ou la distorsion trapézoïdale.
- Le projecteur et l'écran/le mur doivent être placés en respectant une certaine distance effective.
- L'objectif du projecteur n'est pas propre.

5. Image non rectangulaire

- Placez le projecteur perpendiculairement à l'écran/au mur si la fonction de correction de la distorsion trapézoïdale n'est pas utilisée.
- Utilisez la fonction de correction trapézoïdale pour régler l'affichage.

6. Échec de la correction automatique du trapèze

- Assurez-vous que la caméra/TOF du panneau avant n'est pas bloquée ou sale.
- La meilleure distance de correction automatique du trapèze est de 2,0-4,0m, horizontale $\pm 30^\circ$.

7. Échec de la mise au point automatique

- Assurez-vous que la caméra/TOF sur le panneau avant n'est pas bloquée ou sale.
- La meilleure distance autofocus est de 2,0-3,5m, horizontale $\pm 20^\circ$.

8. Échec de la protection intelligente des yeux

- Assurez-vous que la caméra/TOF sur la façade avant n'est pas bloquée ou sale.
- La plage de détection optimale se situe autour du centre de l'image. Si vous êtes trop près des bords, la protection oculaire risque de ne pas se déclencher.
- Assurez-vous que le motif de la boîte rouge se trouve dans le cadre de l'écran et qu'il n'est pas bloqué.

9. Échec de l'ajustement de l'écran intelligent

- Assurez-vous que le projecteur est correctement positionné, de manière à ce que l'image projetée dépasse les bords de l'écran.
- Assurez-vous que l'écran de projection a une bordure/cadre de couleur sur les quatre côtés, afin que le projecteur puisse reconnaître le cadre.
- Assurez-vous que le motif de la boîte rouge se trouve dans le cadre de l'écran et qu'il n'est pas bloqué.

10. La télécommande ne réagit pas

- Assurez-vous que la télécommande a été correctement appariée via Bluetooth. Si l'appairage est réussi, le voyant LED clignotera une fois en appuyant sur n'importe quel bouton. Lorsque vous appuyez sur un bouton et que vous le maintenez enfoncé, le voyant LED reste toujours allumé.
- Si l'appairage a échoué, le voyant LED clignotera trois fois en appuyant sur n'importe quel bouton. Lorsque vous appuyez sur un bouton et que vous le maintenez enfoncé, le voyant LED clignote trois fois, puis reste allumé en continu.
- Vérifiez si le témoin lumineux d'alimentation reste allumé sans appuyer sur aucun bouton. Si c'est le cas, vérifiez si des boutons de la télécommande sont coincés.
- Assurez-vous qu'il n'y a pas d'interférences ou d'obstructions entre le projecteur et la télécommande.
- Vérifiez la polarité de la pile et de l'installation.

11. Comment connecter d'autres appareils par Bluetooth

Entrez les paramètres, ouvrez les [télécommandes et accessoires] pour coupler plus d'appareils Bluetooth.

12. Autres

N'hésitez pas à nous contacter à l'adresse support@dangbei.com

Déclaration

Google TV est le nom de la solution logicielle de cet appareil. Il s'agit d'une marque de Google LLC. Google, YouTube, et Google Cast sont des marques de Google LLC.

This equipment has been tested and found to comply with the limits for a Class B digital device, pursuant to Part 15 of the FCC Rules. These limits are designed to provide reasonable protection against harmful interference in a residential installation.

This equipment generates uses and can radiate radio frequency energy and, if not installed and used in accordance with the instructions, may cause harmful interference to radio communications. However, there is no guarantee that interference will not occur in a particular installation. If this equipment does cause harmful interference to radio or television reception, which can be determined by turning the equipment off and on, the user is encouraged to try to correct the interference by one or more of the following measures:

- Reorient or relocate the receiving antenna.
- Increase the separation between the equipment and receiver.
- Connect the equipment to an outlet on a circuit different from that to which the receiver is connected.
- Consult the dealer or an experienced radio/TV technician for help.

Changes or modifications not expressly approved by the party responsible for compliance could void the user's authority to operate the equipment.

This device operating frequency: 2402-2480MHz (EIRP < 20dBm), 2412-2472MHz (EIRP < 20dBm), 5150-5250MHz (EIRP < 23dBm), 5250-5350MHz (EIRP < 20dBm), 5470-5725MHz (EIRP < 27dBm), 5725-5850MHz (EIRP < 13.98dBm).

 We declares that this device is in compliance with the essential requirements and other relevant provisions of Directive 2014/53/EU.

 Satisfies all the technical regulations applicable to the product within the scope of UK Radio Equipment Regulations (SI 2017/1206); UK Electrical Equipment (Safety) Regulations (SI 2016/1101); and UK Electromagnetic Compatibility Regulations (SI 2016/1091).

 Netflix is a trademark of Netflix, Inc.

 Fabriqué sous licence de Dolby Laboratories. Dolby, Dolby Audio et le symbole double-D sont des marques déposées de Dolby Laboratories Licensing Corporation.

 Les termes HDMI, interface multimédia haute définition HDMI et habillage commercial HDMI, et les logos HDMI sont des marques commerciales et des marques déposées de HDMI Licensing Administrator, Inc.

THIS DEVICE COMPLIES WITH DHHS RULES 21 CFR CHAPTER I SUBCHAPTER J.
CAN ICES-3 (B)/NMB-3 (B)

This Class B digital apparatus complies with Canadian ICES-003.

Cet appareil numérique de classe B est conforme à la norme canadienne ICES-003.

This device contains licence-exempt transmitter(s)/receiver(s) that comply with Innovation, Science and Economic Development Canada's licence-exempt RSS(s). Operation is subject to the following two conditions:

(1) This device may not cause interference.

(2) This device must accept any interference, including interference that may cause undesired operation of the device

L'émetteur/récepteur exempt de licence contenu dans le présent appareil est conforme aux CNR d'Innovation, Sciences et Développement économique Canada applicables aux appareils radio exempts de licence. L'exploitation est autorisée aux deux conditions suivantes :

1.L'appareil ne doit pas produire de brouillage;

2.L'appareil doit accepter tout brouillage radioélectrique subi, même si le brouillage est susceptible d'en compromettre le fonctionnement.

For projectors only

The distance between user and products should be no less than 20cm.

La distance entre l'utilisateur et le produit ne doit pas être inférieure à 20 cm.

5150-5350MHz band is restricted to indoor use only.

La bande de 5150-5350MHz est réservée à l'usage intérieur.



WARNING: This product can expose you to Lead, which is known to the State of California to cause cancer and birth defects or other reproductive harm. For more information go to www.P65Warnings.ca.gov



OST_UK_20220817000004

EVATOST CONSULTING LTD

Office 101 32 Threadneedle Street, London,
United Kingdom, EC2R 8AY
contact@evatmaster.com

We simply act as UK representative for cross-border sellers, and are not manufacturers/importers/distributors for the product, nor involved in the manufacture/import/sale of the product. Therefore, we are not responsible for any after-sales services related to the product. In case of any product quality or infringement issues, the manufacturer/importer/seller shall be solely held responsible.



OST_UK_202208170000037

eVatmaster Consulting GmbH

Bettinaser.30
60325 Frankfurt am Main, Germany
contact@evatmaster.com

We simply act as EU representative for cross-border sellers, and are not manufacturers/importers/distributors for the product, nor involved in the manufacture/import/sale of the product. Therefore, we are not responsible for any after-sales services related to the product. In case of any product quality or infringement issues, the manufacturer/importer/seller shall be solely held responsible.



EU DECLARATION OF CONFORMITY

Product : Portable Projector

Trademark : Dangbei

Model Designation : DBOD03

Manufacturer's Name : Shenzhen Dangs Science and Technology Co., Ltd.

Manufacturer's Address : 901, GDC Building, Gaoxin Mid 3rd Road, Maling Community, Yuehai Sub-district, Nanshan District, Shenzhen, China.

Manufacturer's Phone : 86-755-26907499

We, Shenzhen Dangs Science and Technology Co., Ltd. declare under our sole responsibility that the above referenced product is in conformity with the applicable requirements of the following directives:

RED Directive : 2014/53/EU

RoHS Directive : 2011/65/EU

(EU) 2015/863

WEEE Directive : 2012/19/EU

REACH Regulation : 2006/1907/EC

Conformity with these directives has been assessed for the product by demonstrating compliance to the following harmonized standards and/or regulations:

EN 62311:2008

EN IEC 62368-1:2020+A11:2020

EN 301489-1 V2.2.3 (2019-11)

EN 301489-3 V2.3.2 (2023-01)

EN 301489-17 V3.2.4 (2020-09)

EN 55032:2015+A11:2020

EN 55035:2017+A11:2020

EN 61000-3-2:2019+A1:2021

EN 61000-3-3:2013+A2:2021

EN 301893 V2.1.1 (2017-05)

EN 300440 V2.1.1 (2017-03)

EN 300328 V2.2.2 (2019-07)

2011/65/EU, (EU) 2015/863

2006/1907/EC

2012/19/EU

Signed for and on behalf of: Shenzhen Dangs Science and Technology Co., Ltd.

Place: Shenzhen, China

Date: 2024-02-07

Name: Libing Zhang

Position: Certification Engineer

Signature:

Libing Zhang

Lingua

English	01-24
Deutsch	25-48
Français	49-72
Italiano	73-96
Español	97-120
日本語	121-143

Contenuti

Leggere prima dell'uso	74
Avvertenze importanti	75
Elenco degli imballaggi	76
Panoramica del proiettore	77
Guida al LED del tasto di alimentazione	79
Panoramica del telecomando	81
Guida introduttiva	82
Impostazioni di rete	85
Impostazioni di messa a fuoco	85
Impostazioni di correzione dell'immagine	86
Modalità altoparlante Bluetooth	87
Modalità batteria	87
Caricare con power bank	88
Assistente Google	88
Google Cast™	89
Mirroring dello schermo	89
Ingressi	90
Altre impostazioni	90
Specifiche tecniche	91
Risoluzione dei problemi	92
Nota	94

Leggere prima dell'uso

Le preghiamo preghiamo di leggere attentamente le istruzioni del prodotto:

Grazie per aver acquistato e utilizzato questi prodotti.

Per la tua sicurezza e il tuo interesse, ti invitiamo a leggere attentamente le istruzioni del prodotto prima di utilizzarlo.

Informazioni sulle istruzioni del prodotto:

I marchi e i nomi citati nelle Istruzioni per l'uso sono di proprietà dei rispettivi titolari.

Tutte le Istruzioni per l'uso del prodotto riportate sono solo a scopo illustrativo. Il prodotto reale può variare a causa di miglioramenti del prodotto.

Dangbei non sarà responsabile per eventuali lesioni personali, danni alla proprietà o altri danni causati dalla mancata osservanza delle istruzioni o precauzioni da parte dell'utente.

* Dangbei si riserva il diritto di interpretare e modificare le Istruzioni del Prodotto.

Avvertenze importanti



- Come con ogni sorgente luminosa intensa, non fissare il fascio diretto, RG2 IEC 62471-5:2015.
- Gli utenti sono consapevoli del rischio di ustioni cutanee o corneali. PRODOTTO LASER DI CLASSE 1, Conforme a IEC 60825-1:2014.
- Do not block or cover the heat dissipation holes of the device to avoid affecting the heat dissipation of the internal parts, and damaging the device.
- Keep away from humidity, exposure, high temperature, low pressure, and magnetic environments.
- Do not place the device in areas susceptible to excessive dust and dirt.
- Place the device in a flat and stable station, and do not place the device on a surface that is prone to vibration.
- Do not allow children to handle the device without supervision.
- Do not place heavy or sharp objects on the device.
- Avoid extreme vibrations, because these may damage the internal components.
- Please use the correct type of battery for the remote control.
- Only use attachments/accessories specified or provided by the manufacturer (such as the exclusive power adapter, bracket, etc.).
- Do not disassemble the device. The device should only be repaired by staff authorized by the manufacturer.
- Place and use the device in a 5-35°C environment.
- La custodia metallica è rivestita con vernice isolante.
- The plug is considered as a disconnected device of the adapter.
- The adapter should be installed near the equipment, and should be easily accessible.
- Protect the power cord from being walked on or pinched, particularly at the plugs, convenience receptacles, and the point where this exits from the device.
- Unplug this device if there are lightning storms or when unused for a long period of time.
- Where the power plug or an appliance coupler is used to disconnect the device, the disconnected device would remain readily operable.
- Never touch the power cable or power connector with wet hands.
- Risk of explosion if battery is replaced by an incorrect type. Dispose of used batteries according to local regulations.

Elenco degli imballaggi

Prima di utilizzare il prodotto, controlla che tutti gli articoli siano inclusi nella confezione.

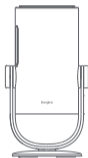

Proiettore



Telecomando



Batterie AAA

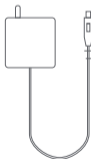

Adattatore di potenza

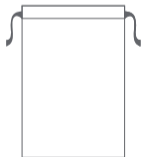

Custodia portatile



Manuale d'uso

Panoramica del proiettore

Panoramica e descrizione dell'interfaccia.

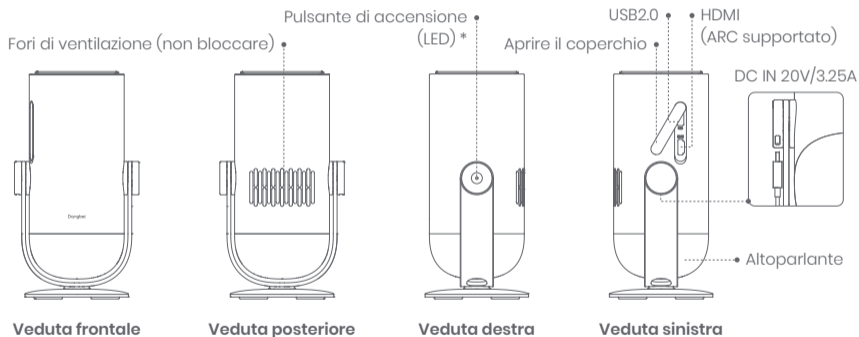

Presa della staffa PTZ

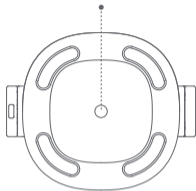

Veduta inferiore

Fori di ventilazione
(non bloccare)

TOF

Telecamera

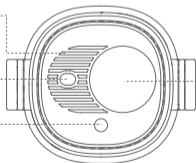

Veduta dall'alto

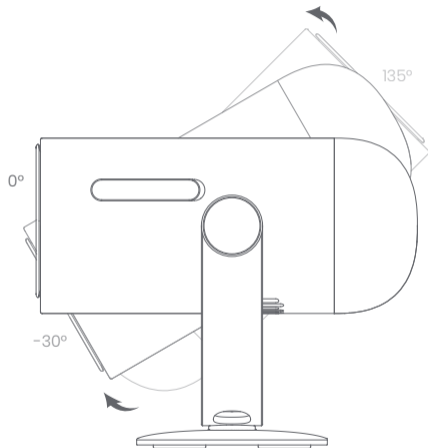

Gamma dell'angolo di inclinazione: -30° a +135°

Guida al LED del tasto di alimentazione

Scenario		Stato dispositivo	Capacità batteria	LED
Modalità proiezione	Carica con adattatore	Modalità standby	=100%	Bianco: luce intermittente
			=70%-99%	Verde: lampeggiante
			=20%-69%	Arancione: lampeggiante
			≤19%	Rosso: lampeggiante
		Spegnere	=100%	Off
			=70%-99%	Verde: lampeggiante
			=20%-69%	Arancione: lampeggiante
			≤19%	Rosso: lampeggiante
		Accendere	=100%	Bianco: sempre acceso
			=70%-99%	
			=20%-69%	
			≤19%	

Scenario		Stato dispositivo	Capacità batteria	LED
Projection mode	Modalità batteria (se scollegato)	Spegnere	=100%	Off
			=70%-99%	Off
			=20%-69%	Off
			≤19%	Off
		Accendere	=100%	Off
			=70%-99%	Verde: sempre acceso
			=20%-69%	Arancione: sempre acceso
			≤19%	Rosso: lampeggiante
	Controllo della capacità della batteria (premere brevemente il tasto di alimentazione del proiettore, solo per modalità batteria)	Spegnere	=70%-100%	Verde: si illumina una volta per pressione
			=20%-69%	Arancione: si illumina una volta per pressione
≤19%			Rosso: si illumina una volta per pressione	
Modalità audio Bluetooth		Commutazione alla modalità audio Bluetooth	N/A	Blu: luce intermittente
		In attesa di associazione	N/A	Blu: luce intermittente
		Connessione eseguita correttamente	N/A	Blu: sempre acceso
		Commutazione alla modalità proiezione	N/A	Fare riferimento al LED in modalità proiezione

Panoramica del telecomando

- Apri il coperchio del vano batterie del telecomando.
- Installa 2 batterie AAA *.
- Riposiziona il coperchio del vano batterie.

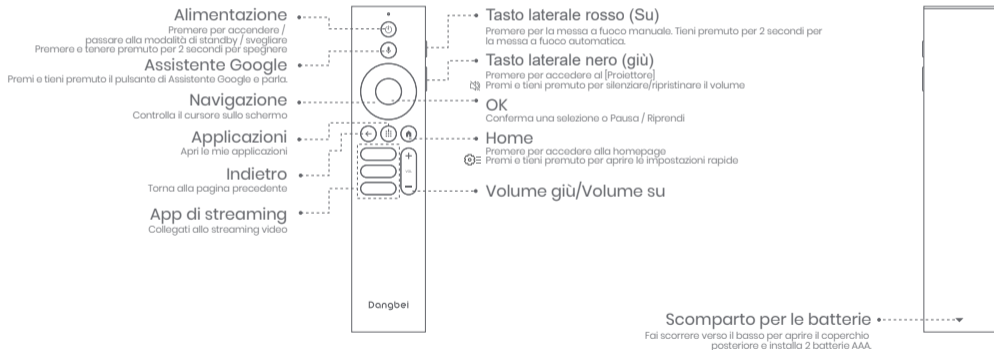

* Inserire le batterie nuove rispettando le indicazioni di polarità.

Guida introduttiva

1. Posizionamento

Posiziona il proiettore su una superficie stabile e piana di fronte alla superficie di proiezione. Si consiglia una superficie di proiezione piatta e bianca.

Segui le istruzioni riportate di seguito per determinare la distanza tra il proiettore e la superficie di proiezione e il formato di proiezione corrispondente:

Dimensioni	Schermo (Lunghezza x Larghezza)
60 pollici	133 x 75 cm 4.36 x 2.46 ft
80 pollici	177 x 100 cm 5.8 x 3.28 ft
100 pollici	221 x 124 cm 7.25 x 4.06 ft
120 pollici	265 x 149 cm 8.69 x 4.88 ft



La dimensione di proiezione migliore consigliata è di 100 pollici.

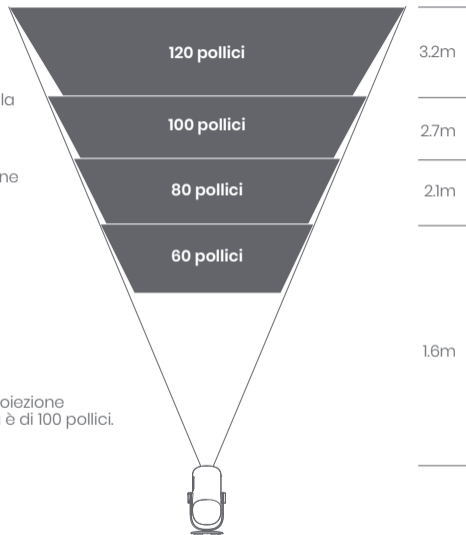

2. Accensione (Per la prima volta, utilizzare l'adattatore in dotazione per caricare completamente il proiettore.)

2.1 Quando si inserisce l'adattatore

- Inserire l'adattatore di collegamento del proiettore nell'alimentazione.
- Premere il tasto di alimentazione sul corpo del proiettore o sul telecomando per accenderlo.
- * Prima che il telecomando sia associato, può essere acceso solo tramite il tasto di alimentazione del corpo del proiettore.

2.2 Modalità batteria (se scollegato)

- Tenere premuto il tasto di alimentazione del corpo del proiettore per 2 secondi per accenderlo.
- * La modalità batteria non supporta l'accensione con il tasto di alimentazione sul telecomando.

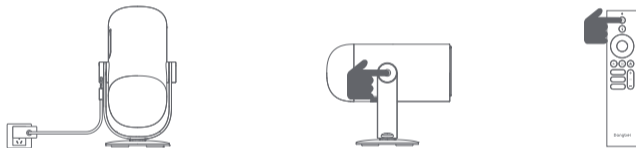

3. Modalità standby / Spegnimento



3.1 Quando si inserisce l'adattatore

- Premere il tasto di alimentazione sul proiettore o sul telecomando per accedere alla modalità standby.
- Tenere premuto il tasto di alimentazione sul corpo del proiettore o sul telecomando per 2 secondi per spegnerlo.

3.2 Modalità batteria (se scollegato)

- Premere il tasto di alimentazione sul corpo del proiettore o sul telecomando per spegnerlo.
- * La modalità batteria non supporta lo standby.

4. Abbinamento del telecomando

- Accendi il proiettore e attendi la richiesta di accoppiamento Bluetooth sullo schermo.
- Porta il telecomando a 10 cm dal proiettore.
- Tieni premuti contemporaneamente i tasti  e .
- Rilascia i tasti dopo che l'indicatore luminoso inizia a lampeggiare.
- Attendi fino a quando non sentirai due "bip" che indicano che l'abbinamento è andato a buon fine.

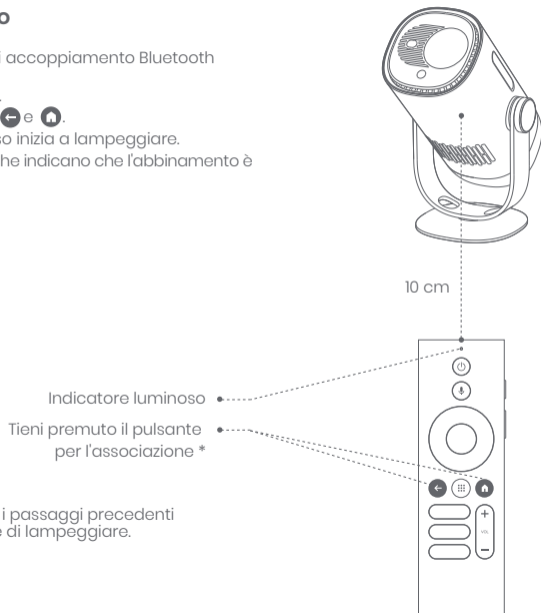

* Se l'abbinamento non va a buon fine, ripeti i passaggi precedenti finché la spia del telecomando non smette di lampeggiare.

Impostazioni di rete

- Vai su [Impostazioni], seleziona [Rete e Internet] e attiva il Wi-Fi.
- Scegli la tua rete e inserisci la password corretta.



Impostazioni di messa a fuoco

Metodo 1: Premi il tasto laterale rosso (su) per la messa a fuoco manuale. Tieni premuto per 2 secondi per la messa a fuoco automatica.

Metodo 2: Vai in [Proiettore], seleziona [messa a fuoco] e scegli la messa a fuoco manuale o la messa a fuoco automatica.

Messa a fuoco automatica

Seleziona [Messa a fuoco automatica] per attivare la funzione di autofocus. L'immagine diventerà automaticamente chiara.

Messa a fuoco manuale

Seleziona [Messa a fuoco manuale] e usa i tasti di navigazione (su / giù) del telecomando per regolare la distanza di messa a fuoco e rendere l'immagine nitida.



Impostazioni di correzione dell'immagine

1. Correzione Keystone

- Vai a [Impostazioni del proiettore] -- [Correzione dell'immagine].
- Seleziona [Correzione trapezoidale automatica], e lo schermo verrà automaticamente corretto.
- Seleziona [Correzione trapezoidale manuale], e usa i tasti di navigazione per regolare i quattro punti e la forma dell'immagine.

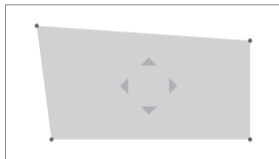

2. Adattamento intelligente dello schermo

- Vai in [Impostazioni del proiettore] -- [Correzione dell'immagine] e attiva [Adattamento allo schermo].
- Segui le istruzioni sullo schermo per regolare automaticamente l'immagine proiettata per adattarla allo schermo.
- Questa funzione supporta solo la tenda 16:9.

3. Evitamento intelligente degli ostacoli

- Vai in [Impostazioni del proiettore] -- [Correzione dell'immagine] -- [Avanzate] e attiva [Evita ostacoli].
- Segui le istruzioni sullo schermo per regolare automaticamente l'immagine proiettata in modo da evitare gli oggetti presenti sulla superficie di proiezione.

Modalità altoparlante Bluetooth

- Vai in [Impostazioni], seleziona [Proiettore] e clicca su [Modalità altoparlante Bluetooth].
- Collega il telefono a un dispositivo con nome Bluetooth contenente "DBOD03". Dopo aver modificato il nome del dispositivo, anche il nome Bluetooth verrà sincronizzato di conseguenza.
- Quando sentirai "connessione Bluetooth riuscita", il proiettore potrà riprodurre la musica dal tuo telefono.
- Tieni premuto il tasto  del telecomando per 2 secondi per uscire dalla [Modalità altoparlante Bluetooth].

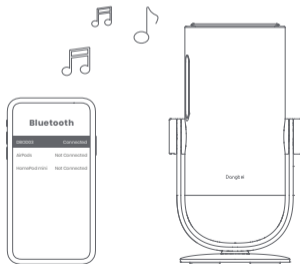

Modalità batteria

- Scollegare l'adattatore di alimentazione.
- Il proiettore è alimentato da una batteria integrata. La luminosità del proiettore passa automaticamente alla modalità ECO, che ne prolunga la durata.
- * La modalità batteria supporta la regolazione di altre opzioni di modalità di luminosità, ma influirà sulla durata.

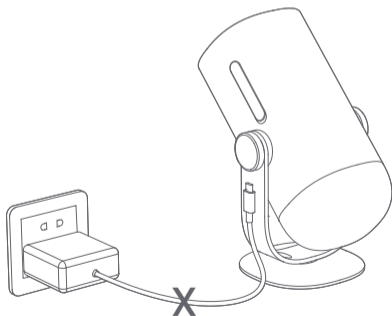

Caricare con power bank

- Scollegare l'adattatore di alimentazione.
 - Collegare il proiettore al power bank con un cavo di alimentazione USB-C.
- * Assicurarsi che il power bank supporti PD3.0 65 W e che il cavo di alimentazione USB-C supporti PD 65 W ed E-mark.

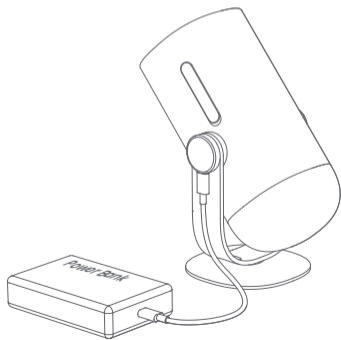

Assistente Google

Il tuo televisore è più utile che mai. Usa la tua voce per trovare film, accedere a servizi di streaming, riprodurre musica e controllare la TV. Chiedi a Assistente Google di cercare un titolo specifico, cercare per genere o ricevere raccomandazioni personalizzate. Puoi persino ottenere risposte sullo schermo, controllare dispositivi smart home e altro ancora. Per iniziare, premi il pulsante Assistente Google sul telecomando.

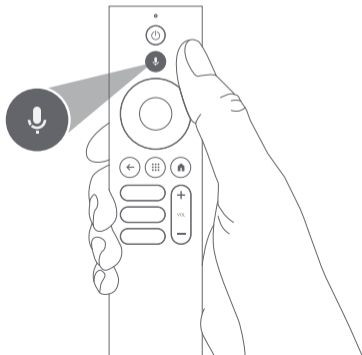

Google Cast™

Trasmetti facilmente i tuoi film, musica e altro alla tua TV con Google Cast.

Per trasmettere contenuti dall'app :

Semplicemente tocca il pulsante Cast dalle app che conosci già e ami. Nessun nuovo accesso o download richiesto.

1. Connetti il tuo dispositivo e il proiettore alla stessa rete wireless.
2. Apri l'app di streaming sul tuo dispositivo.
3. Riproduci un video e tocca il pulsante Cast sulla schermata del video. 
4. Seleziona "DBOD03" per connetterti. Il proiettore visualizzerà il video dal tuo dispositivo.

* A causa di restrizioni legate al copyright, alcuni contenuti non possono essere trasmessi al proiettore. Puoi trasmettere il contenuto sul proiettore installando la stessa applicazione su di esso.

Mirroring dello schermo

Puoi proiettare l'intero schermo del tuo dispositivo sul proiettore.

Per trasmettere lo schermo del dispositivo :

1. Assicurati che sia il tuo dispositivo che il proiettore siano connessi alla stessa rete wireless.
2. Installa l'app AirScreen sul proiettore.
3. Apri l'app AirScreen e segui le istruzioni visualizzate per completare il processo.

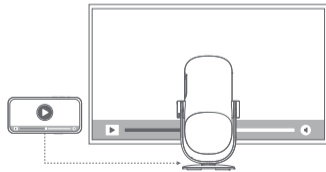

Ingressi

HDMI

Inserire il dispositivo HDMI nella porta USB.

Tenere premuto il tasto Home del telecomando per estrarre il pannello di controllo dall'angolo in alto a destra dello schermo.

Andare su [Ingressi] e selezionare HDMI.

Disco USB

Scaricare l'app File Manager da Google Play.

Inserire il disco USB-A nella porta USB.

Aprire l'app File Manager, trovare il disco USB e selezionare il contenuto da aprire.

* Formati USB supportati: FAT32, NTFS.

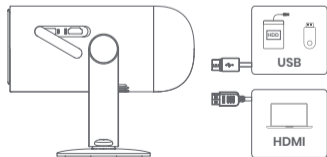

Altre impostazioni

1. Modalità di proiezione

Vai in [Impostazioni] -- [Proiettore] -- [Impostazioni avanzate] -- [Modalità di proiezione] per scegliere il metodo di posizionamento del proiettore.

2. Zoom

Vai a [Impostazioni] -- [Proiettore] -- [Correzione dell'immagine] -- [Adattamento immagine] -- [Zoom] per ridurre le dimensioni dell'immagine dal 100% al 50%.

3. Informazioni sul sistema e sul prodotto

Vai su [Impostazioni] -- [Sistema] -- [Informazioni] per controllare le informazioni sul sistema e sul prodotto.

* Per garantire un aggiornamento senza problemi, utilizzare l'adattatore per evitare eventuali problemi causati da un'interruzione imprevista.

Specifiche tecniche

Tecnologia dello schermo	0.23 pouces, DLP	Versione Bluetooth	5.1
Risoluzione dello schermo	1920 x 1080	WI-FI	a doppia frequenza 2.4/5.0 GHz
Rapporto di proiezione	1.2 : 1	Dimensioni (LxLxH)	131 x 109 x 239 mm 5.16 x 4.29 x 9.4 pouces
Altoparlante	6W	Peso	1.4kg / 3.08lb

Risoluzione dei problemi

1. Nessuna uscita audio

- Verifica se hai premuto due volte il tasto nero sul lato del telecomando, potresti aver messo il proiettore in modalità silenziosa.
- Controlla se l'interfaccia del proiettore "HDMI 1 (eARC)" o il Bluetooth sono collegati a un dispositivo audio esterno.

2. Nessuna immagine in uscita

- Premere il pulsante di accensione situato sul retro del proiettore. La spia del pulsante di accensione si spegnerà se il proiettore entra correttamente in modalità di proiezione.
- Assicurati che l'adattatore di alimentazione abbia un'uscita di corrente.

3. Nessuna rete

- Entra nelle impostazioni e controlla lo stato della connessione di rete nell'opzione Rete.
- Assicurati che il cavo di rete sia inserito correttamente nell'interfaccia del proiettore "LAN".
- Assicurati che il router sia configurato correttamente.

4. Immagine sfocata

- Regola la messa a fuoco o il keystone.
- Il proiettore e lo schermo/muro devono essere posizionati a una distanza efficace.
- La lente del proiettore non è pulita.

5. Immagine non rettangolare

- Posiziona il proiettore perpendicolare allo schermo/muro se non si utilizza la funzione di correzione Keystone.
- Usa la funzione Keystone per regolare la visualizzazione.

6. Correzione keystone automatica fallita

- Assicurati che la telecamera/TOF sul pannello frontale non sia bloccata o sporca.
- La distanza migliore per la correzione keystone automatica è 2,0-4,0m, orizzontale $\pm 30^\circ$.

7. Mancata messa a fuoco automatica

- a. Assicurati che la telecamera/TOF sul pannello frontale non sia bloccata o sporca.
- b. La distanza migliore per l'autofocus è di 2,0-3,5m, in orizzontale $\pm 20^\circ$.

8. Protezione intelligente degli occhi non riuscita

- a. Protezione intelligente degli occhi non riuscita
- b. Il campo di rilevamento ottimale si trova intorno al centro dell'immagine. Se si è troppo vicini ai bordi, la funzione di protezione degli occhi potrebbe non attivarsi.

9. Errore di adattamento dello schermo intelligente

- a. Assicurati che il proiettore sia posizionato correttamente, in modo che l'immagine proiettata si estenda oltre i bordi dello schermo.
- b. Assicurati che lo schermo di proiezione abbia un bordo/quadro colorato su tutti e quattro i lati, in modo che il proiettore possa riconoscere la cornice.
- c. Assicurati che il motivo del riquadro rosso sia all'interno della cornice dello schermo e non sia bloccato.

10. Il telecomando non risponde

- a. Assicurati che il telecomando sia accoppiato correttamente via Bluetooth. Se l'accoppiamento è riuscito, il LED lampeggia una volta quando premi un pulsante qualsiasi. Se tieni premuto un pulsante qualsiasi, la luce del LED rimarrà fissa.
- b. Se l'accoppiamento non è riuscito, la luce del LED lampeggerà tre volte quando premi un pulsante qualsiasi. Quando tieni premuto un pulsante qualsiasi, la luce del LED lampeggia tre volte e poi rimane fissa.
- c. Verifica se l'indicatore di alimentazione rimane acceso senza premere alcun pulsante. In caso affermativo, controlla se i pulsanti del telecomando sono bloccati.
- d. Assicurati che non ci siano interferenze o ostruzioni tra il proiettore e il telecomando.
- e. Controlla la polarità della batteria e dell'installazione.

11. Come connettere altri dispositivi tramite Bluetooth

Inserisci le impostazioni, apri [Telecomandi e accessori] per associare più dispositivi Bluetooth.

12. Altro

Non esitare a contattarci all'indirizzo support@dangbei.com

Nota

Google TV è il nome dell'esperienza software di questo dispositivo e un marchio di Google LLC. Google, YouTube e Google Cast sono marchi di Google LLC.

This equipment has been tested and found to comply with the limits for a Class B digital device, pursuant to Part 15 of the FCC Rules. These limits are designed to provide reasonable protection against harmful interference in a residential installation.

This equipment generates uses and can radiate radio frequency energy and, if not installed and used in accordance with the instructions, may cause harmful interference to radio communications. However, there is no guarantee that interference will not occur in a particular installation. If this equipment does cause harmful interference to radio or television reception, which can be determined by turning the equipment off and on, the user is encouraged to try to correct the interference by one or more of the following measures:

- Reorient or relocate the receiving antenna.
- Increase the separation between the equipment and receiver.
- Connect the equipment to an outlet on a circuit different from that to which the receiver is connected.
- Consult the dealer or an experienced radio/TV technician for help.

Changes or modifications not expressly approved by the party responsible for compliance could void the user's authority to operate the equipment.

This device operating frequency: 2402-2480MHz (EIRP < 20dBm), 2412-2472MHz (EIRP < 20dBm), 5150-5250MHz (EIRP < 23dBm), 5250-5350MHz (EIRP < 20dBm), 5470-5725MHz (EIRP < 27dBm), 5725-5850MHz (EIRP < 13.98dBm).

 We declares that this device is in compliance with the essential requirements and other relevant provisions of Directive 2014/53/EU.

 Satisfies all the technical regulations applicable to the product within the scope of UK Radio Equipment Regulations (SI 2017/1206); UK Electrical Equipment (Safety) Regulations (SI 2016/1101); and UK Electromagnetic Compatibility Regulations (SI 2016/1091).

 Netflix is a trademark of Netflix, Inc.

 Prodotto su licenza di Dolby Laboratories. Dolby, Dolby Audio e il simbolo della doppia D sono marchi registrati di Dolby Laboratories Licensing Corporation.

 I termini HDMI, Interfaccia multimediale ad alta definizione HDMI (HDMI High-Definition Multimedia Interface), immagine commerciale HDMI (HDMI Trade dress) e i loghi HDMI sono marchi commerciali o marchi commerciali registrati di HDMI Licensing Administrator, Inc.

THIS DEVICE COMPLIES WITH DHHS RULES 21 CFR CHAPTER I SUBCHAPTER J.
CAN ICES-3 (B)/NMB-3 (B)

This Class B digital apparatus complies with Canadian ICES-003.

Cet appareil numérique de classe B est conforme à la norme canadienne ICES-003.

This device contains licence-exempt transmitter(s)/receiver(s) that comply with Innovation, Science and Economic Development Canada's licence-exempt RSS(s). Operation is subject to the following two conditions:

(1) This device may not cause interference.

(2) This device must accept any interference, including interference that may cause undesired operation of the device

L'émetteur/récepteur exempt de licence contenu dans le présent appareil est conforme aux CNR d'Innovation, Sciences et Développement économique Canada applicables aux appareils radio exempts de licence. L'exploitation est autorisée aux deux conditions suivantes :

1.L'appareil ne doit pas produire de brouillage;

2.L'appareil doit accepter tout brouillage radioélectrique subi, même si le brouillage est susceptible d'en compromettre le fonctionnement.

For projectors only

The distance between user and products should be no less than 20cm.

La distance entre l'utilisateur et le produit ne doit pas être inférieure à 20 cm.

5150-5350MHz band is restricted to indoor use only.

La bande de 5150-5350MHz est réservée à l'usage intérieur.



WARNING: This product can expose you to Lead, which is known to the State of California to cause cancer and birth defects or other reproductive harm. For more information go to www.P65Warnings.ca.gov



OST_UK_20220817000004

EVATOST CONSULTING LTD

Office 101 32 Threadneedle Street, London,
United Kingdom, EC2R 8AY
contact@evatmaster.com

We simply act as UK representative for cross-border sellers, and are not manufacturers/importers/distributors for the product, nor involved in the manufacture/import/sale of the product. Therefore, we are not responsible for any after-sales services related to the product. In case of any product quality or infringement issues, the manufacturer/importer/seller shall be solely held responsible.



OST_UK_202208170000037

eVatmaster Consulting GmbH

Bettlinaser.30
60325 Frankfurt am Main, Germany
contact@evatmaster.com

We simply act as EU representative for cross-border sellers, and are not manufacturers/importers/distributors for the product, nor involved in the manufacture/import/sale of the product. Therefore, we are not responsible for any after-sales services related to the product. In case of any product quality or infringement issues, the manufacturer/importer/seller shall be solely held responsible.



EU DECLARATION OF CONFORMITY

Product : Portable Projector

Trademark : Dangbei

Model Designation : DBOD03

Manufacturer's Name : Shenzhen Dangs Science and Technology Co., Ltd.

Manufacturer's Address : 901, GDC Building, Gaoxin Mid 3rd Road, Maling Community, Yuehai Sub-district, Nanshan District, Shenzhen, China.

Manufacturer's Phone : 86-755-26907499

We, Shenzhen Dangs Science and Technology Co., Ltd. declare under our sole responsibility that the above referenced product is in conformity with the applicable requirements of the following directives:

RED Directive : 2014/53/EU

RoHS Directive : 2011/65/EU

(EU) 2015/863

WEEE Directive : 2012/19/EU

REACH Regulation : 2006/1907/EC

Conformity with these directives has been assessed for the product by demonstrating compliance to the following harmonized standards and/or regulations:

EN 62311:2008

EN IEC 62368-1:2020+A11:2020

EN 301489-1 V2.2.3 (2019-11)

EN 301489-3 V2.3.2 (2023-01)

EN 301489-17 V3.2.4 (2020-09)

EN 55032:2015+A11:2020

EN 55035:2017+A11:2020

EN 61000-3-2:2019+A1:2021

EN 61000-3-3:2013+A2:2021

EN 301893 V2.1.1 (2017-05)

EN 300440 V2.1.1 (2017-03)

EN 300328 V2.2.2 (2019-07)

2011/65/EU, (EU) 2015/863

2006/1907/EC

2012/19/EU

Signed for and on behalf of: Shenzhen Dangs Science and Technology Co., Ltd.

Place: Shenzhen, China

Date: 2024-02-07

Name: Libing Zhang

Position: Certification Engineer

Signature:

Libing Zhang

Idioma

English	01-24
Deutsch	25-48
Français	49-72
Italiano	73-96
Español	97-120
日本語	121-143

Índice

Leer antes de usar	98
Precauciones importantes	99
Lista de embalaje	100
Descripción general del proyector	101
Pautas sobre el indicador LED del botón de alimentación	103
Descripción general del control remoto	105
Primeros pasos	106
Ajustes de red	109
Ajustes de enfoque	109
Ajustes de corrección de imagen	110
Modo de altavoz Bluetooth	111
Modo de batería	111
Carga con batería externa	112
Asistente de Google	112
Google Cast™	113
Duplicación de pantalla	113
Entradas	114
Más ajustes	114
Especificaciones	115
Resolución de problemas	116
Declaración	118

Leer antes de usar

Le rogamos que lea atentamente las instrucciones del producto:

Gracias por comprar y usar estos productos.

Por motivos de seguridad y en pro de sus intereses, lea atentamente las Instrucciones del producto antes de usarlo.

Acerca de las Instrucciones del producto:

Las marcas registradas y los nombres mencionados en las Instrucciones del producto son propiedad de sus respectivos propietarios. Todas las Instrucciones del producto indicadas sirven únicamente fines ilustrativos. El producto real podría variar debido a posibles mejoras del producto.

No seremos responsables de ninguna lesión, daño a la propiedad u otros daños producidos debido al incumplimiento, por parte del usuario, de las Instrucciones del producto o las respectivas precauciones.

* Dangbei se reserva el derecho a la interpretación y modificación de las Instrucciones del producto.

Precauciones importantes



- Como con cualquier fuente brillante, no mirar directamente al haz, RG2 IEC 62471-5:2015.
- Los usuarios son conscientes del riesgo de quemaduras en la piel o en la córnea. PRODUCTO LÁSER DE CLASE 1, Cumple con IEC 60825-1:2014.
- Do not block or cover the heat dissipation holes of the device to avoid affecting the heat dissipation of the internal parts, and damaging the device.
- Keep away from humidity, exposure, high temperature, low pressure, and magnetic environments.
- Do not place the device in areas susceptible to excessive dust and dirt.
- Place the device in a flat and stable station, and do not place the device on a surface that is prone to vibration.
- Do not allow children to handle the device without supervision.
- Do not place heavy or sharp objects on the device.
- Avoid extreme vibrations, because these may damage the internal components.
- Please use the correct type of battery for the remote control.
- Only use attachments/accessories specified or provided by the manufacturer (such as the exclusive power adapter, bracket, etc.).
- Do not disassemble the device. The device should only be repaired by staff authorized by the manufacturer.
- Place and use the device in a 5-35°C environment.
- La carcasa de metal está recubierta con pintura aislante.
- The plug is considered as a disconnected device of the adapter.
- The adapter should be installed near the equipment, and should be easily accessible.
- Protect the power cord from being walked on or pinched, particularly at the plugs, convenience receptacles, and the point where this exits from the device.
- Unplug this device if there are lightning storms or when unused for a long period of time.
- Where the power plug or an appliance coupler is used to disconnect the device, the disconnected device would remain readily operable.
- Never touch the power cable or power connector with wet hands.
- Risk of explosion if battery is replaced by an incorrect type. Dispose of used batteries according to local regulations.

Lista de embalaje

Antes de usar el producto, compruebe que todos los artículos vengan incluidos en la caja.

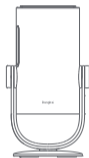

Proyector



Control remoto



Baterías AAA

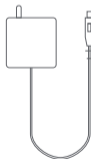

Adaptador de corriente

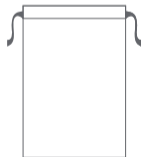

Bolsa portátil



Manual de usuario

Descripción general del proyector

Descripción general y de la interfaz.

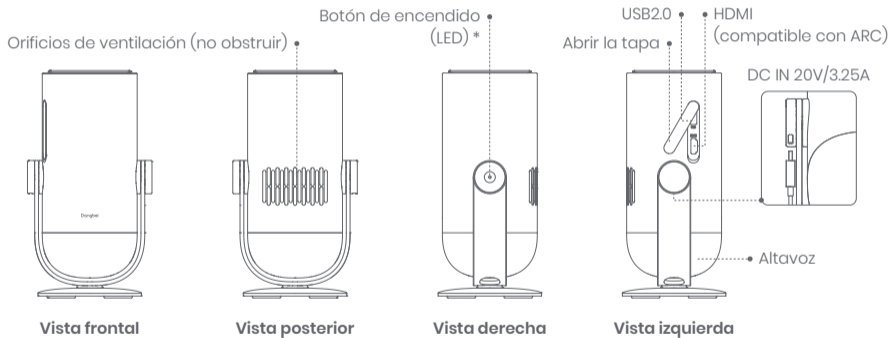

Conexión de soporte PTZ

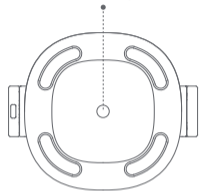

Vista inferior

Orificios de ventilación
(no obstruir)

TOF

Cámara

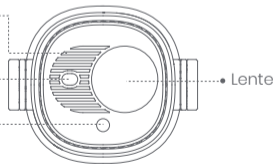

Vista superior

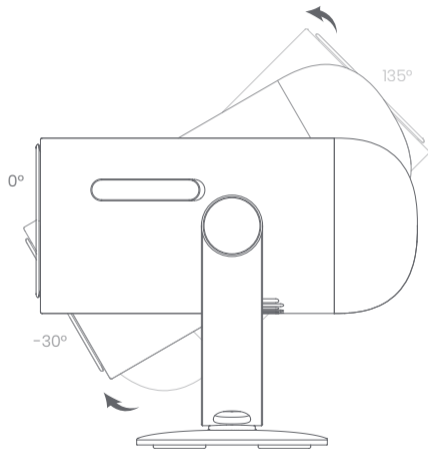

Intervalo del ángulo de inclinación: -30° a +135°

Pautas sobre el indicador LED del botón de alimentación

Escenario		Estado del dispositivo	Capacidad de la batería	Indicador LED
Modo de proyección	Cargar con adaptador	Modo en espera	=100%	Blanco: luz de respiración
			=70%-99%	Verde: intermitente
			=20%-69%	Naranja: intermitente
			≤19%	Rojo: intermitente
		Apagar	=100%	Apagado
			=70%-99%	Verde: intermitente
			=20%-69%	Naranja: intermitente
			≤19%	Rojo: intermitente
		Encender	=100%	Blanco: siempre encendido
			=70%-99%	
			=20%-69%	
			≤19%	

Escenario		Estado del dispositivo	Capacidad de la batería	Indicador LED
Modo de proyección	Modo de batería (cuando está desenchufado)	Apagar	=100%	Apagado
			=70%-99%	Apagado
			=20%-69%	Apagado
			≤19%	Apagado
		Encender	=100%	Apagado
			=70%-99%	Verde: siempre encendido
			=20%-69%	Naranja: siempre encendido
			≤19%	Rojo: intermitente
	Comprobación de la capacidad de la batería (presionar brevemente el botón de alimentación del proyector, solo para el modo de batería)	Apagar	=70%-100%	Verde: se enciende una vez por pulsación
			=20%-69%	Naranja: se enciende una vez por pulsación
≤19%			Rojo: se enciende una vez por pulsación	
Modo de audio Bluetooth	Cambiar al modo de audio Bluetooth	N/D	Azul: luz de respiración	
	Esperando la asociación	N/D	Azul: luz de respiración	
	Conexión correcta	N/D	Azul: siempre encendido	
	Cambiar al modo de proyección	N/D	Consulte el indicador LED en el modo de proyección	

Descripción general del control remoto

- Abra la tapa del compartimiento de las baterías del control remoto.
- Coloque 2 baterías AAA *.
- Vuelva a colocar la tapa del compartimiento de las baterías.

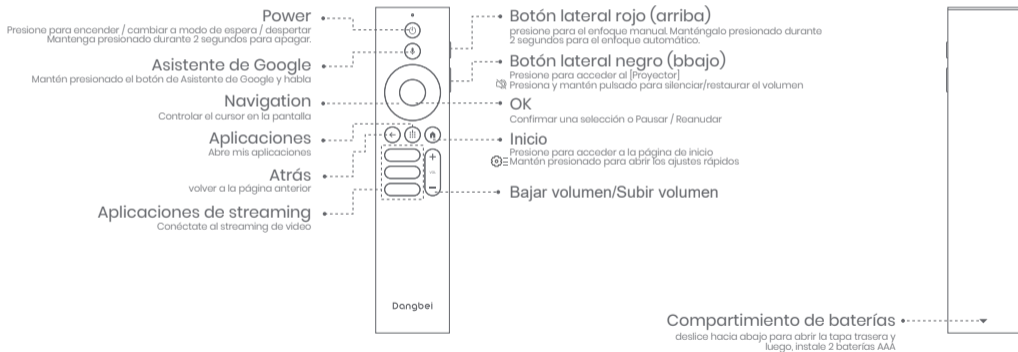

* Inserte las baterías nuevas según las indicaciones de polaridad.

Primeros pasos

1. Colocación

Coloque el proyector sobre una superficie lisa y estable frente a la superficie de proyección.

Se recomienda una superficie de proyección blanca que sea lisa. Siga las instrucciones vertidas a continuación para determinar la distancia entre el proyector y la superficie de proyección, y el tamaño de proyección correspondiente:

Tamaño	Pantalla (largo x ancho)
60 pulgadas	133 x 75 cm 4.36 x 2.46 ft
80 pulgadas	177 x 100 cm 5.8 x 3.28 ft
100 pulgadas	221 x 124 cm 7.25 x 4.06 ft
120 pulgadas	265 x 149 cm 8.69 x 4.88 ft



El tamaño óptimo de proyección recomendado es de 100 pulgadas.

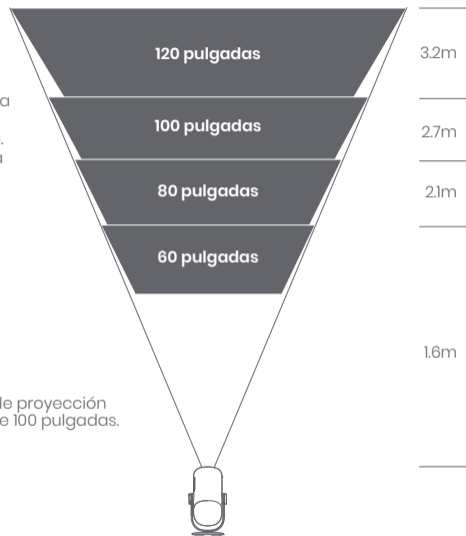

2. Encendido (Por primera vez, utilice el adaptador suministrado para cargar completamente el proyector.)

2.1 Cuando se conecta el adaptador

- Enchufe el adaptador de conexión del proyector a la red eléctrica.
- Presione el botón de alimentación situado en el cuerpo del proyector o en el mando a distancia para encenderlo.
- * Antes de emparejar el mando a distancia, solamente puede encenderse mediante el botón de alimentación situado en el cuerpo del proyector.

2.2 Modo de batería (cuando está desenchufado)

- Mantenga presionado el botón de alimentación del cuerpo del proyector durante 2 segundos para encenderlo.
- * El modo de batería no admite el encendido con el botón de alimentación del mando a distancia.

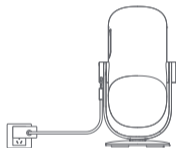

3. Modo de espera / Apagar



3.1 Cuando se conecta el adaptador

- Presione el botón de alimentación del proyector o del mando a distancia para entrar en el modo en espera.
- Mantenga presionado el botón de alimentación del cuerpo del proyector o del mando a distancia durante 2 segundos para apagarlo.

3.2 Modo de batería (cuando está desenchufado)

- Presione el botón de alimentación situado en el cuerpo del proyector o en el mando a distancia para apagarlo.
- * El modo batería no admite el modo En espera.

4. Emparejamiento del control remoto

- Encienda el proyector y espere a que aparezca el mensaje de sincronización con Bluetooth en la pantalla.
- Acerque el control remoto a no más de 10 cm / 0.33 pies del proyector.
- Simultáneamente presione y mantenga presionados los botones  y .
- Suelte los botones cuando la luz indicadora empiece a parpadear.
- Espere hasta oír dos "bips" que indican una sincronización exitosa.

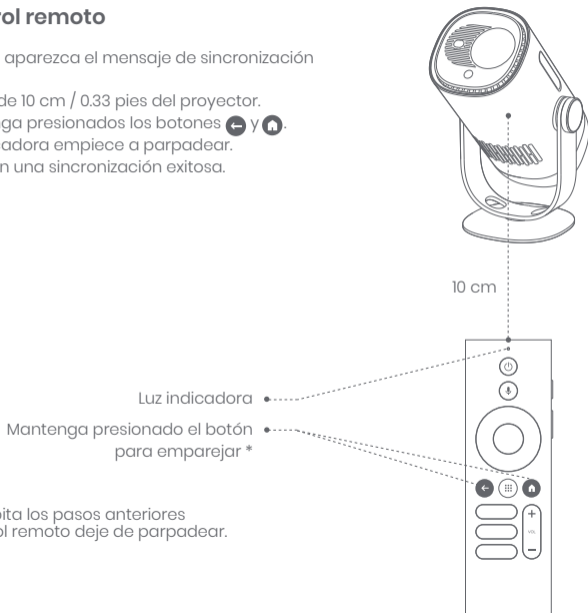

* Si no se logra el emparejamiento, repita los pasos anteriores hasta que la luz indicadora del control remoto deje de parpadear.

Ajustes de red

- Vaya a [Ajustes], seleccione [Red e Internet] y active la función Wifi.
- Elija la red e introduzca la contraseña correcta.



Ajustes de enfoque

Método 1: Para enfoque manual, presione el botón lateral rojo (arriba); para enfoque automático, manténgalo presionado por 2 segundos.

Método 2: Vaya a [Proyector], seleccione [Enfoque] y elija entre enfoque manual o enfoque automático.

Enfoque automático

Para activar la función de enfoque automático seleccione [Enfoque automático]. La imagen se aclarará automáticamente.

Enfoque manual

Seleccione [Enfoque Manual] y utilice los botones de navegación (arriba/abajo) del control remoto, para ajustar la distancia de enfoque y obtener una imagen nítida.



Ajustes de corrección de imagen

1. Corrección trapezoidal

- Vaya a [Proyector] -- [Corrección de imagen].
- Seleccione [Corrección trapezoidal automática], y la pantalla se corregirá automáticamente.
- Seleccione [Corrección trapezoidal manual], y use las teclas de navegación para ajustar los cuatro puntos y la forma de la imagen.



2. Adaptación inteligente de pantalla

- Vaya a [Proyector] -- [Corrección de imagen] y active [Ajustar a la pantalla].
- Siga las instrucciones en pantalla para que la imagen proyectada se adapte de manera automática a la pantalla.
- Esta función solamente admite cortina 16:9.

3. Evasión inteligente de obstáculos

- Vaya a [Proyector] -- [Corrección de imagen] -- [Avanzado] y active [Evitar obstáculos].
- Siga las instrucciones en pantalla para que la imagen proyectada se ajuste automáticamente de manera tal que evada cualquier objeto sobre la superficie de proyección.

Modo de altavoz Bluetooth

- Vaya a [Ajustes], seleccione [Proyector] y haga clic en [Modo de altavoz Bluetooth].
- Conecte su teléfono al dispositivo de Bluetooth que contenga "DBOD03". Tras modificar el nombre del dispositivo, el nombre de Bluetooth también se sincronizará en conformidad.
- Cuando escuche "Conexión Bluetooth correcta", el proyector podrá reproducir música desde su teléfono.
- Para salir del [Modo de altavoz Bluetooth], mantenga pulsada la tecla  del mando a distancia durante 2 segundos.

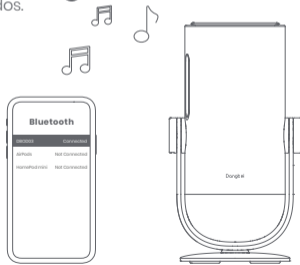

Modo de batería

- Desenchufa el adaptador de alimentación.
- El proyector funciona con una batería integrada. El brillo del proyector cambiará automáticamente al modo ECO, lo que prolongará su vida útil.
- * El modo de batería admite el ajuste a otras opciones de modo de brillo, pero afectará a la vida útil.

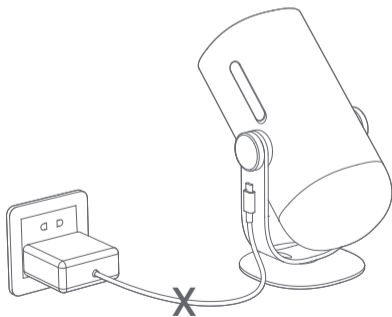

Carga con batería externa

- Desenchufa el adaptador de alimentación.
- Conecte el proyector a la batería externa con un cable de alimentación USB-C.
- * Asegúrese de que el banco de alimentación admite PD3.0 de 65 W y el cable de alimentación USB-C admite PD 65 W y E-mark.

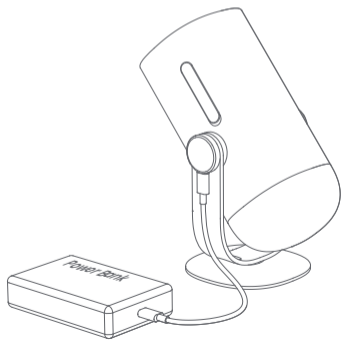

Asistente de Google

Tu televisor es más útil que nunca. Usa tu voz para encontrar películas, transmitir aplicaciones, reproducir música y controlar el televisor. Pregunta a Asistente de Google para encontrar un título específico, buscar por género o recibir recomendaciones personalizadas. Incluso obtén respuestas en pantalla, controla dispositivos inteligentes del hogar y más. Pulsa el botón del Asistente de Google del mando para empezar.

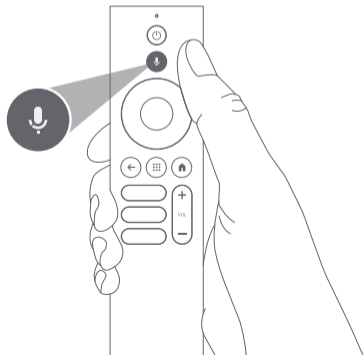

Google Cast™

Envía fácilmente tus películas, música y más a tu TV con Google Cast.

Para transmitir contenido de la aplicación :

Simplemente toca el botón de Cast en las aplicaciones que ya conoces y amas. No se requieren nuevos inicios de sesión ni descargas.

1. Conecta tu dispositivo y el proyector a la misma red inalámbrica.
2. Abre la aplicación de streaming en tu dispositivo.
3. Reproduce un video y toca el botón de Cast en la pantalla del video. 
4. Selecciona "DBOD03" para conectar. El proyector mostrará el video desde tu dispositivo.

*Debido a restricciones de derechos de autor, ciertos contenidos no se pueden transmitir al proyector. Puedes transmitir el contenido en el proyector instalando la misma aplicación en él.

Duplicación de pantalla

Puedes proyectar la pantalla completa de tu dispositivo en el proyector.

Para duplicar la pantalla del dispositivo :

1. Asegúrate de que tanto tu dispositivo como el proyector estén conectados a la misma red inalámbrica.
2. Instala la aplicación AirScreen en el proyector.
3. Abre la aplicación AirScreen y sigue las instrucciones en pantalla para completar el proceso.

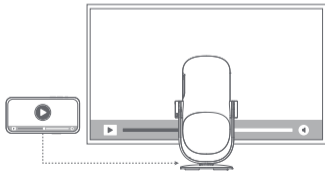

Entradas

HDMI

Enchufe el dispositivo HDMI al puerto HDMI.

Mantenga presionado el botón Inicio del mando a distancia para extraer el panel de control de la parte superior derecha de la pantalla.

Vaya a [Entradas] y seleccione HDMI.

Disco USB

Descargue la aplicación Administrador de archivos de Google Play.

Inserte el disco USB-A en el puerto USB.

Abra la aplicación Administrador de archivos, busque el disco USB y seleccione el contenido que desea abrir.

* Formatos USB admitidos: FAT32 y NTFS.

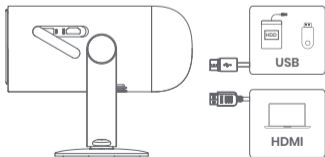

Más ajustes

1. Modo de proyección

Vaya a [Ajustes] -- [Proyector] -- [Configuración avanzada] -- [Modo de proyección] para seleccionar el método de colocación del proyector.

2. Zoom

Vaya a [Ajustes] -- [Proyector] -- [Corrección de imagen] -- [Adaptar imagen] -- [Zoom] para reducir el tamaño de la imagen del 100% al 50%.

3. Información del sistema y del producto

Vaya a [Ajustes] -- [Sistema] -- [Información] para comprobar la información del sistema y del producto.

* Para asegurar una actualización sin problemas, utilice el adaptador para evitar cualquier problema causado por un corte inesperado.

Especificaciones

Tecnología de pantalla	0.23 pulgadas, DLP	Versión Bluetooth	5.1
Risoluzione dello schermo	1920 x 1080	Wi-Fi	Frecuencia dual 2.4/5.0 GHz
Relación de proyección	1.2 : 1	Dimensiones (L x An x Alt)	131 x 109 x 239 mm 5.16 x 4.29 x 9.4 pulgadas
Altavoz	6W	Peso	1.4kg / 3.08lb

Resolución de problemas

1. No hay salida de sonido

- Comprueba si has presionado dos veces la tecla negra en el costado del control remoto, lo que podría haber silenciado el proyector.
- Compruebe si la interfaz "HDMI 1 (eARC)" del proyector o Bluetooth están conectadas a algún dispositivo externo de sonido.

2. No hay salida de imagen

- Presiona el botón de encendido ubicado en la parte trasera del proyector. El indicador luminoso del botón de encendido se apagará si el proyector entra con éxito en el modo de proyección.
- Asegúrese de que el adaptador de corriente tenga salida de corriente.

3. Sin red

- Ingrese a los ajustes y averigüe el estado de la conexión de red en las opciones de red.
- Asegúrese de que el cable de red esté correctamente insertado en la interfaz "LAN" del proyector.
- Asegúrese de que el enrutador esté configurado correctamente.

4. Imagen borrosa.

- Ajuste el enfoque o la corrección trapezoidal.
- El proyector y la pantalla/pared deben quedar a una distancia efectiva.
- La lente del proyector no está limpia.

5. La imagen no es rectangular

- Coloque el proyector en sentido perpendicular a la pantalla/pared si no utiliza la función de corrección trapezoidal.
- Utilice la función de corrección trapezoidal para ajustar la pantalla.

6. La corrección trapezoidal automática falló

- Asegúrese de que la cámara/TOF del panel frontal no esté obstruida ni sucia.
- La distancia óptima para una corrección trapezoidal automática es de 2,0 a 4,0m, horizontal $\pm 30^\circ$.

7. Fallo del enfoque automático

- Asegúrese de que la cámara/TOF del panel frontal no esté obstruida ni sucia.
- La distancia óptima para un enfoque automático es de 2,0 a 3,5m, horizontal $\pm 20^\circ$.

8. Fallo en la protección ocular inteligente

- Asegúrese de que la cámara/TOF en el panel frontal no esté bloqueada o sucia.
- El rango óptimo de detección se encuentra alrededor del centro de la imagen. De hallarse muy cerca de los bordes, puede que la función de protección ocular no se active.

9. Fallo de la adaptación inteligente de pantalla

- Asegúrese de que el proyector esté colocado correctamente, de modo tal que la imagen proyectada se extienda más allá de los bordes de la pantalla.
- Asegúrese de que la pantalla de proyección tenga un borde/marco de color a sus cuatro lados, de modo tal que el proyector pueda reconocer dicho marco.
- Asegúrese de que el patrón de cuadro rojo esté dentro del marco de la pantalla y no esté siendo obstruido.

10. El control remoto no responde

- Asegúrese de que el control remoto se haya sincronizado correctamente a través de Bluetooth. Si el emparejamiento se ha realizado correctamente, la luz LED parpadeará una vez al presionar cualquier botón. Si mantiene presionado cualquier botón, la luz LED permanecerá fija.
- Si la sincronización no se realiza correctamente, la luz LED parpadeará tres veces al presionar cualquier botón. Si mantiene presionado cualquier botón, la luz LED parpadeará tres veces y luego permanecerá fija.
- Verifica si el indicador de encendido permanece encendido sin presionar ningún botón. Si es así, revisa si algún botón del control remoto está atascado.
- Asegúrese de que no haya interferencias u obstrucciones entre el proyector y el control remoto.
- Compruebe la polaridad de las baterías y de la instalación.

11. Cómo conectar otros dispositivos a por Bluetooth

Ingrese a la configuración, abra [Mandos y accesorios] para emparejar varios dispositivos Bluetooth.

12. Otros

No dude en comunicarse con nosotros a la dirección: support@dangbei.com

Declaración

Google TV es el nombre de la experiencia de software de este dispositivo y una marca de Google LLC. Google, YouTube, y Google Cast son marcas de Google LLC.

This equipment has been tested and found to comply with the limits for a Class B digital device, pursuant to Part 15 of the FCC Rules. These limits are designed to provide reasonable protection against harmful interference in a residential installation.

This equipment generates uses and can radiate radio frequency energy and, if not installed and used in accordance with the instructions, may cause harmful interference to radio communications. However, there is no guarantee that interference will not occur in a particular installation. If this equipment does cause harmful interference to radio or television reception, which can be determined by turning the equipment off and on, the user is encouraged to try to correct the interference by one or more of the following measures:

- Reorient or relocate the receiving antenna.
- Increase the separation between the equipment and receiver.
- Connect the equipment to an outlet on a circuit different from that to which the receiver is connected.
- Consult the dealer or an experienced radio/TV technician for help.

Changes or modifications not expressly approved by the party responsible for compliance could void the user's authority to operate the equipment.

This device operating frequency: 2402-2480MHz (EIRP < 20dBm), 2412-2472MHz (EIRP < 20dBm), 5150-5250MHz (EIRP < 23dBm), 5250-5350MHz (EIRP < 20dBm), 5470-5725MHz (EIRP < 27dBm), 5725-5850MHz (EIRP < 13.98dBm).

 We declares that this device is in compliance with the essential requirements and other relevant provisions of Directive 2014/53/EU.

 Satisfies all the technical regulations applicable to the product within the scope of UK Radio Equipment Regulations (SI 2017/1206); UK Electrical Equipment (Safety) Regulations (SI 2016/1101); and UK Electromagnetic Compatibility Regulations (SI 2016/1091).

 Netflix is a trademark of Netflix, Inc.

 Fabricado con la autorización de Dolby Laboratories. Dolby, Dolby Audio y el símbolo de doble D son marcas registradas de Dolby Laboratories Licensing Corporation.

 Los términos HDMI, HDMI High-Definition Multimedia Interface, la Imagen comercial de HDMI (Trade dress) y los logotipos de HDMI son marcas comerciales o marcas registradas de HDMI Licensing Administrator, Inc.

THIS DEVICE COMPLIES WITH DHHS RULES 21 CFR CHAPTER I SUBCHAPTER J.
CAN ICES-3 (B)/NMB-3 (B)

This Class B digital apparatus complies with Canadian ICES-003.

Cet appareil numérique de classe B est conforme à la norme canadienne ICES-003.

This device contains licence-exempt transmitter(s)/receiver(s) that comply with Innovation, Science and Economic Development Canada's licence-exempt RSS(s). Operation is subject to the following two conditions:

(1) This device may not cause interference.

(2) This device must accept any interference, including interference that may cause undesired operation of the device

L'émetteur/récepteur exempt de licence contenu dans le présent appareil est conforme aux CNR d'Innovation, Sciences et Développement économique Canada applicables aux appareils radio exempts de licence. L'exploitation est autorisée aux deux conditions suivantes :

1.L'appareil ne doit pas produire de brouillage;

2.L'appareil doit accepter tout brouillage radioélectrique subi, même si le brouillage est susceptible d'en compromettre le fonctionnement.

For projectors only

The distance between user and products should be no less than 20cm.

La distance entre l'utilisateur et le produit ne doit pas être inférieure à 20 cm.

5150-5350MHz band is restricted to indoor use only.

La bande de 5150-5350MHz est réservée à l'usage intérieur.



WARNING: This product can expose you to Lead, which is known to the State of California to cause cancer and birth defects or other reproductive harm. For more information go to www.P65Warnings.ca.gov



OST_UK_20220817000004

EVATOST CONSULTING LTD

Office 101 32 Threadneedle Street, London,
United Kingdom, EC2R 8AY
contact@evatmaster.com

We simply act as UK representative for cross-border sellers, and are not manufacturers/importers/distributors for the product, nor involved in the manufacture/import/sale of the product. Therefore, we are not responsible for any after-sales services related to the product. In case of any product quality or infringement issues, the manufacturer/importer/seller shall be solely held responsible.



OST_UK_20220817000007

eVatmaster Consulting GmbH

Bettlinaser.30
60325 Frankfurt am Main, Germany
contact@evatmaster.com

We simply act as EU representative for cross-border sellers, and are not manufacturers/importers/distributors for the product, nor involved in the manufacture/import/sale of the product. Therefore, we are not responsible for any after-sales services related to the product. In case of any product quality or infringement issues, the manufacturer/importer/seller shall be solely held responsible.



EU DECLARATION OF CONFORMITY

Product : Portable Projector

Trademark : Dangbei

Model Designation : DBOD03

Manufacturer's Name : Shenzhen Dangs Science and Technology Co., Ltd.

Manufacturer's Address : 901, GDC Building, Gaoxin Mid 3rd Road, Maling Community, Yuehai Sub-district, Nanshan District, Shenzhen, China.

Manufacturer's Phone : 86-755-26907499

We, Shenzhen Dangs Science and Technology Co., Ltd. declare under our sole responsibility that the above referenced product is in conformity with the applicable requirements of the following directives:

RED Directive : 2014/53/EU

RoHS Directive : 2011/65/EU

(EU) 2015/863

WEEE Directive : 2012/19/EU

REACH Regulation : 2006/1907/EC

Conformity with these directives has been assessed for the product by demonstrating compliance to the following harmonized standards and/or regulations:

EN 62311:2008

EN IEC 62368-1:2020+A11:2020

EN 301489-1 V2.2.3 (2019-11)

EN 301489-3 V2.3.2 (2023-01)

EN 301489-17 V3.2.4 (2020-09)

EN 55032:2015+A11:2020

EN 55035:2017+A11:2020

EN 61000-3-2:2019+A1:2021

EN 61000-3-3:2013+A2:2021

EN 301893 V2.1.1 (2017-05)

EN 300440 V2.1.1 (2017-03)

EN 300328 V2.2.2 (2019-07)

2011/65/EU, (EU) 2015/863

2006/1907/EC

2012/19/EU

Signed for and on behalf of: Shenzhen Dangs Science and Technology Co., Ltd.

Place: Shenzhen, China

Date: 2024-02-07

Name: Libing Zhang

Position: Certification Engineer

Signature:

Libing Zhang

言語

English	01-24
Deutsch	25-48
Français	49-72
Italiano	73-96
Español	97-120
日本語	121-143

目次

使用前に必ずお読みください	122
重要な注意事項	123
梱包内容	124
プロジェクター外観	125
電源ボタンのLEDインジケータについてのガイダンス	127
リモコン概要	129
操作	130
ネットワーク設定	133
フォーカス設定	133
キーストーンの自動補正	134
Bluetoothスピーカーモード	135
バッテリーモード	135
パワーバンクで充電	136
Google アシスタント	136
Google Cast™	137
スクリーンミラーリング	137
入力	138
その他	138
仕様	139
トラブルシューティング	140
ステートメント	142

使用前に必ずお読みください

プロジェクターを操作する前に、この取扱説明書をお読みください。

この度は弊社製品をお買い上げ頂き誠にありがとうございます。

本装置を安全にご使用いただくために、このガイドおよび装置のマークに記載されている指示に従ってください。

製品の注意事項については次のとおりです。

本製品取扱書に記載されている商標ならびに製品名は弊社に帰属します。

表示されているすべてのイラストは、あくまでも商品説明のためのものです。製品の向上のため、実際の製品とは異なる場合があります。

お客様が本取扱説明書や注意事項を守らなかったことにより発生した人身事故、物損事故、その他の損害について、弊社では一切の責任を負いません。

* Dengbeiでは本取扱説明書の解釈ならびに変更する権利を留保します。

重要な注意事項

- ・ プロジェクターを投映中にレンズをのぞかないでください。本製品の投写光はIEC 62471-5:2015のリスクグループ2(RG2)に分類されます。
- ・ 皮膚や角膜の火傷のリスクがあります。クラス1レーザー製品、IEC 60825-1:2014に準拠しています。
- ・ 内部部品の放熱に影響を与え、本体が壊れる恐れがあるため、本体の放熱孔を塞いだり、覆ったりしないでください。
- ・ 高湿、直射日光、高温、低圧、磁気のある環境には置かないでください。
- ・ ちりやほこりの多い場所には置かないでください。
- ・ 平らで安定した台に置き、振動が発生しやすい場所には置かないでください。
- ・ 保護者のいないところでお子様を取り扱わないようにしてください。
- ・ 本体の上に重いものや鋭利なものを置かないでください。
- ・ 内部の部品を損傷させる可能性があるため、極端な振動は避けてください。
- ・ リモコンには正しいタイプの電池をお使いください。
- ・ 付属品やアクセサリ（専用電源アダプター、ブラケットなど）にはメーカーが指定または提供するもののみをお使いください。
- ・ 本体を自らの手で分解しないでください。本体の修理はメーカーで認定された作業者のみが行ってください。
- ・ 本体は5~35°Cの環境下に置き、使用してください。
- ・ 金属のケーシングは絶縁塗料でコーティングされています。
- ・ アダプターのプラグが挿されていないと、電源が入りません。
- ・ アダプターは本体の近くに置き、簡単に取扱いできるようにする必要があります。
- ・ 電源コード、特にプラグやコンセント、本体から出る部分などは、歩いて引っ掛けたりしないように保護してください。
- ・ 雷雨になっているとき、または長期間使用しないときは、本体のプラグを抜いてください。
- ・ 電源プラグや電気器具のカプラから本体の電源を切断した場合、本体を簡単に操作できるような状態にしてください。
- ・ ぬれた手で電源コードやアダプターを決して触らないでください。
- ・ 電池を誤ったタイプに交換すると爆発の危険があります。使用済みの電池は地域の規制に従って廃棄してください。

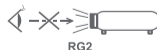

梱包内容

丁寧に開梱し、次に示すものがすべて揃っていることを確認してください。不足しているものがある場合は、お買い上げの販売店にご連絡ください。



プロジェクター本体



リモコン



単4電池

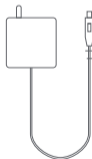

電源アダプター

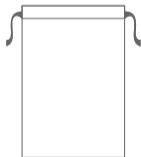

携帯用ポーチ



取扱説明書

プロジェクター外観

概要及びインターフェースの説明。

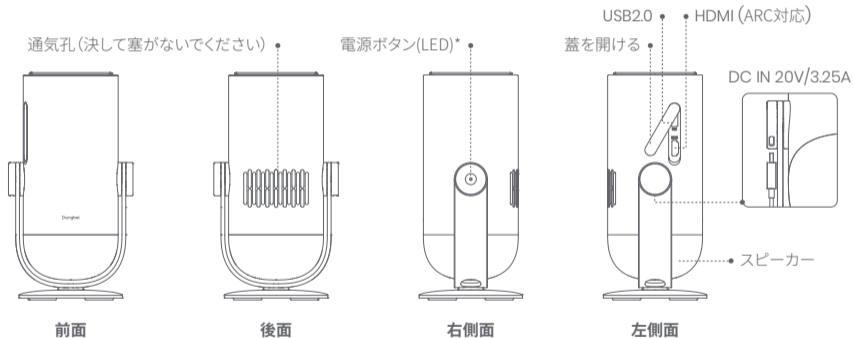

PTZブラケット用ソケット

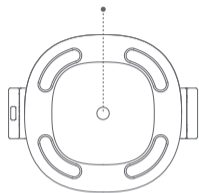

底面

通気孔
(決して塞がないでください)

通気孔

TOF

カメラ

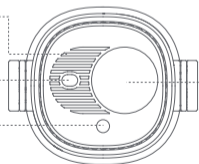

レンズ

上面

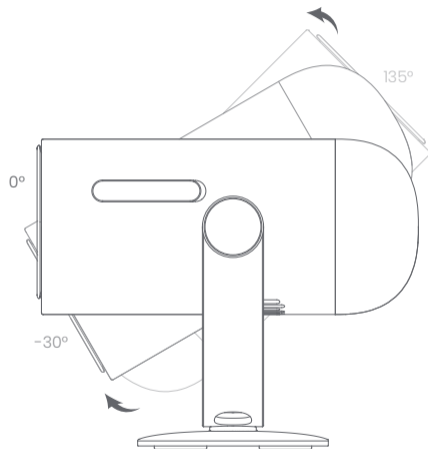

傾斜角度の範囲: -30°から+135°

電源ボタンのLEDインジケータについてのガイドンス

シナリオ		デバイスの状態	バッテリー容量	LEDインジケーター
投影モード	アダプターで充電	スタンバイモード	=100%	白: プリージングライト
			=70%~99%	緑: 点滅
			=20%~69%	オレンジ: 点滅
			≤19%	赤: 点滅
		電源オフ	=100%	オフ
			=70%~99%	緑: 点滅
			=20%~69%	オレンジ: 点滅
			≤19%	赤: 点滅
	電源オン	=100%	白: 常時点灯	
		=70%~99%		
		=20%~69%		
		≤19%		

シナリオ		デバイスの状態	バッテリー容量	LEDインジケーター
投影モード	バッテリーモード (プラグを抜いている状態)	電源オフ	=100%	オフ
			=70%~99%	オフ
			=20%~69%	オフ
			≤19%	オフ
		電源オン	=100%	オフ
			=70%~99%	緑: 常時点灯
			=20%-69%	オレンジ: 常時点灯
			≤19%	赤: 点滅
	バッテリー容量検査 (プロジェクターの電源 ボタンを短押しする、 バッテリーモードのみ)	電源オフ	=70%~100%	緑: 押すたびに一度点灯します
			=20%~69%	オレンジ: 押すたびに一度点灯します
≤19%			赤: 押すたびに一度点灯します	
Bluetoothオーディオモード		Bluetoothオーディオモードへの切り替え	N/A	青: プリージングライト
		ペアリング待ち	N/A	青: プリージングライト
		接続成功	N/A	青: 常時点灯
		投影モードへの切り替え	N/A	プロジェクションモードのLEDインジケーターを参照

リモコン概要

- ・リモコン本体の電池カバーを開けます。
- ・単4電池2本をセットします*。
- ・電池カバーをもとに戻します。

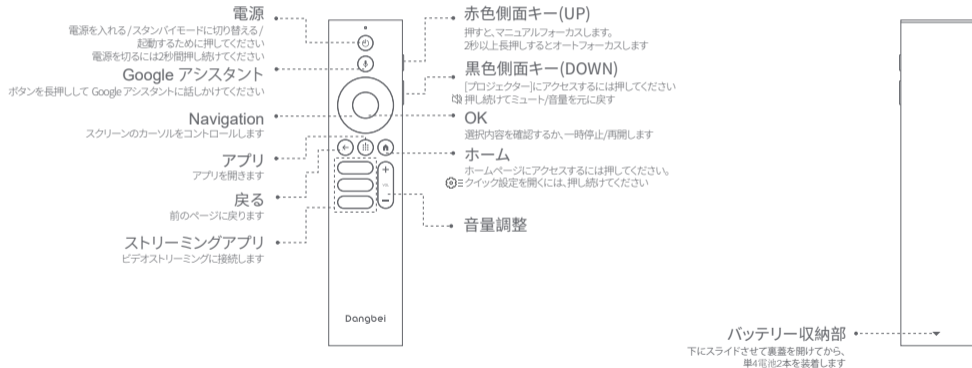

* 極性表示に従って 新しい電池をセットしてください。

操作

1. 設置方法

プロジェクターは安定した平らな面で、投影面の手前に置きます。
 投影面は、平らで白いものを推奨します。
 以下の手順で、プロジェクターと投写面との距離、
 対応する投写サイズを確認ください。

寸法	スクリーン 長さ(L)×幅(W)
60 インチ	133 x 75 cm 4.36 x 2.46 ft
80 インチ	177 x 100 cm 5.8 x 3.28 ft
100 インチ	221 x 124 cm 7.25 x 4.06 ft
120 インチ	265 x 149 cm 8.69 x 4.88 ft



投影サイズは80インチが最適です。

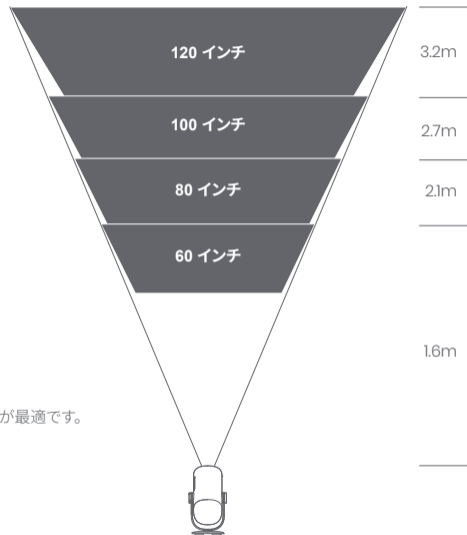

2.電源オン (初めて使用する際は、付属のアダプターでプロジェクターをフル充電します。)

2.1 接続アダプターを使用する場合

- ・プロジェクター接続アダプターを電源に差し込みます。
- ・プロジェクター本体またはリモコンの電源ボタンを押して、電源を入れます。
- * リモコンのペアリング前は、プロジェクター本体の電源ボタンからのみ電源を入れることができます。

2.2 バッテリーモード (プラグを抜いているとき)

- ・プロジェクター本体の電源ボタンを2秒間長押しして電源を入れます。
- * バッテリーモードは、リモコンの電源ボタンによる電源オンには対応しません。

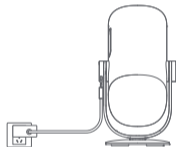

3.スタンバイモード / 電源オフ

3.1 接続アダプターを使用する場合

- ・プロジェクターまたはリモコンの電源ボタンを押して、スタンバイモードに進みます。
- ・プロジェクター本体またはリモコンの電源ボタンを2秒間長押しして、電源をオフにします。

3.2 バッテリーモード (プラグを抜いているとき)

- ・プロジェクター本体またはリモコンの電源ボタンを押して電源を切ります。
- * バッテリーモードはスタンバイに対応していません。

4.リモコンのペアリング

- プロジェクターの電源を入れ、画面にBluetoothペアリングのプロンプトが表示されるまで待ちます。
- リモコンをプロジェクターから10cm(0.33ft)以内に近づけます。
- **←** キーと **⏻** キーを同時に押し続けます。
- インジケータライトが点滅し始めてからキーを離します。
- ペアリングが成功したことを示す「ピーブ音」が2回鳴るまで待ちます。

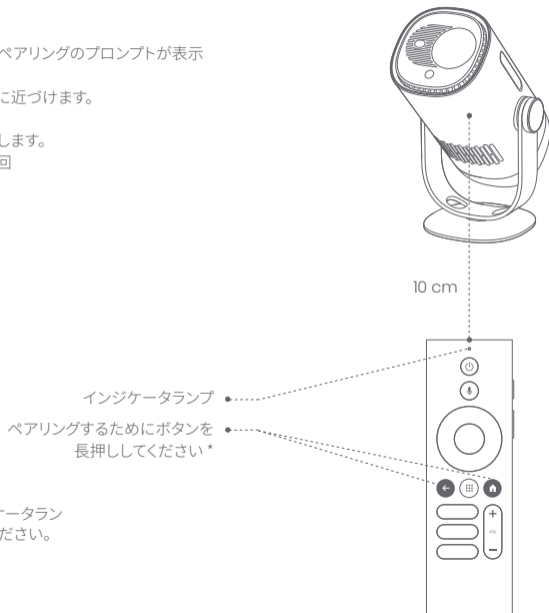

* ペアリングが成功しない場合、リモコンのインジケータランプが点滅をやめるまで上記の手順を繰り返してください。

ネットワーク設定

- ・「設定」>「ネットワークとインターネット」を選択し、Wi-Fi機能を立ち上げます。
- ・ネットワークを選択し、正しいパスワードを入力します。



フォーカスセッティング

方法1: 赤色側面キー(UP)を押すとマニュアルフォーカスします。2秒以上長押しするとオートフォーカスします。

方法2: 「プロジェクター」>「フォーカス」を選択し、マニュアルフォーカスがオートフォーカスを選択します。

オートフォーカス

「自動フォーカス」を選択すると、オートフォーカス機能が起動します。画像は自動で鮮明になります。

マニュアルフォーカス

「手動フォーカス」を選択して、リモコンのナビゲーションキー(UP/DOWN)を使ってピント距離を調整し、画像を鮮明にします。



キーストーンの自動補正

1.自動台形補正

- ・「プロジェクター」>「画像補正」に進みます。
- ・[自動台形補正]を選択すると、画面が自動的に補正されます。
- ・[手動台形補正]を選択して、4つのポイントと画像の形状を調整するためにナビゲーションキーを使用します。

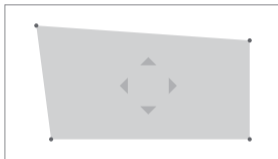

2.スマートスクリーンフィット

- ・「プロジェクター」>「画像補正」に進み、「自動スクリーンフィット」を立ち上げます。
- ・画面の指示に従って、投影されるイメージをスクリーンに合わせて自動的に調整します。
- ・この機能は16:9画面のみをサポートします。

3.スマート障害物回避

- ・「プロジェクター」>「画像補正」>「詳細」に進み、「障害物回避」機能を立ち上げます。
- ・画面の指示に従って、投写面上の物体を避けるように投写イメージを自動調整します。

Bluetoothスピーカーモード

- ・「設定」>「プロジェクター」を選択し、「Bluetoothスピーカーモード」をクリックします。
- ・スマートフォンから「DBOD03」を含むBluetooth名を持つデバイスに接続します。デバイス名を変更した後、Bluetooth名もそれに応じて同期されます。
- ・「Bluetooth接続成功」と表示されると、プロジェクターはスマートフォンから音楽を再生することができます。
- ・リモコンの  キーを2秒間長押しして、「Bluetoothスピーカーモード」を終了します。

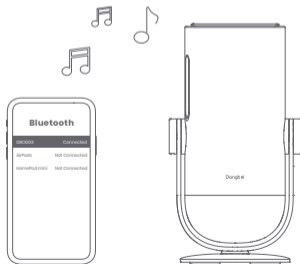

バッテリーモード

- ・電源アダプターを抜きます。
- ・プロジェクターは内蔵バッテリーで駆動します。プロジェクターの明るさは自動的にECOモードに切り替わり、寿命を延ばします。
*バッテリーモードは、他の明るさモードへの調整もサポートしますが、寿命に影響を及ぼします。

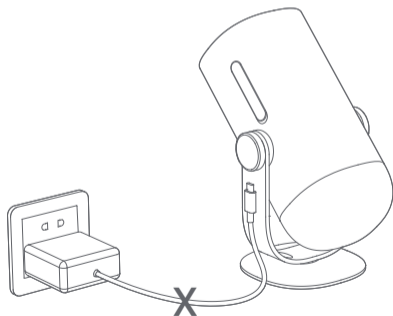

パワーバンクで充電

- ・ 電源アダプターを抜きます。
- ・ USB-C電源コードでプロジェクターとパワーバンクを接続します。
*パワーバンクがPD3.0 65Wをサポートし、USB-C電源コードがPD 65WおよびEマークをサポートしていることを確認してください。

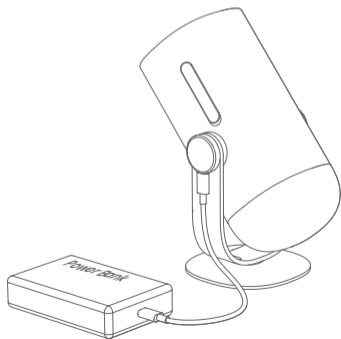

Google アシスタント

あなたのテレビは、さらに便利になりました。声で映画の検索やアプリのストリーミング、音楽の再生、テレビの操作ができます。聞きたいことを Google にタイトルやジャンルで検索を頼んだり、「何を見たい?」と言ってパーソナライズされたおすすめを尋ねましょう。調べ物やスマートホーム デバイスの操作なども、Google に頼むことができます。リモコンのボタンを押して、始めましょう。

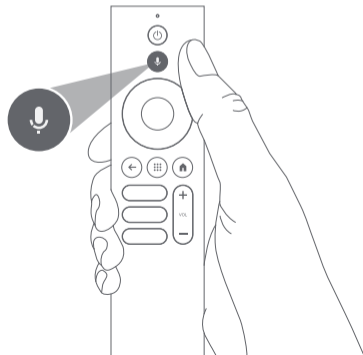

Google Cast™

Google Castを使って、お気に入りの映画、音楽などを簡単にテレビにキャストできます。

アプリ内コンテンツをキャストするには:

お気に入りのアプリで、キャストボタンをタップするだけ。新たなログインやダウンロードは不要です。

1. デバイスとプロジェクターを同じ無線ネットワークに接続します。
2. デバイス上のストリーミングアプリを開きます。
3. ビデオを再生し、ビデオ画面でキャスト ボタンをタップします。 
4. 「DBOD03」を選択して接続します。プロジェクターはデバイスからビデオを表示します。

*著作権の制約により、特定のコンテンツはプロジェクターにキャストすることができません。

同じアプリケーションをプロジェクターにインストールすることで、コンテンツをプロジェクター上でストリーミングできます。

スクリーンミラーリング

デバイスの全画面をプロジェクターに映すことができます。

デバイスの画面をキャストするには:

1. デバイスとプロジェクターが同じ無線ネットワークに接続されていることを確認してください。"
2. プロジェクターにAirScreenアプリをインストールしてください。
3. AirScreenアプリを開き、画面上の指示に従ってプロセスを完了してください。

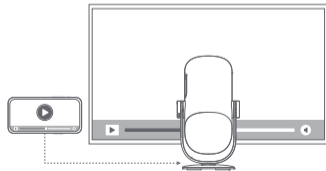

入力

HDMI

HDMIデバイスをHDMIポートに差し込みます。
リモコンのホームボタンを長押しすると、画面右上のコントロールパネルが現れます。

「入力」でHDMIを選択します。

USBディスク

Google Playからファイルマネージャーアプリをダウンロードします。
USB-AディスクをUSBポートに挿入します。
ファイルマネージャーアプリを開き、USBディスクを見つけ、開きたいコンテンツを選択します。

*USBフォーマット対応: FAT32、NTFS。

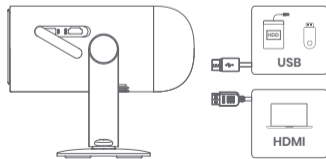

その他

1. プロジェクションモード

「設定」>「プロジェクター」>「詳細設定」>「プロジェクションモード」と進み、プロジェクターの設置方法を選択します。

2. ズーム

「設定」>「プロジェクター」>「画像補正」>「画像変換」>「ズーム」と進むと、画像サイズを100%から50%に縮小できます。

3. システムおよび製品情報

「設定」>「システム」>「デバイス情報」と進むと、システムと製品情報が確認できます。

* システムアップグレードをスムーズに行うため、電源アダプターを使用して電源を供給し、予期しない停電による問題を防いでください。

仕様

ディスプレイ技術	DLP 0,23インチ	Bluetoothバージョン	5.1
ディスプレイ解像度	1920 x 1080	Wi-Fi	2.4/5.0 GHzデュアル周波数
スローレシオ	1.2:1	寸法(LxWxH)	131 x 109 x 239 mm 5.16 x 4.29 x 9.4 インチ
スピーカー	6W	重量	1.4kg / 3.08lb

トラブルシューティング

1. 音声が出力されない

- リモコンの黒いサイドキーを2回押したかどうかを確認してください。それによってプロジェクターがミュートになる可能性があります。
- プロジェクターのインターフェースが「HDMI 1 (eARC)」になっているかどうか、Bluetoothが外部オーディオ端末に接続されているかどうか確認します。

2. イメージが出力されない

- プロジェクターの背面にある電源ボタンを押してください。プロジェクターが正常に投影モードに入ると、電源ボタンのインジケータライトが消灯します。
- 電源アダプターに電源が出力されていることを確認します。

3. ネットワークにつながらない

- 「設定」に入り、ネットワークオプションのネットワーク接続状態を確認します。
- プロジェクターのインターフェース「LAN」にLANケーブルがきちんと挿入されているか確認します。
- ルーターの設定が正しいかどうか確認します。

4. 画像がぼやけている

- フォーカスもしくは台形補正を調整します。
- プロジェクターとスクリーン/壁が有効な距離に置かれているかどうか確認します。
- プロジェクターのレンズが汚れているため、きれいに拭きます。

5. 画像が正方形になっていない

- 台形補正機能を使用していない場合、スクリーン/壁に対してプロジェクターを垂直に設置します。
- 自動台形補正機能を使ってディスプレイを調整します。

6. 自動台形補正に失敗する

- 前面パネルのカメラ/TOFがブロックされていないかまたは汚れていないか確認します。
- 最適な自動台形補正の距離は2.0~4.0m、水平度は±30°です。

7.オートフォーカスに失敗する

- 前面パネルのカメラ/TOFが遮蔽されていないかまたは汚れていないか確認します。
- 最適なオートフォーカスの距離は2.0~3.5m、水平度は±20°です。

8.スマートアイ保護が失敗しました

- フロントパネルのカメラ/TOFがブロックされていないか、汚れていないことを確認してください。
- 最適な検出範囲は画像の中心にあります。端に近づきすぎるとアイ保護機能が作動しない可能性があります。

9.スマートスクリーンフィットに失敗する

- プロジェクターが正確に位置決めされているかどうか確認します。投影されたイメージがスクリーンの端まで拡大されています。
- プロジェクターがフレームを認識できるように、プロジェクションスクリーンの4辺に色のついたボーダー/フレームがあることを確認します。
- 赤枠のパターンが画面枠内にあり、遮蔽されていないことを確認します。

10.リモコンが反応しない

- リモコンはBluetooth経由で正常にペアリングされていることを確認してください。ペアリングが成功していると、どのボタンを押してもLEDライトが一回点滅します。どのボタンを長押ししても、LEDライトは点灯したままになります。
- ペアリングが成功していなければ、どのボタンを押してもLEDライトが三回点滅します。どのボタンを長押ししても、LEDライトは三回点滅した後点灯したままになります。
- どのボタンも押さずに電源インジケータが点灯しているかを確認してください。もしそうであれば、リモコンのボタンが詰まっていないかを確認してください。
- プロジェクターとリモコンの間に遮蔽物や障害がないかどうか確認してください。
- 電池と電池の極性を確認してください。

11. Bluetoothで他のデバイスと接続する方法

「設定」に入り、「リモコンとアクセサリ」を開いて複数の Bluetooth デバイスをペアリングします。

12.その他

弊社support@dangbei.com までお気軽にお問い合わせください。

ステートメント

Google TV は、本デバイスのソフトウェア機能の名称であり、Google LLC の商標です。
Google、YouTube、Google Cast は Google LLC の商標です。

This equipment has been tested and found to comply with the limits for a Class B digital device, pursuant to Part 15 of the FCC Rules. These limits are designed to provide reasonable protection against harmful interference in a residential installation.

This equipment generates uses and can radiate radio frequency energy and, if not installed and used in accordance with the instructions, may cause harmful interference to radio communications. However, there is no guarantee that interference will not occur in a particular installation. If this equipment does cause harmful interference to radio or television reception, which can be determined by turning the equipment off and on, the user is encouraged to try to correct the interference by one or more of the following measures:

- Reorient or relocate the receiving antenna.
- Increase the separation between the equipment and receiver.
- Connect the equipment to an outlet on a circuit different from that to which the receiver is connected.
- Consult the dealer or an experienced radio/TV technician for help.

Changes or modifications not expressly approved by the party responsible for compliance could void the user's authority to operate the equipment.

This device operating frequency: 2402-2480MHz (EIRP < 20dBm), 2412-2472MHz (EIRP < 20dBm), 5150-5250MHz (EIRP < 23dBm), 5250-5350MHz (EIRP < 20dBm), 5470-5725MHz (EIRP < 27dBm), 5725-5850MHz (EIRP < 13.98dBm).

 We declares that this device is in compliance with the essential requirements and other relevant provisions of Directive 2014/53/EU.

 Satisfies all the technical regulations applicable to the product within the scope of UK Radio Equipment Regulations (SI 2017/1206); UK Electrical Equipment (Safety) Regulations (SI 2016/1101); and UK Electromagnetic Compatibility Regulations (SI 2016/1091).

 Netflixは、Netflix, Inc.の登録商標です。

 Dolby Audio ドルビーラポラトリーズの実施権に基づき製造されています。Dolby、ドルビー、Dolby Audio及びダブルD記号は Dolby Laboratories Licensing Corporation の登録商標です。

 HDMI[®] HIGH-DEFINITION MULTIMEDIA INTERFACE HDMI、HDMI High-Definition Multimedia Interfaceという語、HDMIのトレードドレスおよびHDMIのロゴは、HDMI Licensing Administrator, Inc.の商標または登録商標です。

THIS DEVICE COMPLIES WITH DHHS RULES 21 CFR CHAPTER I SUBCHAPTER J.
CAN ICES-3 (B)/NMB-3 (B)

This Class B digital apparatus complies with Canadian ICES-003.

Cet appareil numérique de classe B est conforme à la norme canadienne ICES-003.

This device contains licence-exempt transmitter(s)/receiver(s) that comply with Innovation, Science and Economic Development Canada's licence-exempt RSS(s). Operation is subject to the following two conditions:

(1) This device may not cause interference.

(2) This device must accept any interference, including interference that may cause undesired operation of the device

L'émetteur/récepteur exempt de licence contenu dans le présent appareil est conforme aux CNR d'Innovation, Sciences et Développement économique Canada applicables aux appareils radio exempts de licence. L'exploitation est autorisée aux deux conditions suivantes :

1.L'appareil ne doit pas produire de brouillage;

2.L'appareil doit accepter tout brouillage radioélectrique subi, même si le brouillage est susceptible d'en compromettre le fonctionnement.

For projectors only

The distance between user and products should be no less than 20cm.

La distance entre l'utilisateur et le produit ne doit pas être inférieure à 20 cm.

5150-5350MHz band is restricted to indoor use only.

La bande de 5150-5350MHz est réservée à l'usage intérieur.

Customer Support : support@dangbei.com

For FAQs, user guides in multiple languages to download, and more information, please visit us.dangbei.com

Dangbei

Portable Projector

Model : DBOD03

Input : 20.0V \Rightarrow 3.25A, 65.0W

USB Output : 5V \Rightarrow 1.0A

Manufacturer : Shenzhen Dangs Science and Technology Co., Ltd.

Address : 901, GDC Building, Gaoxin Mid 3rd Road, Maling Community, Yuehai Sub-district, Nanshan District, Shenzhen, China.