



WEDNESDAY



76784





Q LEGO® Builder



LEGO.com/sustainable-packaging



FR
DONNEZ
OU
RECYCLEZ

 OU  OU 

ASSOCIATION MAGASIN DÉCHÈTERIE

Adresses sur quefairedemesdechets.fr

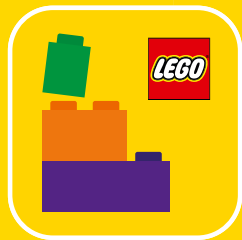

Q LEGO® Builder

BUILDER



Apple and the Apple logo are trademarks of Apple Inc., registered in the U.S. and other countries and regions. App Store is a service mark of Apple Inc. Google Play and the Google Play logo are trademarks of Google LLC. Tencent and the Tencent logo are trademarks of Tencent Inc.

Q [LEGO.com/devicecheck](https://www.lego.com/devicecheck)

EN Ask parents' permission before going online | DE Eltern um Erlaubnis bitten, bevor du online gehst | FR Demande l'autorisation d'un parent avant d'aller en ligne | IT Chiedi il permesso ai tuoi genitori prima di andare online | ES Pídeles permiso a tus papás antes de conectarte a Internet | PT Peça autorização aos pais antes de acederes online | ZH 上网前应先征得父母的同意 | PL Poproś rodziców o zgodę, zanim wejdiesz do Internetu | CS Než půjdeš na internet, požádej rodiče o svolení | SK Skôr než pôjdeš na internet, vypýtaj si povolenie od rodičov | HU Kérj szülői engedélyt, mielőtt online csatlakoznál! | UA Запитуйте дозволу батьків, перш ніж користуватися інтернетом | RO Cere permisiunea părinților înainte de a te conecta online | BG Поискайте разрешение от родител, преди да влезете онлайн | LV Pirms došanās tiešsaistē palūdz atļauju vecākiem | ET Enne Interneti kasutamist küsi vanematelt luba | LT Prieš prisijungdami prie interneto, atsklauskite tėvų



1



2



1



2



3



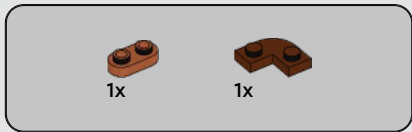

1

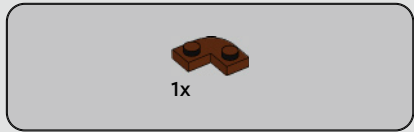
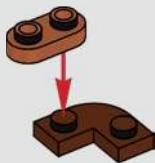

2





2x

3



2x

4





2x



1x

5



2x

6

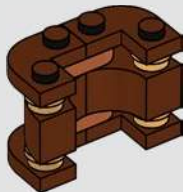

1x

7



8





8

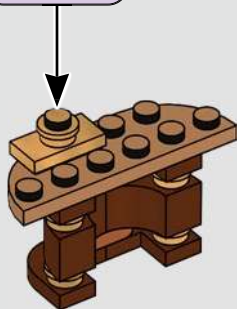
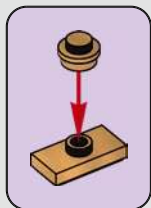

9

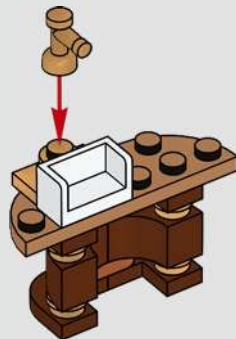



10

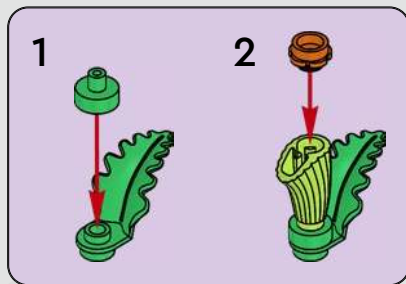

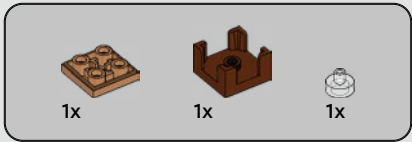

11

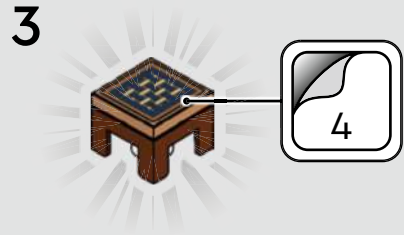
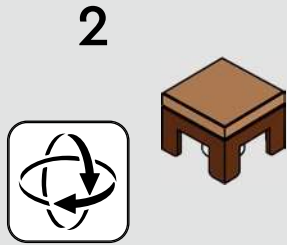
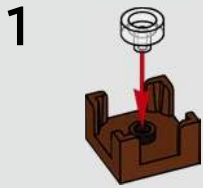

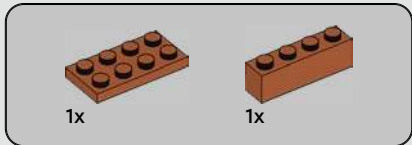

12

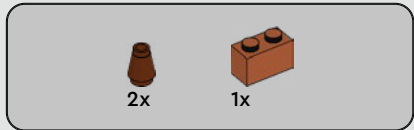
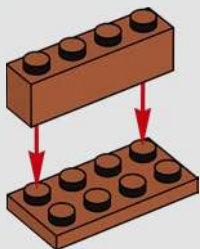

13

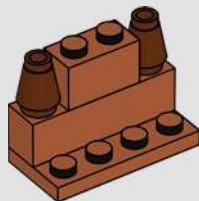

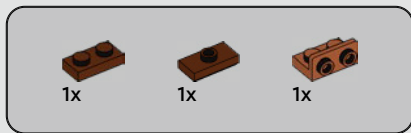

14

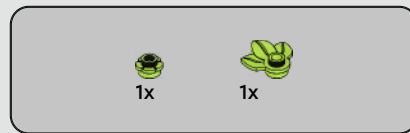
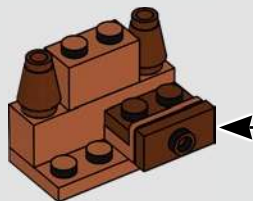
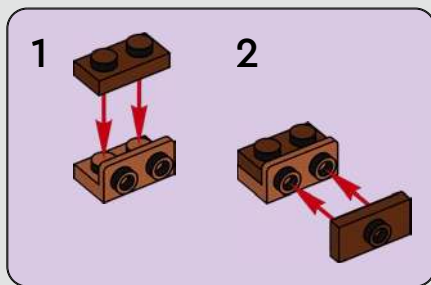

15





2x

16

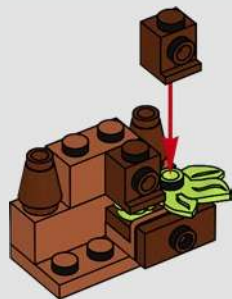

14



1x

17

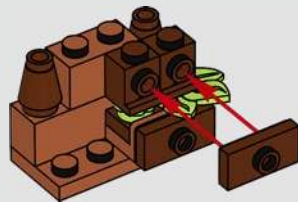



18

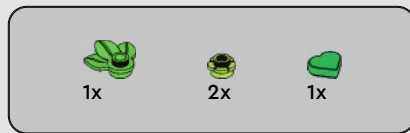
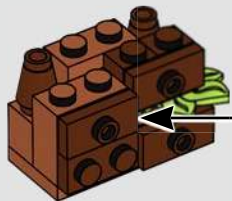
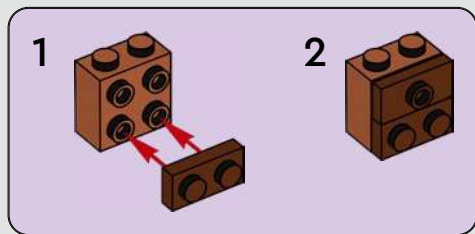

19





1x

20



1x

21



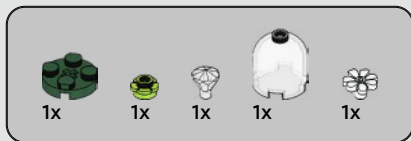

22

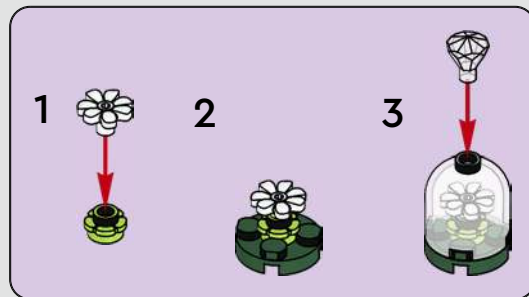



23

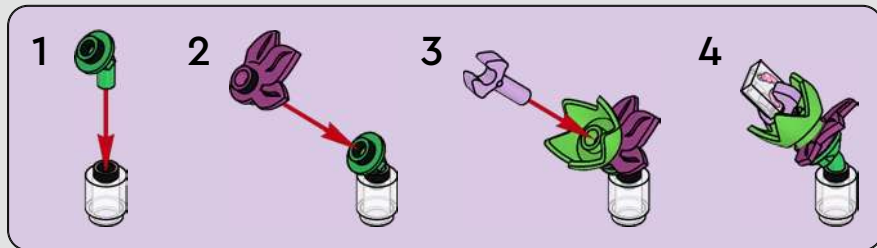

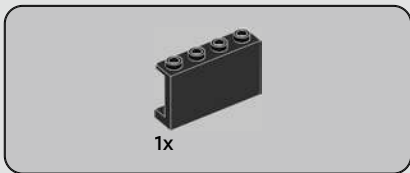
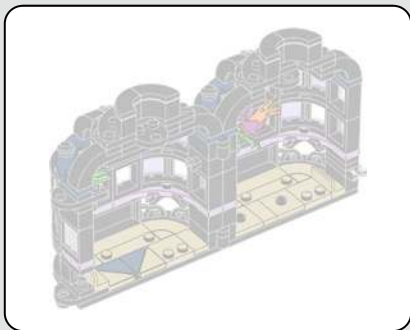

24

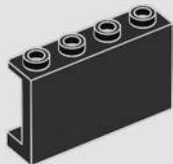

25

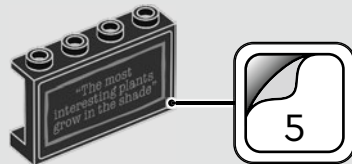

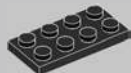

1x

26

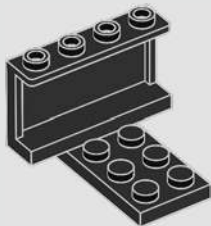

2x

27

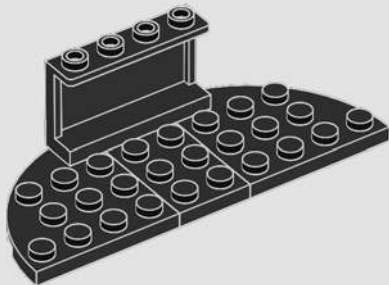

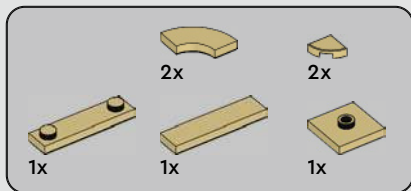

28

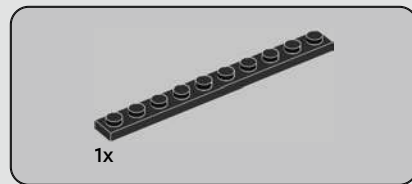
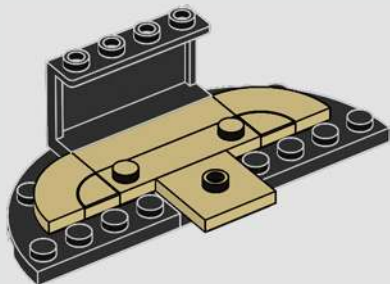

29

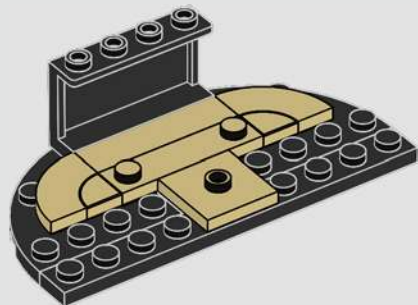

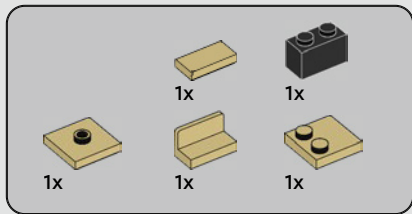

30

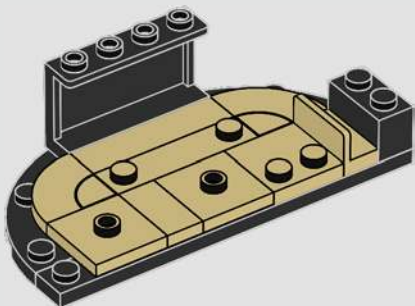

31

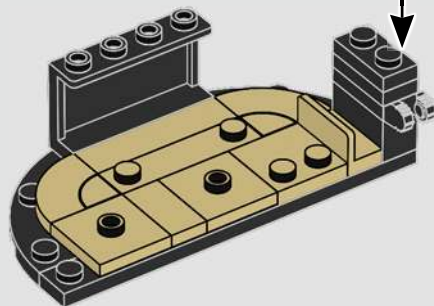
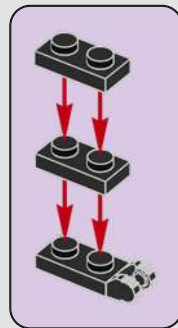



1x



1x

32

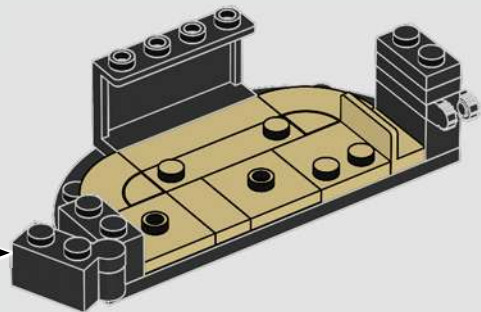
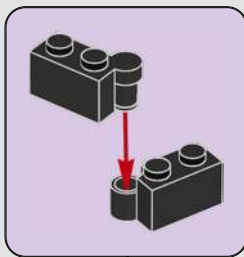

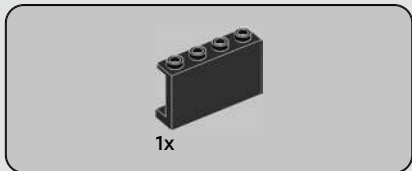

1x

33

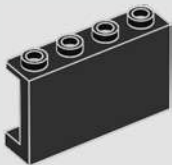

34

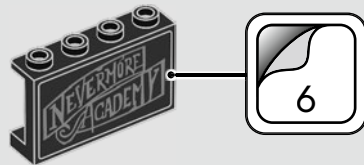



35

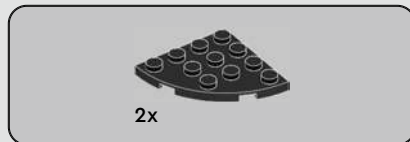

36

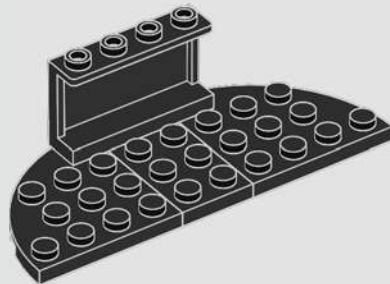

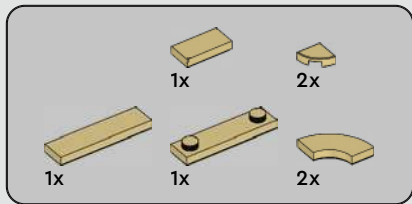

37

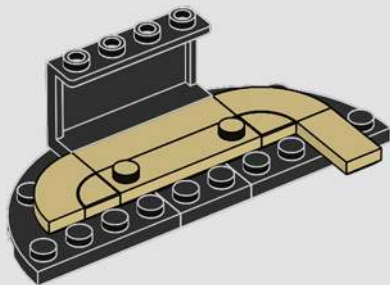

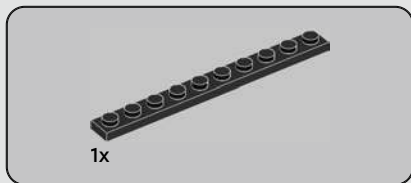

38

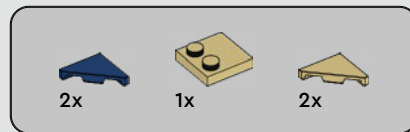
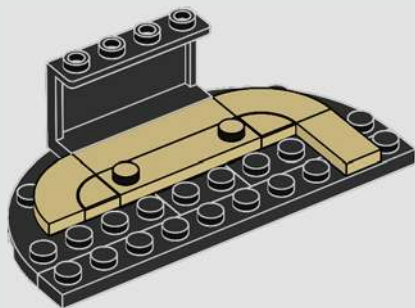

39

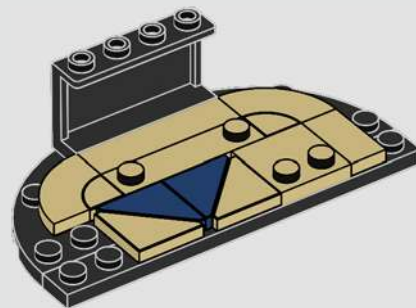



42

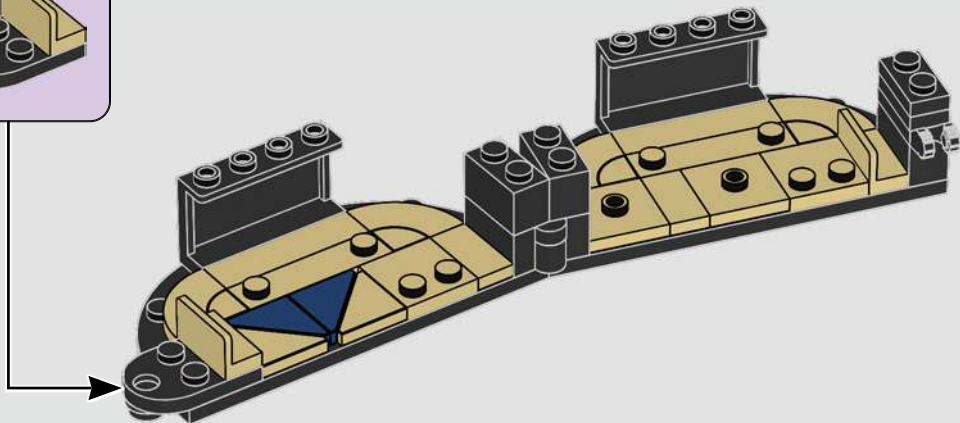
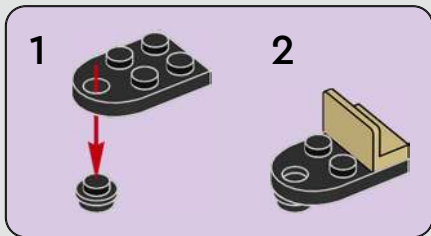



2x



1x

43

1

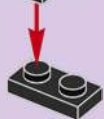

2

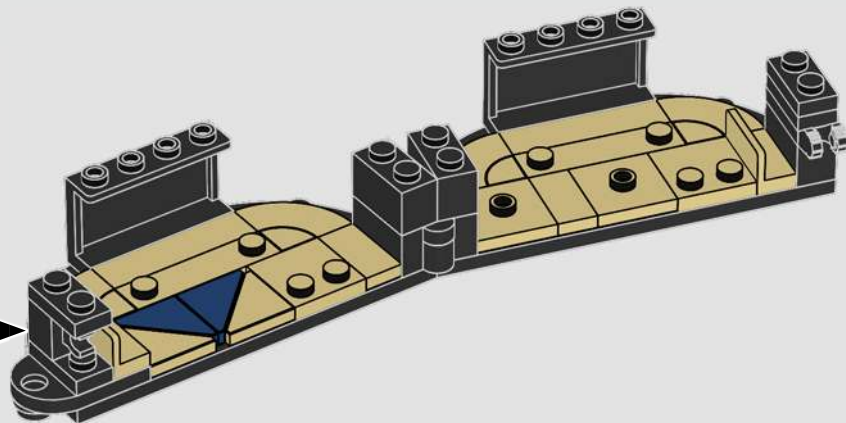



4x

44

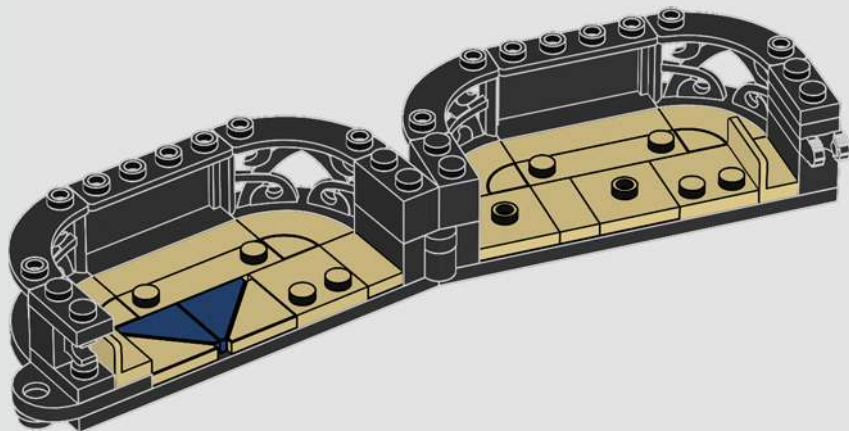



4x

45

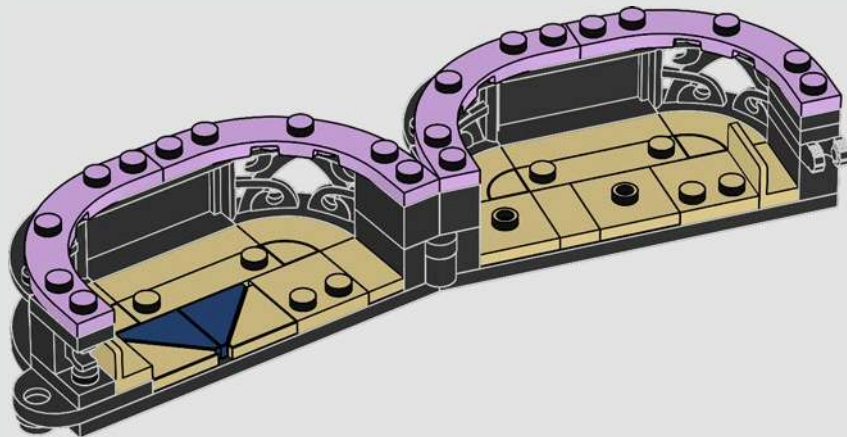

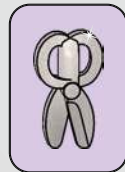
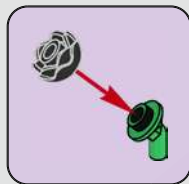
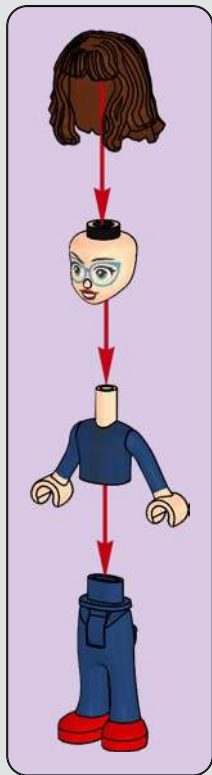

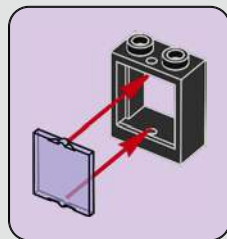
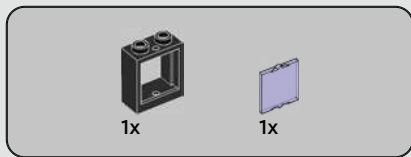

46

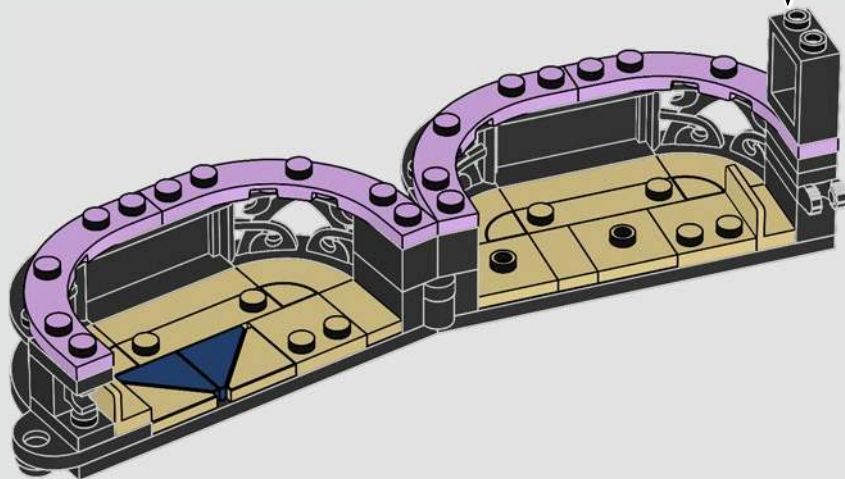

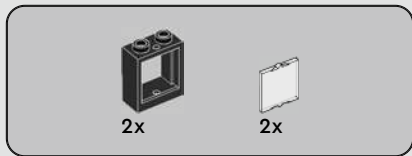

47

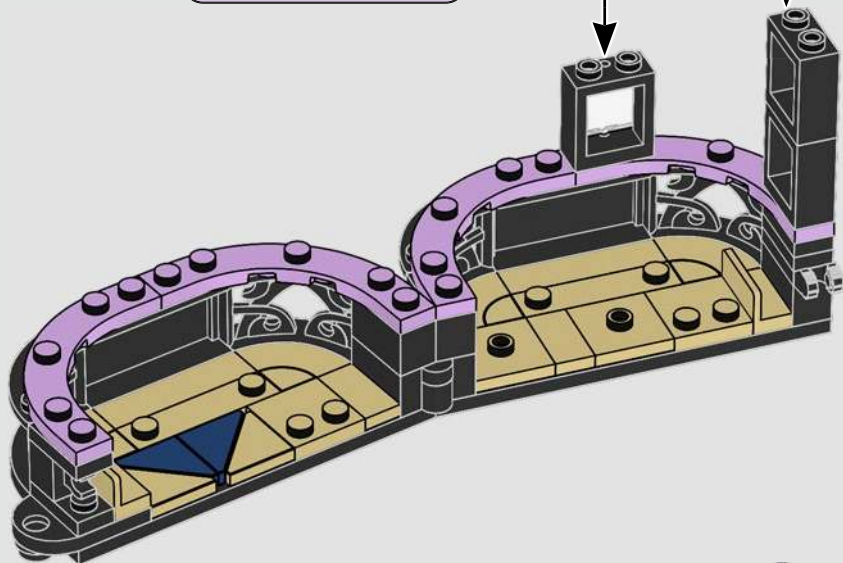
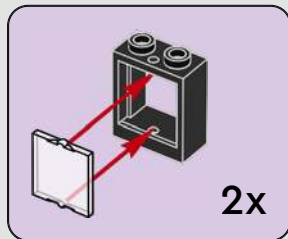

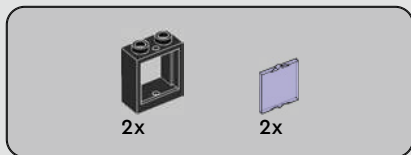

48

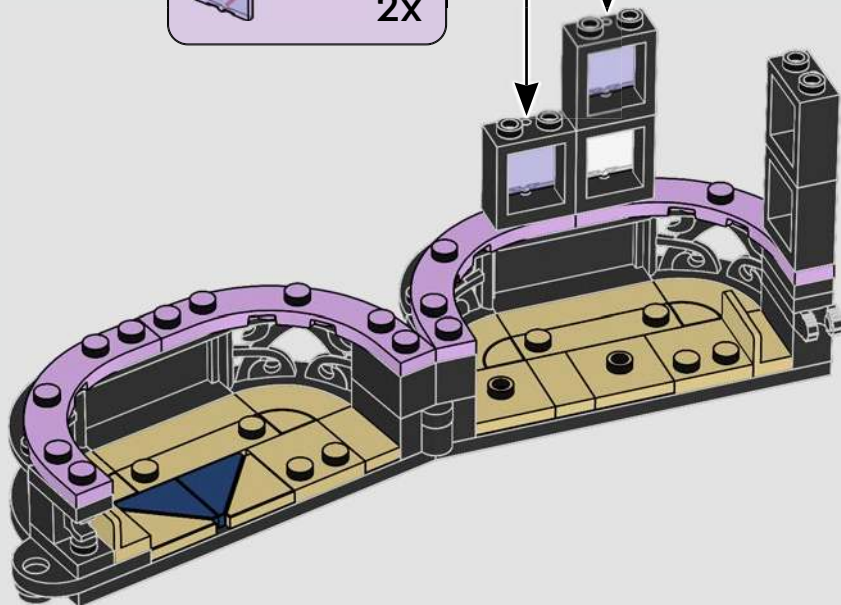
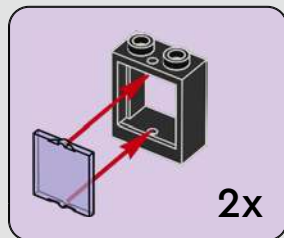

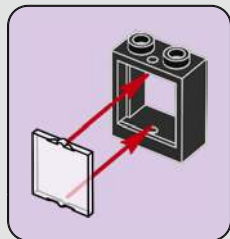
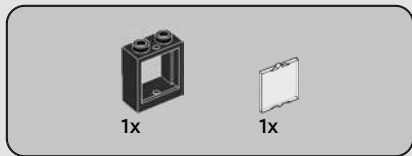

49

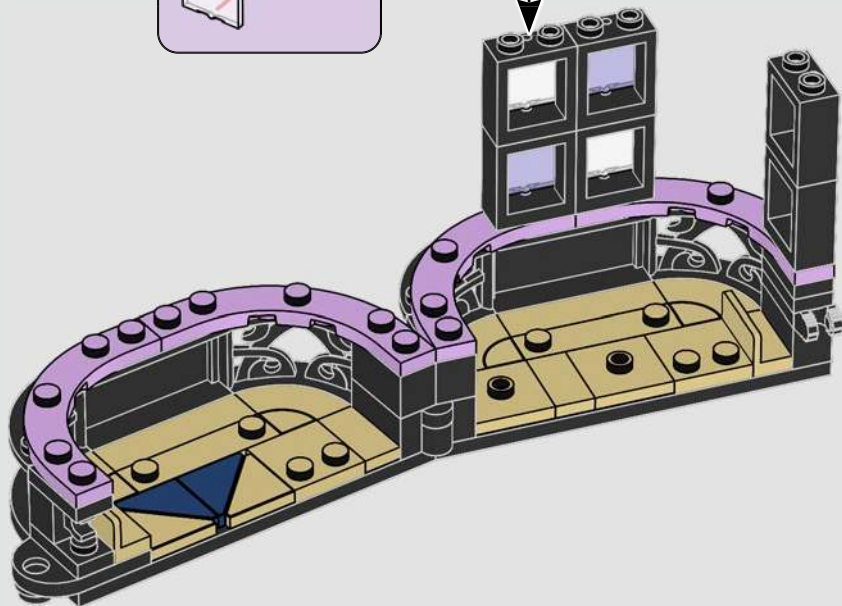

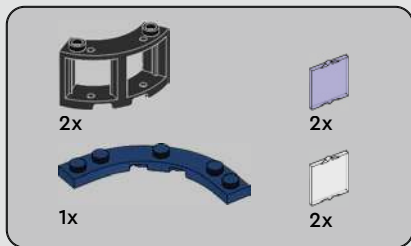

50

1

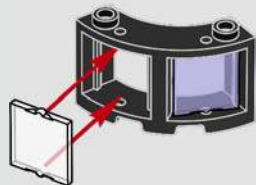

2

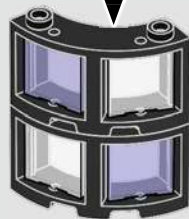

3

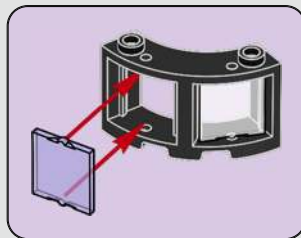
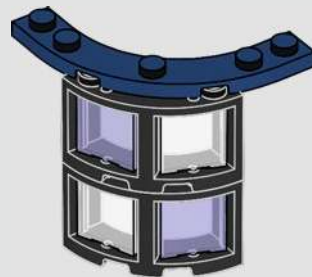

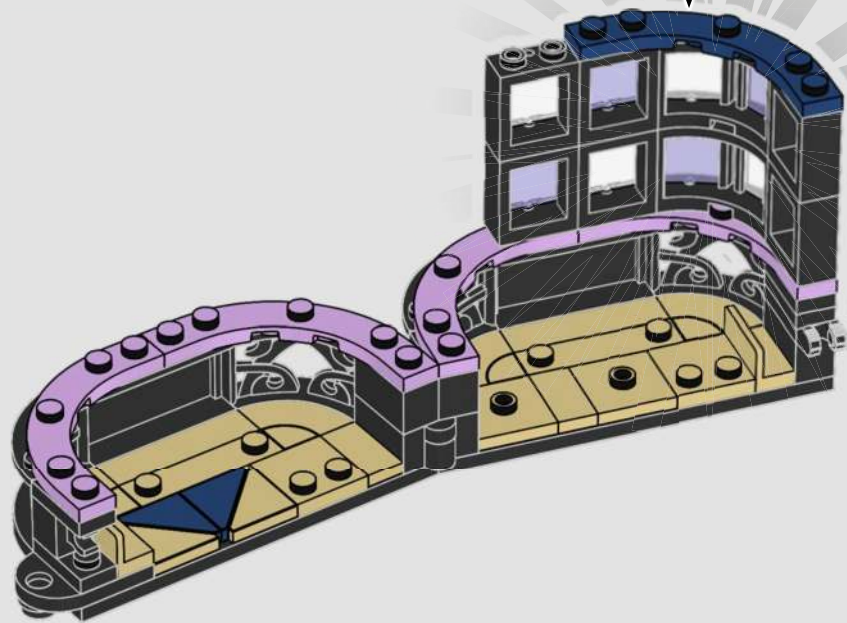

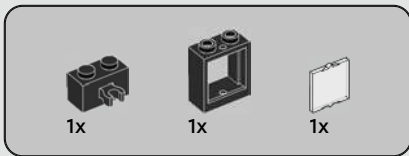

51

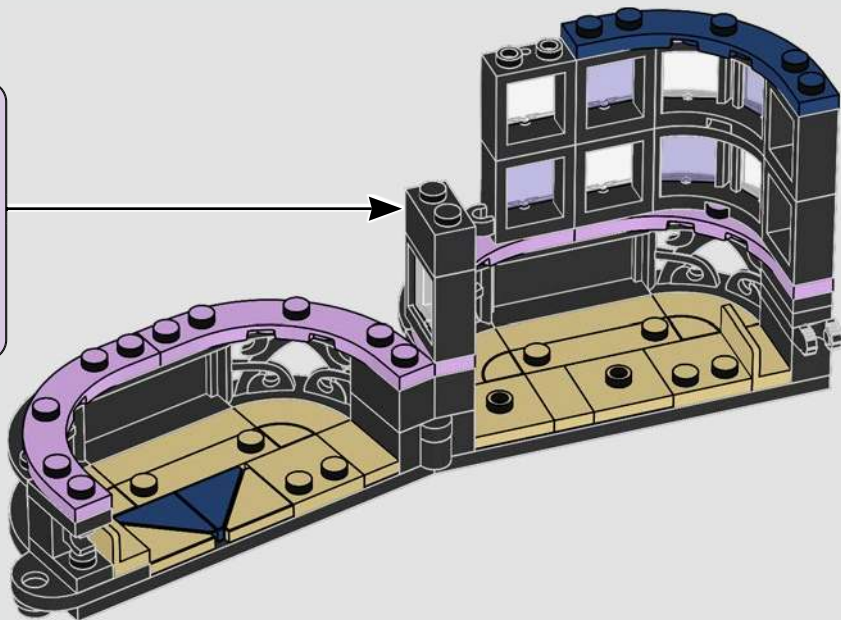
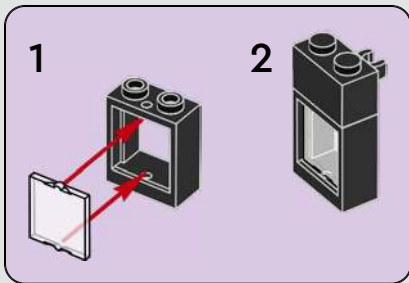

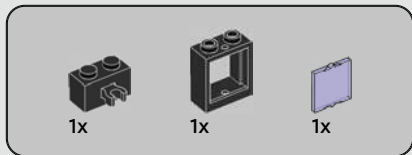

52

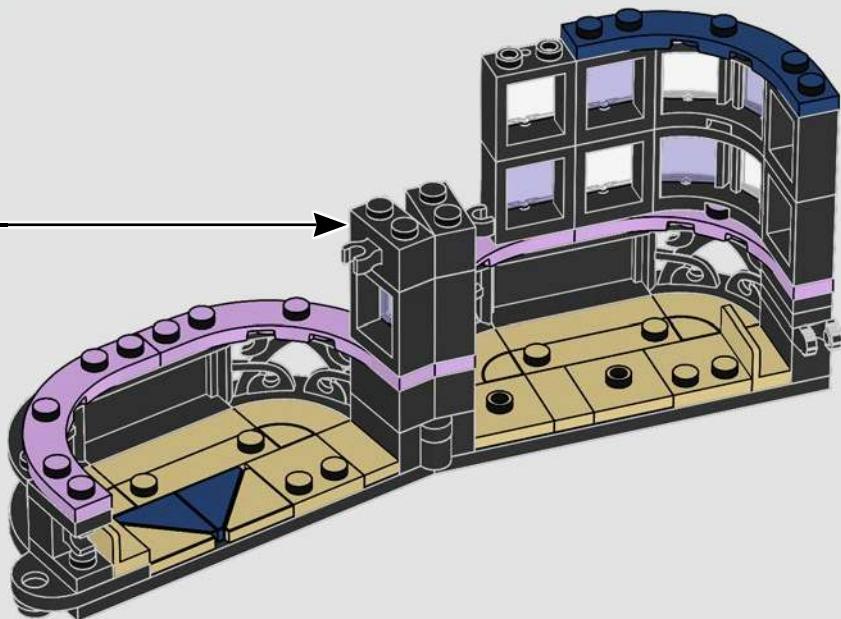
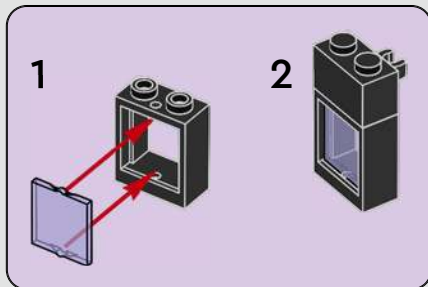



1x



1x

53

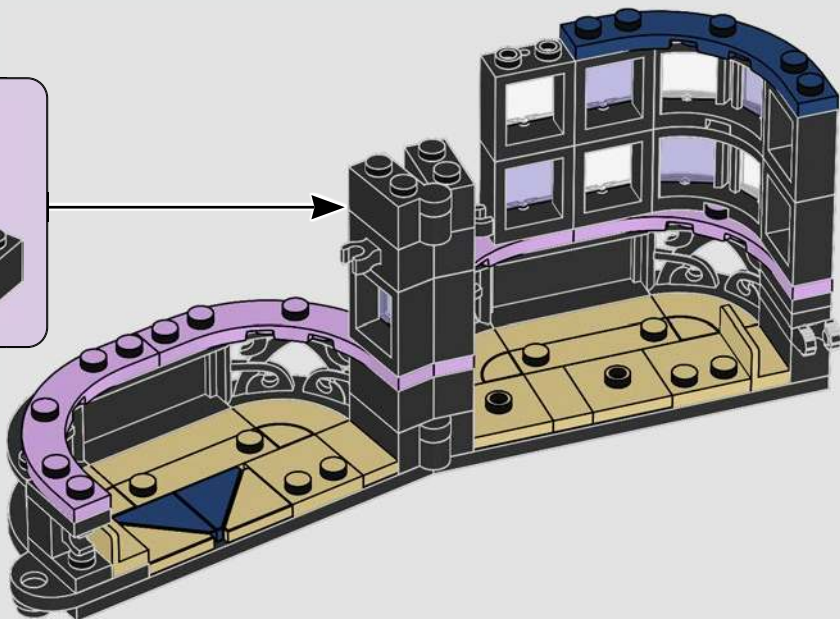
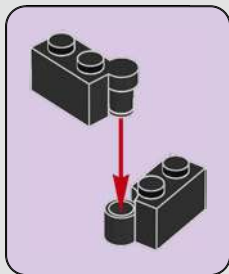

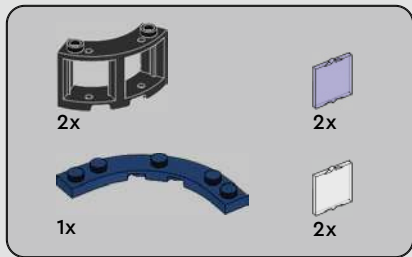

54

1

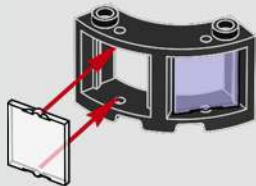

2



3

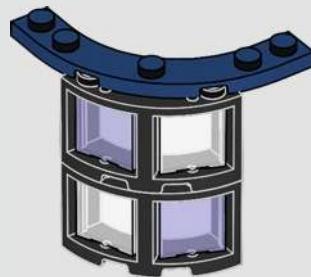

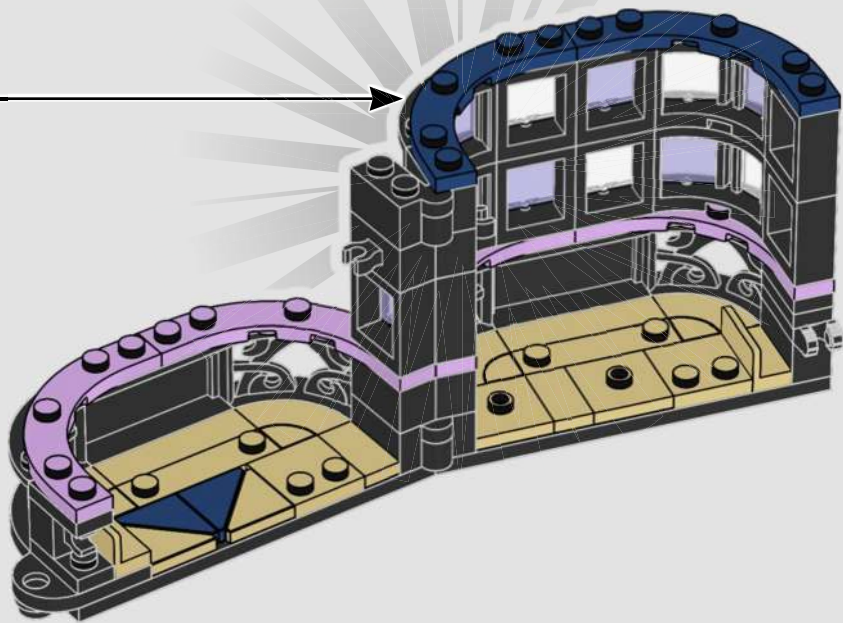

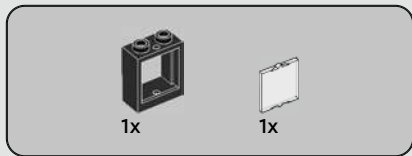

55

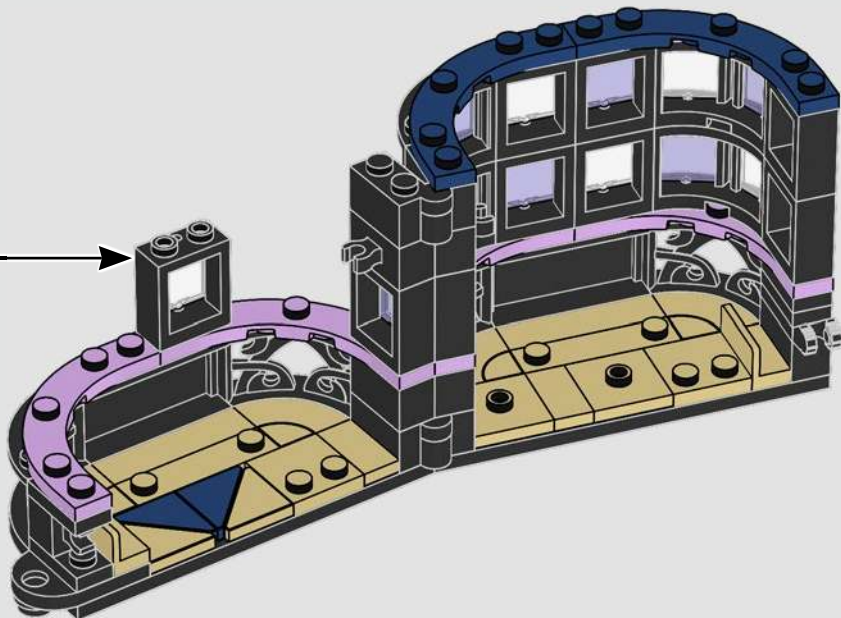
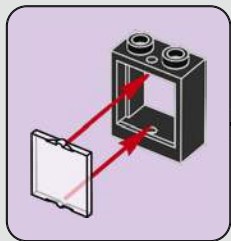

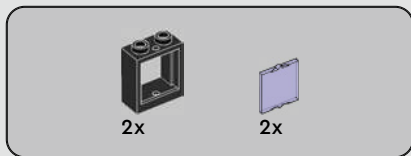

56

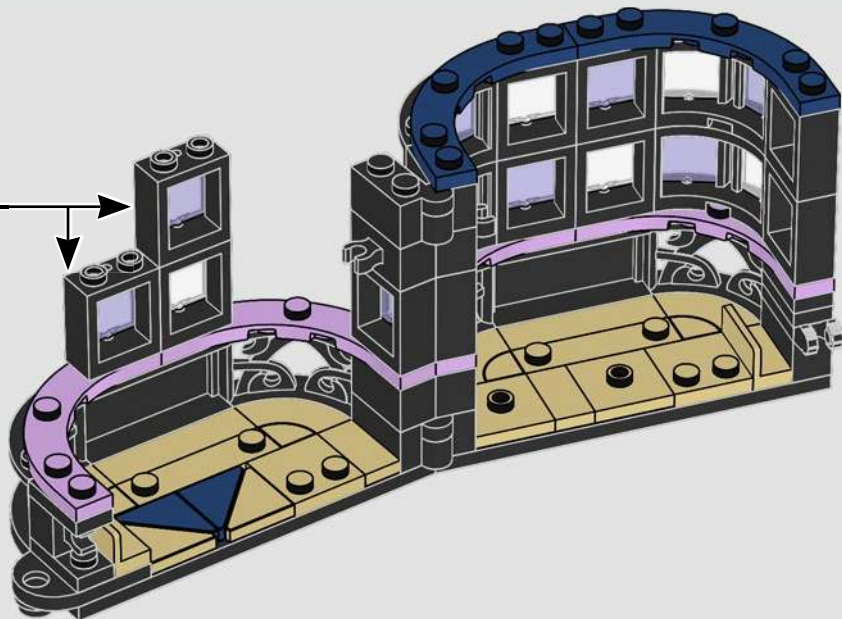
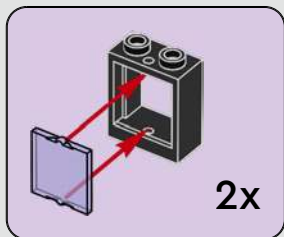

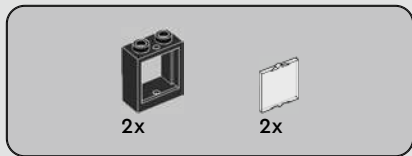

57

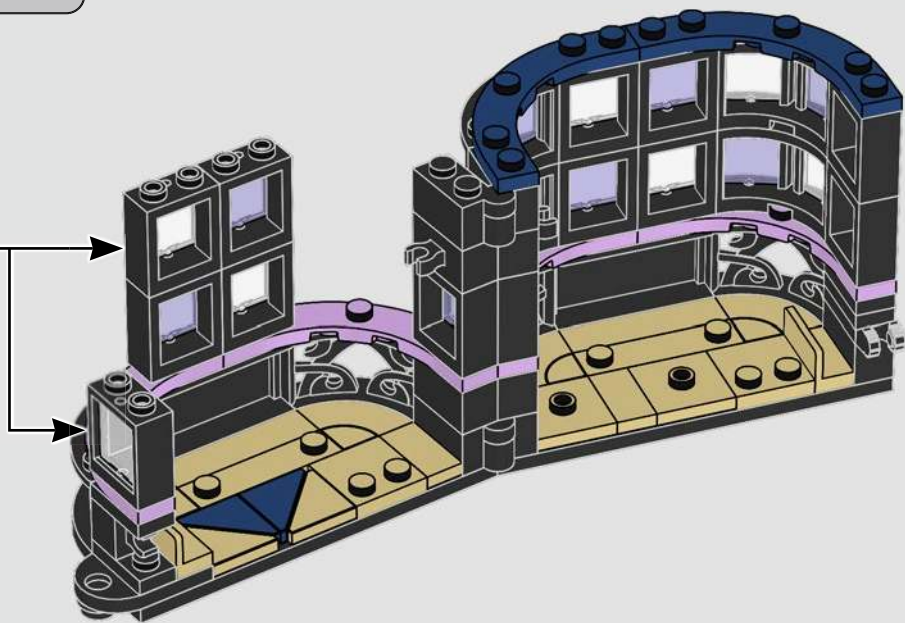
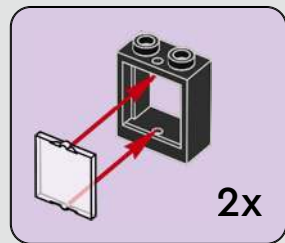

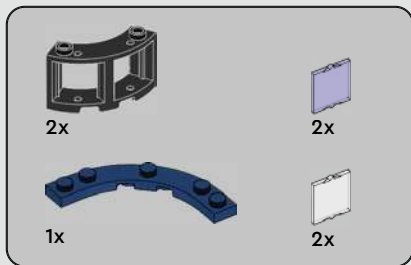

58

1

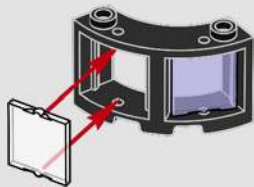

2

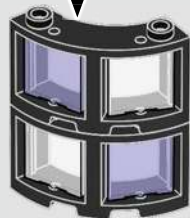
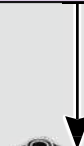
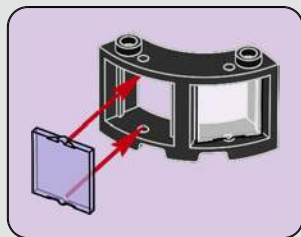

3

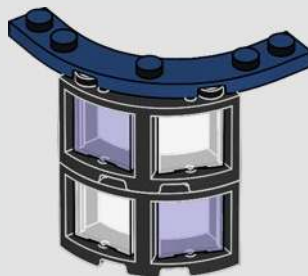

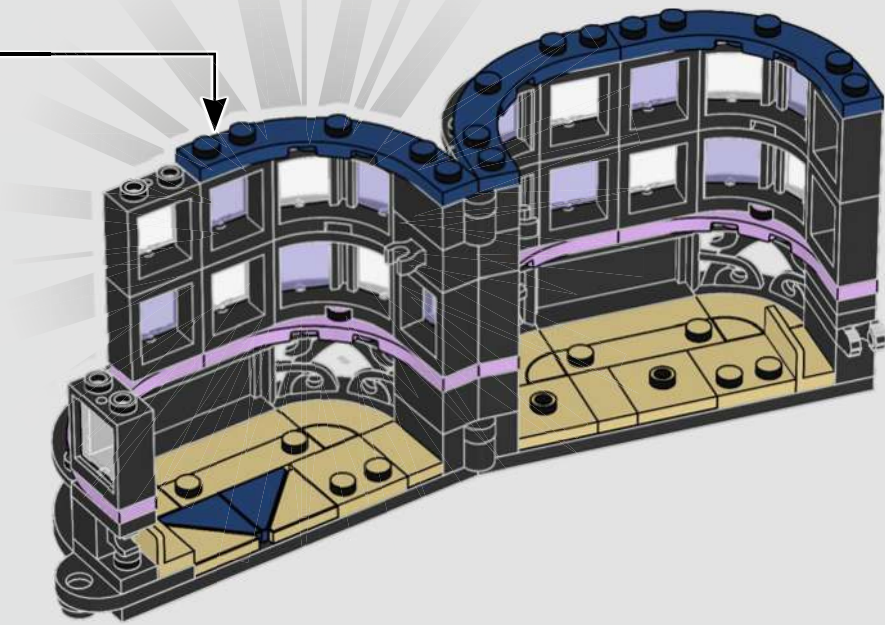



59

1



2

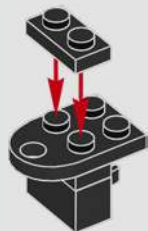

3

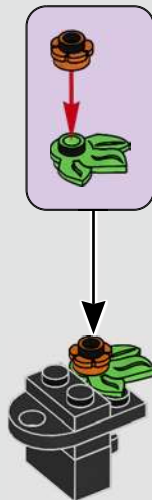

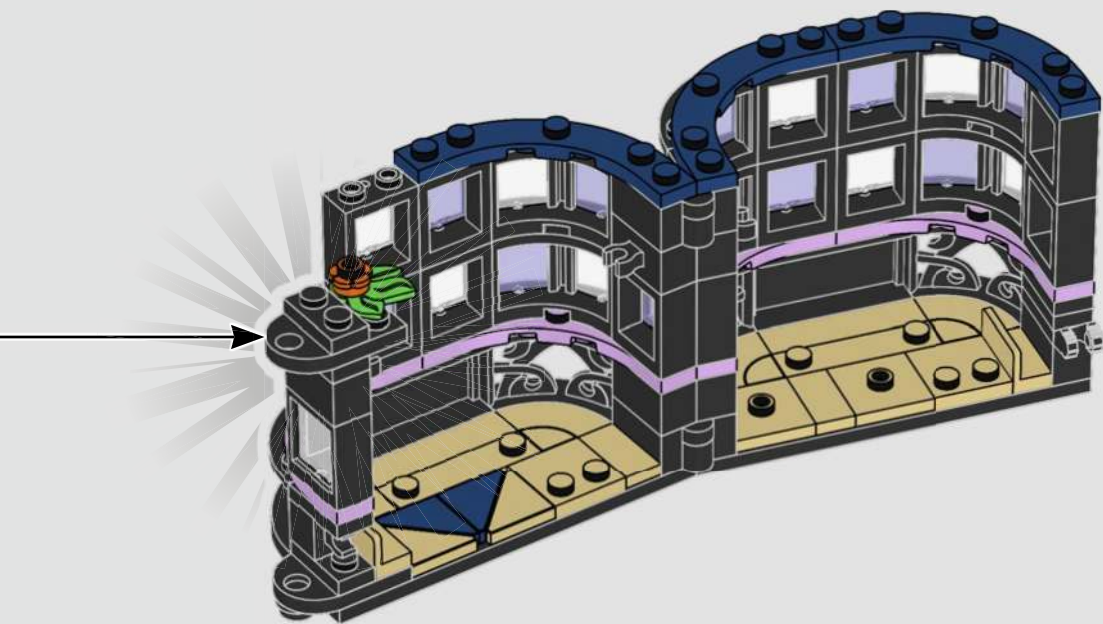

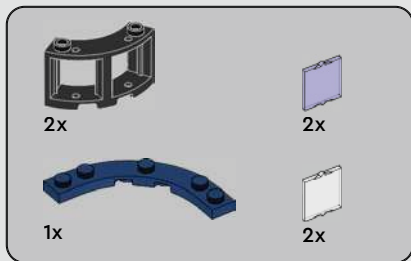

60

1

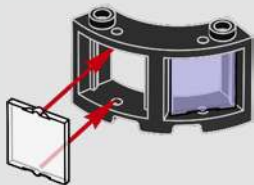

2

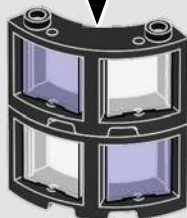

3

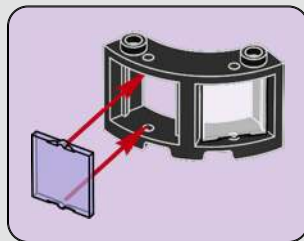
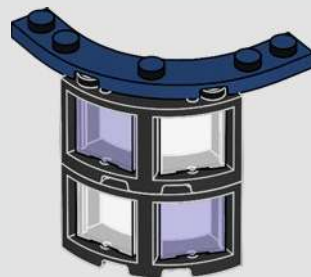

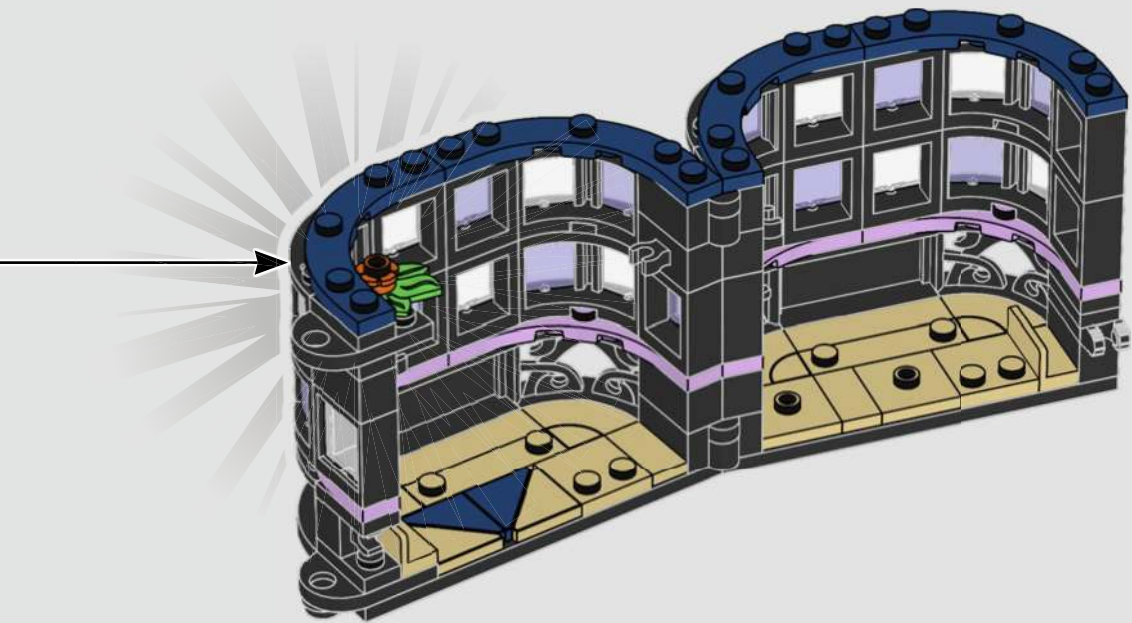



2x



4x



2x

61

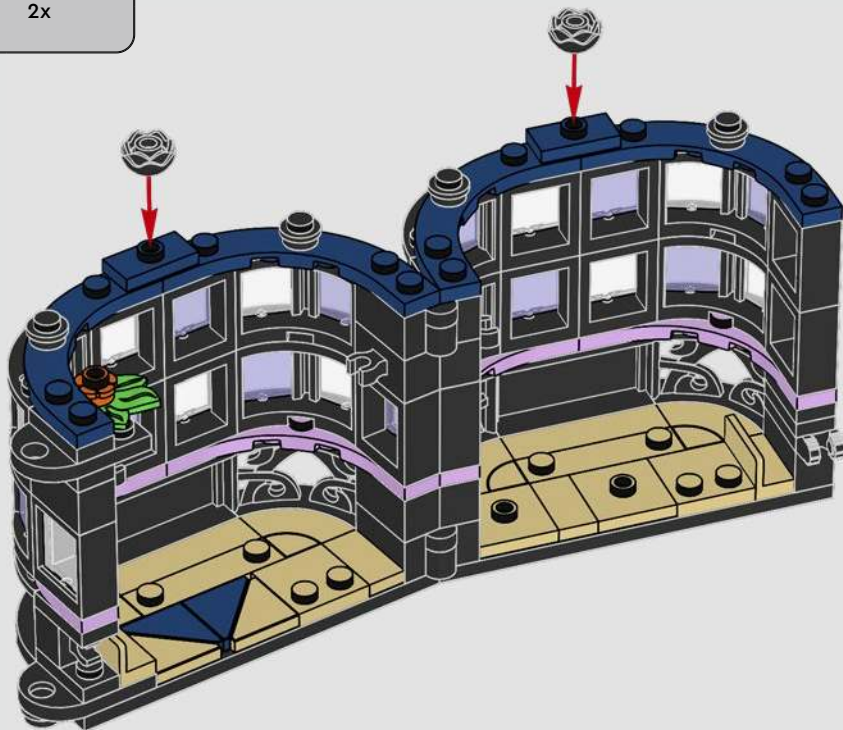

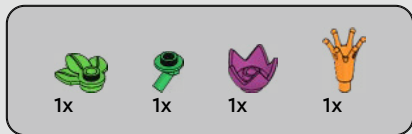

62

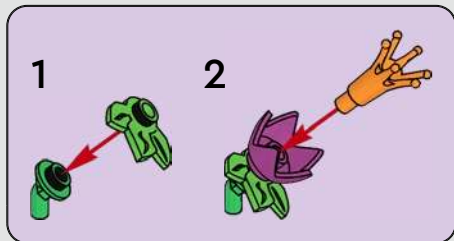

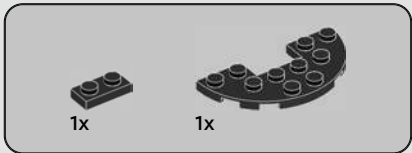
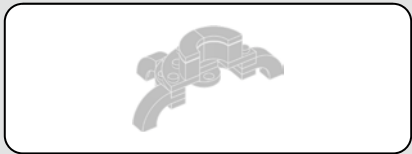

63

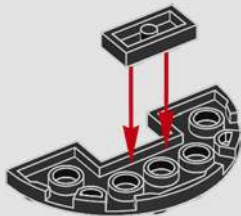

64





1x

65



4x

66

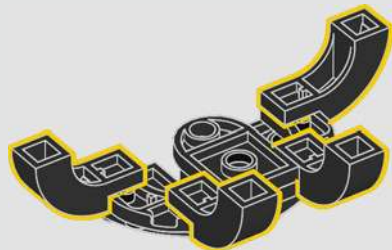



2x

67

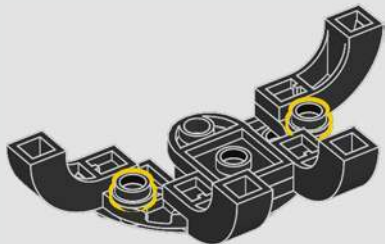

2x

68

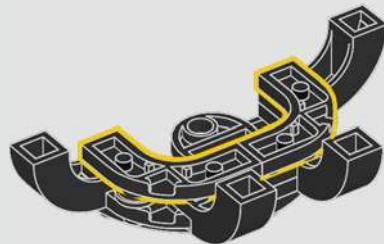

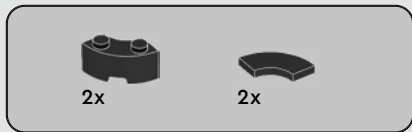

69

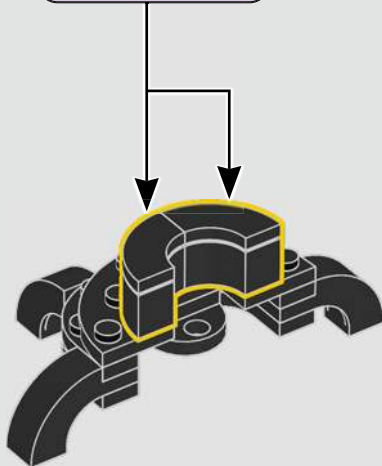
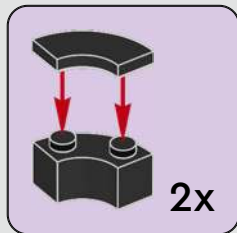

70

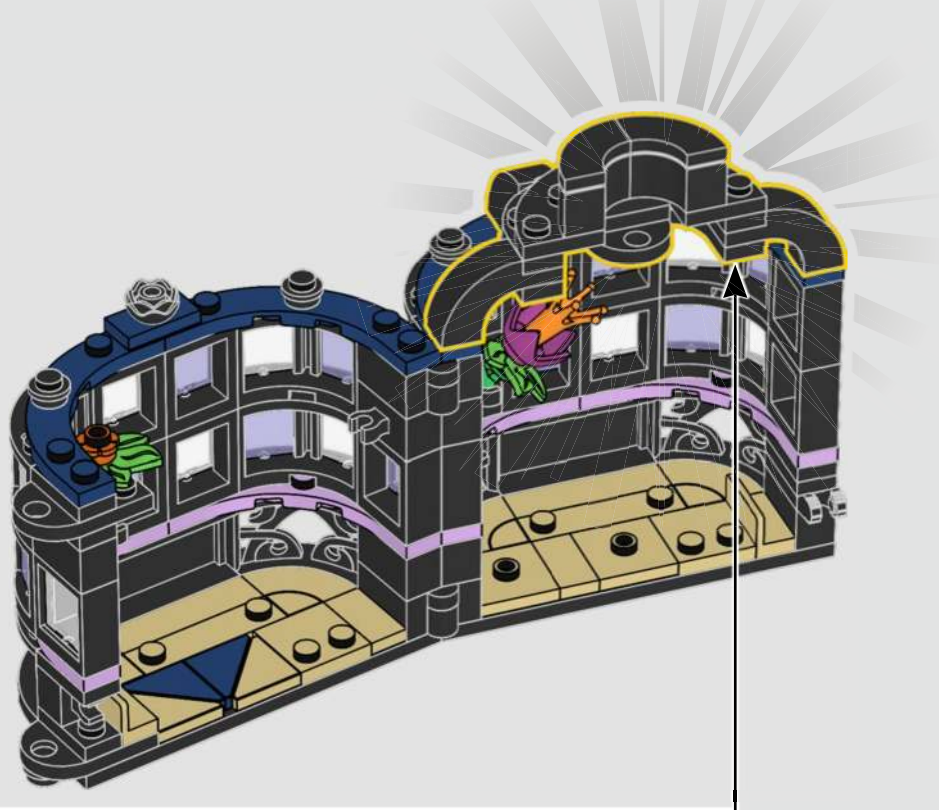

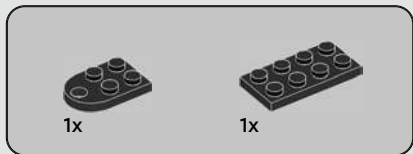

71

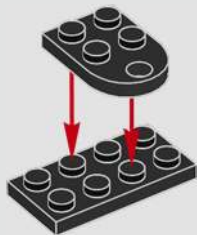

72

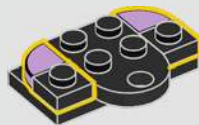

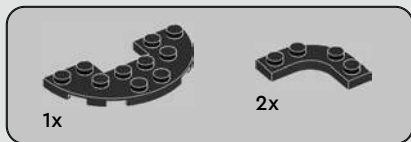

73

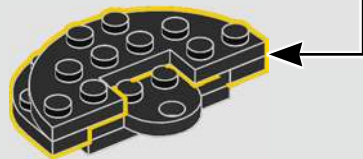
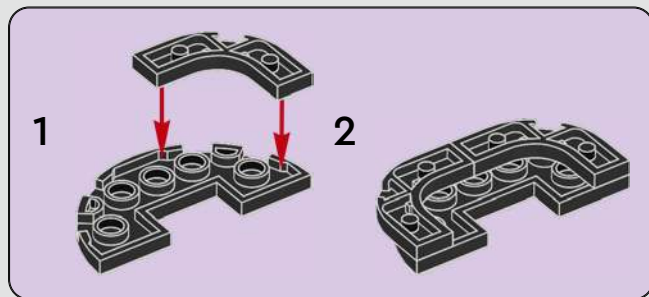



1x



2x

74

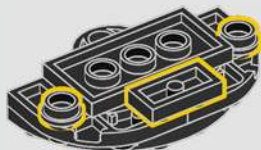
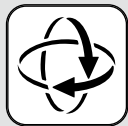

4x

75

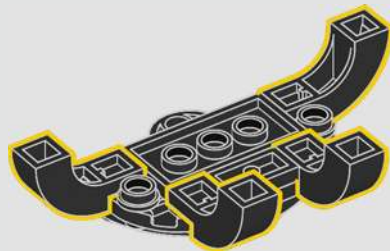



76

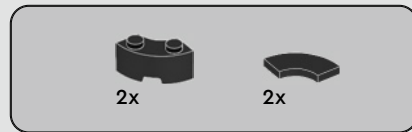
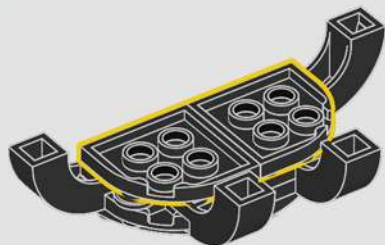

77

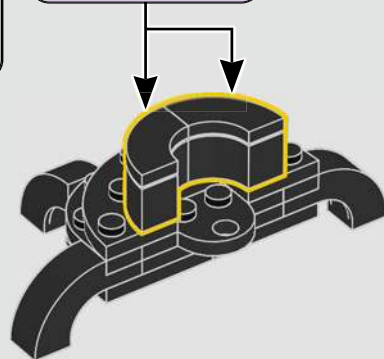
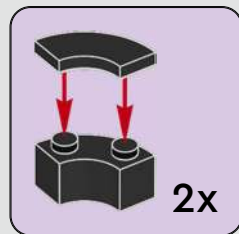

78



79



80

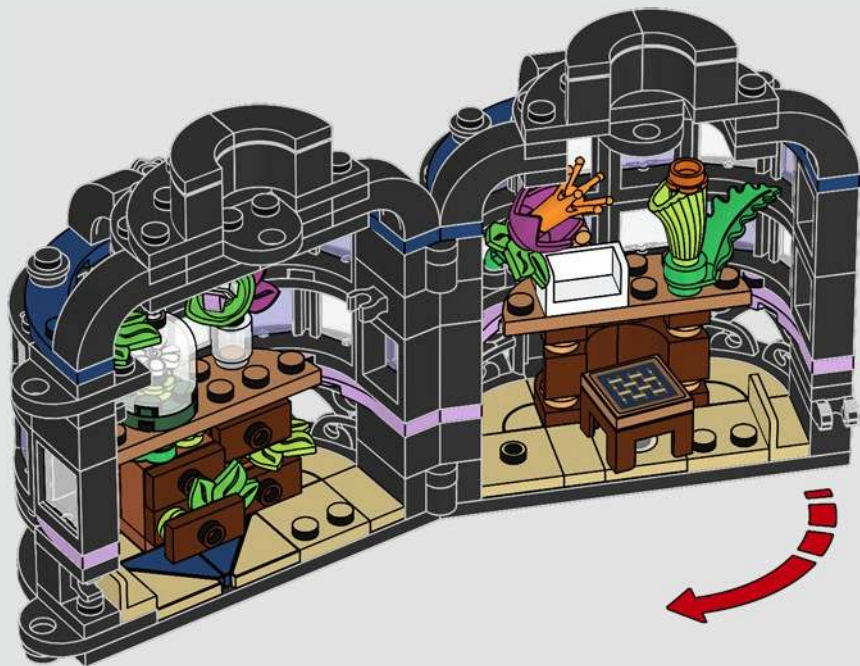

81

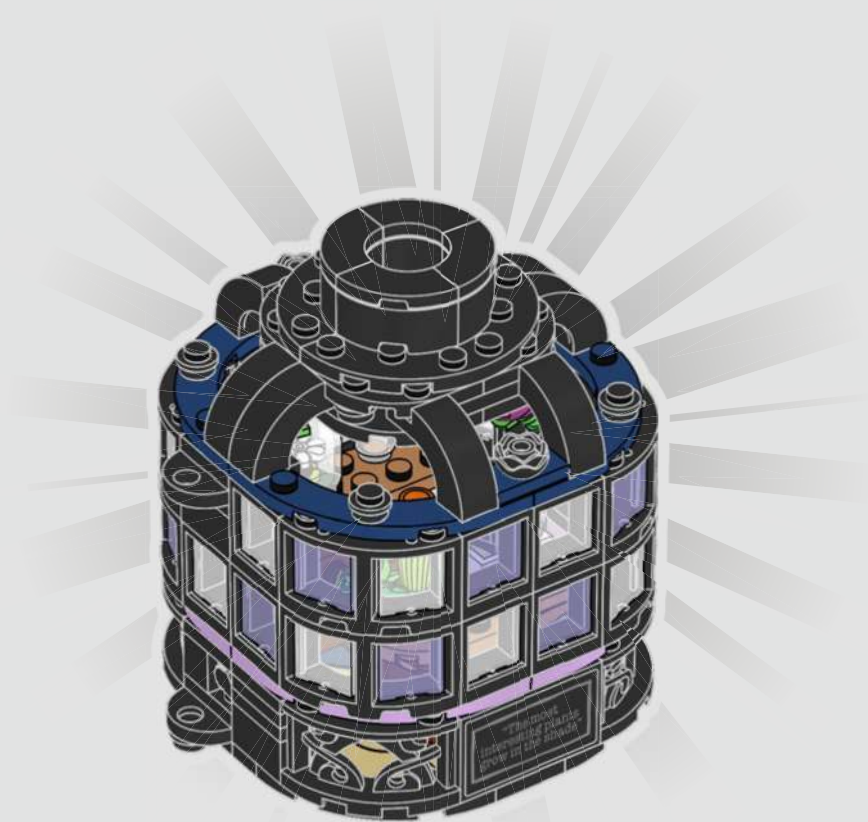

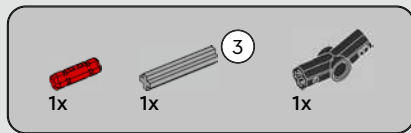

1

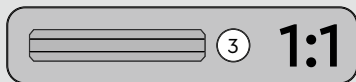
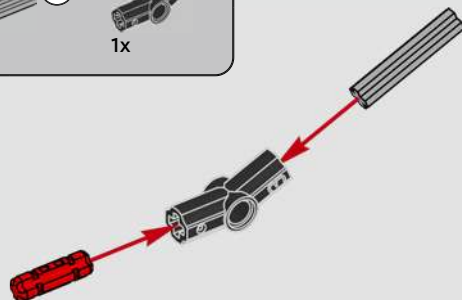

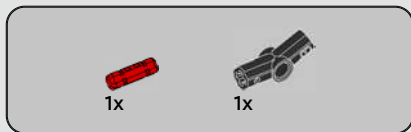

2

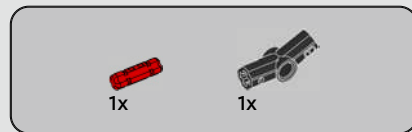
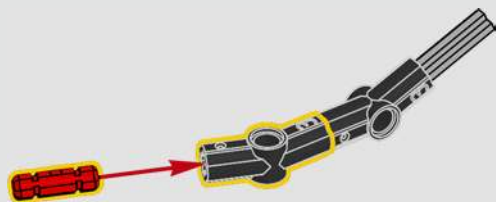

3

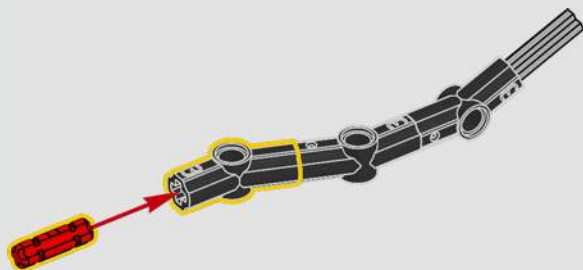



4

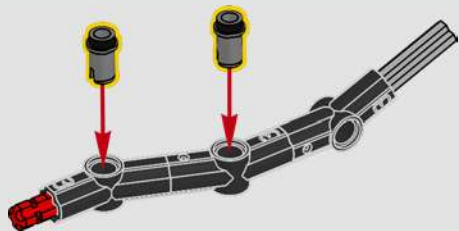

5

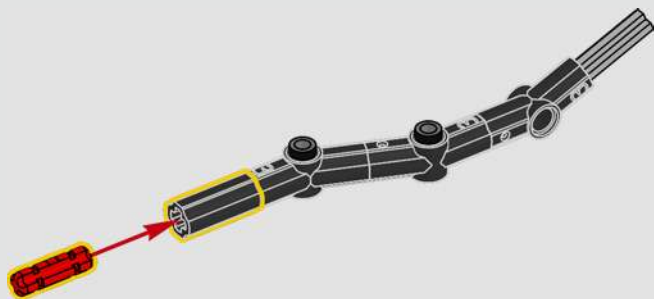

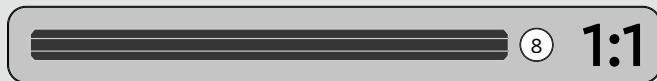
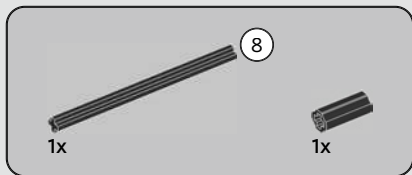

6

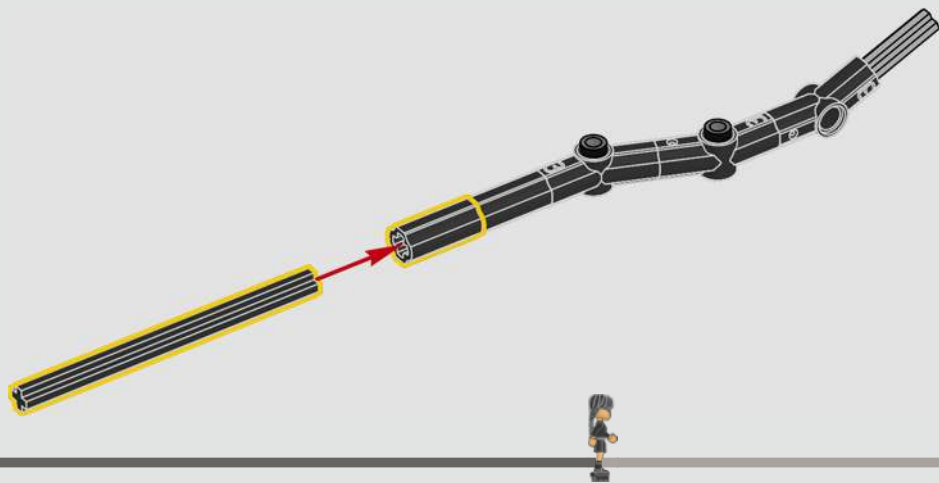

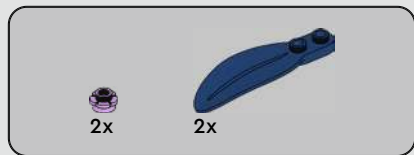

7

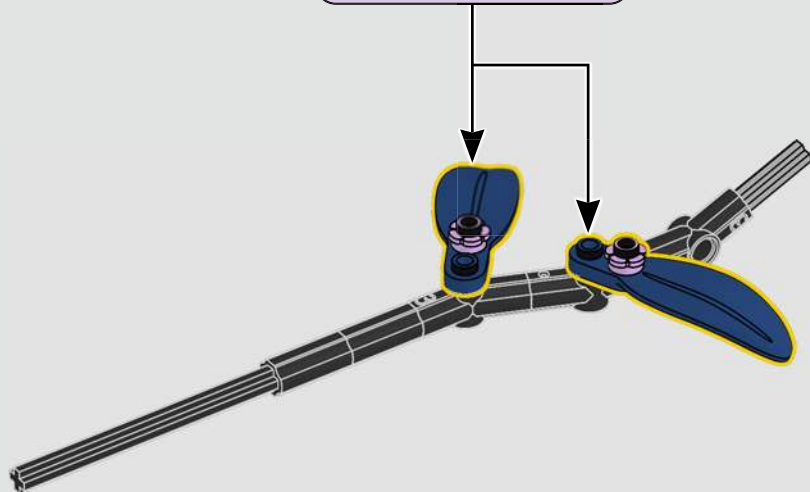
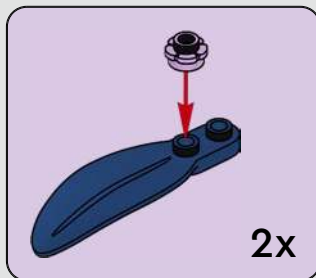



2x

8

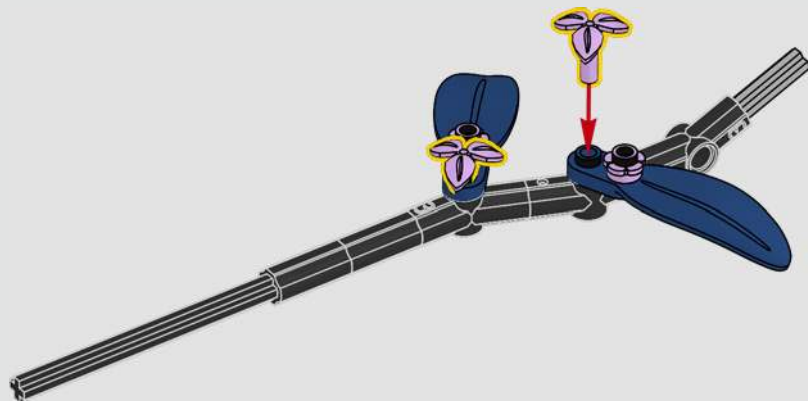

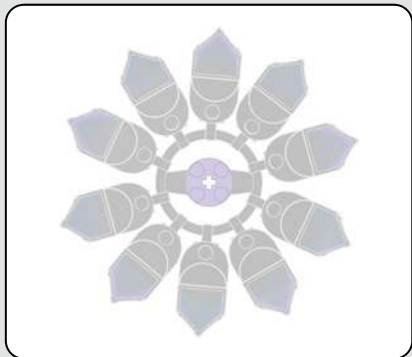

9

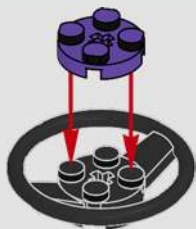

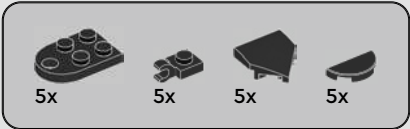

10

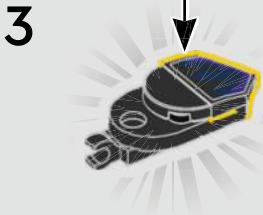
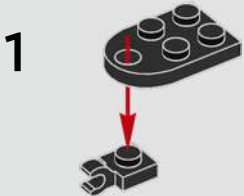

5x



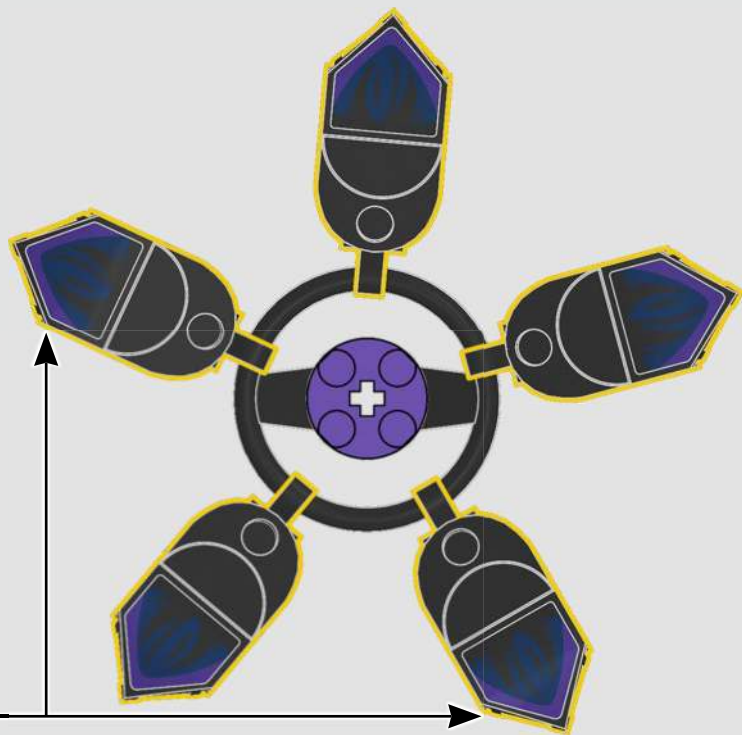



11

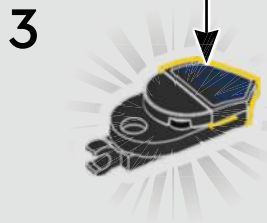
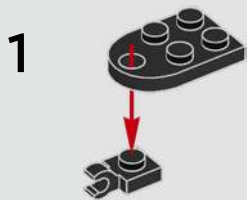

5x



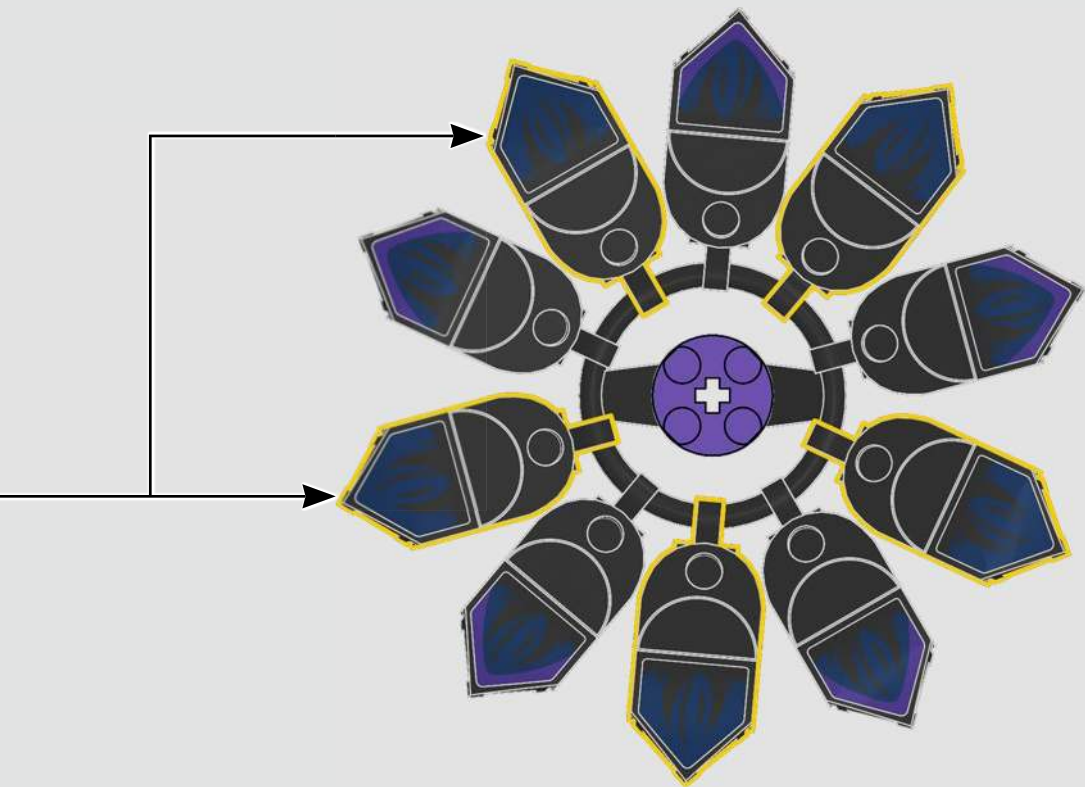

12





13

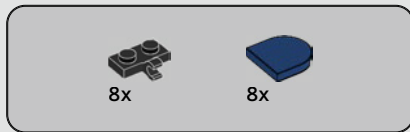
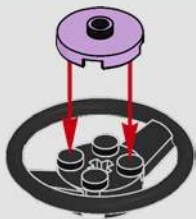

14

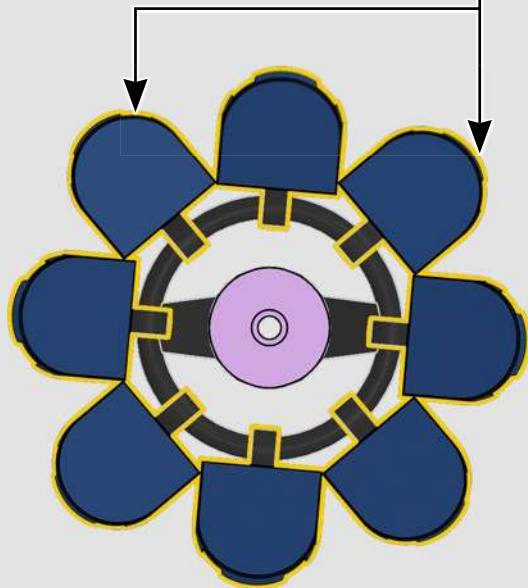
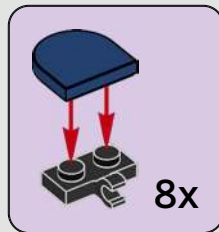

15

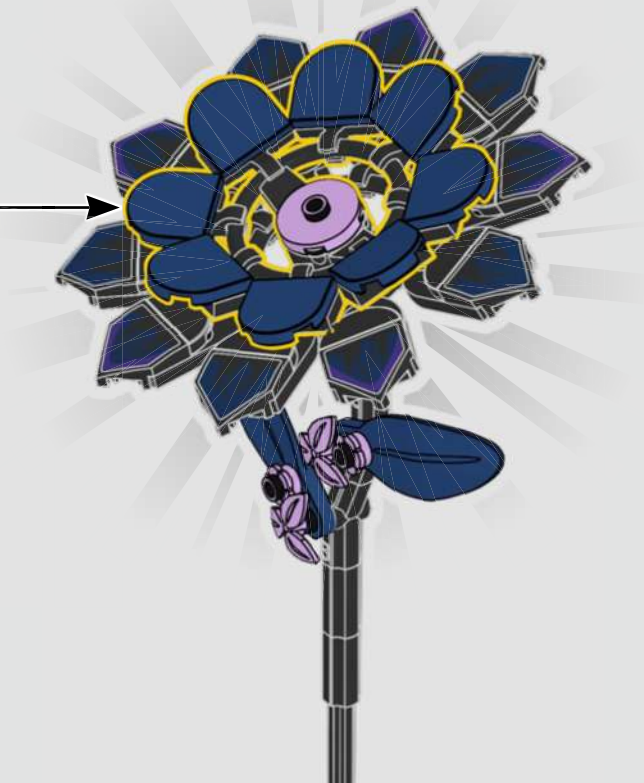



16

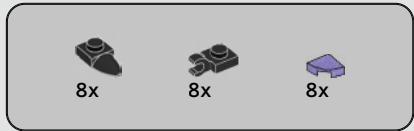
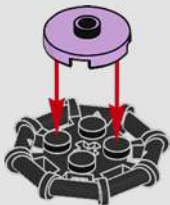

17

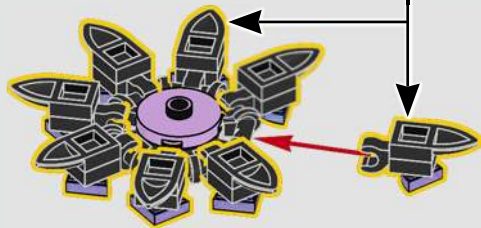
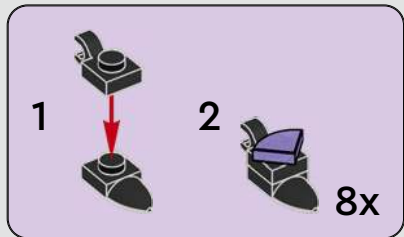



18

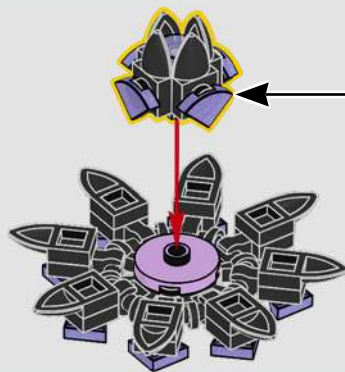

19

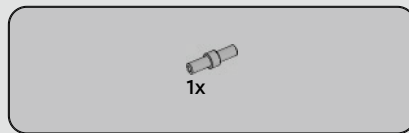

20

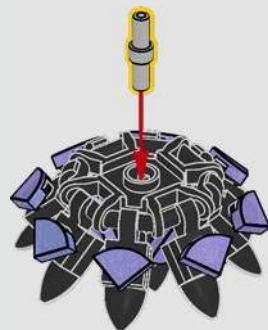

21

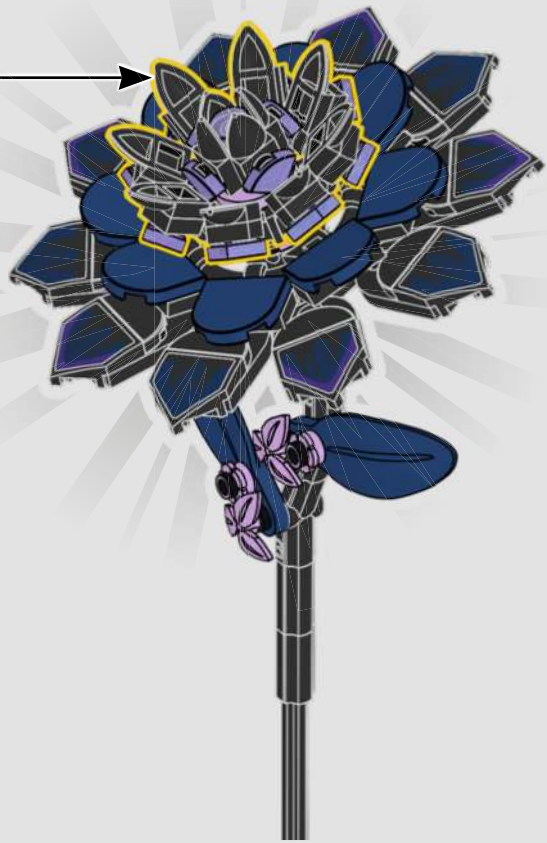

22







1x
6452532



1x
6248490



4x
6145570



2x
6146221



2x
4114026



2x
6314477



2x
6221467



2x
4565387



4x
6226565



2x
4550324



2x
6257600



4x
4142865



9x
614126



3x
6550557



2x
302426



1x
6320309



12x
4273590



1x
6566249



18x
6308000



10x
6510071



8x
6473450



4x
6473451



1x
6563326



1x
6492552



2x
4512363



8x
6313116



10x
6308912



13x
6382697



3x
6330197



3x
300426



8x
302326



2x
6344999



8x
6523044



2x
383126



4x
6191630



4x
4567436



1x
6267045



3x
6261386



14x
317626



2x
4227392



1x
6018805



2x
6115117



6x
6325190



2x
6299938



3x
302026



2x
6138405



4x
6101857



1x
370726



2x
447726

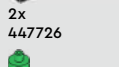

1x
6535694

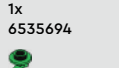

3x
6510190

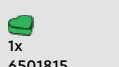

1x
6501815



1x
6411022



1x
6420228



3x
6182261



2x
6369194



1x
6361813



1x
4579659



1x
6440767



1x
6223040



1x
4535928



1x
6514232



1x
6507895



1x
6513976

1x
6551166

15x
6514136

1x
6286876

1x
6527031

4x
6209692

1x
6514489

1x
6286831

1x
6510519

1x
6375929

1x
6514201

14x
6559622

1x
6566683

2x
6092588

8x
6536139

2x
6214808

2x
6559620

4x
6399562

1x
6035029

2x
4529242

2x
4225469

1x
6174229

1x
6403106

4x
6092590

2x
4211150

1x
6494116

4x
6526059

2x
6322211

1x
4211511

1x
6436419

1x
4211815

2x
6395635

1x
6030534

1x
6551164

1x
6566395

5x
4523159

1x
6146054

1x
6092594

1x
6313601

2x
6559623

2x
6214235

1x
6439052

2x
6240465

2x
6466042

2x
6223598

4x
6488200

12x
6514466

1x
6096993

1x
6559619

1x
6501573

1x
6566236

2x
6475523

 [LEGO.com/service](https://www.LEGO.com/service)



YOU COULD
WIN



Scan this QR code or go to
LEGO.COM/PRODUCTFEEDBACK and give us
your short feedback about this LEGO® set
for a chance to win a cool LEGO prize.

Terms and Conditions apply*

EN: YOU COULD WIN. Terms and Conditions apply* **DE: Du könntest GEWINNEN.** Es gelten die Teilnahmebedingungen* **FR: Tu pourrais GAGNER.** Des conditions s'appliquent* **IT: Potresti VINCERE tu.** Termini e condizioni sono applicabili* **ES: Puedes GANAR.** Aplican términos y condiciones* **PT: PODERÁ GANHAR.** Aplicam-se Termos e Condições* **ZH: 轻松获奖.** 条款和条件适用* **PL: Szansa na WYGRANĄ.** Obowiązuje regulamin* **CS: Máte šanci VYHRÁT.** Platí všeobecné smluvní podmínky* **SK: Máte šancu VYHRAŤ.** Platia všeobecné zmluvné podmienky* **HU: TE IS NYERHETSZ.** Felhasználási feltételek érvényesek* **UA: ВИ МОЖЕТЕ ВИГРАТИ.** Застосовуються загальні положення та умови* **RO: Ai putea CÂȘTIGA.** Se aplică termeni și condiții* **BG: Можете да СПЕЧЕЛИТЕ.** Има определени правила и условия* **LV: Tu vari LAIMĒT.** Ir spēkā noteikumi un nosacījumi.* **ET: Sul on võimalus VÕITA.** Kehtivad tingimused* **LT: Jūs galite LAIMĖTI.** Taikomos sąlygos*

*[LEGO.com/productfeedback-terms](https://www.lego.com/productfeedback-terms)

LEGO and the LEGO logo are trademarks of the LEGO Group. ©2025 The LEGO Group.

WEDNESDAY © 2022-2025 MGM Television Entertainment Inc. WEDNESDAY is a trademark of Tee & Charles Addams Foundation.

© 2025 Metro-Goldwyn-Mayer Studios Inc. All Rights Reserved.



6592852