



Friends

42659



LEGO® Builder



LEGO.com/sustainable-packaging



FR
DONNEZ
OU
RECYCLEZ

 OU  OU 

ASSOCIATION MAGASIN DÉCHÈTERIE

Adresses sur quefairedemesdechets.fr

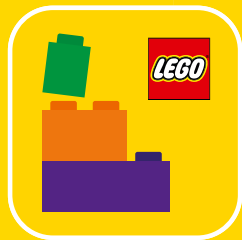

Q LEGO® Builder

BUILDER



Apple and the Apple logo are trademarks of Apple Inc., registered in the U.S. and other countries and regions. App Store is a service mark of Apple Inc. Google Play and the Google Play logo are trademarks of Google LLC. Tencent and the Tencent logo are trademarks of Tencent Inc.

Q [LEGO.com/devicecheck](https://www.lego.com/devicecheck)

EN Ask parents' permission before going online | DE Eltern um Erlaubnis bitten, bevor du online gehst | FR Demande l'autorisation d'un parent avant d'aller en ligne | IT Chiedi il permesso ai tuoi genitori prima di andare online | ES Pídeles permiso a tus papás antes de conectarte a Internet | PT Peça autorização aos pais antes de acederes online | ZH 上网前应先征得父母的同意 | PL Poproś rodziców o zgodę, zanim wejdiesz do Internetu | CS Než půjdeš na internet, požádej rodiče o svolení | SK Skôr než pôjdeš na internet, vypýtaj si povolenie od rodičov | HU Kérj szülői engedélyt, mielőtt online csatlakoznál! | UA Запитуйте дозволу батьків, перш ніж користуватися інтернетом | RO Cere permisiunea părinților înainte de a te conecta online | BG Поискайте разрешение от родител, преди да влезете онлайн | LV Pirms došanās tiešsaistē palūdz atļauju vecākiem | ET Enne Interneti kasutamist küsi vanematelt luba | LT Prieš prisijungdami prie interneto, atsklauskite tėvų

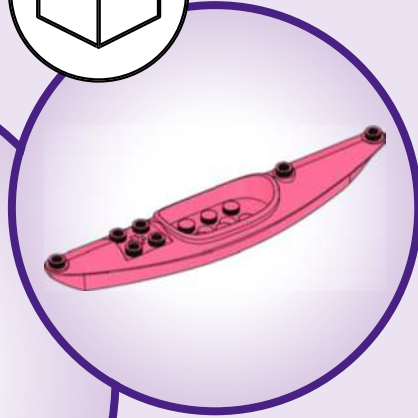
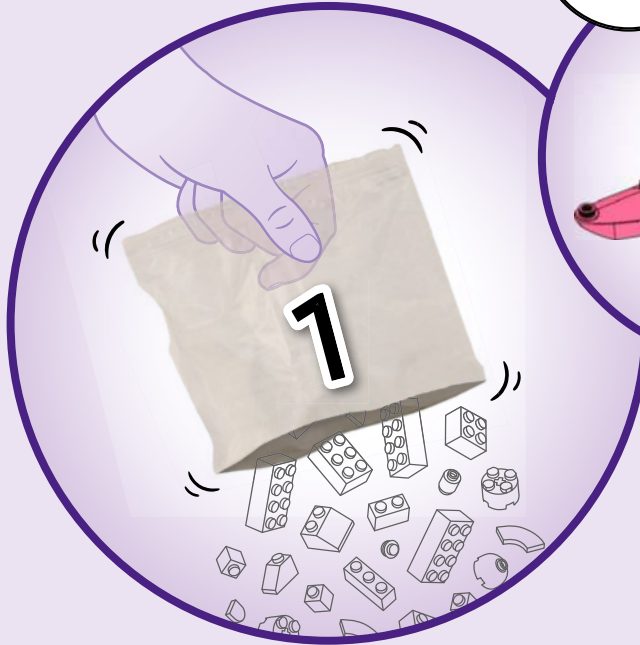
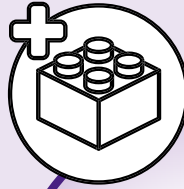

1

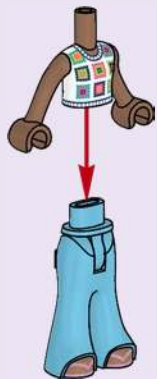

2



3

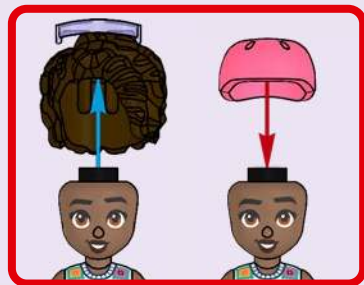
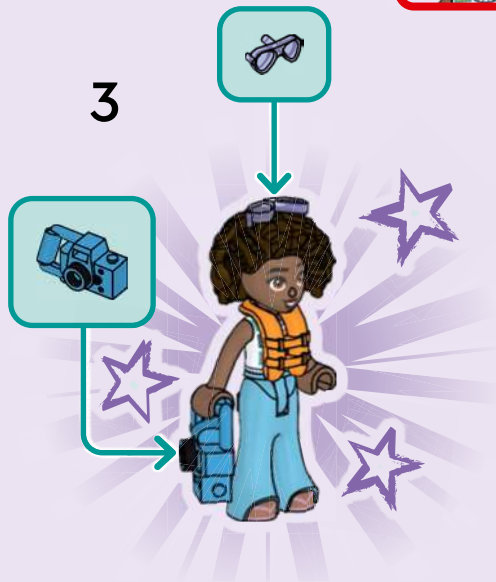

AIRA



ALIYA



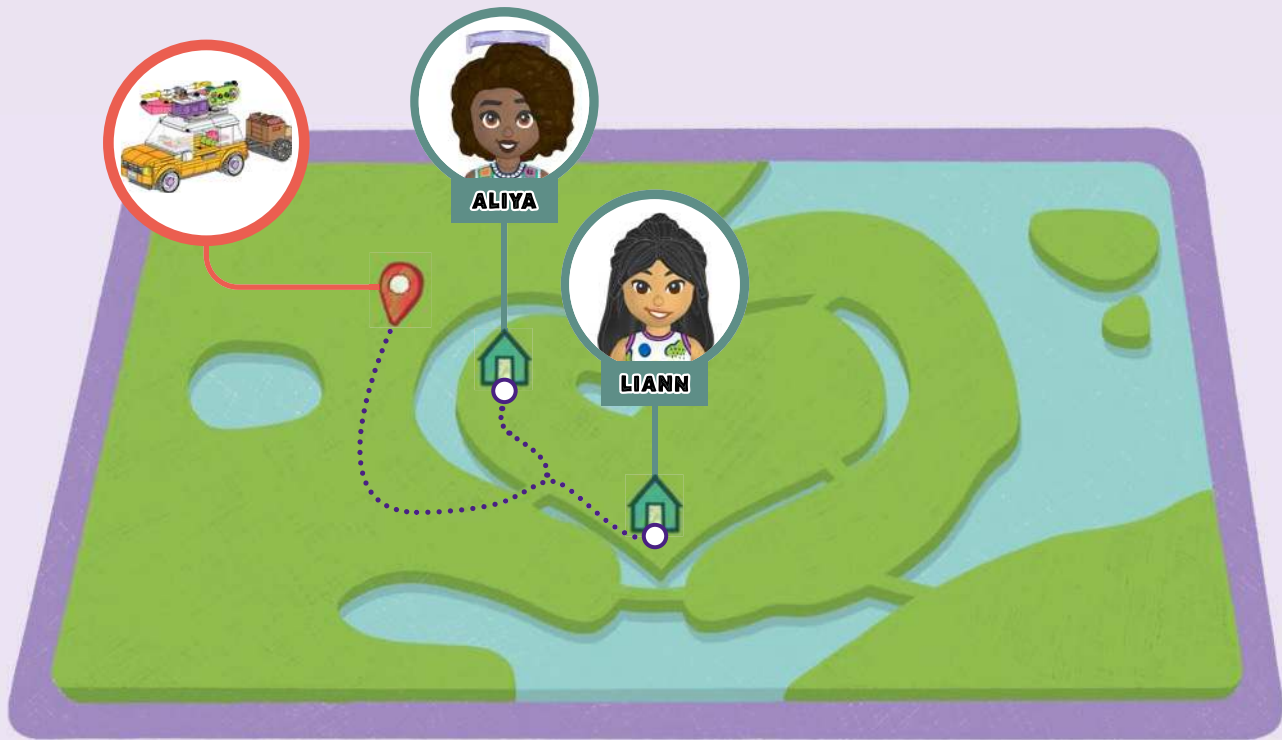

1

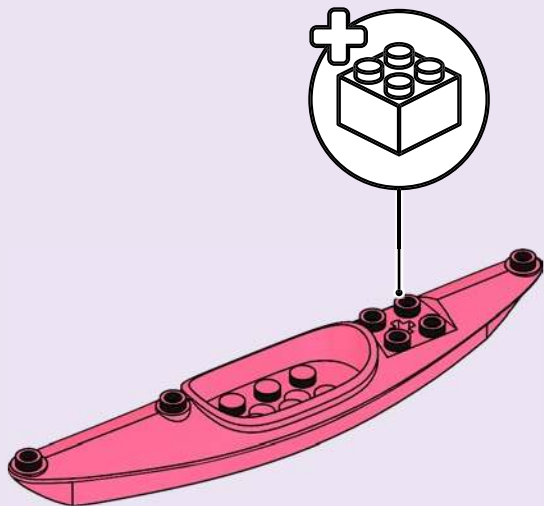

2



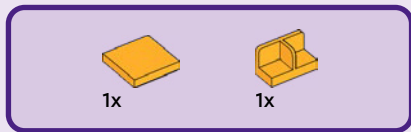

3



4

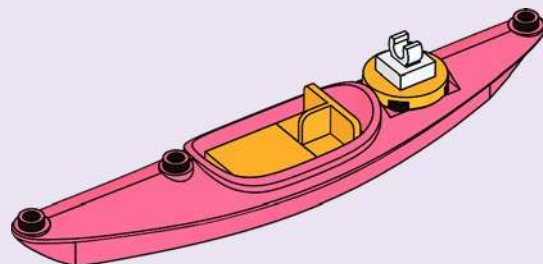



5

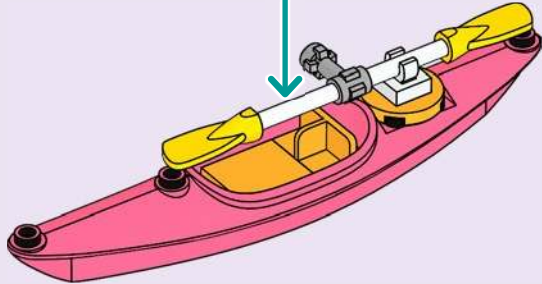
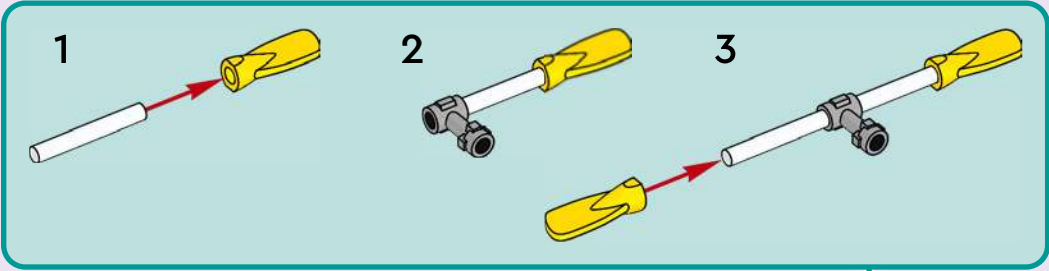

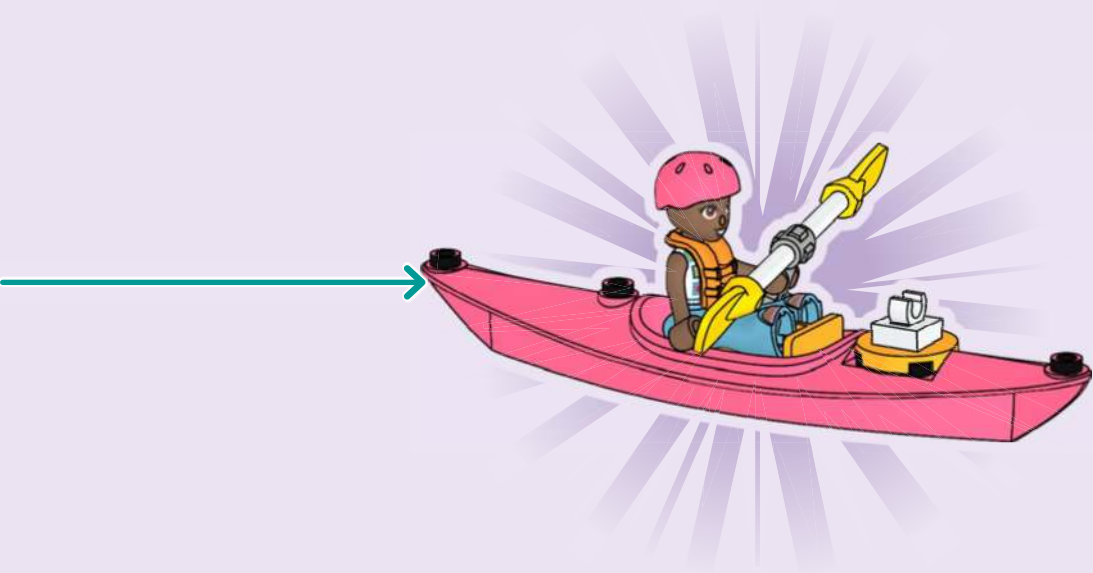

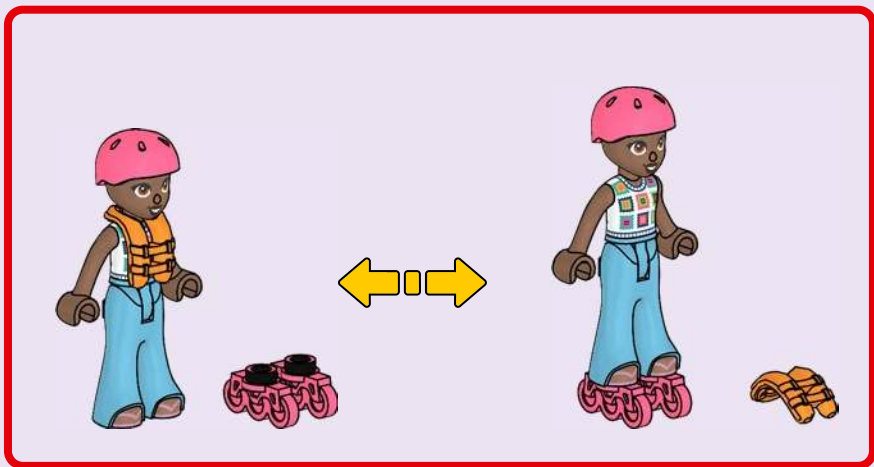

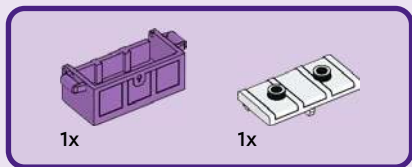

1

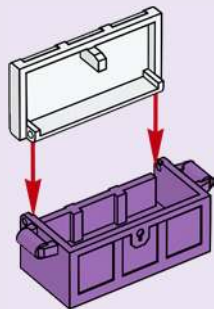

2

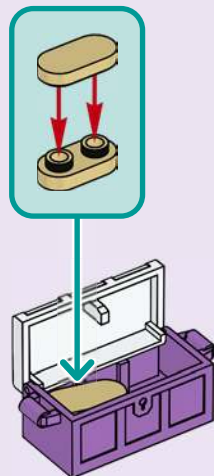

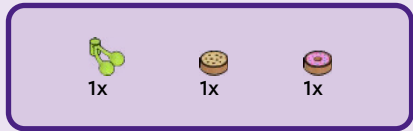

3

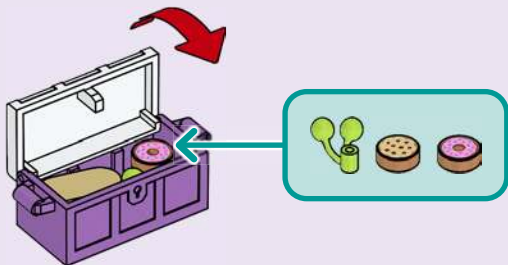

4



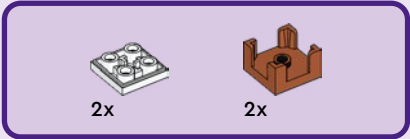

5

1

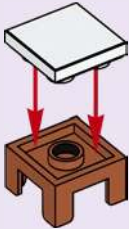

2

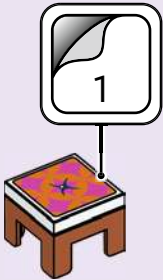

2x





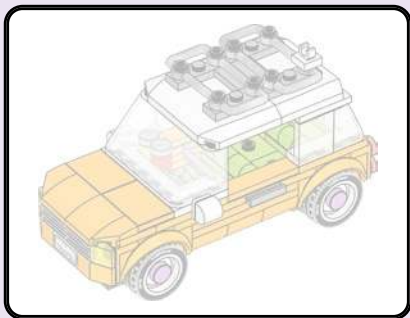

1x

1

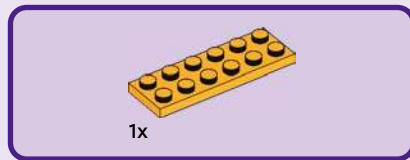
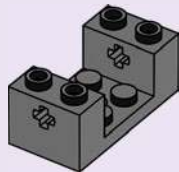

1x

2

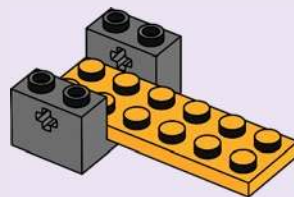

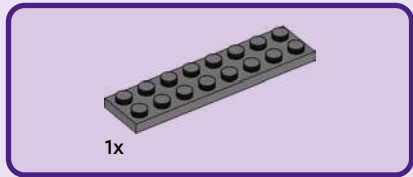

3

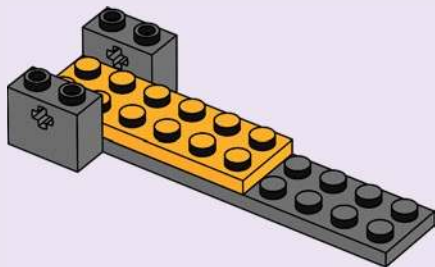

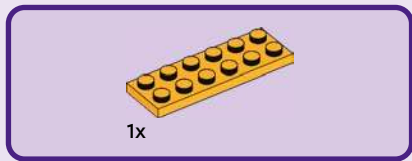

4

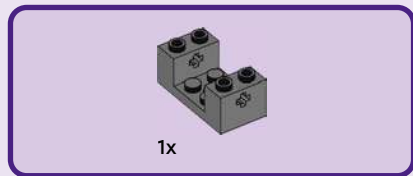
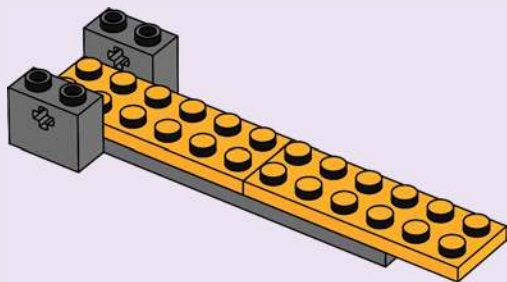

5

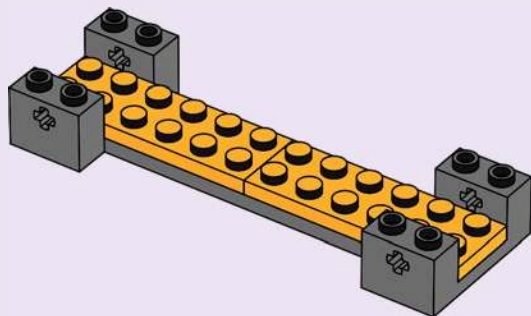



4x

6

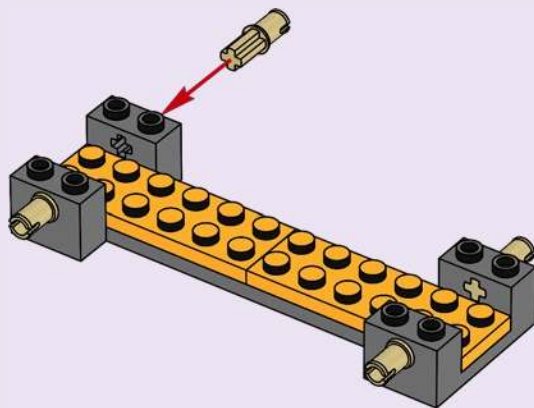

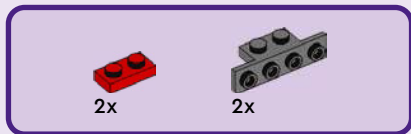

7

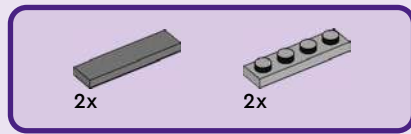
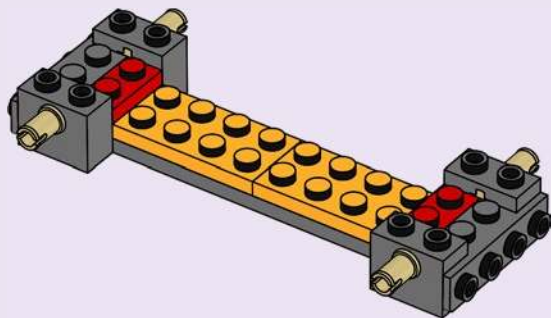

8

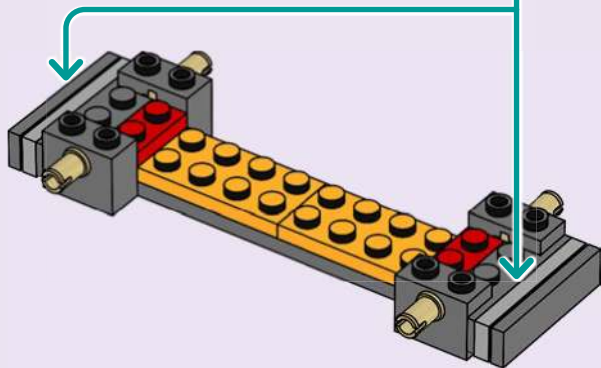
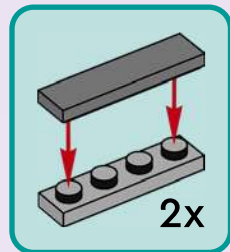

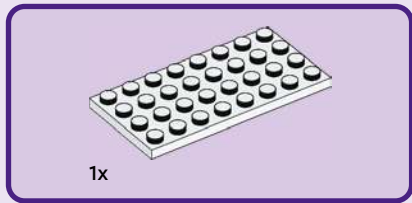

9

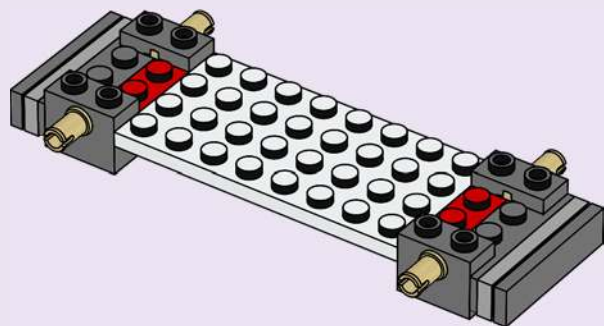



4x

10

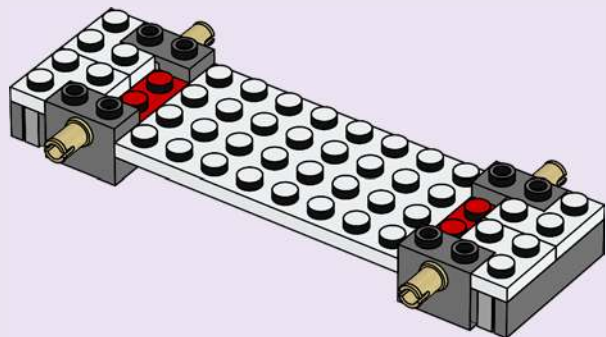

2x



2x



2x

11

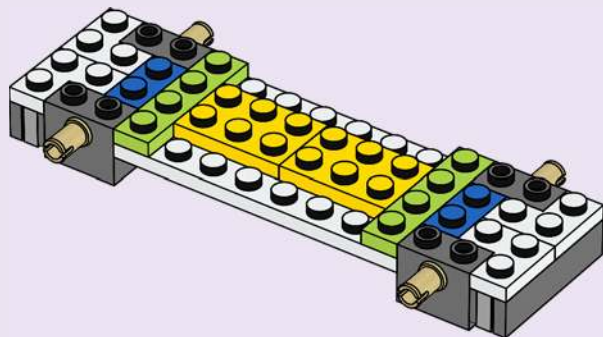



6x

12

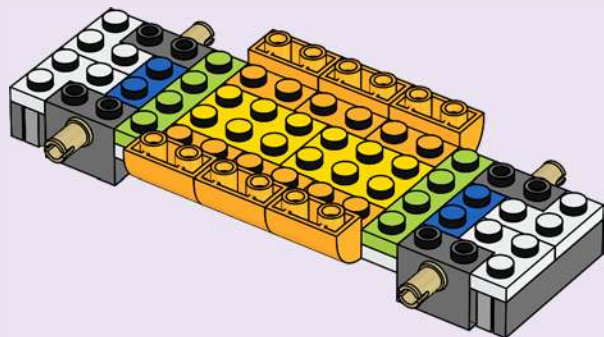



2x

13

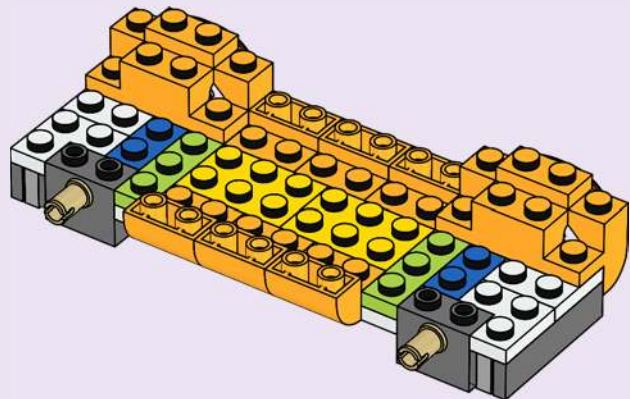

1x

14

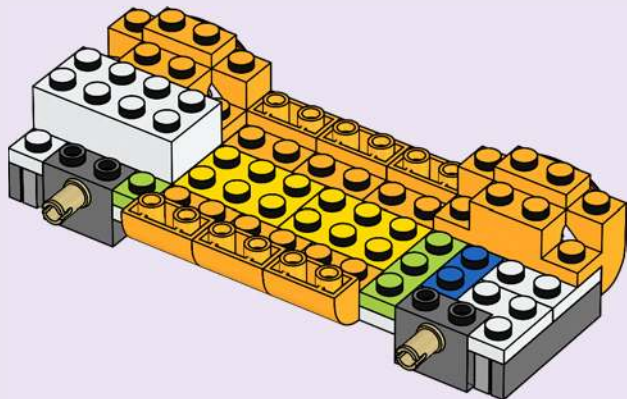



2x

15

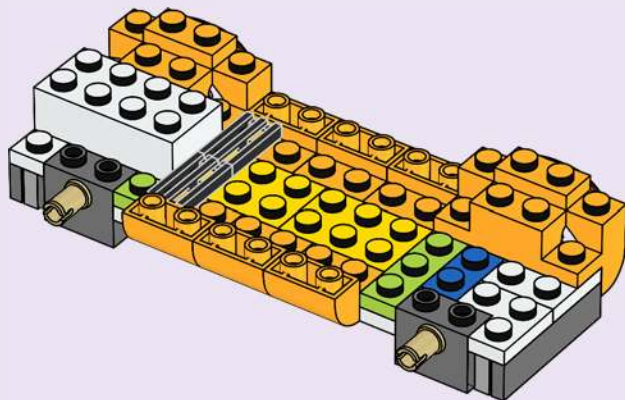



2x



1x

16

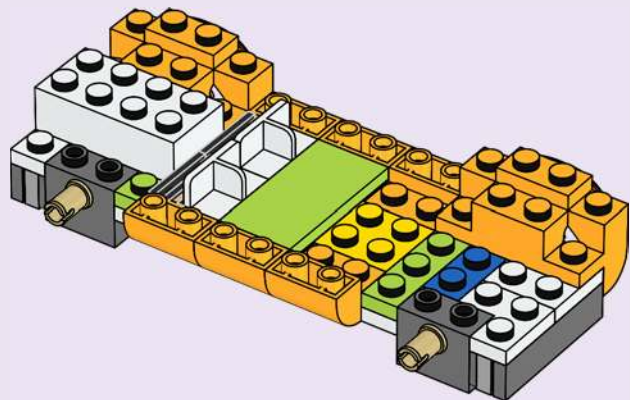

1x



1x



2x

17

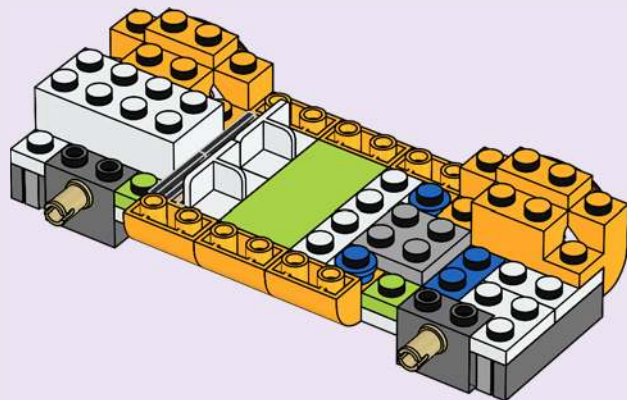



1x



1x

18

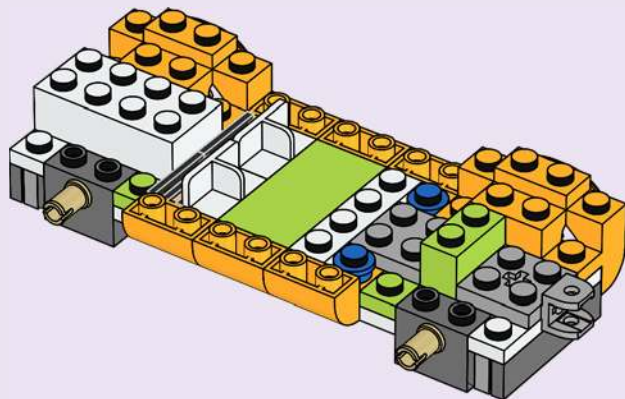



2x

19

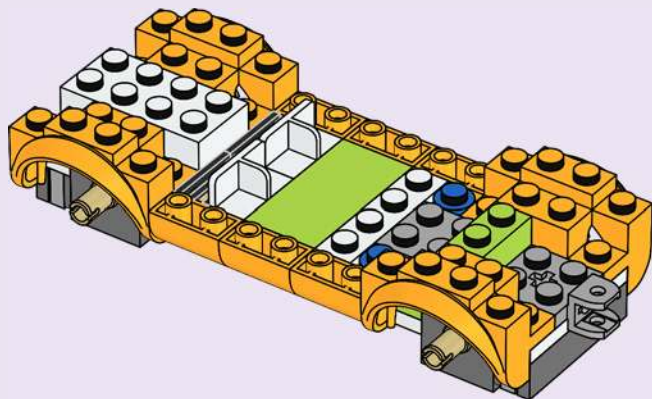



4x

20

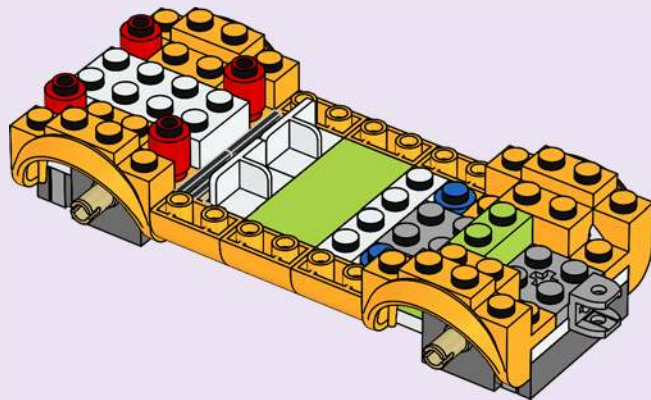

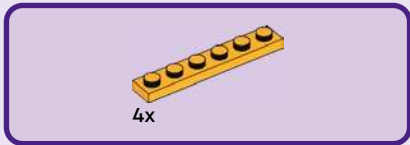

21

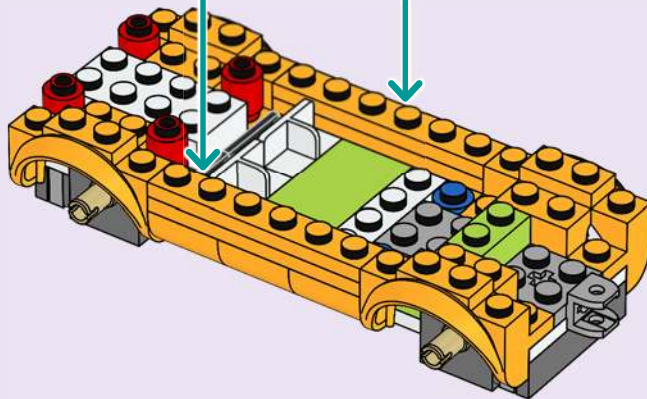
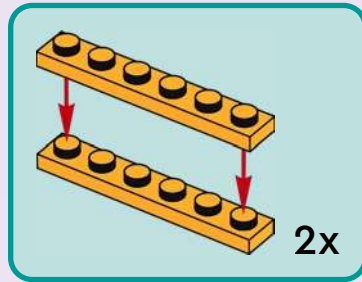



1x



2x

22

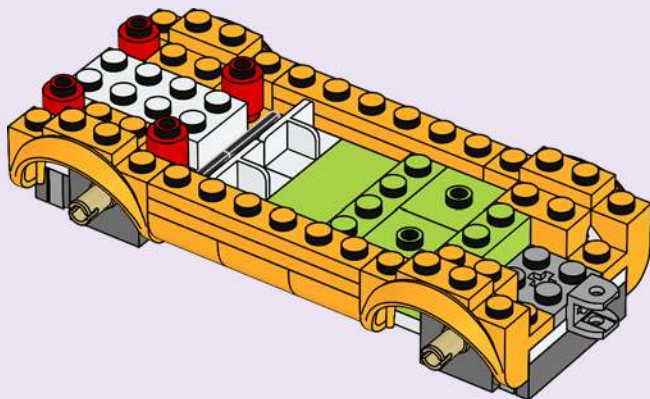

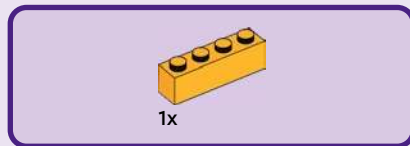

23

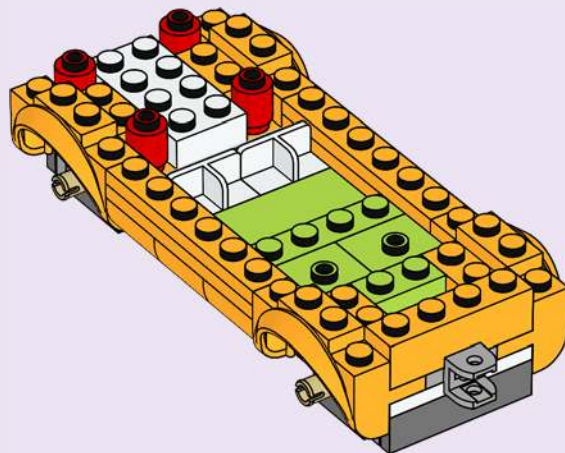



2x

24

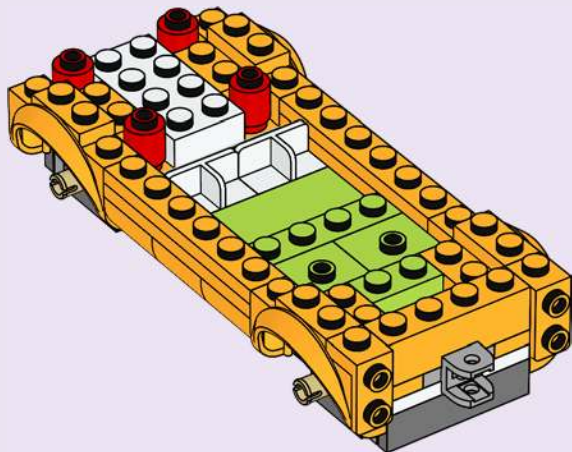



4x

25

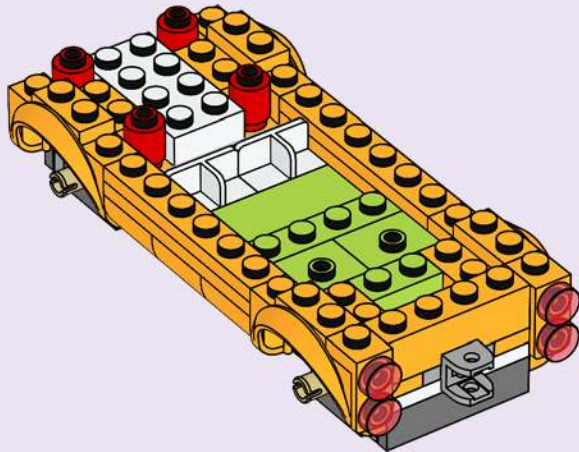



1x

26

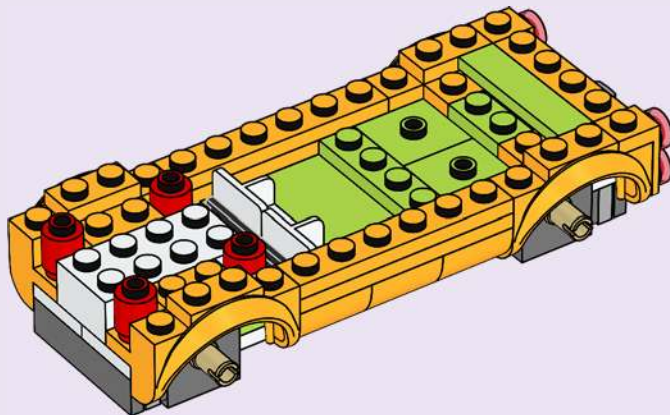



8x

27

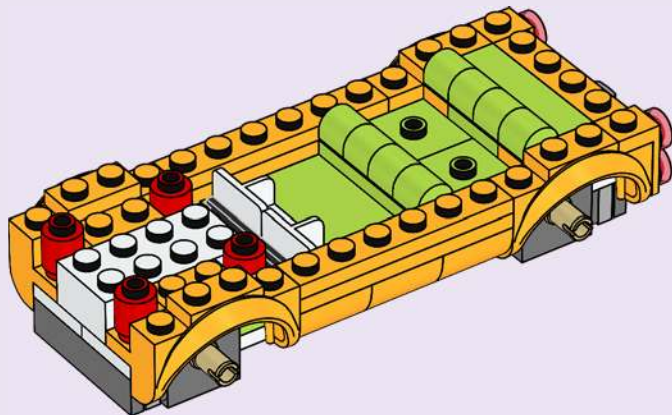



2x



2x

28

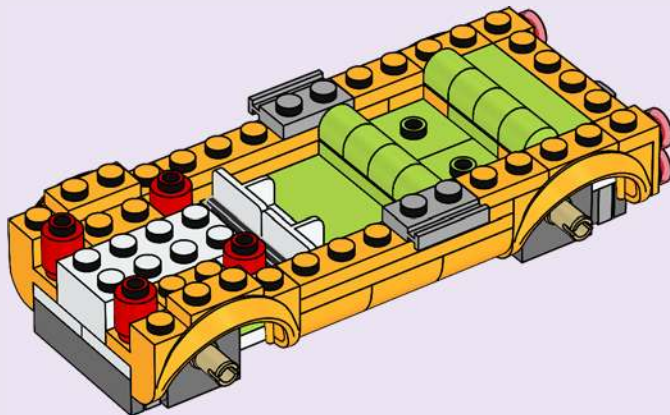



2x

29

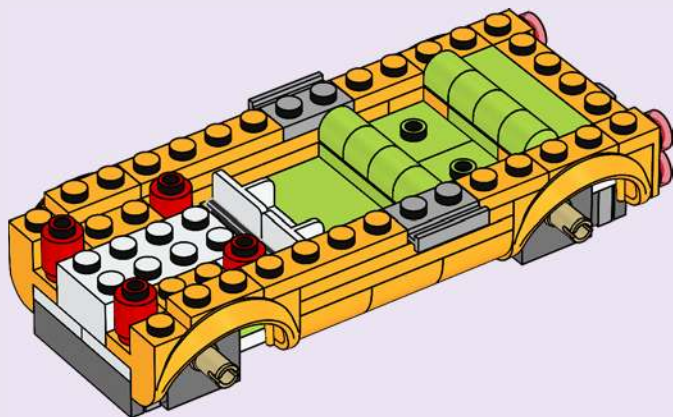

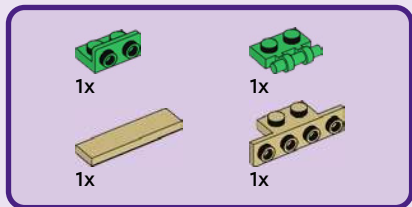

30

1

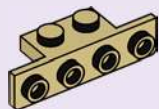

2

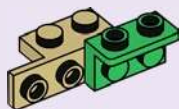

3

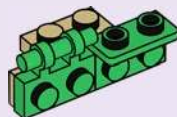

4



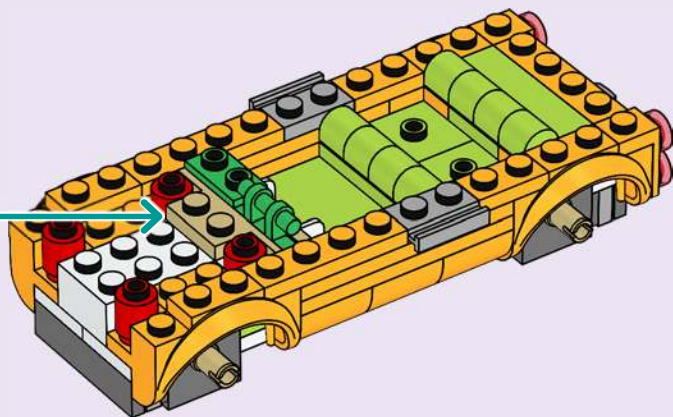



1x

31

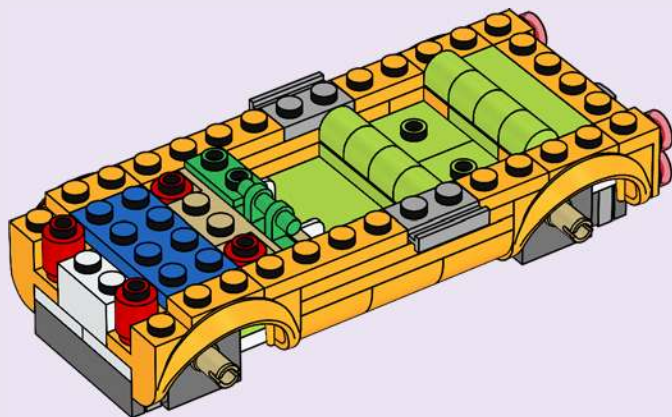



1x

32

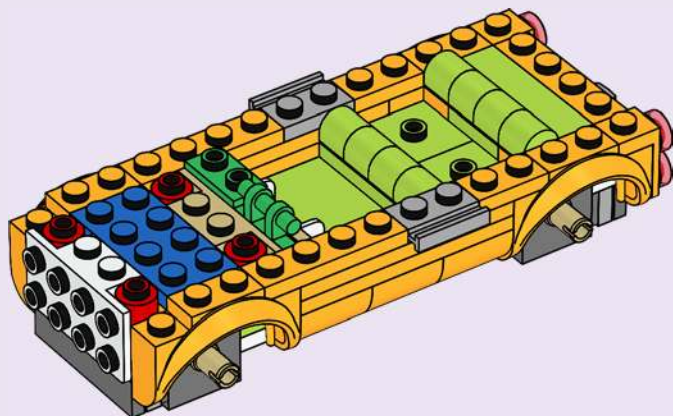



33

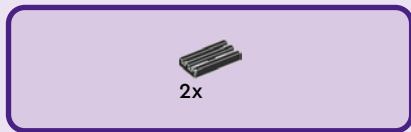

34





1x

35

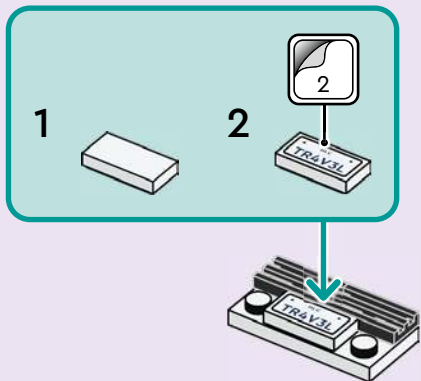

2x

36

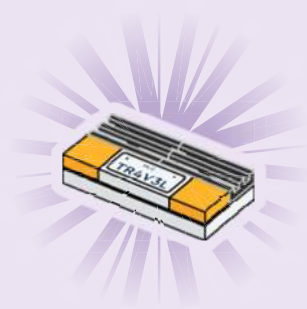

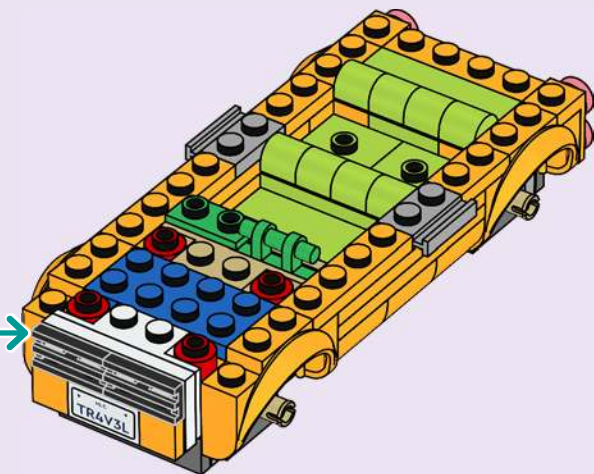



2x

37

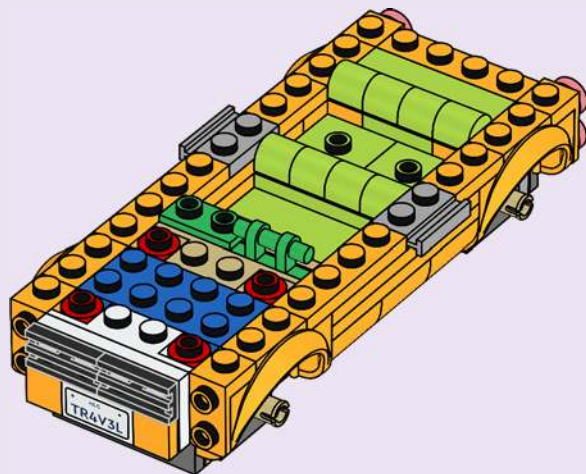



2x



2x

38

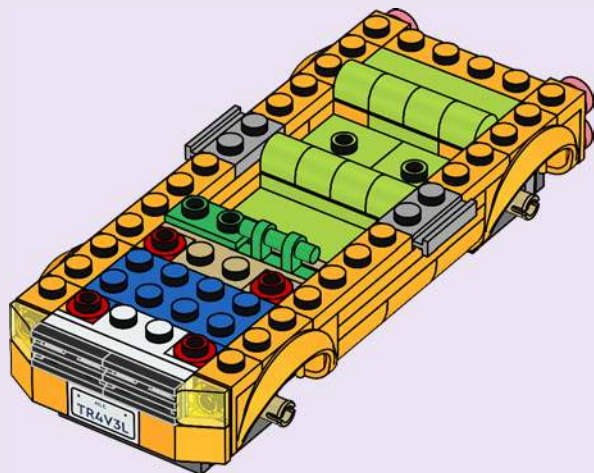

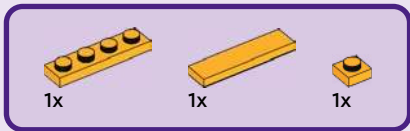

39

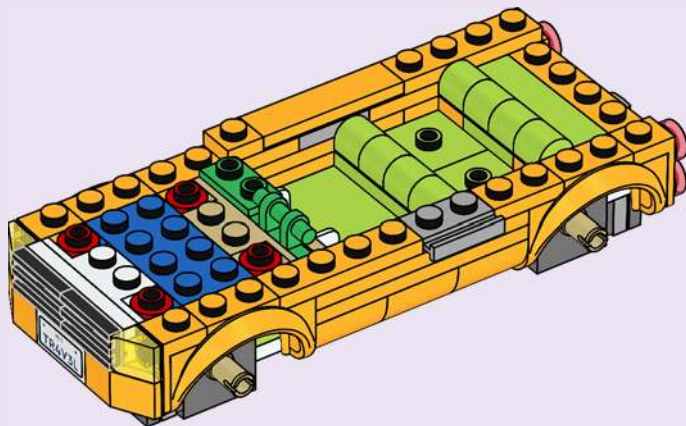

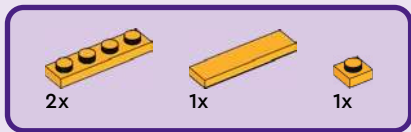

40

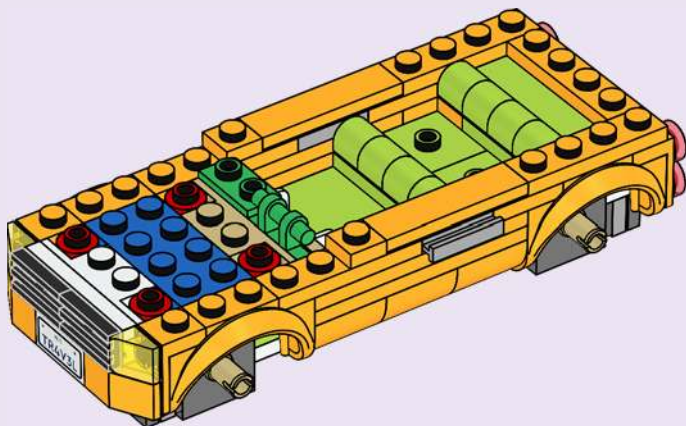



2x

41

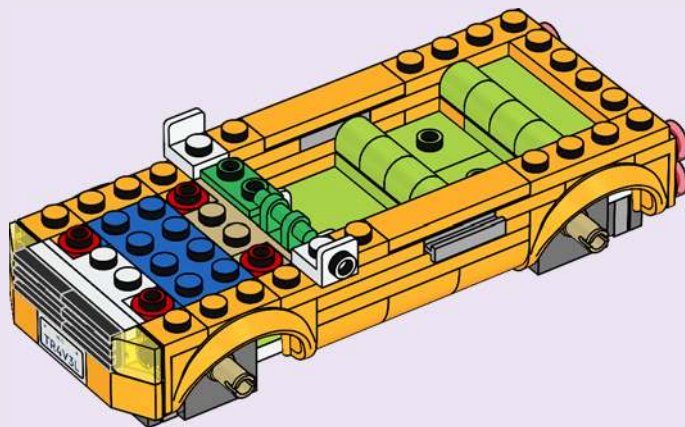



2x

42

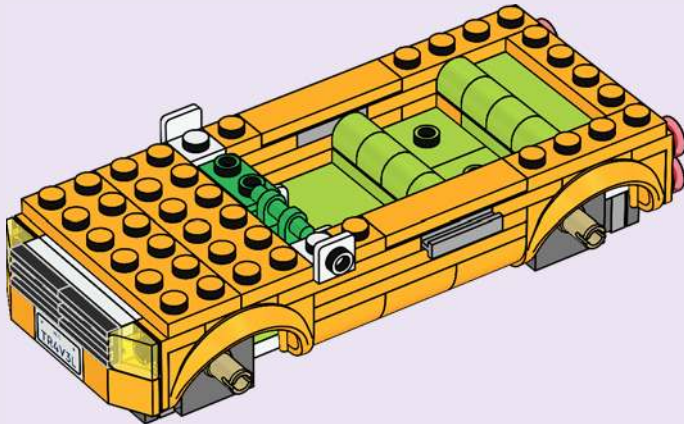



2x



1x

43

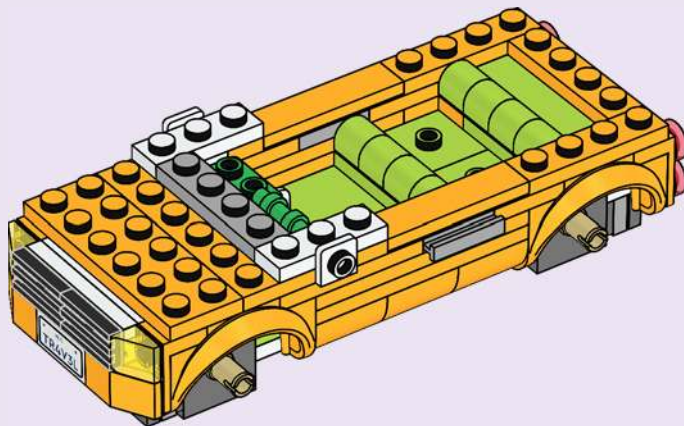



2x

44

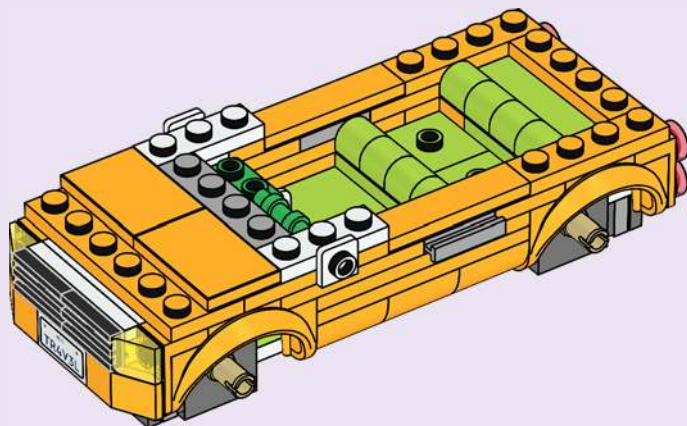



2x

45

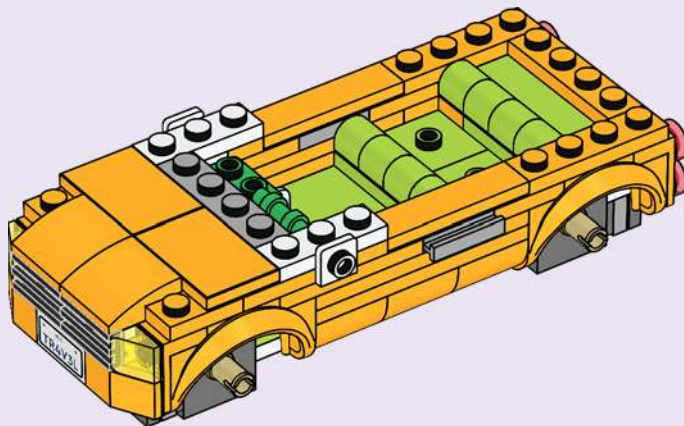



1x



1x

46

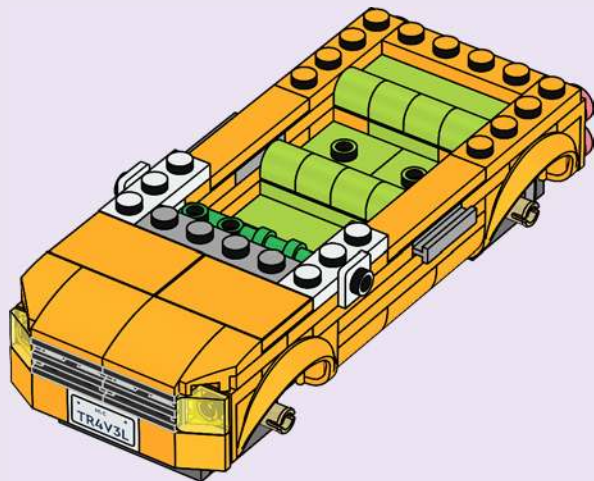



2x

47

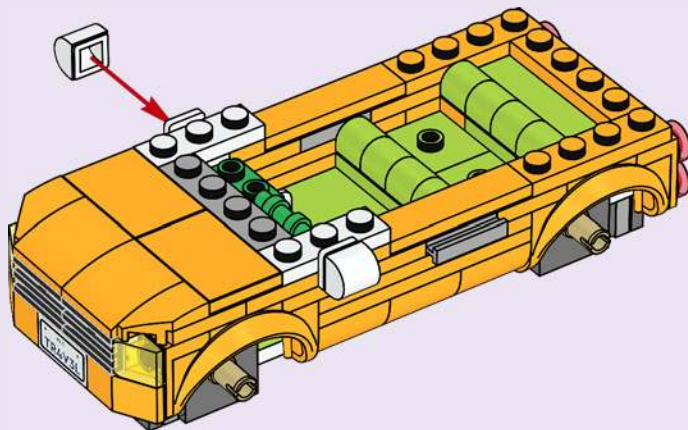

1x 1x 2x

48

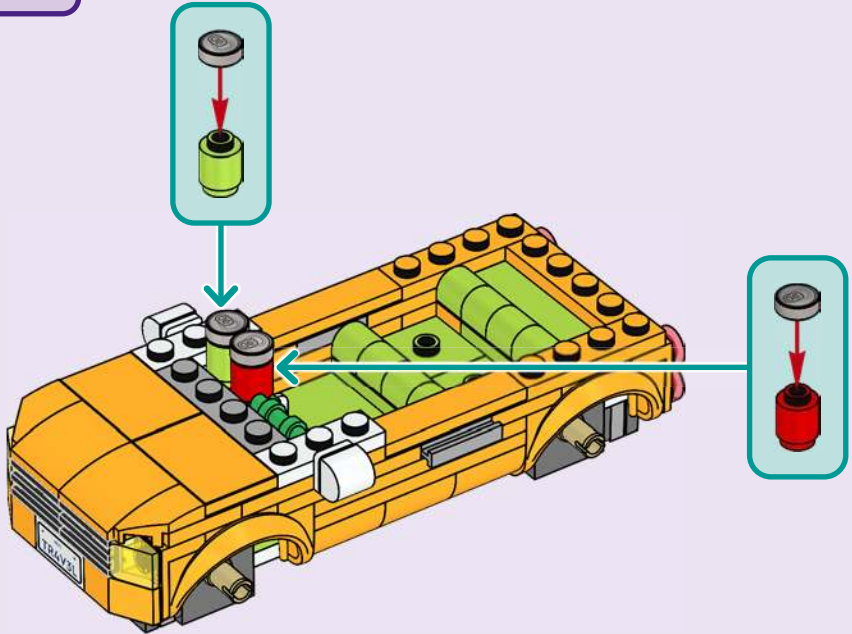



1x

49

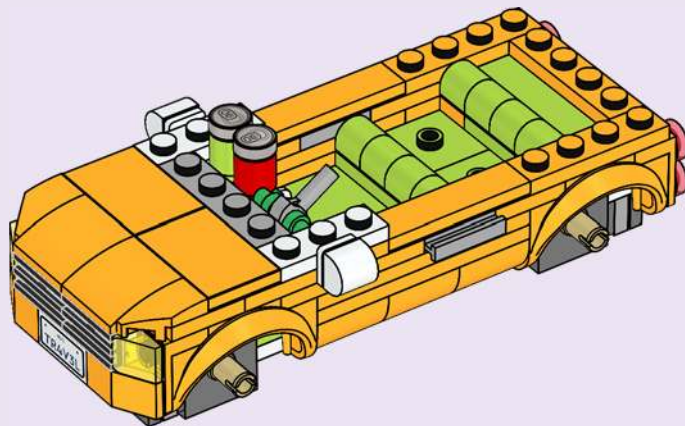



1x

50

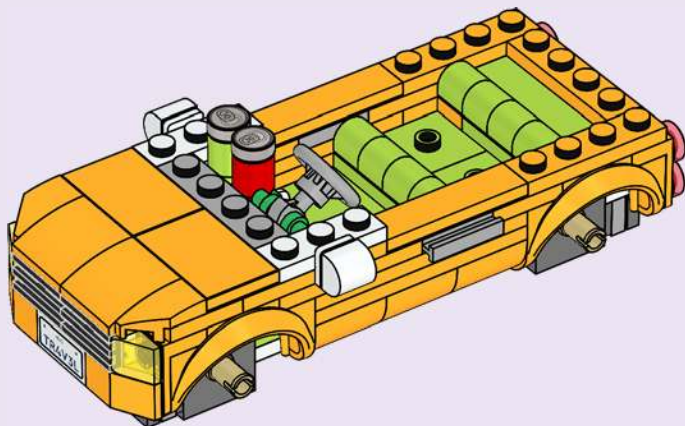



51

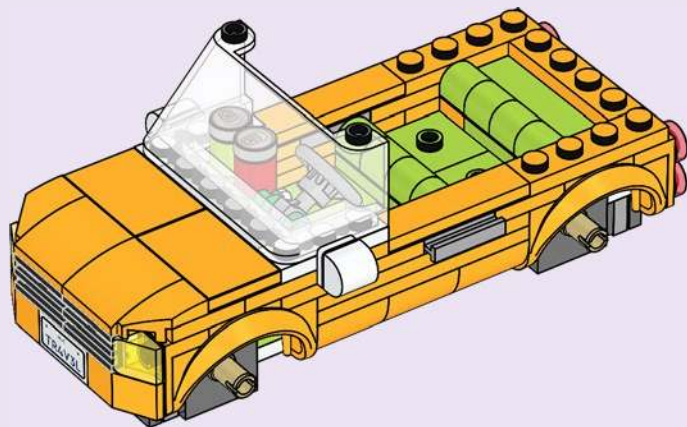



LIANN

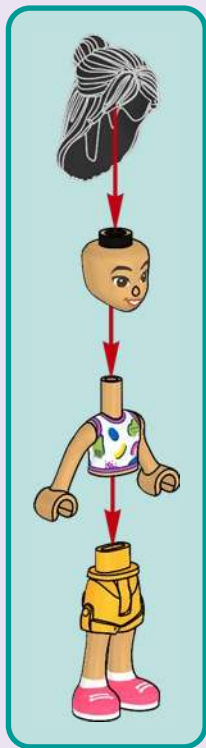

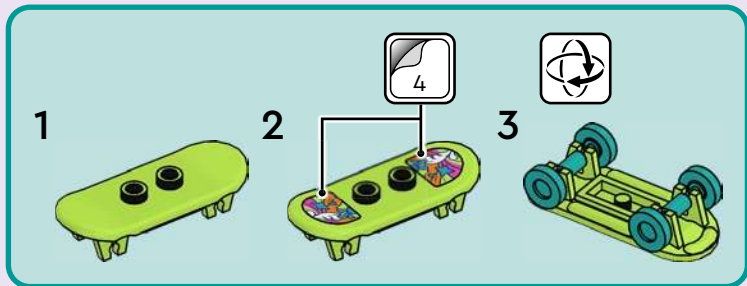



52

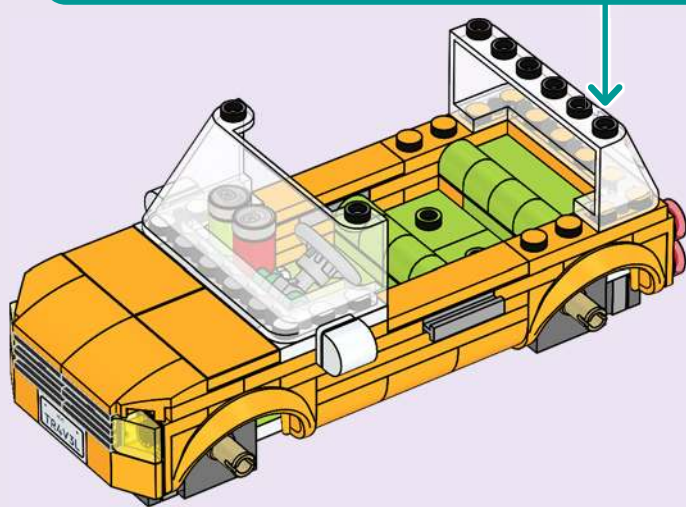
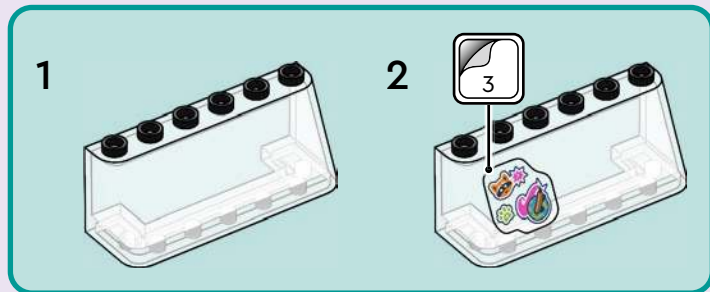



2x

53

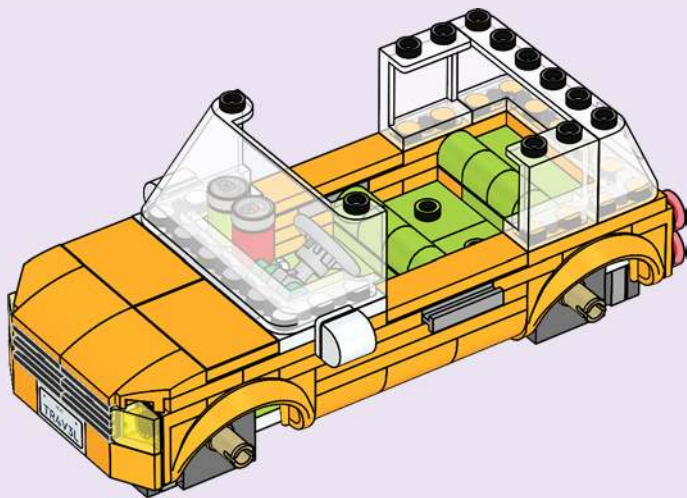



2x



1x

54

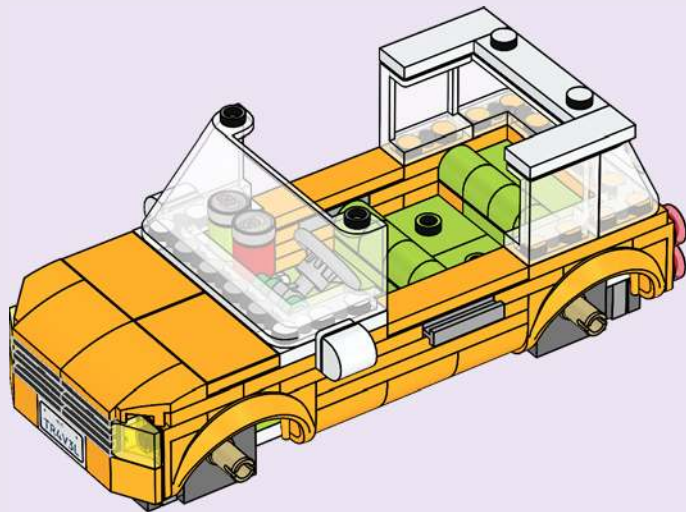



1x

55



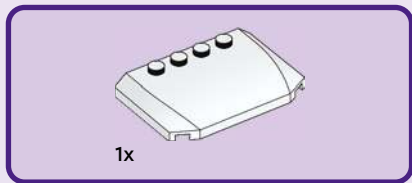

56

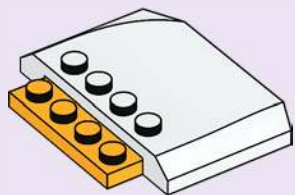

57





1x

58

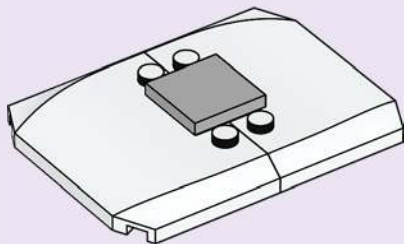



2x

59

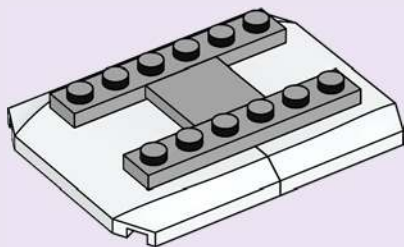



2x

60

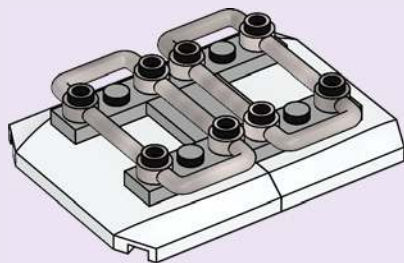

1x

61

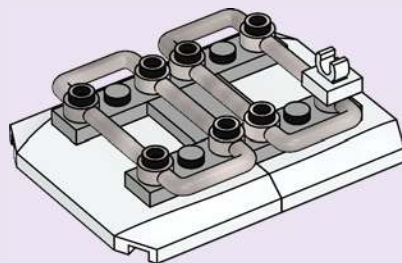

62

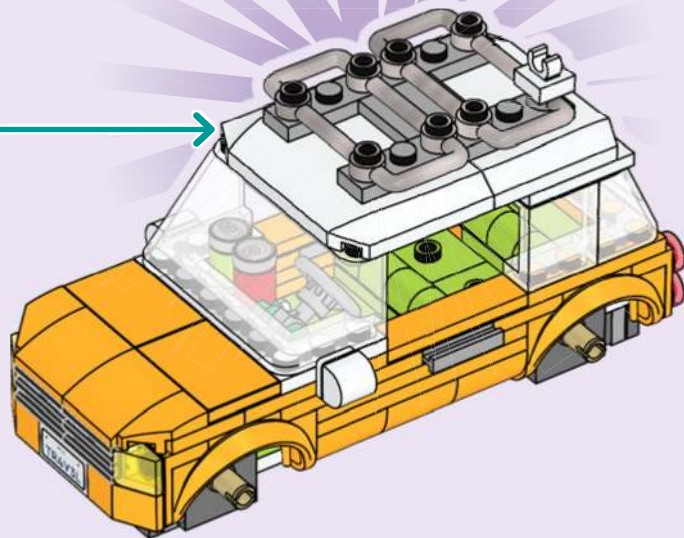



63

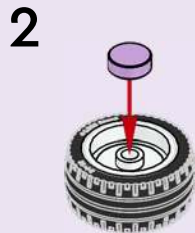
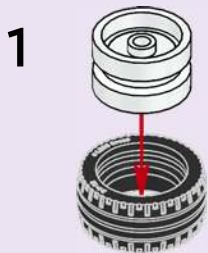

4x

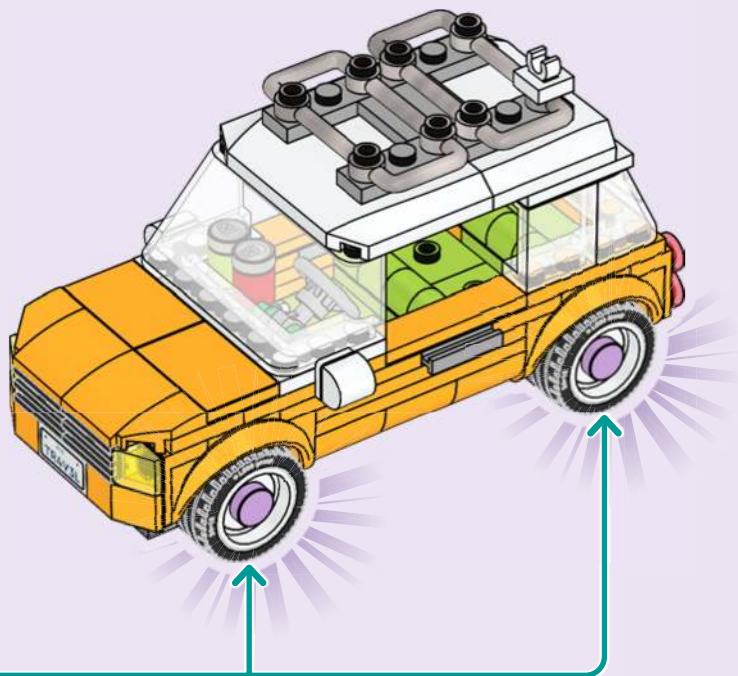

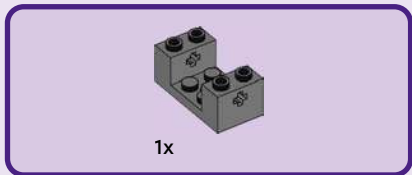
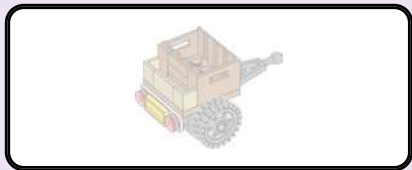

1x

64

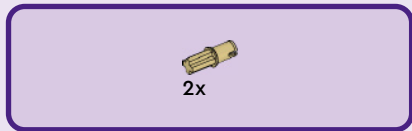
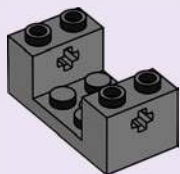

2x

65

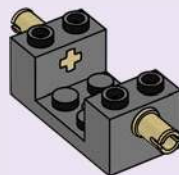



1x

66



1x

67

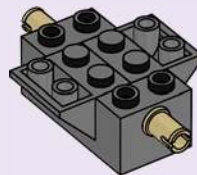



1x

68

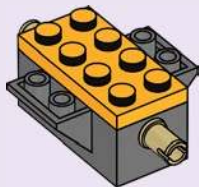

1x

69

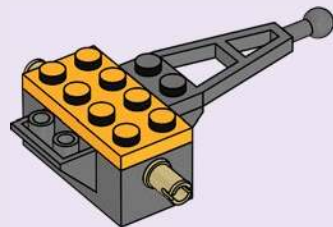



1x

70

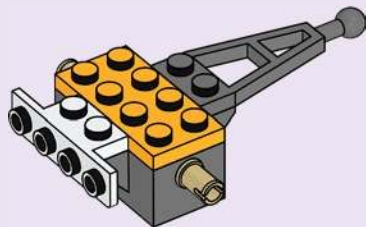

1x

71

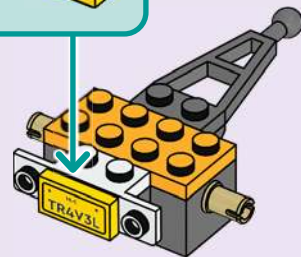
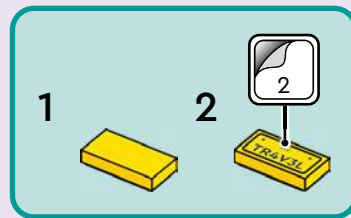



2x

72



1x

73

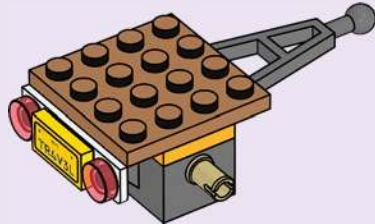



1x

74

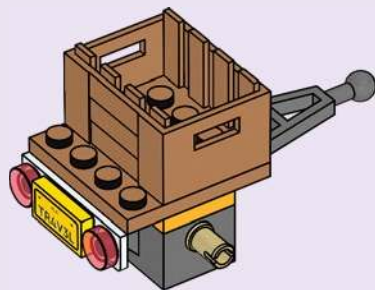

2x



1x

75

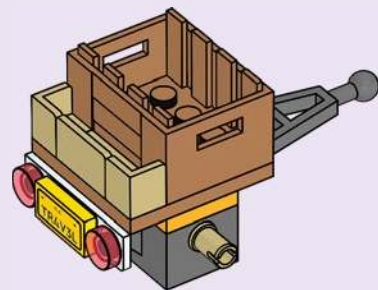



76

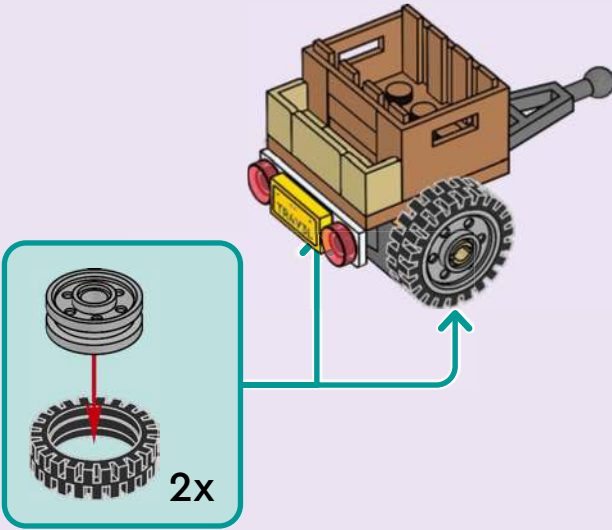

77

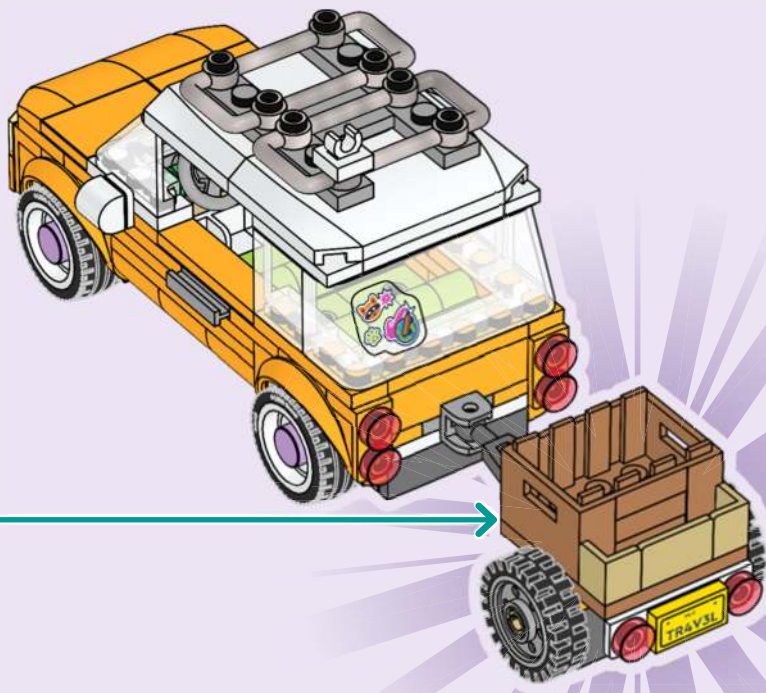

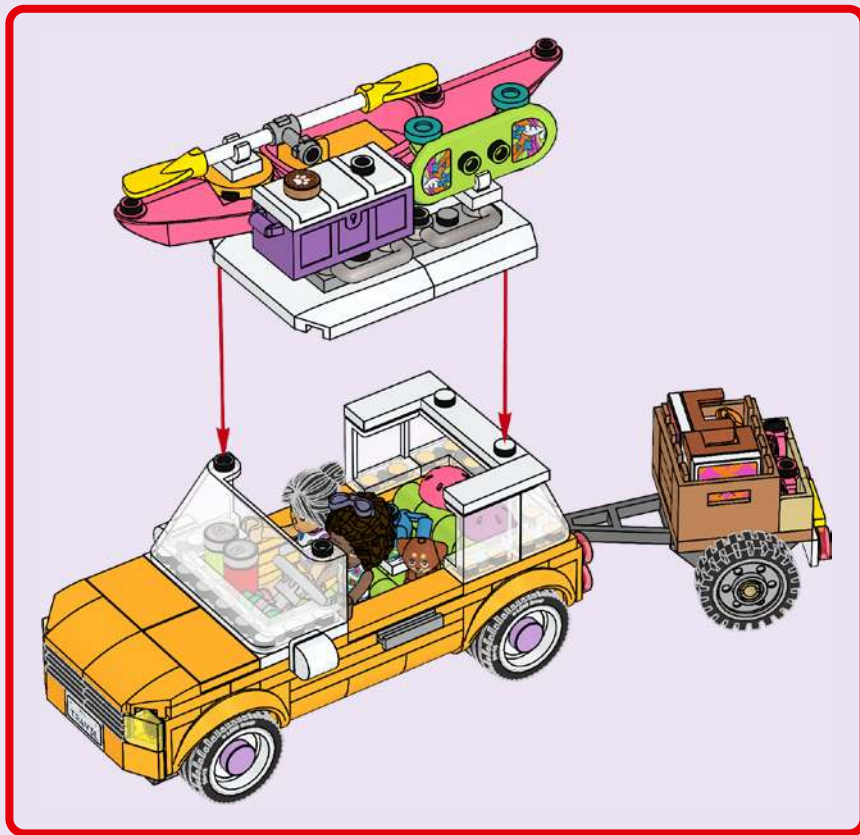



LEGO

Friends



42664

42652



42663



42661



42650





Friends



NOVA

ALIYA

LIANN

LEO

AUTUMN



Friends



42673

































Friends

WATCH
SERIES
ONLINE



WATCH SERIES ONLINE / SCHAU DIR DIE SERIE ONLINE AN / REGARDE LA SÉRIE EN LIGNE / GUARDA LA SERIE ONLINE / MIRA LA SERIE EN INTERNET / ASSISTIR À SÉRIE ONLINE / 在线观看 / OGLĄDAJ SERIAL W INTERNECIE / SLEDUJ SERIÁL ONLINE / POZRI SI SERIÁL ONLINE / NÉZD A SOROZATOT ONLINE / ДИВІТЬСЯ СЕРІАЛ ОНЛАЙН / VIZIONEAZĂ SERIALUL ONLINE / ГЛЕДАЙТЕ СЕРІАЛА ОНЛАЙН / SKATIES SERIĀLU TIĒŠSAISTĒ / VAATA SARJA VEEBIST / ŽIŪRĒK SERIALĄ INTERNETU

 2x 6258135	 2x 4558168	 2x 6428803	 1x 6212758	 1x 6409763	 1x 6416470	 1x 4212454	 2x 6023173
 2x 6348055	 1x 6158058	 4x 242001	 6x 4666579	 4x 241226	 2x 6528544	 1x 6087084	 1x 6289747
 2x 6242241	 1x 6168618	 2x 6013866	 5x 306221	 2x 4541455	 6x 6514189	 8x 6312452	 1x 6289745
 1x 6542056	 1x 6168618	 2x 6013866	 2x 302321	 2x 4541455	 2x 6245272	 1x 4164022	 1x 6133933
 1x 306901	 1x 371001	 2x 362301	 2x 614123	 4x 6102596	 1x 6136310	 2x 6056291	 2x 6028736
 2x 6093479	 1x 6249091	 2x 4612603	 2x 302323	 2x 6253231	 2x 6421682	 1x 6138657	 1x 6133805
 4x 6290262	 1x 302001	 1x 6507789	 1x 302023	 2x 6253231	 3x 4187743	 2x 6073040	 6x 6469079
 1x 300101	 2x 4261565	 1x 6146221	 2x 6424021	 1x 6510175	 1x 4164021	 4x 6540972	 2x 6099730
 1x 6437723	 1x 303501	 1x 6318084	 1x 306924	 1x 6503221	 1x 6212989	 1x 6423146	 1x 6020147
 1x 6437723	 1x 303501	 1x 6318084	 2x 302124	 1x 6503221	 1x 6064097	 1x 6423146	 1x 6020147

2x
6065504

2x
6286881

5x
6020073

2x
6072668

1x
6003004

2x
6097511

4x
6421680

4x
6020074

4x
6097509

1x
4640844

1x
6092956

2x
6044729

2x
4211568

1x
4211397

1x
4211413

1x
6273227

3x
4211445

2x
4211438

1x
6439041

1x
6409768

2x
4211000

2x
6271127

2x
4211053

3x
6335115

1x
6472960

1x
4210997

1x
6476484

1x
6481595

4x
6322820

1x
6287856

1x
6329593

1x
6287854

1x
6035734

1x
6397823

1x
6096991

1x
6416663

1x
6541665

1x
6416546

1x
6528290

1x
6056226

2x
6322904



2x
6385229

1x
6099243

1x
4542391

2x
6509803

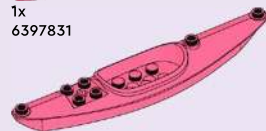

1x
6397831

1x
6540970

 [LEGO.com/service](https://www.lego.com/service)

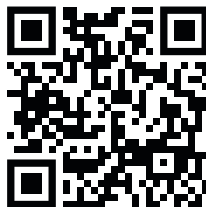

YOU COULD
WIN



Scan this QR code or go to
LEGO.COM/PRODUCTFEEDBACK and give us
your short feedback about this LEGO® set
for a chance to win a cool LEGO prize.

Terms and Conditions apply*

EN: YOU COULD WIN. Terms and Conditions apply* **DE: Du könntest GEWINNEN.** Es gelten die Teilnahmebedingungen* **FR: Tu pourrais GAGNER.** Des conditions s'appliquent* **IT: Potresti VINCERE tu.** Termini e condizioni sono applicabili* **ES: Puedes GANAR.** Aplican términos y condiciones* **PT: PODERÁ GANHAR.** Aplicam-se Termos e Condições* **ZH: 轻松获奖.** 条款和条件适用* **PL: Szansa na WYGRANĄ.** Obowiązuje regulamin* **CS: Máte šanci VYHRÁT.** Platí všeobecné smluvní podmínky* **SK: Máte šancu VYHRAŤ.** Platia všeobecné zmluvné podmienky* **HU: TE IS NYERHETSZ.** Felhasználási feltételek érvényesek* **UA: ВИ МОЖЕТЕ ВИГРАТИ.** Застосовуються загальні положення та умови* **RO: Ai putea CĂȘTIGA.** Se aplică termeni și condiții* **BG: Можете да СПЕЧЕЛИТЕ.** Има определени правила и условия* **LV: Tu vari LAIMĒT.** Ir spēkā noteikumi un nosacījumi.* **ET: Sul on võimalus VÕITA.** Kehtivad tingimused* **LT: Jūs galite LAIMĖTI.** Taikomos sąlygos*

*[LEGO.com/productfeedback-terms](https://www.lego.com/productfeedback/terms)

