



Friends

42661



2

3



OLLY

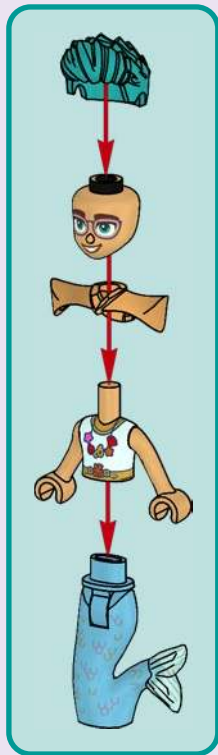

LEO

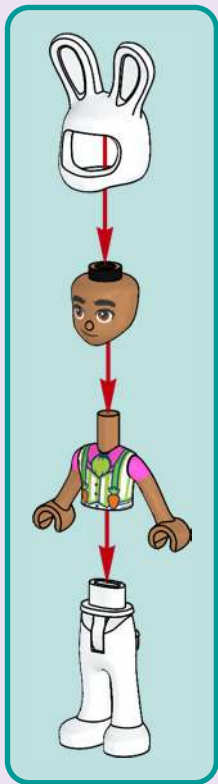

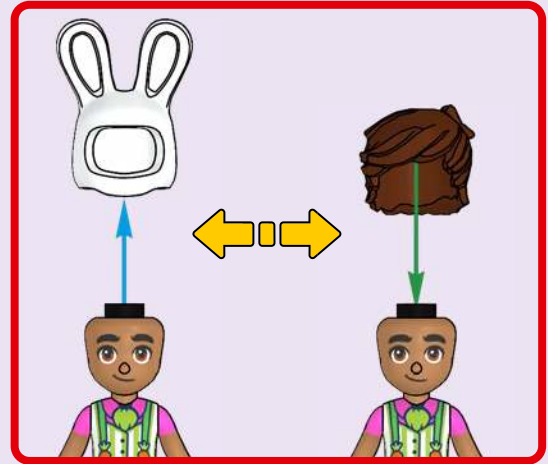
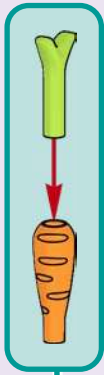

CHURRO



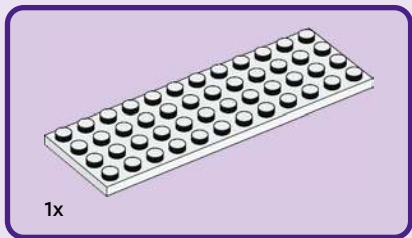
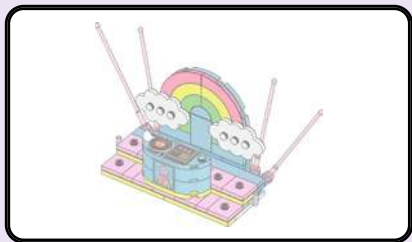

1x

1

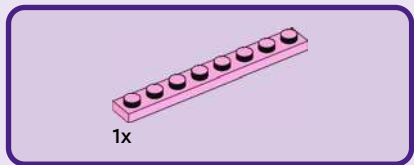
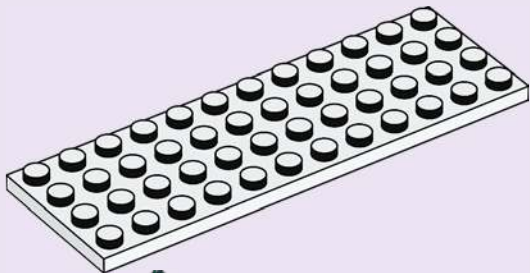

1x

2

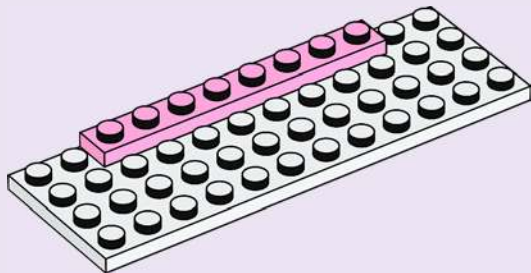



3

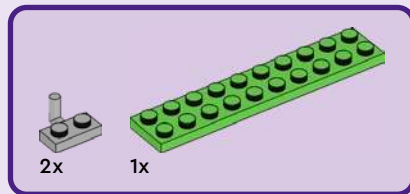
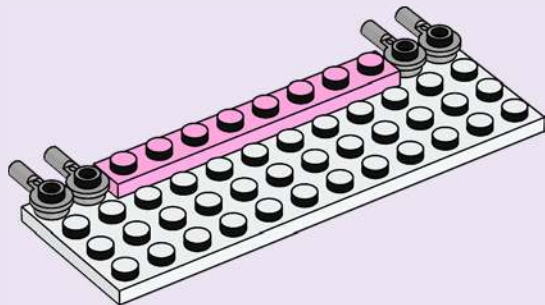

4

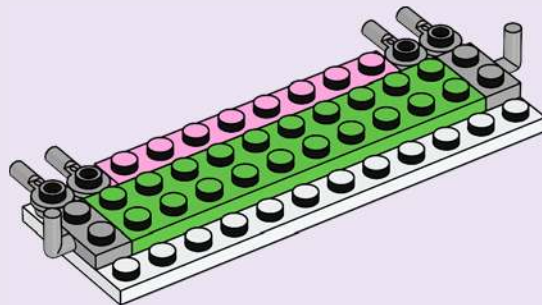

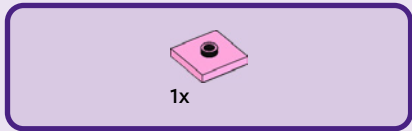

5

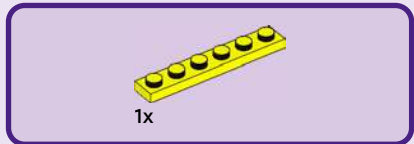
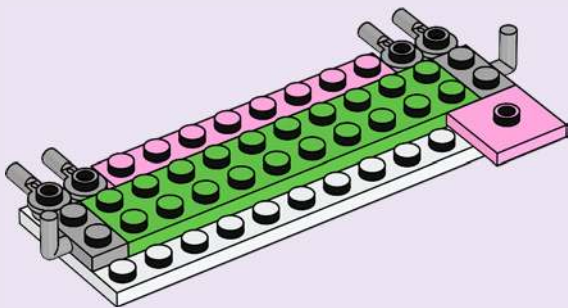

6

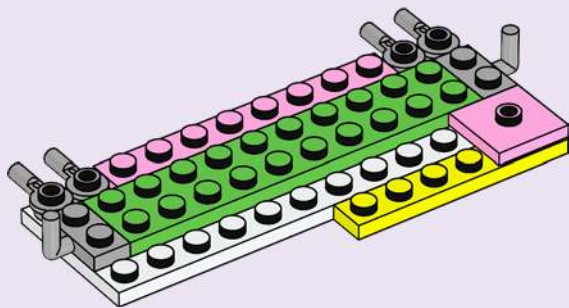

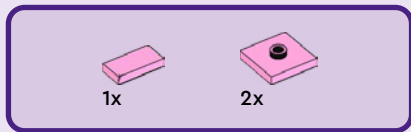

7

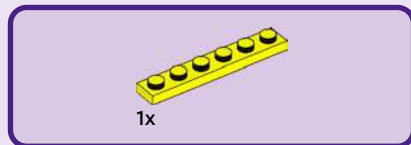
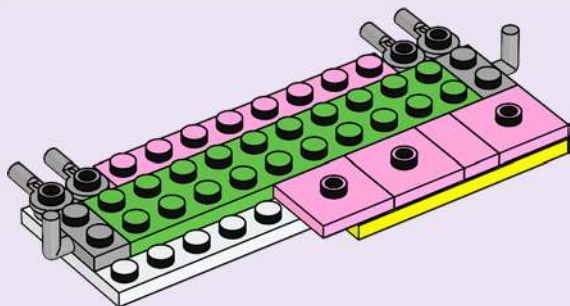

8

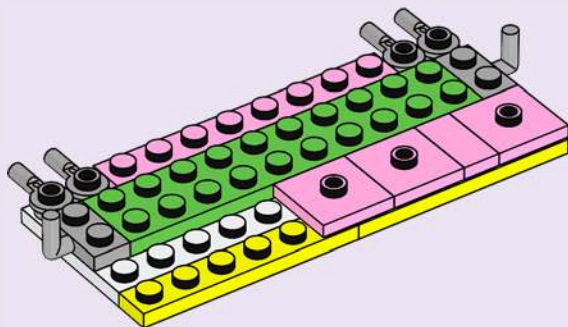

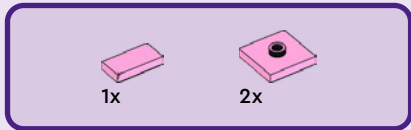

9

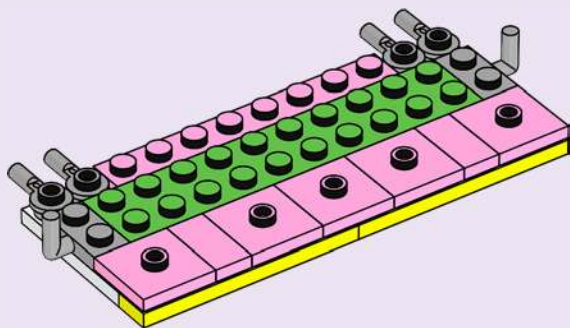

10

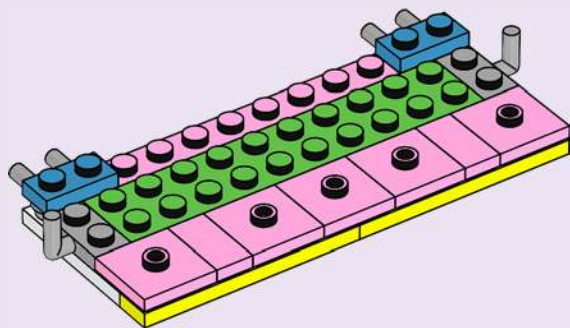

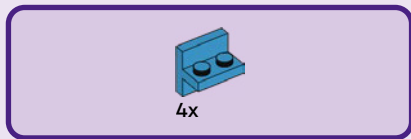

11

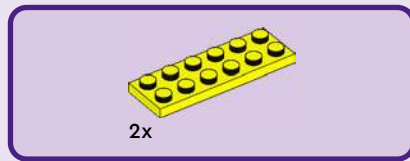
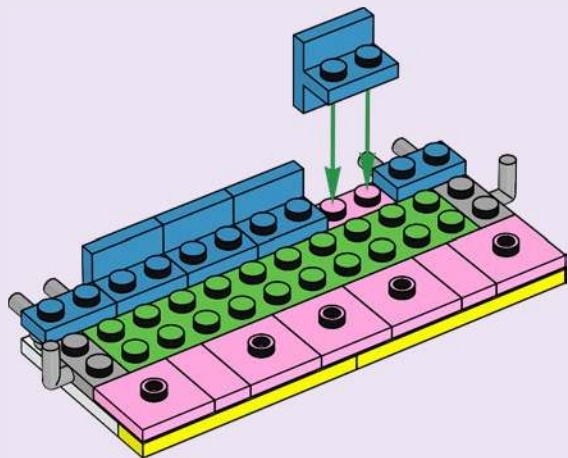

12

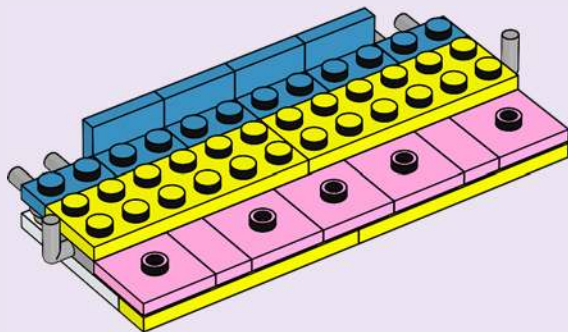

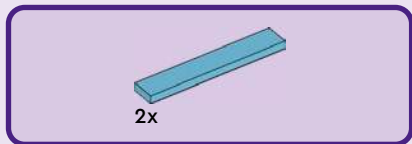

13

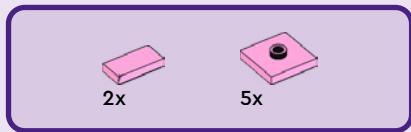
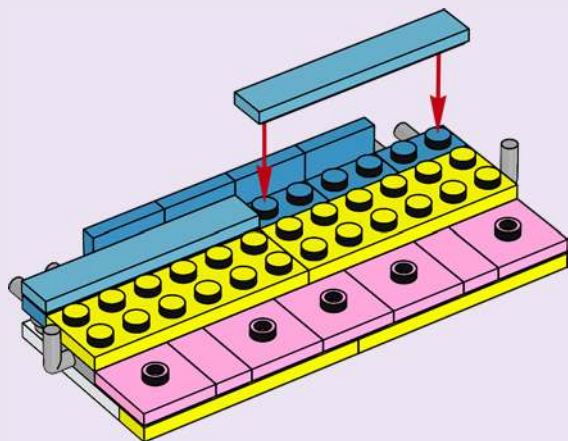

14

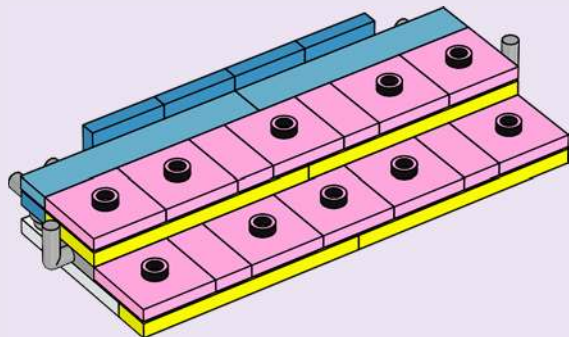

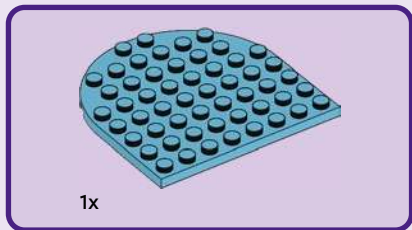
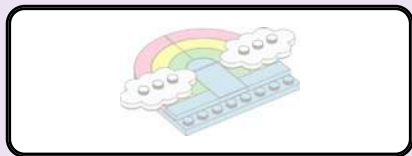

15

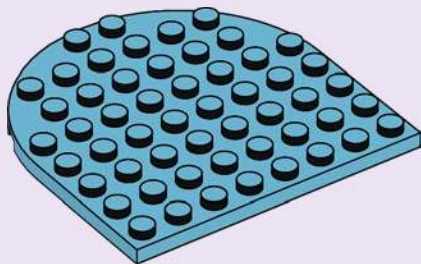

16

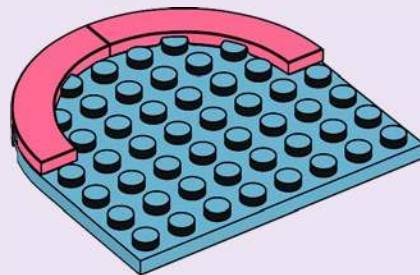



17

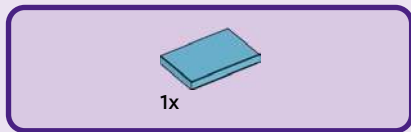
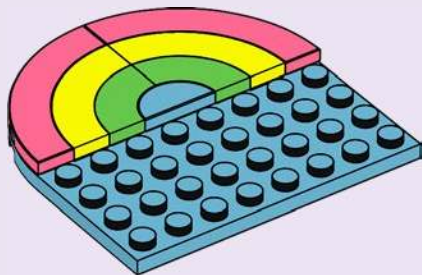

18

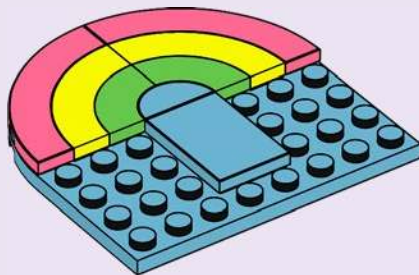



19

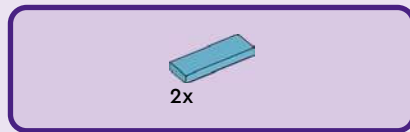
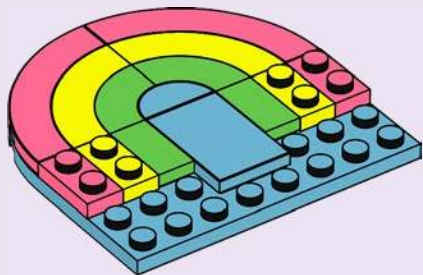

20

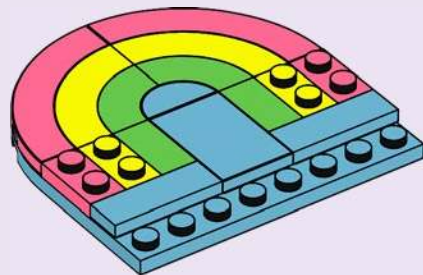



2x

21



22

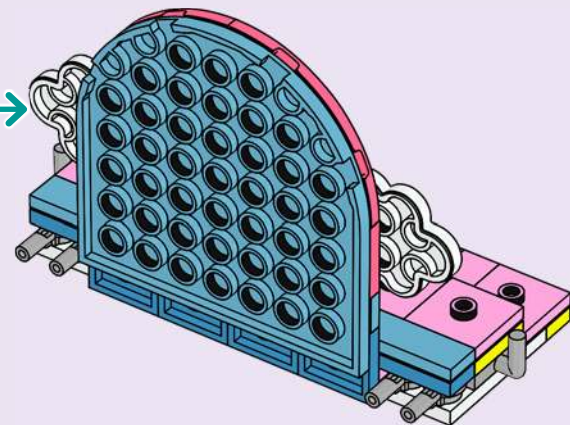
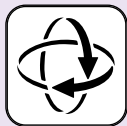



2x

23

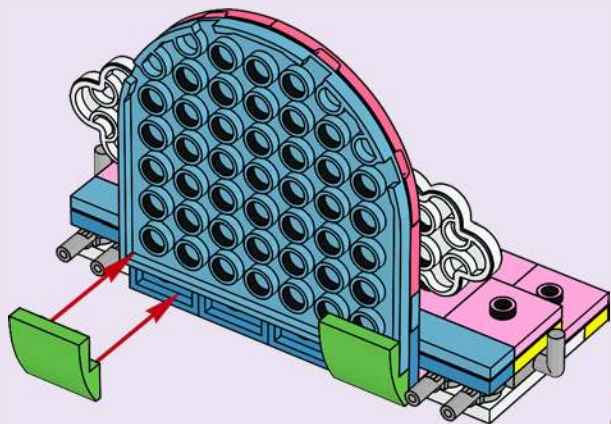

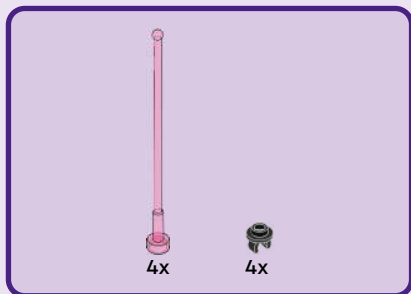

24

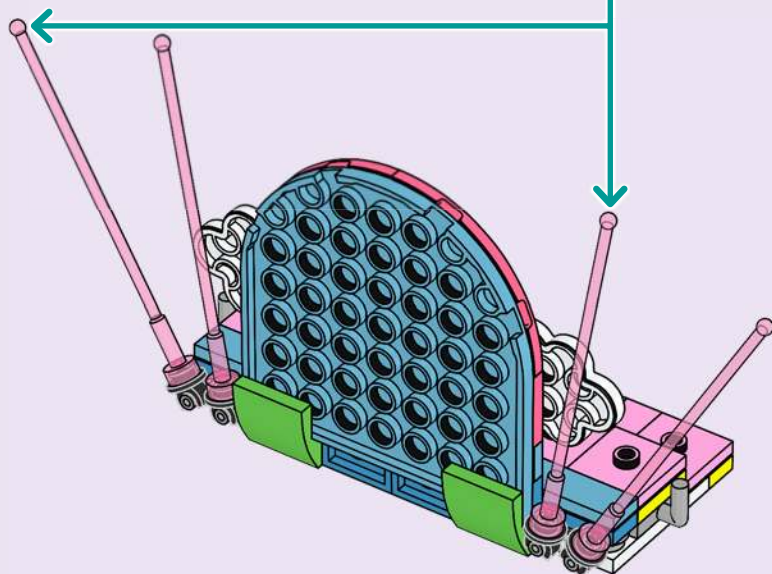
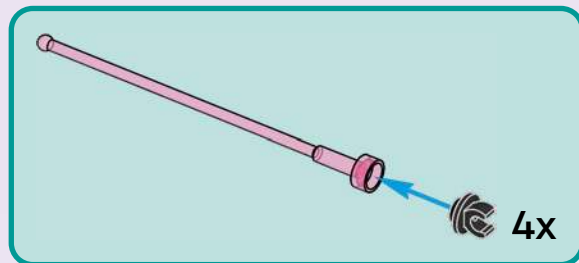

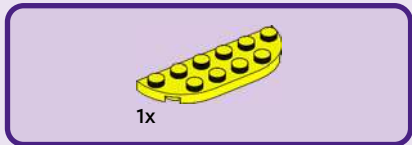

25

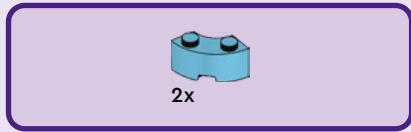

26

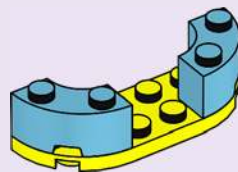

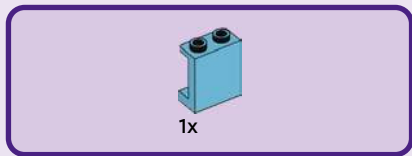

27

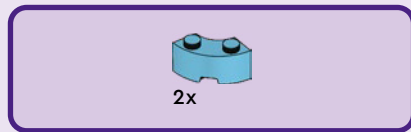
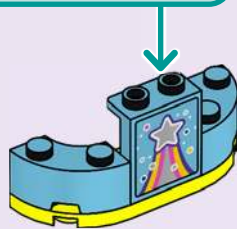
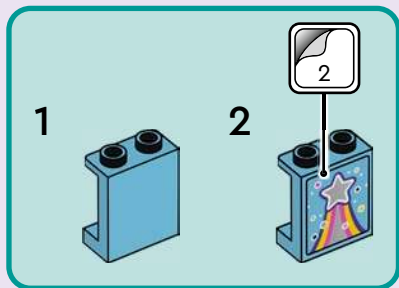

28

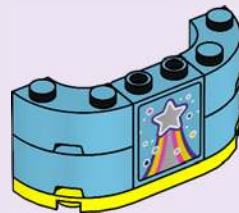



1x

29



1x



1x

30





31

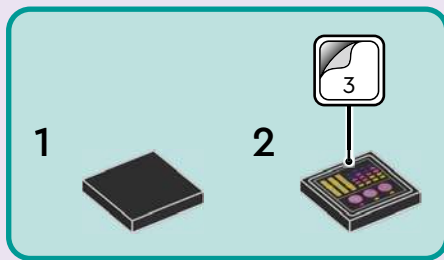

32

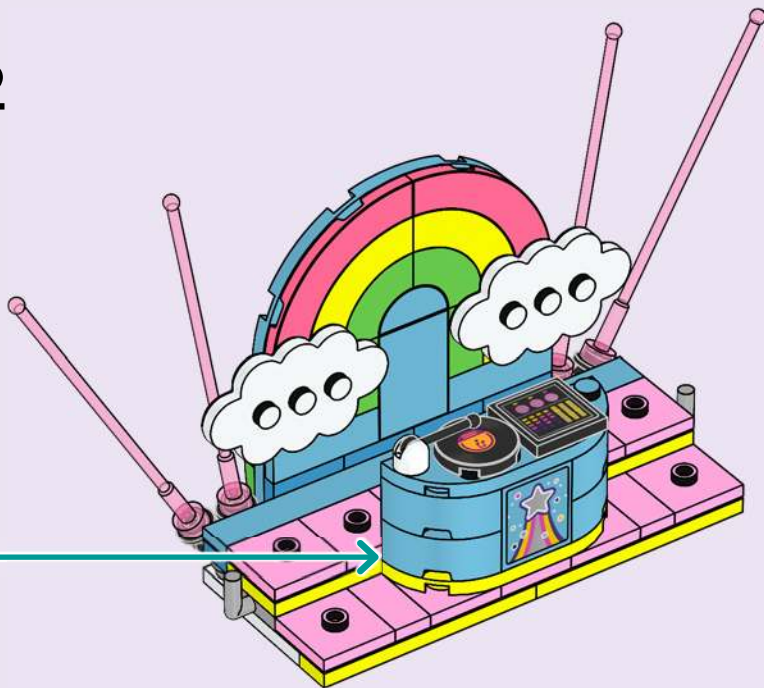
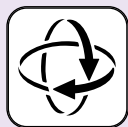

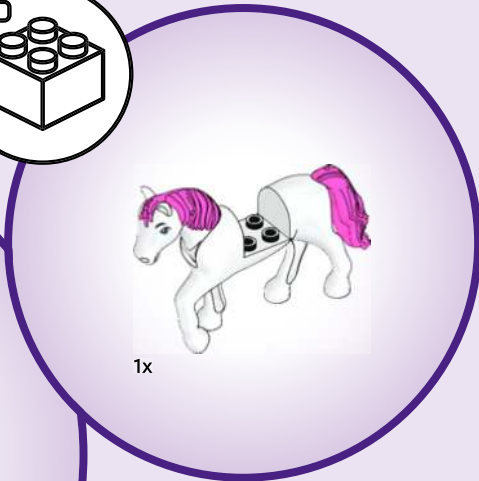
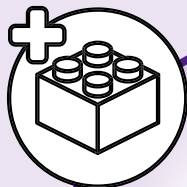

1

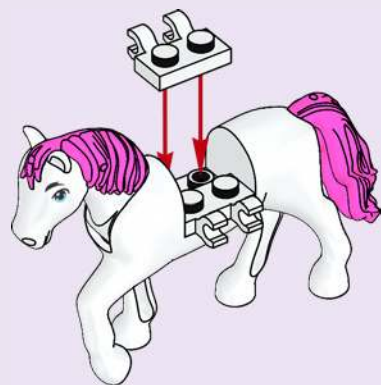

2

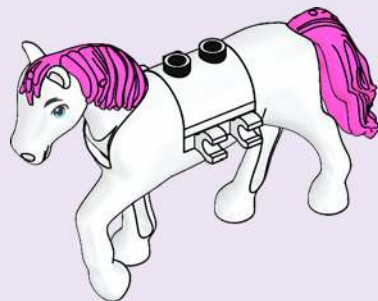

3

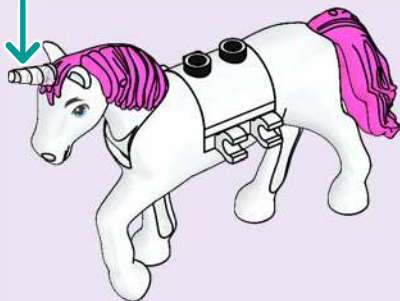

4

PERIWINKLE



1

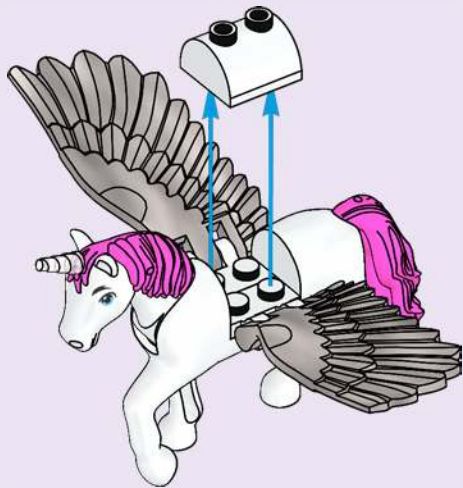

2

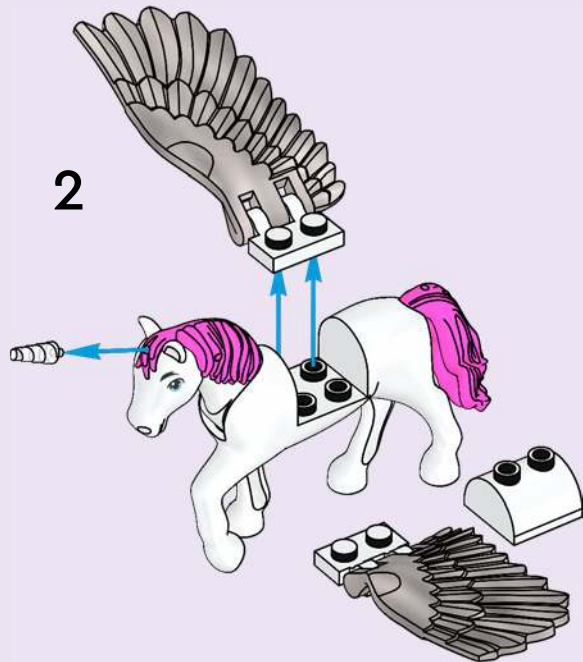

3

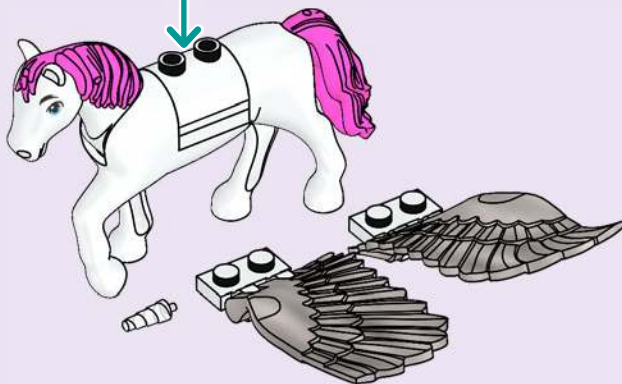
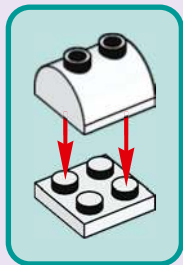

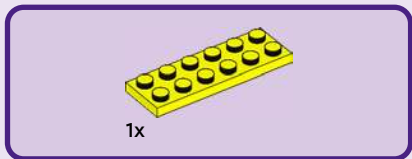
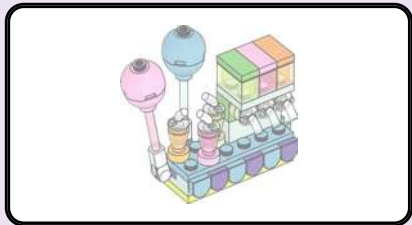

1x

33





3x

34

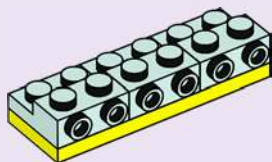

2x



1x



1x

35

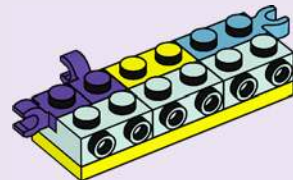



1x

36

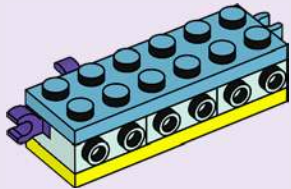

3x



3x

37

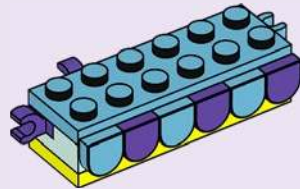

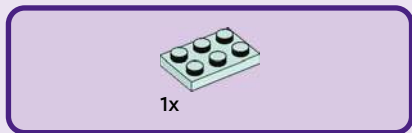

1x

38



1x

1x

1x

39



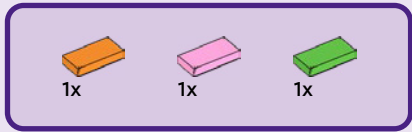

40

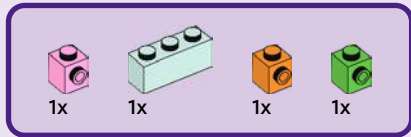

41

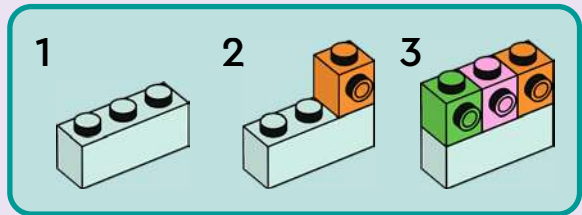



1x



1x

42



1x



1x

43

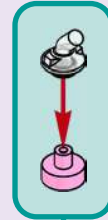



1x



1x

44

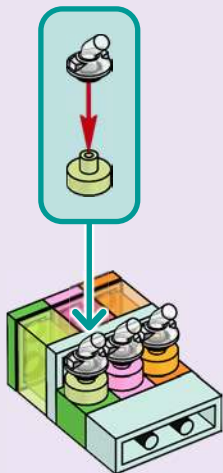

45

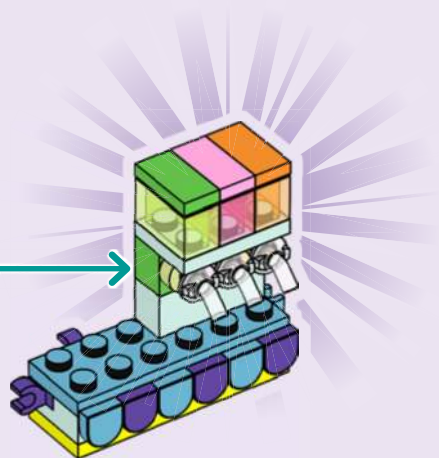



46

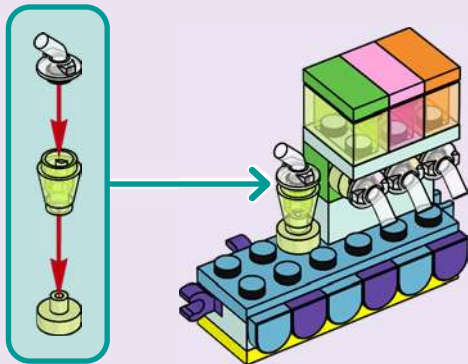

47

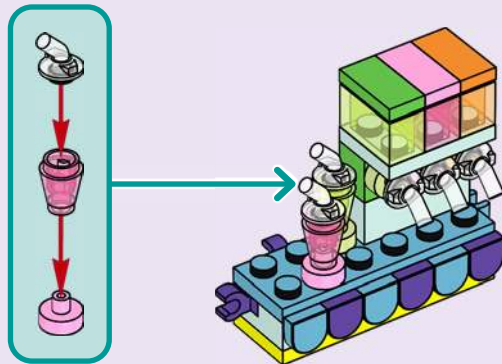



48

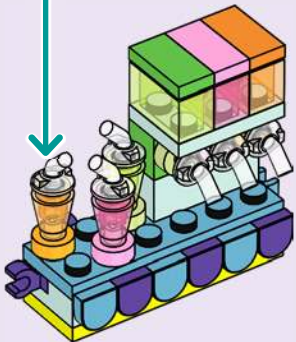

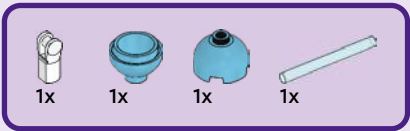

49

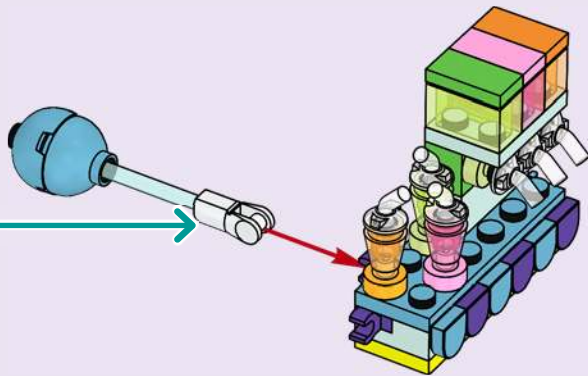
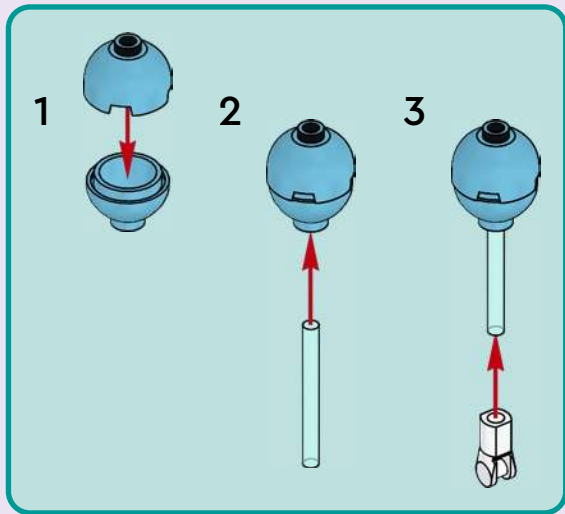

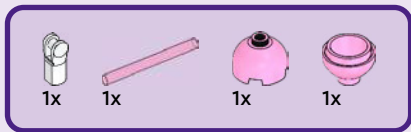

50

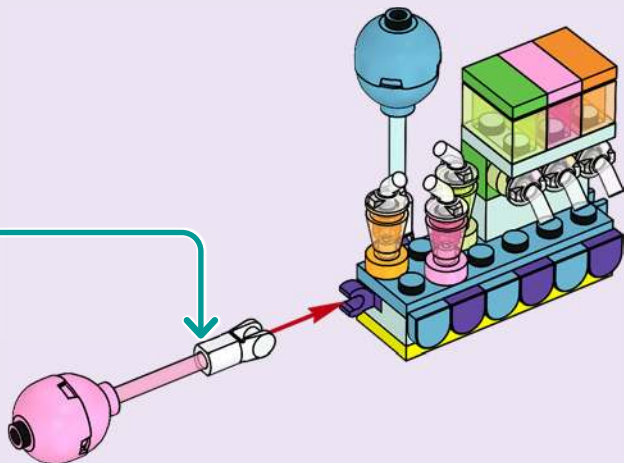
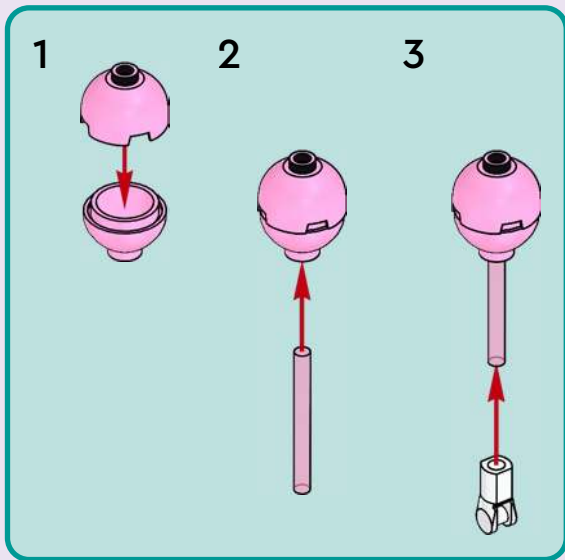

51

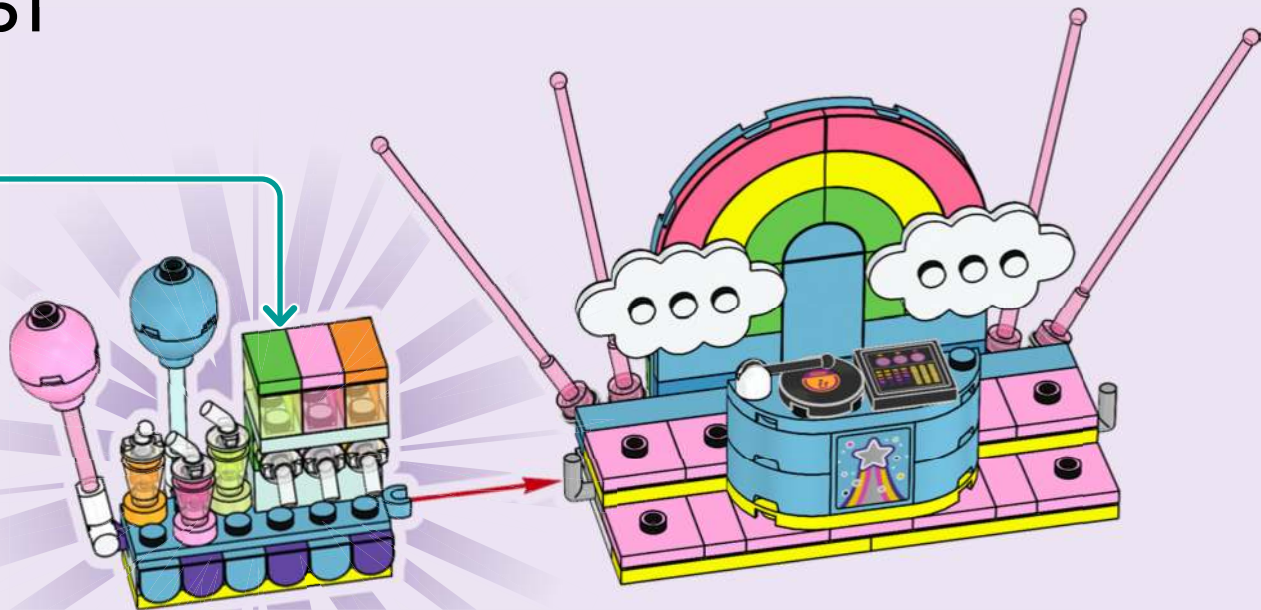

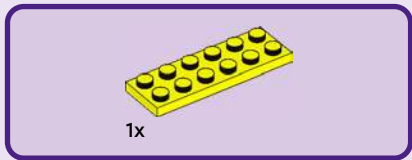

52

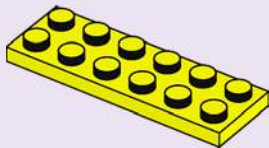

53

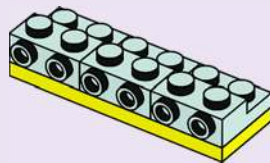



2x



1x



1x

54

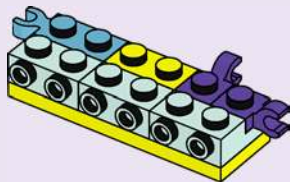

3x

55

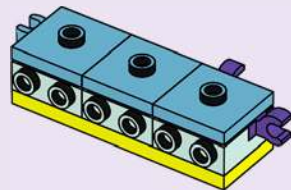



3x



3x

56

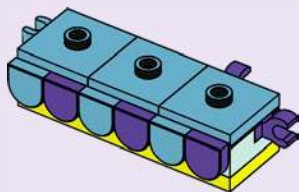



57

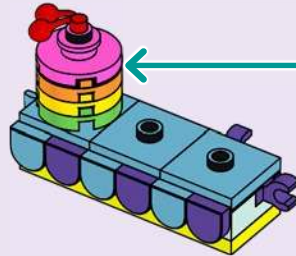
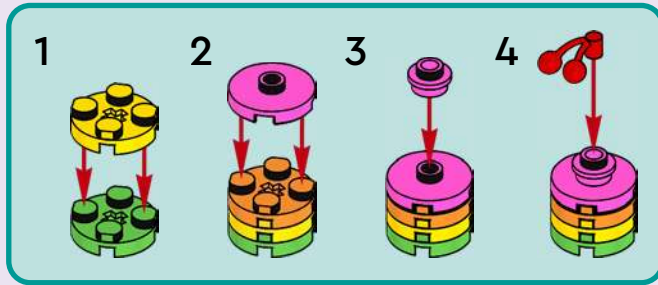



58

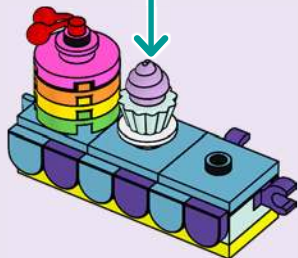

59

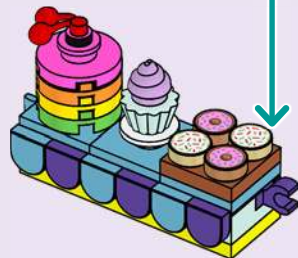

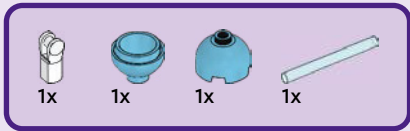

60

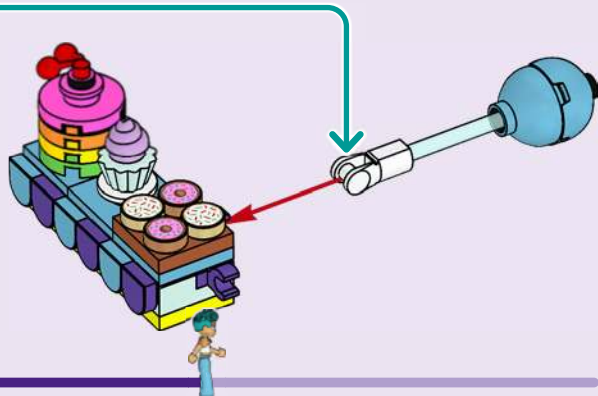
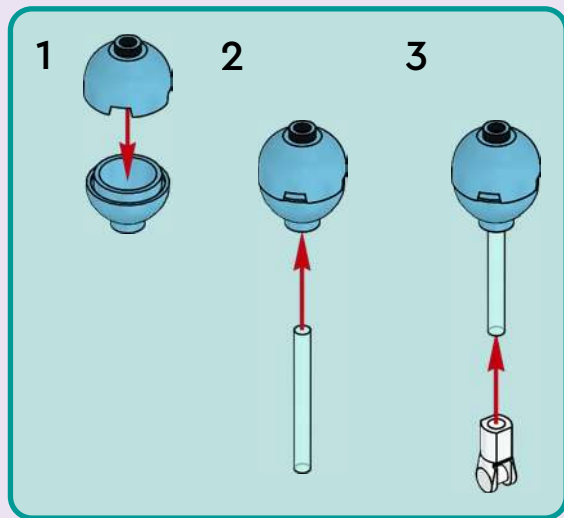

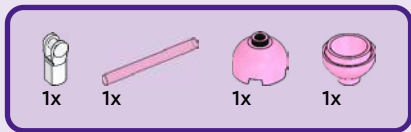

61

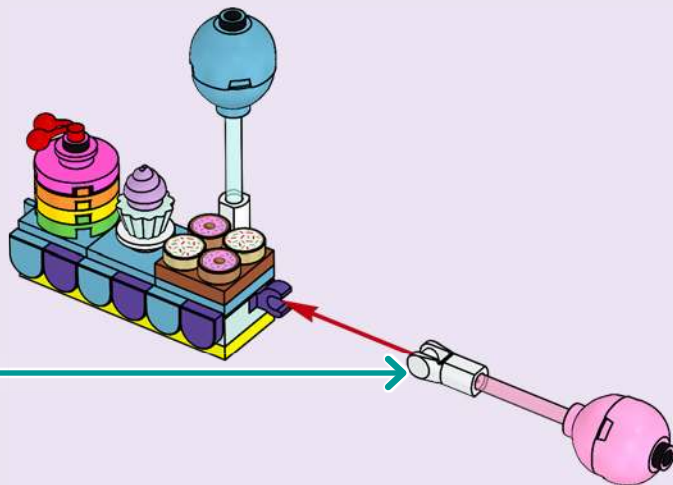
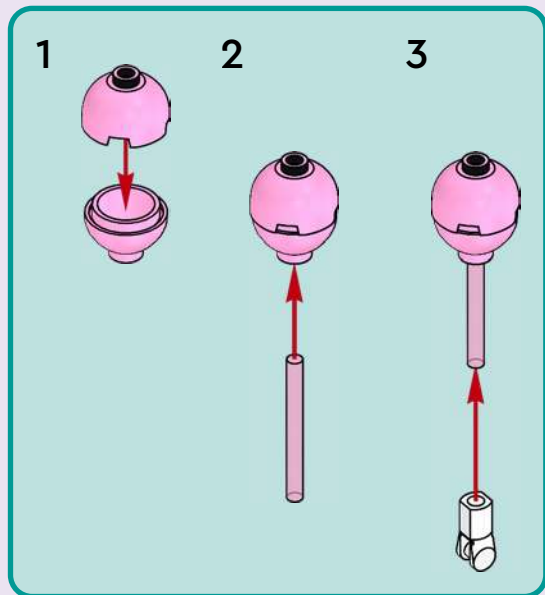

62





2x



1x

63

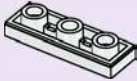

1x

64





1x

65



1x

66





1x

67

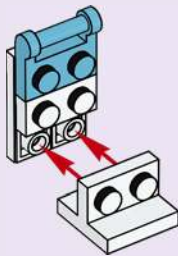
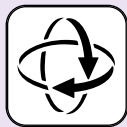

1x



1x

68

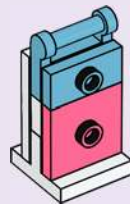



1x



1x

69



1x

70

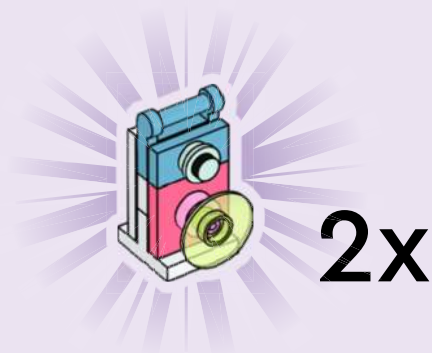

2x



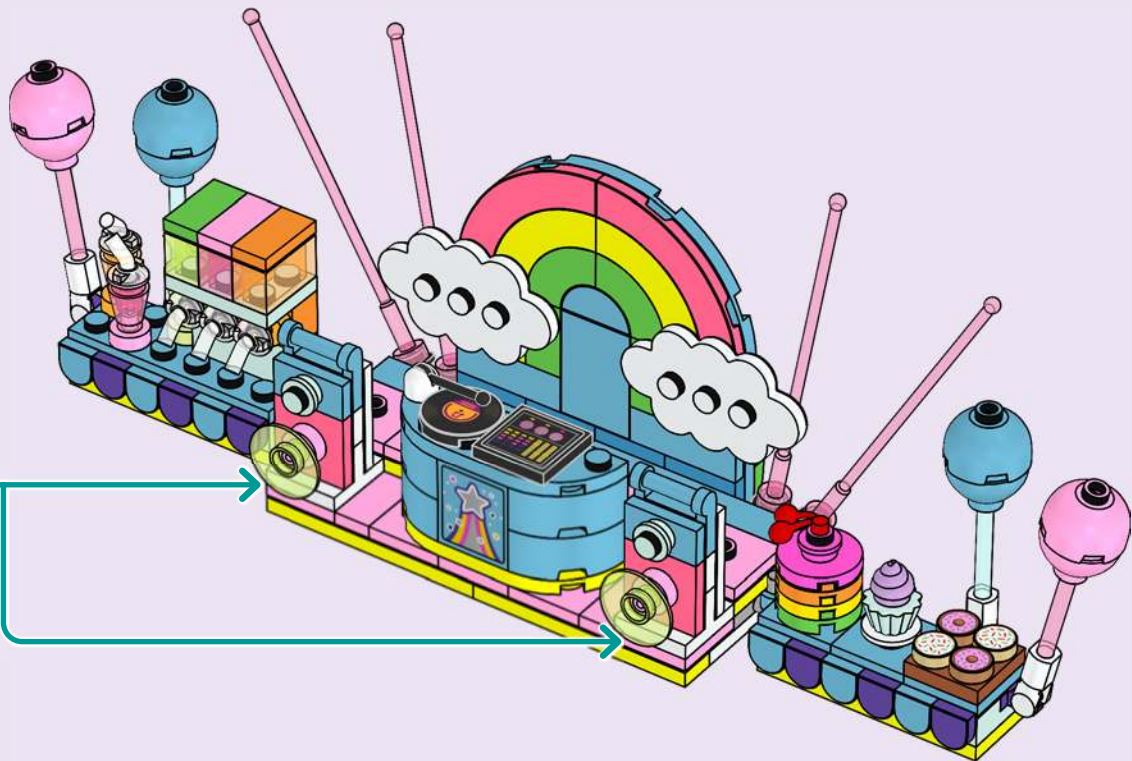



LEGO

Friends



42664

42652



42663



42661



42650





Friends



NOVA

ALIYA

LIANN

LEO

AUTUMN

- 1x 73737
- 4x 6322489
- 1x 6508151
- 2x 6172366
- 1x 6471108
- 1x 6546358
- 1x 6537804
- 1x 6051511
- 2x 302301
- 2x 6347287
- 4x 6250019
- 1x 4140583
- 1x 4624989
- 1x 6210385
- 4x 6223491
- 2x 371001
- 1x 6023806
- 2x 6223667
- 1x 302201
- 1x 4168072
- 1x 303201
- 2x 6361753
- 1x 6100565
- 1x 6499709
- 1x 6509767
- 1x 403224
- 1x 6186675
- 4x 6534180
- 1x 6546404
- 1x 6485111
- 1x 6546170
- 1x 6431014
- 1x 306826
- 1x 6469830
- 1x 6464978
- 1x 6138624
- 1x 6462430
- 3x 6195258
- 2x 6382958
- 2x 6404643
- 1x 6546393
- 1x 4615606
- 6x 6510188
- 1x 6538584
- 2x 6507882
- 1x 6431334
- 1x 6030521
- 1x 6424015
- 1x 4188771
- 1x 6549058
- 1x 6420268
- 2x 6507885
- 1x 6525789
- 1x 6547052
- 4x 6362970
- 1x 6514026
- 1x 6245512
- 1x 6514270
- 2x 6507885
- 1x 6525789
- 1x 6230582
- 1x 6223767
- 1x 6514017
- 1x 6514273
- 2x 6223719
- 1x 6424457
- 4x 6227897
- 2x 6261353
- 1x 6039479
- 1x 6230582
- 1x 6223767
- 4x 6230579
- 1x 4621554
- 1x 6537809
- 2x 6541655
- 2x 6519484
- 5x 4580010
- 10x 6251842
- 1x 6143789



1x
6543255



6x
6313558



4x
6347297



2x
4655691



1x
6537795



1x
6537805



1x
6546398



1x
6557655



1x
6173109



1x
6270116



1x
6581875



1x
6322813



1x
6514024



2x
6518820



1x
6514269



2x
6329593



1x
6416551



1x
6546367



1x
6398396



1x
6398397



2x
4653988



4x
6424641



2x
6102986



6x
6375606



1x
6510074



6x
6445843



1x
6546449



2x
6132411



2x
6429058



8x
6331949



1x
6369854



2x
6236582



2x
6441239



3x
6126090



4x
6176171



2x
6097492



1x
6233166



1x
6292824



2x
6185309



1x
6146926



2x
6382504



1x
6500671



1x
6296050



1x
6361352



6x
6470182



1x
6295228



1x
6426724



1x
6492250



8x
6223506



2x
6258094



2x
6287638



2x
6458179



1x
6527047



1x
6514061



2x
6545922



1x
6388034



4x
6382324



2x
6525159



5x
6391549



1x
6416639



1x
6546442



[LEGO.com/service](https://www.lego.com/service)



 LEGO.com/service

YOU COULD
WIN

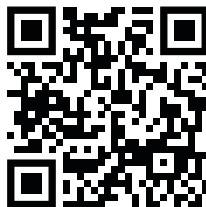

Scan this QR code or go to
LEGO.COM/PRODUCTFEEDBACK and give us
your short feedback about this LEGO® set
for a chance to win a cool LEGO prize.

Terms and Conditions apply*

EN: YOU COULD WIN. Terms and Conditions apply* **DE: Du könntest GEWINNEN.** Es gelten die Teilnahmebedingungen* **FR: Tu pourrais GAGNER.** Des conditions s'appliquent* **IT: Potresti VINCERE tu.** Termini e condizioni sono applicabili* **ES: Puedes GANAR.** Aplican términos y condiciones* **PT: PODERÁ GANHAR.** Aplicam-se Termos e Condições* **ZH: 轻松获奖.** 条款和条件适用* **PL: Szansa na WYGRANĄ.** Obowiązuje regulamin* **CS: Máte šanci VYHRÁT.** Platí všeobecné smluvní podmínky* **SK: Máte šancu VYHRAŤ.** Platia všeobecné zmluvné podmienky* **HU: TE IS NYERHETSZ.** Felhasználási feltételek érvényesek* **UA: ВИ МОЖЕТЕ ВИГРАТИ.** Застосовуються загальні положення та умови* **RO: Ai putea CÂȘTIGA.** Se aplică termeni și condiții* **BG: Можете да СПЕЧЕЛИТЕ.** Има определени правила и условия* **LV: Tu vari LAIMĒT.** Ir spēkā noteikumi un nosacījumi.* **ET: Sul on võimalus VÕITA.** Kehtivad tingimused* **LT: Jūs galite LAIMĖTI.** Taikomos sąlygos*

*[LEGO.com/productfeedback-terms](https://www.lego.com/productfeedback/terms)

