



# MINECRAFT

21276



Q LEGO® Builder



LEGO.com/sustainable-packaging



FR  
**DONNEZ**  
OU  
**RECYCLEZ**



OU



OU



ASSOCIATION

MAGASIN

DÉCHÈTERIE

Adresses sur [quefairedemesdechets.fr](http://quefairedemesdechets.fr)

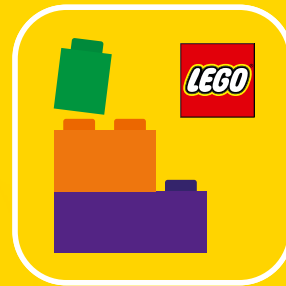

🔍 LEGO® Builder

# BUILDER



Apple and the Apple logo are trademarks of Apple Inc., registered in the U.S. and other countries and regions. App Store is a service mark of Apple Inc. Google Play and the Google Play logo are trademarks of Google LLC. Tencent and the Tencent logo are trademarks of Tencent Inc.

🔍 [LEGO.com/devicecheck](https://lego.com/devicecheck)

**EN** Ask parents' permission before going online | **DE** Eltern um Erlaubnis bitten, bevor du online gehst | **FR** Demande l'autorisation d'un parent avant d'aller en ligne | **IT** Chiedi il permesso ai tuoi genitori prima di andare online | **ES** Pídeles permiso a tus papás antes de conectarte a Internet | **PT** Peça autorização aos pais antes de acederes online | **ZH** 上网前应先征得父母的同意 | **PL** Poproś rodziców o zgodę, zanim wejdziesz do Internetu | **CS** Než půjdeš na internet, požádej rodiče o svolení | **SK** Skôr než pôjdeš na internet, vypýtaj si povolenie od rodičov | **HU** Kérj szülői engedélyt, mielőtt online csatlakoznál! | **UA** Запитуйте дозволу батьків, перш ніж користуватися інтернетом | **RO** Cere permisiunea părinților înainte de a te conecta online | **BG** Поискайте разрешение от родител, преди да влезете онлайн | **LV** Pirms došanās tiešsaistē palūdz atļauju vecākiem | **ET** Enne Interneti kasutamist küsi vanematelt luba | **LT** Prieš prisijungdami prie interneto, atsiklauskite tėvų



# MINECRAFT



## FUN FACT.

The Creeper™ was originally an incorrectly modelled pig.



Schon gewusst? Der Creeper™ war ursprünglich ein falsch geformtes Schwein.  
Info amusante : à l'origine, le Creeper™ était un cochon mal modélisé.  
Curiosità. Il Creeper era originariamente un maiale modellato in modo errato.  
Dato curioso: El Creeper™ comenzó siendo un cerdo mal modelado.  
Curiosidade: o Creeper™ era originalmente um porco moldado incorretamente.  
趣事：苦力怕最初是一头设计错误的猪。  
Ciekawostka. Creeper™ powstał w wyniku pomyłki – z początku miał być świnia.  
Perlička: Postava Creepera byla původně nesprávně namodelované prasátko.

Zaujímavosť: Postava Creepera bola pôvodne nesprávne vymodelované prasiatko.  
Érdekeség: A Creeper™ eredetileg egy hibásan modellezett malac volt.  
Цікавий факт. Спочатку Крепер був неправильно змодельованою свинцею.  
Interesant de știut: Creeper™ era inițial un porc modelat greșit.  
Забавен факт. Creeper™ първоначално е бил неправилно моделирано прасце.  
Interesants fakts. Creeper™ sākotnēji bija nepareizi modelēta cūka.  
Löbus fakt. The Creeper™ oli esialgu valesti modelleeritud siga.  
Jdomus faktas. Creeper™ buvo neteisingai sumodeliuota kiaulė.



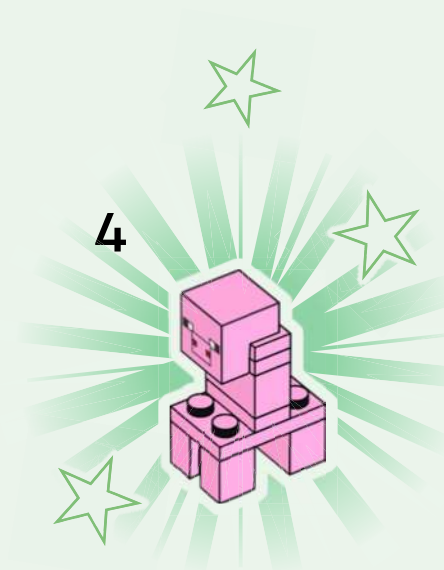
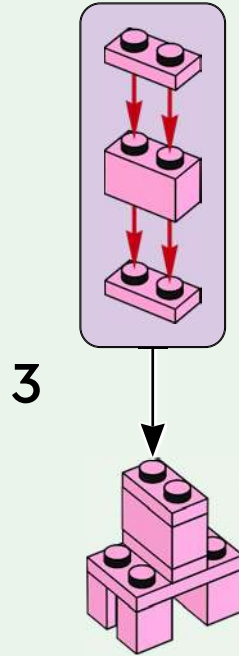
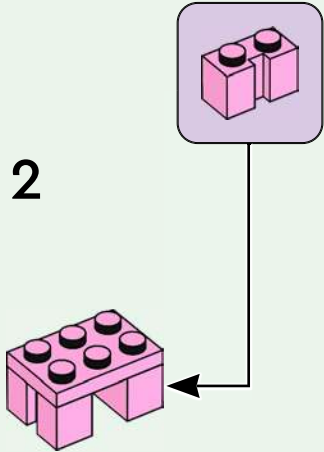
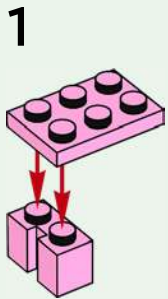
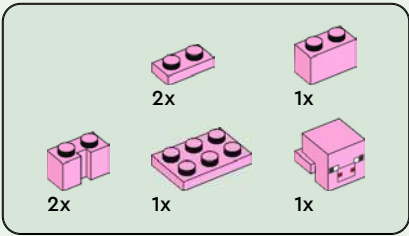

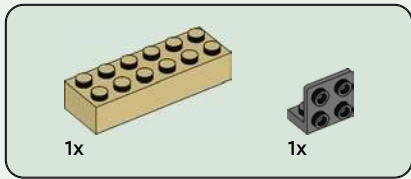

1

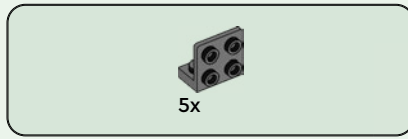
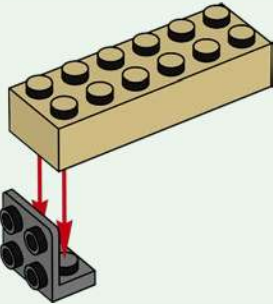

2

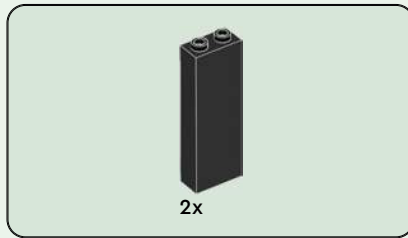
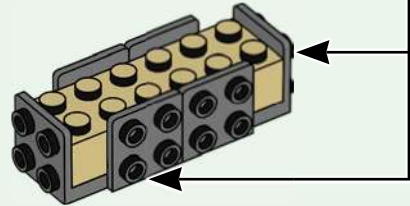
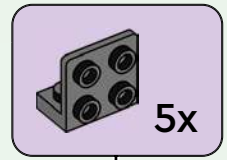

3

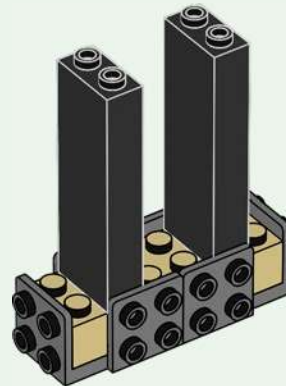

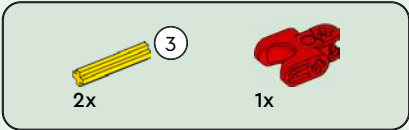
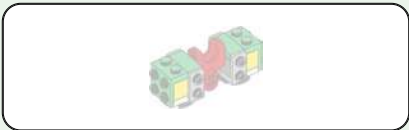

4

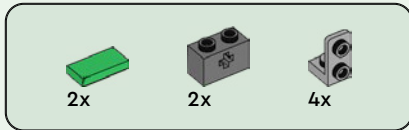
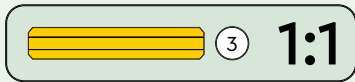
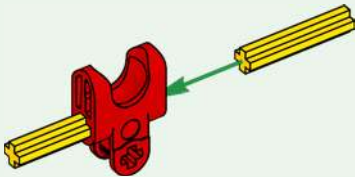

5

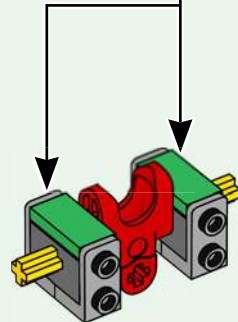
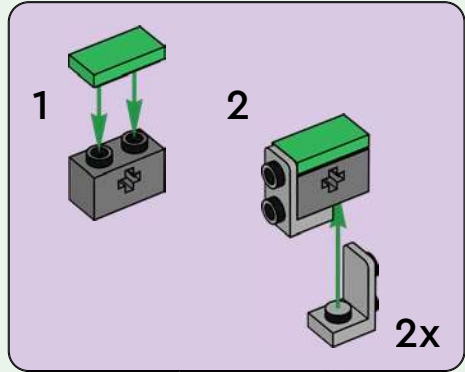

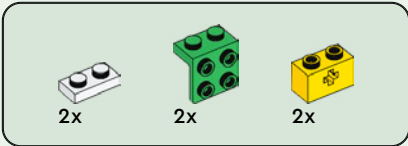

6

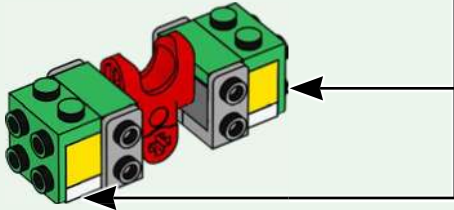
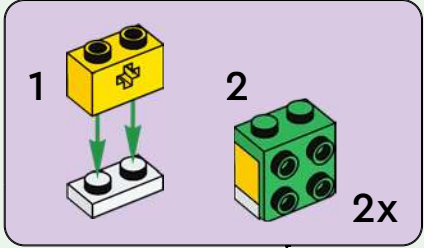

7

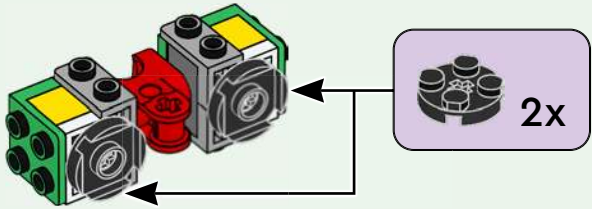

8

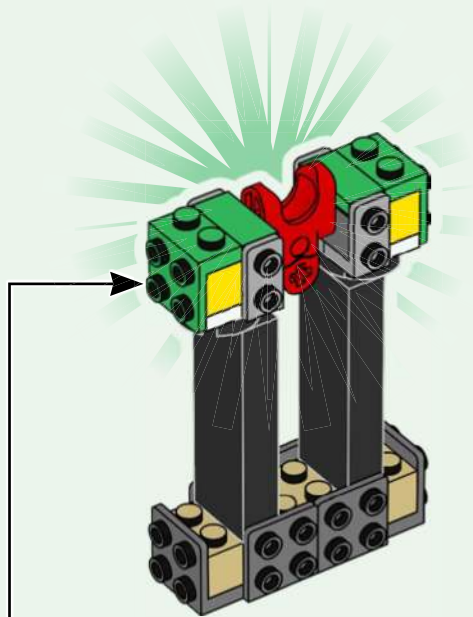

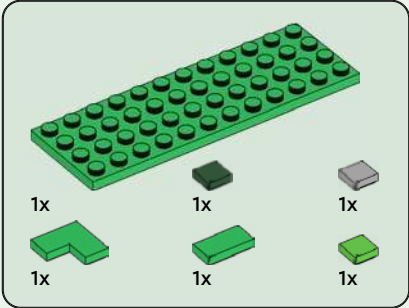
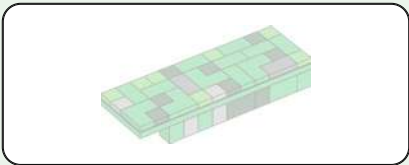

9

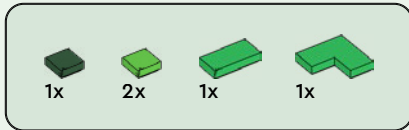
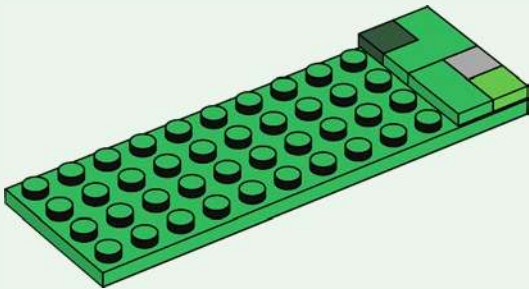

10

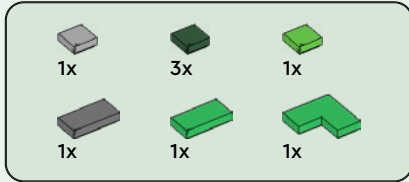
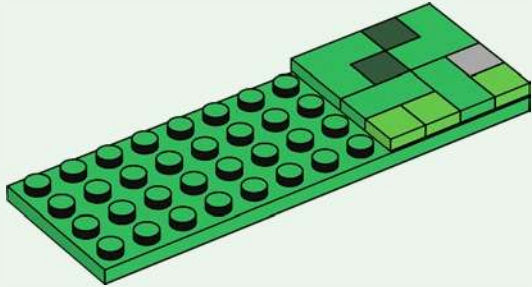

11

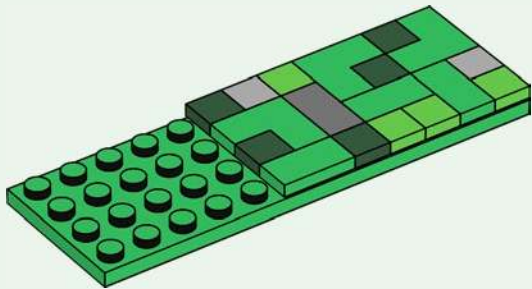

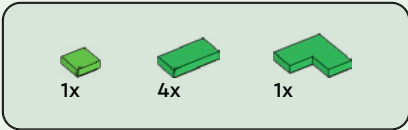

12

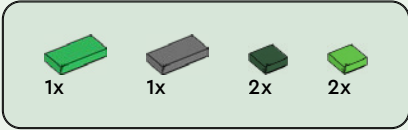
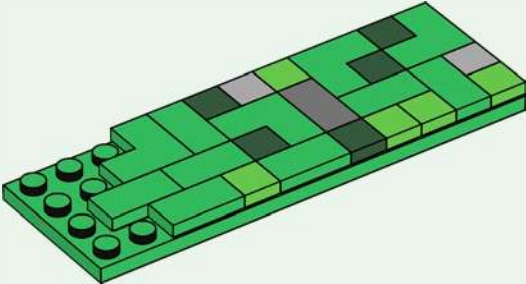

13

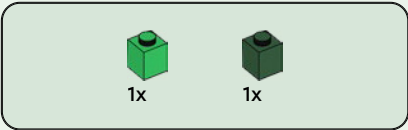
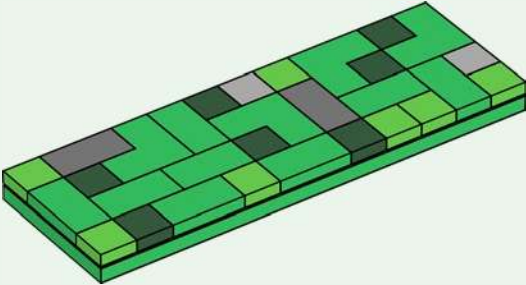

14

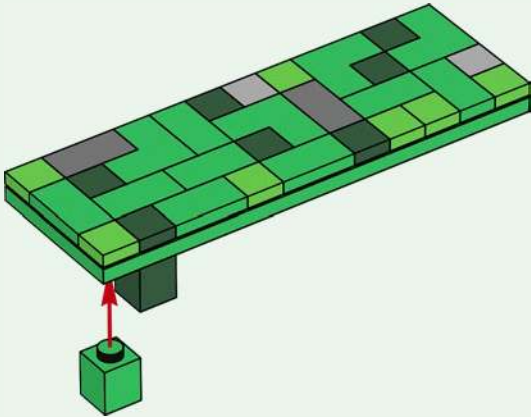

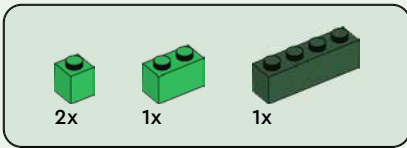

15

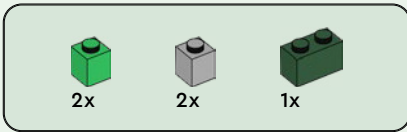
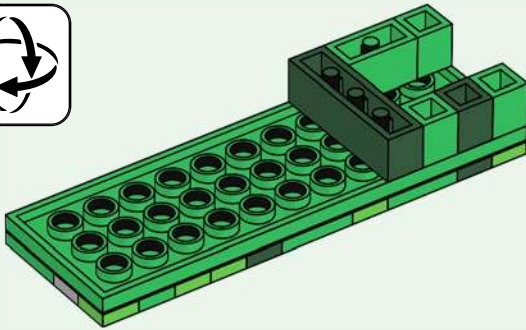

16

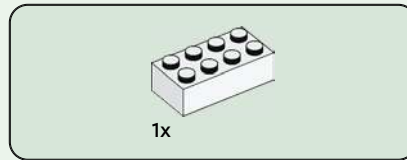
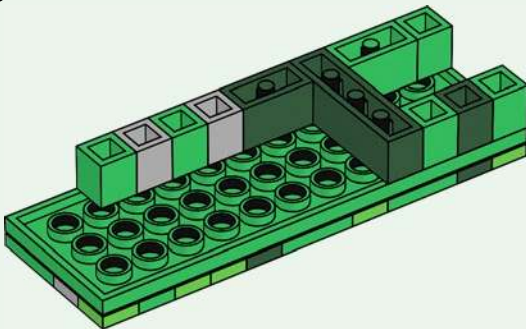

17

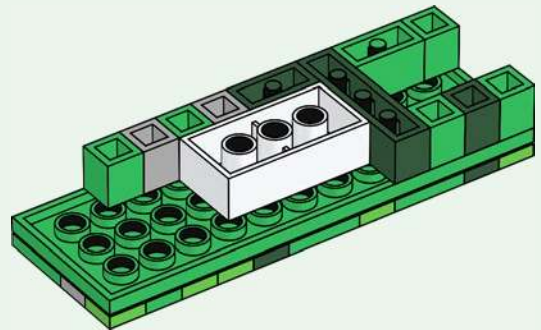

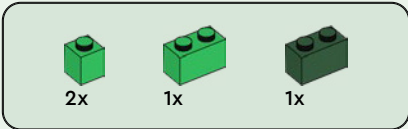

18

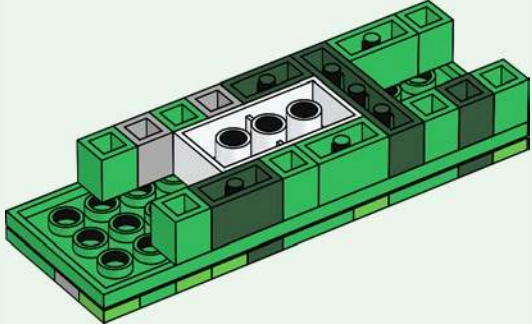

19

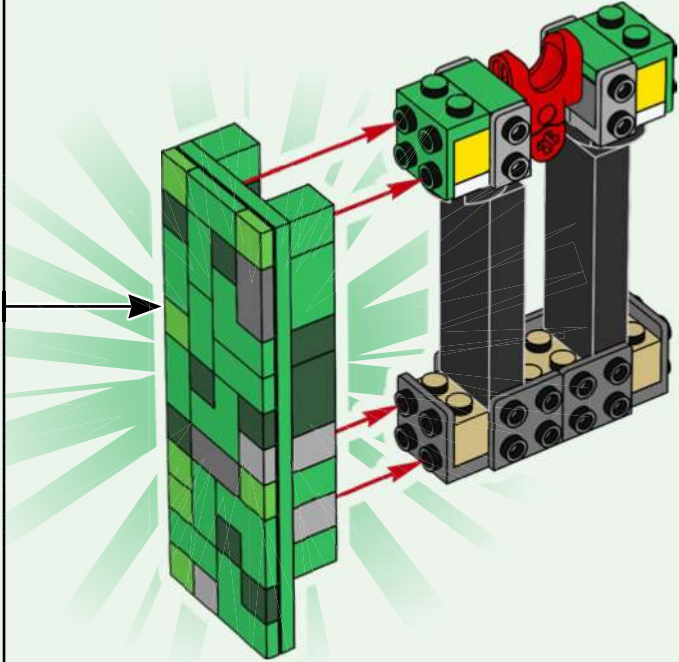



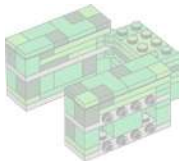

2x



1x

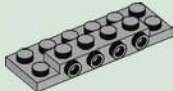

1x

20

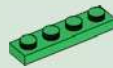
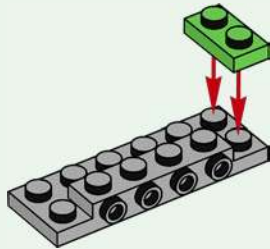

1x



1x

21

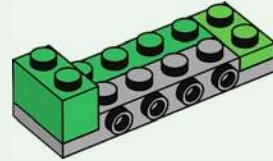

1x



1x

22

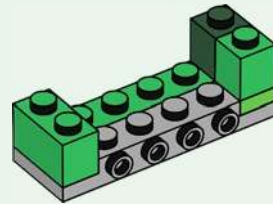

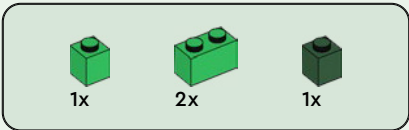

23

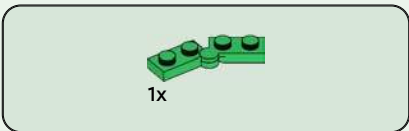
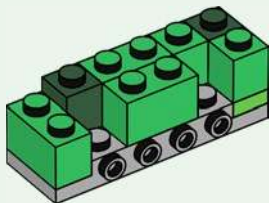

24

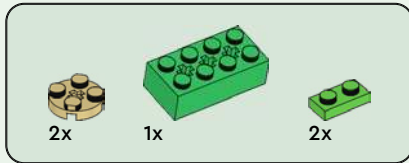
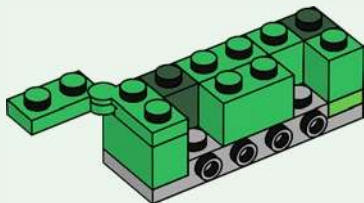

25

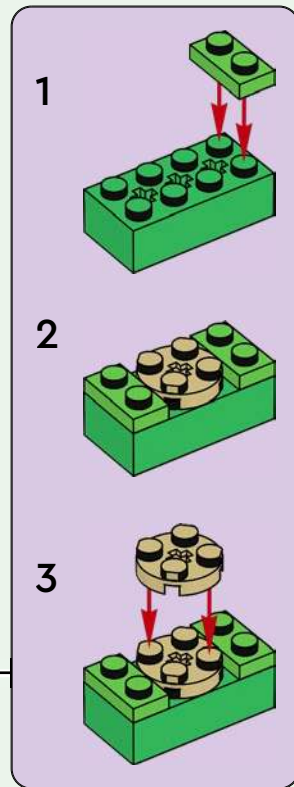
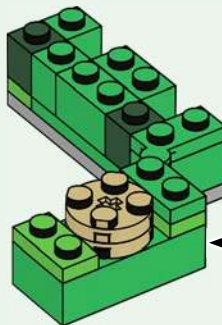

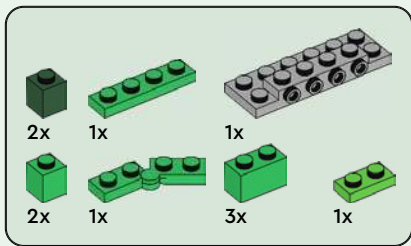

26

1

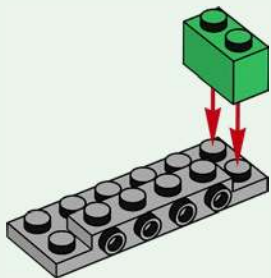

2

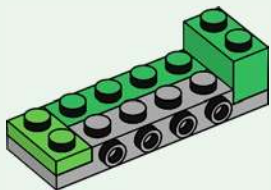

3

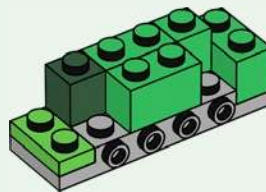

4

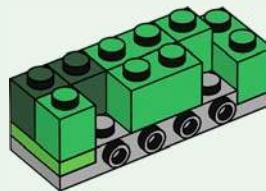

5

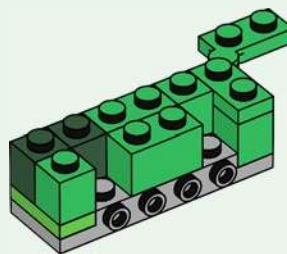



1x



2x

# 27

1

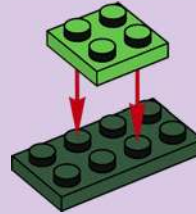

2

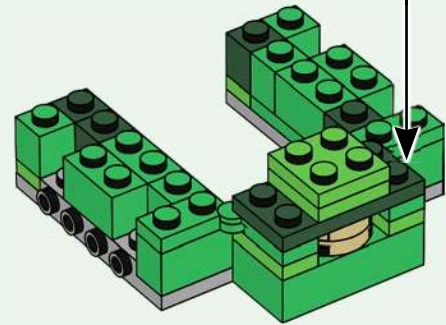
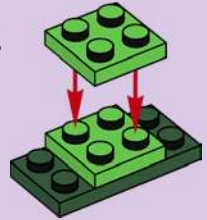



2x

28

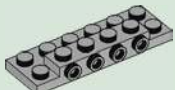
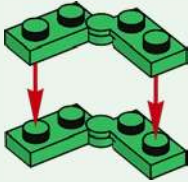

1x

29

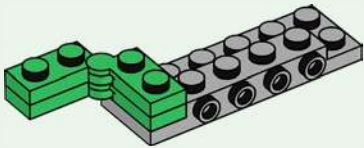

1x



1x

30

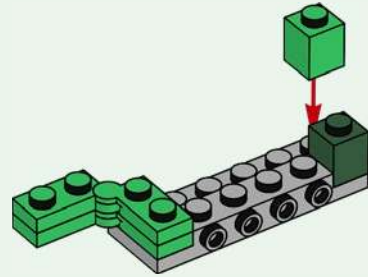

1x



1x

31

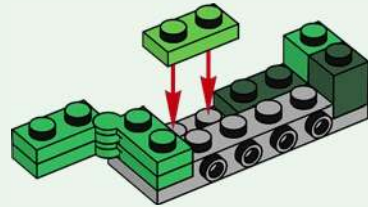



1x

32

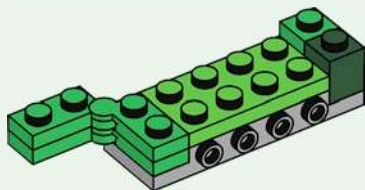

1x



1x

33

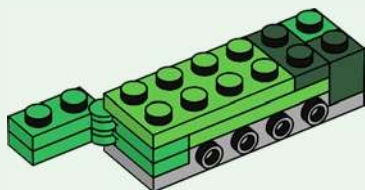

3x



2x



2x



1x

34

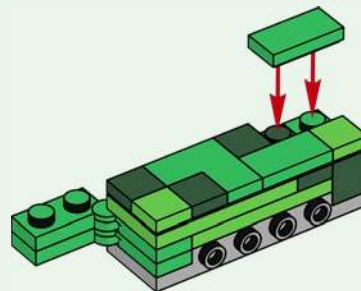

35

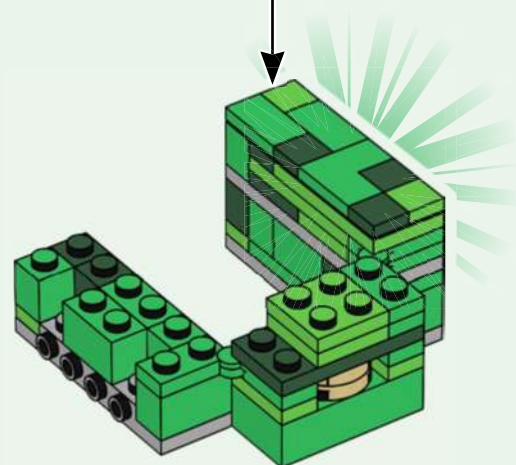

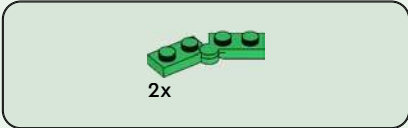
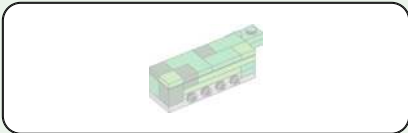

2x

36

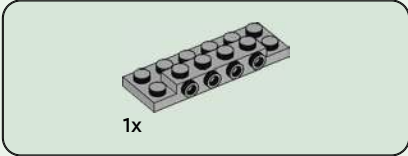
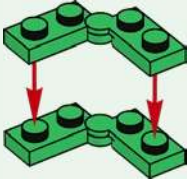

1x

37

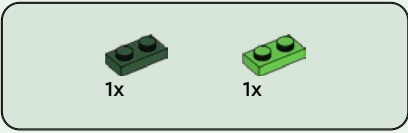
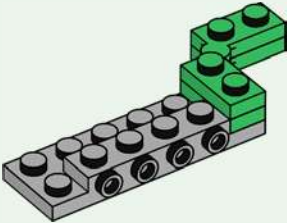

1x

1x

38

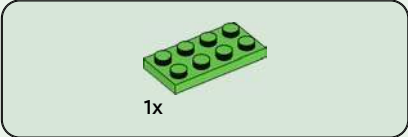
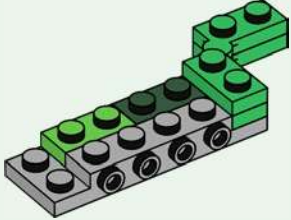

1x

39

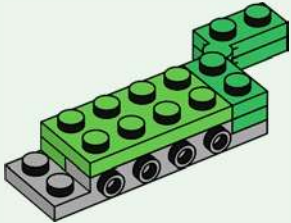

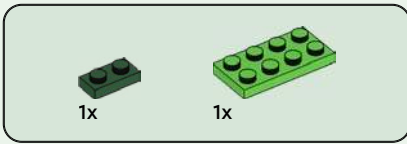

40

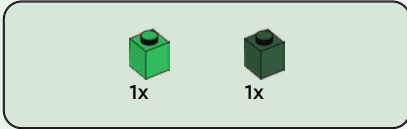
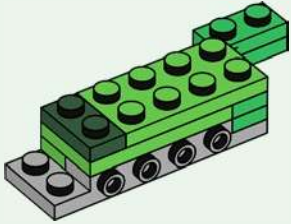

41

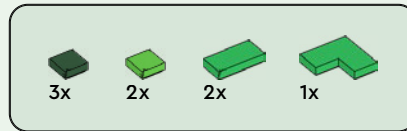
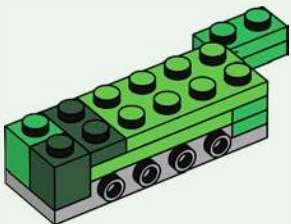

42

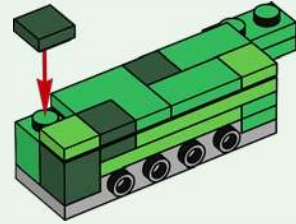

43

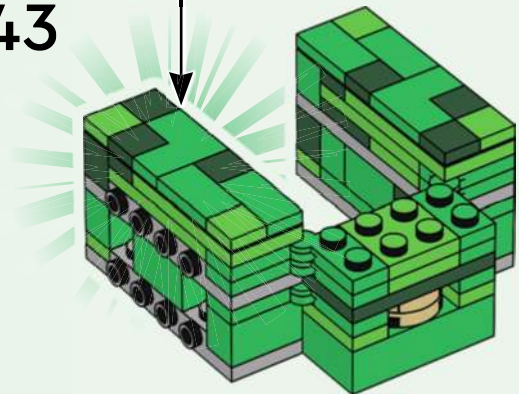

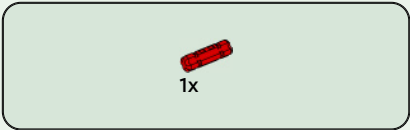

44

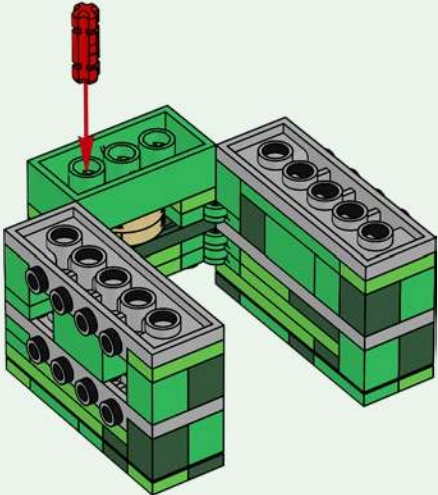

2x



45

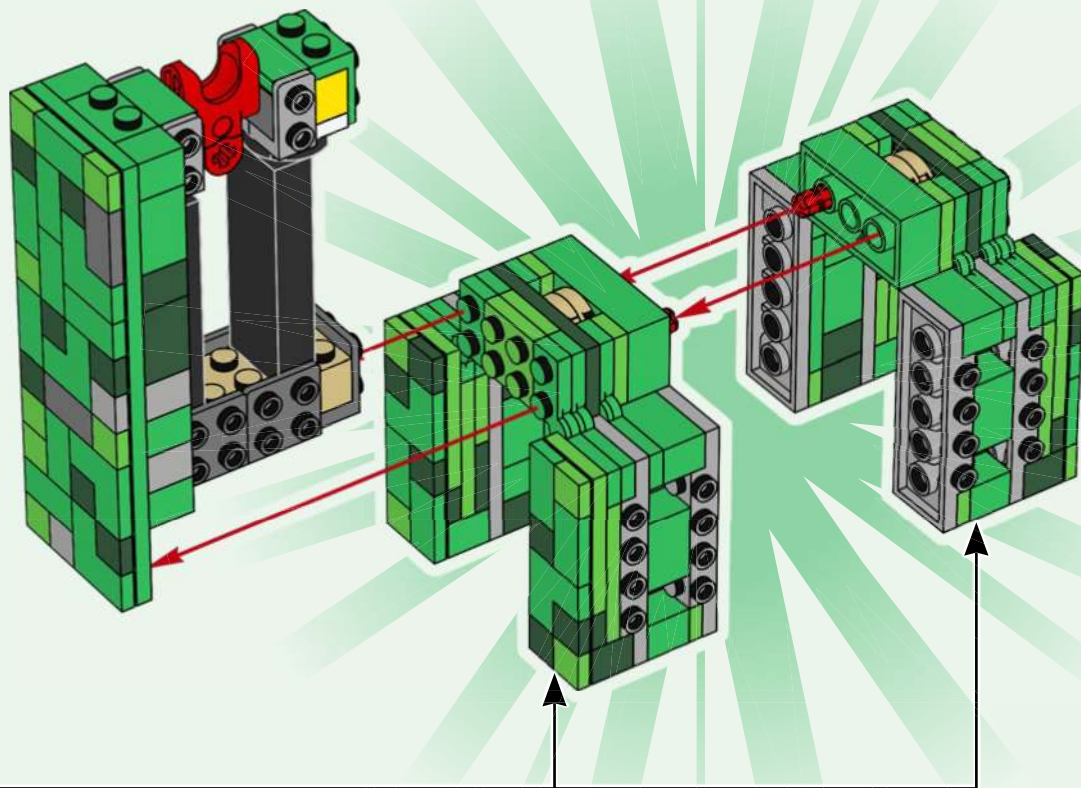



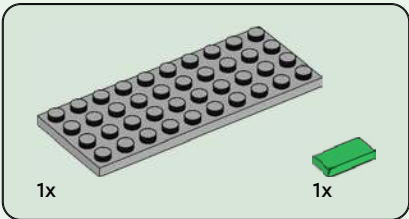
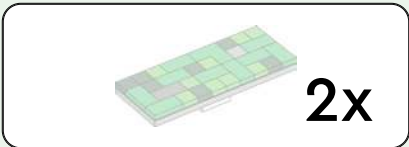

46

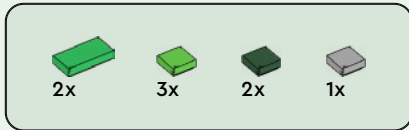
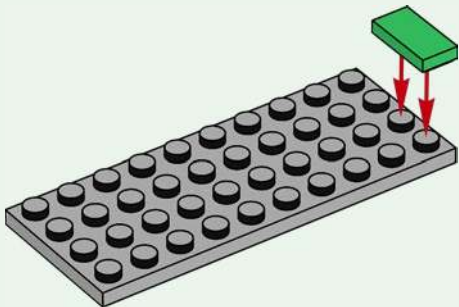

47

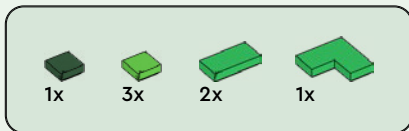
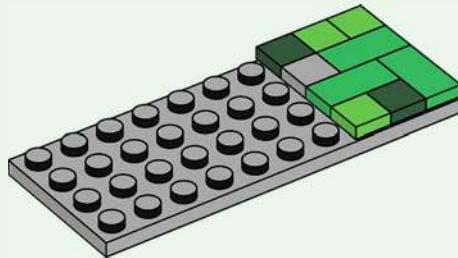

48

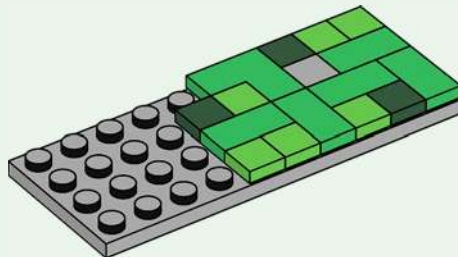

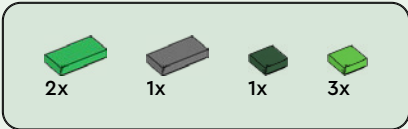

49

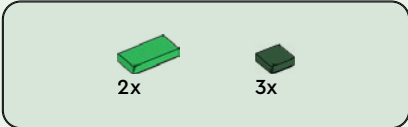
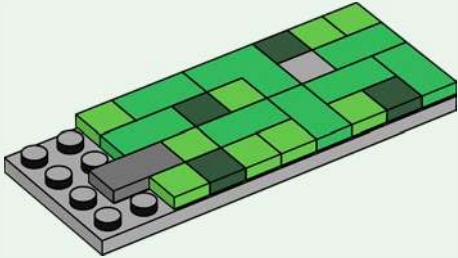

50

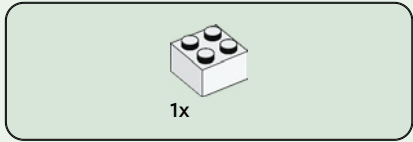
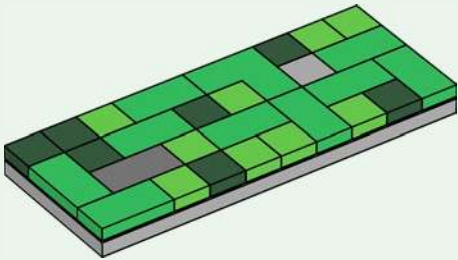

51

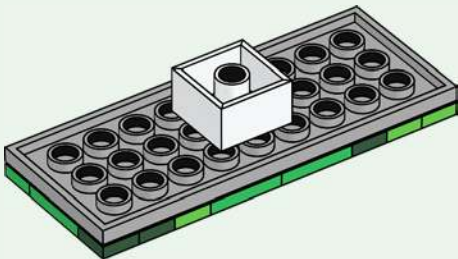

2x



52

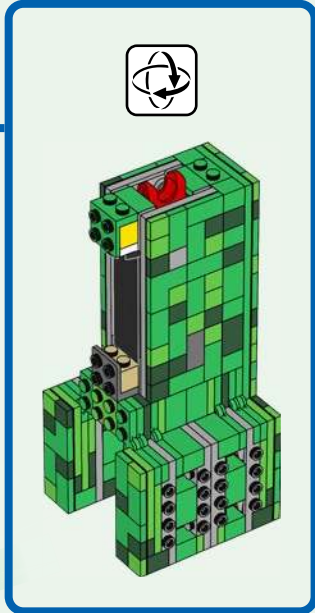
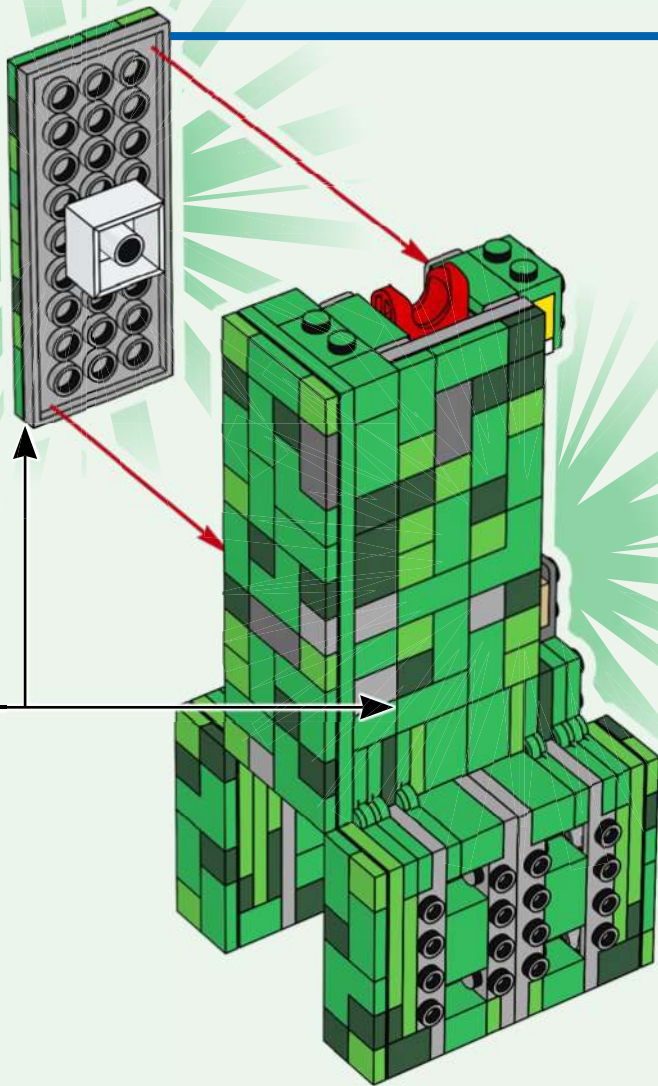

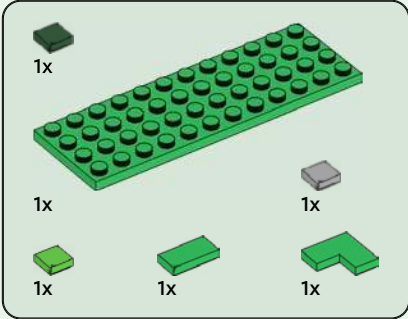
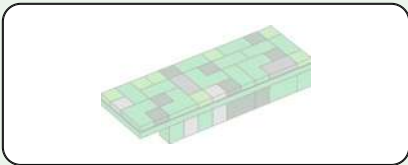

53

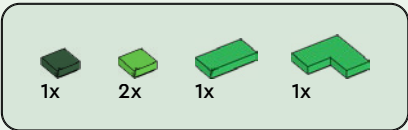
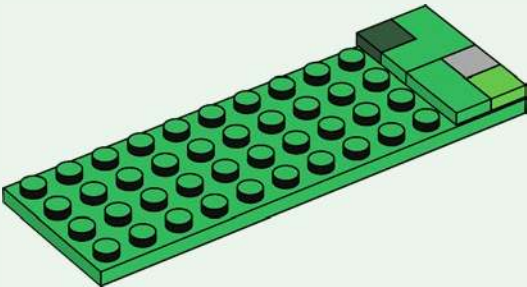

54

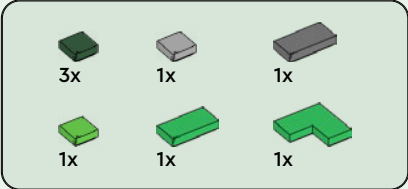
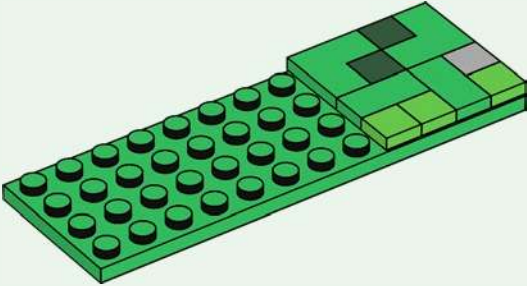

55

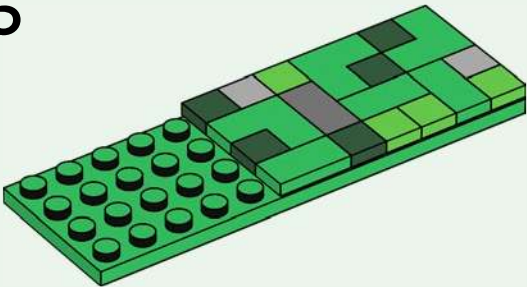

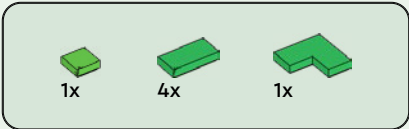

56

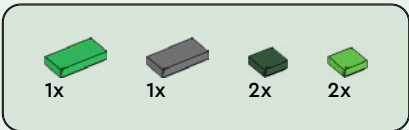
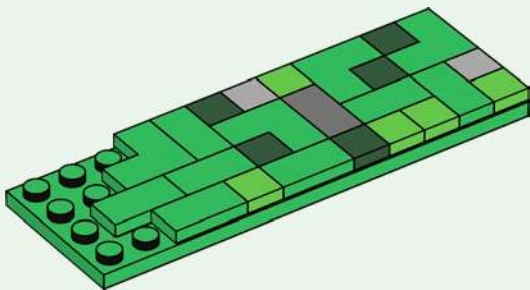

57

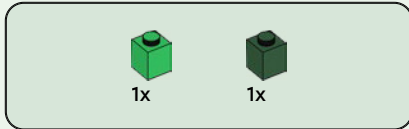
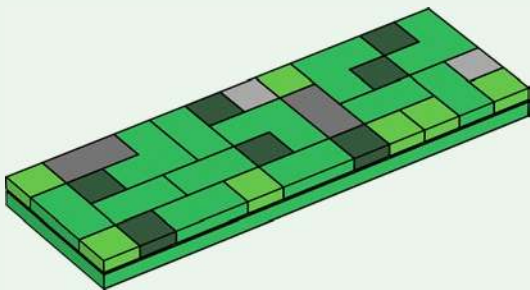

58

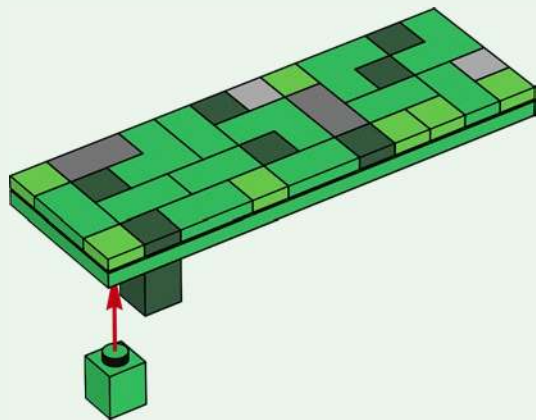

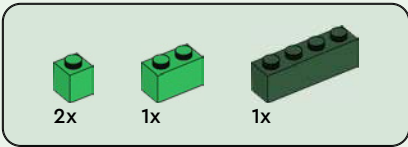

59

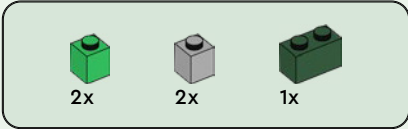
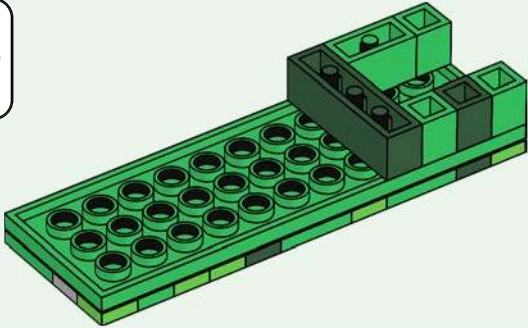

60

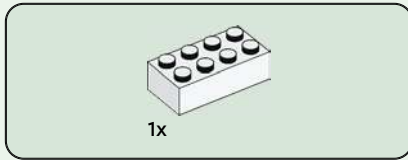
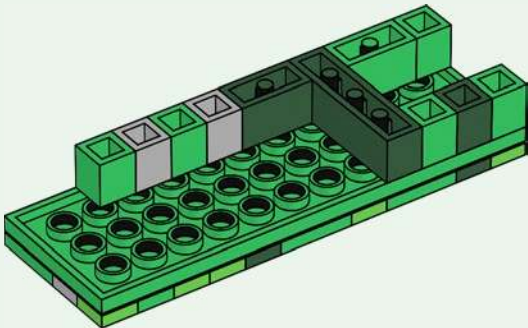

61

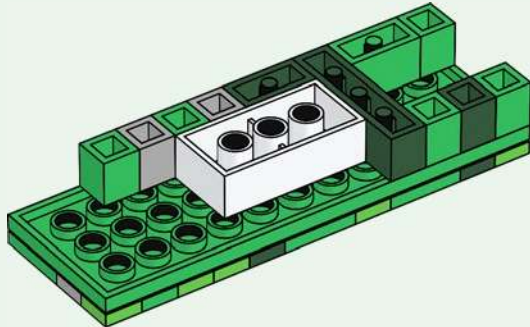

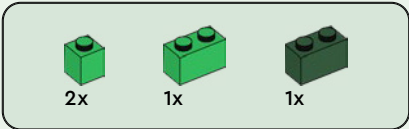

62

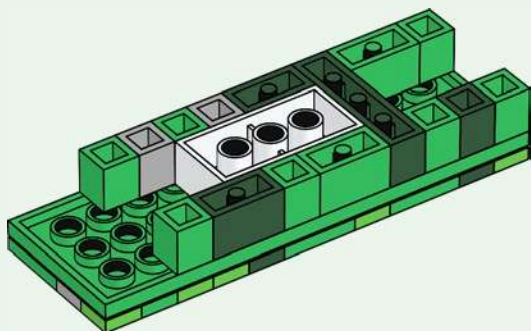

63

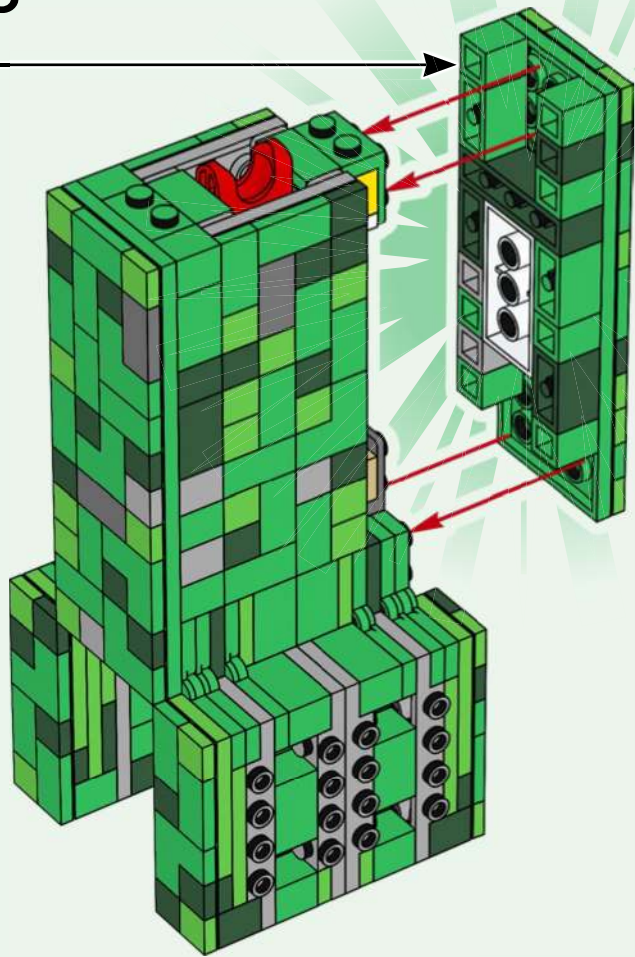





4x



1x



1x

64

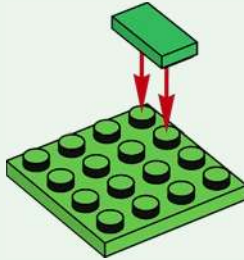

1x



1x



1x

65

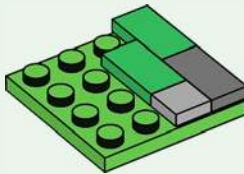

1x



1x



2x

66

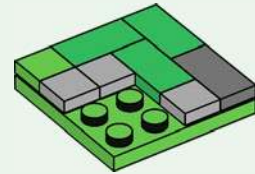

1x



1x

67

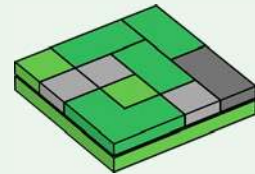

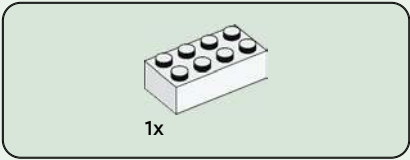

68

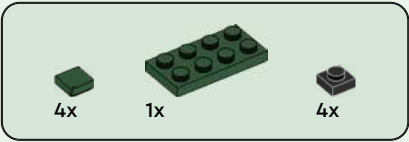
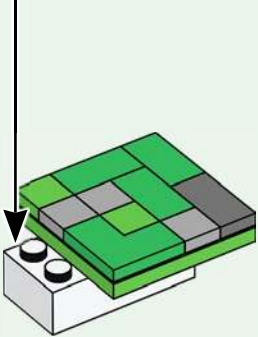
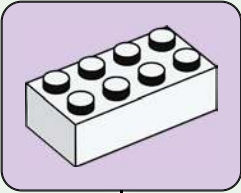

69

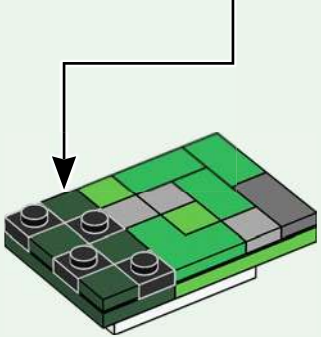
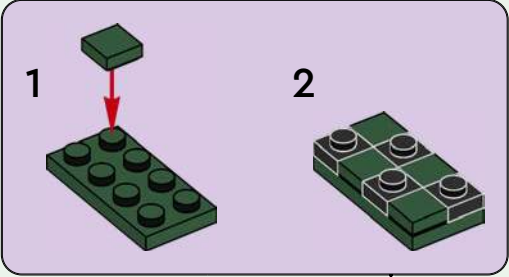

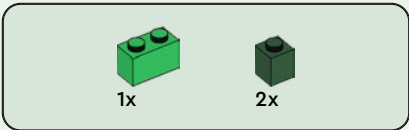

70

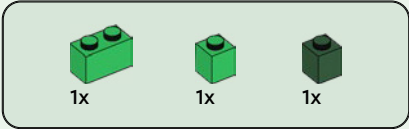
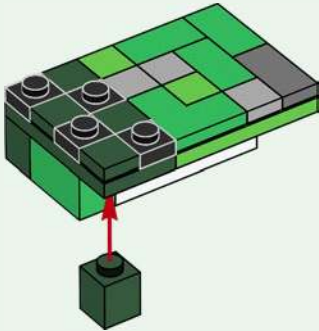

71

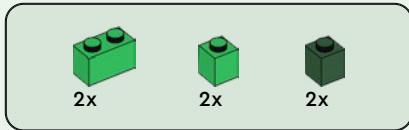
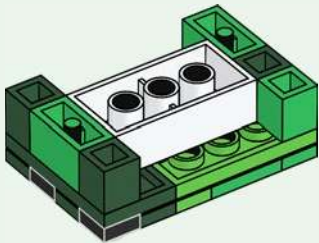

72

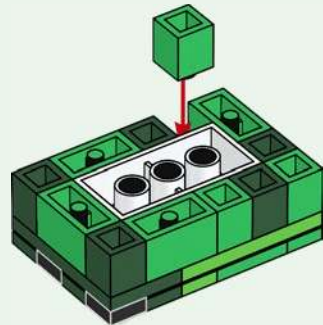

4x



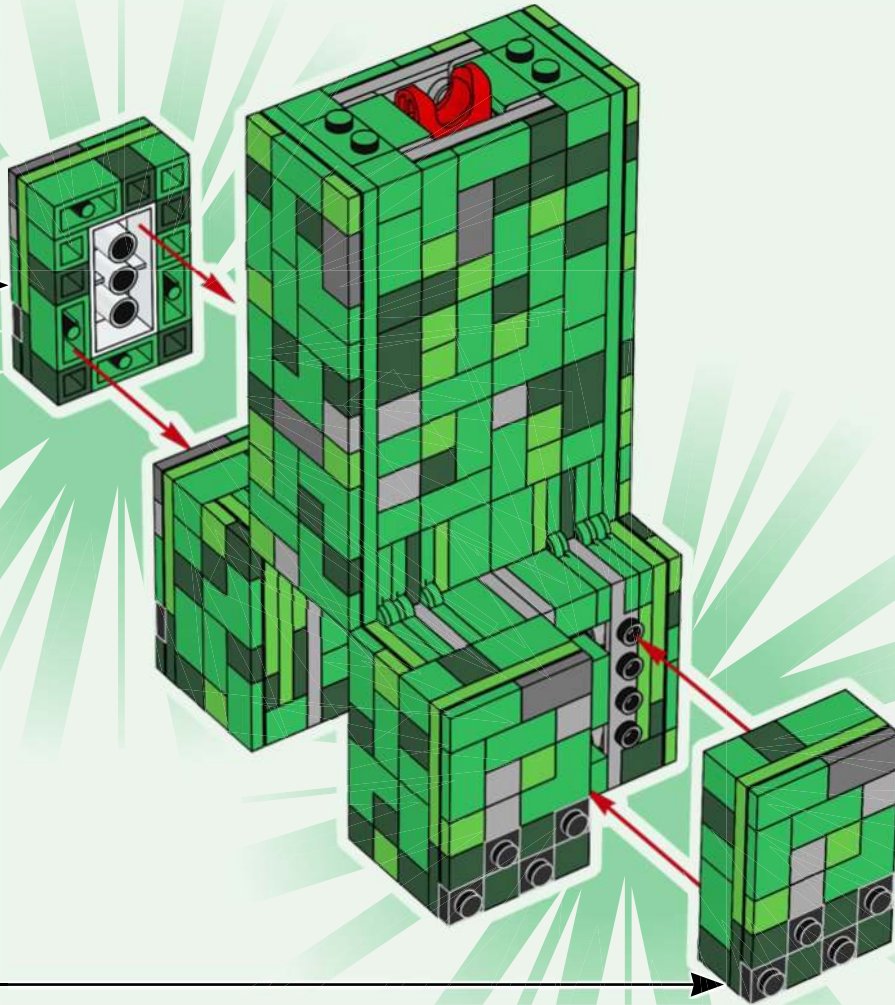



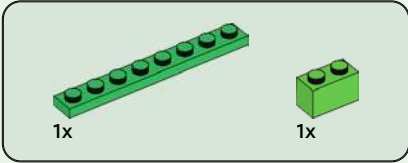
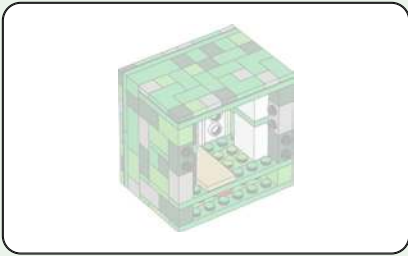

74

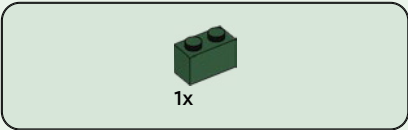
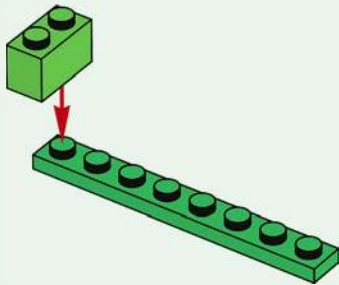

75

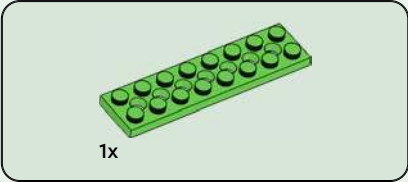
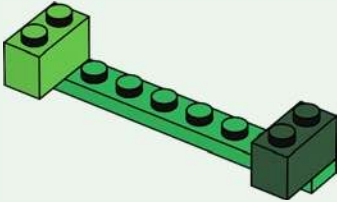

76

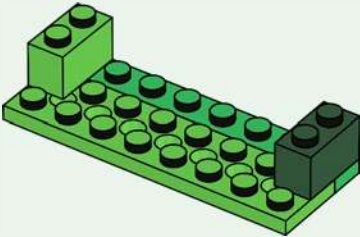

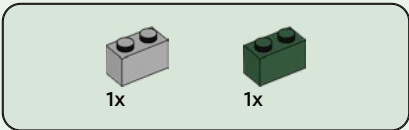

77

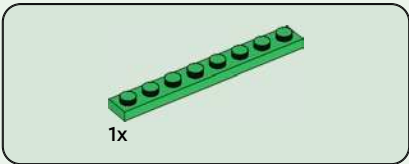
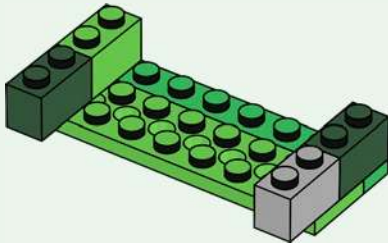

78

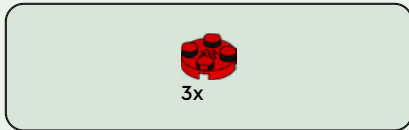
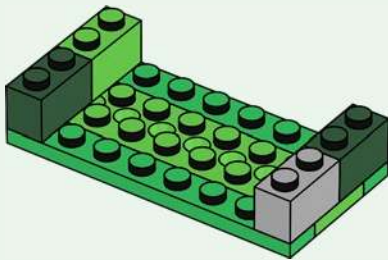

79

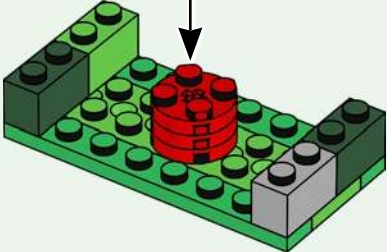
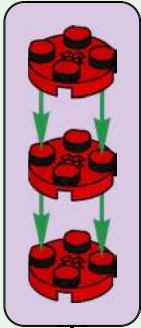

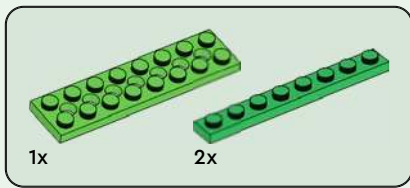

80

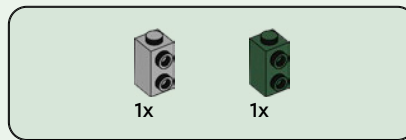
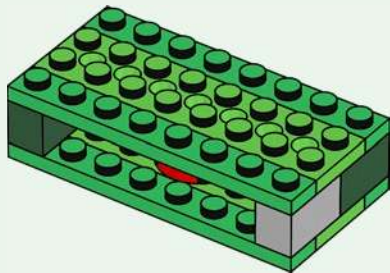

81

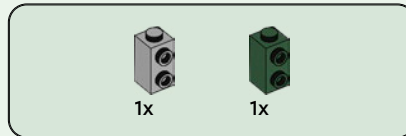
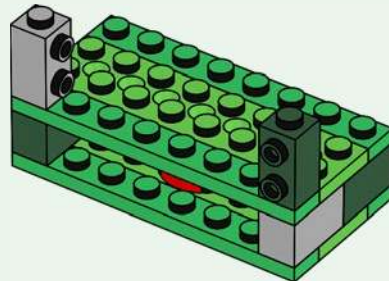

82

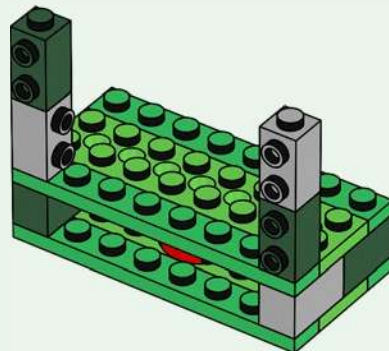

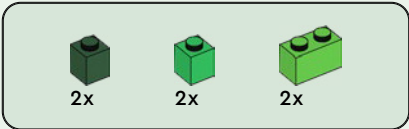

83

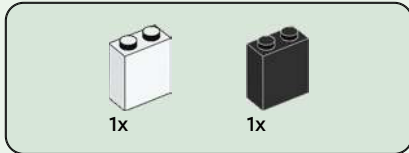
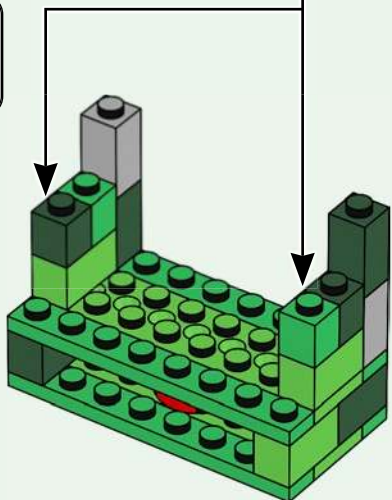
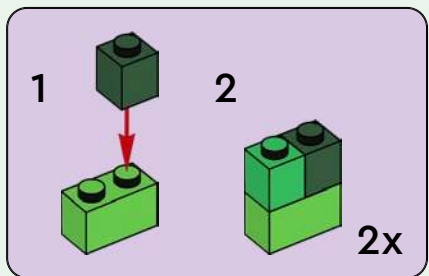

84

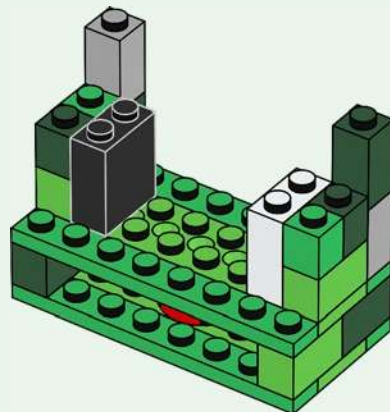



2x

85

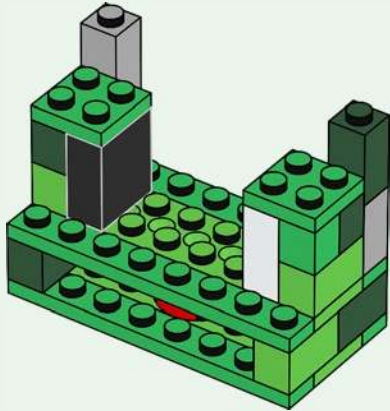

1x



1x

86

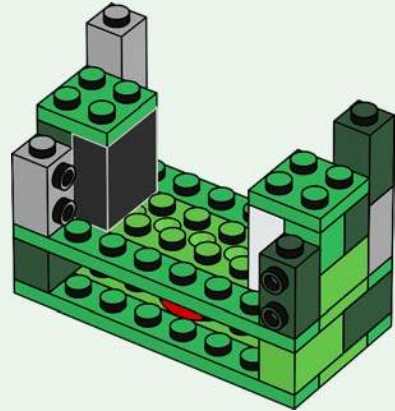

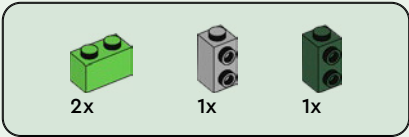

87

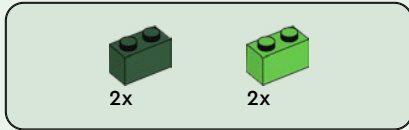
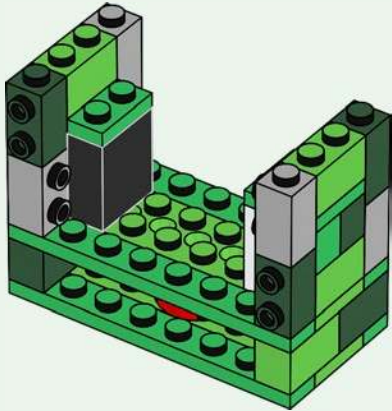

88

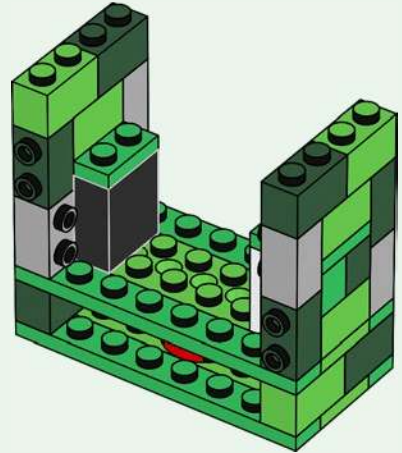

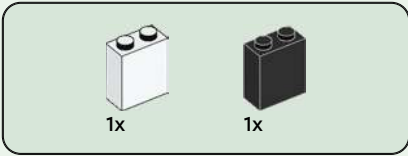

89

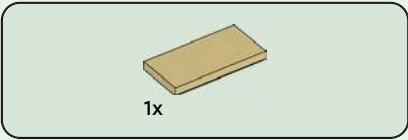
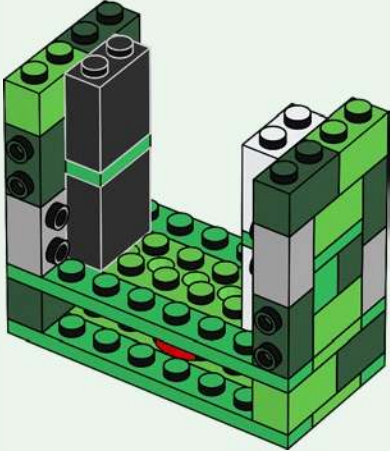

90

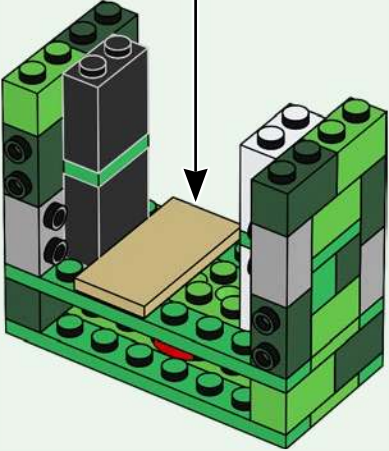
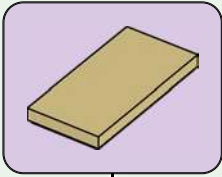

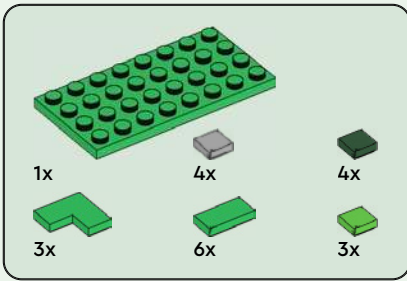

91

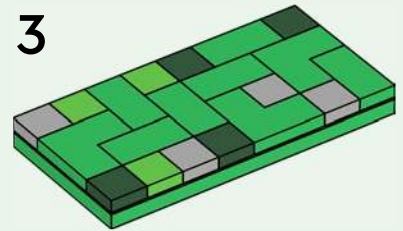
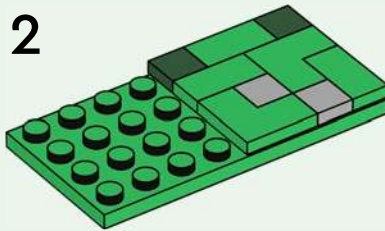
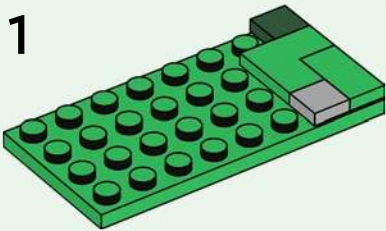

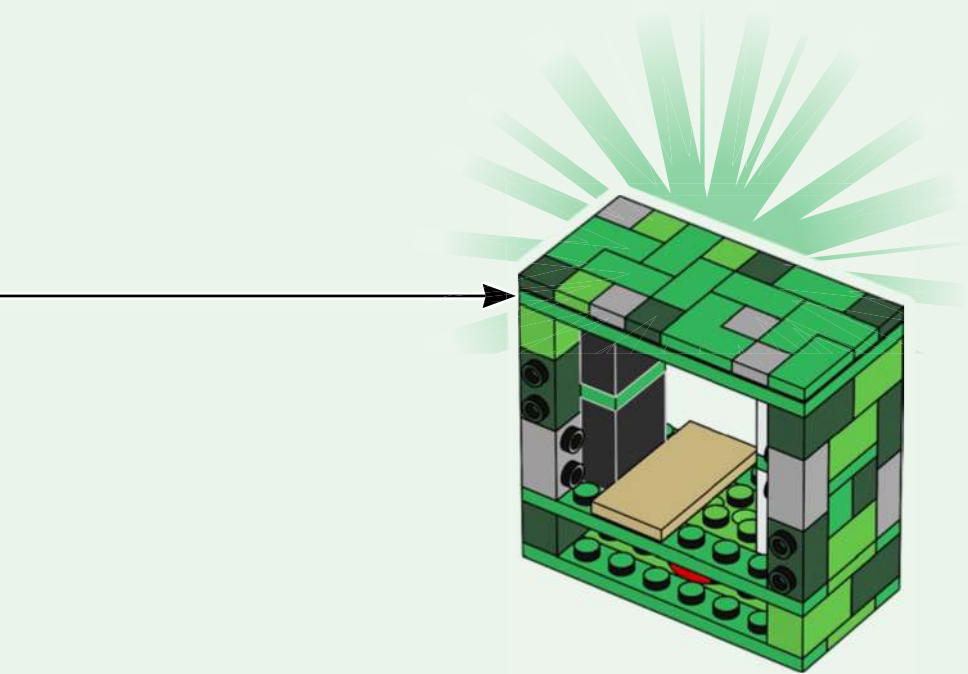

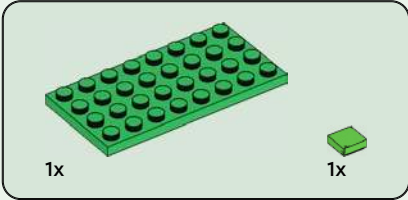
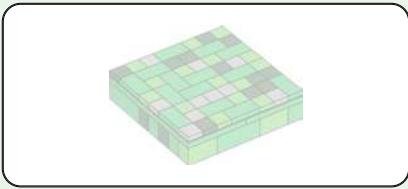

92

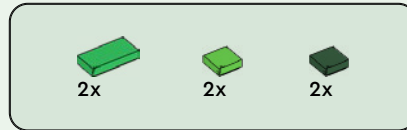
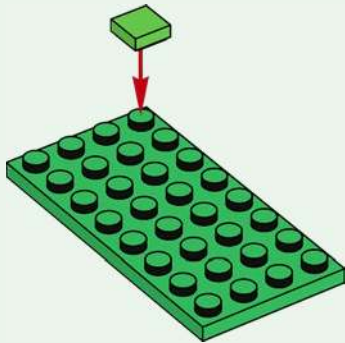

93

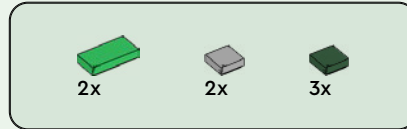
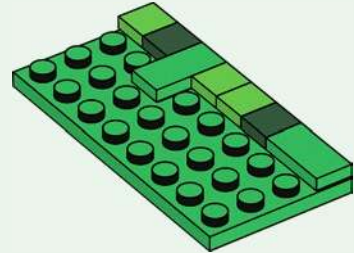

94

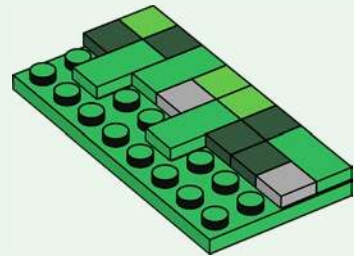



2x



4x

# 95

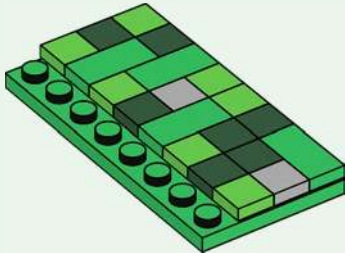

3x



2x



1x



2x

# 96

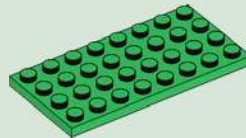
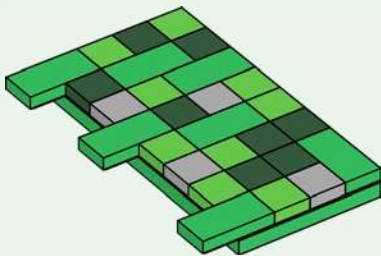

1x

# 97

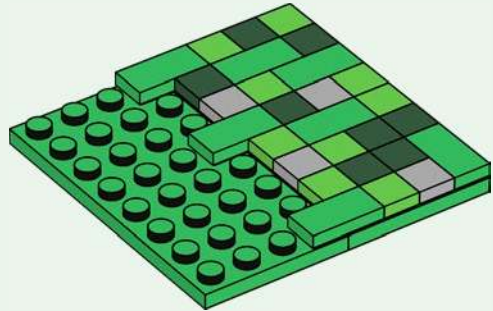

2x



1x



1x



1x

# 98

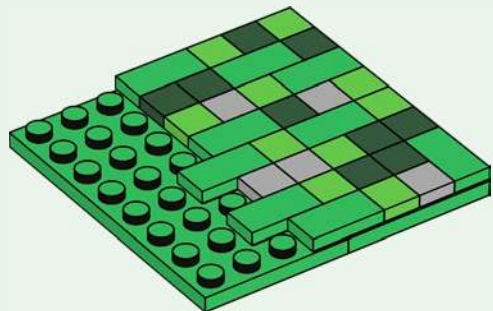

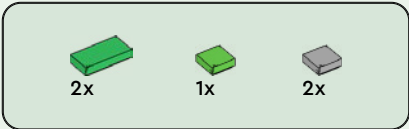

99

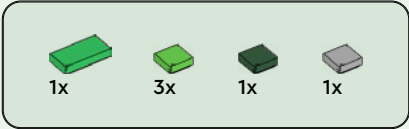
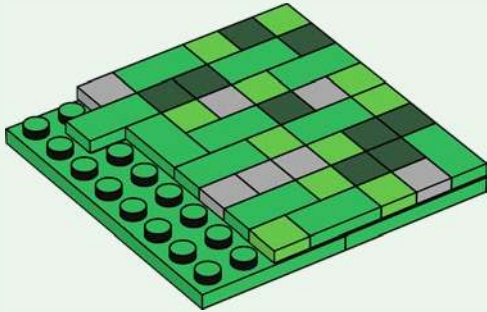

100

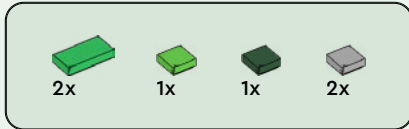
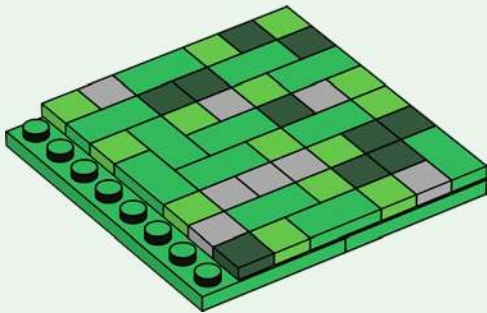

101

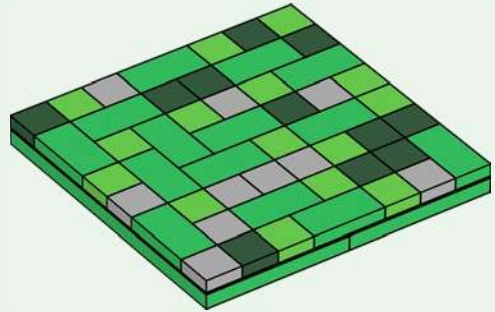

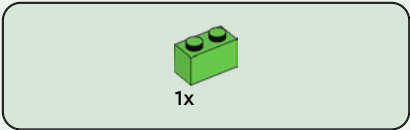

102

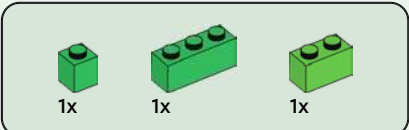
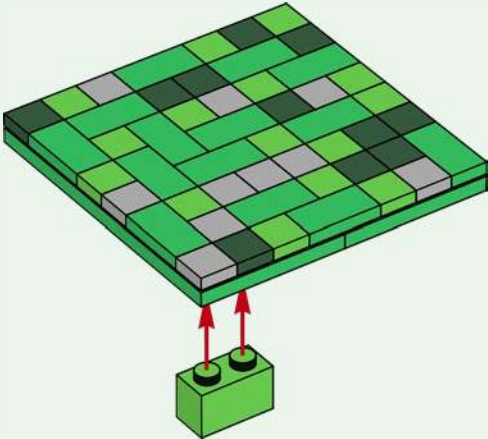

103

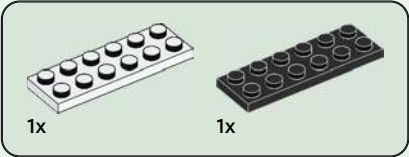
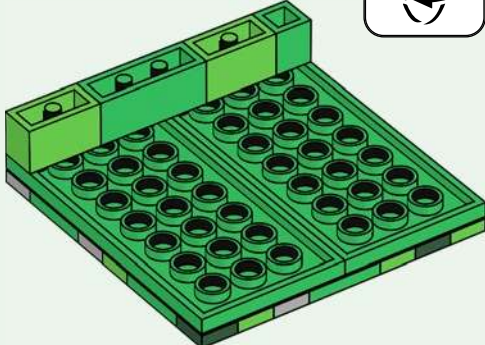

104

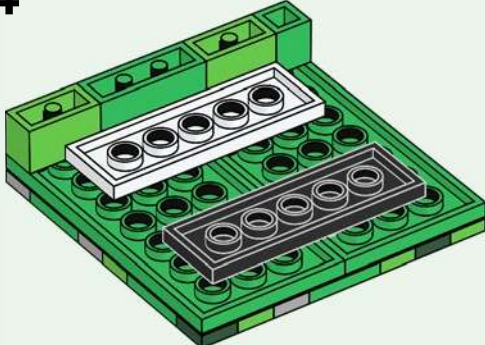

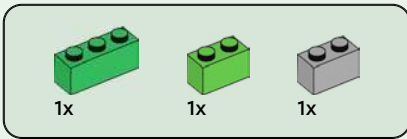

105

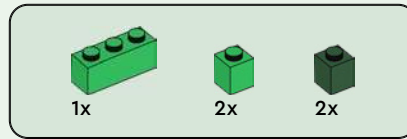
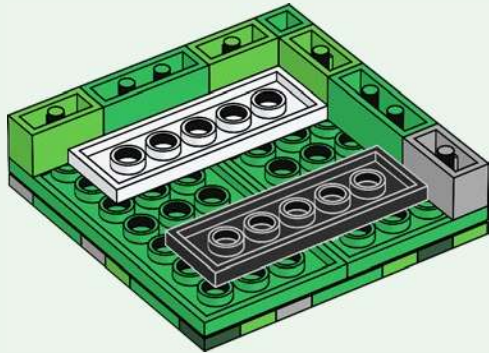

106

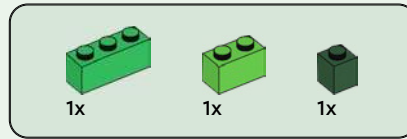
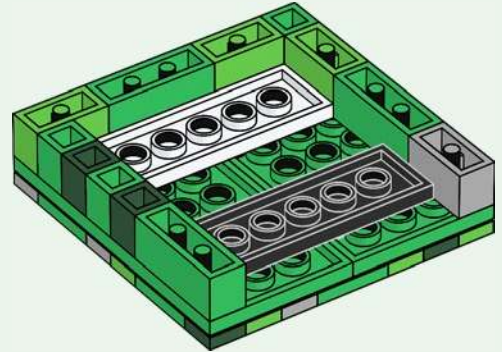

107

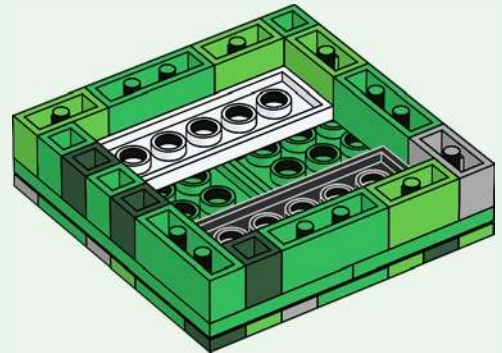

108

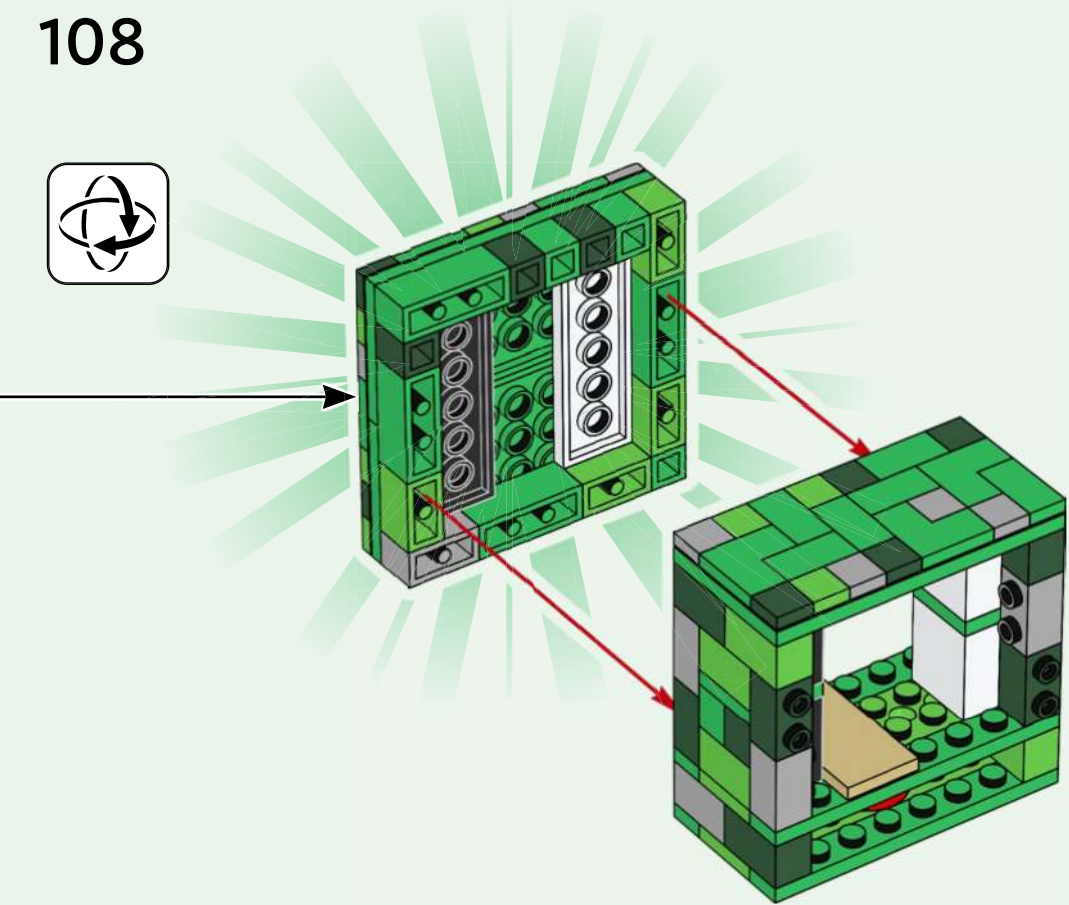

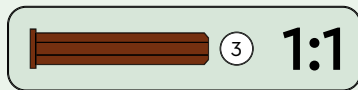

109

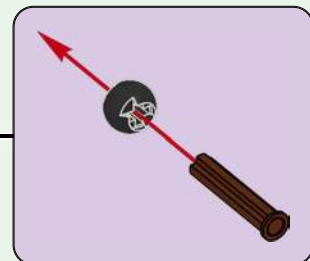
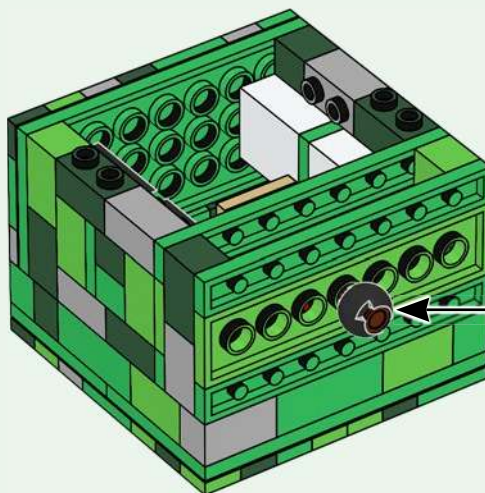

110

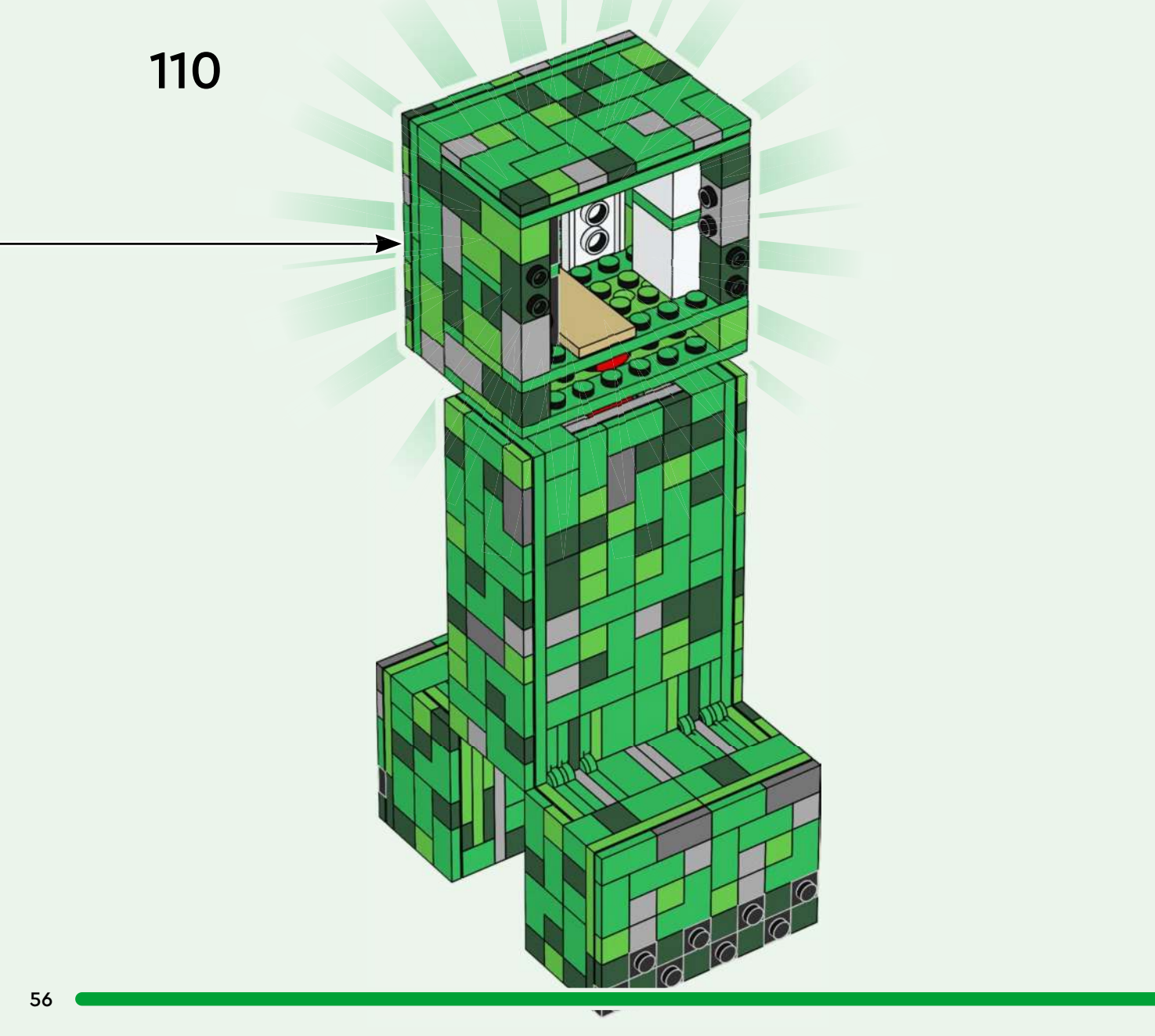

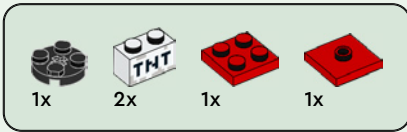

111

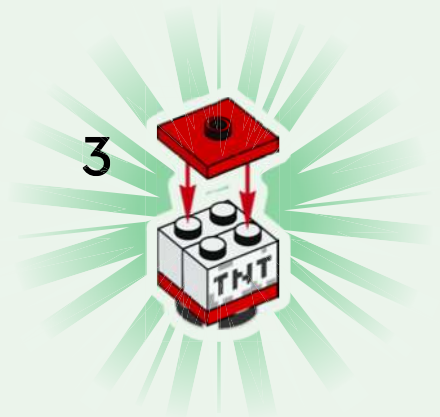
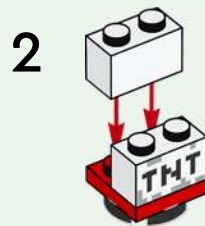
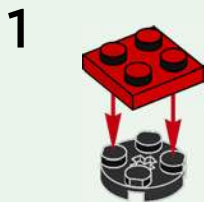

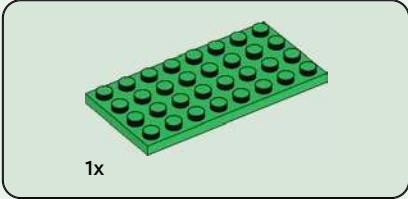
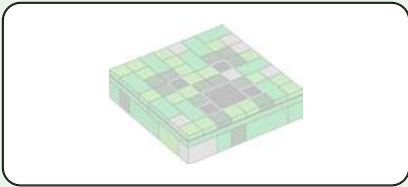

112

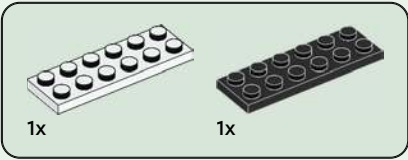
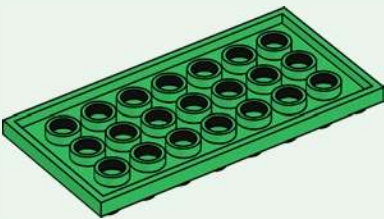

113

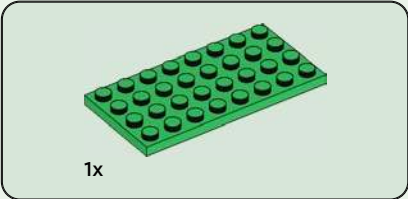
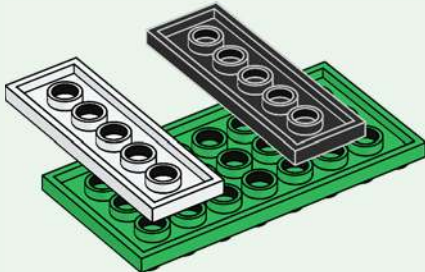

114

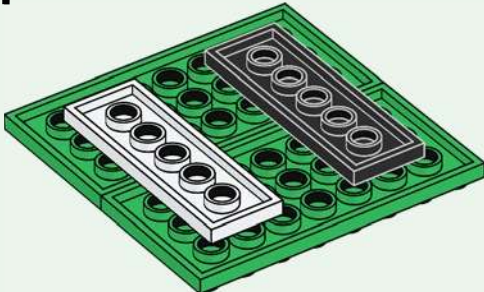

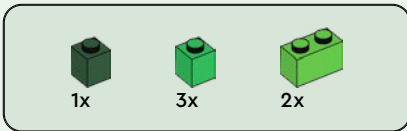

115

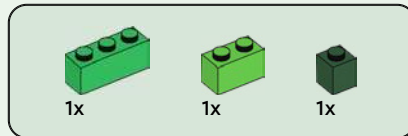
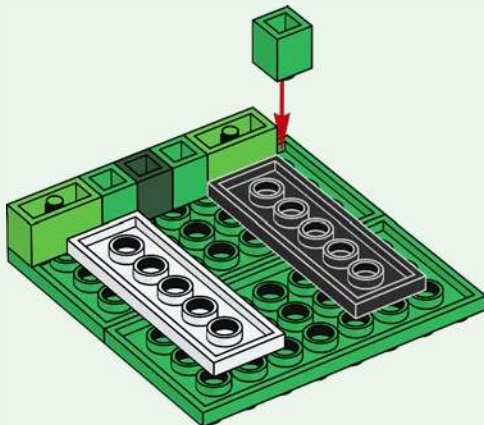

116

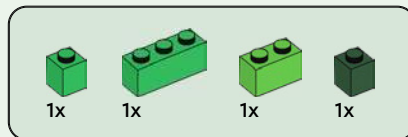
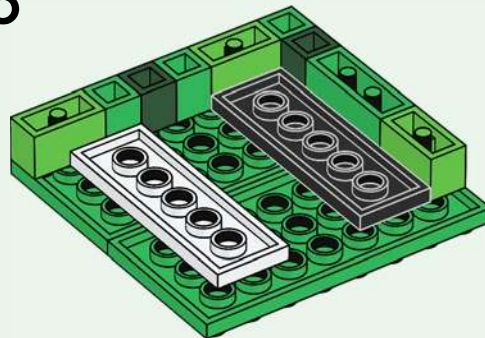

117

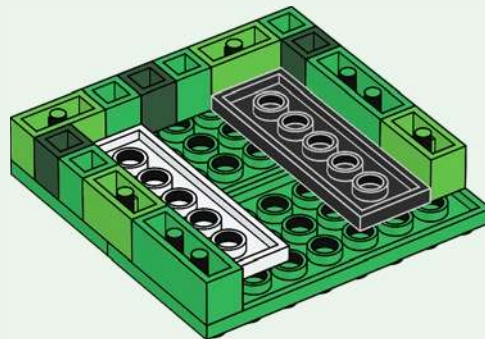

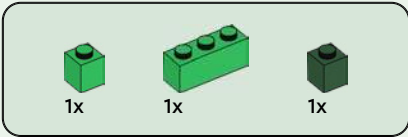

118

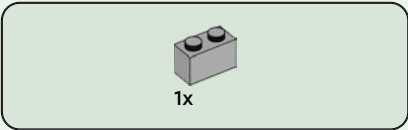
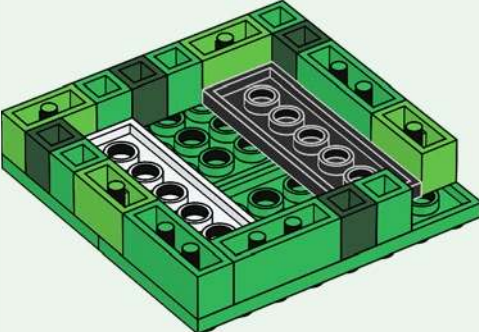

119

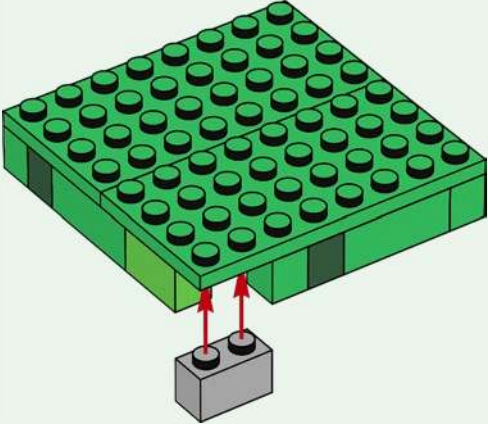

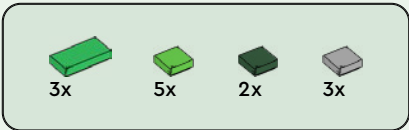

120

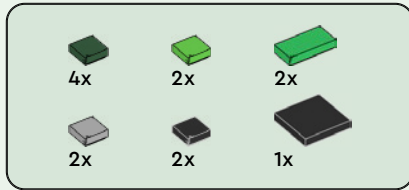
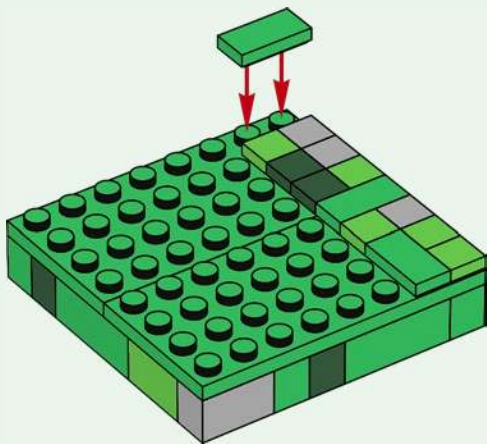

121

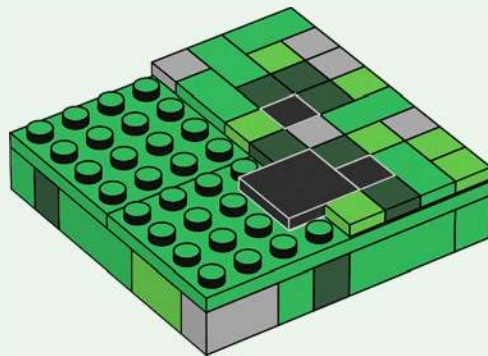

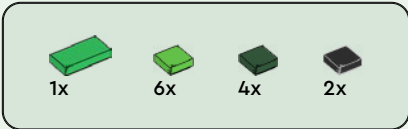

122

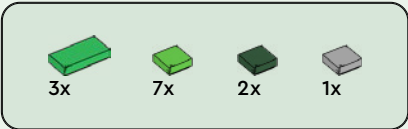
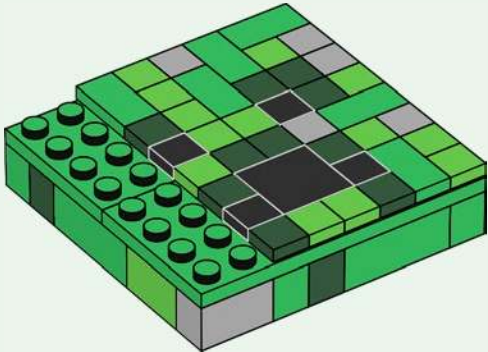

123

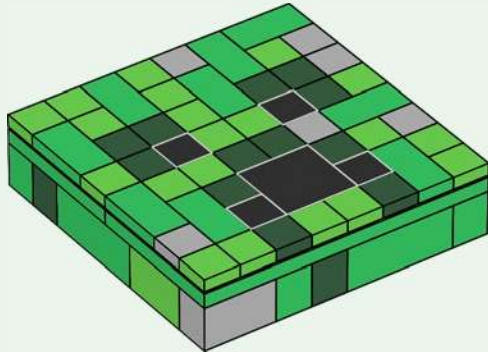

124

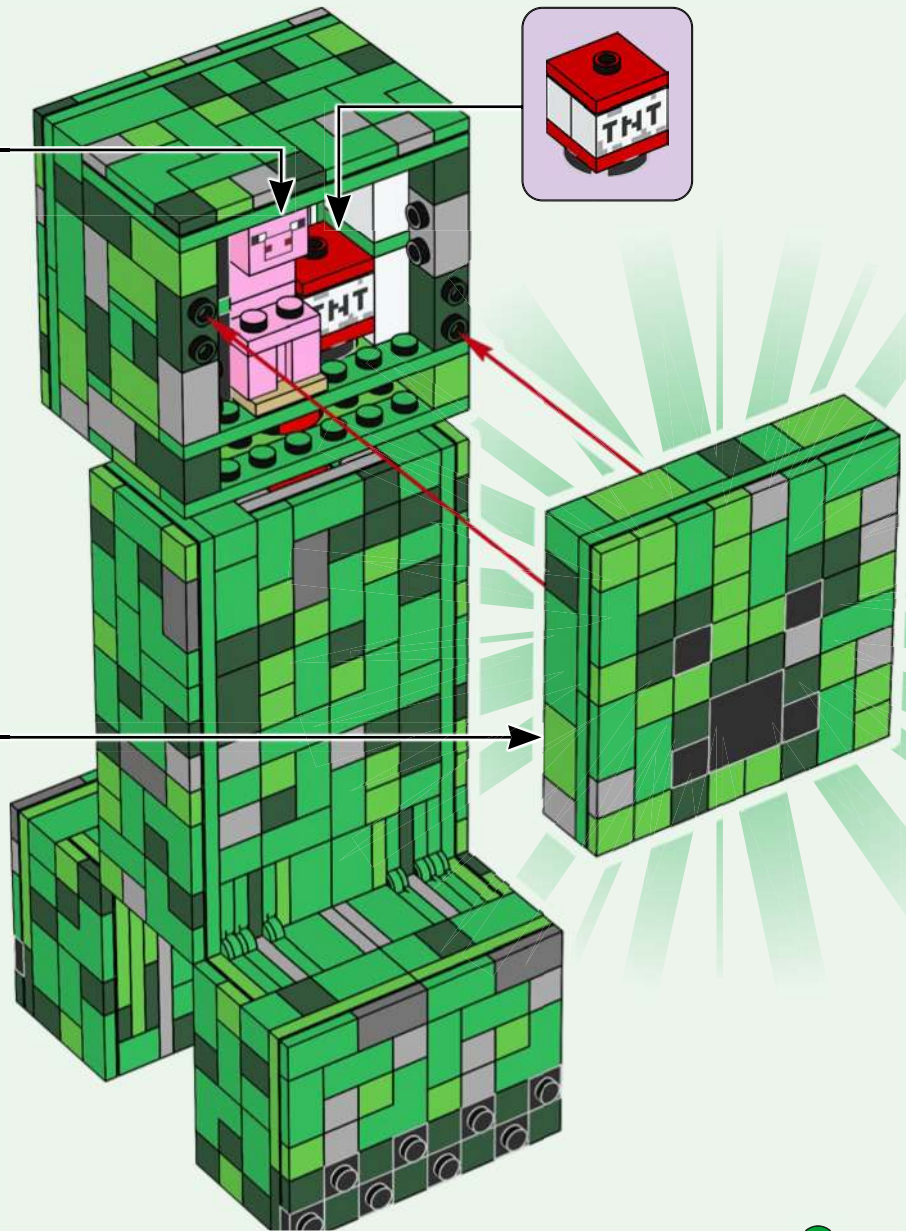
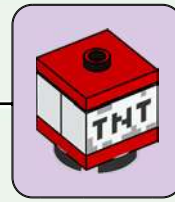
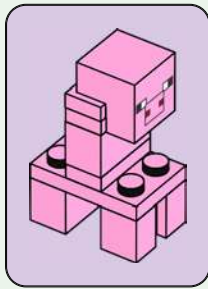

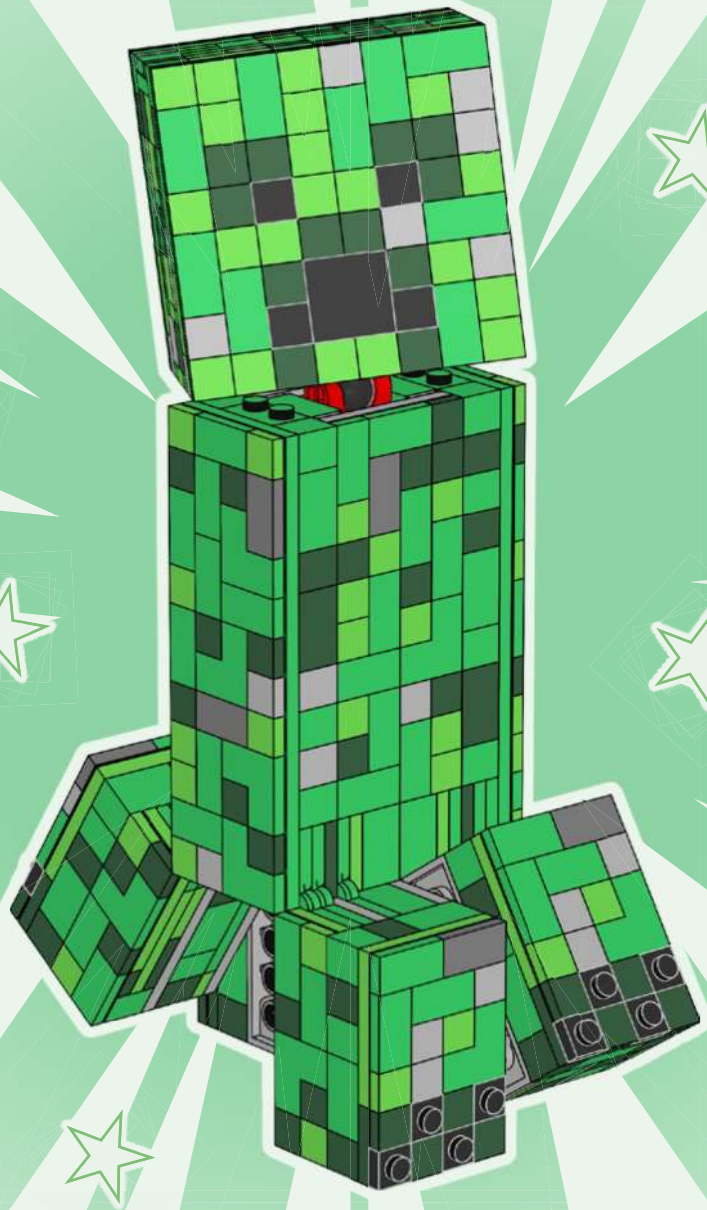



# MINECRAFT

21277



21274



21276



21279



21275



21278



2x  
6097028

2x  
4113261

2x  
300301

6x  
300101

2x  
302301

2x  
379501

1x  
4181134

1x  
6122047

4x  
4140562

1x  
6464974

1x  
302221

1x  
6126048

3x  
403221

2x  
4142865

2x  
6206240

2x  
6130007

2x  
4618852

2x  
245426

1x  
4286267

4x  
307026

16x  
302426

1x  
306826

2x  
379526

3x  
403226

48x  
300528

32x  
4107736

2x  
6117971

7x  
4109679

2x  
6244915

85x  
306928

2x  
302228

21x  
6374049

4x  
371028

4x  
346028

5x  
4277361

2x  
4279059

15x  
4647553

86x  
6172375

12x  
6343326

4x  
6357612

12x  
6416506

8x  
6141590

4x  
4617799

2x  
6138494

43x  
4521915

8x  
4245570

2x  
4245571

4x  
6252591

83x  
6055171

8x  
6013102

6x  
4586057

38x  
4211415

4x  
4211389

3x  
4211388

4x  
6225242

4x  
6345639

8x  
6430550

2x  
4211402

1x  
4517993

2x  
6291009

2x  
4654128

1x  
6102999

1x  
6529878

2x  
6178919

10x  
4211052

6x  
6308045

1x  
6135494



 [LEGO.com/service](https://www.LEGO.com/service)

YOU COULD  
**WIN**

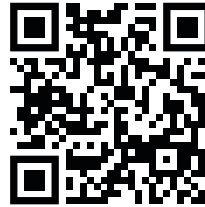

Scan this QR code or go to  
**LEGO.COM/PRODUCTFEEDBACK** and give us  
your short feedback about this LEGO® set  
for a chance to win a cool LEGO prize.

Terms and Conditions apply\*



**EN: YOU COULD WIN.** Terms and Conditions apply\* **DE: Du könntest GEWINNEN.** Es gelten die Teilnahmebedingungen\* **FR: Tu pourrais GAGNER.** Des conditions s'appliquent\* **IT: Potresti VINCERE tu.** Termini e condizioni sono applicabili\* **ES: Puedes GANAR.** Aplican términos y condiciones\* **PT: PODERÁ GANHAR.** Aplicam-se Termos e Condições\* **ZH: 轻松获奖. 条款和条件适用\*** **PL: Szansa na WYGRANĄ.** Obowiązuje regulamin\* **CS: Máte šanci VYHRÁT.** Platí všeobecné smluvní podmínky\* **SK: Máte šancu VYHRAŤ.** Platia všeobecné zmluvné podmienky\* **HU: TE IS NYERHETSZ.** Felhasználási feltételek érvényesek\* **UA: ВИ МОЖЕТЕ ВИГРАТИ.** Застосовуються загальні положення та умови\* **RO: Ai putea CÂȘTIGA.** Se aplică termeni și condiții\* **BG: Можете да СПЕЧЕЛИТЕ.** Има определени правила и условия\* **LV: Tu vari LAIMĒT.** Ir spēkā noteikumi un nosacījumi.\* **ET: Sul on võimalus VÕITA.** Kehtivad tingimused\* **LT: Jūs galite LAIMĖTI.** Taikomos sąlygos\*  
*\*LEGO.com/productfeedback-terms*

LEGO and the LEGO logo are trademarks of the LEGO Group. ©2025 The LEGO Group.

© 2025 Mojang AB. All Rights Reserved. Minecraft, the Minecraft logo, the Mojang Studios logo and the Creeper logo are trademarks of the Microsoft group of companies.