



SONIC™

THE HEDGEHOG

77005



Q LEGO® Builder



LEGO.com/sustainable-packaging



FR
DONNEZ
OU
RECYCLEZ



OU



OU



ASSOCIATION

MAGASIN

DÉCHÈTERIE

Adresses sur quefairedemesdechets.fr

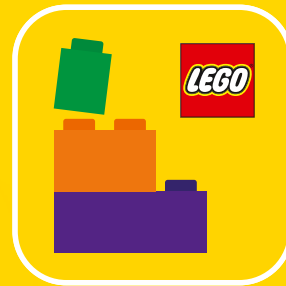

🔍 LEGO® Builder

BUILDER



Apple and the Apple logo are trademarks of Apple Inc., registered in the U.S. and other countries and regions. App Store is a service mark of Apple Inc. Google Play and the Google Play logo are trademarks of Google LLC. Tencent and the Tencent logo are trademarks of Tencent Inc.

🔍 [LEGO.com/devicecheck](https://lego.com/devicecheck)

EN Ask parents' permission before going online | **DE** Eltern um Erlaubnis bitten, bevor du online gehst | **FR** Demande l'autorisation d'un parent avant d'aller en ligne | **IT** Chiedi il permesso ai tuoi genitori prima di andare online | **ES** Pídeles permiso a tus papás antes de conectarte a Internet | **PT** Peça autorização aos pais antes de acederes online | **ZH** 上网前应先征得父母的同意 | **PL** Poproś rodziców o zgodę, zanim wejdziesz do Internetu | **CS** Než půjdeš na internet, požádej rodiče o svolení | **SK** Skôr než pôjdeš na internet, vypýtaj si povolenie od rodičov | **HU** Kérj szülői engedélyt, mielőtt online csatlakoznál! | **UA** Запитуйте дозволу батьків, перш ніж користуватися інтернетом | **RO** Cere permisiunea părinților înainte de a te conecta online | **BG** Поискайте разрешение от родител, преди да влезете онлайн | **LV** Pirms došanās tiešsaistē palūdz atļauju vecākiem | **ET** Enne Interneti kasutamist küsi vanematelt luba | **LT** Prieš prisijungdami prie interneto, atsiklauskite tėvų

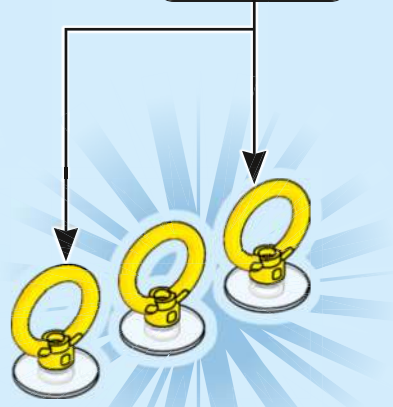
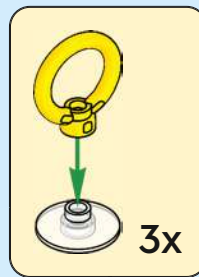
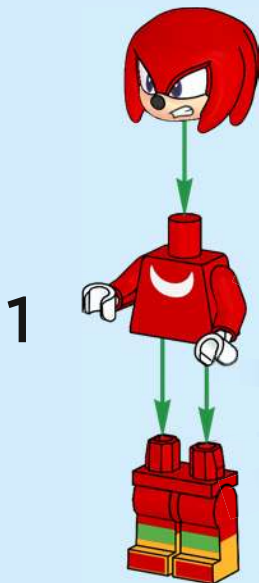

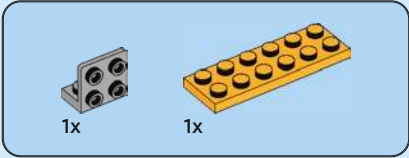
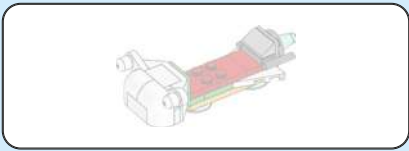

1

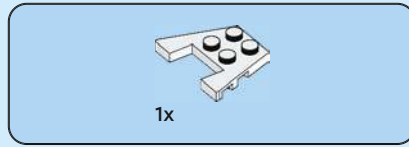
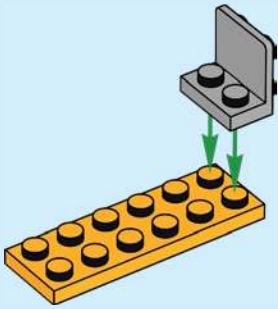

2

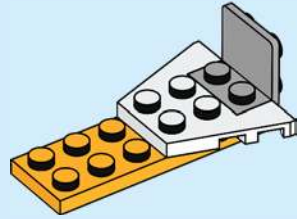

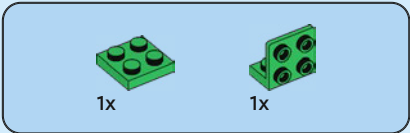

3

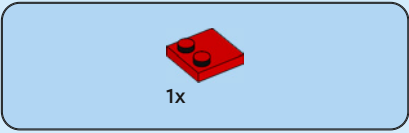
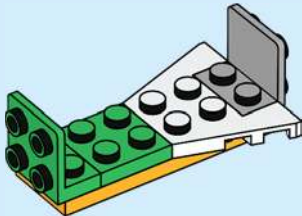

4

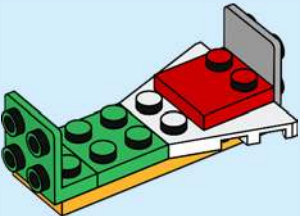



5

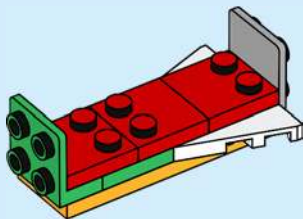

6

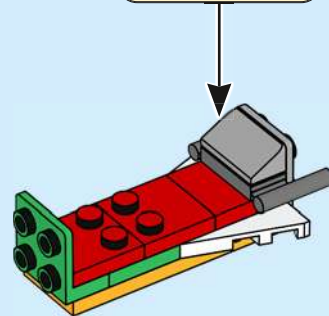
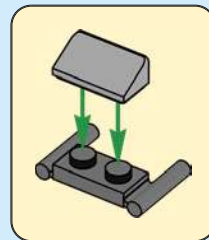



1x



1x

7

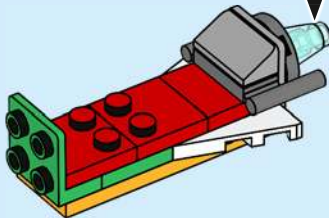

2x

8

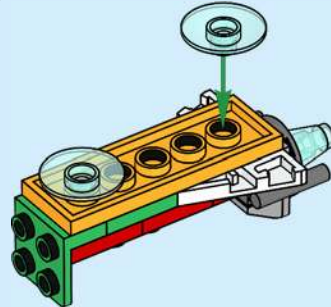
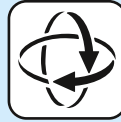

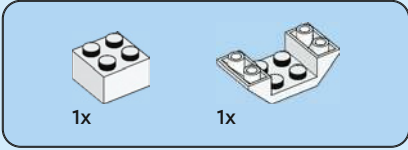

9

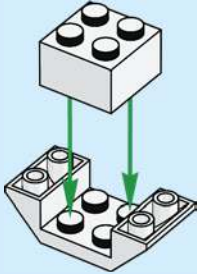

10

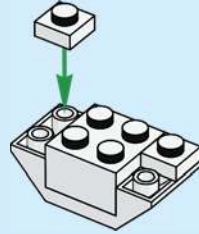

11

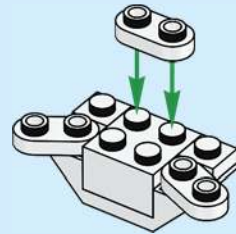

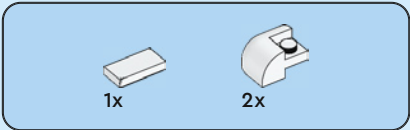

12

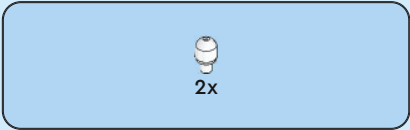
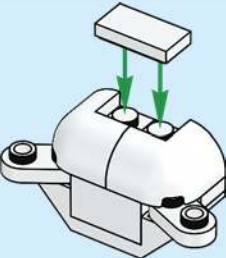

13



14

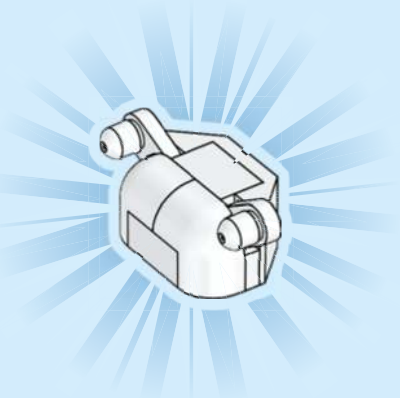

15

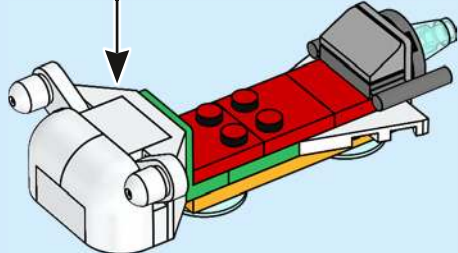

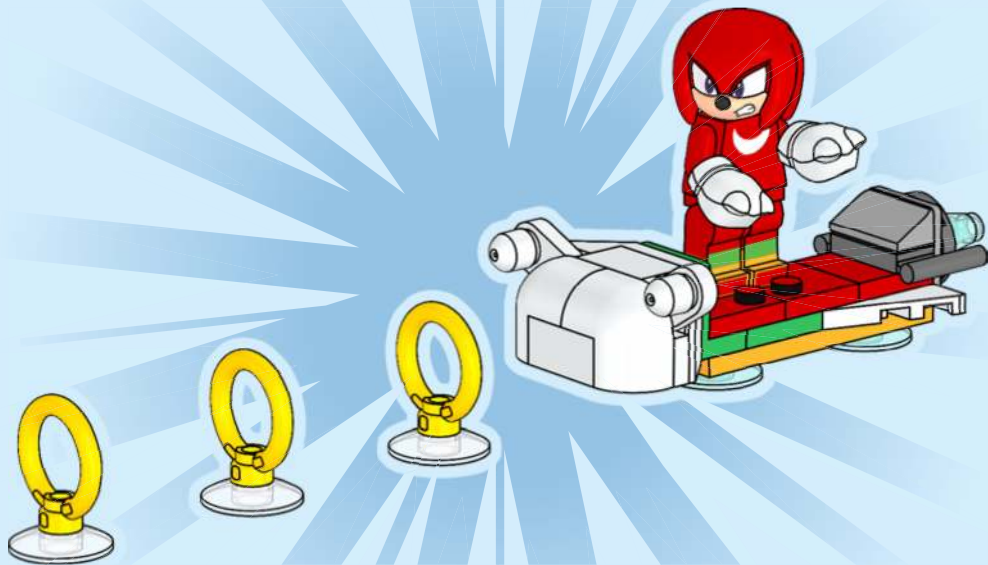

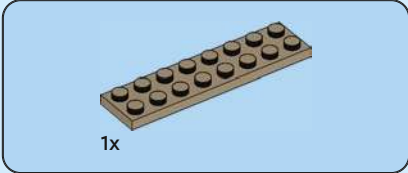
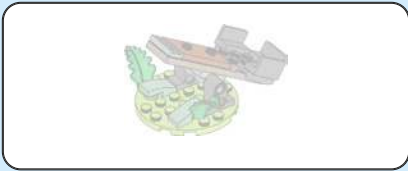

1

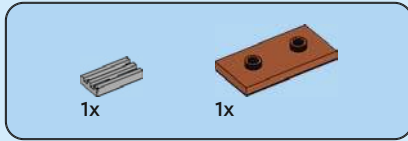
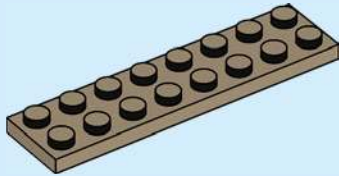

2

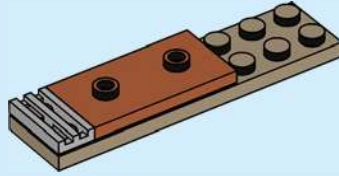

3

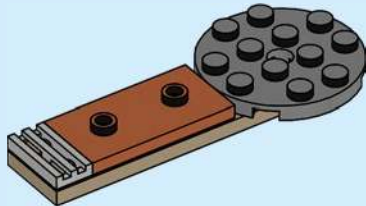

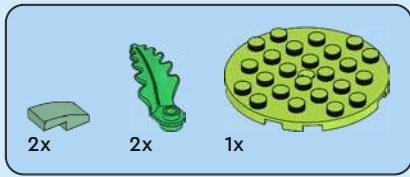

8

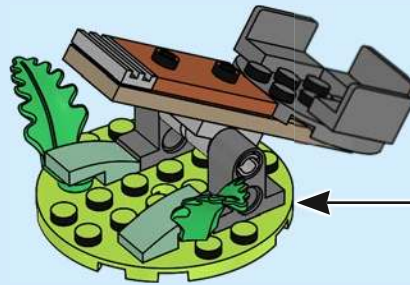
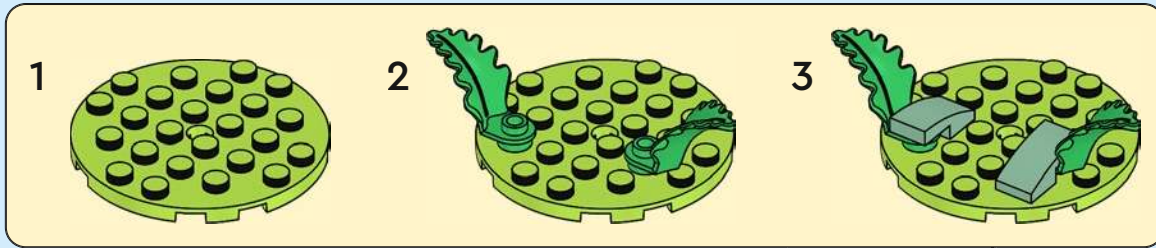

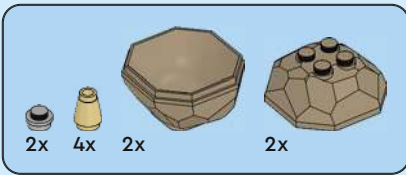

9

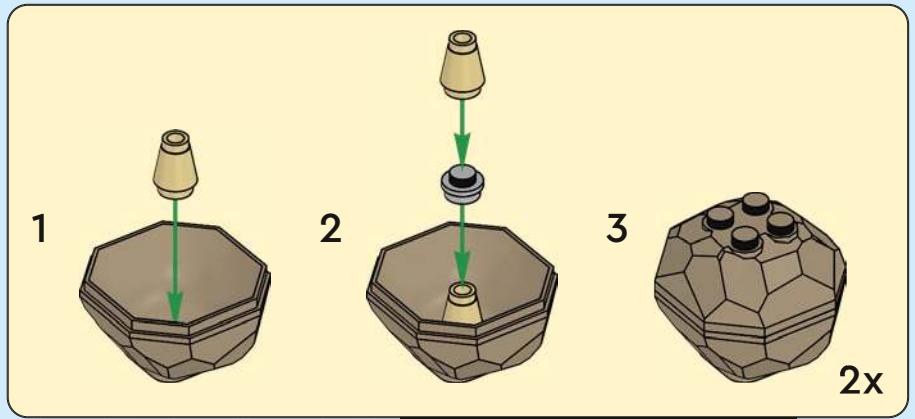

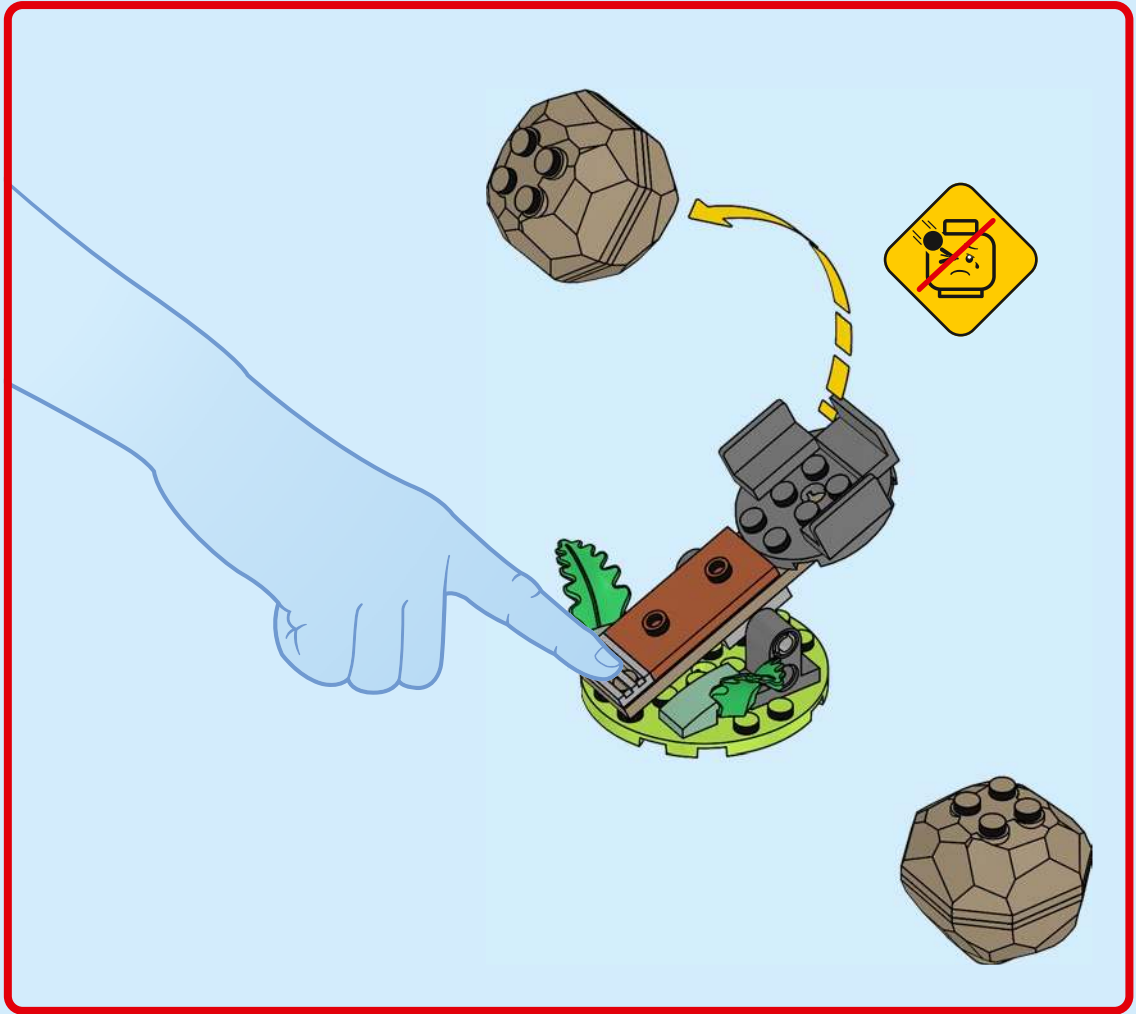

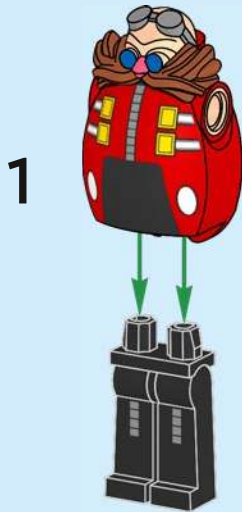

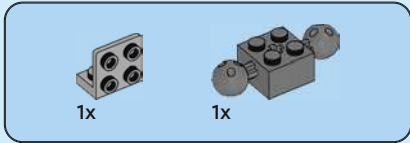

1

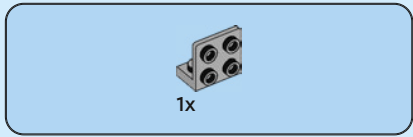
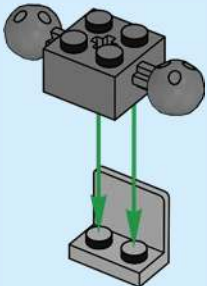

2

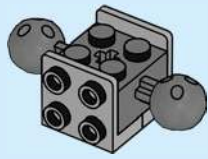

3



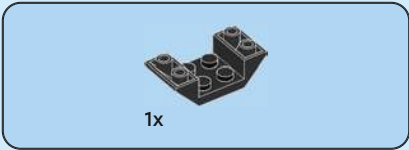

4

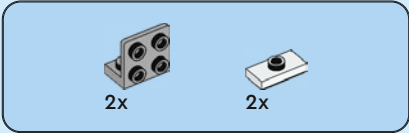
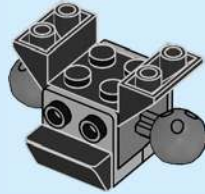

5

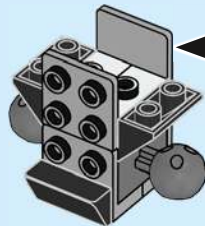
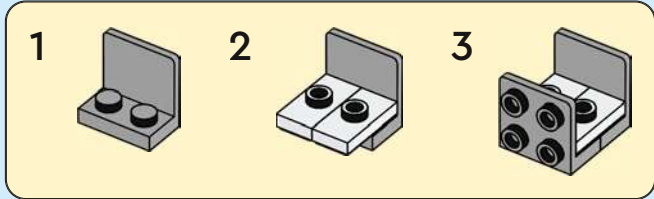



2x



4x



2x



2x

6

1

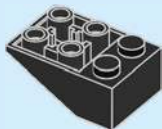

2



3

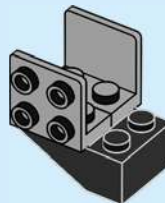

4

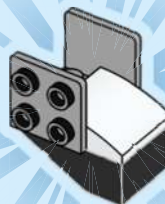

2x



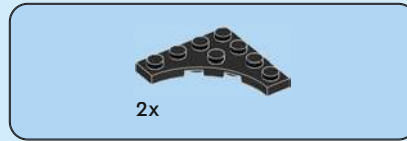
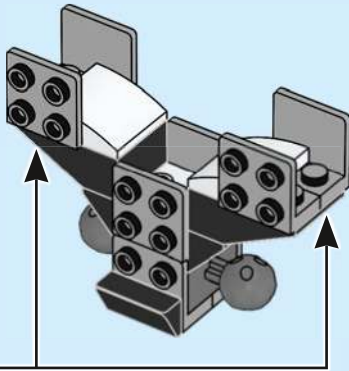

7

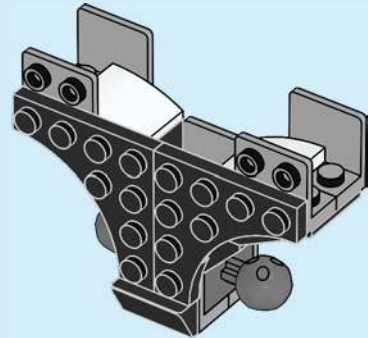



2x



2x



2x



2x



4x



4x



2x



2x

8

1

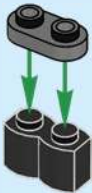

2



3



4



5



6



2x

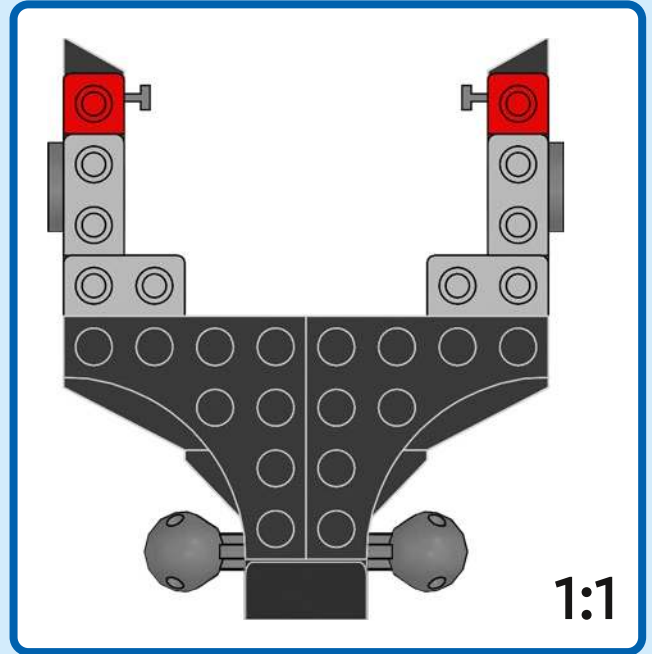
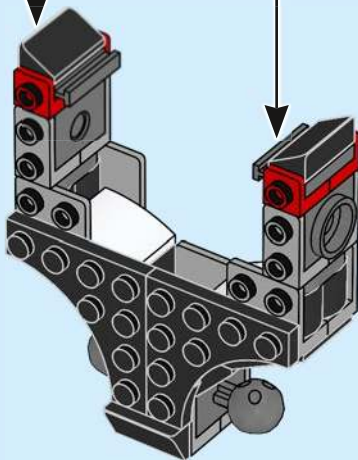

1:1



2x

9

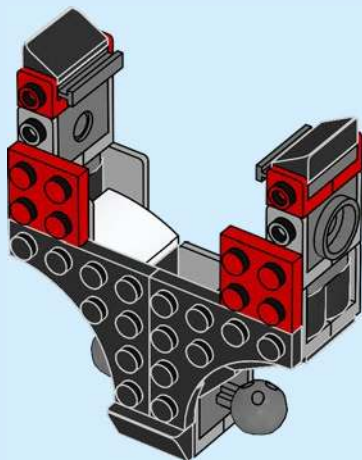

1x

10

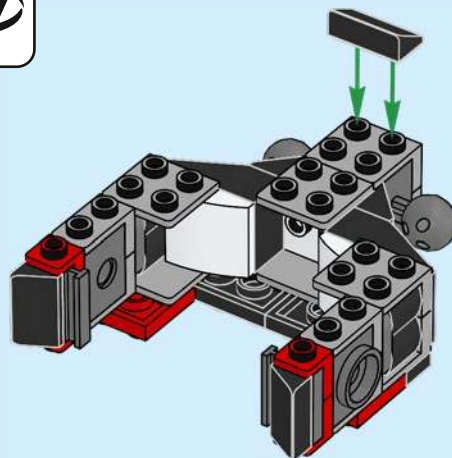

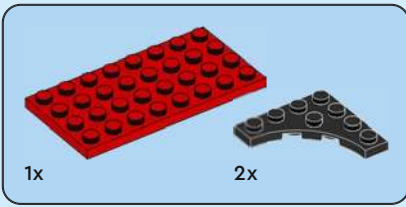

11

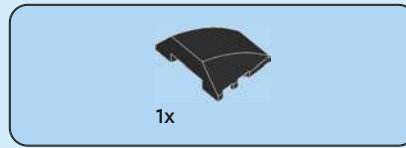
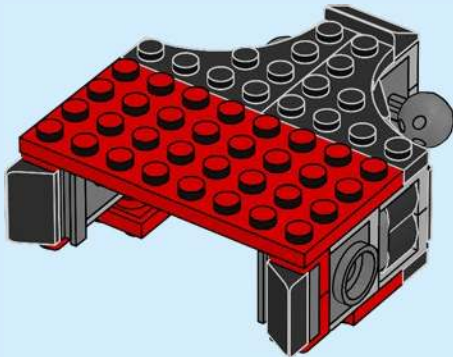

12

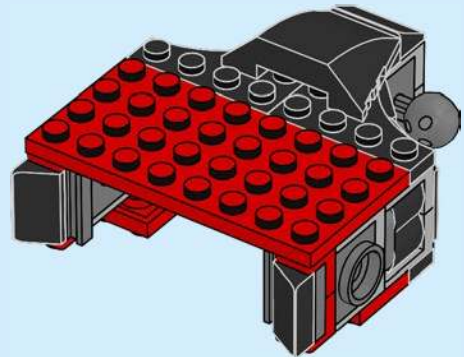

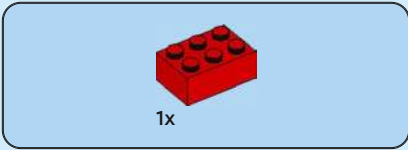

13

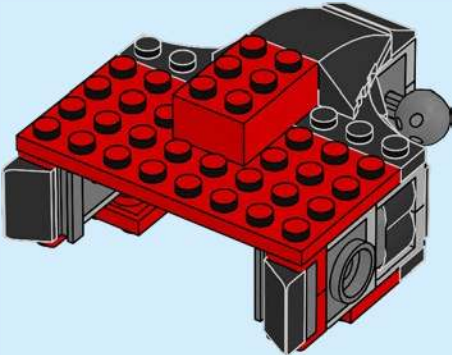

14

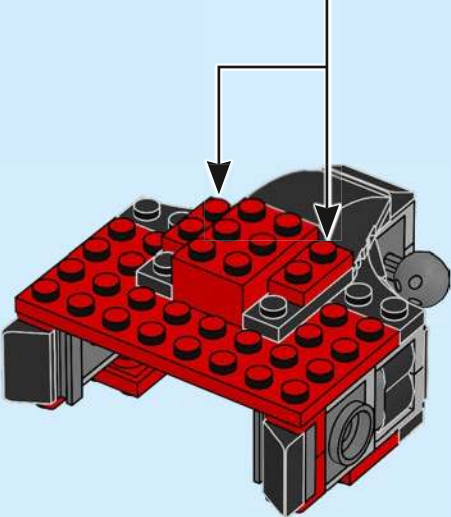
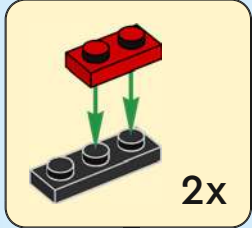

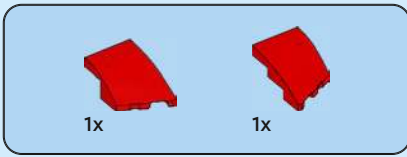

15

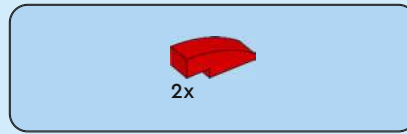
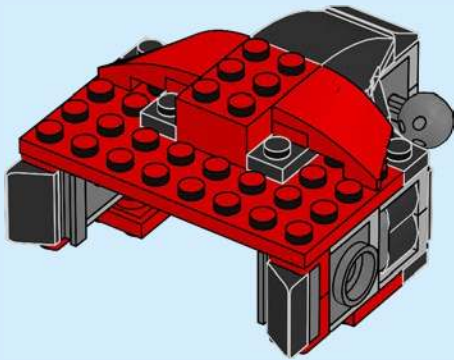

16

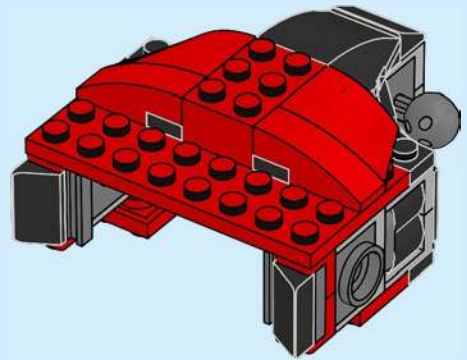



1x



1x

17

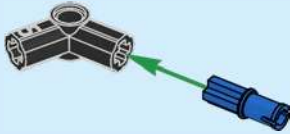

1x

18

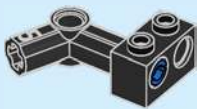

1x



1x



1x

19

1

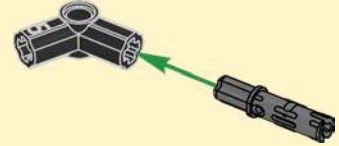

2

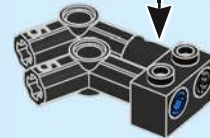
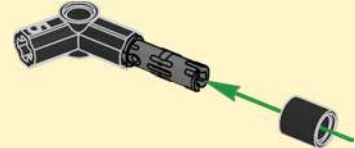



2x

20



2x

21



2x

22

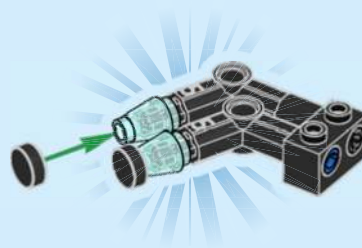

23

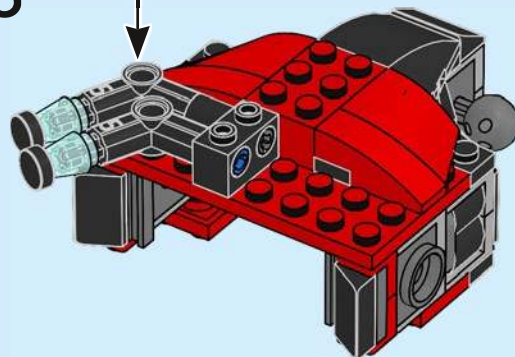

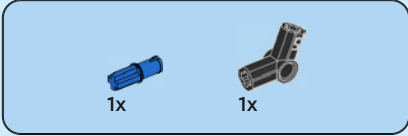
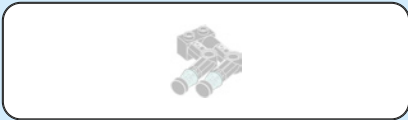

24

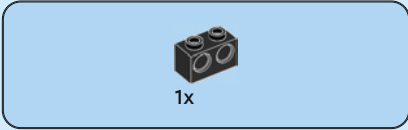
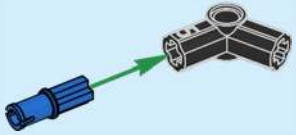

25

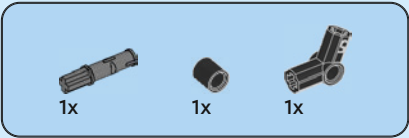

26

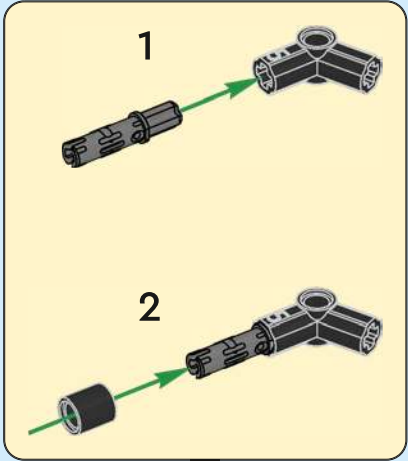



2x

27

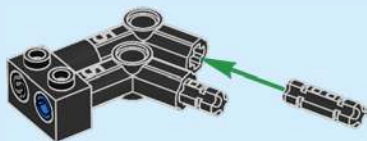

2x

29

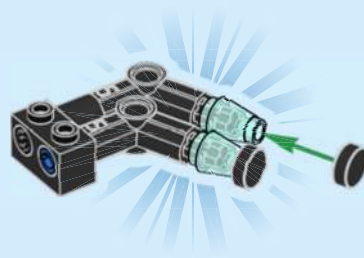

2x

28



30

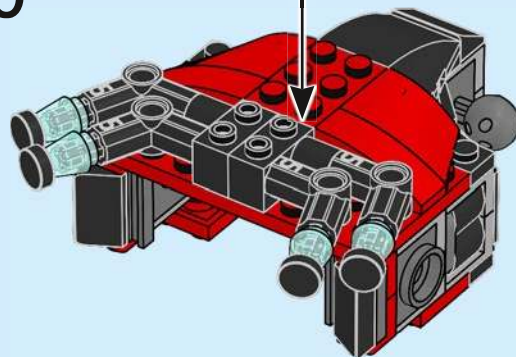



2x



2x

31

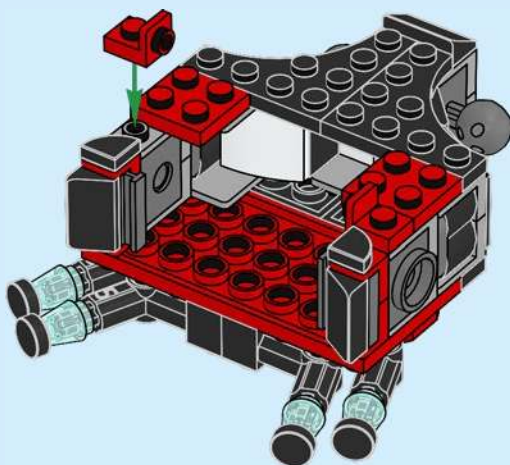

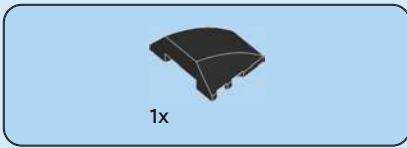

32

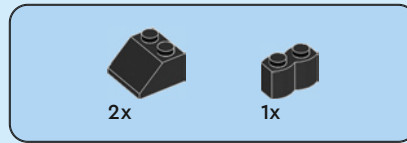
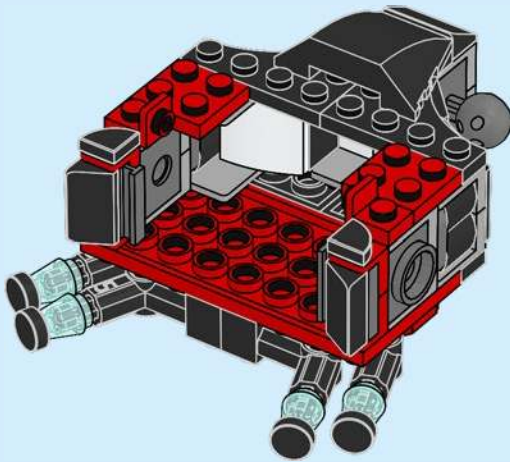

33

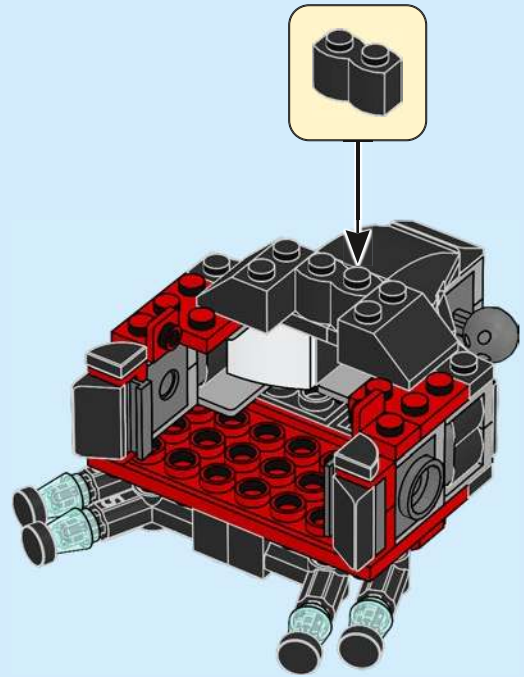

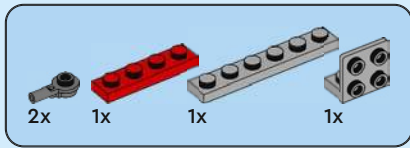

34

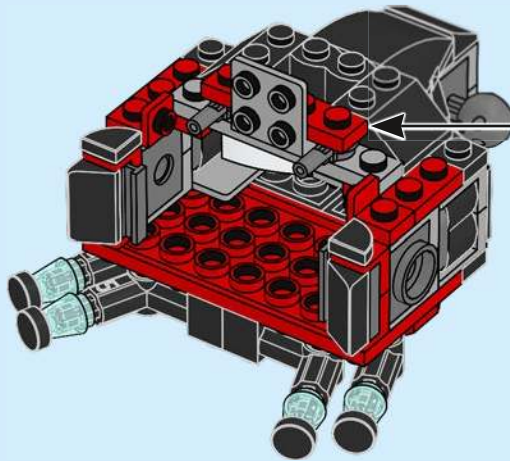
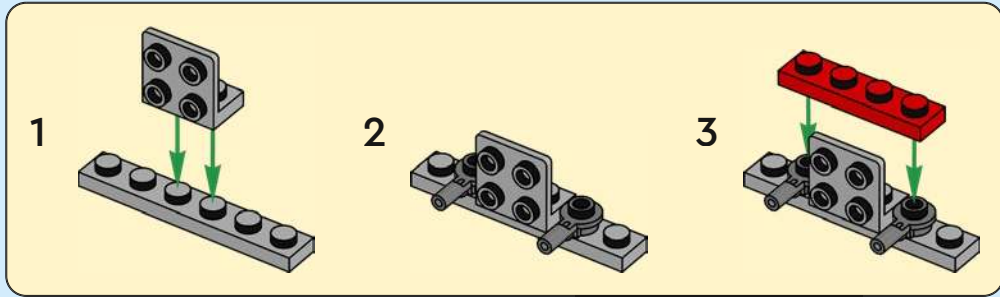

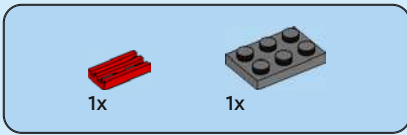

35

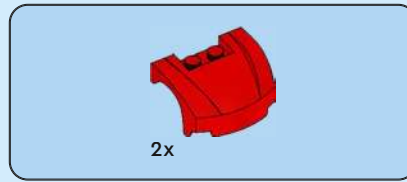
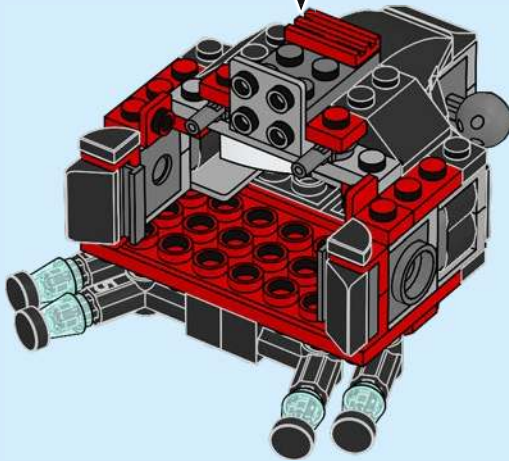
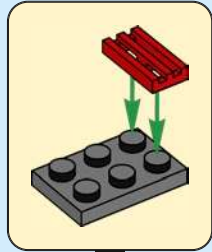

36

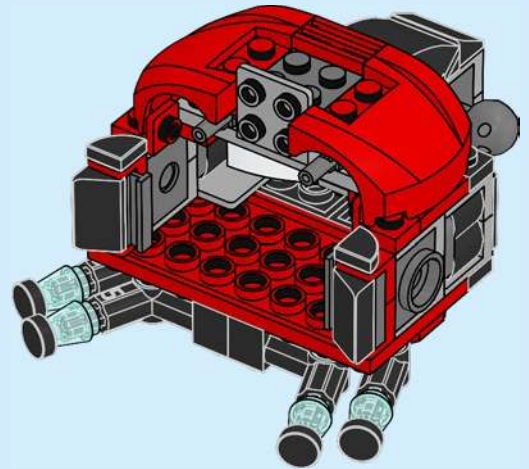

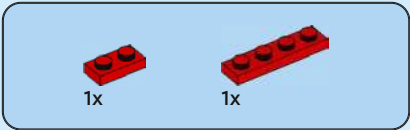

37

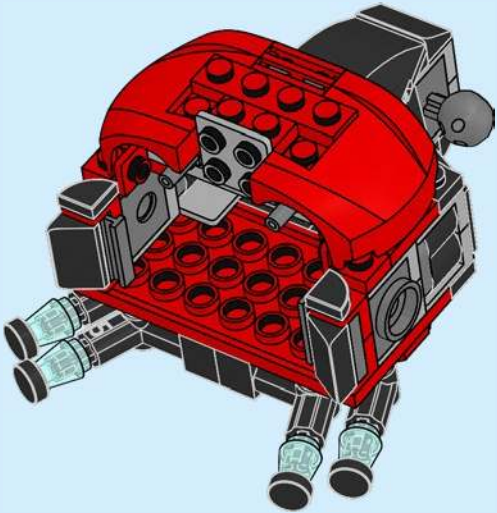

38

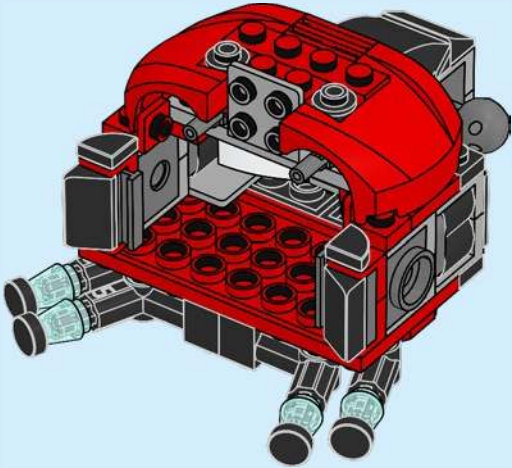



1x



2x

39

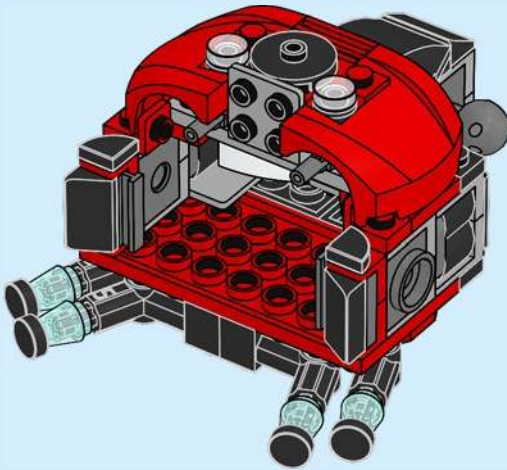

1x

40

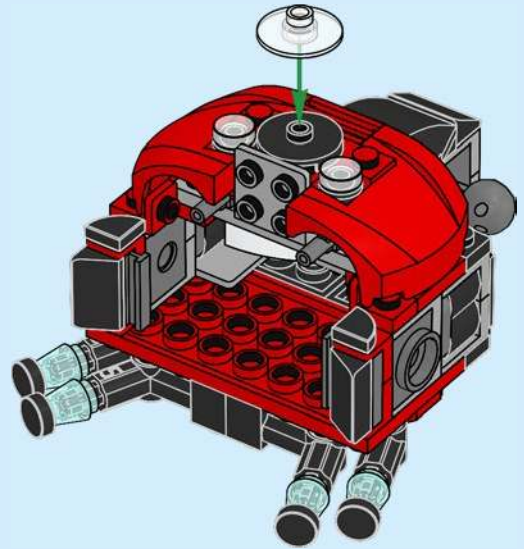

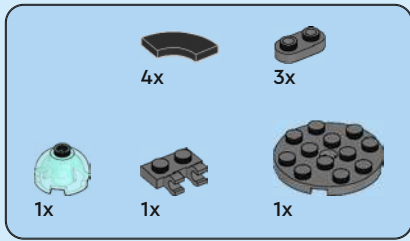

41

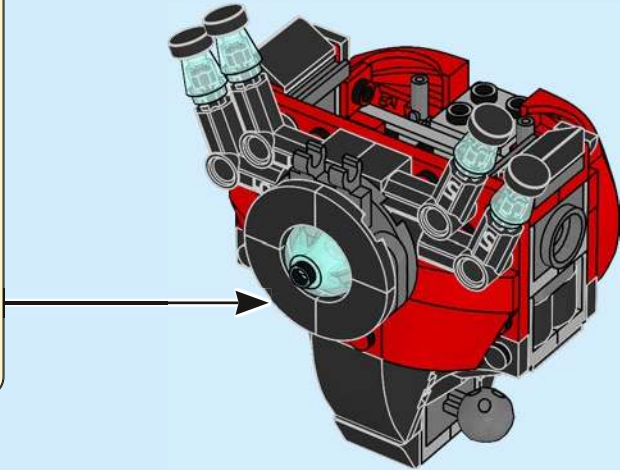
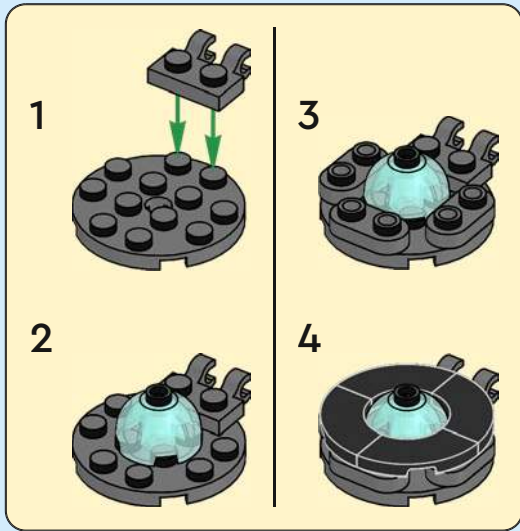



2x



1x



1x

42

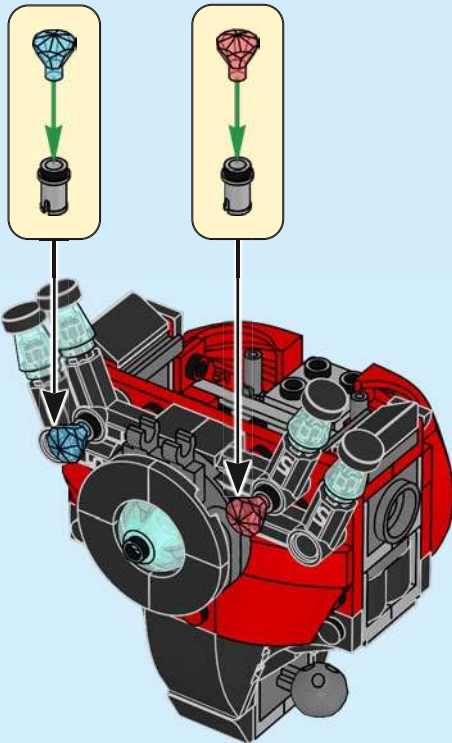

1x

43

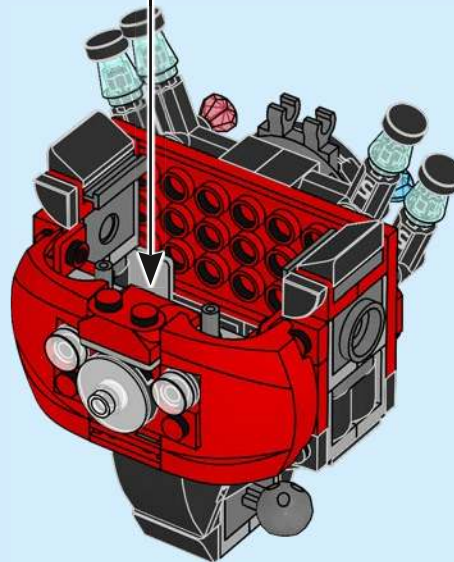
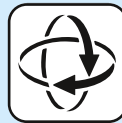



44

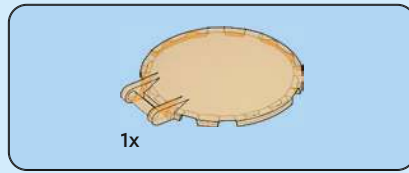
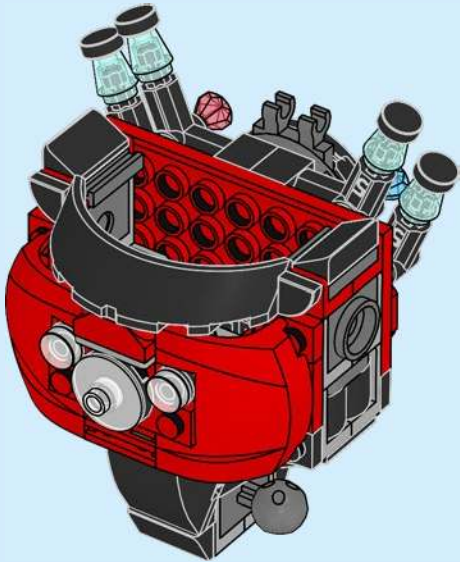

45

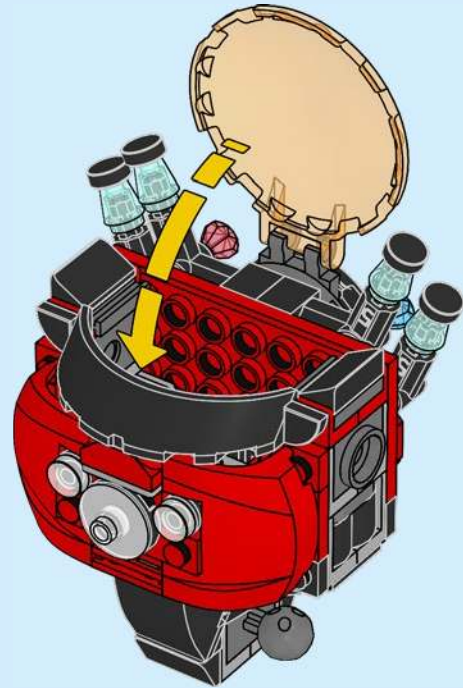

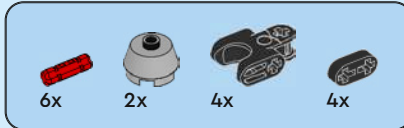

46

1



2



3

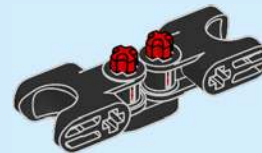

4



5

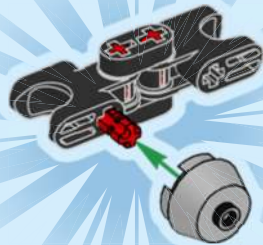

2x

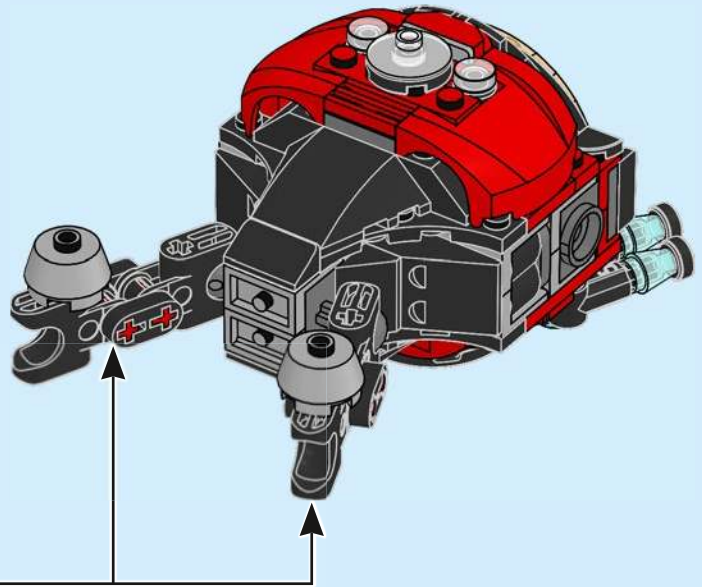



2x



1x

47

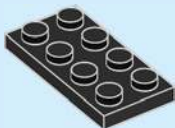

1x

48

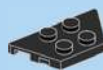

1x

49

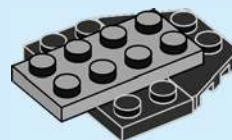

2x

50





51

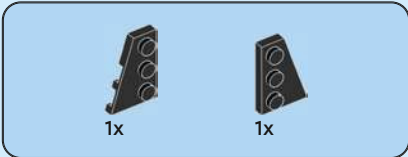
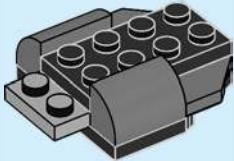

52

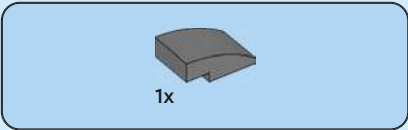
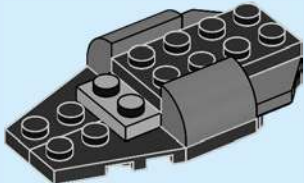

53

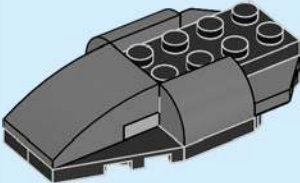

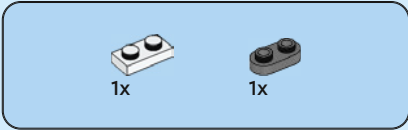
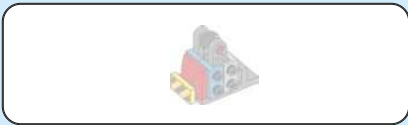

54

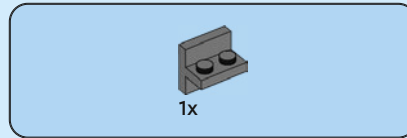
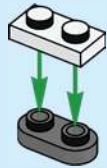

55

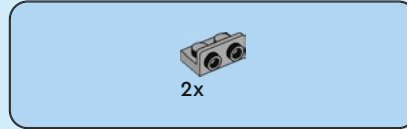
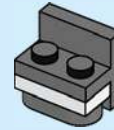

56

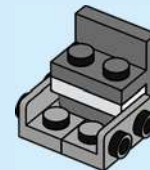

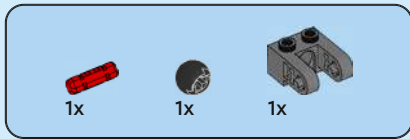

57

1



2

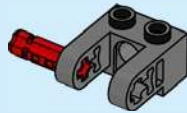

3

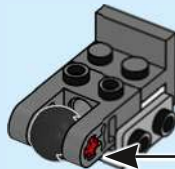
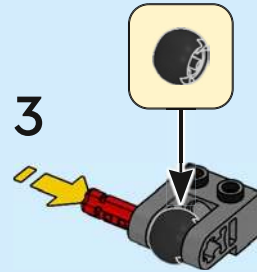



2x

58

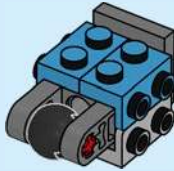

1x



1x

59

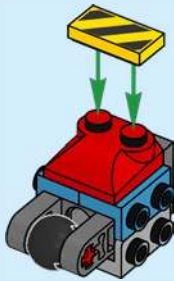

1x



1x

60

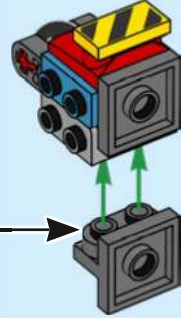
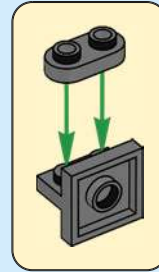
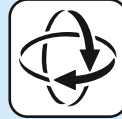

61

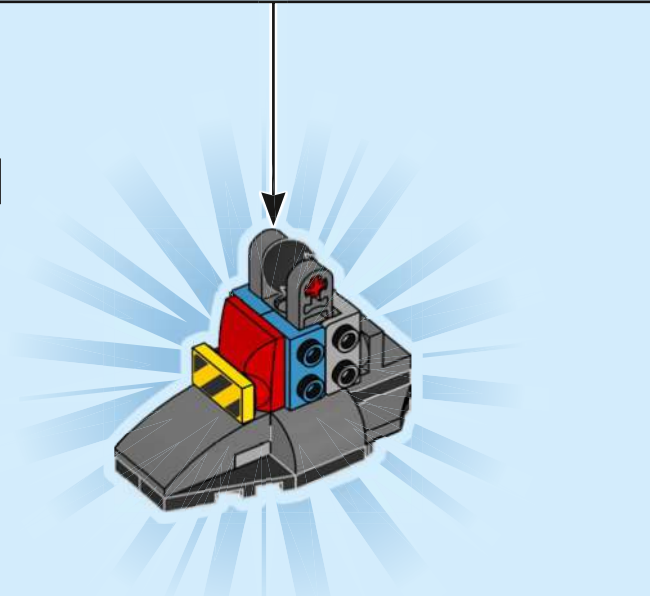

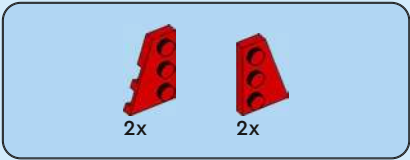

62

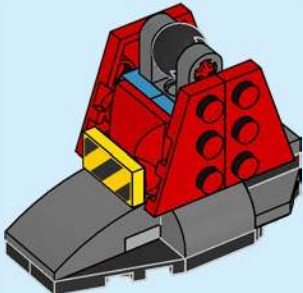

63

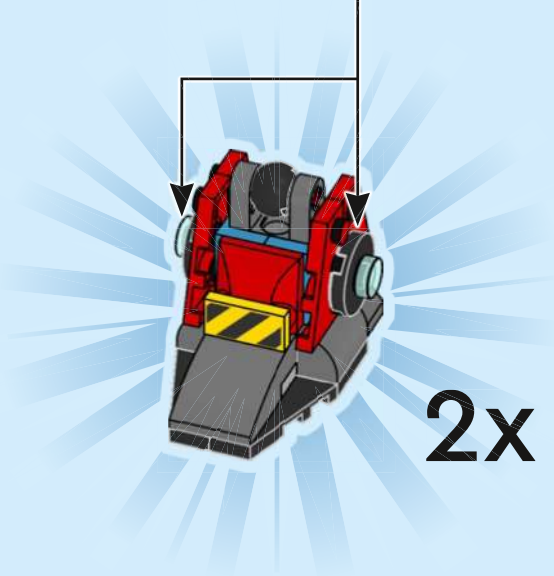
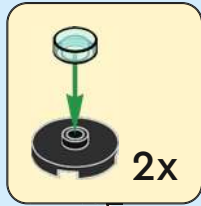

64

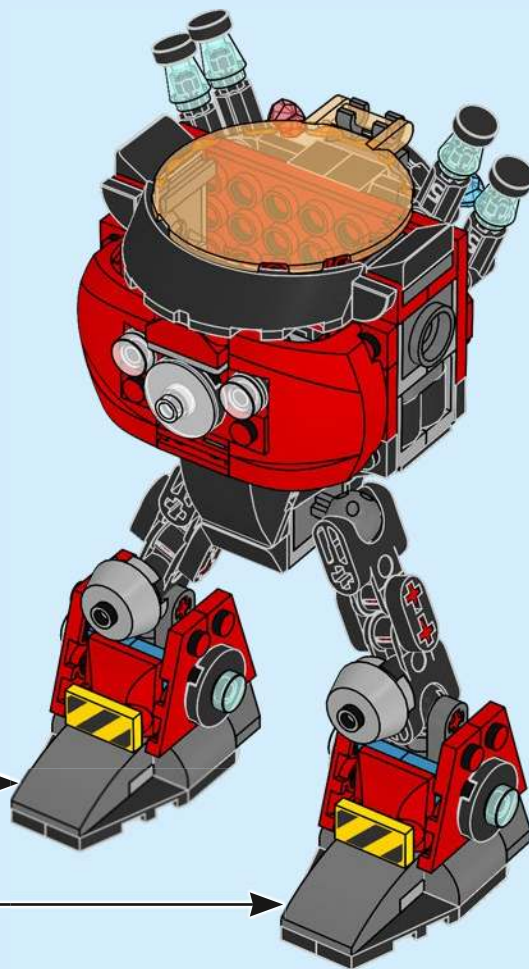

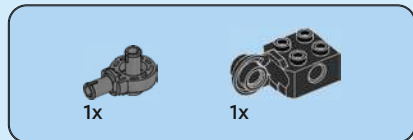

65

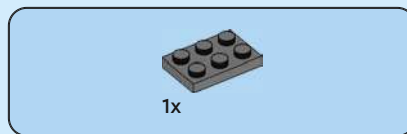
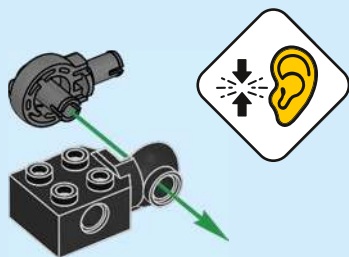

66

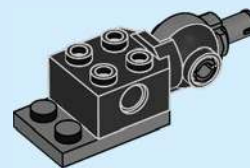

67

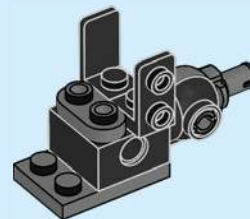

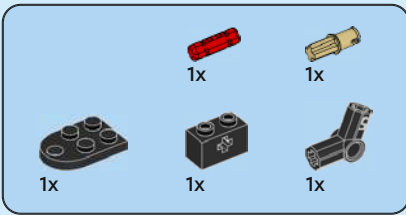

68

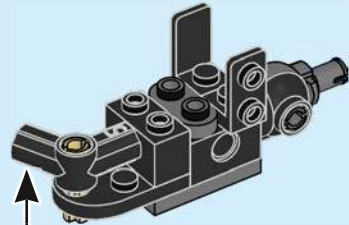
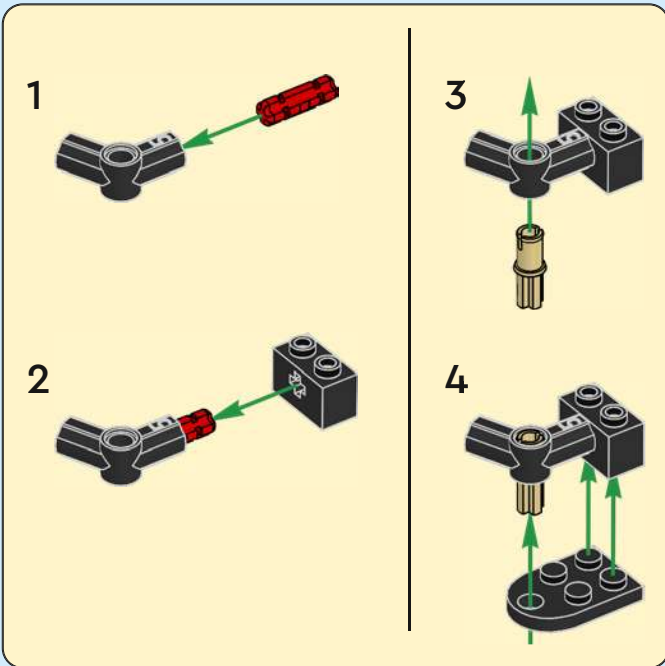

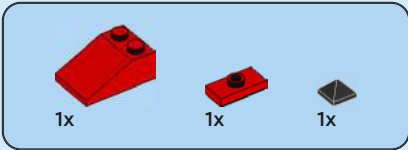

69

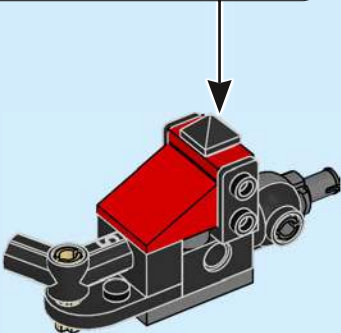
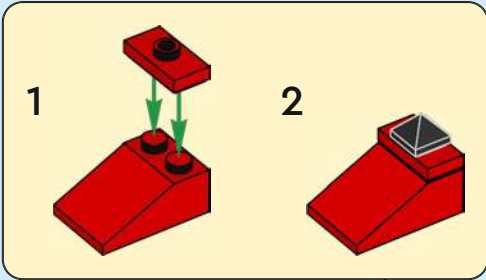

70

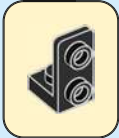
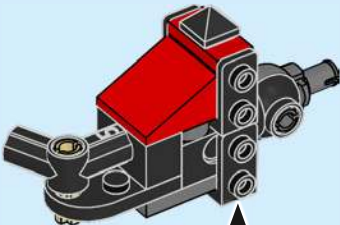



71

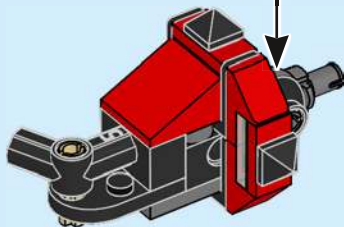
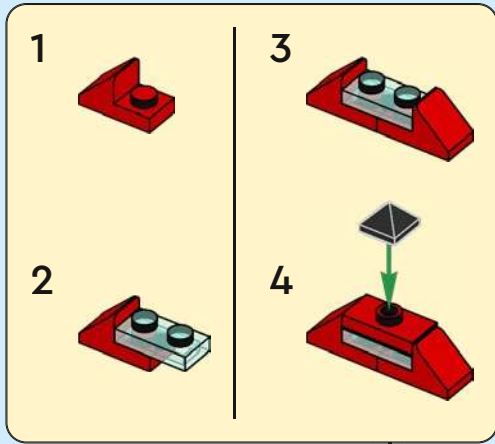

72

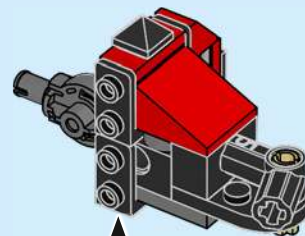
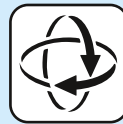



73

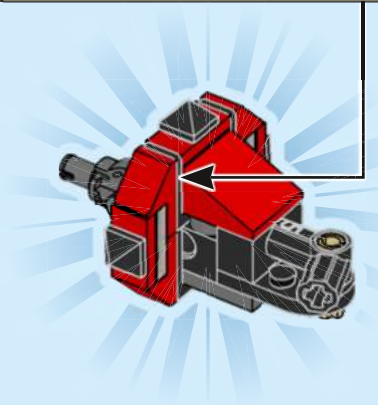
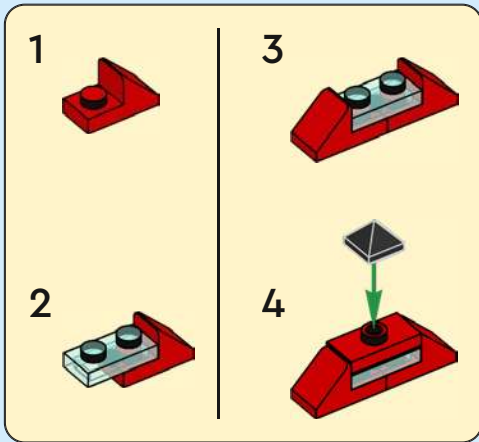

74

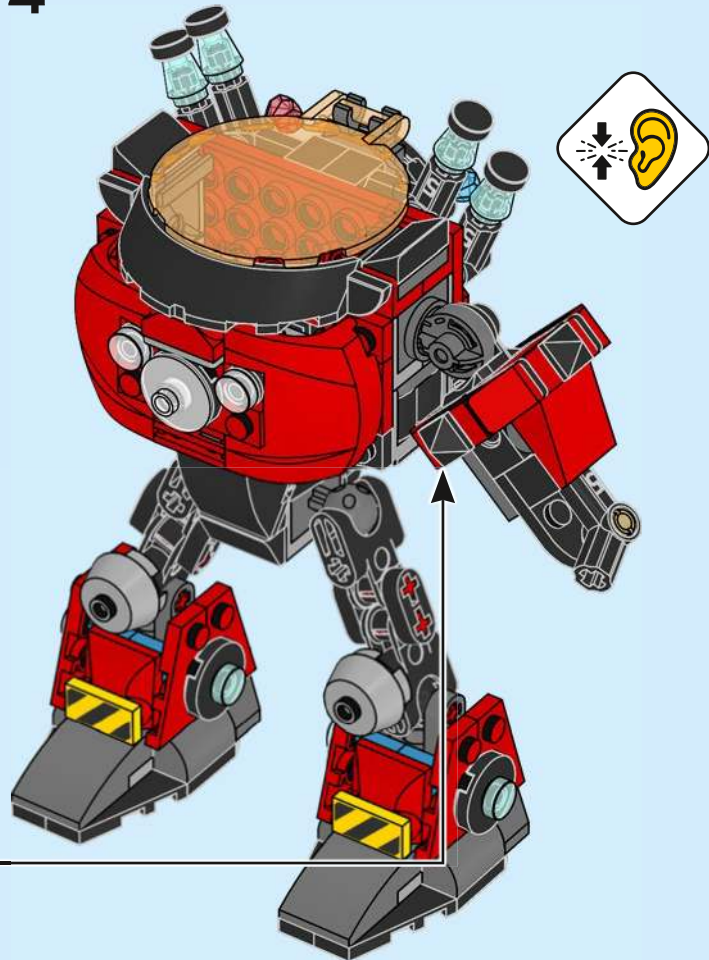

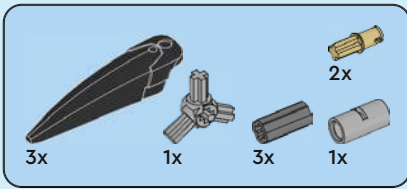

75

1

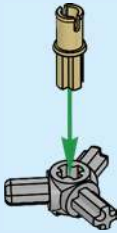

2

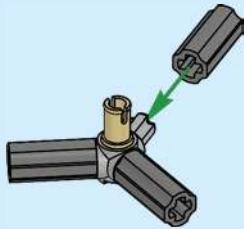

3

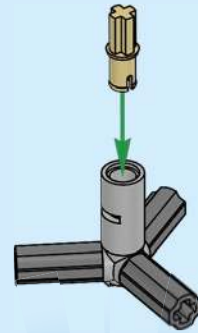

4

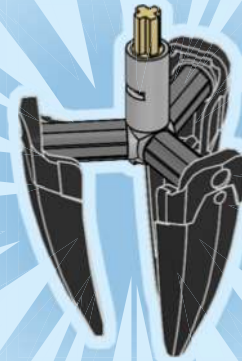

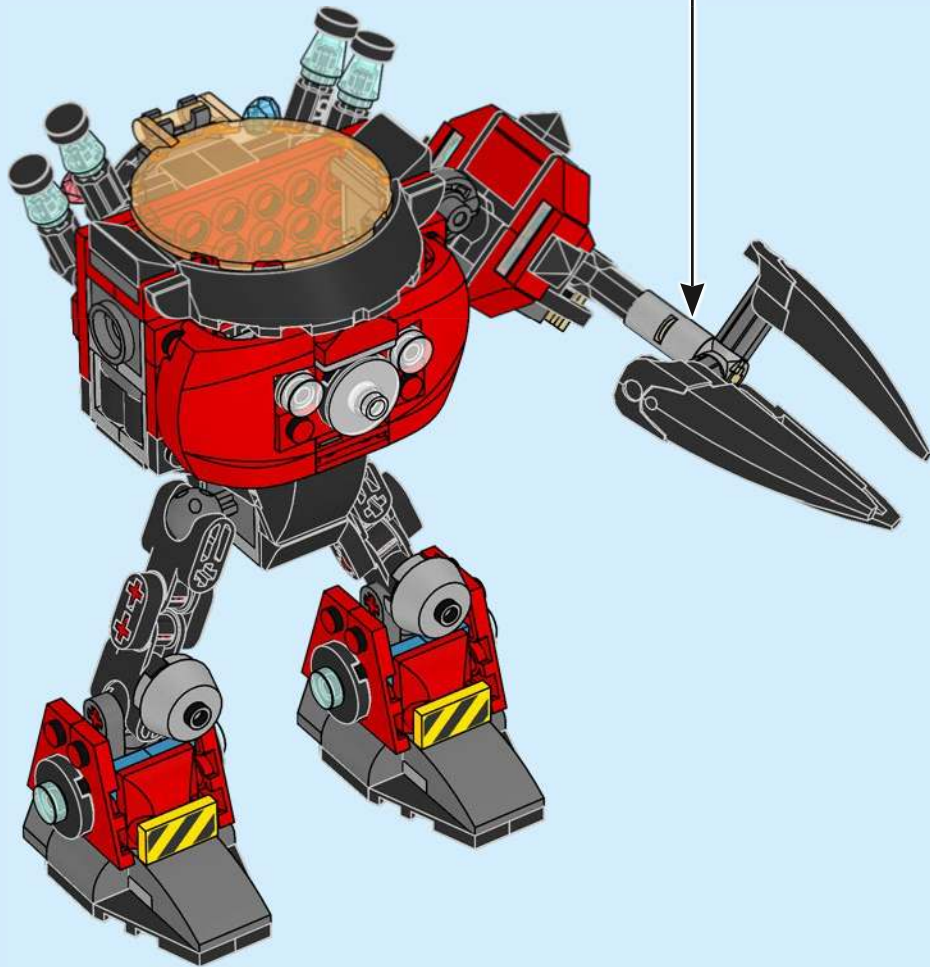

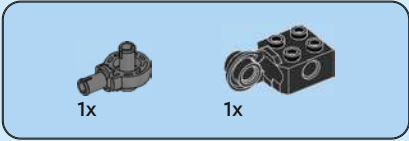

76

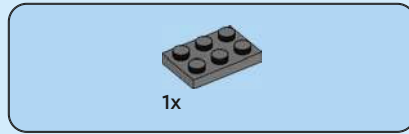
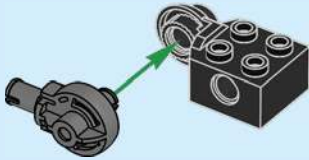

77

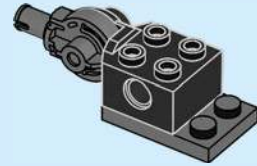

78

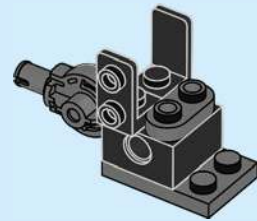

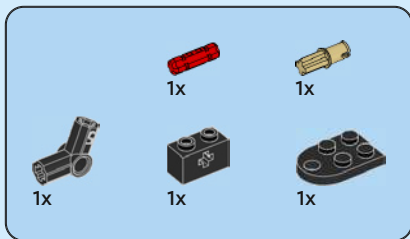

79

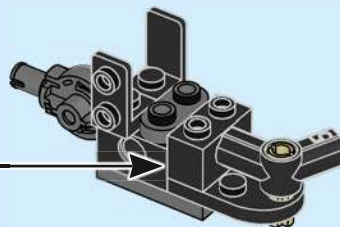
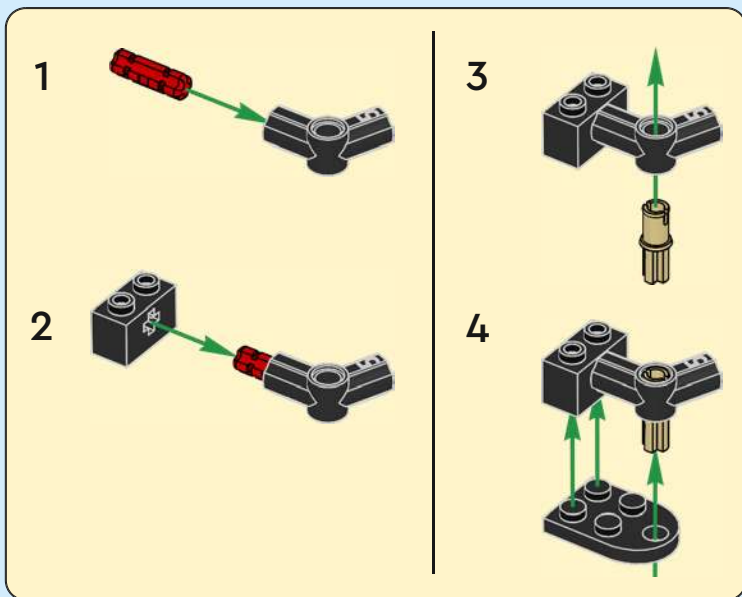

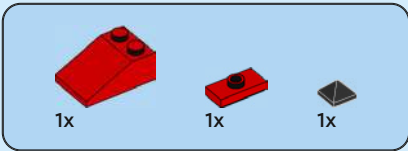

80

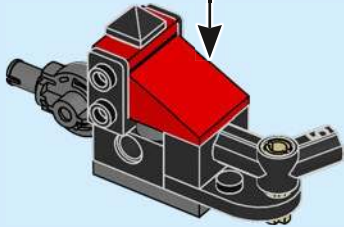
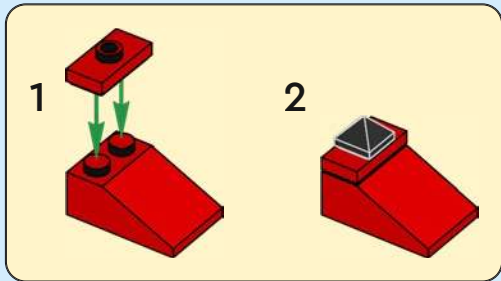

81

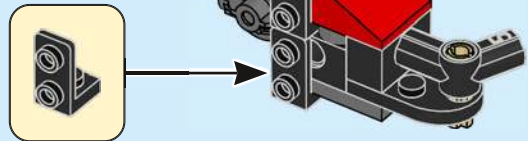



82

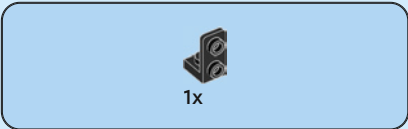
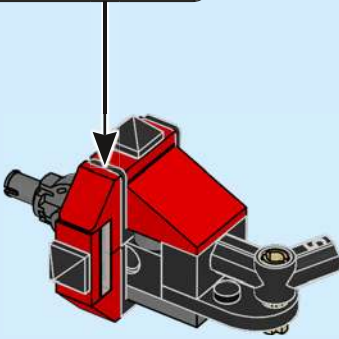
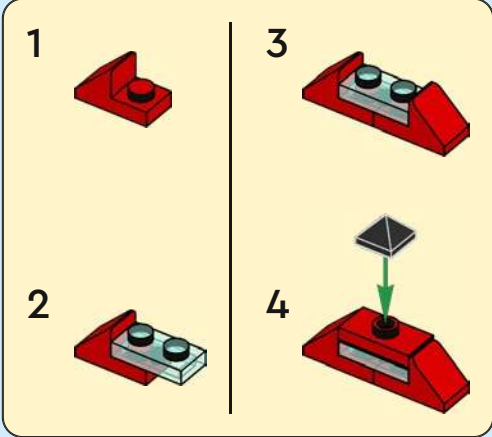

83

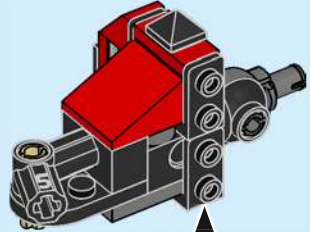



2x



1x



1x



1x

84

1



3



2



4

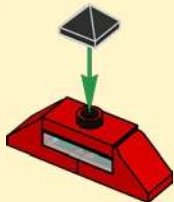

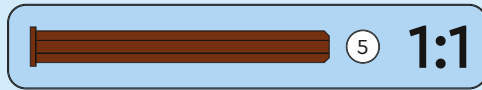
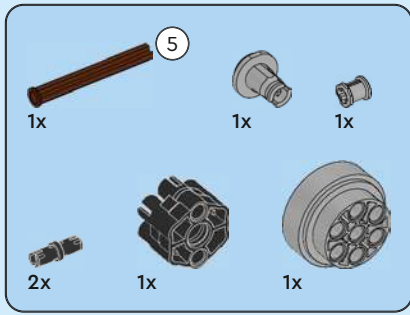

85

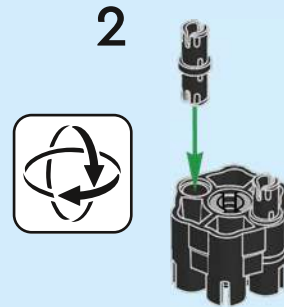
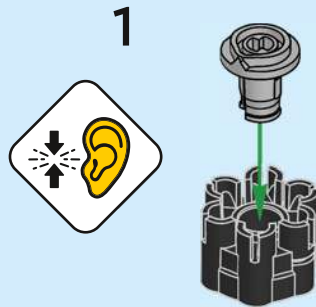

3

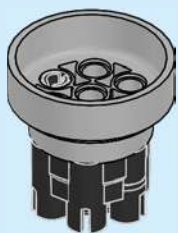

4



5

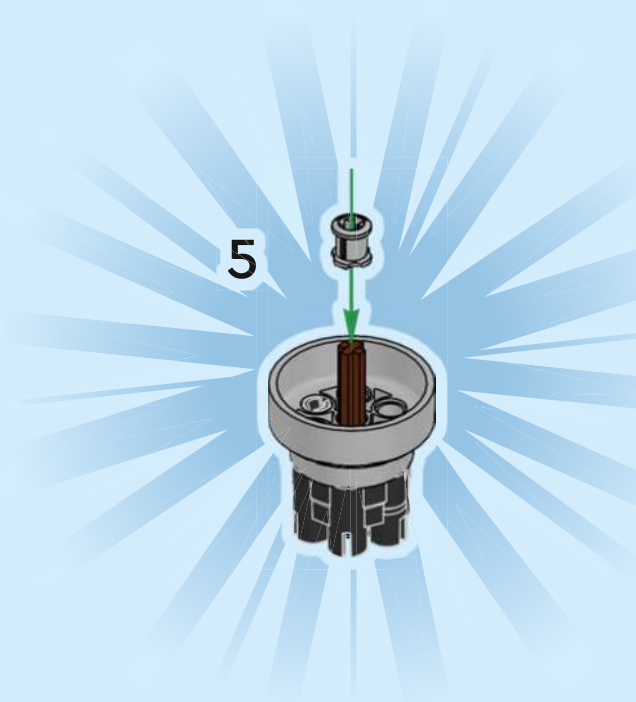

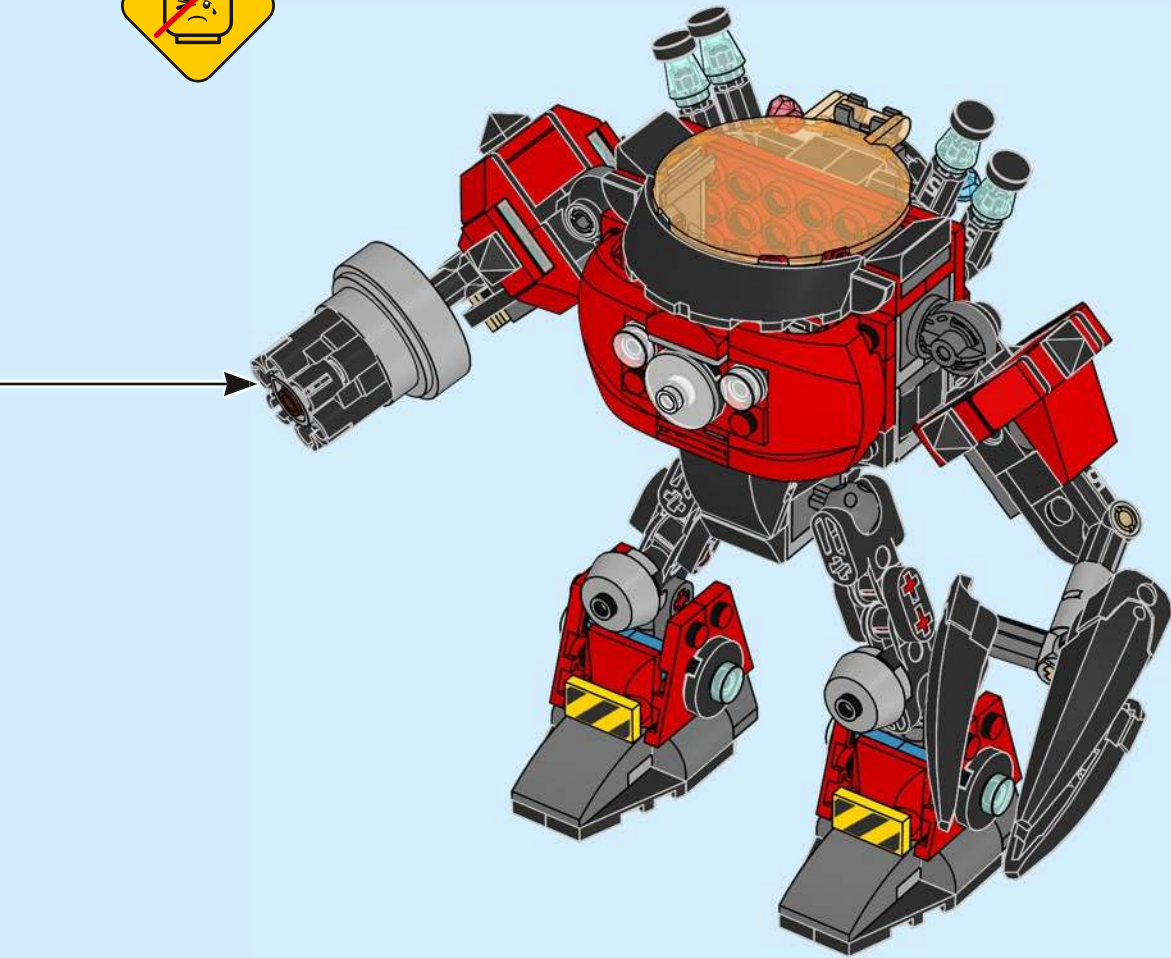



12x

86

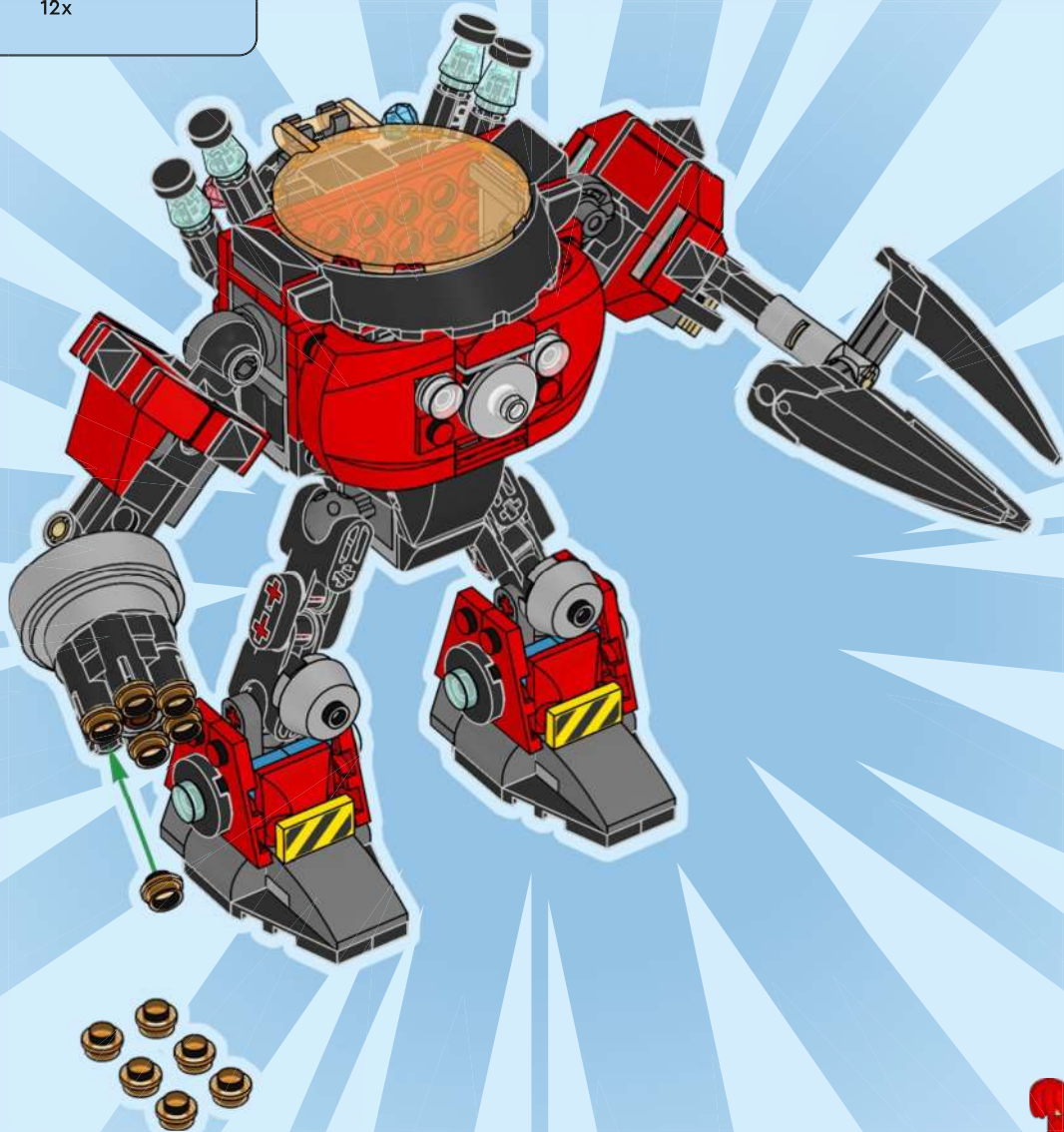

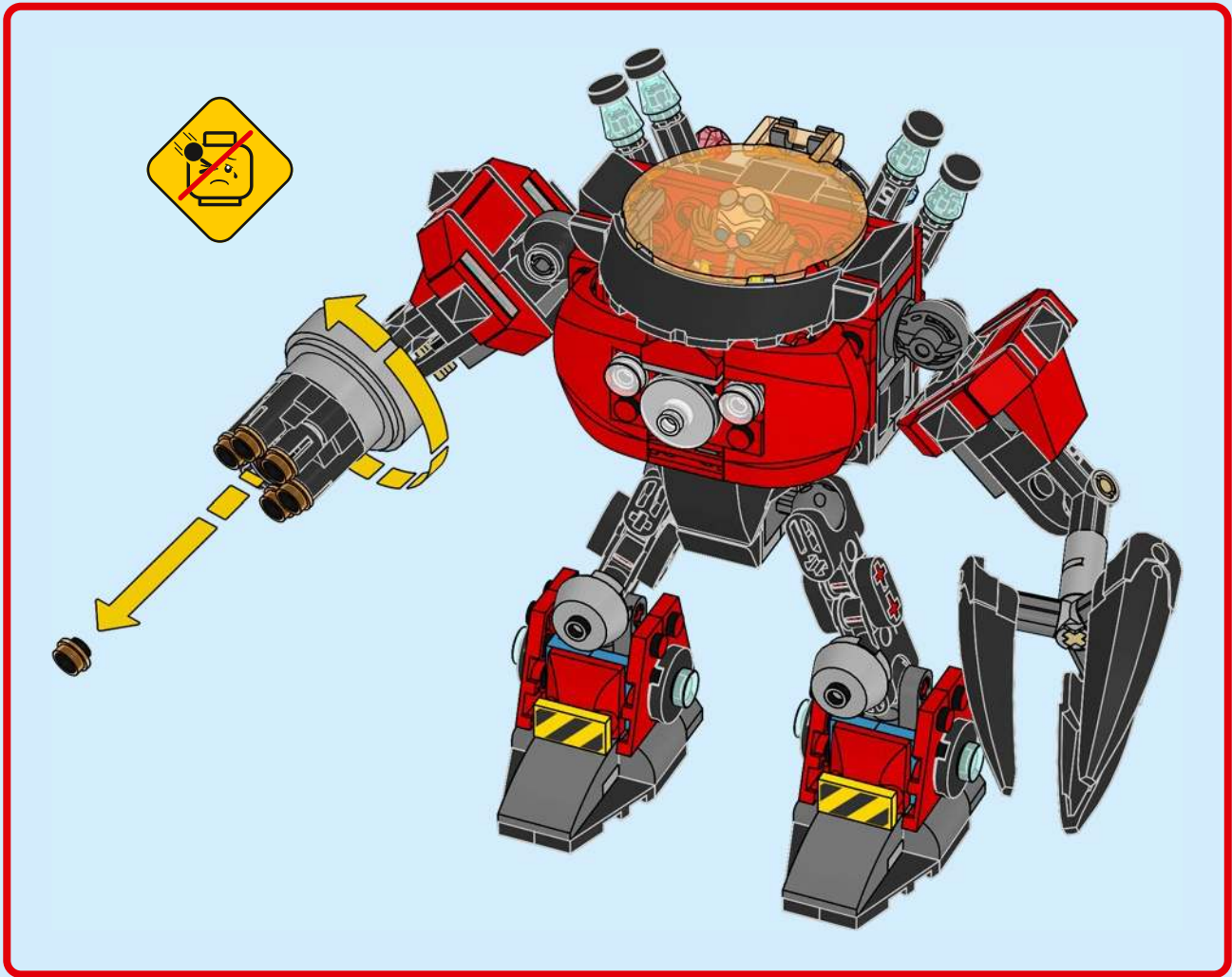





SONIC™

THE HEDGEHOG



77002



77001



77003



©SEGA. All rights reserved. SEGA is registered in the U.S. Patent and Trademark Office. SEGA and SONIC THE HEDGEHOG are either registered trademarks or trademarks of SEGA CORPORATION.

EXPLORE MORE















































































Explore more
 Mehr entdecken
 En savoir plus
 Esplora di più
 Explora más
 Explorar mais
 了解更多
 Zobacz więcej
 Objev více
 Objav viac
 Tudj meg többet!
 Дізнайтеся більше
 Descoperă mai multe
 Разгледайте още
 Izprēti vairāk
 Uuri lähemalt
 Atraskite daugiau



 LEGO.com/sonic



 2x 6448949	 6x 6249907	 1x 6443218	 1x 6528046	 2x 6168646	 4x 6338289	 1x 6360819
 2x 302401	 6x 6092565	 1x 6492337	 8x 6053011	 4x 6284070	 6x 6271346	 2x 6302828
 2x 6431337	 10x 4142865	 1x 6474530	 3x 302321	 6x 6312449	 2x 303926	 2x 362326
 3x 6210272	 1x 241221	 1x 6474530	 4x 4180504	 2x 6172383	 2x 6435928	 2x 6009018
 2x 6051511	 2x 4251162	 1x 6508124	 4x 4180533	 2x 6121485	 2x 6435928	 2x 6009018
 1x 306901	 1x 6527749	 2x 329821	 4x 4180533	 2x 4286267	 2x 4531412	 1x 4188534
 2x 302301	 3x 6219819	 1x 300221	 2x 4180508	 4x 4109810	 2x 317626	 4x 302026
 2x 6047220	 3x 4220515	 2x 371021	 2x 4180536	 2x 6178922	 3x 6444456	 4x 6208787
 1x 300301	 2x 302221	 2x 6422923	 4x 6338428	 3x 4644456	 1x 6443216	 1x 6560521
 1x 6170524	 1x 6436412	 2x 6422923	 2x 6279875	 4x 4548180	 4x 6191630	 1x 6560521
 1x 4173943	 1x 6436413	 1x 303521	 5x 6195325	 8x 6335317	 2x 3200026	 3x 6297810

2x
4206482

1x
6493342

2x
6581711

1x
302228

1x
6288614

5x
6514027

2x
6580378

4x
6514007

1x
6507968

1x
6513973

2x
6514191

4x
6514246

1x
6513969

4x
6514192

1x
6133836

2x
6555150

2x
6555149

1x
4246957

2x
6196591

2x
6514059

1x
6507912

1x
6097509

1x
6159763

1x
6275844

2x
4211525

2x
4211483

4x
6345639

1x
6173127

4x
6004990

2x
4211807

1x
4211350

1x
6361703

2x
6028324

1x
4568637

10x
4654580

1x
4211376

1x
4502595

2x
4211395

1x
4511007

1x
4211438

4x
4666579

4x
4529237

2x
6329649

3x
6508325

4x
6152101

3x
6146225

2x
6398662

2x
6388118

11x
6221607

1x
6115080

4x
6177079

1x
6350292

2x
6015356

2x
4543086

3x
4516546

4x
6302690

2x
6324639

2x
4210763

4x
6250018

2x
6501502

2x
4522784

1x
4263176

3x
4211043

2x
4528323

1x
6065816

 [LEGO.com/service](https://www.LEGO.com/service)



YOU COULD **WIN**

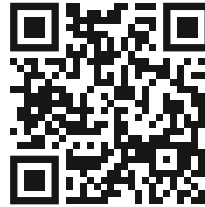

Scan this QR code or go to
LEGO.COM/PRODUCTFEEDBACK and give us
your short feedback about this LEGO® set
for a chance to win a cool LEGO prize.

Terms and Conditions apply*

EN: YOU COULD WIN. Terms and Conditions apply* **DE: Du könntest GEWINNEN.** Es gelten die Teilnahmebedingungen* **FR: Tu pourrais GAGNER.** Des conditions s'appliquent* **IT: Potresti VINCERE tu.** Termini e condizioni sono applicabili* **ES: Puedes GANAR.** Aplican términos y condiciones* **PT: PODERÁ GANHAR.** Aplicam-se Termos e Condições* **ZH: 轻松获奖.** 条款和条件适用* **PL: Szansa na WYGRANĄ.** Obowiązuje regulamin* **CS: Máte šanci VYHRÁT.** Platí všeobecné smluvní podmínky* **SK: Máte šancu VYHRAŤ.** Platia všeobecné zmluvné podmienky* **HU: TE IS NYERHETSZ.** Felhasználási feltételek érvényesek* **UA: ВИ МОЖЕТЕ ВИГРАТИ.** Застосовуються загальні положення та умови* **RO: Ai putea CÂȘTIGA.** Se aplică termeni și condiții* **BG: Можете да СПЕЧЕЛИТЕ.** Има определени правила и условия* **LV: Tu vari LAIMĒT.** Ir spēkā noteikumi un nosacījumi.* **ET: Sul on võimalus VÕITA.** Kehtivad tingimused* **LT: Jūs galite LAIMĖTI.** Taikomos sąlygos*
**LEGO.com/productfeedback-terms*