



**SUPER
MARIO**™



72040







LEGO.com/sustainable-packaging



FR
DONNEZ
OU
RECYCLEZ

 OU  OU 

ASSOCIATION MAGASIN DÉCHÈTERIE

Adresses sur quefairedemesdechets.fr



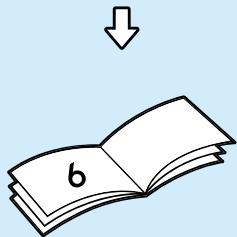
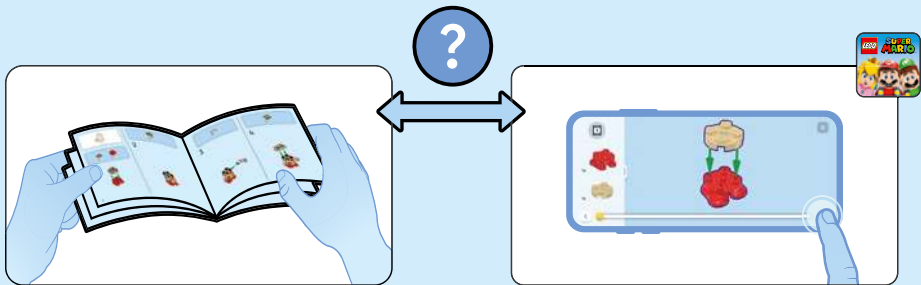

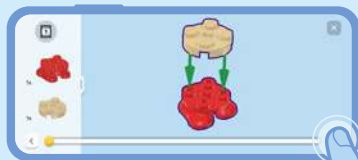

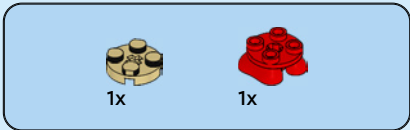

1

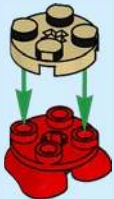

6

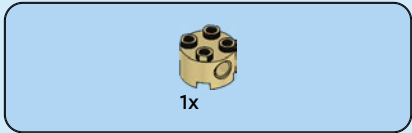

2





2x

3

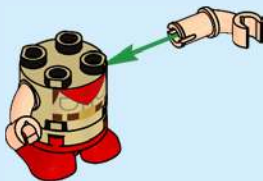

1x

4

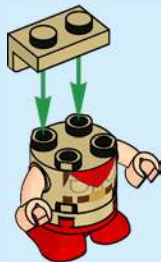



1x



1x

5



8



1x



2x

6





1x

7

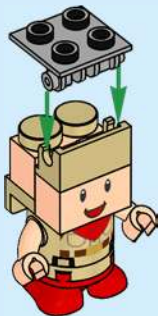

1x

8



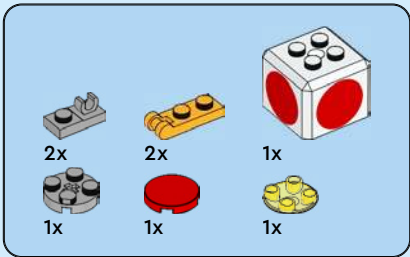

9

1



2



3



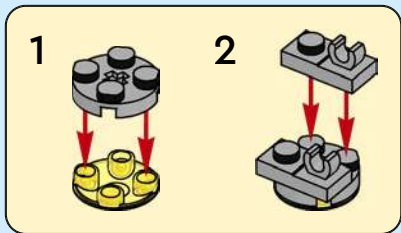

4

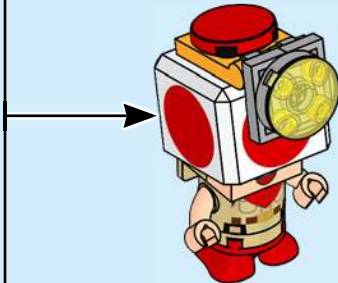

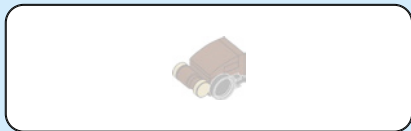

10

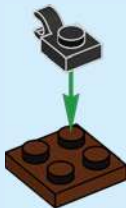

11

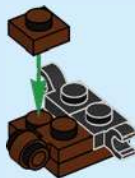



1x

12



14



2x

13

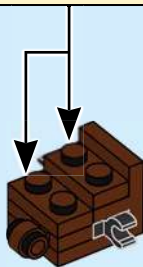



14

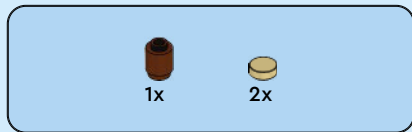

15

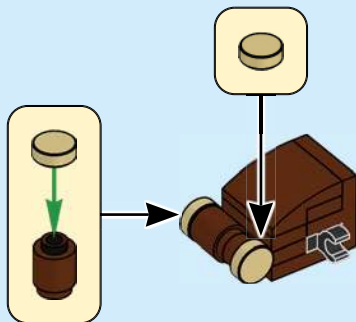

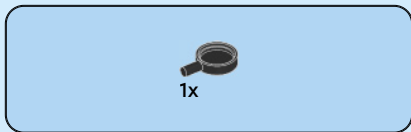

16



17

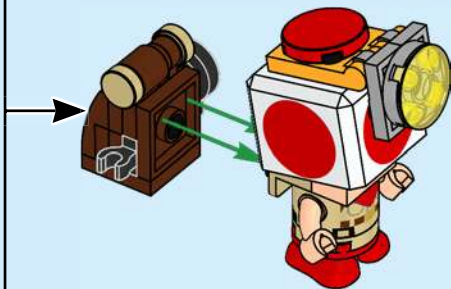

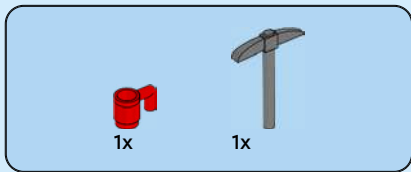

18



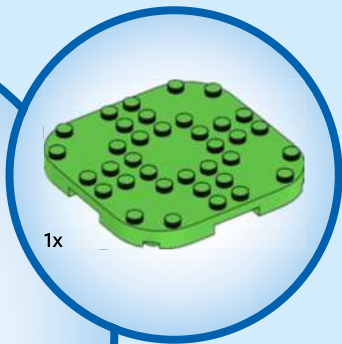
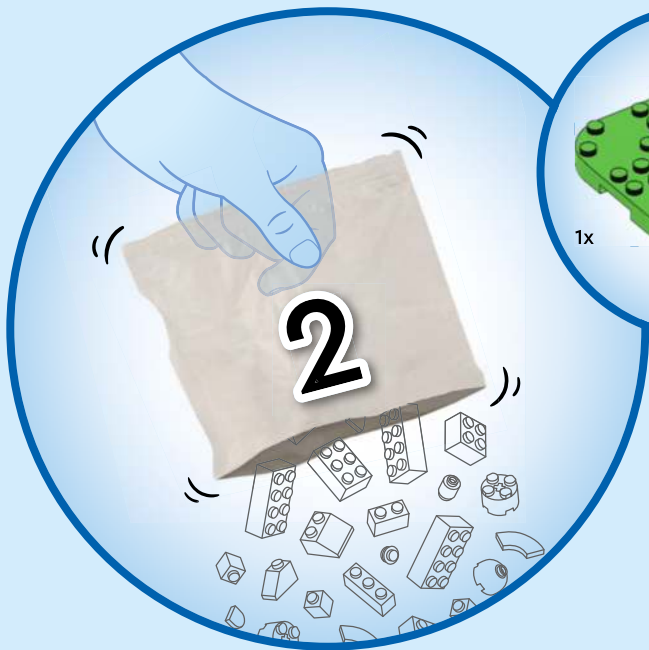

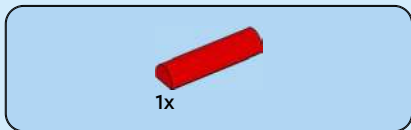
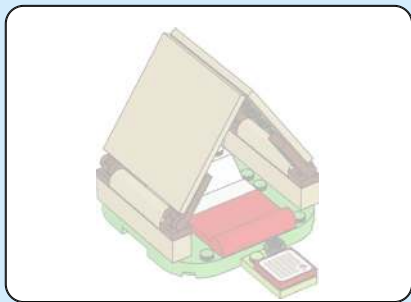

1

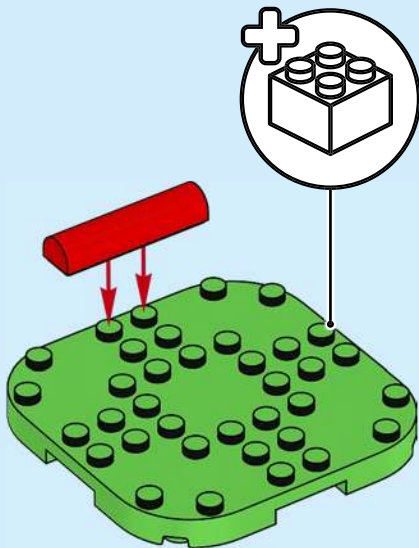

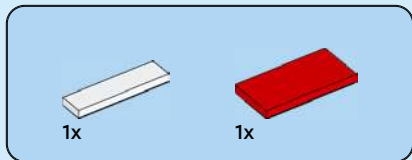

2

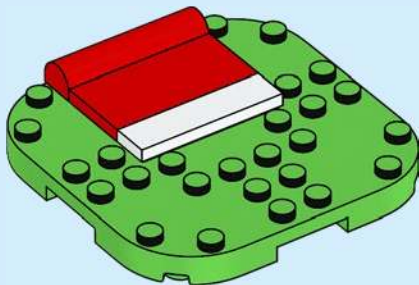

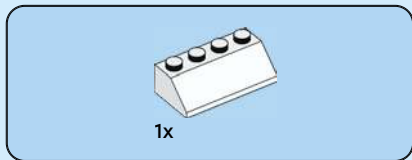

3

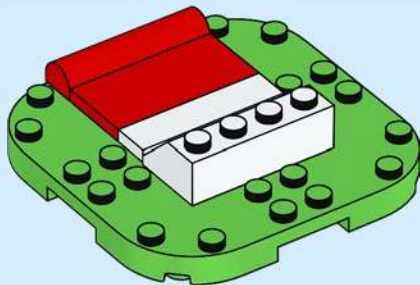

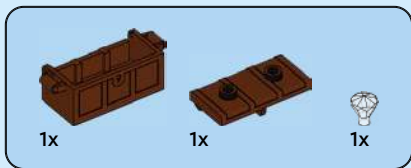

4

1

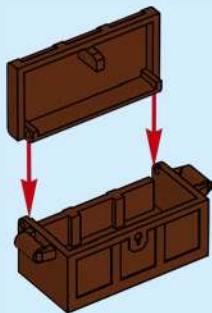

2

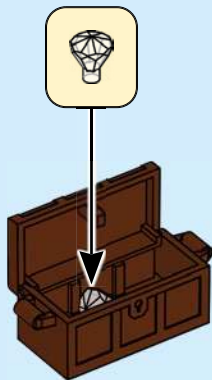

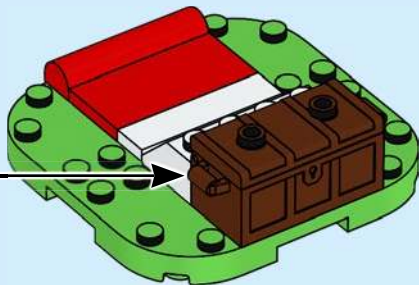

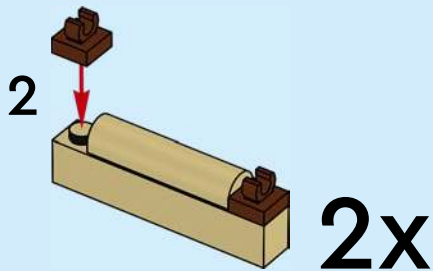
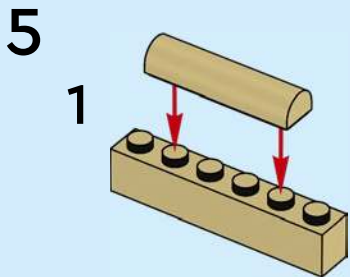
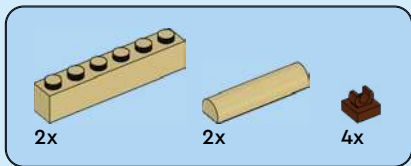
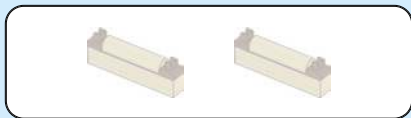

2x

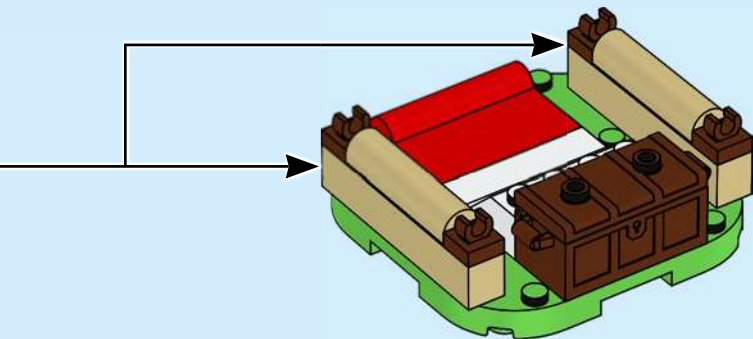

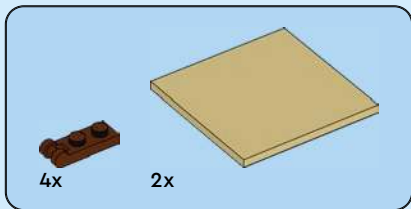
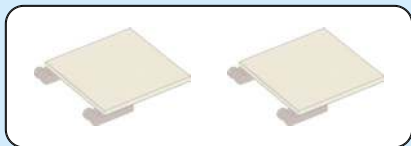

6

1

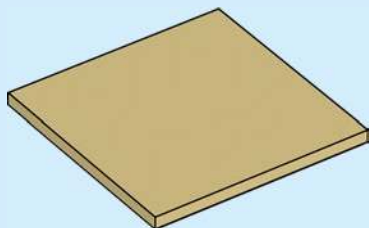

2

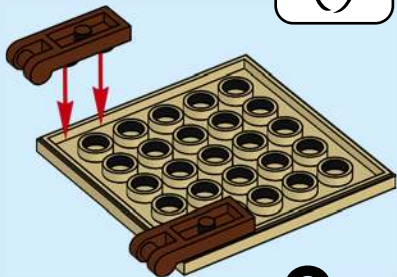

2x

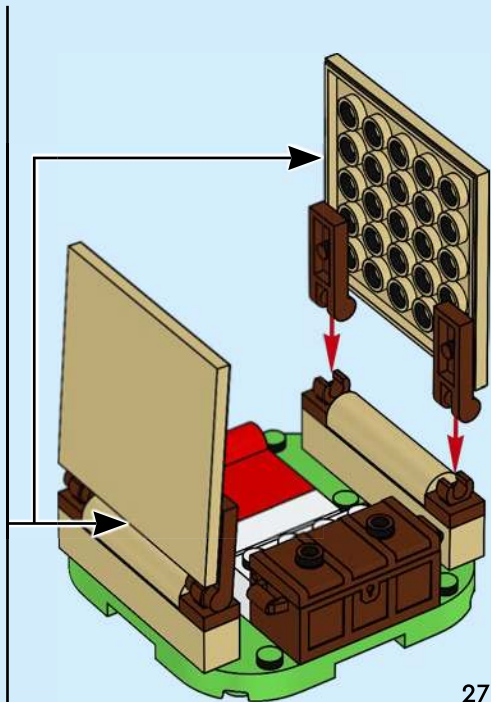

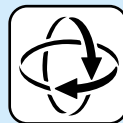
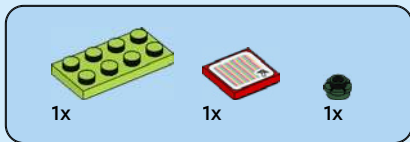

7

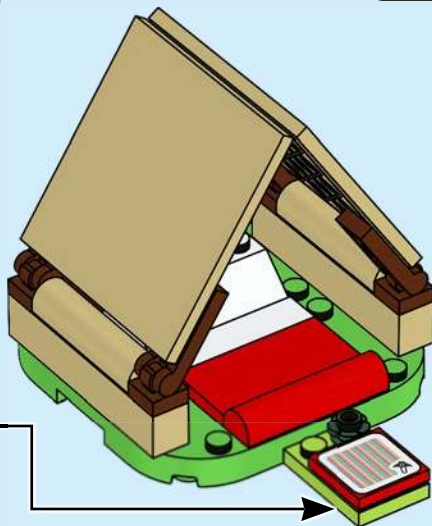
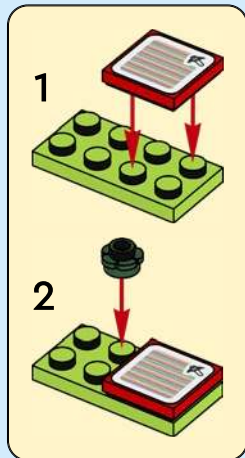

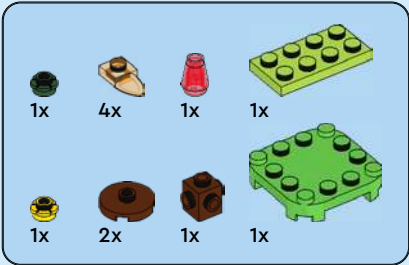

8



1

2

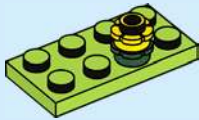

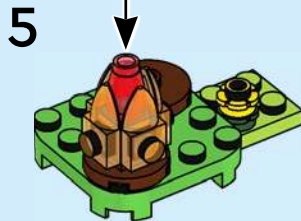
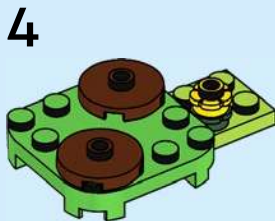
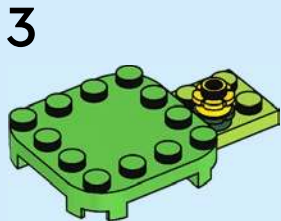
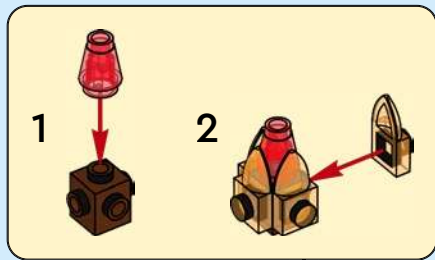

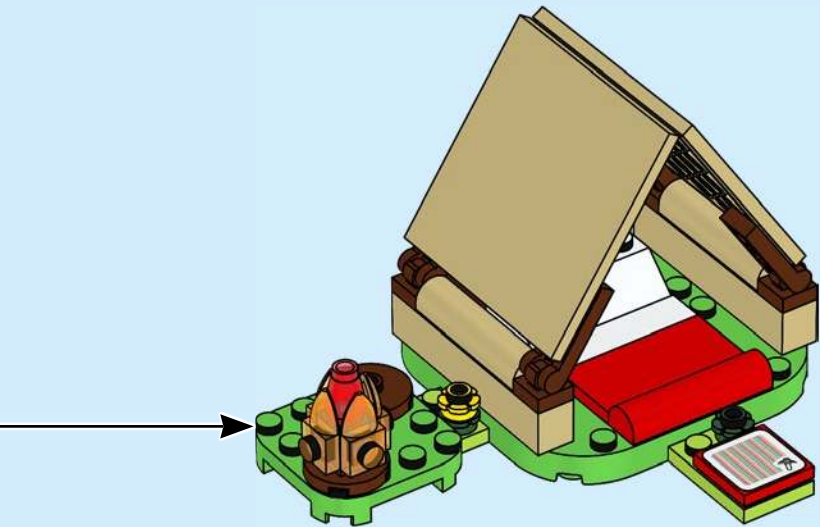





1x

1



2x

2

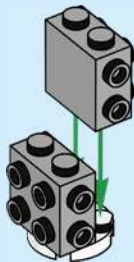



1x



1x

3

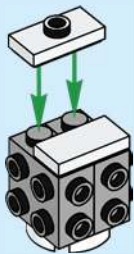

34



1x



1x

4





2x



2x

5

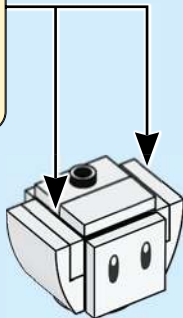
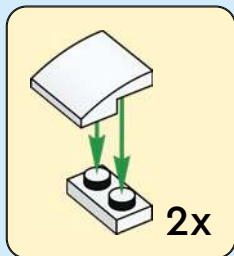

1x



1x

6

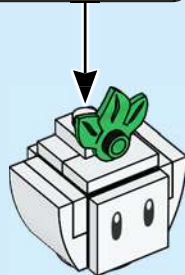
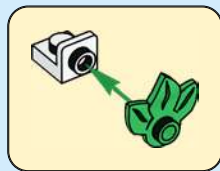

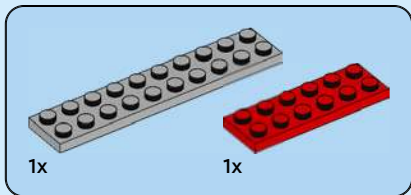
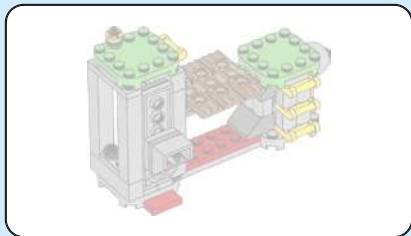

1

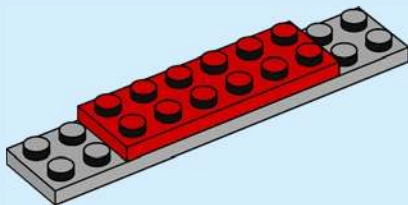

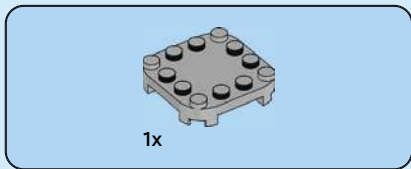

2

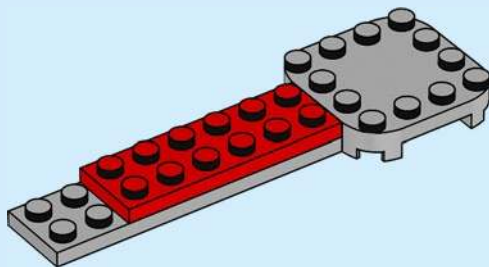



1x

3

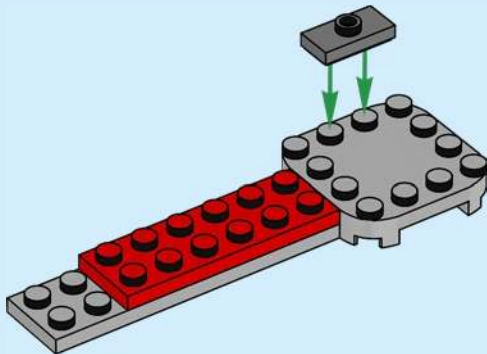



1x

4

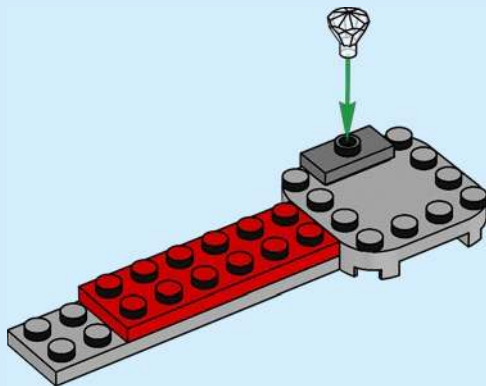

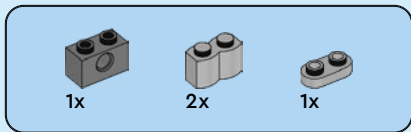

5

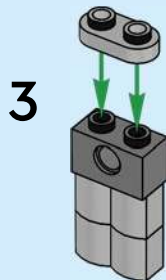
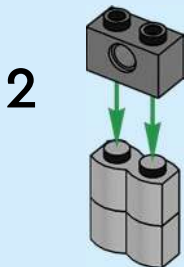
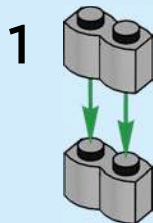

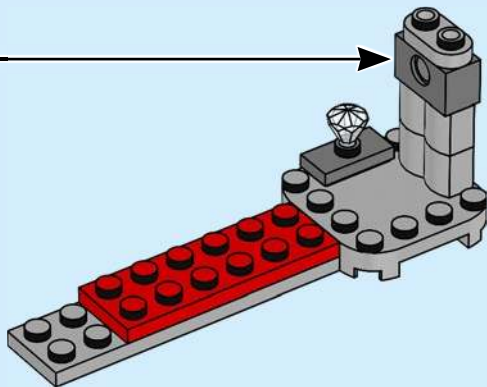

3x 2x 1x

6

1

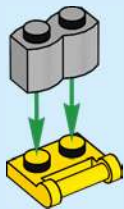

2

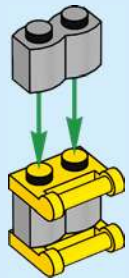

3



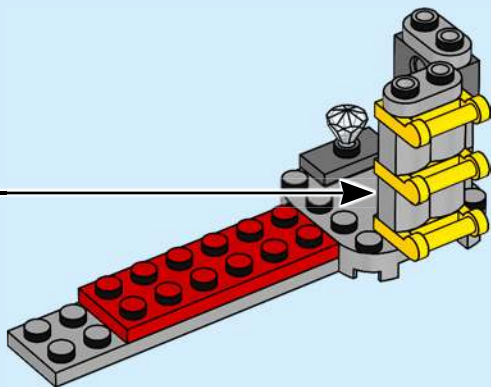

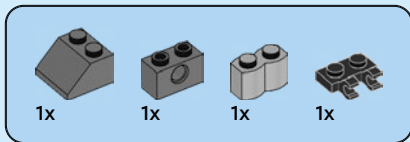

7

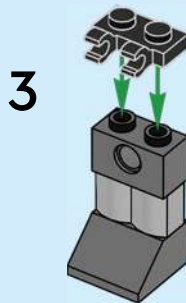
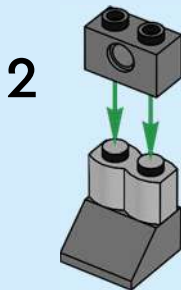
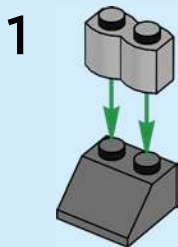

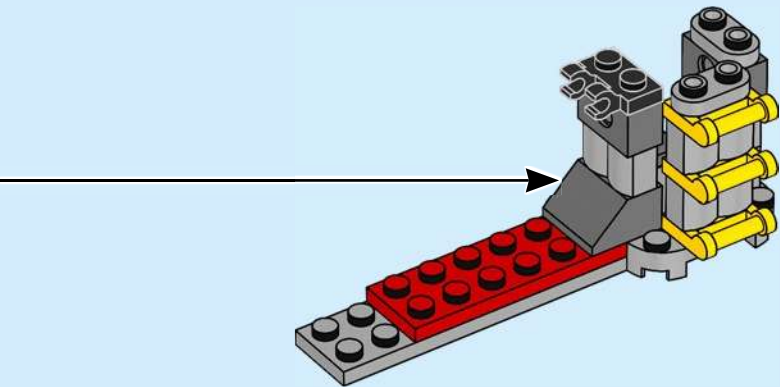



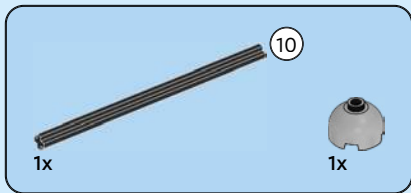

9

1

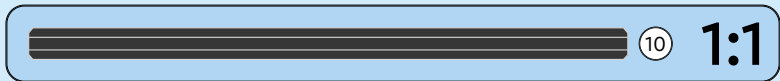

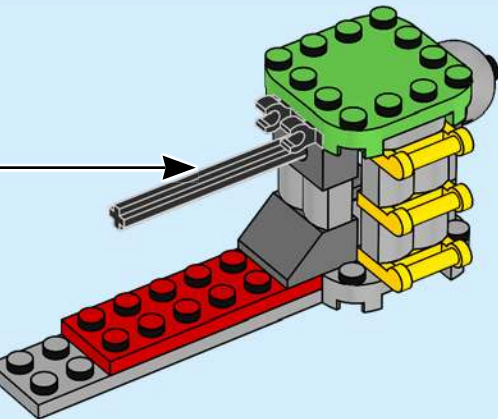

10

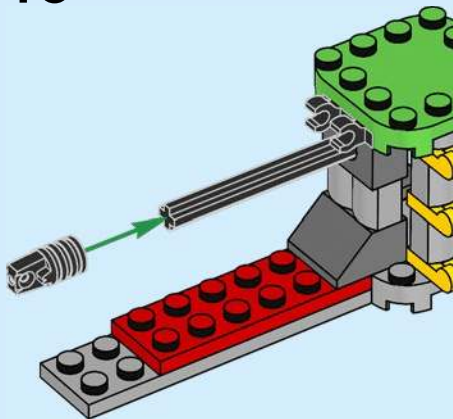

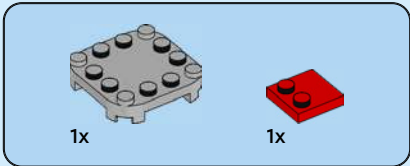
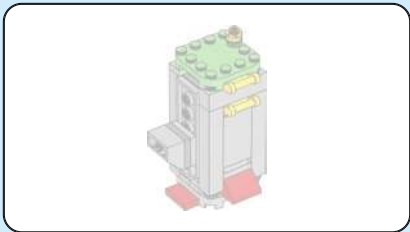

11

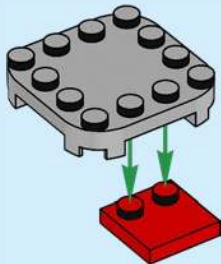



1x



1x

12

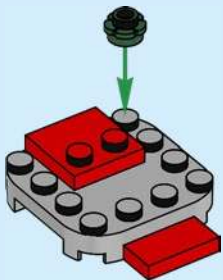

2x

13

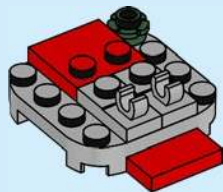



1x



1x

14

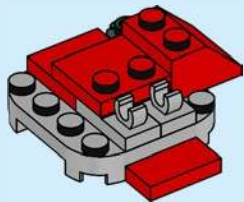

52



1x



1x

15

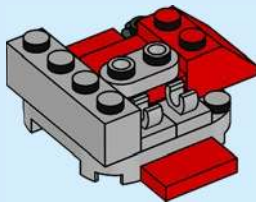



1x

16

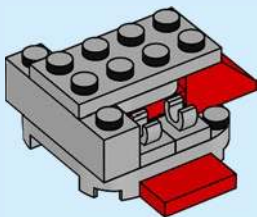

2x

17



2x

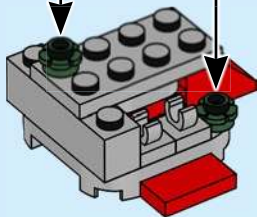

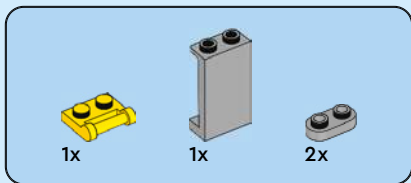

18

1

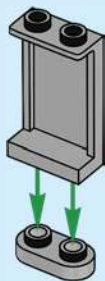

2



3



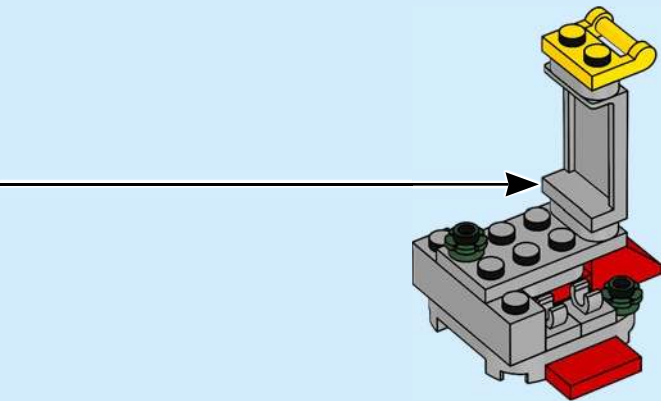

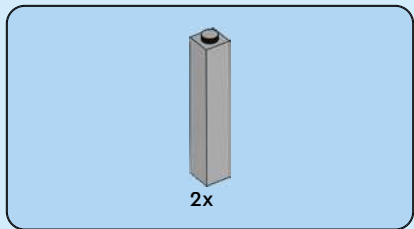

19

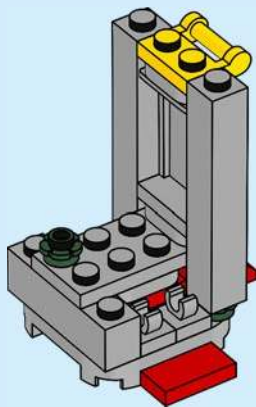

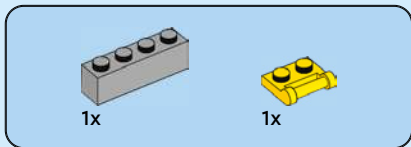

20

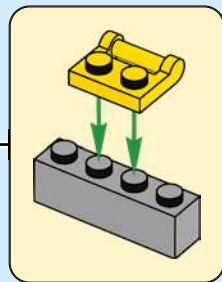
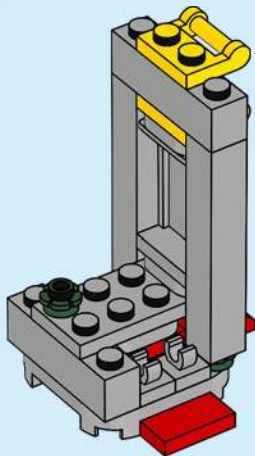

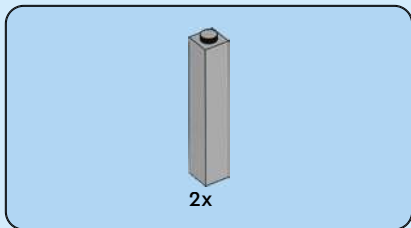

21

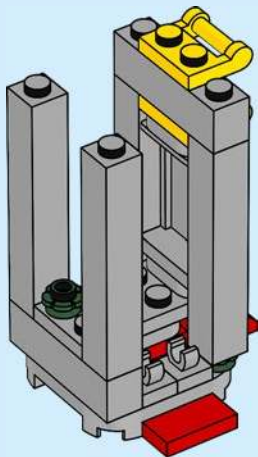

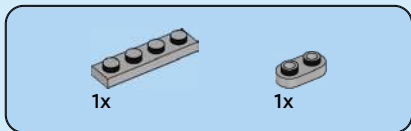

22

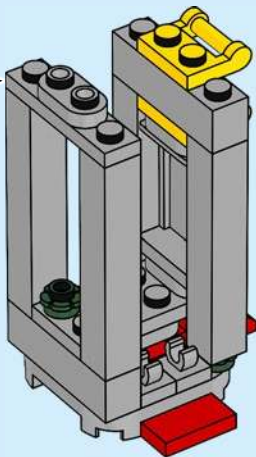
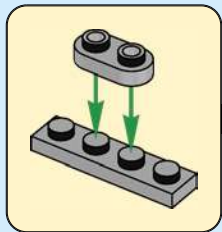

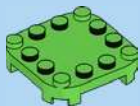

1x

23

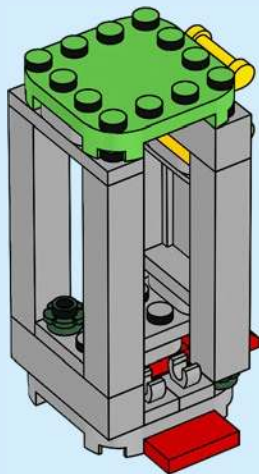



1x



1x

24

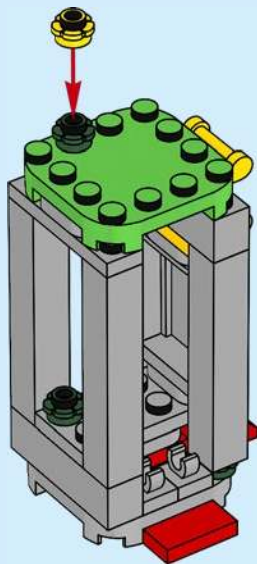

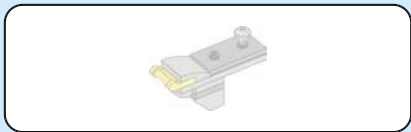

25

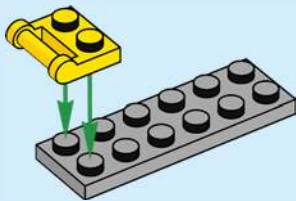



1x



1x

26

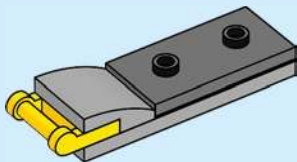

1x

27

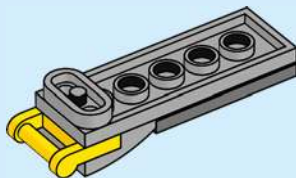

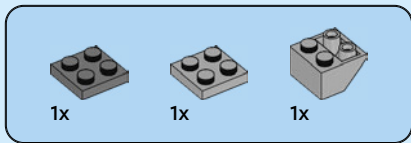

28

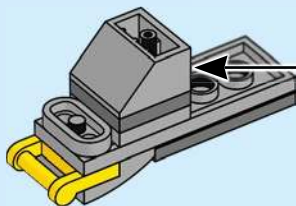
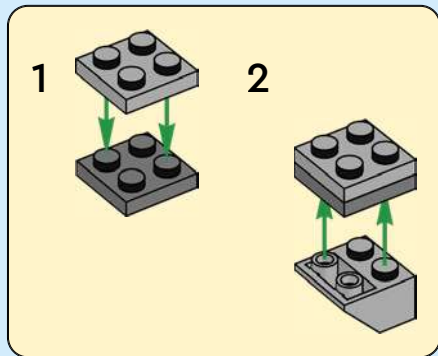



1x

29

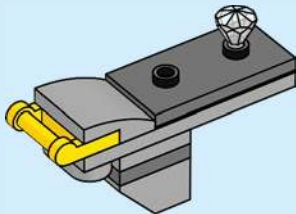

30

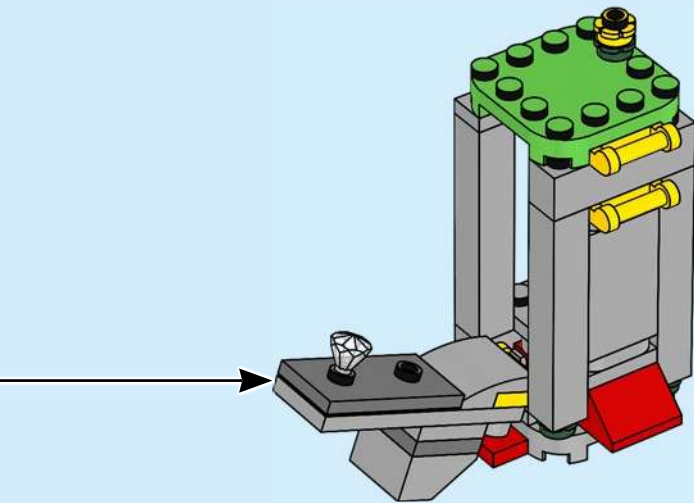

31

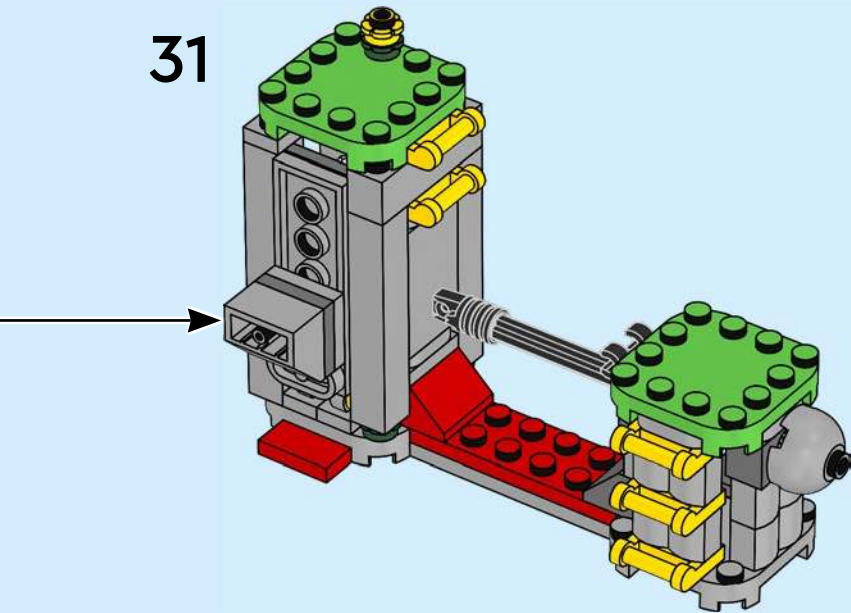



3x

32

1

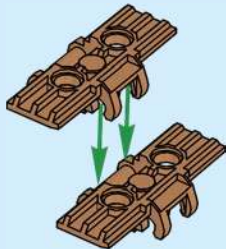

2

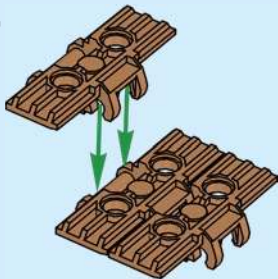

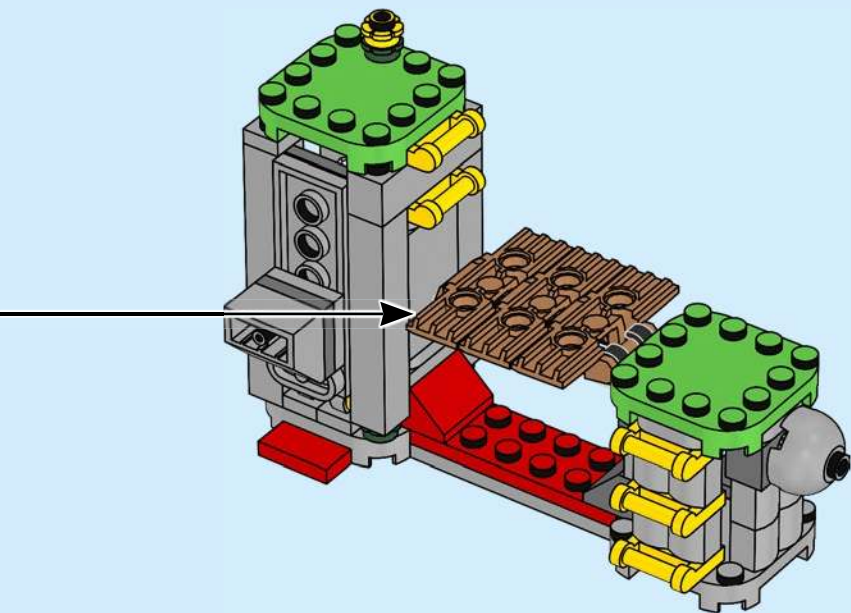



1x

1



2x

2

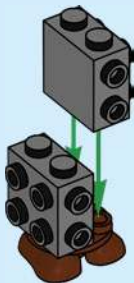



3

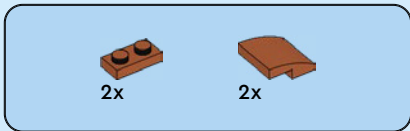
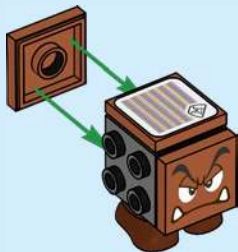

4

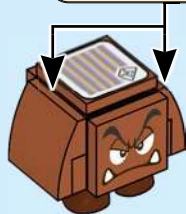
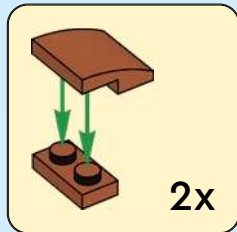

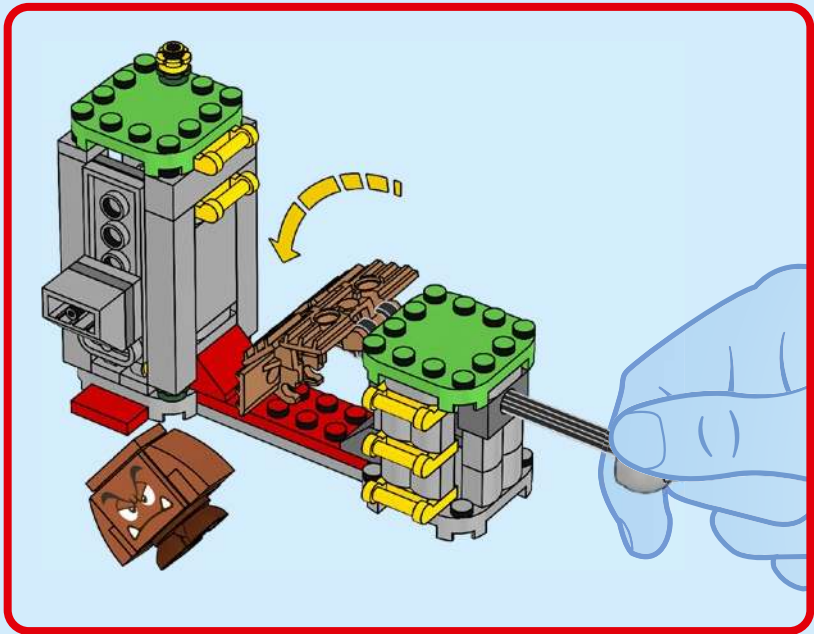





**UPDATE YOUR
INTERACTIVE FIGURE IN THE
LEGO® SUPER MARIO™ APP
TO BE READY TO PLAY**



Update your interactive figure in the LEGO® Super Mario™ app to be ready to play / Aktualisiere deine interaktive Figur in der LEGO® Super Mario™ App und das Spiel kann beginnen / Mets à jour ta figurine interactive dans l'appli LEGO® Super Mario™ avant de jouer / Aggiorna il tuo personaggio interattivo nell'app LEGO® Super Mario™ perché sia pronto per giocare / Actualiza tu figura interactiva en la app LEGO® Super Mario™ y prepárate para jugar / Atualiza a tua figura interativa na aplicação LEGO® Super Mario™ para começar a jogar / 在乐高®超级马力欧应用程序中更新你的交互式人偶，为玩乐做好准备 / Zaktualizuj swoją interaktywną figurkę w aplikacji LEGO® Super Mario™, aby przygotować ją do zabawy / Aktualizujte interaktivní figurku v aplikaci LEGO® Super Mario™, abyste se mohli pustit do hry / Aktualizujte interaktivnú figurku v aplikácii LEGO® Super Mario™, aby ste mohli pustiť do hrania / Frissítsd interaktív figurád a LEGO® Super Mario™ alkalmazásban és készülj fel a játékra! / Оновить свою інтерактивну фігурку в додатку LEGO® Super Mario™, щоб підготуватися до гри / Actualizează-ți figurina interactivă în aplicația LEGO® Super Mario™ pentru a fi gata de joacă / Актуалізуйте інтерактивну фігуру в додатку LEGO® Super Mario™, за да сте готови за гру / Atjaunini savu interaktīvo figūru LEGO® Super Mario™ lietotnē, lai būtu gatavs rotaļāties / Vārskenda oma interaktiivset figuuri rakenduses LEGO® Super Mario™, et alla mängimiseks valmis / Atnaujinkite interaktyvią figūrėlę programėlėje „LEGO® Super Mario™“ ir pasiruoškite žaisti



LEGO® Super Mario™ app /
LEGO® Super Mario™ App / Appli LEGO®
Super Mario™ / App LEGO® Super Mario™ / Aplicação
LEGO® Super Mario™ / 乐高®超级马力欧™应用程序 /
Aplikacja LEGO® Super Mario™ / Aplikace LEGO®
Super Mario™ / Aplikácia LEGO® Super Mario™ /
LEGO® Super Mario™ alkalmazás / Додаток LEGO®
Super Mario™ / Aplicația LEGO® Super Mario™ /
Приложение LEGO® Super Mario™ / Lietotne LEGO®
Super Mario™ / LEGO® Super Mario™ rakendus /
Programèlè „LEGO® Super Mario™“



[LEGO.com/super-mario-trouble-shooting-guide](https://www.lego.com/super-mario-trouble-shooting-guide)

**DISCOVER MORE
ABOUT YOUR SET
IN THE APP**



Entdecke in der App noch mehr über dein Set
Découvre plus de détails sur ton set dans l'appli
Scopri di più sul tuo set nell'app
Descubre más acerca de tu set en la app
Conhece melhor o teu set na aplicação
可通过应用程序了解更多关于此套装的信息
Dowiedz się więcej sprawdzając w aplikacji
Zjistěte více o své stavebnici v aplikaci
Zisti viac o svojej stavebnici v aplikácii
Tudj meg többet a készletről az alkalmazásban!
Дізнайтеся більше про свій набір у додатку
Descoperă mai multe despre setul tău în aplicație
Открийте повече за комплекта в приложението
Atklāj vairāk par komplektu lietotnē
Avasta oma komplekti kohta lisateavet rakendusest
Sužinokite daugiau apie rinkinį programėlėje





72041



72040



72042



72040



72041



72042

**ADD SET FOR
INTERACTIVE
PLAY**



71439

Set hinzufügen, um interaktiv
zu spielen

Ajoute un set pour le jeu interactif

Aggiungi il set per il gioco interattivo

Juego interactivo con estos sets

Adiciona um set para um jogo interativo

添加套装, 进行交互式玩乐

Dodaj zestaw do interaktywnej zabawy

Přidat set pro interaktivní hru

Pridat' stavebnicu pre interaktivnu hru

Add hozzá a készletet az interaktív játékhöz!

Додайте набір для інтерактивної гри

Adaugă setul pentru joacă interactivă

Добавте настройка за интерактивна игра

Pievieno komplektu interaktīvām rotaļām

Lisa komplekt interaktīvseks māngimiseks

Pridėkite rinkinį interaktyviam žaidimui



71440



72041



71439

OR









































































71440

OR



71441

ODER / OU / OPPURE / O / 或 / LUB / NEBO / ALEBO / VAGY / АБО / SAU / ИЛИ / VAI / VÕI / ARBA

| | | | | | | | |
|--|---|---|---|---|---|--|---|
|  |  |  |  |  |  |  |  |
| 1x 6242241 | 1x 243101 | 1x 6174919 | 1x 6066342 | 2x 6308000 | 2x 4570877 | 1x 6133765 | |
|  |  |  |  |  |  |  | |
| 1x 6051511 | | | 1x 6564525 | 1x 6265699 | 2x 6104344 | 2x 6102360 | 4x 4211362 |
|  |  |  |  |  |  |  |  |
| 1x 306901 | 1x 303701 | 2x 6375672 | 1x 6330891 | 1x 452826 | 1x 6422412 | 2x 4211150 | 7x 6248890 |
|  |  |  |  |  |  |  |  |
| 2x 302301 | 1x 6482842 | 2x 4112982 | 3x 6219819 | 1x 6581773 | 1x 6315663 | 1x 6146858 | 1x 6429052 |
|  |  |  |  |  |  |  |  |
| 1x 403201 | 4x 6284573 | 2x 4537936 | 1x 303921 | 6x 6446790 | 1x 6186423 | 1x 6300006 | 4x 6326078 |
|  |  |  |  |  |  |  |  |
| 2x 6047220 | 1x 6540200 | 1x 379521 | 1x 389921 | 4x 6514064 | 4x 6348057 | 4x 6102975 | 5x 4550325 |
|  |  |  |  |  |  |  |  |
| 1x 6564580 | 1x 6249809 | 1x 4560179 | 2x 6299813 | 2x 6248671 | 1x 4221744 | 1x 4216695 | 1x 4211475 |
|  |  |  |  |  |  |  |  |
| 1x 6540201 | 1x 4140562 | 1x 6534946 | 6x 4501232 | 3x 6513976 | 1x 6347749 | 2x 4216695 | 1x 4211475 |
|  |  |  |  |  |  |  |  |
| 82 | | | | 1x 6514021 | 1x 4211183 | 1x 6290983 | 1x 4211397 |



1x
4585429



1x
6102357



1x
4211881



1x
6435857



2x
6301870



1x
4211445



1x
4211395



2x
4211394



2x
6294703



1x
4211452



1x
6307616



1x
6092572



2x
4211111



1x
4211094



2x
6314192



1x
4211054



1x
4211007



2x
6297281



1x
6540199



1x
6369189



1x
6310268



1x
6377651



1x
4533101



3x
6442980



2x
6543652



1x
6229130



3x
6308875

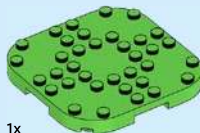

1x
6301641

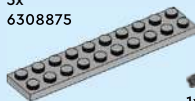

1x
4211462



1x
373726

10



LEGO.com/service

YOU COULD **WIN**



Scan this QR code or go to
LEGO.COM/PRODUCTFEEDBACK and give us
your short feedback about this LEGO® set
for a chance to win a cool LEGO prize.

Terms and Conditions apply*

EN: YOU COULD WIN. Terms and Conditions apply* **DE: Du könntest GEWINNEN.** Es gelten die Teilnahmebedingungen* **FR: Tu pourrais GAGNER.** Des conditions s'appliquent* **IT: Potresti VINCERE tu.** Termini e condizioni sono applicabili* **ES: Puedes GANAR.** Aplican términos y condiciones* **PT: PODERÁ GANHAR.** Aplicam-se Termos e Condições* **ZH: 轻松获奖.** 条款和条件适用* **PL: Szansa na WYGRANA.** Obowiązuje regulamin* **CS: Máte šanci VYHRÁT.** Platí všeobecné smluvní podmínky* **SK: Máte šancu VYHRÁT.** Platia všeobecné zmluvné podmienky* **HU: TE IS NYERHETSZ.** Felhasználási feltételek érvényesek* **UA: ВИ МОЖЕТЕ ВИГРАТИ.** Застосовуються загальні положення та умови* **RO: Ai putea CÂȘTIGA.** Se aplică termeni și condiții* **BG: Можете да СПЕЧЕЛИТЕ.** Има определени правила и условия* **LV: Tu vari LAIMĒT.** Ir spēkā noteikumi un nosacījumi.* **ET: Sul on võimalus VÕITA.** Kehtivad tingimused* **LT: Jūs galite LAIMĖTI.** Taikomos sąlygos*

*[LEGO.com/productfeedback-terms](https://www.lego.com/productfeedback-terms)

LEGO, the LEGO logo and the Brick and Knob configurations are trademarks and/or copyrights of the LEGO Group.

©2025 The LEGO Group.

© Nintendo



6596790