



# STAR WARS™

75411





Q LEGO® Builder



[LEGO.com/sustainable-packaging](https://LEGO.com/sustainable-packaging)



**FR**  
**DONNEZ**  
OU  
**RECYCLEZ**

 OU  OU 

ASSOCIATION    MAGASIN    DÉCHÈTERIE

Adresses sur [quefairedemesdechets.fr](https://quefairedemesdechets.fr)



Q LEGO® Builder

# BUILDER



Apple and the Apple logo are trademarks of Apple Inc., registered in the U.S. and other countries and regions. App Store is a service mark of Apple Inc. Google Play and the Google Play logo are trademarks of Google LLC. Tencent and the Tencent logo are trademarks of Tencent Inc.

Q [LEGO.com/devicecheck](https://www.lego.com/devicecheck)

**EN** Ask parents' permission before going online | **DE** Eltern um Erlaubnis bitten, bevor du online gehst | **FR** Demande l'autorisation d'un parent avant d'aller en ligne | **IT** Chiedi il permesso ai tuoi genitori prima di andare online | **ES** Pídeles permiso a tus papás antes de conectarte a Internet | **PT** Pede autorização aos pais antes de acederes online | **ZH** 上网前应先征得父母的同意 | **PL** Poproś rodziców o zgodę, zanim wejdiesz do Internetu | **CS** Než půjdeš na internet, požádej rodiče o svolení | **SK** Skôr než pôjdeš na internet, vypýtaj si povolenie od rodičov | **HU** Kérj szülői engedélyt, mielőtt online csatlakoznál! | **UA** Запитуйте дозволу батьків, перш ніж користуватися інтернетом | **RO** Cere permisiunea părinților înainte de a te conecta online | **BG** Поискайте разрешение от родител, преди да влезете онлайн | **LV** Pirms došanās tiešsaistē palūdz atļauju vecākiem | **ET** Enne Interneti kasutamist küsi vanematelt luba | **LT** Prieš prisijungdami prie interneto, atsiklauskite tėvų





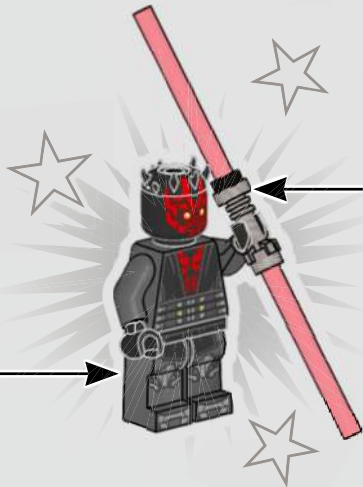
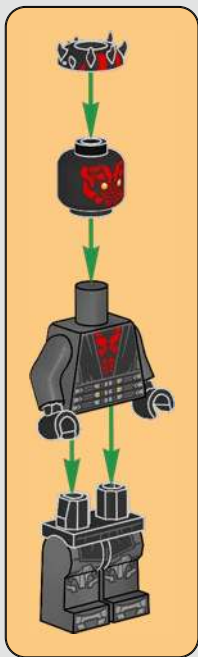

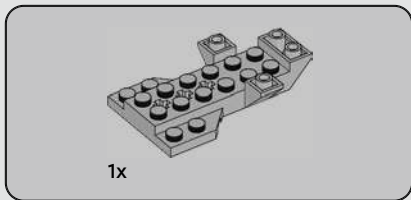

1

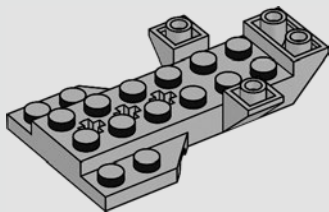

6





1x

2

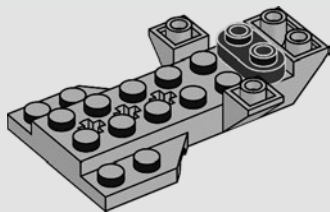

1x

3

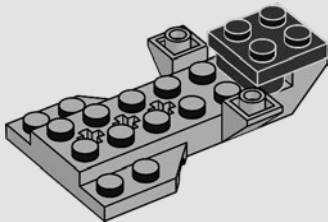



2x

4

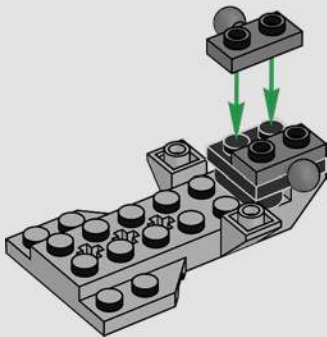

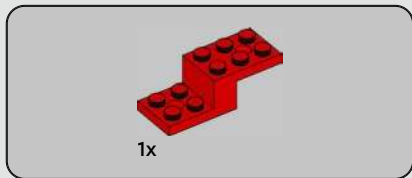

5

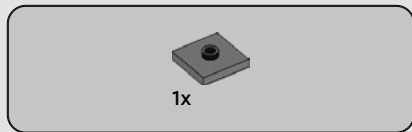
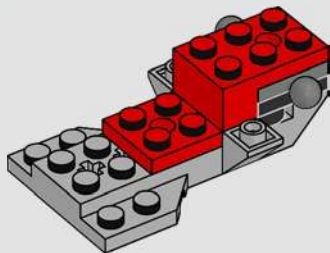

6

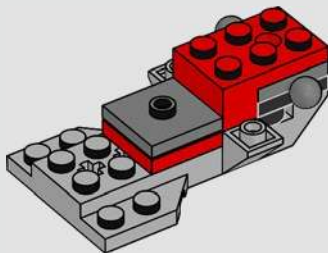



2x

7

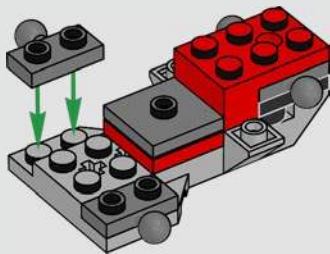

10



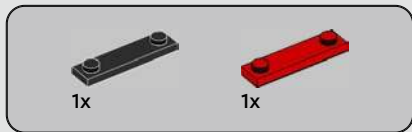

8

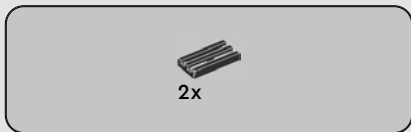
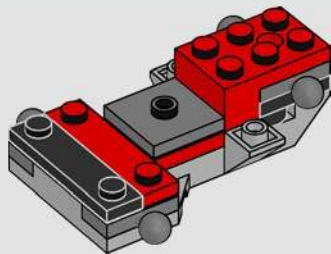

9

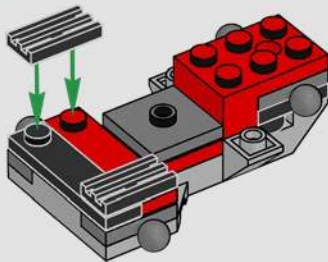



2x

# 10

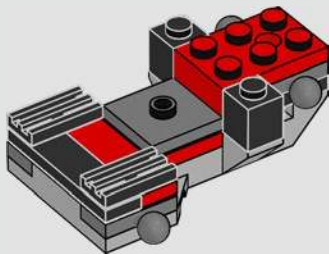



1x

11

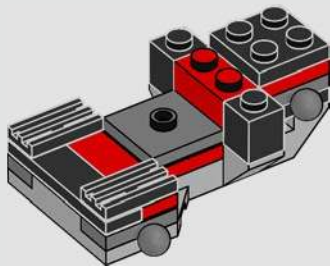

1x

12

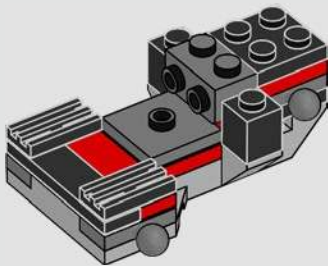



1x

# 13

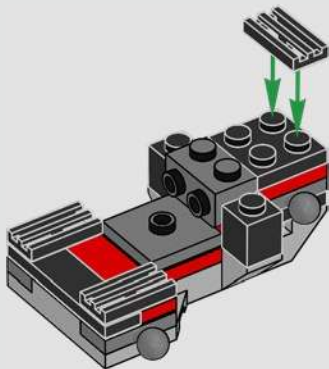

14





1x

14

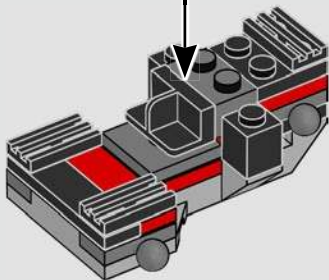

2x

15

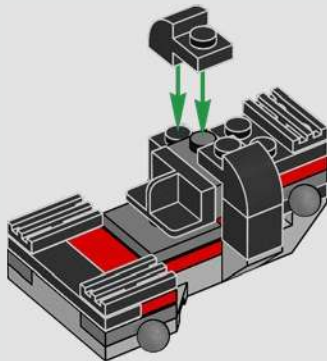



1x

# 16

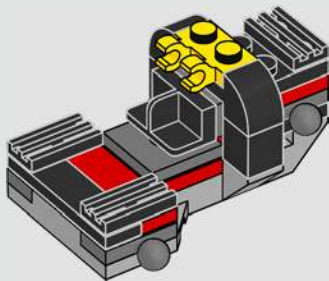



2x

17

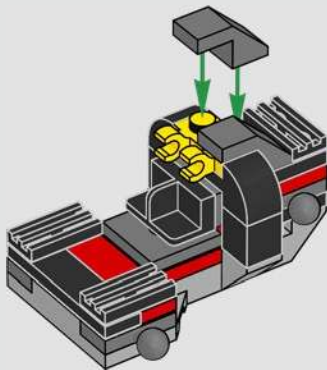

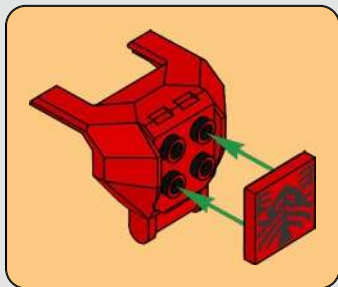
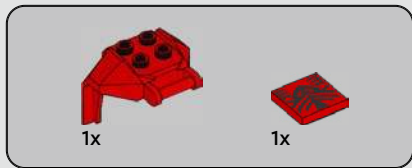

18

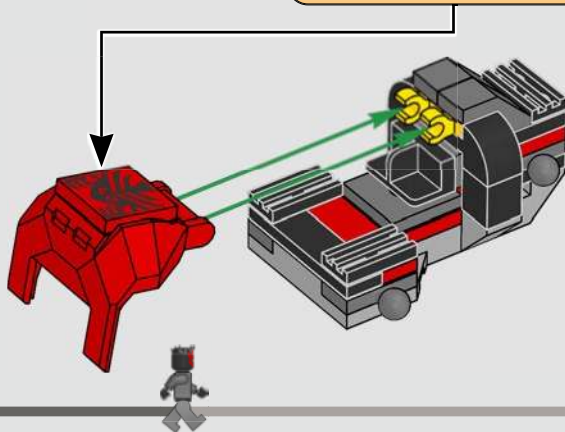

18



1x

19

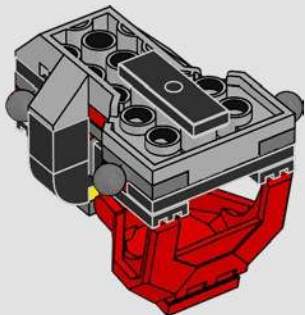
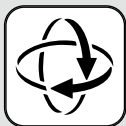

1x

20

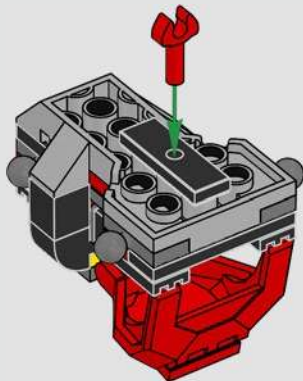



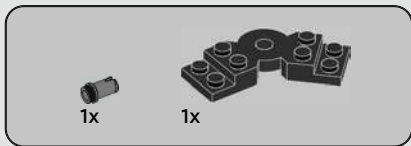
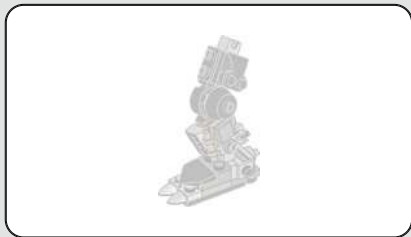

21

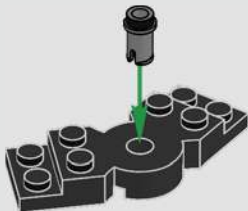



1x

# 22

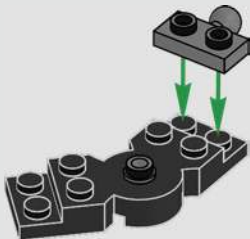

22





1x



1x

# 23

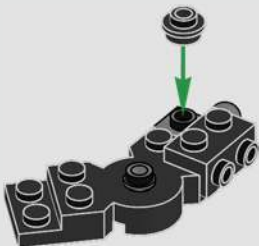

1x

# 24





1x

25

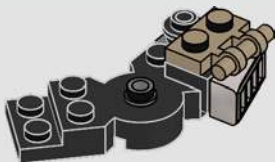

24





1x

26

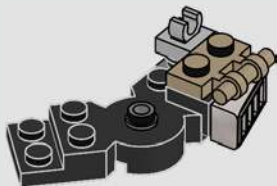

1x

27

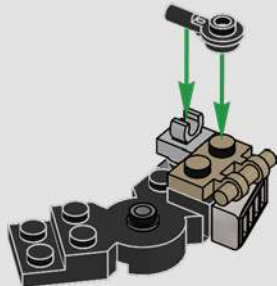





1x

29

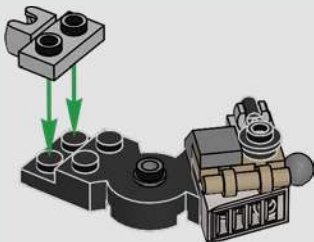

1x

30

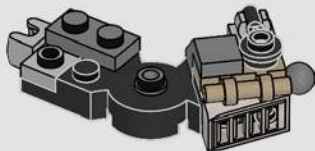



1x

# 31

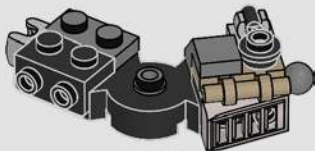

28





1x

32

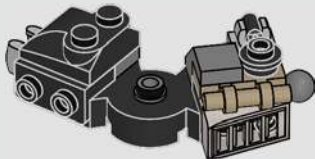

1x

33

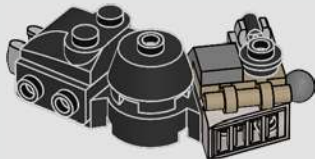



1x

# 34

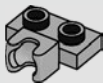

30





2x

35

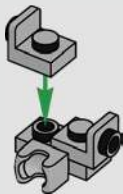

1x

36

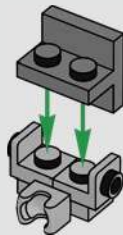



1x



1x

# 37

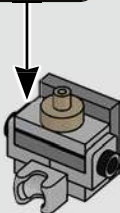
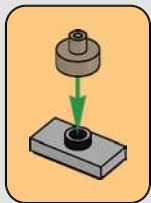

32





1x



1x

# 38

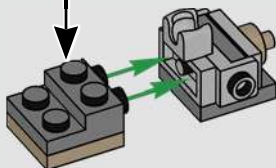
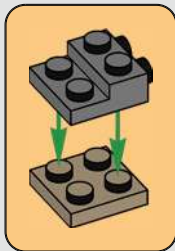



1x

39

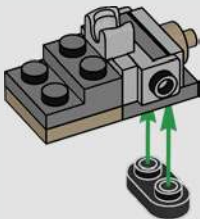

34



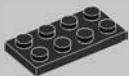

1x

40

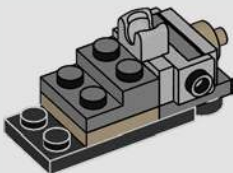

2x

41

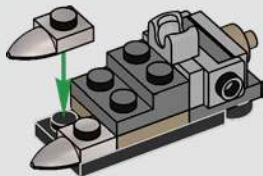



1x

# 42

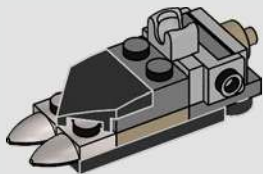

43

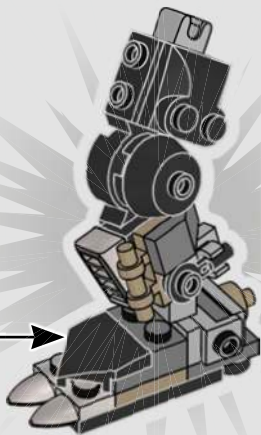

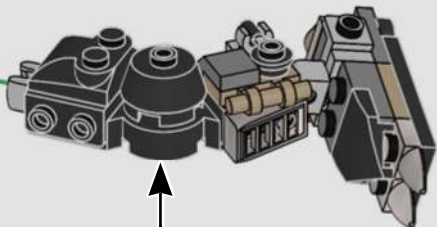
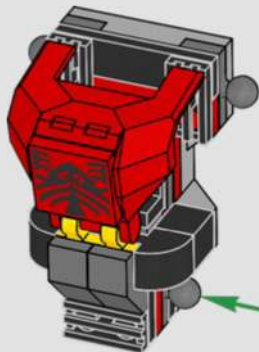

44



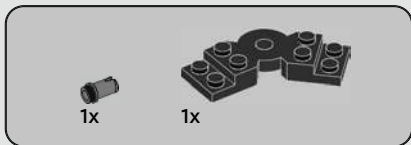

45

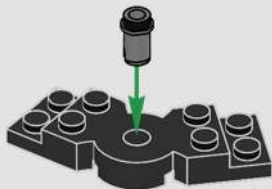



1x

# 46





1x

47

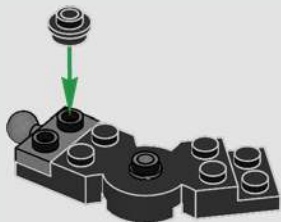

1x

48





1x

49

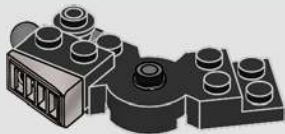



1x

50

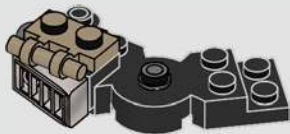

1x

51

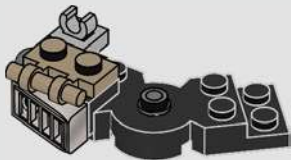



1x

# 52

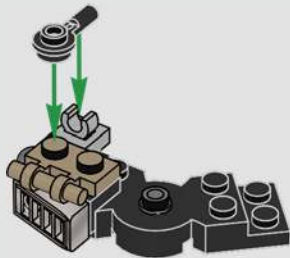



1x

53

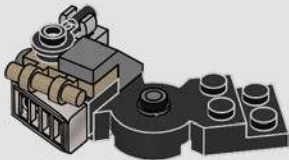

1x

54

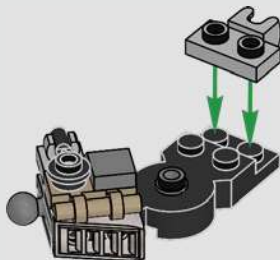



1x

55

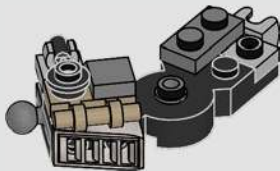



1x

56

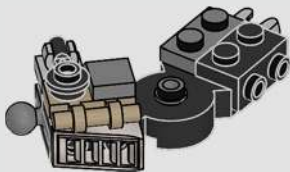

1x

57





1x

58





1x

59

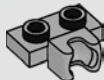

2x

60

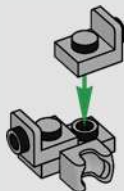



1x

# 61

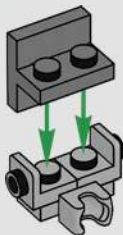

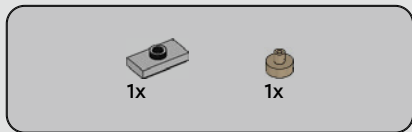

62

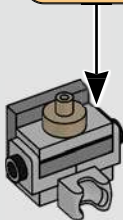
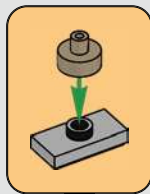



1x



1x

# 63

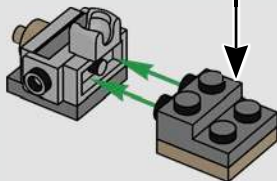
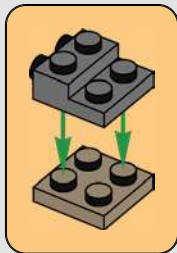



1x

64

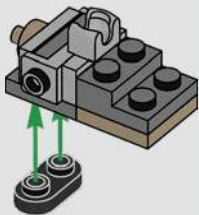

1x

65

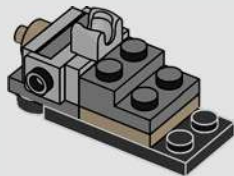



2x

66

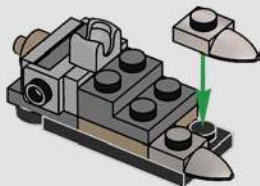



1x

67

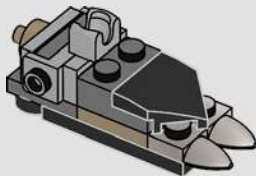

68

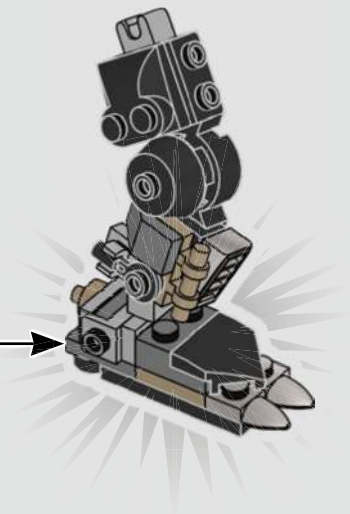

69

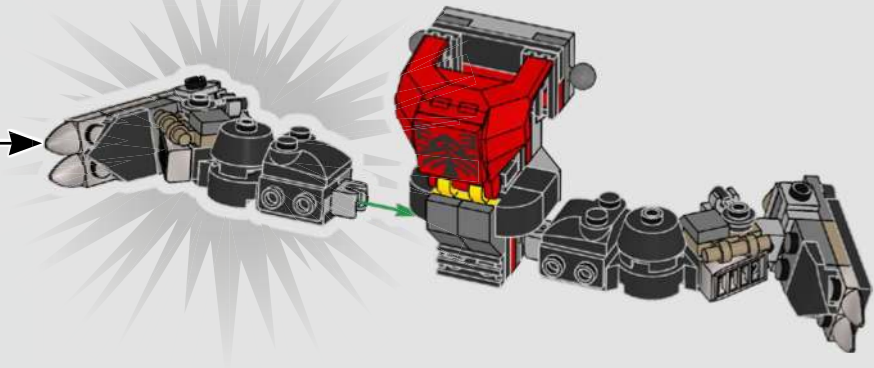



2x

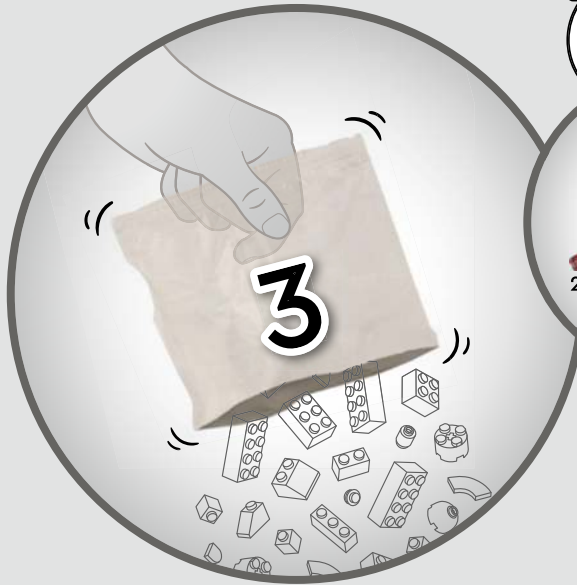

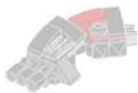

1x

70





1x

71





1x

72

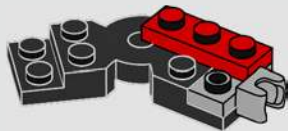

1x

73

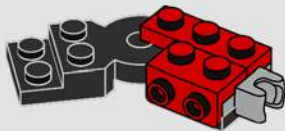



1x



1x

# 74





1x



1x

# 75

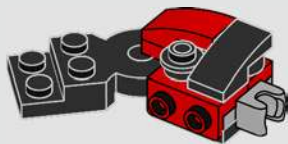

2x

# 76

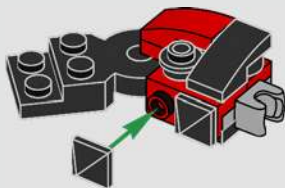



1x

77







1x

80





2x

81

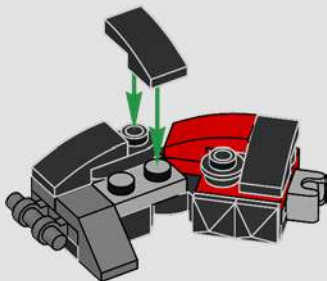

1x

82

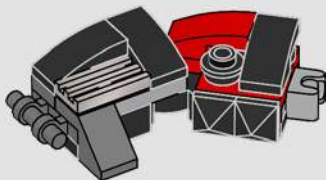



3x

# 83

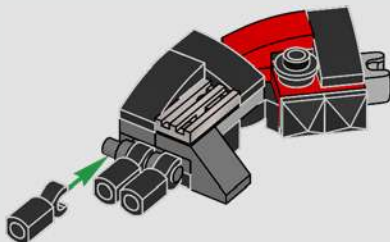



84

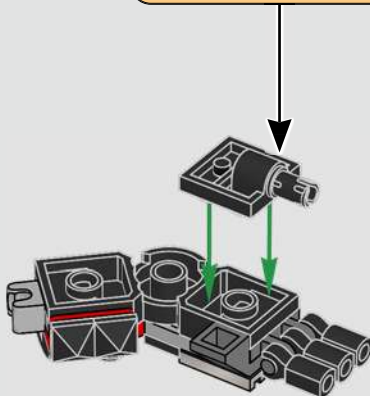
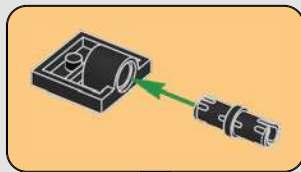

85

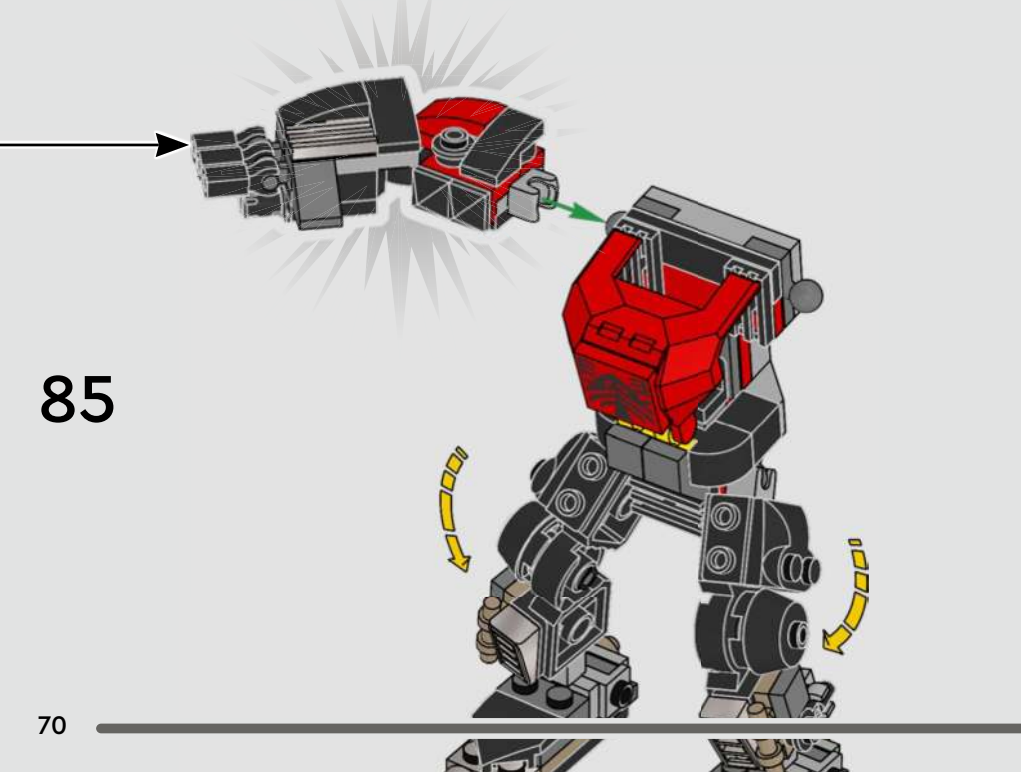



1x

86

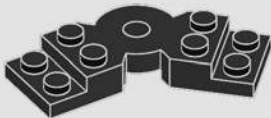



1x

87





1x

88

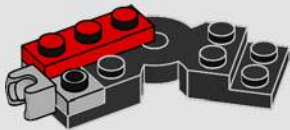

1x

89





1x



1x

# 90





1x



1x

# 91



2x

# 92

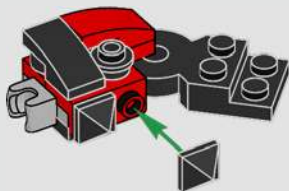



1x

93

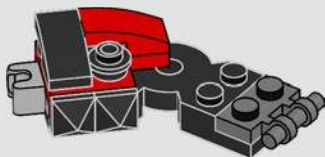



1x



1x

94

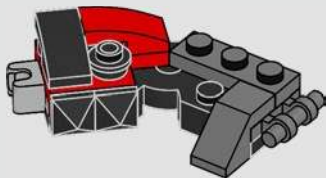

1x

95

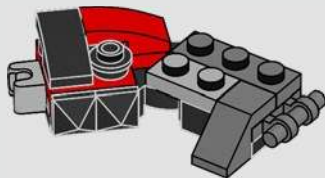



1x

96

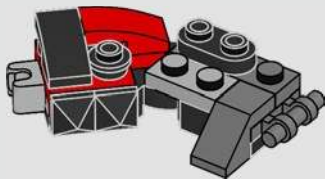



2x

97

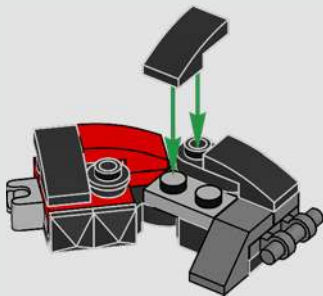

1x

98

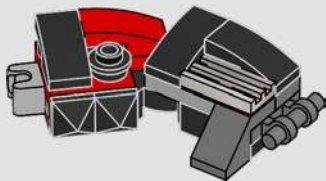



3x

99

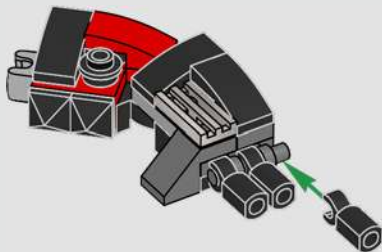

100

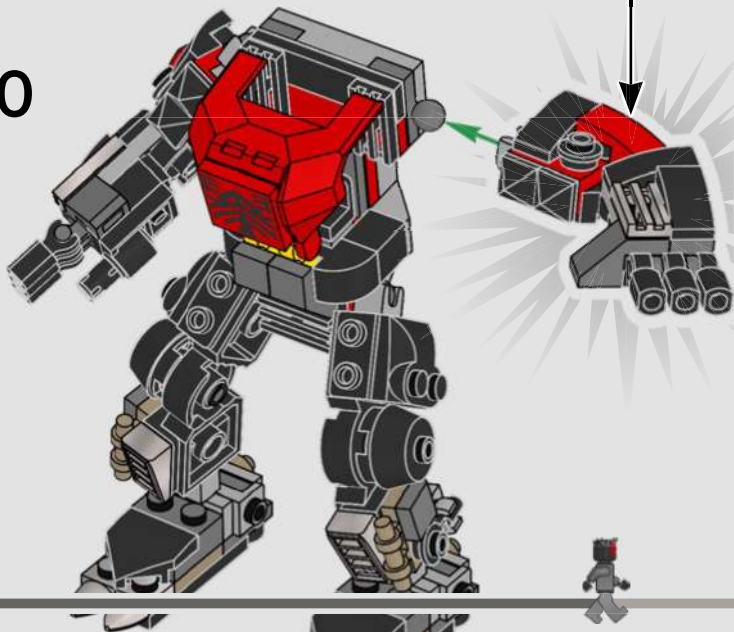



1x



1x



1x



1x



1x

# 101

1

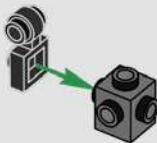

2



3

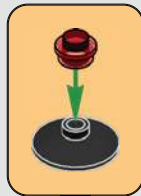
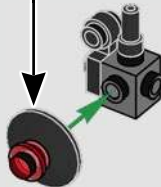

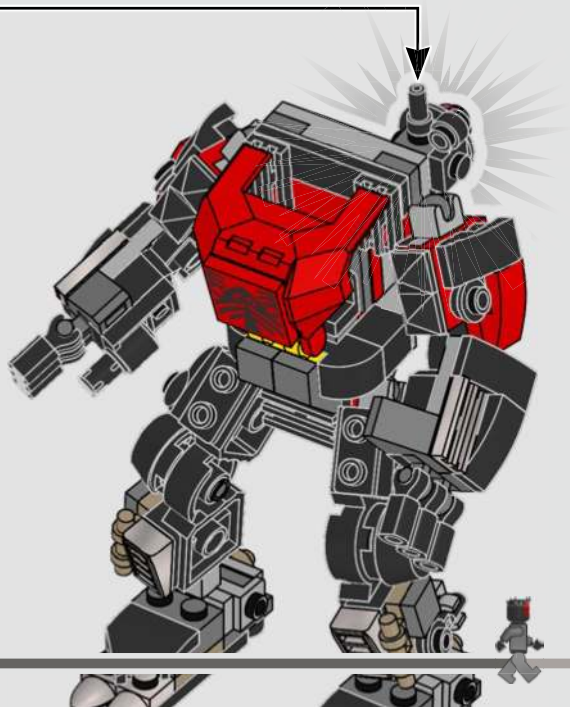

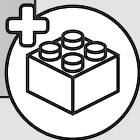
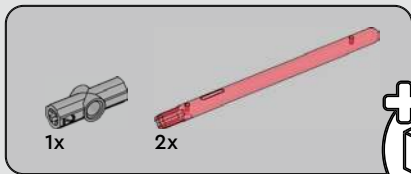

102

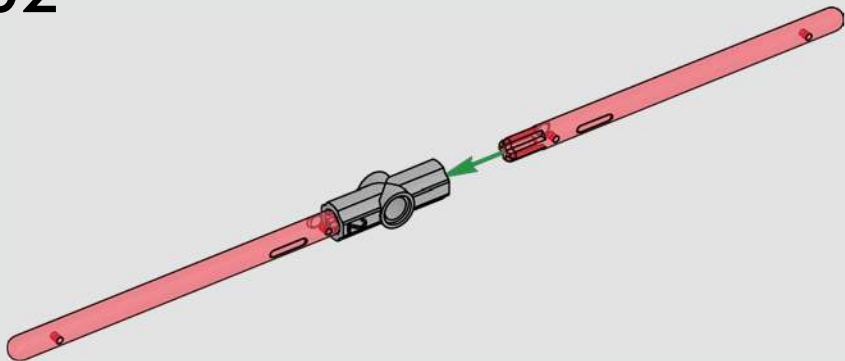

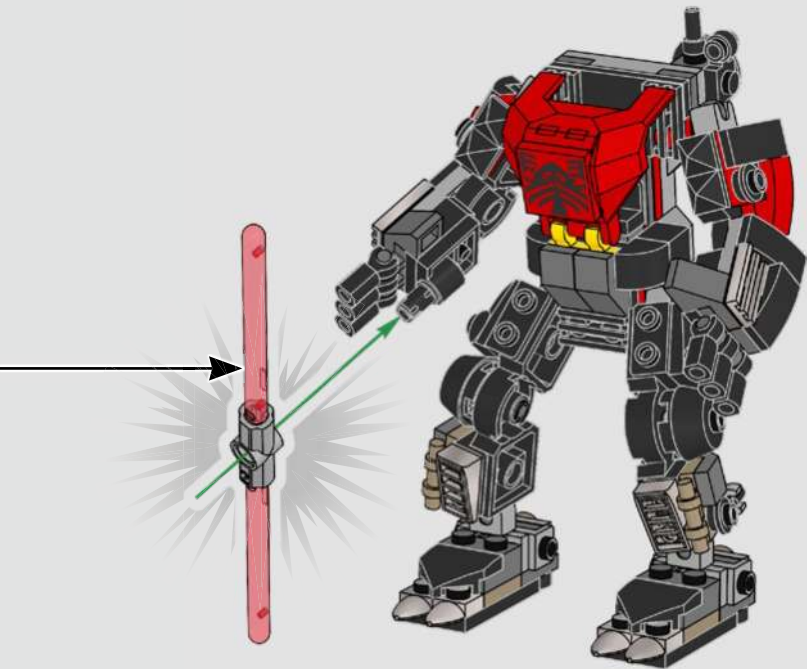

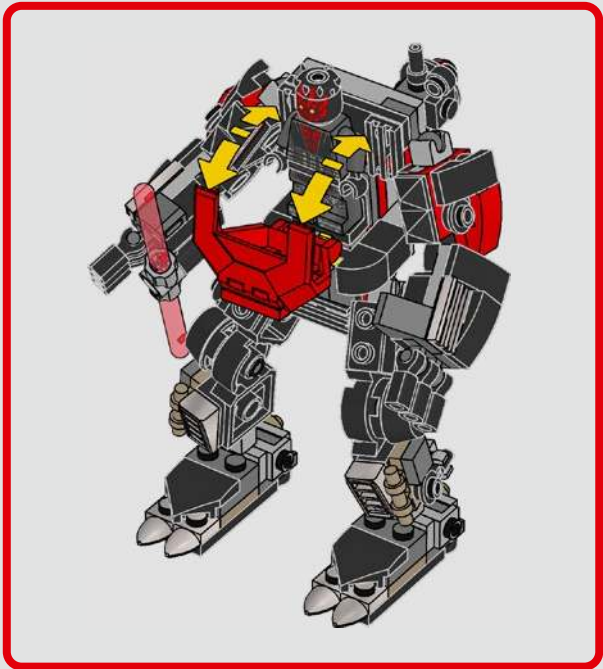

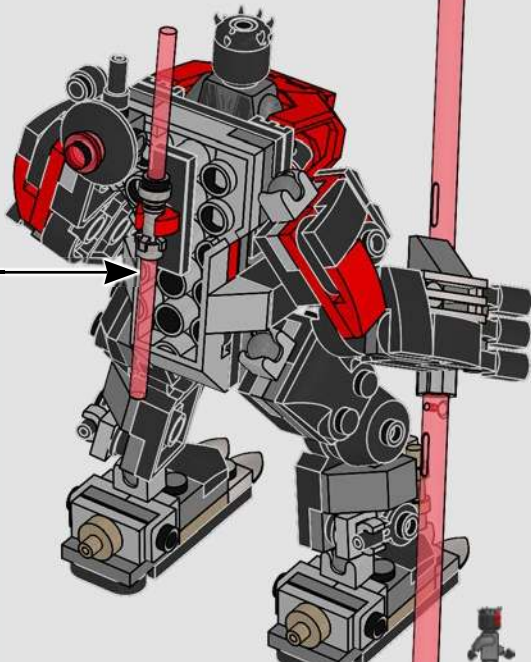





# STAR WARS™





1x  
6439048



1x  
6541180



2x  
362321



1x  
6256923



1x  
6525960



1x  
6029952



2x  
6029946



2x  
6319330



1x  
6337231



6x  
6315887



4x  
6168646



1x  
6541177



1x  
6020297



4x  
6312449



2x  
300526



1x  
6371584



2x  
6196548



7x  
6210270



2x  
4653822



1x  
6279875



1x  
474026



1x  
6281993



1x  
6541179



2x  
6308912



3x  
241226



6x  
6047276



1x  
6115086



2x  
6542614



4x  
6016172



2x  
6394979



1x  
6061032



2x  
302226



1x  
6272184



1x  
6254045



2x  
302026



4x  
6469080



2x  
6507880



2x  
6508266



2x  
6308012



4x  
6335328



6x  
6043656



2x  
6066097



2x  
4211398



1x  
6346487

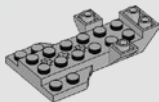

1x  
6452334



2x  
6300320



2x  
6210495



2x  
6047415



2x  
6395635



1x  
4210700



6x  
6168776



2x  
4211063



6x  
6039479



1x  
6214341



2x  
6250018



2x  
4210660



1x  
6126083



2x  
6469463



2x  
4211133



2x  
4619636



4x  
4625146



2x  
6167922



1x  
6514051



1x  
6558774



1x  
6051389



 [LEGO.com/service](https://www.LEGO.com/service)

YOU COULD **WIN**



Scan this QR code or go to **LEGO.COM/PRODUCTFEEDBACK** and give us your short feedback about this LEGO® set for a chance to win a cool LEGO prize.

Terms and Conditions apply\*



**EN: YOU COULD WIN.** Terms and Conditions apply\* **DE: Du könntest GEWINNEN.** Es gelten die Teilnahmebedingungen\* **FR: Tu pourrais GAGNER.** Des conditions s'appliquent\* **IT: Potresti VINCERE tu.** Termini e condizioni sono applicabili\* **ES: Puedes GANAR.** Aplican términos y condiciones\* **PT: PODERÁ GANHAR.** Aplicam-se Termos e Condições\* **ZH: 轻松获奖.** 条款和条件适用\* **PL: Szansa na WYGRANĄ.** Obowiązuje regulamin\* **CS: Máte šanci VYHRÁT.** Platí všeobecné smluvní podmínky\* **SK: Máte šancu VYHRÁŤ.** Platia všeobecné zmluvné podmienky\* **HU: TE IS NYERHETSZ.** Felhasználási feltételek érvényesek\* **UA: ВИ МОЖЕТЕ ВИГРАТИ.** Застосовуються загальні положення та умови\* **RO: Ai putea CÂȘTIGA.** Se aplică termeni și condiții\* **BG: Можете да СПЕЧЕЛИТЕ.** Има определени правила и условия\* **LV: Tu vari LAIMĒT.** Ir spēkā noteikumi un nosacījumi.\* **ET: Sul on võimalus VÕITA.** Kehtivad tingimused\* **LT: Jūs galite LAIMĖTI.** Taikomos sąlygos\*

\*[LEGO.com/productfeedback-terms](https://www.lego.com/productfeedback-terms)

LEGO and the LEGO logo are trademarks of the LEGO Group. ©2025 The LEGO Group.

© & ™ Lucasfilm Ltd.



6582070