



DREAMZZZ

71492



LEGO® Builder



LEGO.com/sustainable-packaging



FR
DONNEZ
OU
RECYCLEZ



ASSOCIATION

OU



MAGASIN

OU



DÉCHÈTERIE

Adresses sur quefairedemesdechets.fr

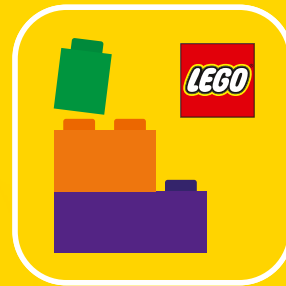

🔍 LEGO® Builder

BUILDER

Download on the
App Store

GET IT ON
Google Play

腾讯应用宝
安卓应用商店

Apple and the Apple logo are trademarks of Apple Inc., registered in the U.S. and other countries and regions. App Store is a service mark of Apple Inc. Google Play and the Google Play logo are trademarks of Google LLC. Tencent and the Tencent logo are trademarks of Tencent Inc.

🔍 [LEGO.com/devicecheck](https://lego.com/devicecheck)

EN Ask parents' permission before going online | **DE** Eltern um Erlaubnis bitten, bevor du online gehst | **FR** Demande l'autorisation d'un parent avant d'aller en ligne | **IT** Chiedi il permesso ai tuoi genitori prima di andare online | **ES** Pídeles permiso a tus papás antes de conectarte a Internet | **PT** Peça autorização aos pais antes de acederes online | **ZH** 上网前应先征得父母的同意 | **PL** Poproś rodziców o zgodę, zanim wejdziesz do Internetu | **CS** Než půjdeš na internet, požádej rodiče o svolení | **SK** Skôr než pôjdeš na internet, vypýtaj si povolenie od rodičov | **HU** Kérj szülői engedélyt, mielőtt online csatlakoznál! | **UA** Запитуйте дозволу батьків, перш ніж користуватися інтернетом | **RO** Cere permisiunea părinților înainte de a te conecta online | **BG** Поискайте разрешение от родител, преди да влезете онлайн | **LV** Pirms došanās tiešsaistē palūdz atļauju vecākiem | **ET** Enne Interneti kasutamist küsi vanematelt luba | **LT** Prieš prisijungdami prie interneto, atsiklauskite tėvų





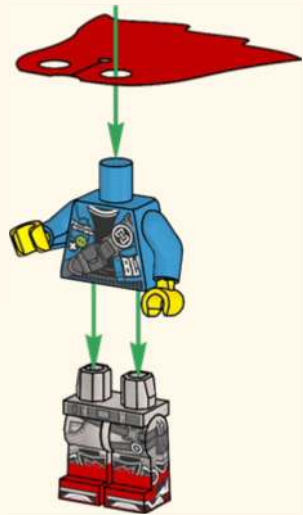

1

2



3

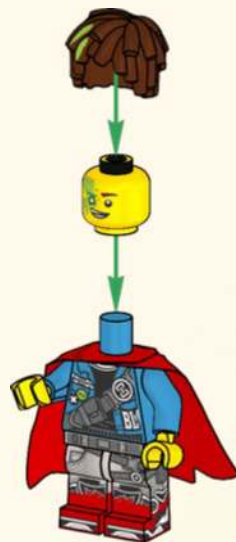

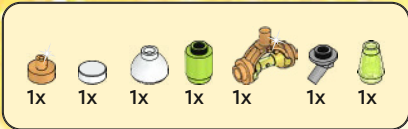

4

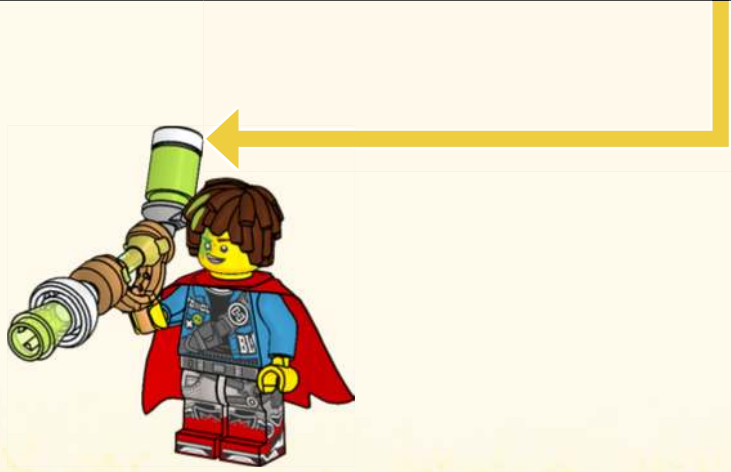
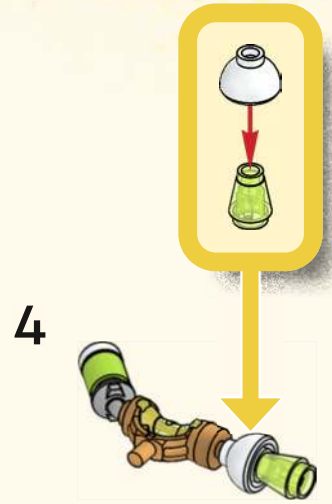
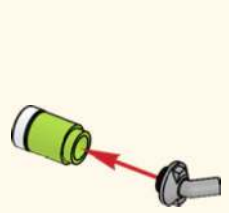



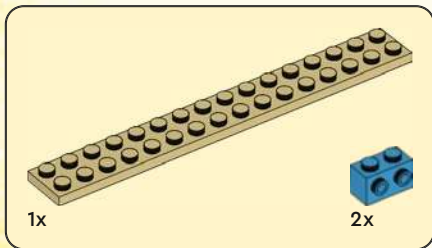
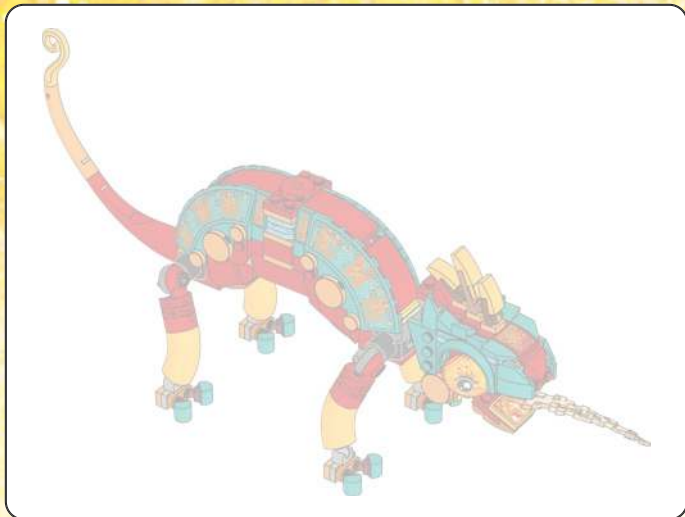

1

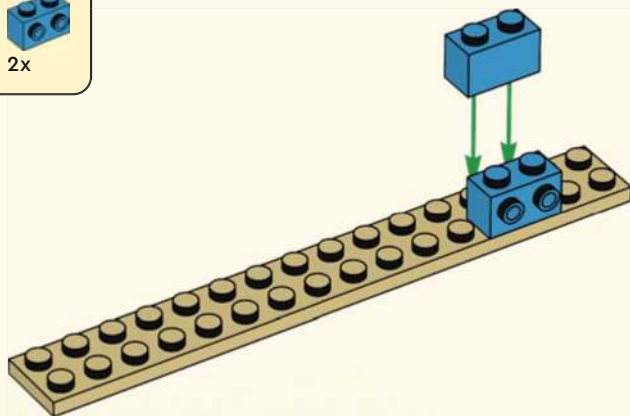

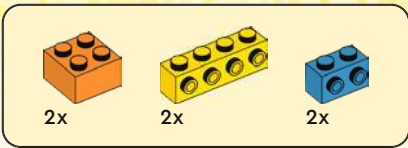

2

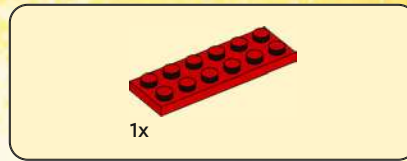
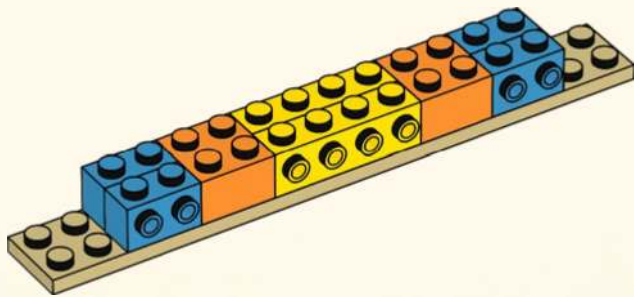

3

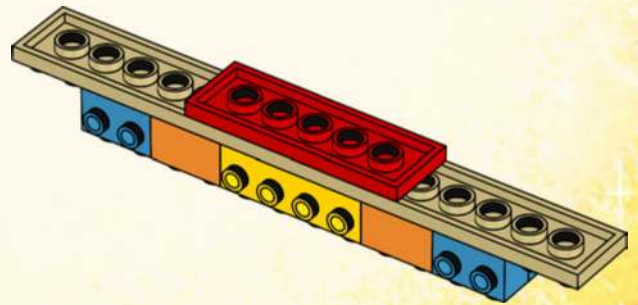

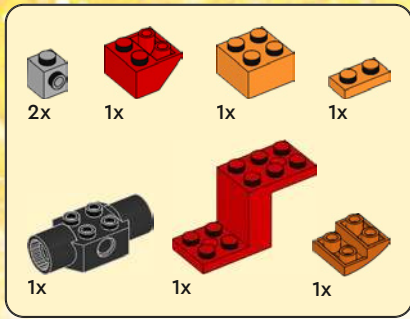

4

1

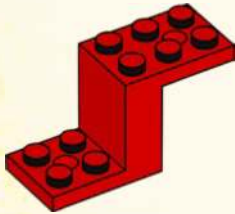

2



3





4

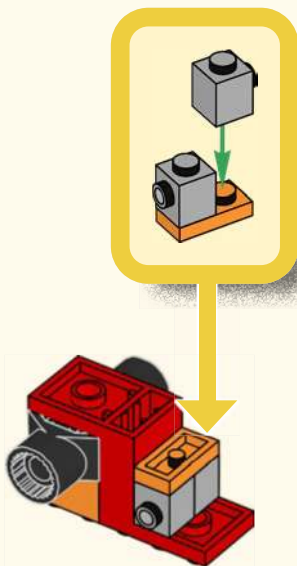

5

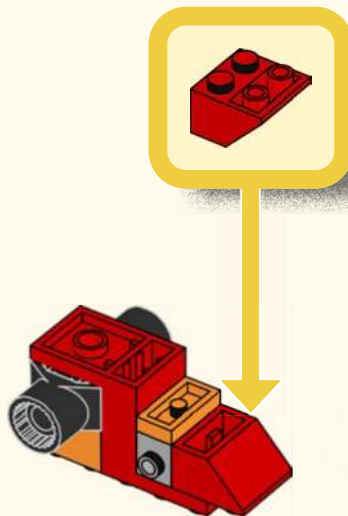

6

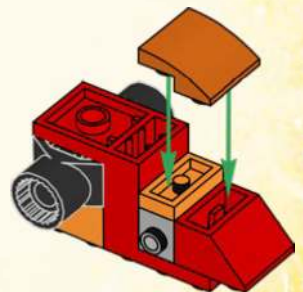

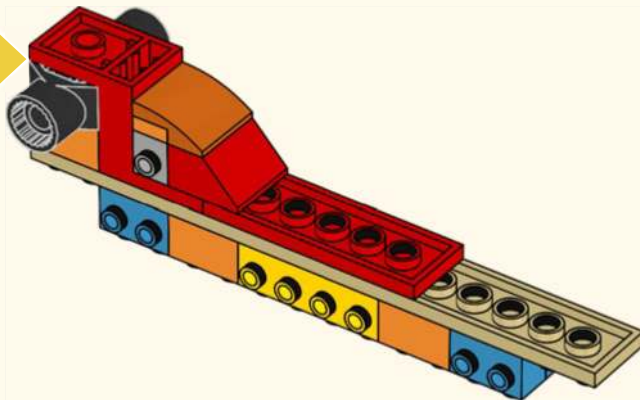

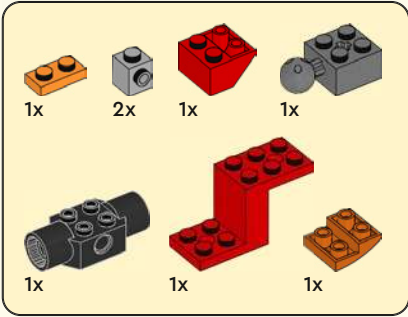
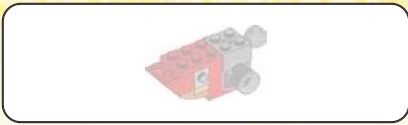

5

1

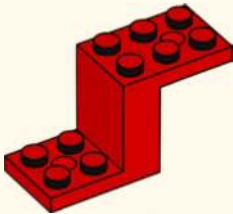

2



3



4

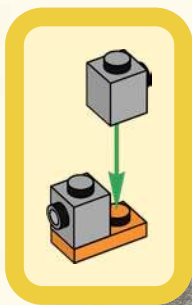

5

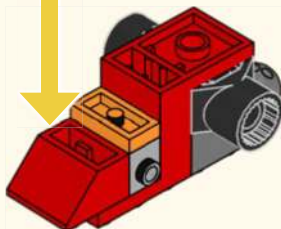

6

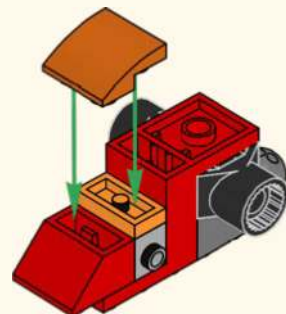

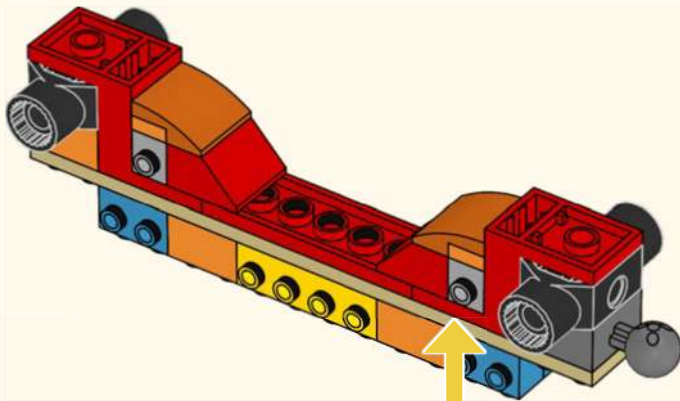



2x

6

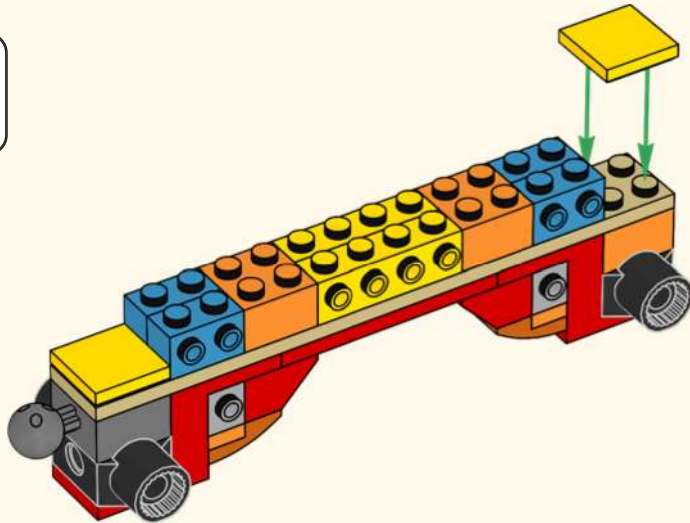

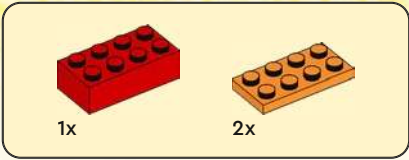

7

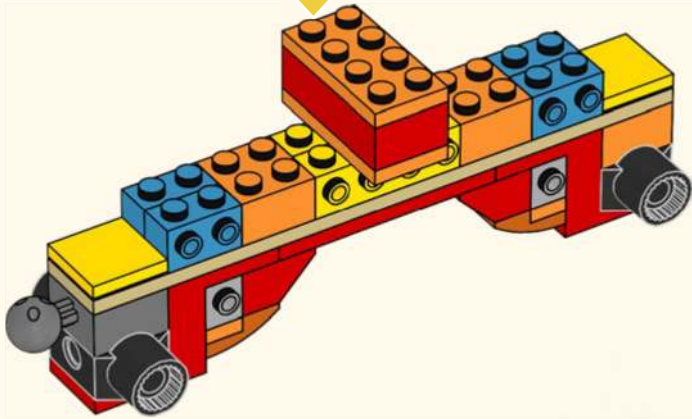
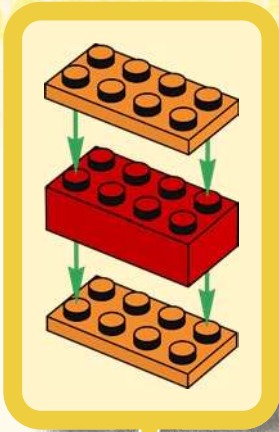



4x

8

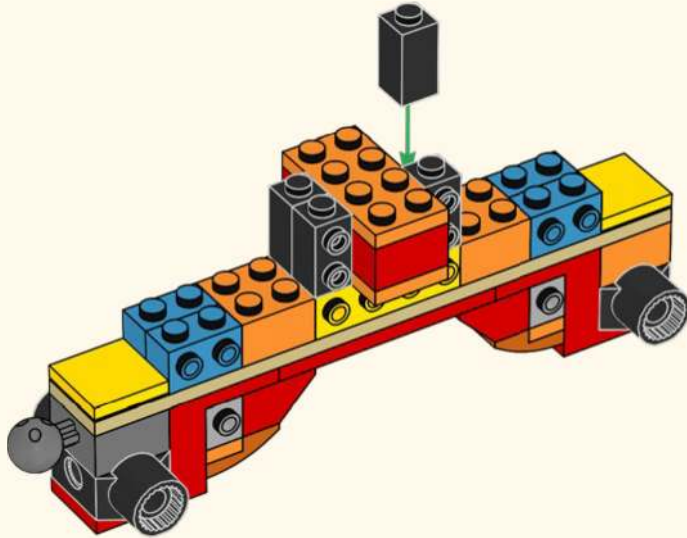



4x

9

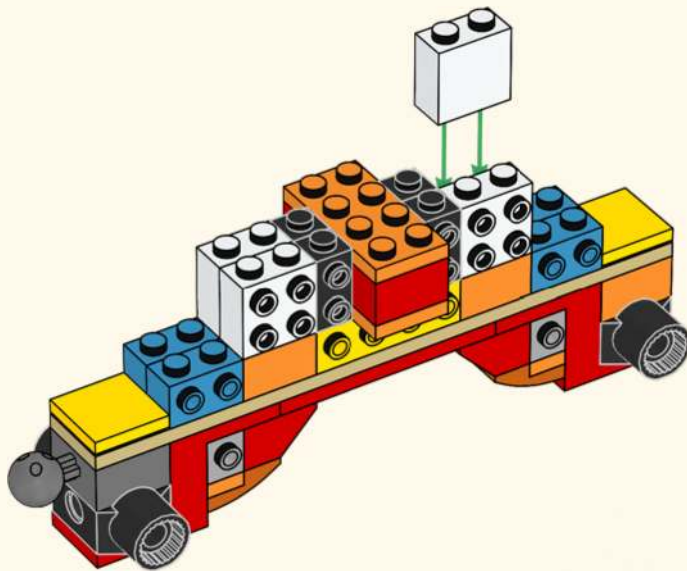



1x



2x

10

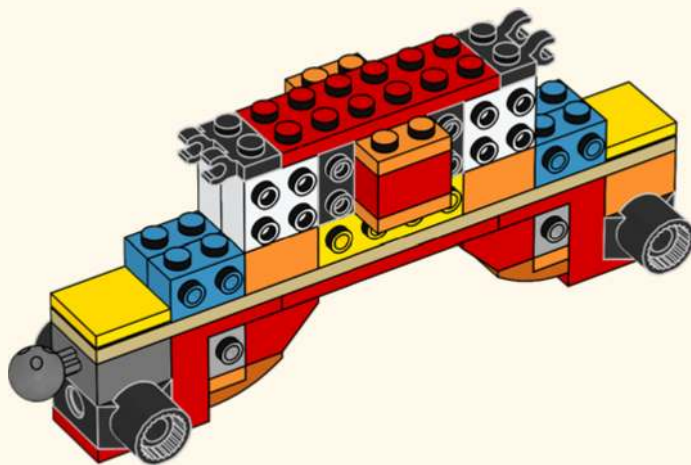



2x

11

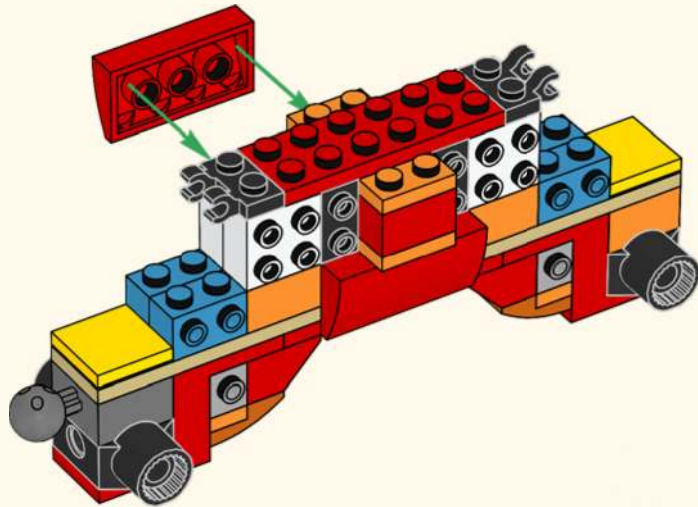

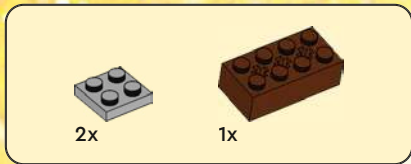

12

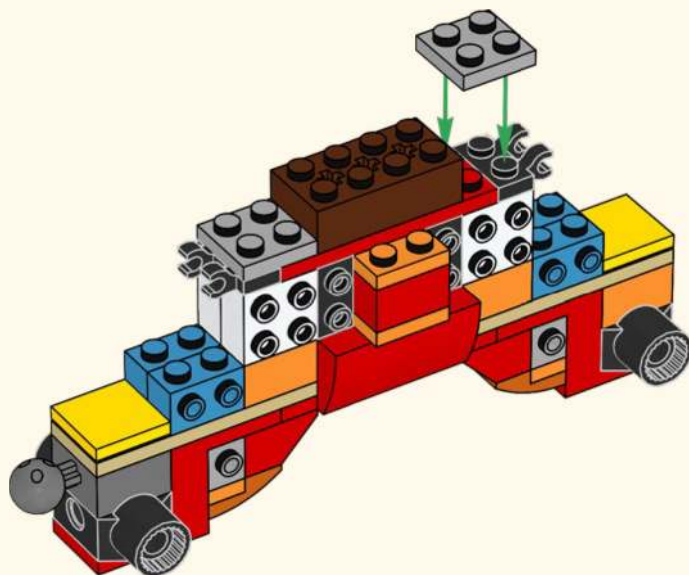



2x

13

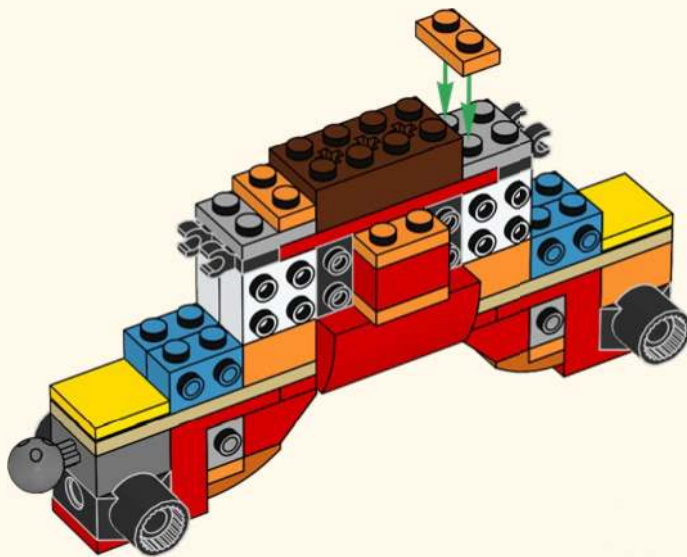



2x



2x

14

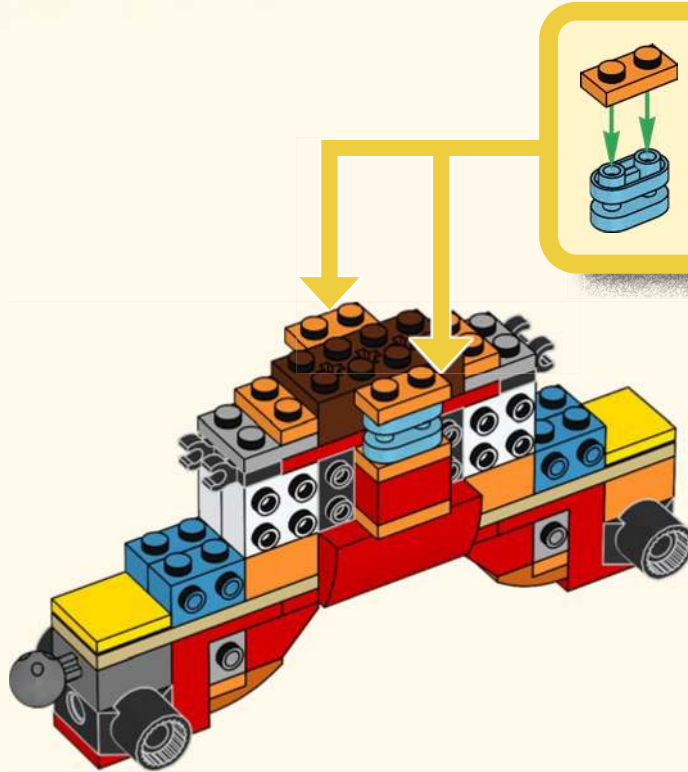

2x



15

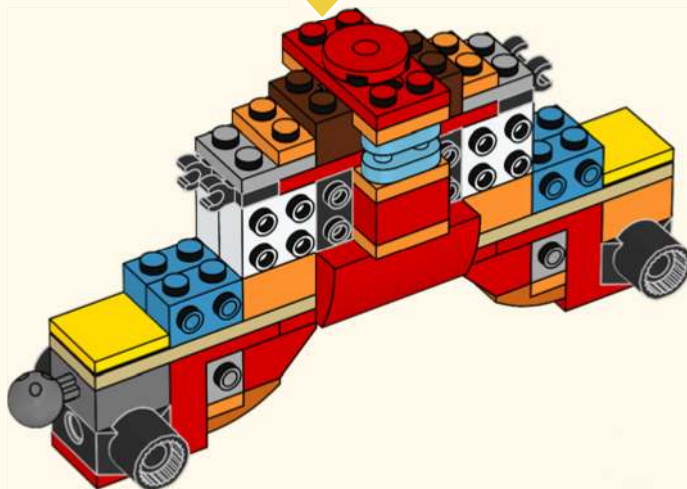



2x

16

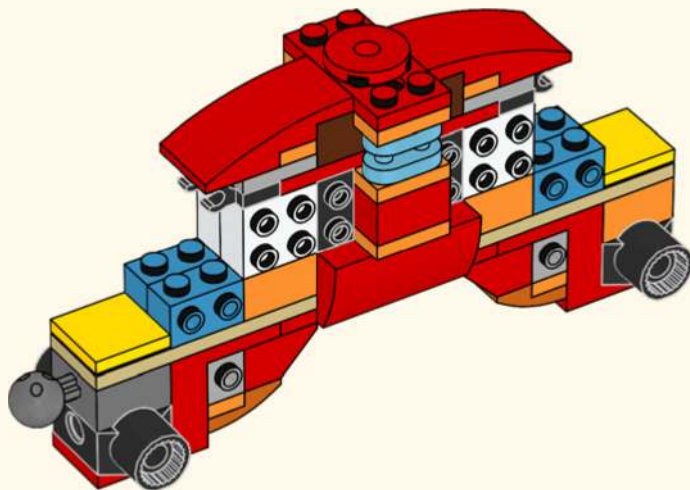



17

1

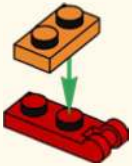

2



3



4



2x

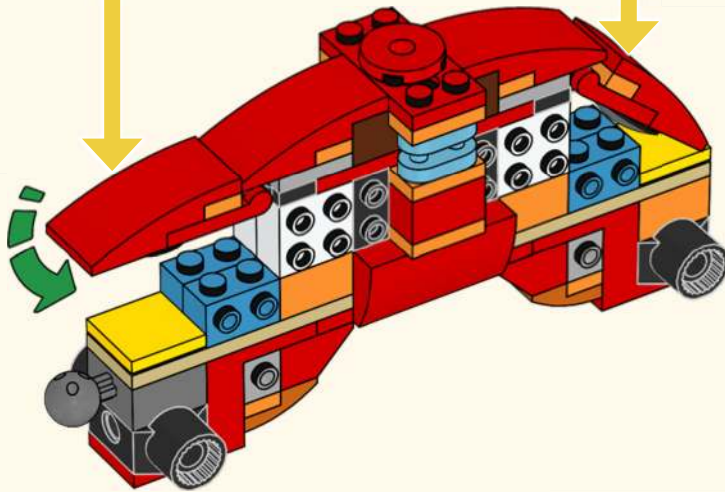

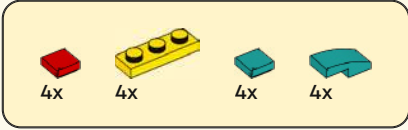
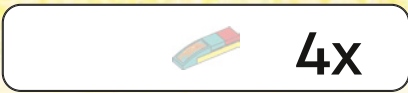

18

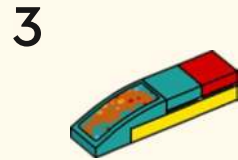
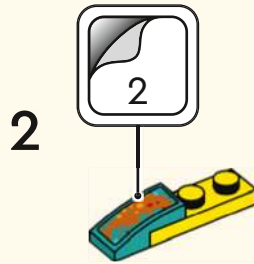
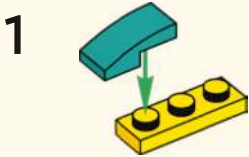

4x

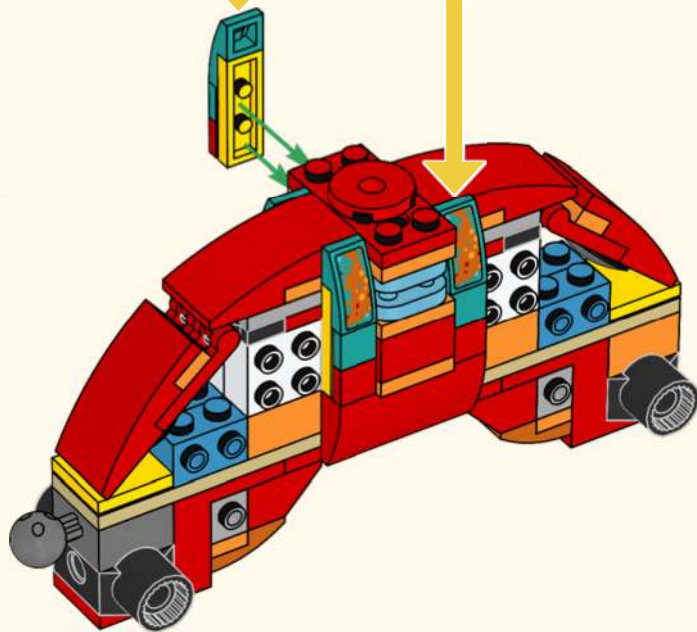



4x

19

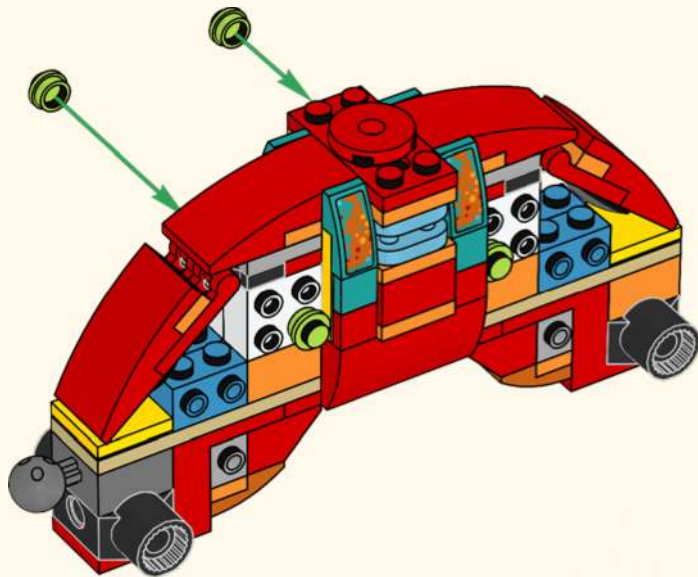



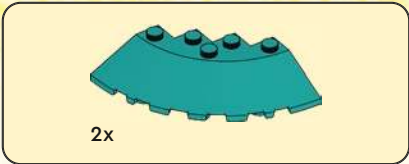

20

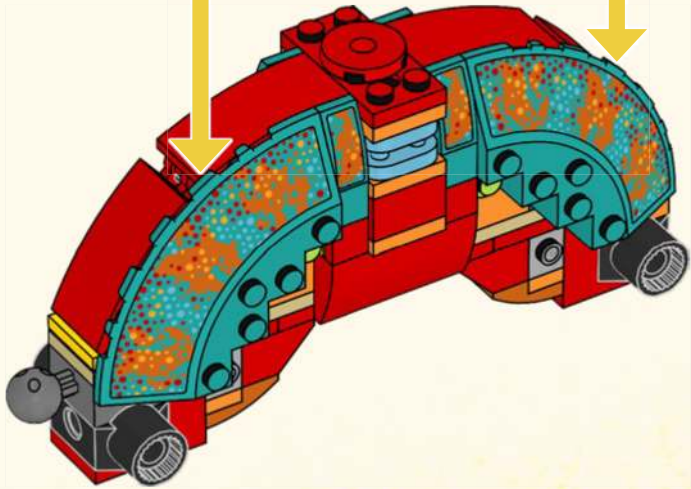
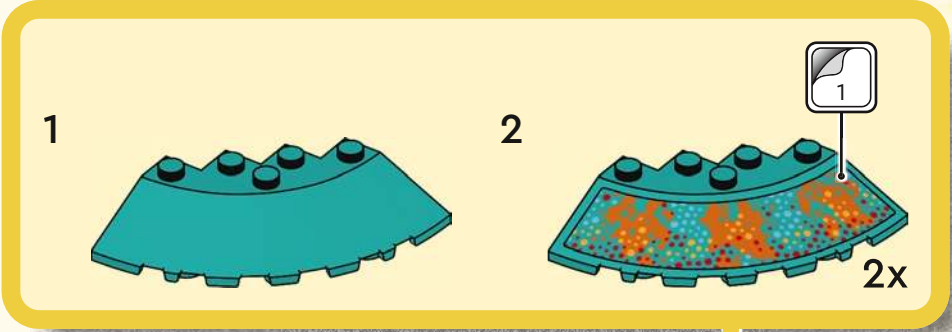

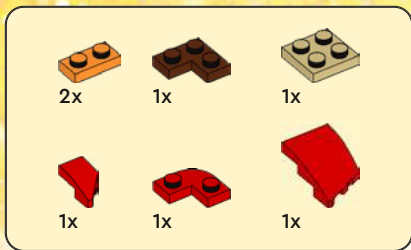

21

1



2



3



4



5

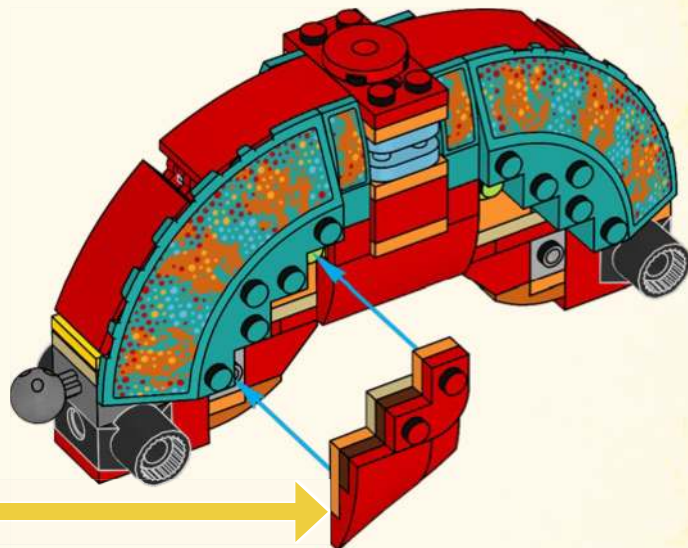
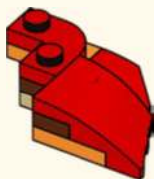



22

1



2



3



4



5

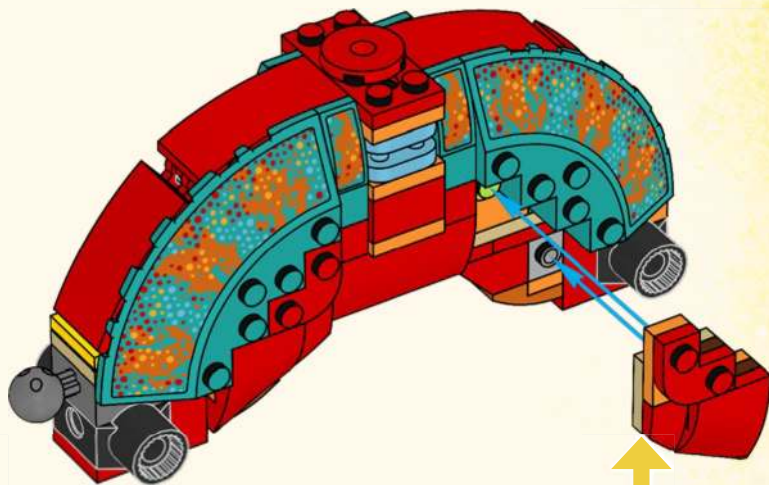
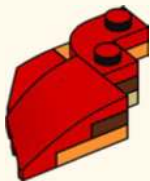



2x



4x

23

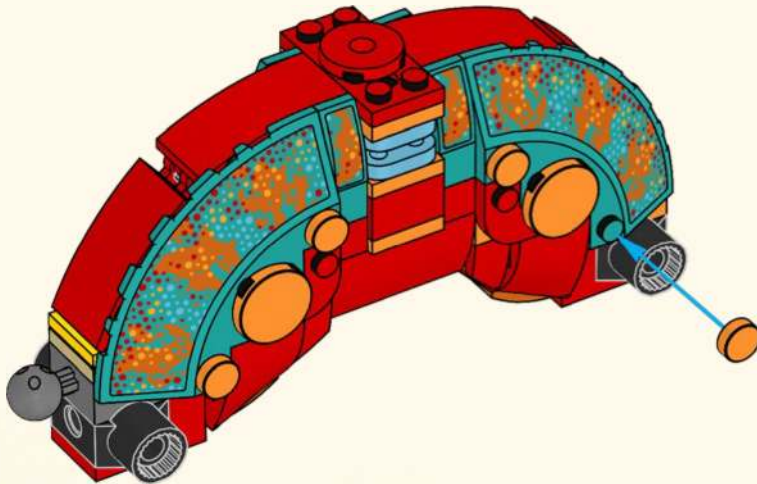

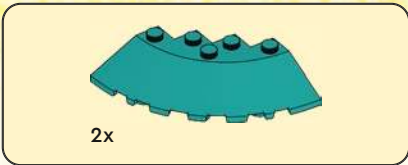

24

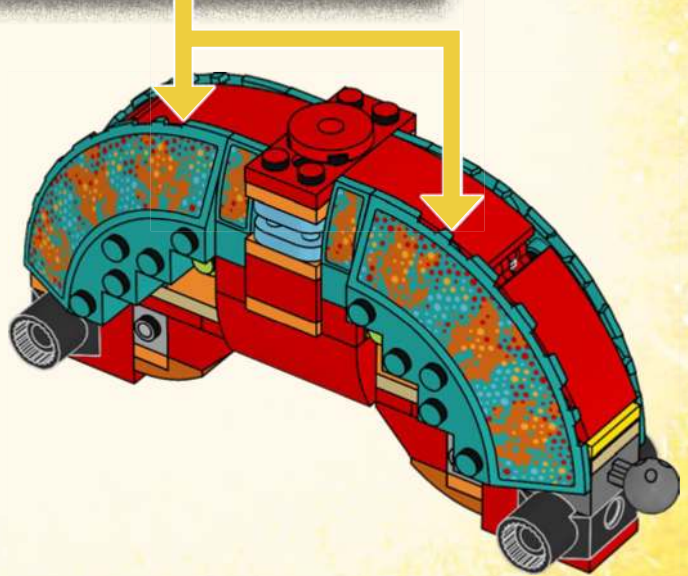
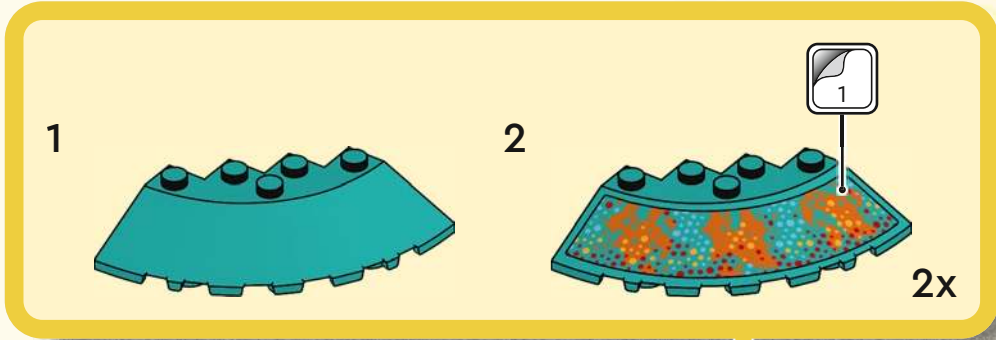

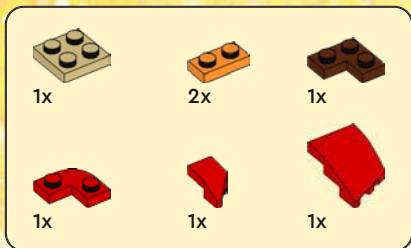

25

1



2



3



4



5

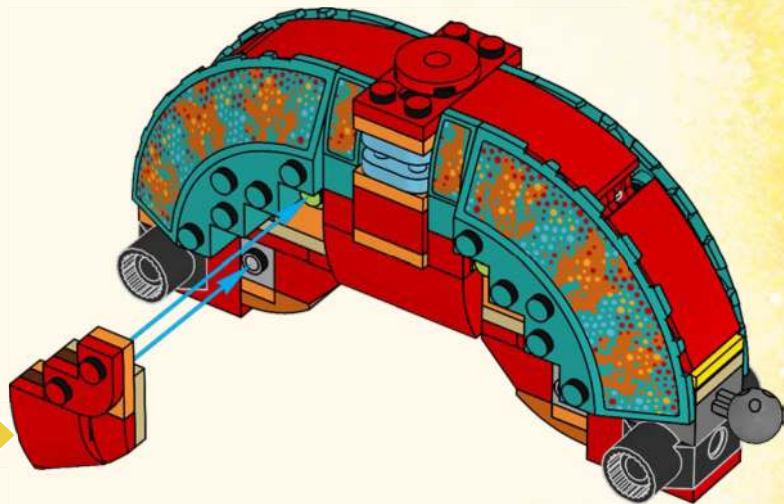
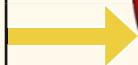

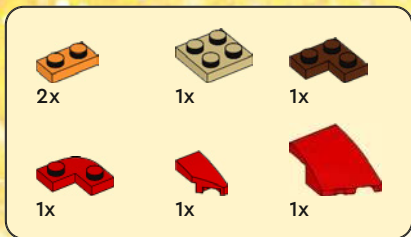

26

1



2



3



4



5

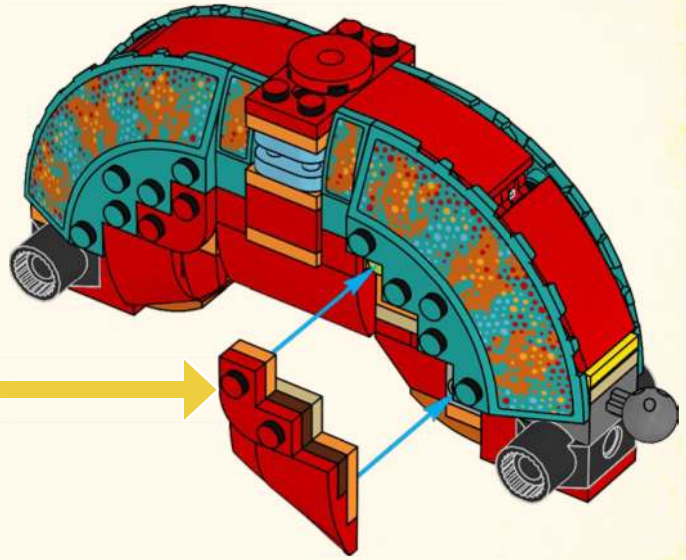
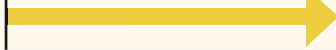
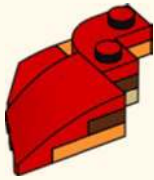



2x



4x

27

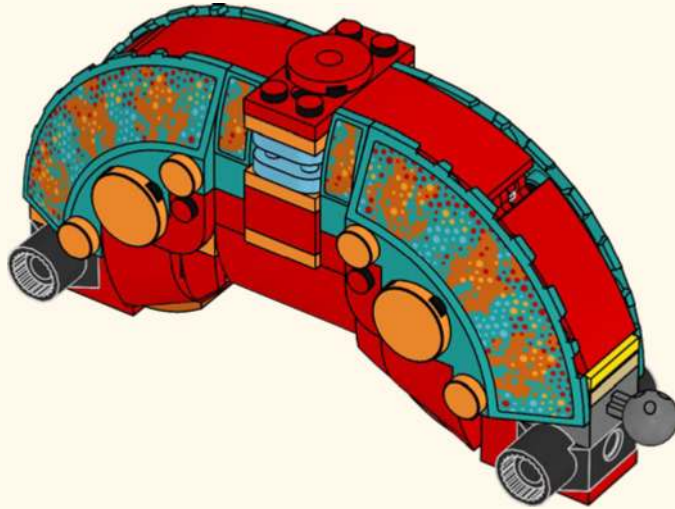

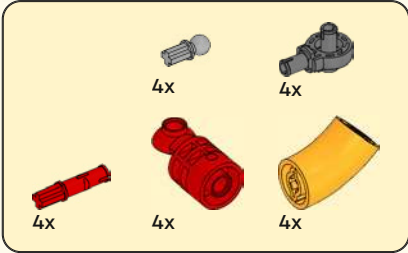

28

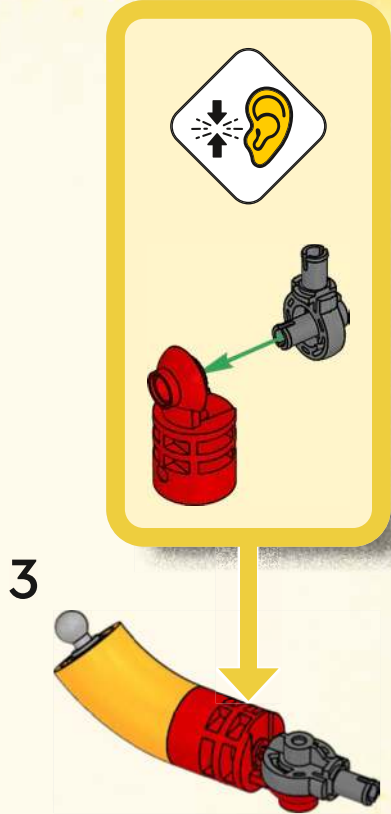
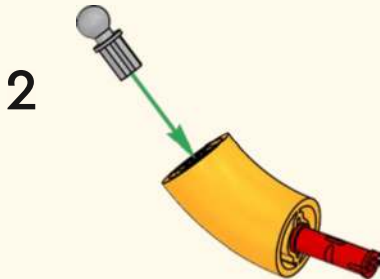
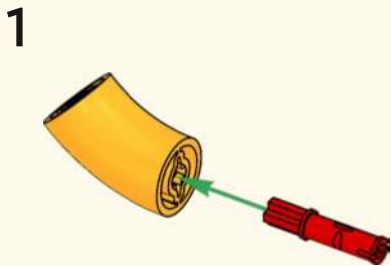

4x

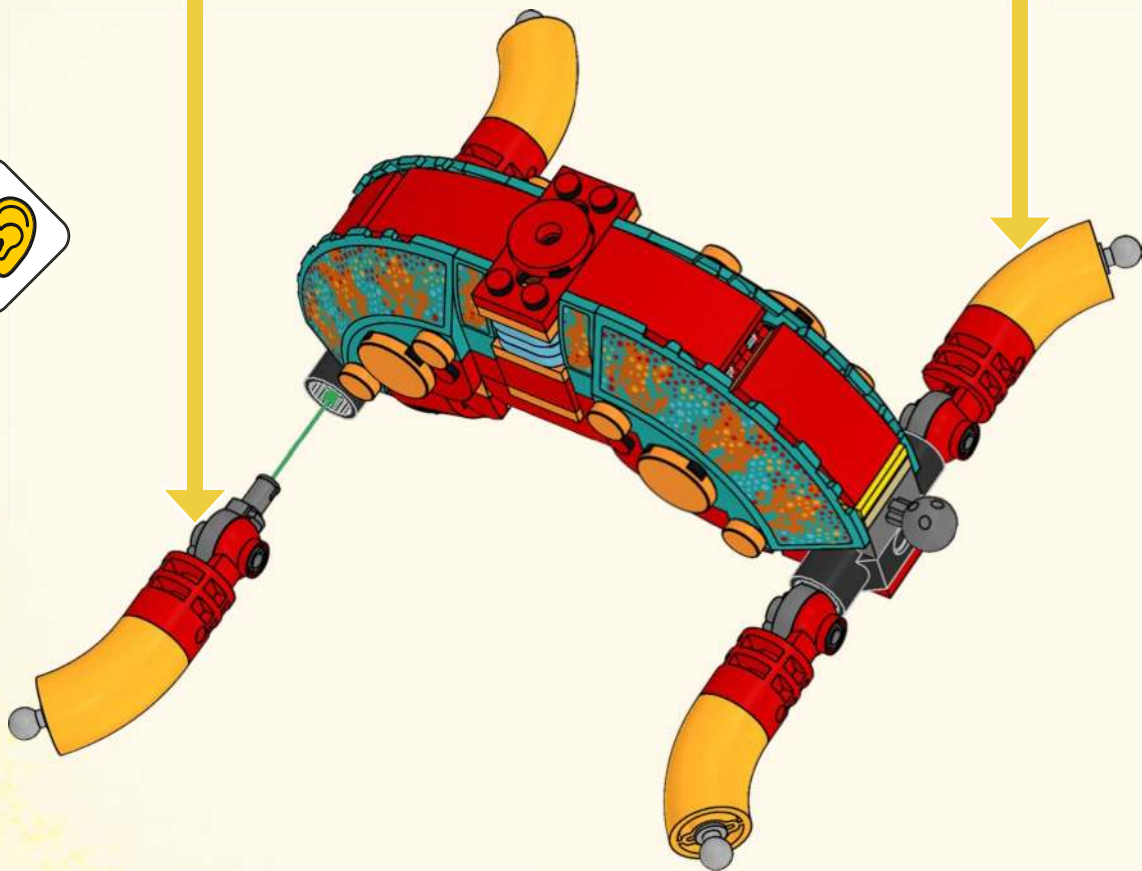

29





4x



4x



4x



8x



8x



4x

30

1

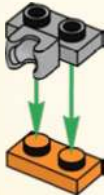

2



3



4



4x

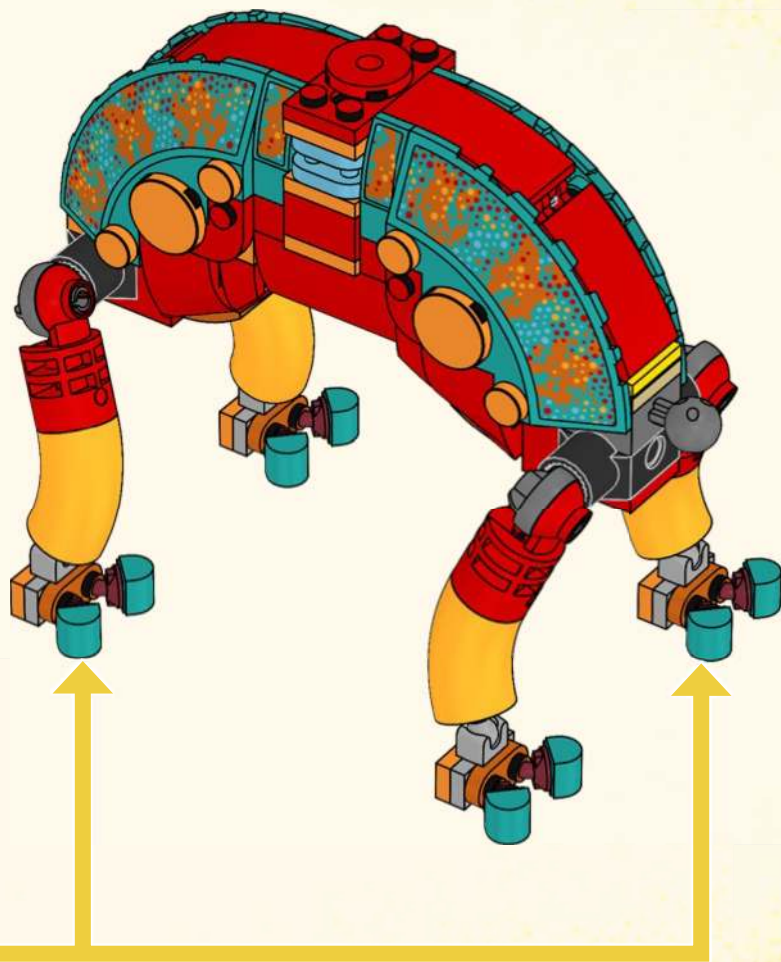





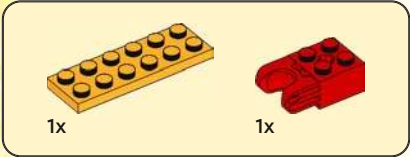
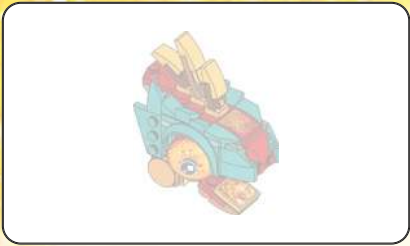

31

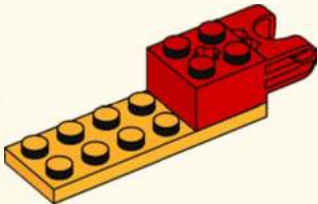

32

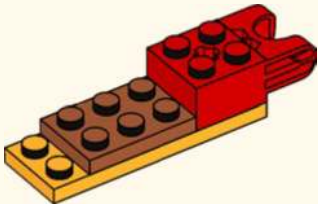



2x



1x

33

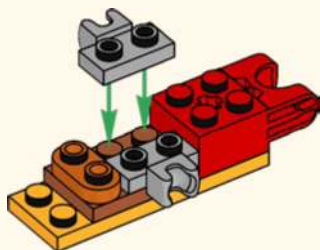

1x

34

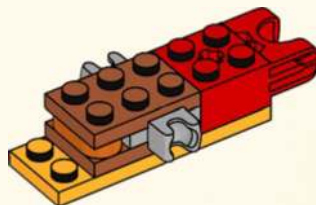



2x

35

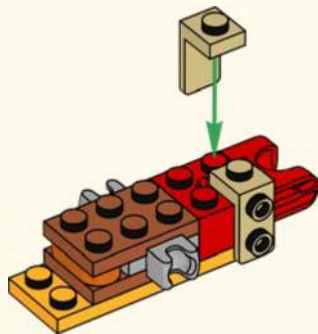

1x

36

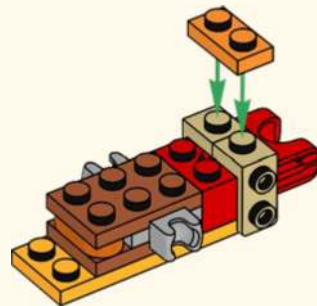



2x

37

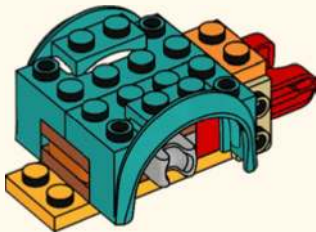

2x



1x

38

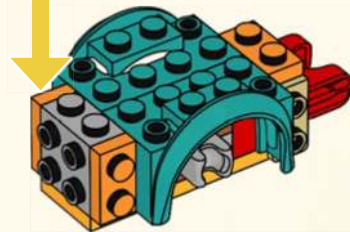
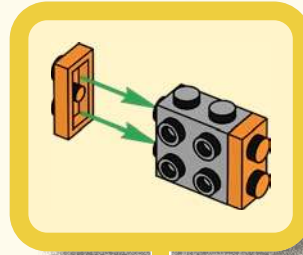



1x



1x

39

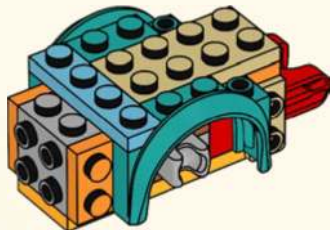

2x

40

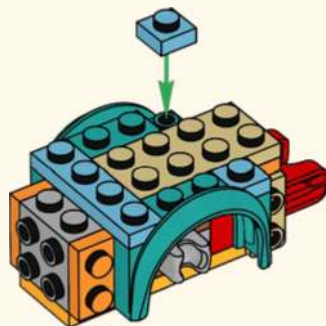



1x

41

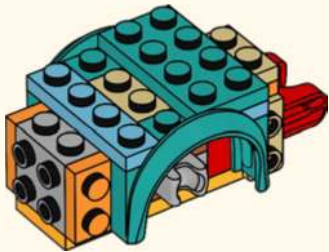

2x

42

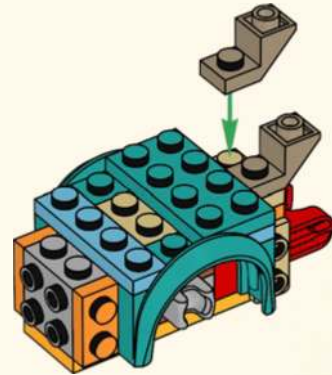



1x

43

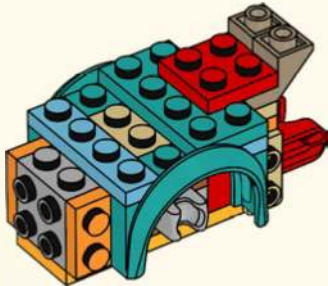

2x

44

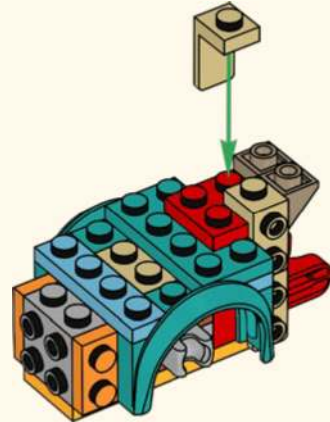



1x



3x

45

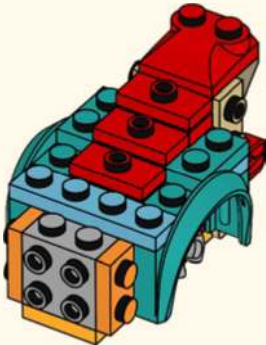

1x

46

1



2

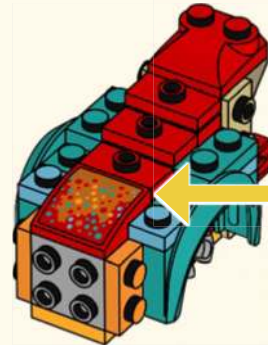



1x

49

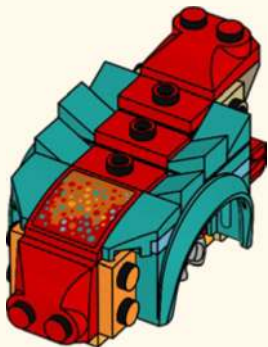

2x



1x



1x

50

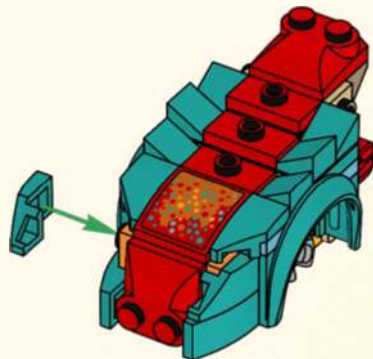



3x

51

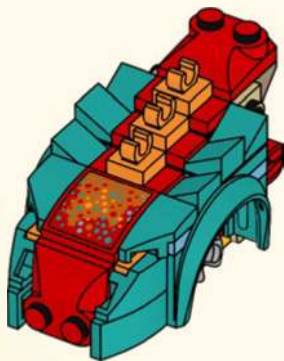

1x



1x



1x

52

1



2

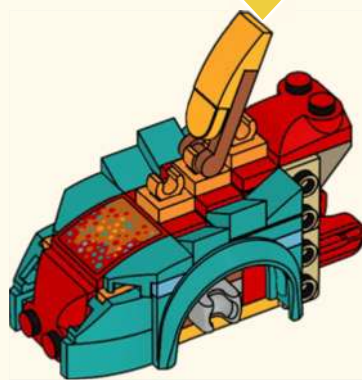
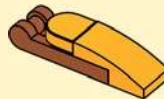



2x



2x

53

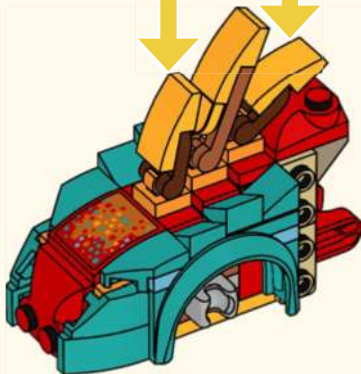

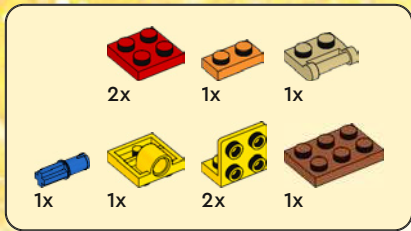

54

1



2



3



4



5



6



7

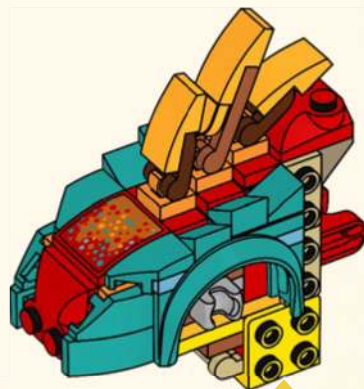
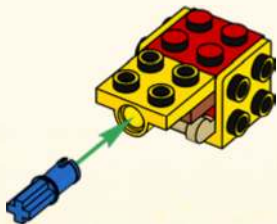

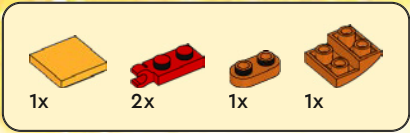

55

1

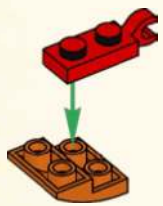

2



3



4



5

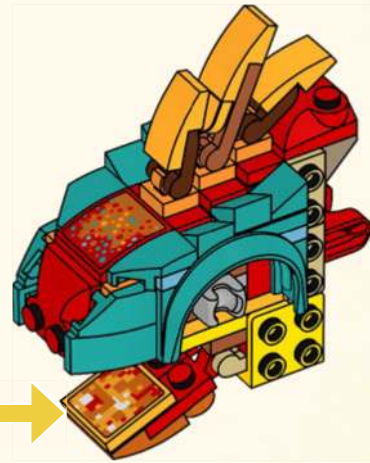

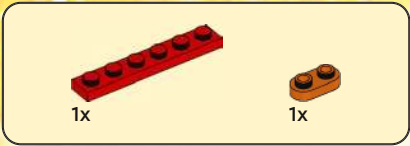

56

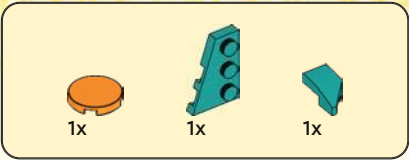

57



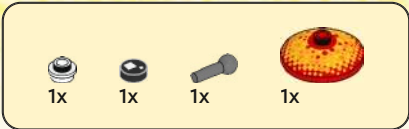

58

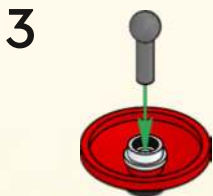
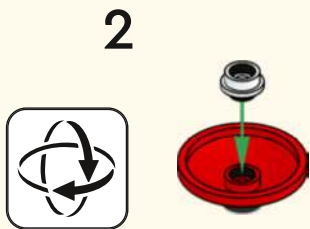
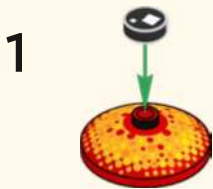

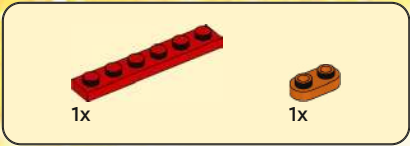

59

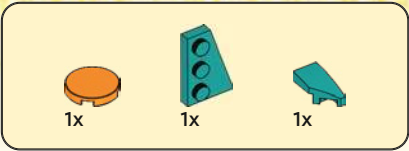

60



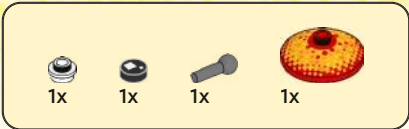

61

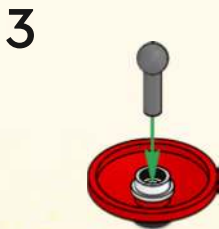
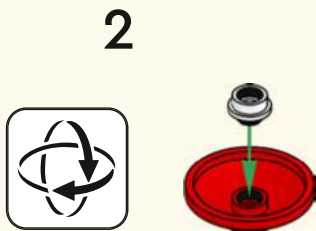
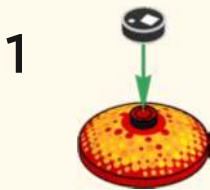

62

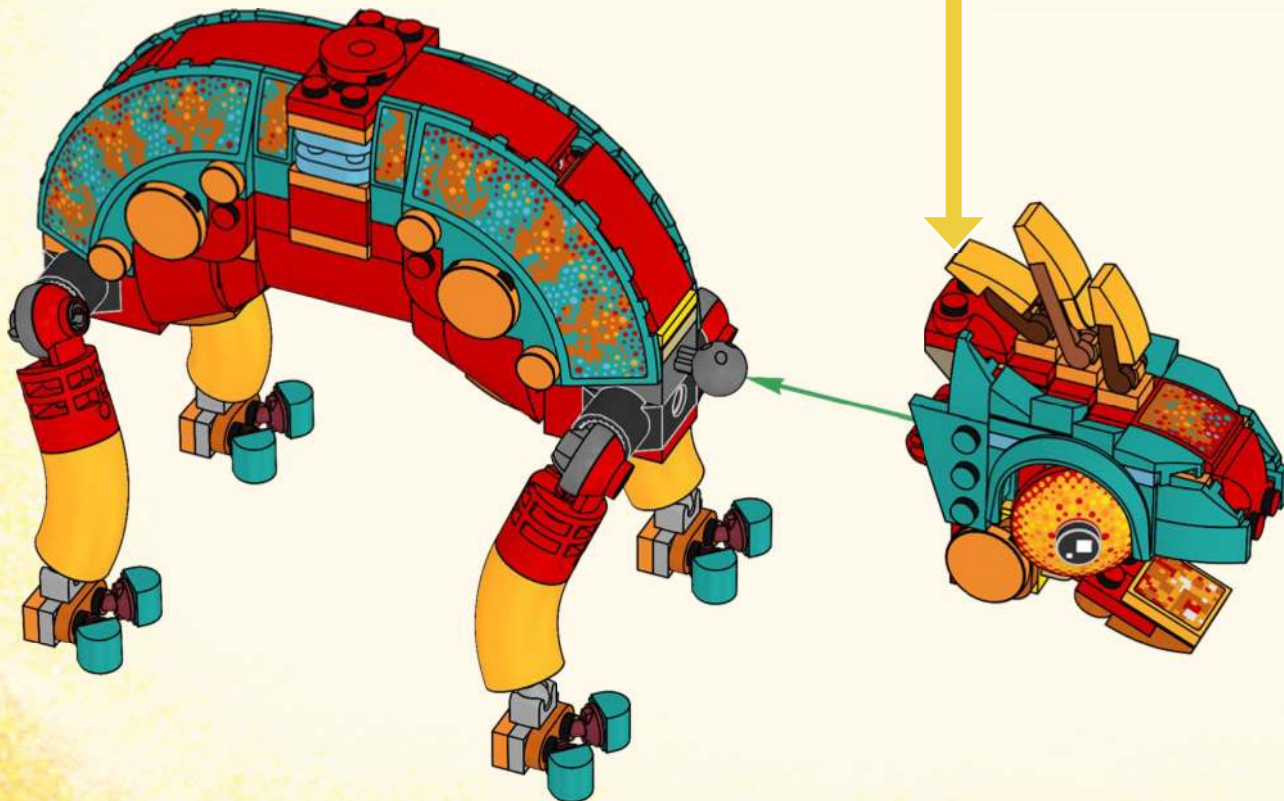

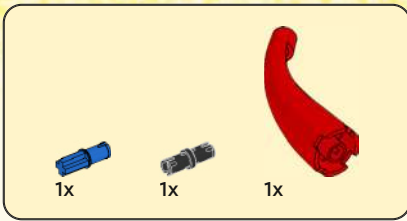

63

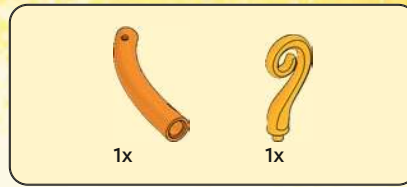
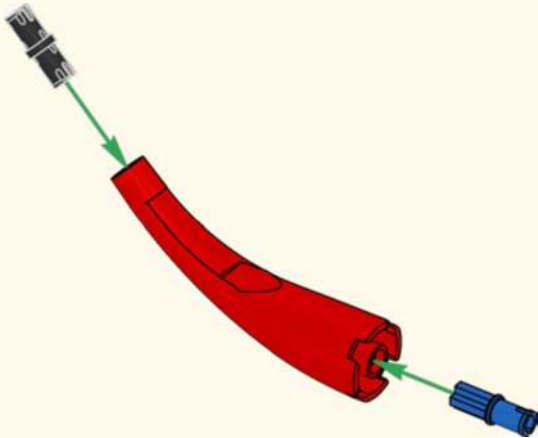

64

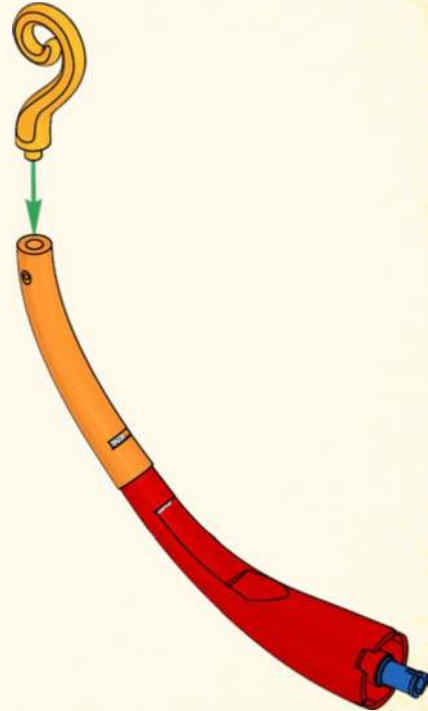

65

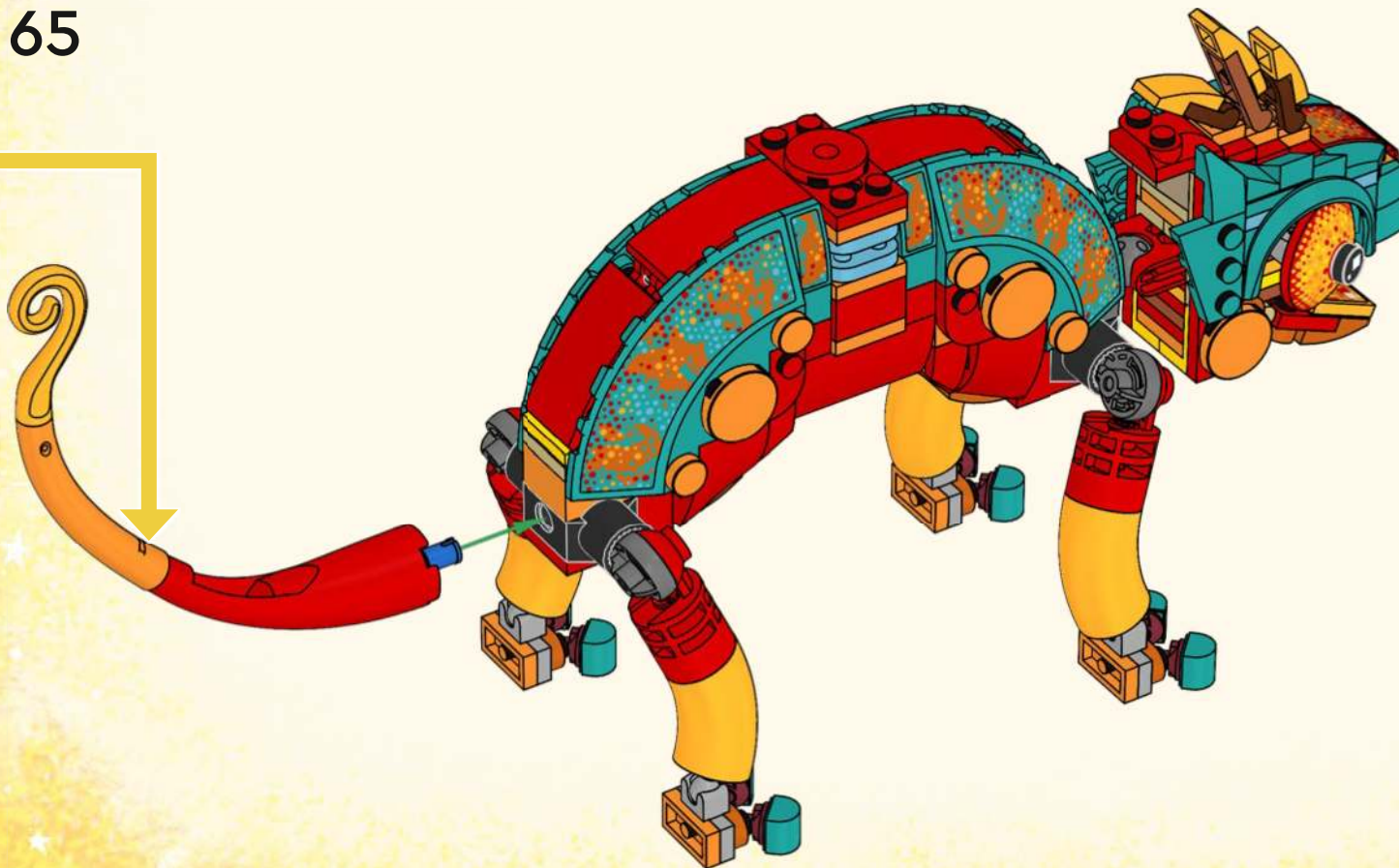

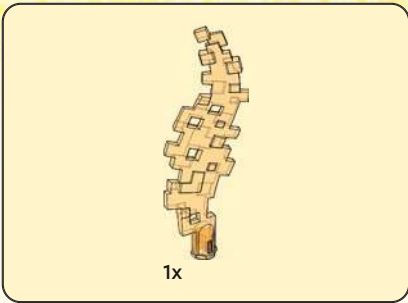

66

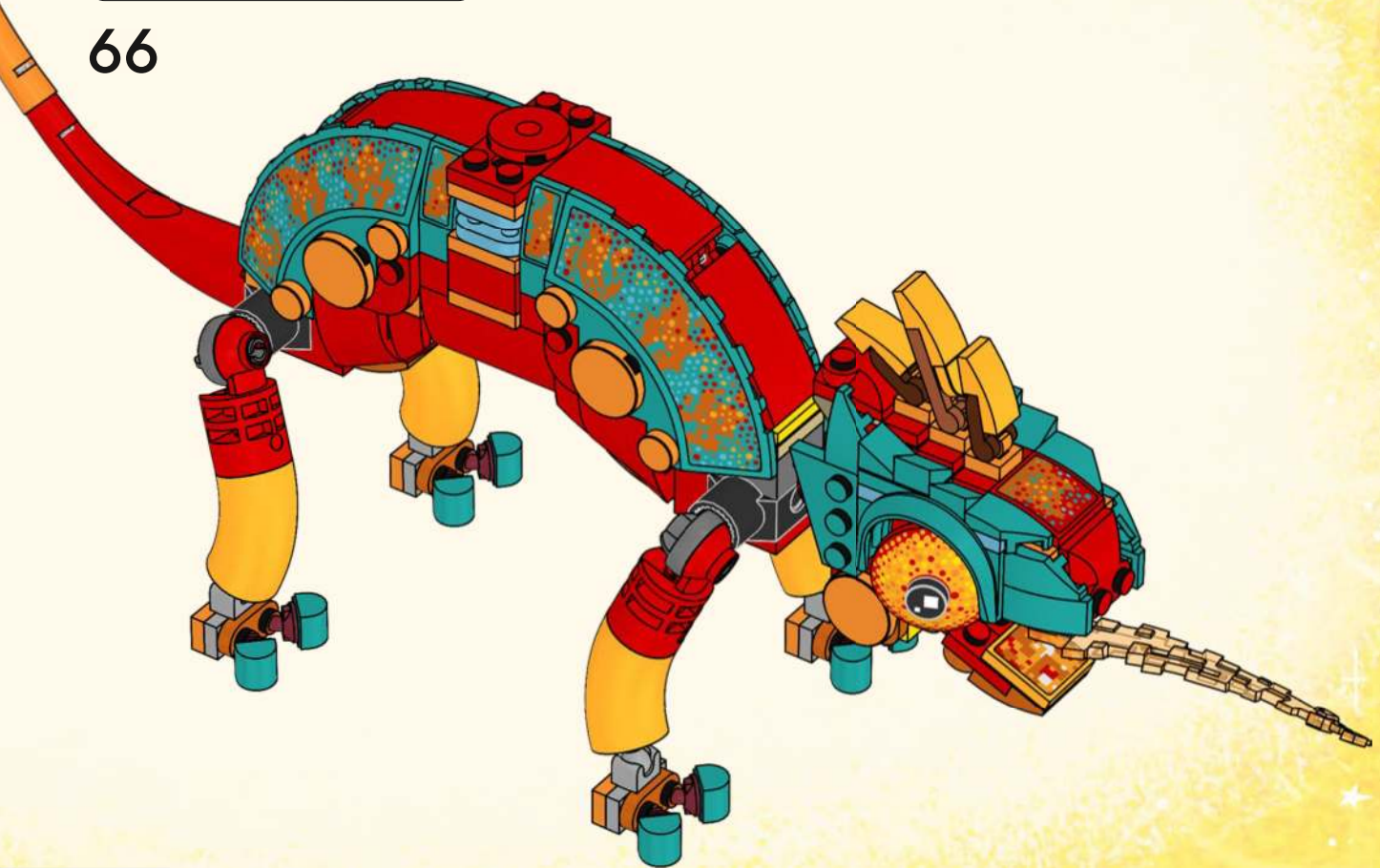



1





1



2

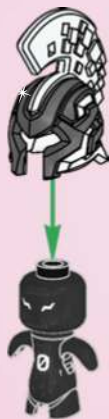

3



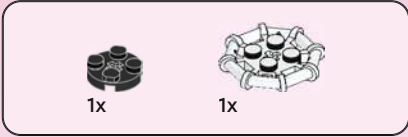

1



2



3





1x



2x

4



1x

5



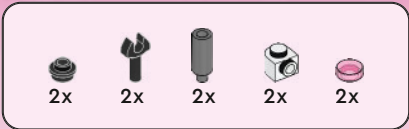

6

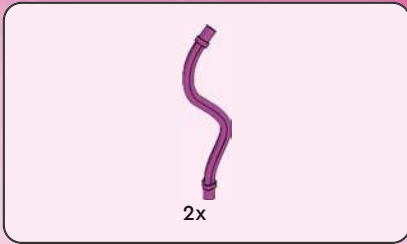
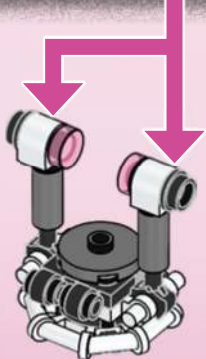
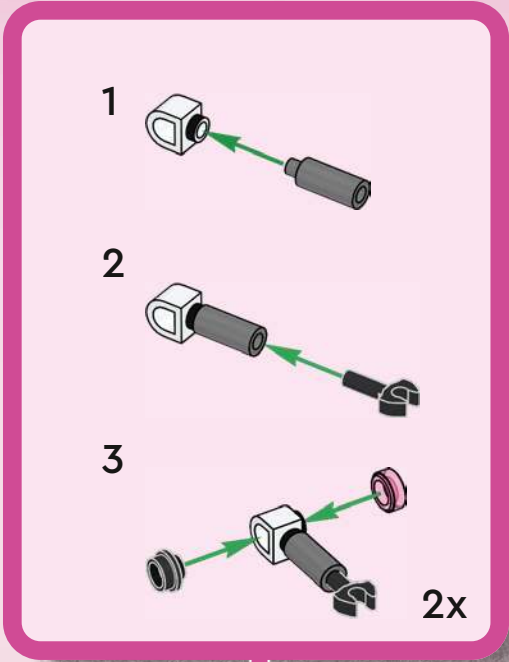

7





8

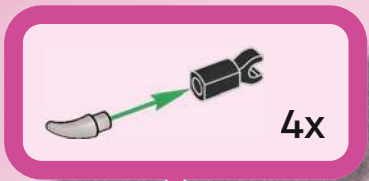

9





10







1



2

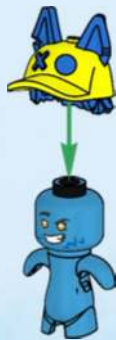

3





1x

1



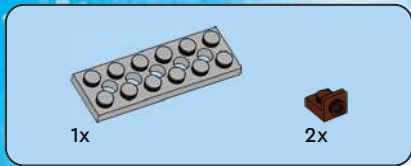

2

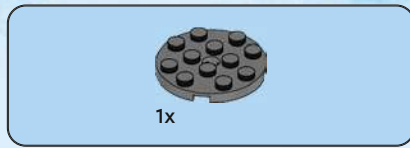
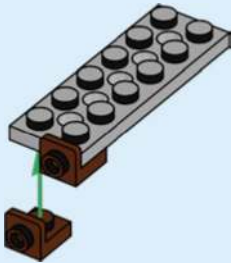

3

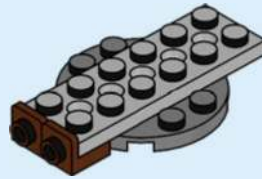

4

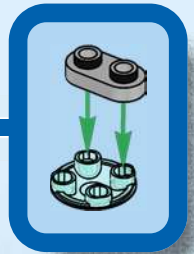



5



6



7

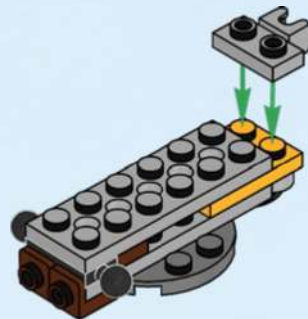

8

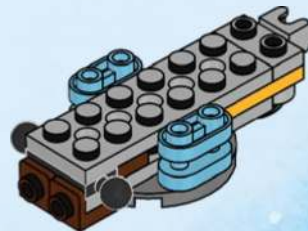



2x



1x

9

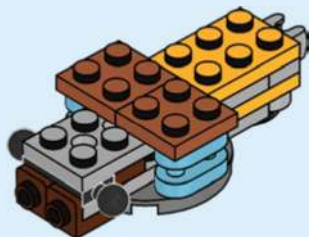

1x



1x

10

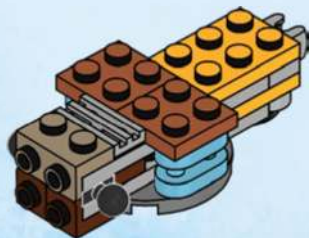

2x

11

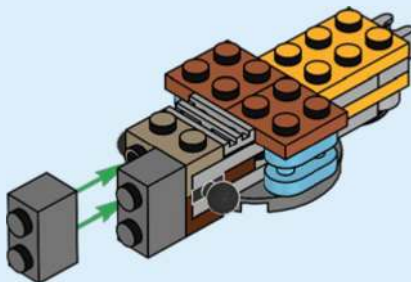

1x

12

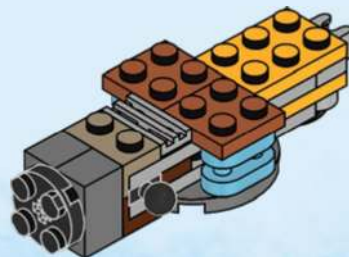



13

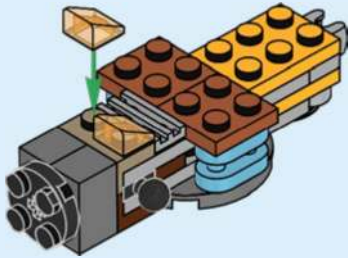

14

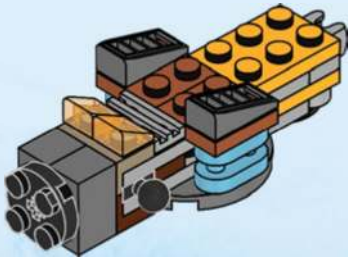

15





1x



1x

16



1x



2x

17

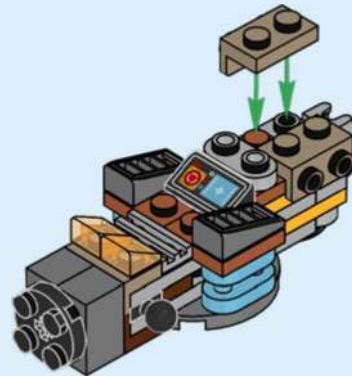

2x

18





19



20



21



22

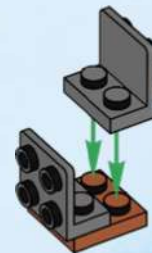



1x



1x

23

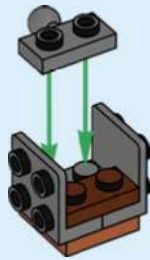

1x

24



1x



1x

25

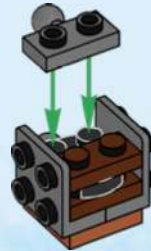



1x



1x

26

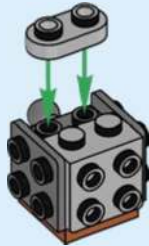

2x

27

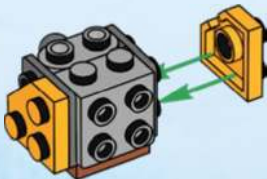

1x



1x

28

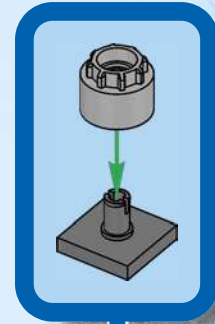

29

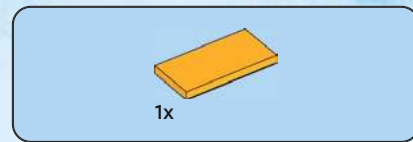
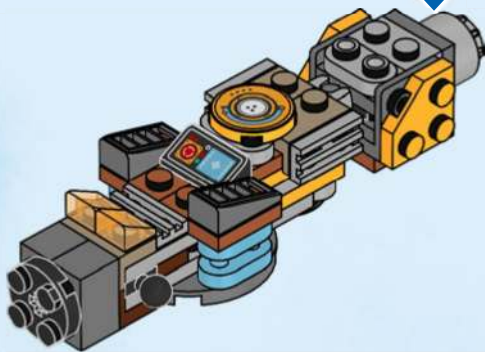

30

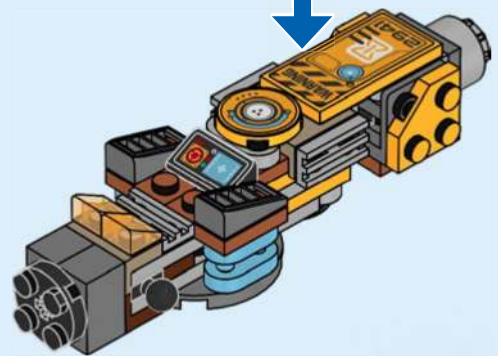
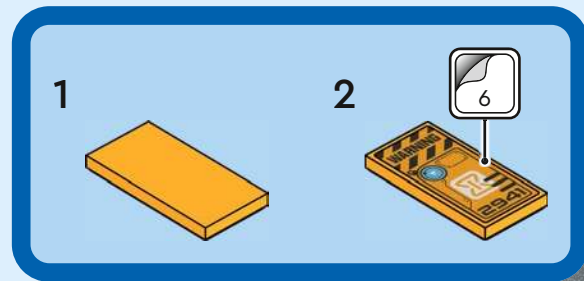

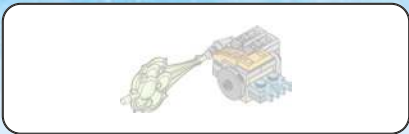

31

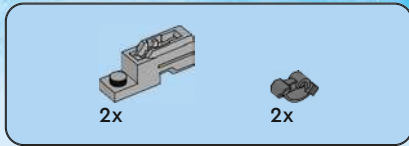
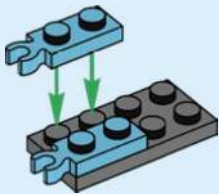

32

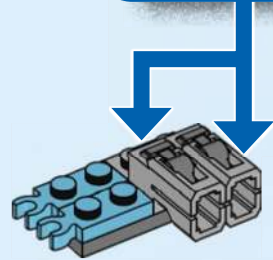
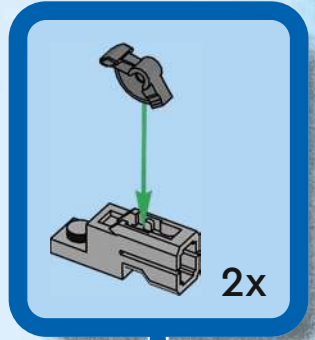



1x



1x

33

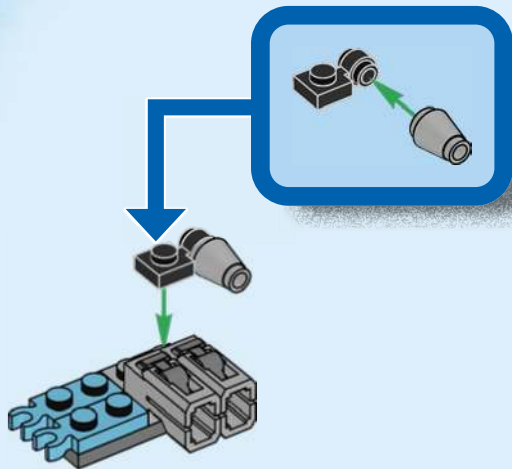

1x

34

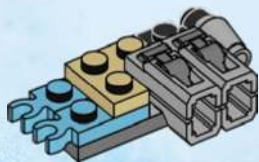

3x

35

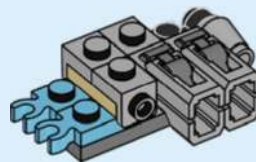

1x

36





1x

37

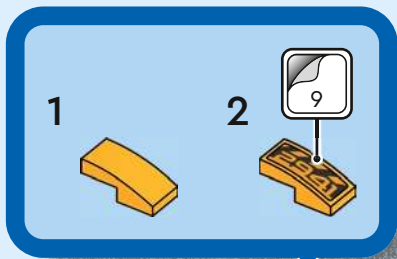

1x



1x

38

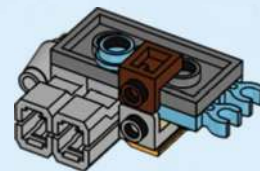

1x

39

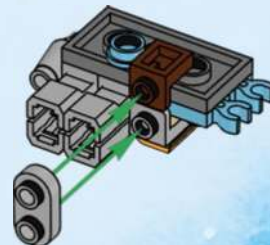



1x

40



1x

41

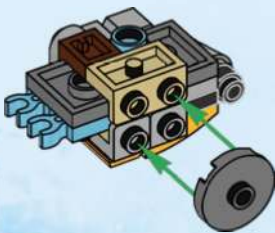

1x

42

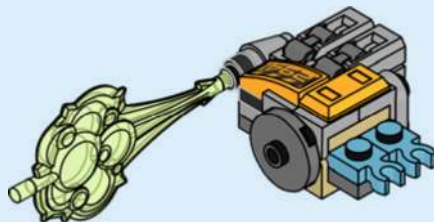

43

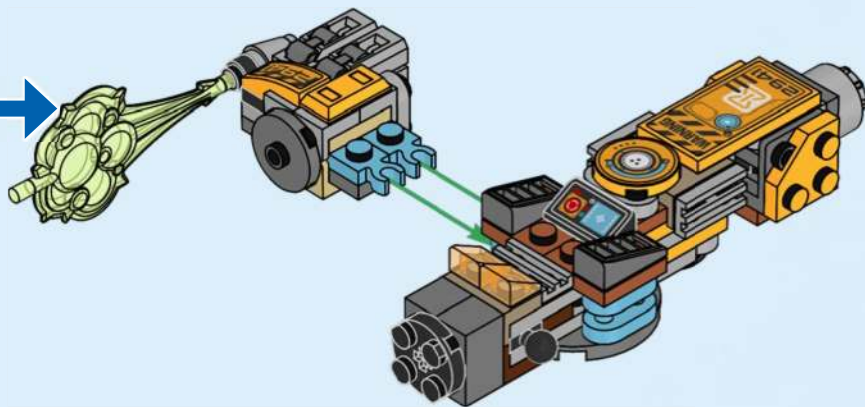



44

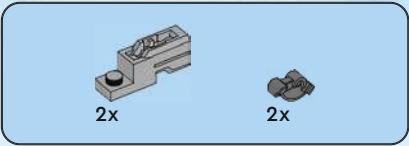
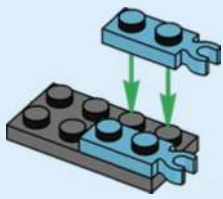

45

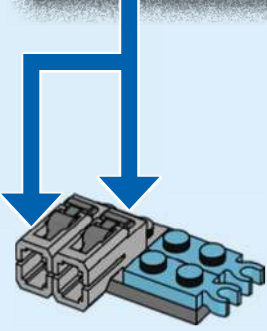
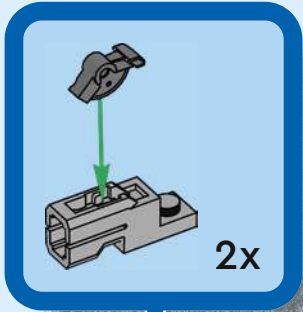



1x



1x

46

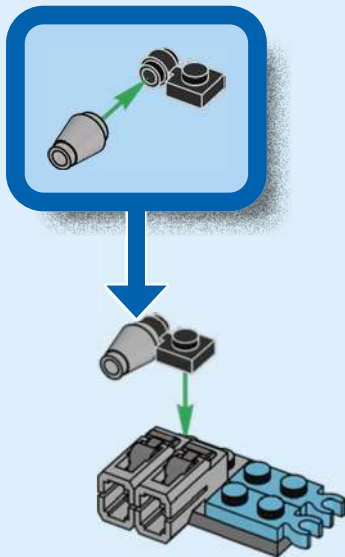

1x

47

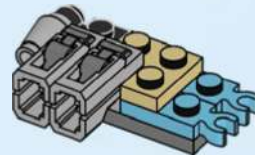



48

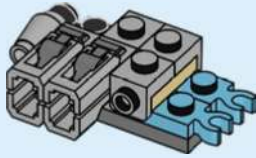

49

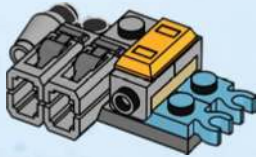

50



1x

1x

51

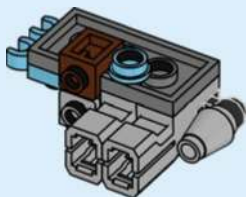

1x

52

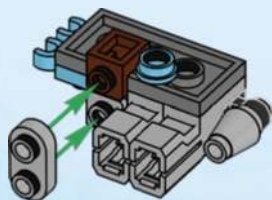

1x

53





54

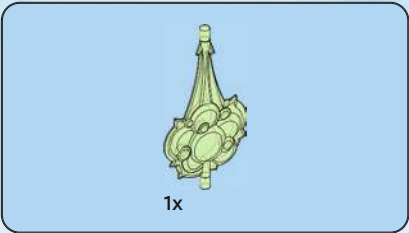
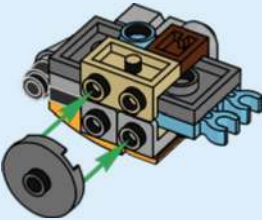

55



56

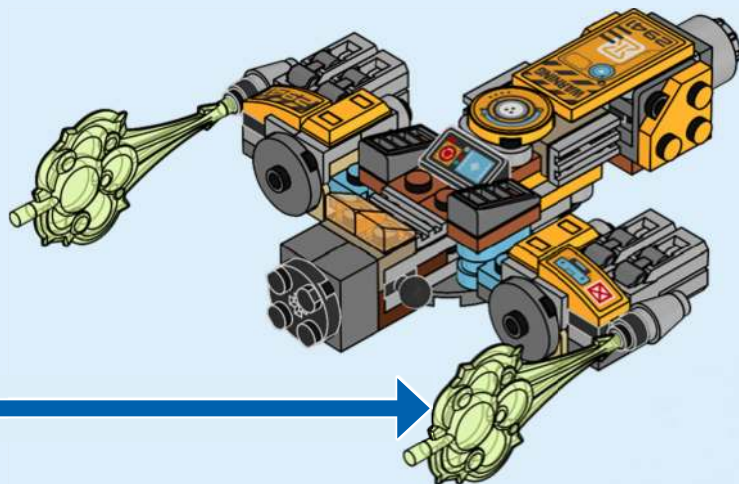

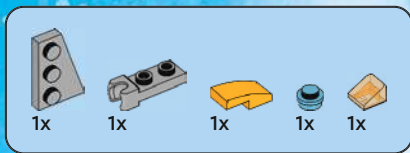

57

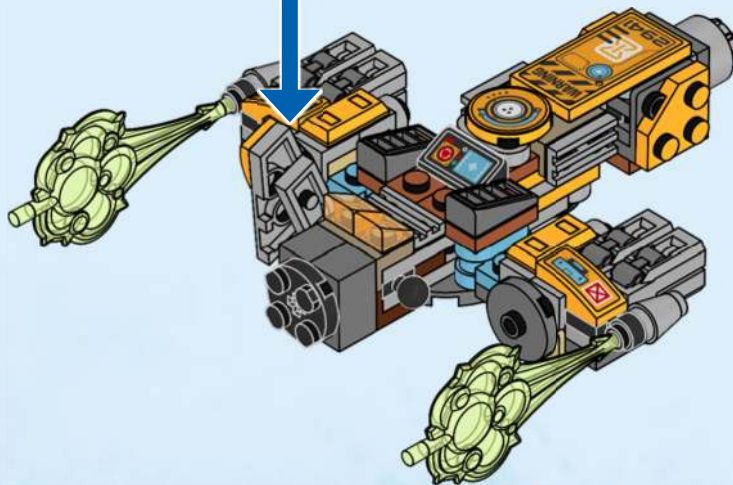
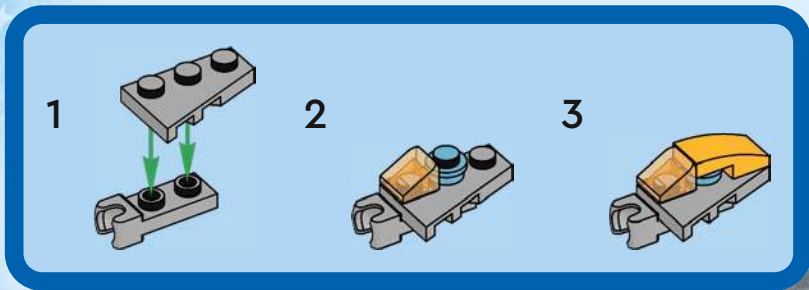

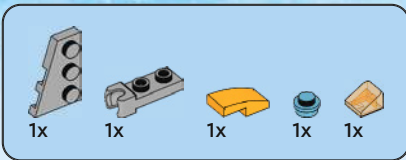

58

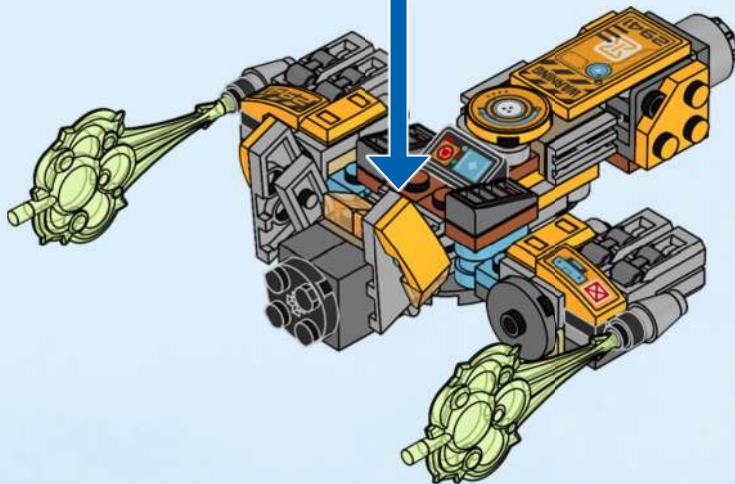
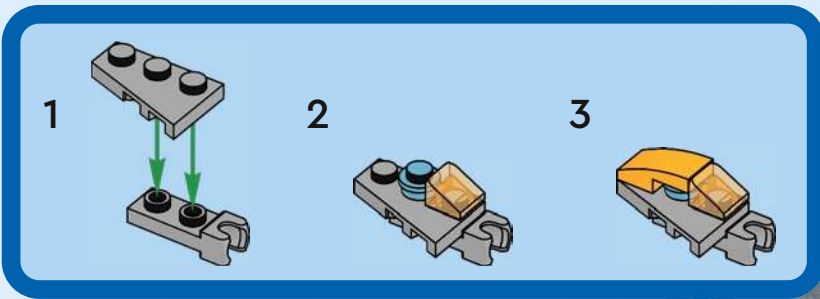

59

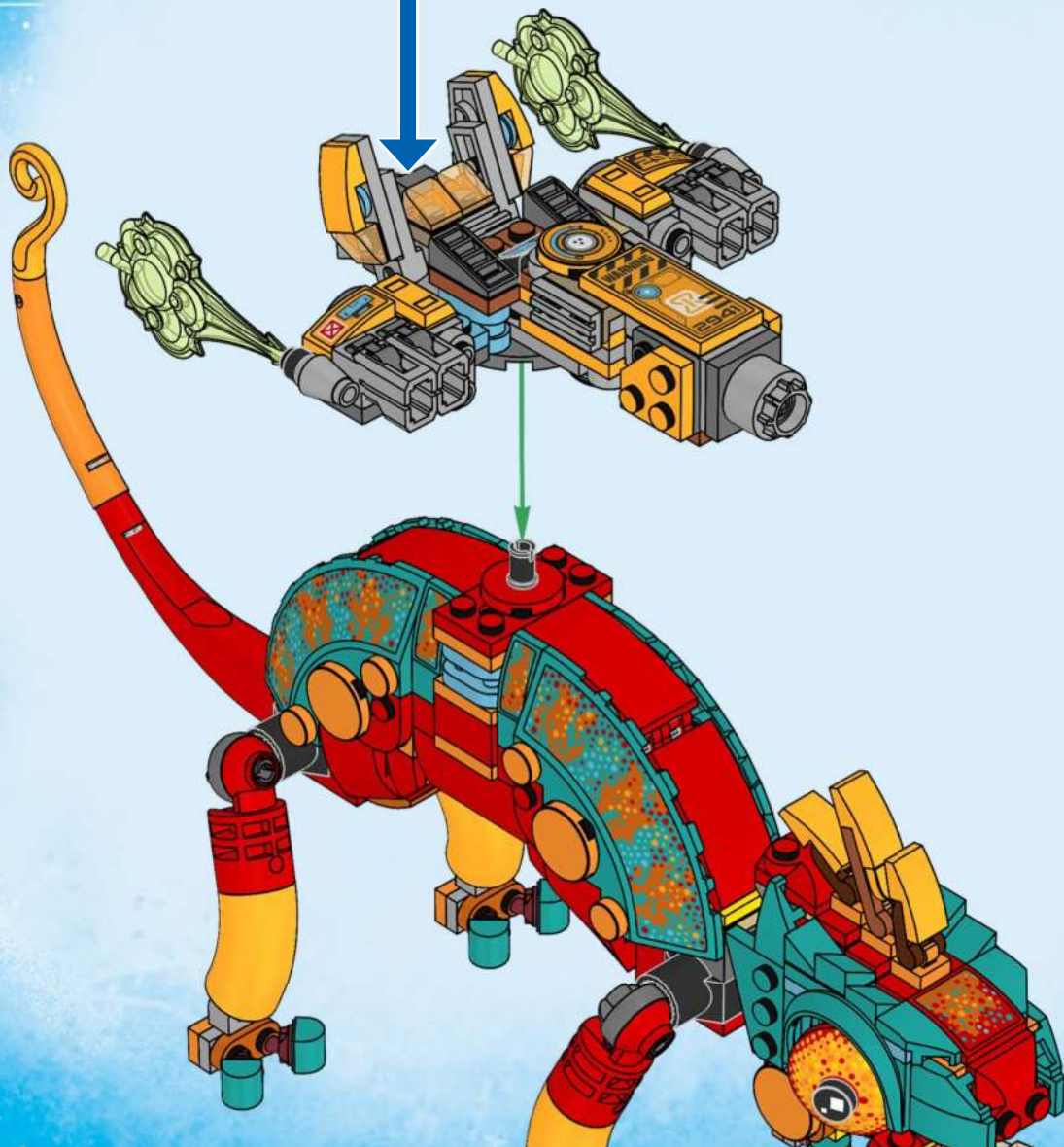



8x

60

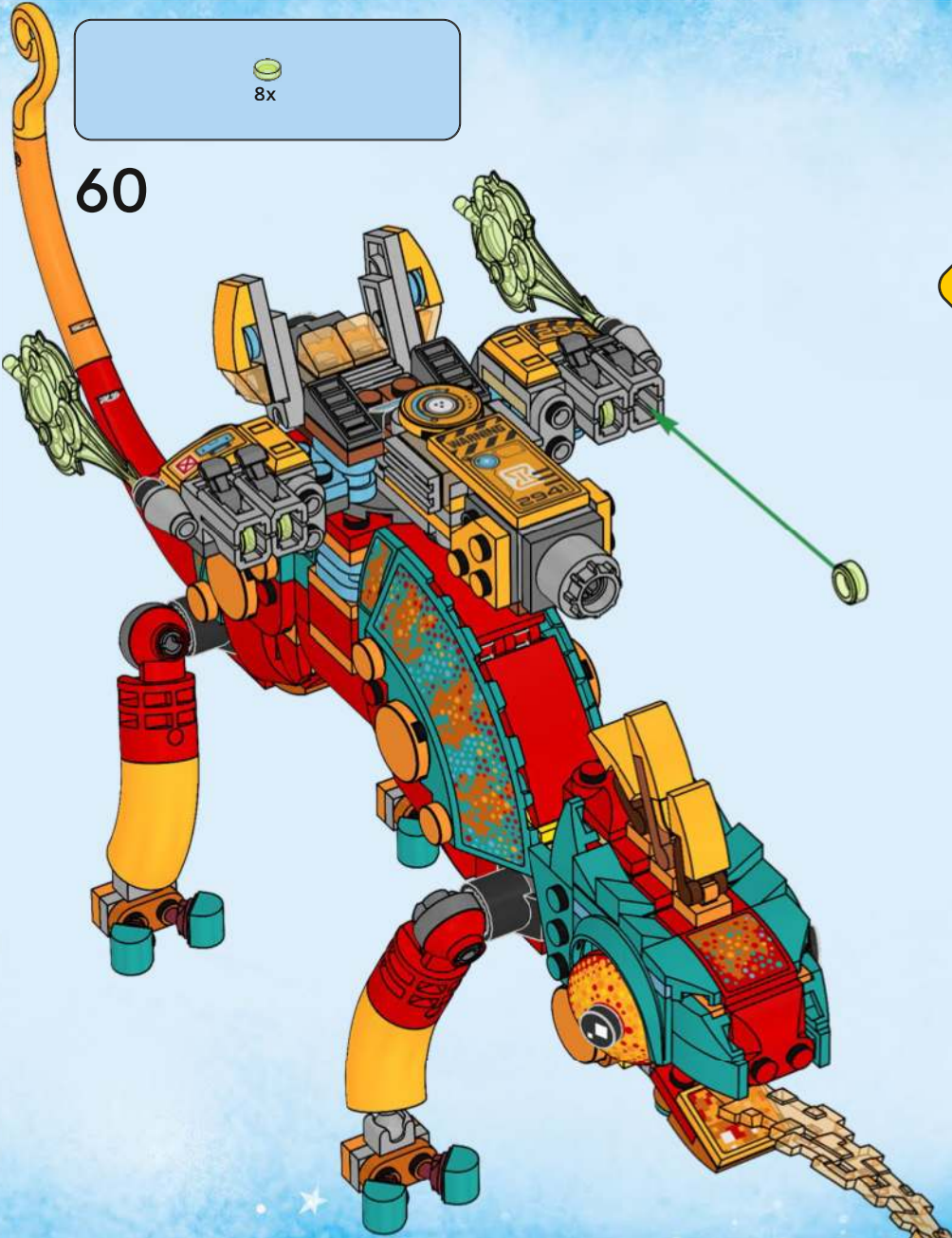

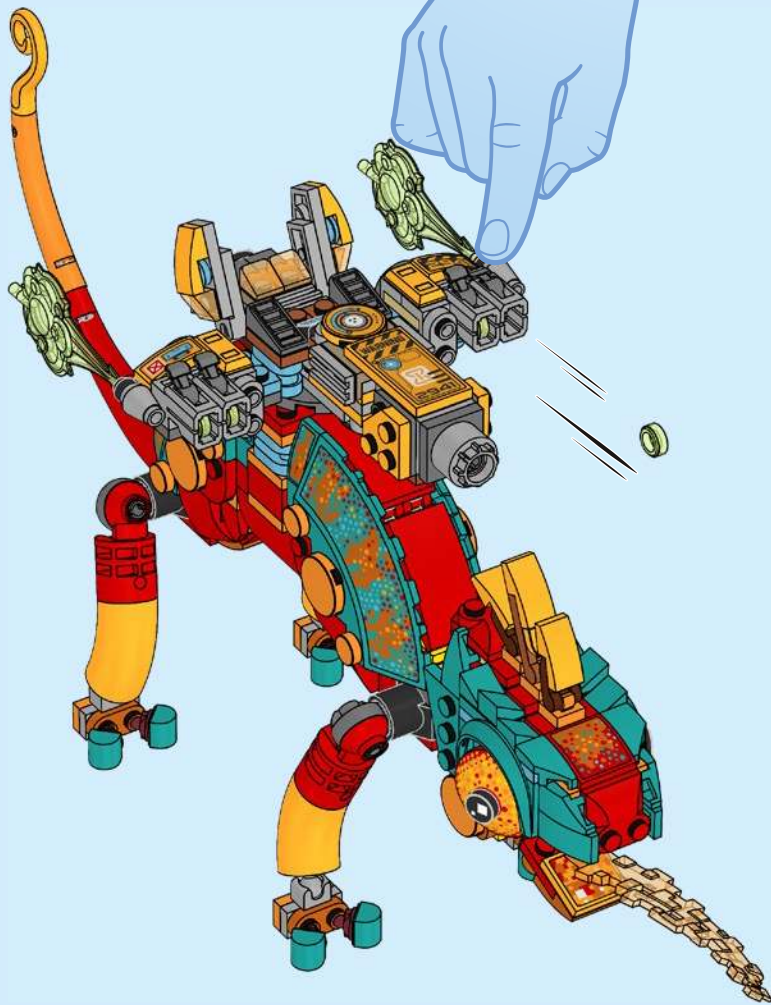





1

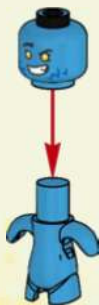

2

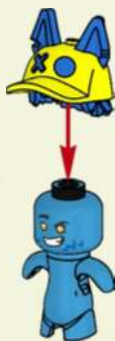

3





1

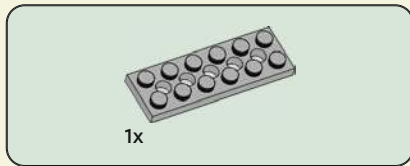
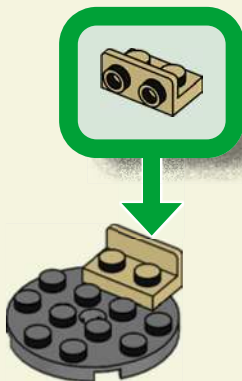

2



3

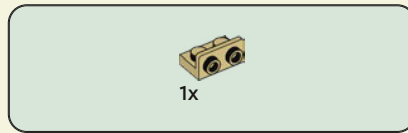
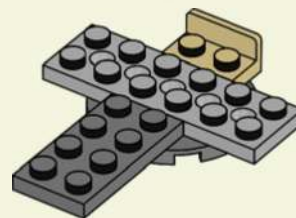

4





1x

5

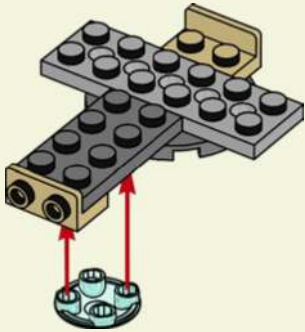

1x

6

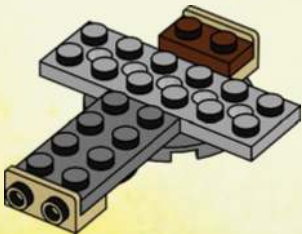

1x

7

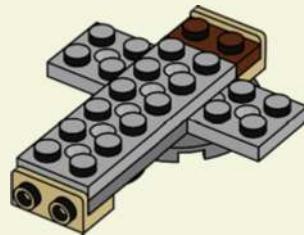

2x

8

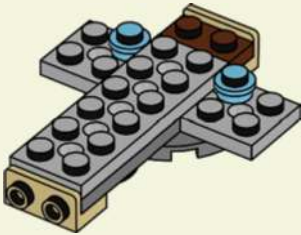

2x

9

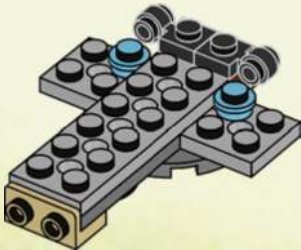

2x

2x

10

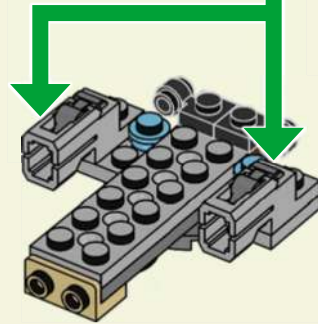
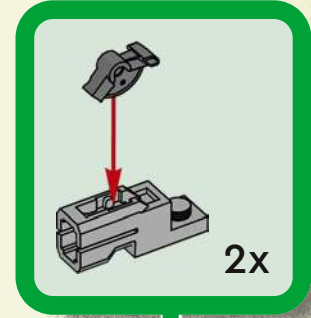



1x

11

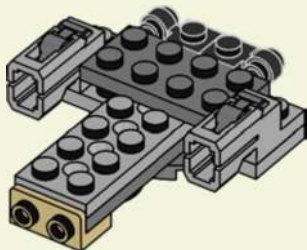

1x

12

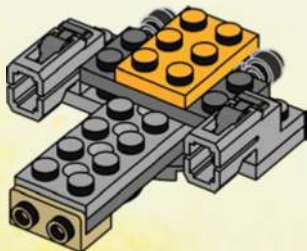

2x

13

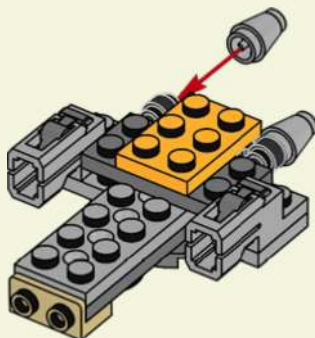



1x

14

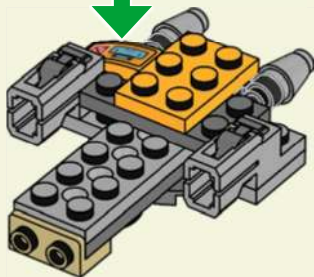
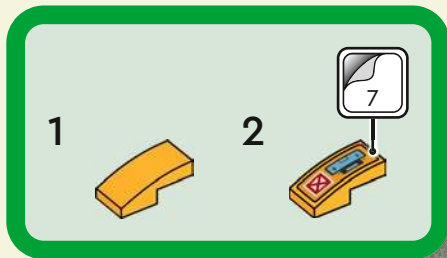

1x

15

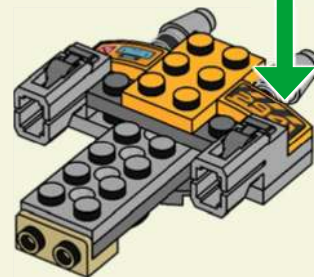
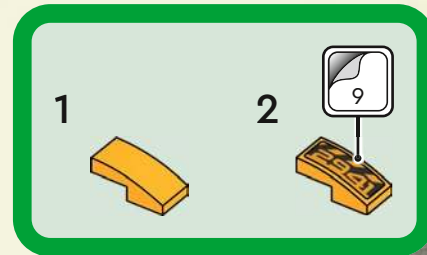



16

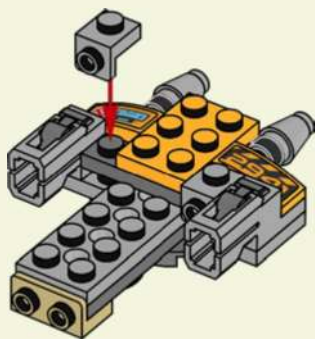

17

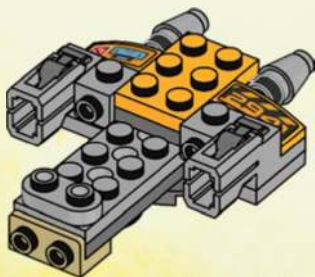

18

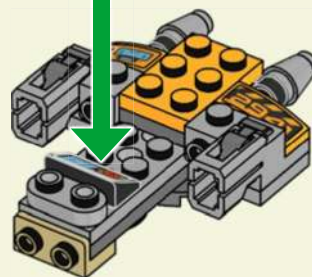



2x

19



2x

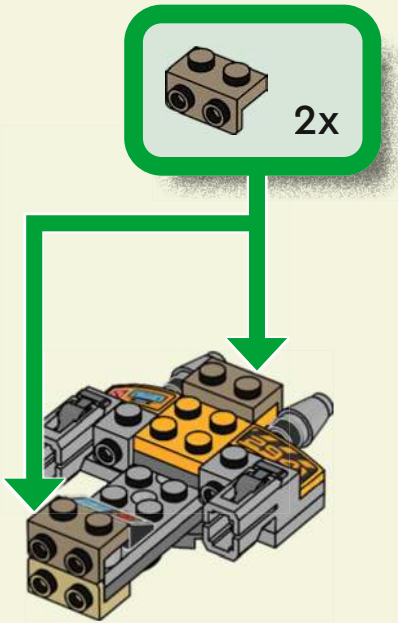

2x

20

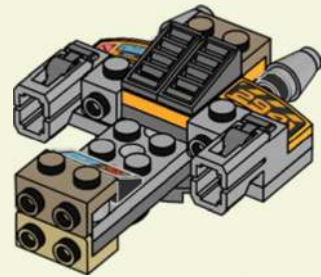

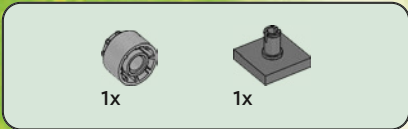

21

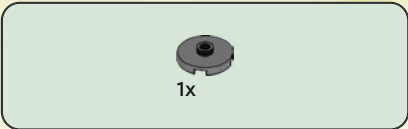
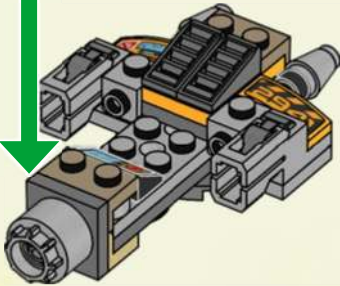
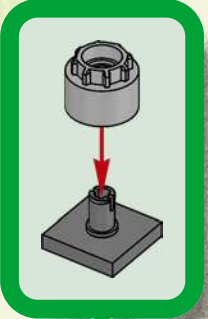

22

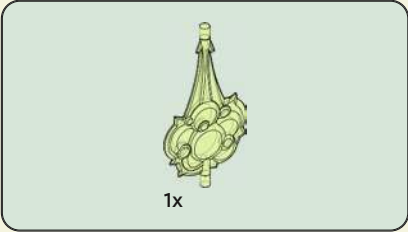

23

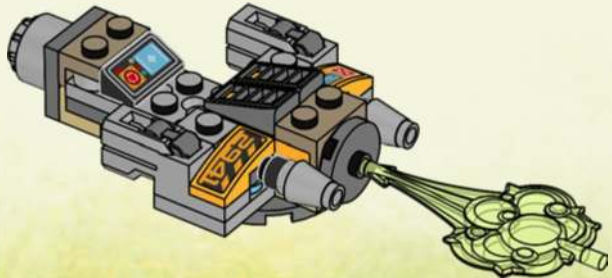



4x

24

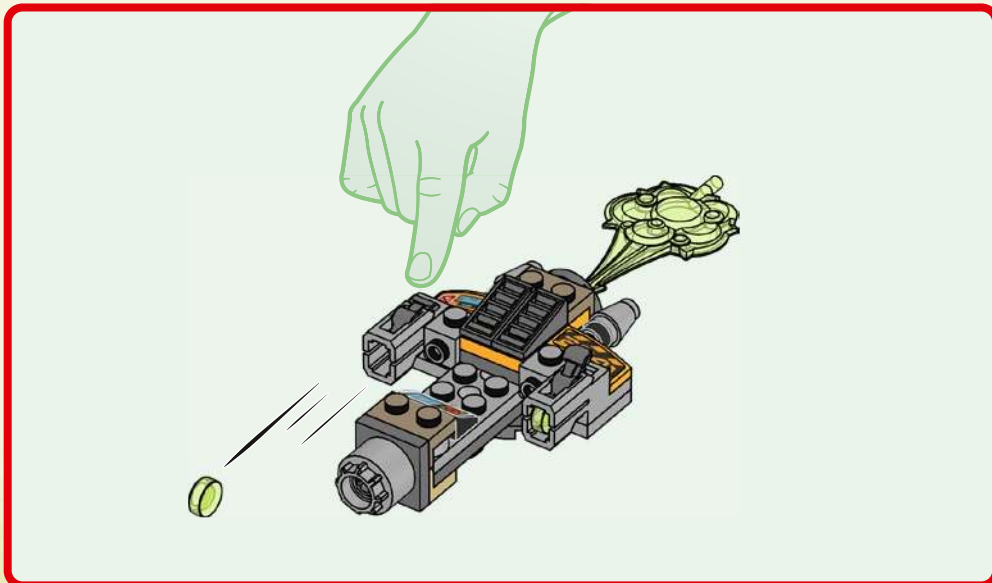
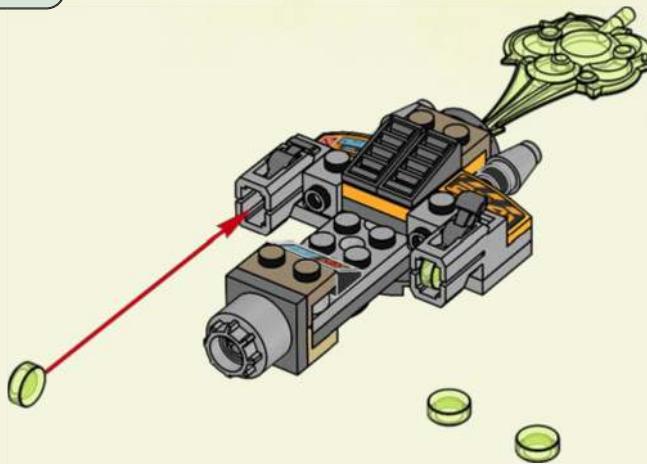

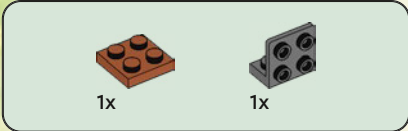
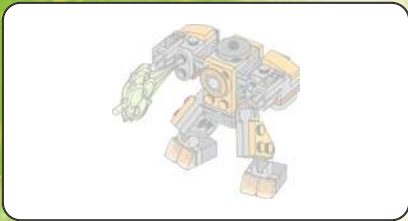

1

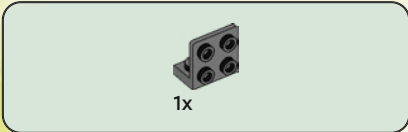

2



3

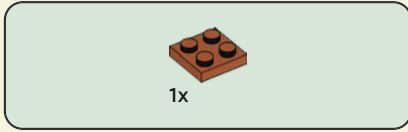

4





1x

5



1x



2x

6



1x

7



2x

8

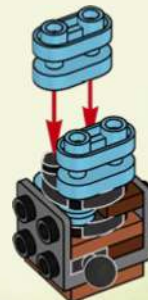

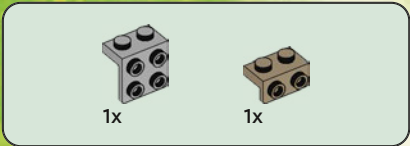

9

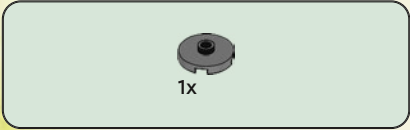

10

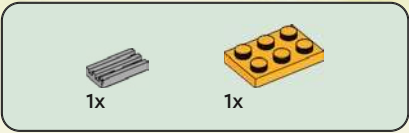

11

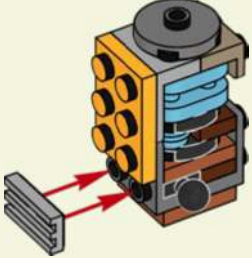

12



13

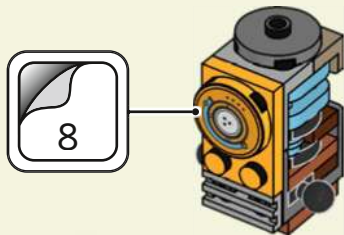

14

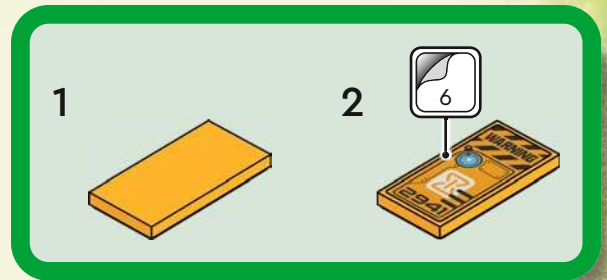
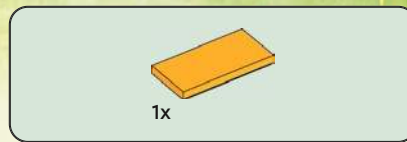



1x



1x

15

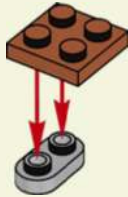

2x

16

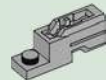

1x



1x

17

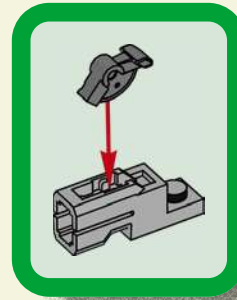

2x

18

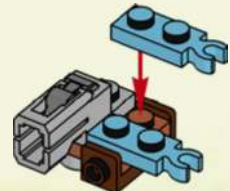



19



20

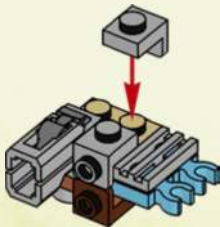

21

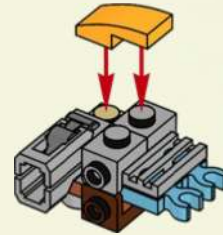

22





1x

23

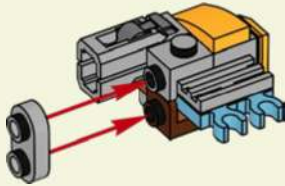

24

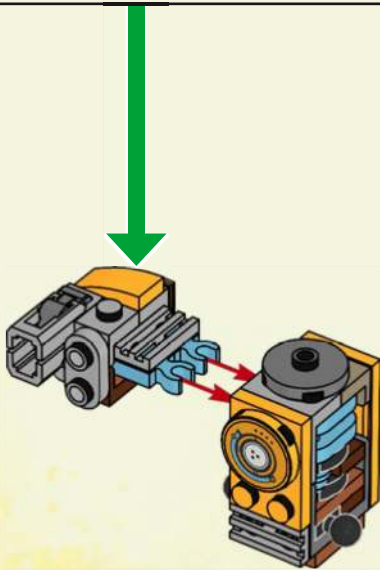

1x

25

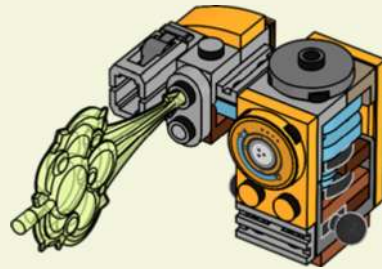



1x

1x

26



2x

27



1x



1x

28

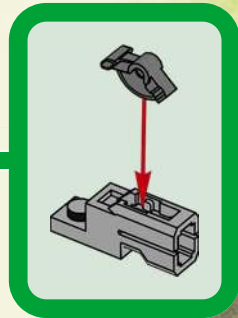
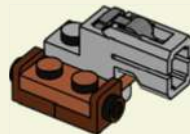

2x

29

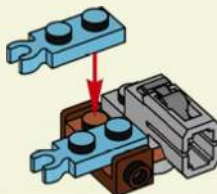



33



34

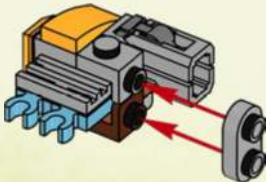

35

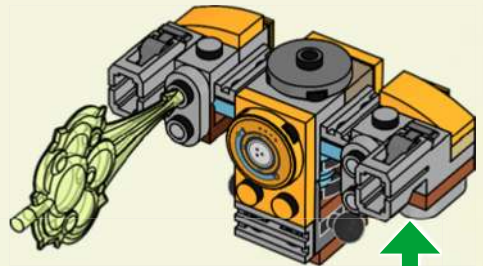

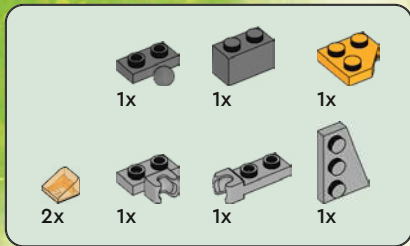

36

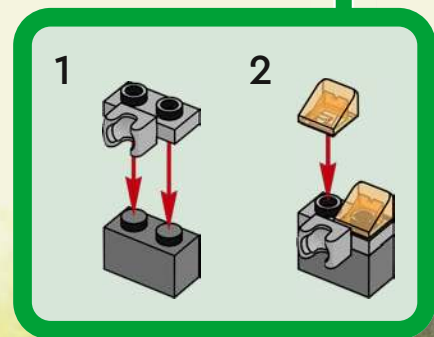
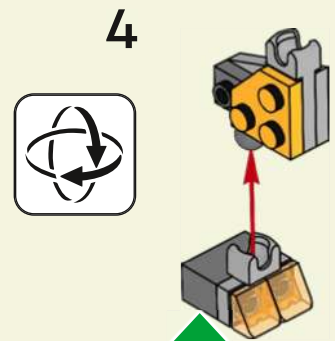
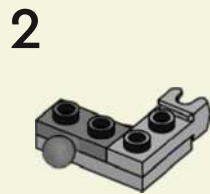
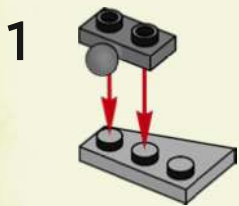

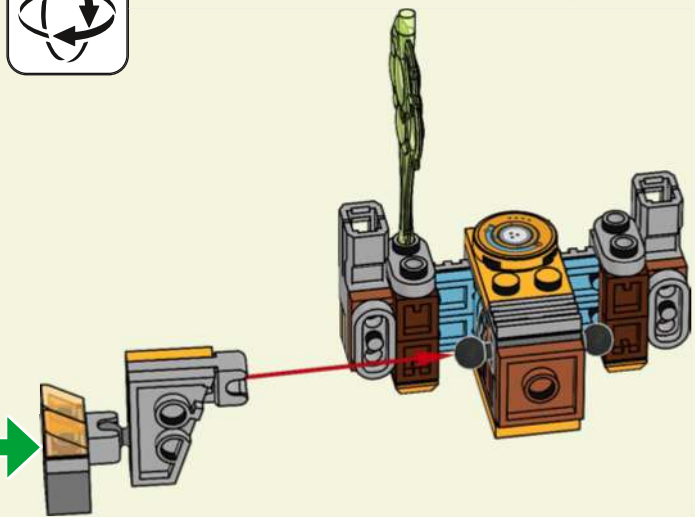

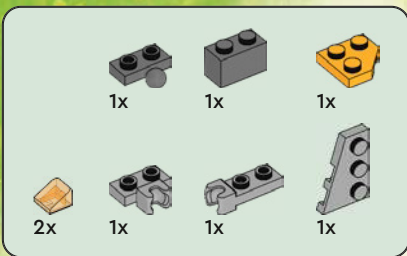

37

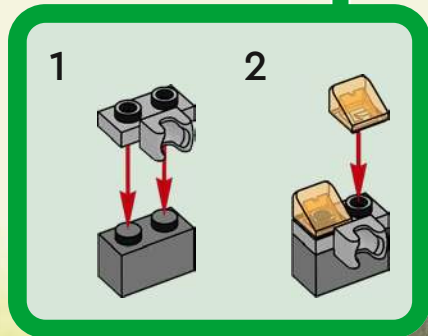
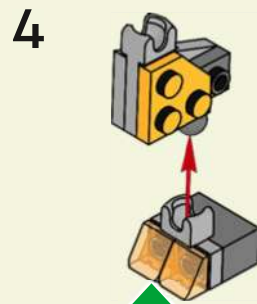
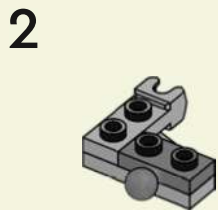
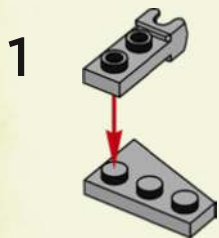

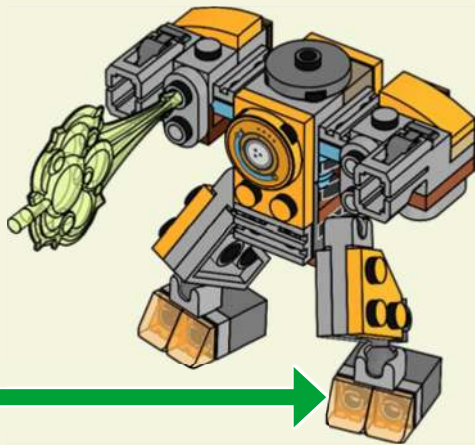



4x

38

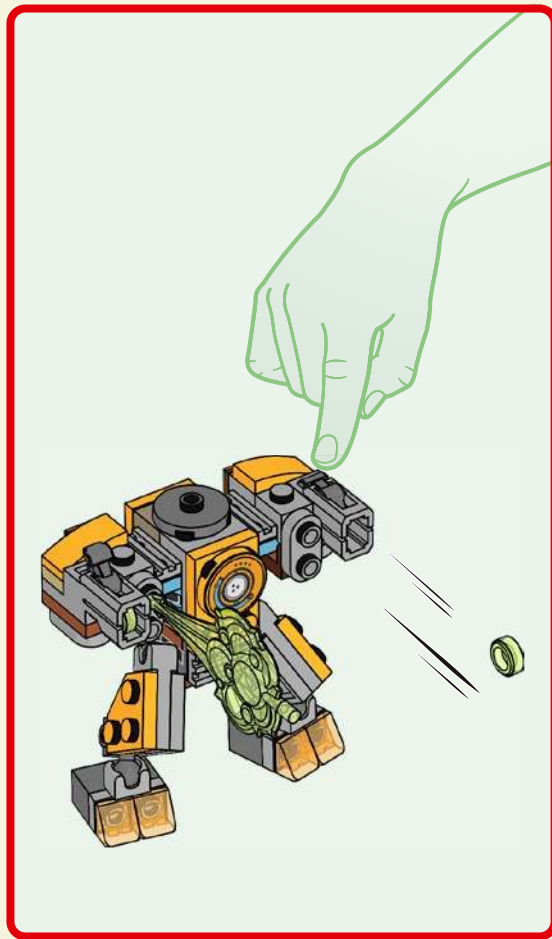
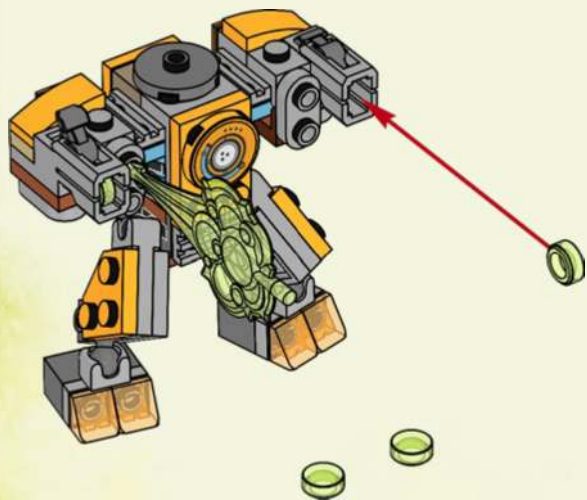



LEGO

DREAMZZZ



71491



71492



71494



71495



71497



71499



71500





DREAMZZZ



Watch series online
Schau dir die Serie online an
Regarde la série en ligne
Guarda la serie online
Mira la serie en Internet
Assistir à série online

在线观看
Oglądaj serial w internecie
Sleduj serial online
Pozri si serial online
Nézd a sorozatot online
Дивіться серіал онлайн

Vizionează serialul online
Гледайте сериала онлайн
Skaties seriālu tiešsaistē
Vaata sarja veebist
Žiūrėk serialą internetu

WATCH
SERIES
ONLINE 



Rebuild

the

World™



3x
6168642
 1x
6284572
 2x
6446788
 1x
6221783
 1x
6528261
 4x
6218823
 2x
4140583
 1x
6009016
 4x
6374151
 2x
6313611
 1x
4217562
 4x
4114084
 2x
4114077
 1x
4114309



1x
6030980



4x
307021



2x
6177505



2x
6177507



1x
6102138



3x
6092565



2x
6346804



2x
4220515



3x
302221



1x
6105976



2x
366021



4x
6384910



2x
6436413



4x
6209519



4x
4515365



2x
6535410



1x
6532363



4x
6538216



2x
6436412



1x
6545627



1x
6406930



1x
370921



4x
4613174



1x
300121



2x
4597912



1x
6538738



2x
6486088



2x
366621



2x
379521



2x
4206482



1x
6487046



2x
6208753



1x
6061025



2x
306824



4x
362324



2x
4164073



2x
4598897



4x
6315887



2x
6168646



2x
6284077



1x
6473449



2x
6439039



1x
6523345



1x
6523361



4x
6228987



1x
6523346



1x
6323189



1x
6471982



4x
403226



1x
6279875



4x
6281993



1x
6523363



2x
6310268



1x
6089119



1x
6416838



1x
6116604



2x
6296186



4x
4615606



1x
6477977



3x
6359717



2x
6513950



1x
6471982



1x
6509654



1x
6532230



1x
6171733



8x
6284582



3x
6472962



6x
6092770



24x
4177932



1x
6545628



3x
4153825



2x
4158355



6x
6278172



3x
6291018



4x
6213782



8x
6295358



1x
6291004

1x
6291006

3x
6291017

6x
6249427

1x
6338181

2x
6465251

4x
6538217

4x
6270108

1x
4212454

4x
4183133

2x
6452010

3x
6328477

8x
6510194

1x
6313554

1x
6545629

1x
6131589

7x
6099728

2x
6236454

2x
6526569

1x
6020147

2x
6097503

4x
6510157

1x
4621543

1x
6097509

4x
6238874

2x
6153863

1x
6523477

3x
4211150

4x
4211257

1x
6365882

2x
4529241

1x
6510189

4x
4558953

6x
6248078

4x
6443149

6x
6248890

1x
4211791

1x
4211794

1x
6307931

8x
6043656

3x
4211350

1x
6117967

1x
6301870

2x
4211397

2x
6043639

4x
6360382

2x
4211542

2x
6388120

2x
6364352

4x
6360675

2x
4278274

3x
6115080

2x
6039479

2x
4211088

2x
4540386

2x
6308045

4x
4522784

1x
6313189

1x
4497253

1x
4528323

2x
4211065

1x
6514726

8x
6527033

3x
6529630

2x
6514196

4x
6102986

2x
6097493

4x
6525399

4x
6441239

1x
6070757

1x
6514024

8x
6514198

1x
6523330

2x
6510438

1x
6523353

4x
6245265

1x
6544726

2x
6527625

1x
6487093

1x
6435593

4x
6523387

1x
6531587

1x
6186672

1x
6554482

 [LEGO.com/service](https://www.LEGO.com/service)



YOU COULD WIN

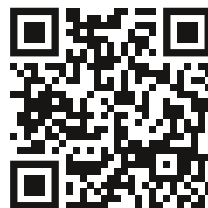

Scan this QR code or go to **LEGO.COM/PRODUCTFEEDBACK** and give us your short feedback about this LEGO® set for a chance to win a cool LEGO prize.

Terms and Conditions apply*



EN: YOU COULD WIN. Terms and Conditions apply* **DE: Du könntest GEWINNEN.** Es gelten die Teilnahmebedingungen* **FR: Tu pourrais GAGNER.** Des conditions s'appliquent* **IT: Potresti VINCERE tu.** Termini e condizioni sono applicabili* **ES: Puedes GANAR.** Aplican términos y condiciones* **PT: PODERÁ GANHAR.** Aplicam-se Termos e Condições* **ZH: 轻松获奖.** 条款和条件适用* **PL: Szansa na WYGRANĄ.** Obowiązuje regulamin* **CS: Máte šanci VYHRÁT.** Platí všeobecné smluvní podmínky* **SK: Máte šancu VYHRAŤ.** Platia všeobecné zmluvné podmienky* **HU: TE IS NYERHETSZ.** Felhasználási feltételek érvényesek* **UA: ВИ МОЖЕТЕ ВИГРАТИ.** Застосовуються загальні положення та умови* **RO: Ai putea CÂȘTIGA.** Se aplică termeni și condiții* **BG: Можете да СПЕЧЕЛИТЕ.** Има определени правила и условия* **LV: Tu vari LAIMĒT.** Ir spēkā noteikumi un nosacījumi.* **ET: Sul on võimalus VÕITA.** Kehtivad tingimused* **LT: Jūs galite LAIMĖTI.** Taikomos sąlygos* **LEGO.com/productfeedback-terms*