

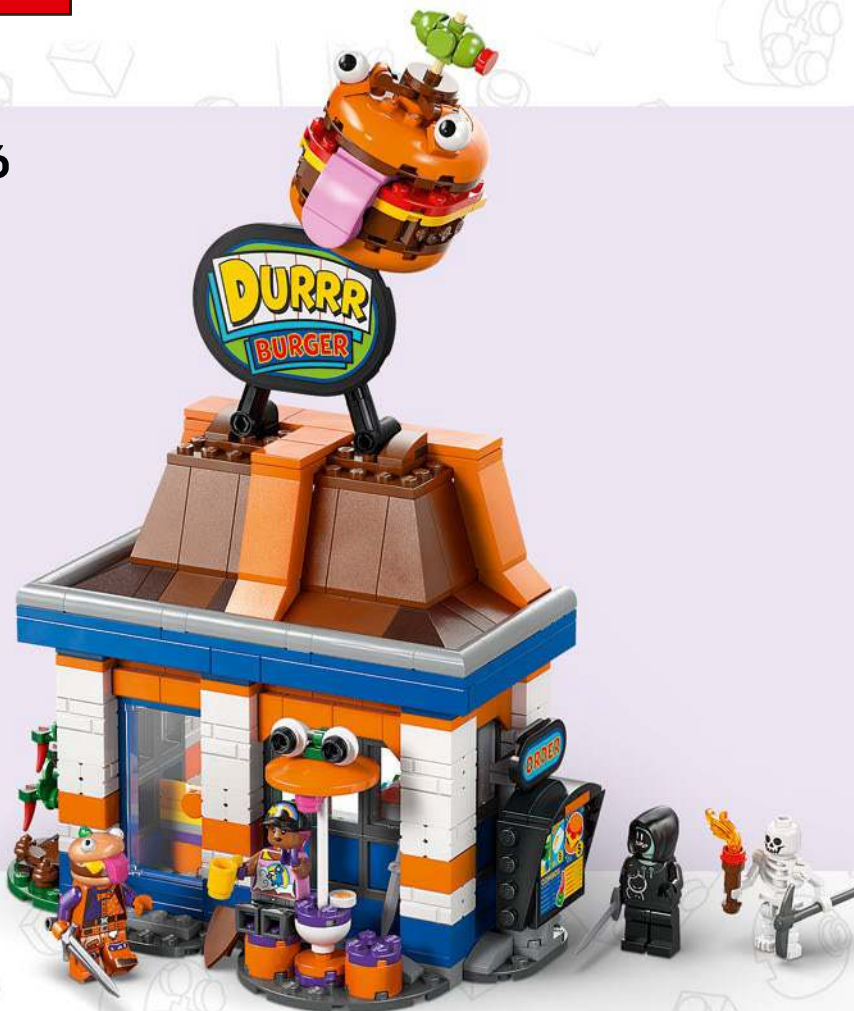

FORTNITE®

77076



Q LEGO® Builder



LEGO.com/sustainable-packaging



FR
DONNEZ
OU
RECYCLEZ



OU



OU



ASSOCIATION

MAGASIN

DÉCHÈTERIE

Adresses sur quefairedemesdechets.fr

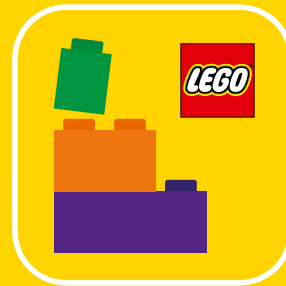

BUILDER



Apple and the Apple logo are trademarks of Apple Inc., registered in the U.S. and other countries and regions. App Store is a service mark of Apple Inc. Google Play and the Google Play logo are trademarks of Google LLC. Tencent and the Tencent logo are trademarks of Tencent Inc.



EN Ask parents' permission before going online | **DE** Eltern um Erlaubnis bitten, bevor du online gehst | **FR** Demande l'autorisation d'un parent avant d'aller en ligne | **IT** Chiedi il permesso ai tuoi genitori prima di andare online | **ES** Pídeles permiso a tus papás antes de conectarte a Internet | **PT** Peça autorização aos pais antes de acederes online | **ZH** 上网前应先征得父母的同意 | **PL** Poproś rodziców o zgodę, zanim wejdziesz do Internetu | **CS** Než půjdeš na internet, požádej rodiče o svolení | **SK** Skôr než pôjdeš na internet, vypýtaj si povolenie od rodičov | **HU** Kérj szülői engedélyt, mielőtt online csatlakoznál! | **UA** Запитуйте дозволу батьків, перш ніж користуватися інтернетом | **RO** Cere permisiunea părinților înainte de a te conecta online | **BG** Поискайте разрешение от родител, преди да влезете онлайн | **LV** Pirms došanās tiešsaistē palūdz atļauju vecākiem | **ET** Enne Interneti kasutamist küsi vanematelt luba | **LT** Prieš prisijungdami prie interneto, atsiklauskite tėvų



FORTNITE®

**REDEEM YOUR IN-GAME
BONUS OUTFIT!**

Offer not available in China

**1 Scan the QR code
and follow the steps**



Redeem your in-game bonus outfit!
Hol dir dein In-Game-Bonus-Outfit!
Réclamez votre équipement in-game bonus !
Riscatta il tuo outfit bonus in-game!
¡Canjea tu bonificación y consigue un traje para tus partidas!
Resgate o seu outfit de bônus!
兌換游戏中奖励的装备吧!
Odbierz swój prezent w postaci stroju z gry!
Získejte bonusový outfit do hry!
Uplatnite si bonusový outfit v hre!
Váltsd be játékon belül! bónusz outfited!
Активуйте своє ігрове бонусне вбрання!
Valorifică-ți Outfitul bonus pentru joc!
Вземте вашето бонус облекло за играта!
Izmanto savu spēles bonusu tērpul!
Lunasta oma mängusilene riidekomplekt!
Gaukrite papildomą żaidimo pavidalą!

Offer not available in China
Das Angebot ist in China nicht verfügbar
Offre non disponible en Chine
Offerta non disponibile in Cina
Oferta no disponible en China
Oferta não disponível na China
中国は対象外です
优惠不适用于中国
중국에서는 본 제안이 적용되지 않습니다
Oferta nie jest dostępna w Chinach
Nabídka neplatí v Číně
Ponuka nie je k dispozícii v Číne
Az ajánlat Kínában nem érhető el
Пропозиція недоступна в Китаї
Oferta nu este disponibilă în China
Предложението не е налично в Китай
Piedāvājums nav pieejams Ķīnā
Pakkumīne pole Hliinas saadaval
Pasiūlymas nepasiekiamas Kinijoje
Kampanya, Çin'de geçerli değildir

- 1 Scan the QR code and follow the steps
- 1 Scanne den QR-Code und folge der Anleitung
- 1 Scannez le QR code et suivez ces étapes
- 1 Scansiona il codice QR e segui i passaggi
- 1 Escanea el código QR y sigue los pasos
- 1 Faça scan do código QR e siga os passos
- 1 扫描二维码并按步骤操作
- 1 Zeskanuj kod QR i wykonaj opisane kroki
- 1 Naskenujte QR kód a postupujte podle návodu
- 1 Naskenujte QR kód a postupujte podľa pokynov
- 1 Olvasd be a QR-kódot és kövesd a lépéseket!
- 1 Проскануйте QR-код та виконайте дії
- 1 Scanează codul QR și urmează pașii
- 1 Сканирайте QR кода и следвайте стъпките
- 1 Skenē QR kodu un veic šīs darbības
- 1 Skaneeri QR-kood ja järgi edasisi samme
- 1 Nuskaitykite QR kodą ir atlikite reikiamus veiksmus

Ask parents' permission before going online



Ask parents' permission before going online
Eltern um Erlaubnis bitten, bevor du online gehst
Demande l'autorisation d'un parent avant d'aller en ligne

Chiedi il permesso ai tuoi genitori prima di andare online

Pídeles permiso a tus papás antes de conectarte a Internet

Pede autorização aos pais antes de acederes online

上网前应先征得父母的同意

Poproś rodziców o zgodę, zanim wejdiesz do Internetu

Než půjdeš na internet, požádej rodiče o svolení

Skôr než pôjdeš na internet, vypýtaj si povolenie od rodičov

Kérj szülői engedélyt, mielőtt online csatlakoznál!

Запитуйте дозволу батьків, перш ніж користуватися інтернетом
Cere permisiunea părinților înainte de a te conecta online

Поискайте разрешение от родител, преди да влезете онлайн

Pirms došanās tiešsaistē palūdz atļauju vecākiem

Enne Interneti kasutamist küsi vanematelt luba
Prieš prisijungdami prie interneto, atsiklauskite tėvų

Terms and Conditions apply

2 Sign in/up and claim your code to redeem



Get Code

Get Code / Code erhalten / Obtenir le code /
Ottieni il codice / Obtenir código / Obter código /
获取编号 / Zdobać kod / Získat kód / Získat kód /
Kérem a kódot / Отримати код / Obține codul /
Взьомте код / Saņemt kodu / Hangi kod /
Gaukrite kodą

Terms and Conditions apply
Es gelten die Teilnahmebedingungen.
Offre soumise à conditions
Termini e condizioni sono applicabili
Sujeto a Términos y Condiciones
Aplicam-se Termos e Condições
《条款和条件》适用
Obowiązuje Regulamin
Platí všeobecné smluvní podmínky

Platia všeobecné zmluvné podmienky
A Felhasználási feltételek érvényesek.
Застосовуються Умови та положення
Se aplică termene și condiții
Прилагат се правила и условията
Ir spēkā noteikumi un nosacījumi
Kehtivad tingimused
Taikomos sąlygos

- 2 Sign in/up and claim your code to redeem
- 2 Melde dich an/logge dich ein und hol dir deinen Code
- 2 Inscrivez-vous/connectez-vous et demandez votre code ici pour recevoir votre bonus
- 2 Accedi/registrati e richiedi il tuo codice per riscattarlo
- 2 Inicia sesión/regístrate para recibir tu código y canjearlo
- 2 Registe-se ou inicie sessão e peça o seu código para resgatar
- 2 登录/注册并申请代码进行兑换
- 2 Zarejestruj się lub zaloguj się i odbierz swój kod
- 2 Zaregistrujte se/přihlaste se a vyzvedněte si svůj kód pro uplatnění
- 2 Prihláste alebo zaregistrujte sa a získajte kód na uplatnenie
- 2 Jelentkezz be/Regisztrálj és igényeld a kódod a beváltáshoz!
- 2 Увійдіть/зареєструйтеся та отримайте свій код для активації
- 2 Conectează-te/Inregistrează-te și revendică-ți codul pentru a-l folosi
- 2 Влезте в профила си/регистраирайте се и потърсете вашия код, за да вземете
- 2 Pieslēdzies/reģistrējies un iegūsti kodu, lai izmantotu
- 2 Liitu/logi sisse ja hangi lunastamiseks kood
- 2 Prisijunkite / užsiregistruokite ir gaukite kodą

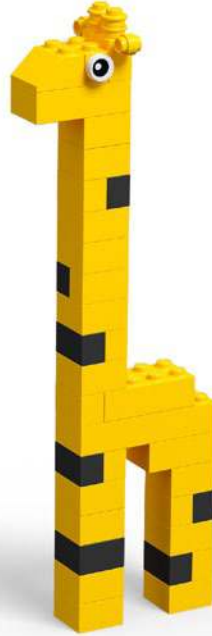

Rebuild

the

World™



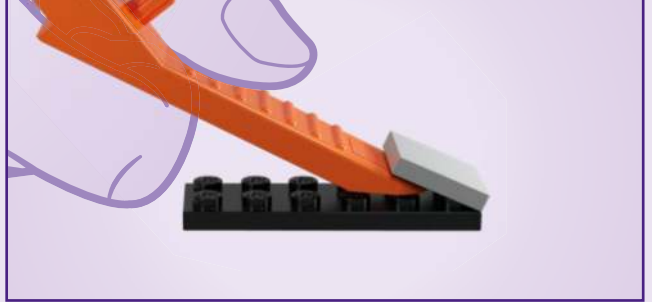
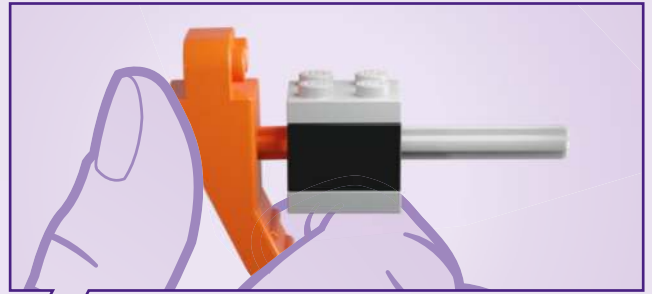

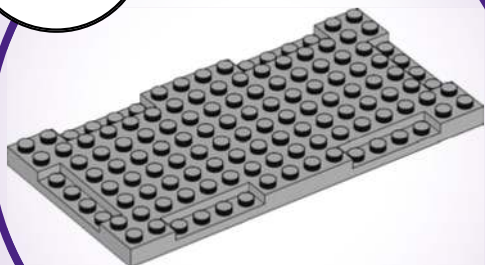
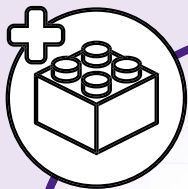

1x

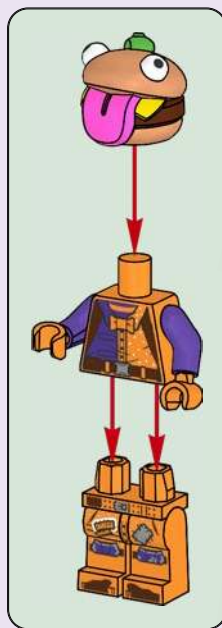

1

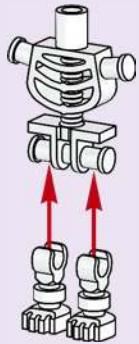

2

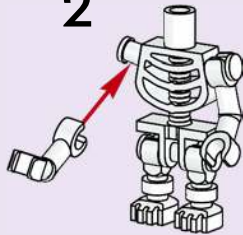

3

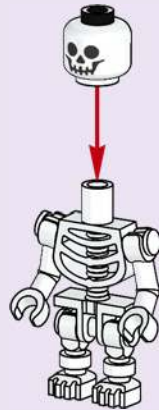

4

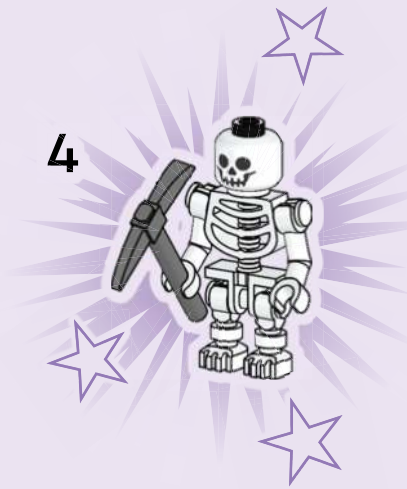

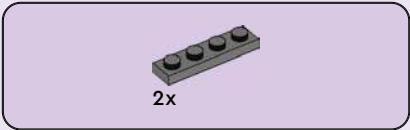

1

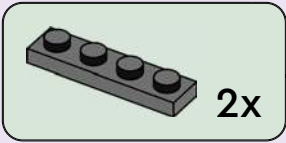
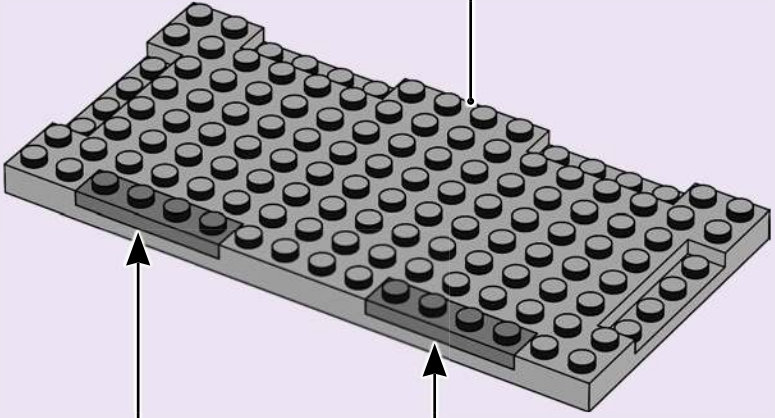
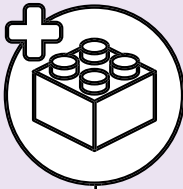



6x

2

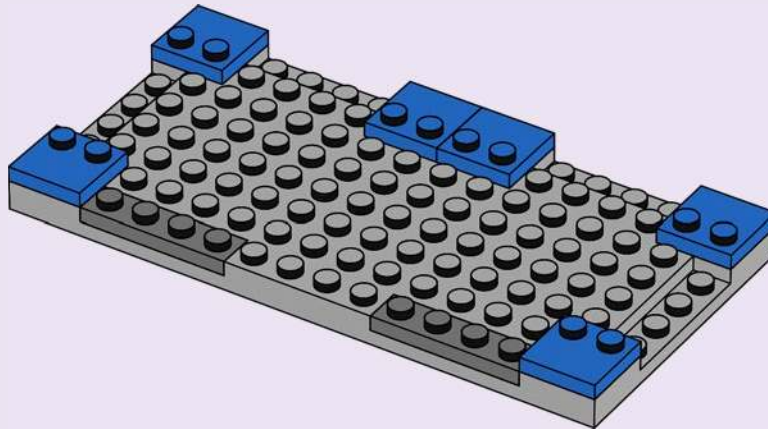

4x

3

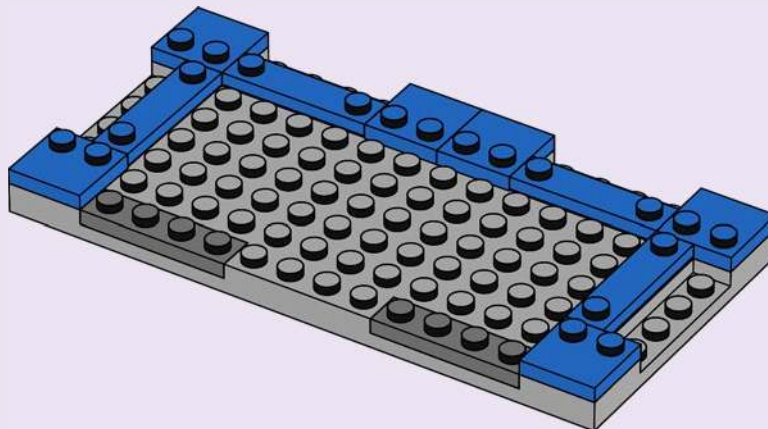

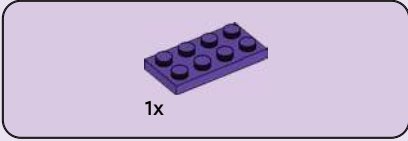
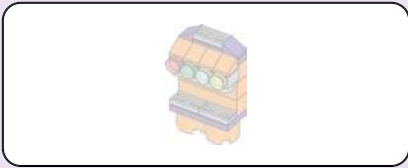

4

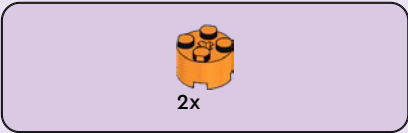

5



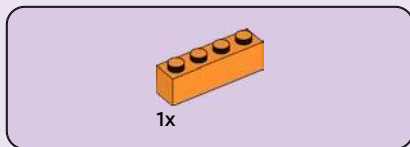

6

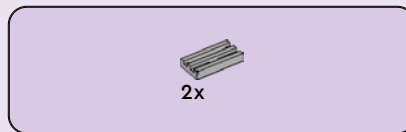
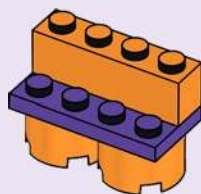

7

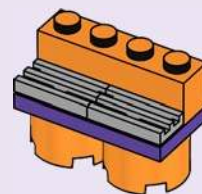

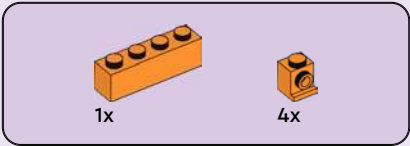

8

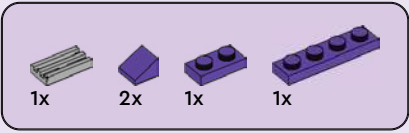
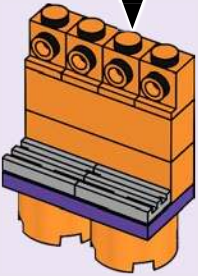
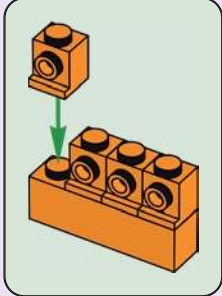

9

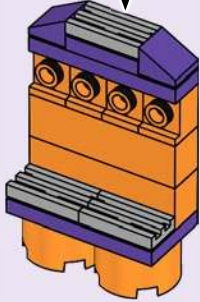
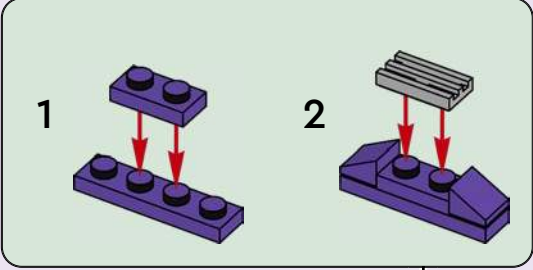

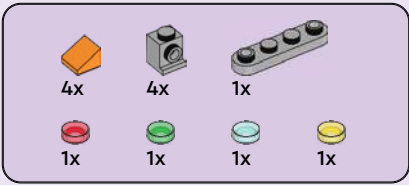

10

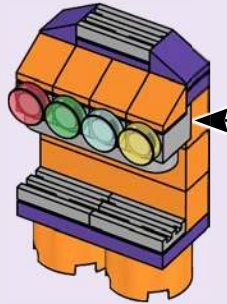
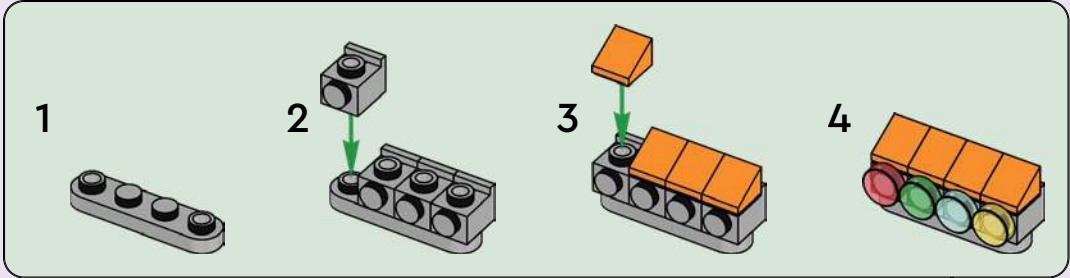

11

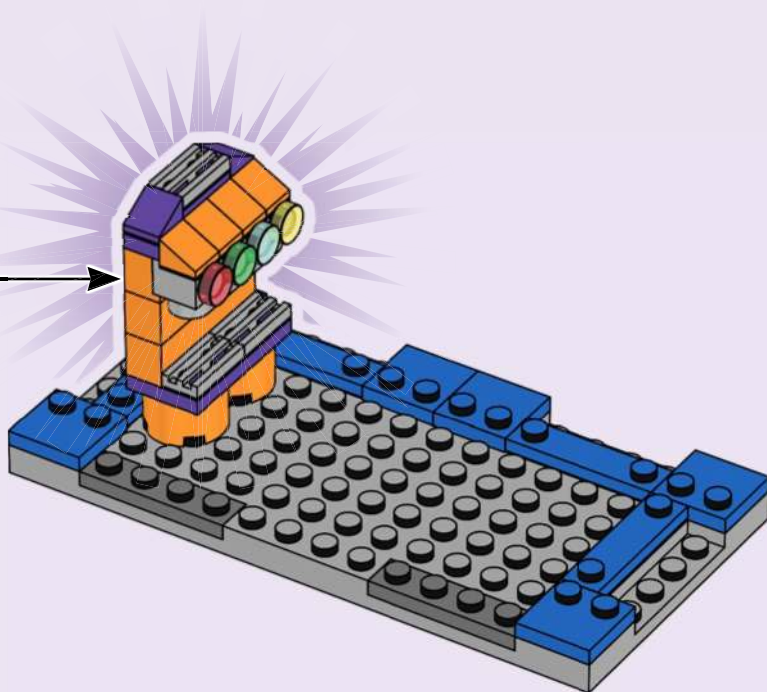

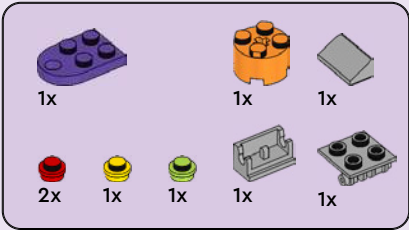

12

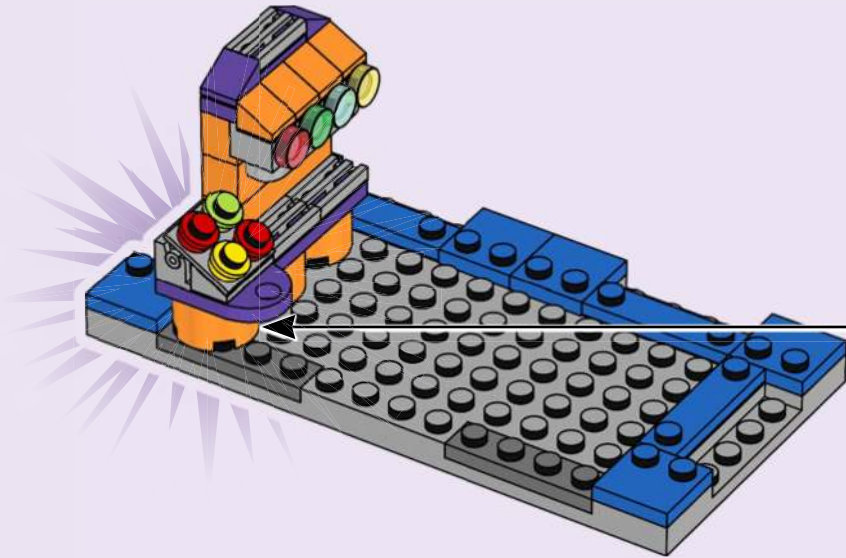
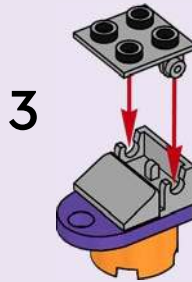
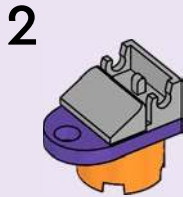
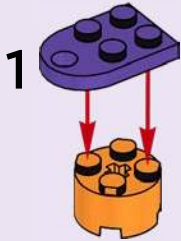

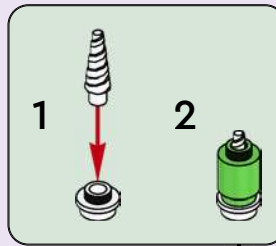
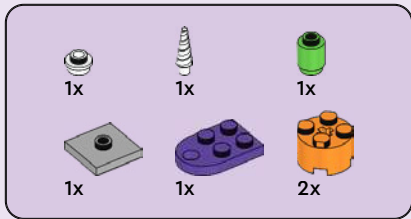

13

1



2



3

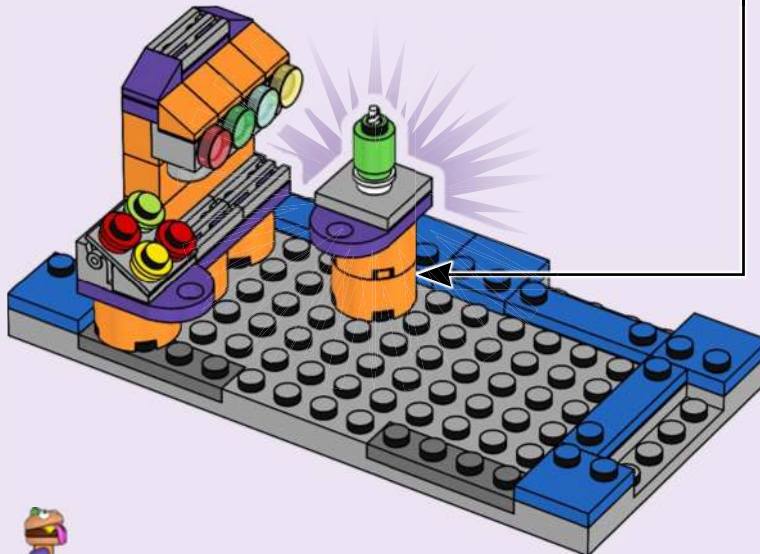

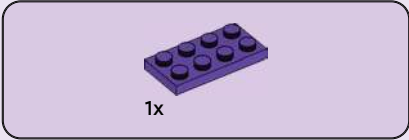
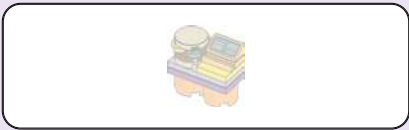

14

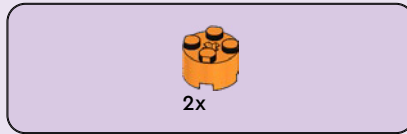
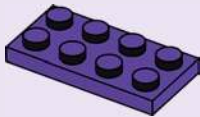

15

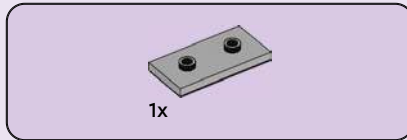
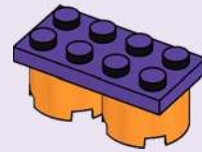

16

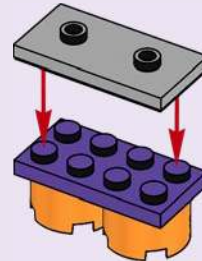



17

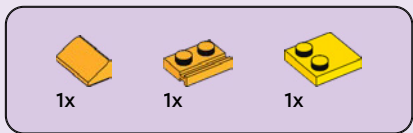
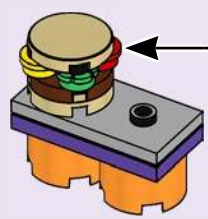
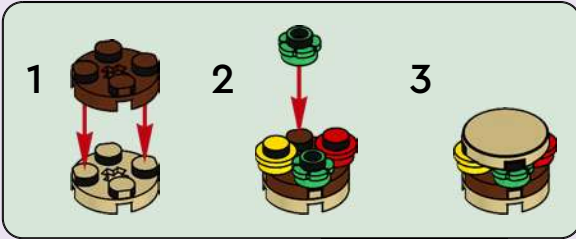

18

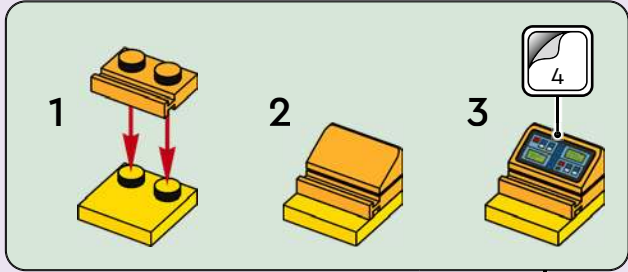

19

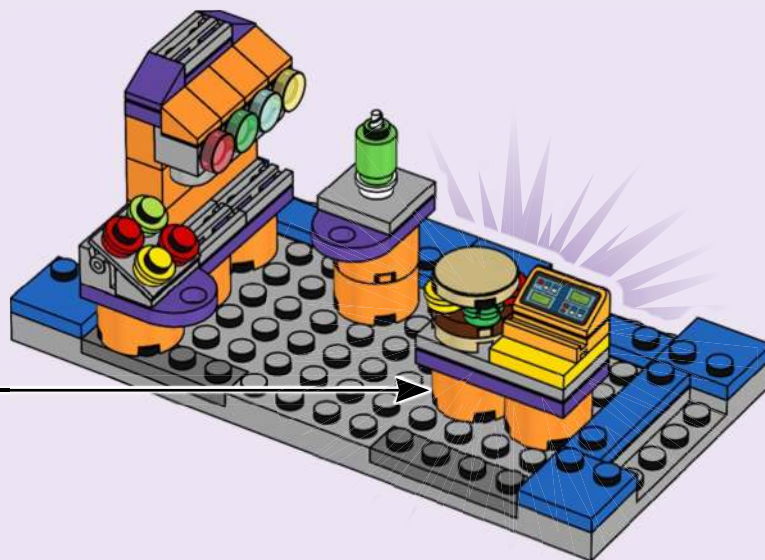

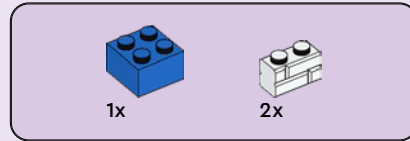
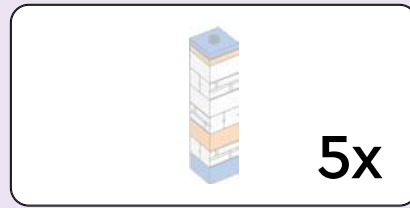

20

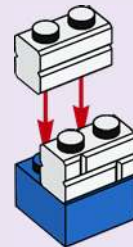



1x



2x

21



1x

22

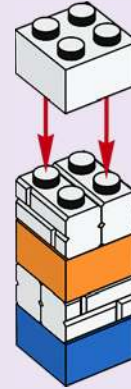

2x

23

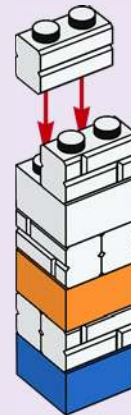



1x

24

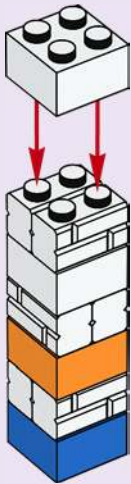

1x



1x

25

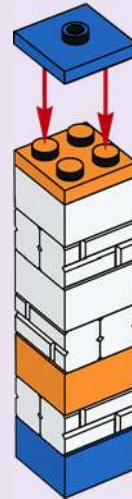

5x



26

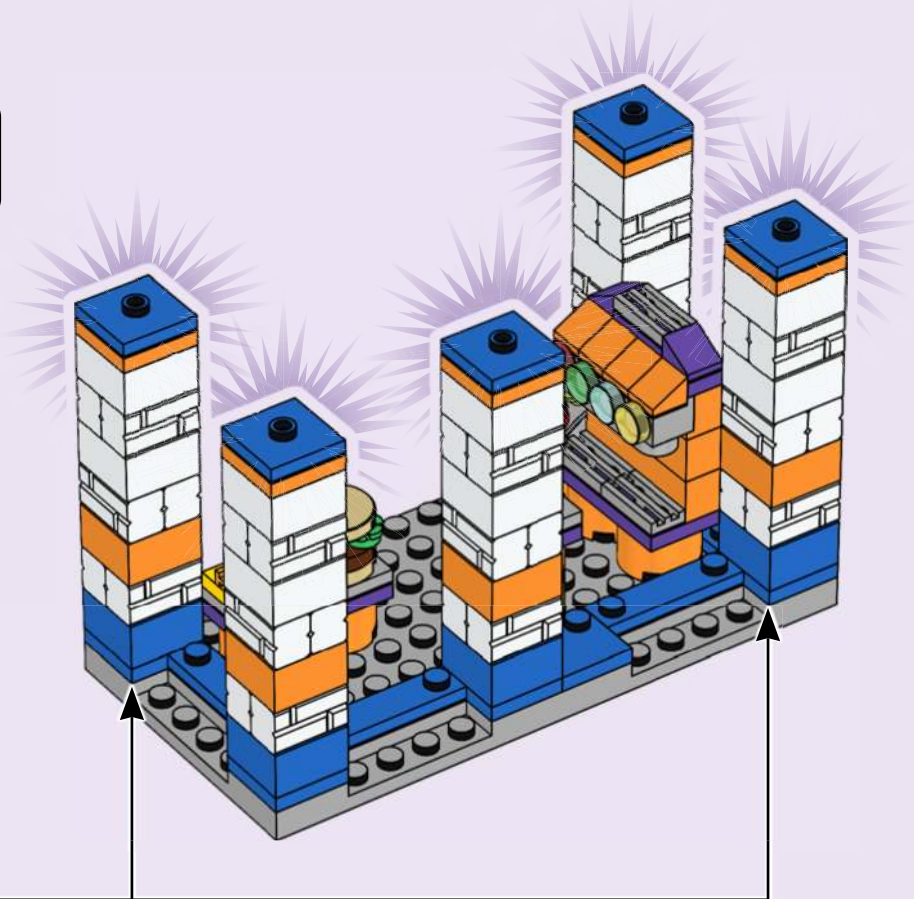
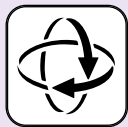

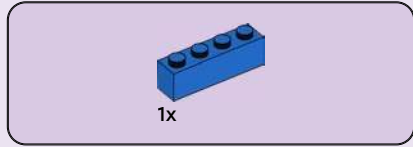

27

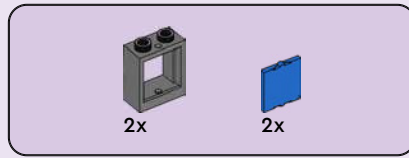

28

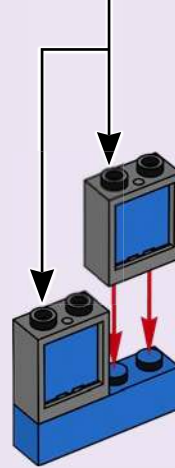
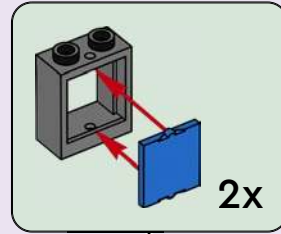

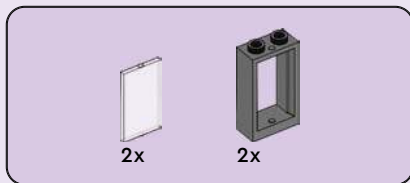

29

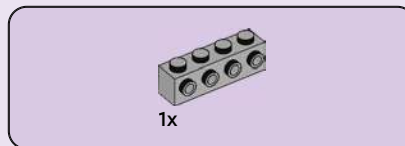
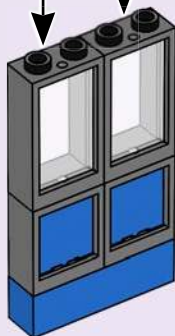
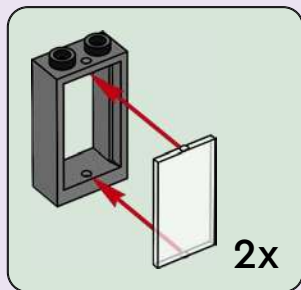

30

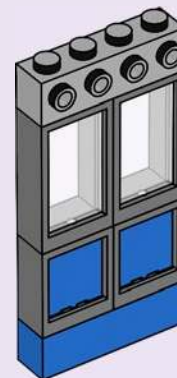

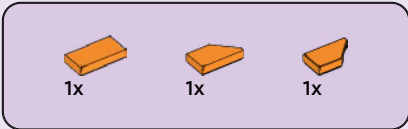

31

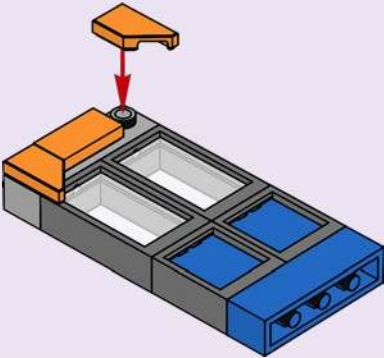

32

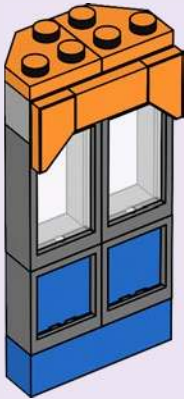

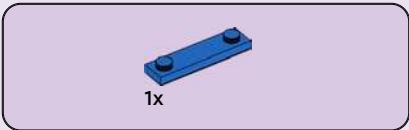

33

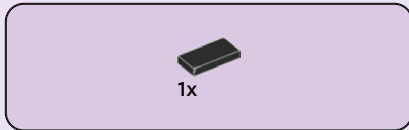
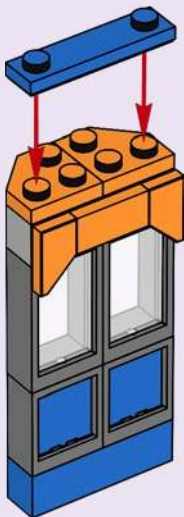

34

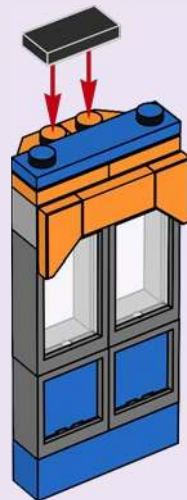

2x

35

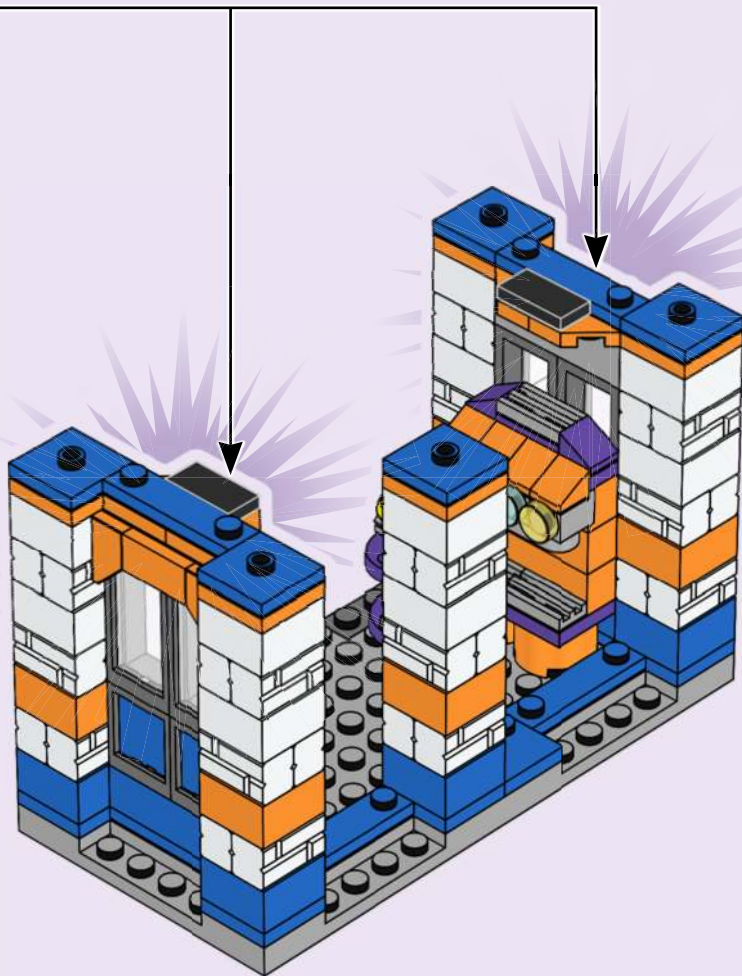

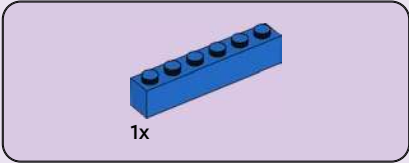
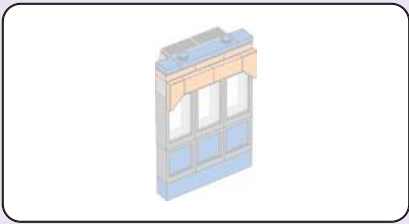

36

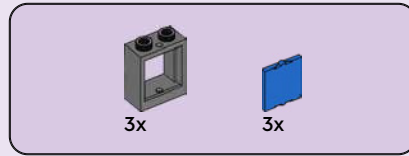
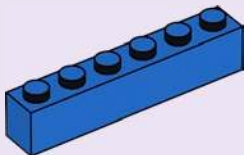

37

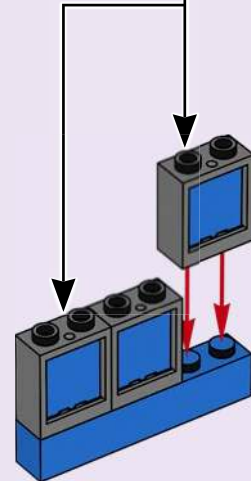
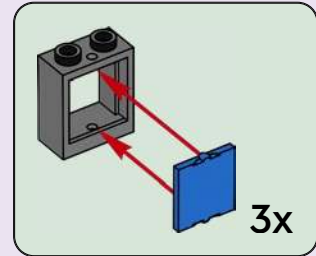

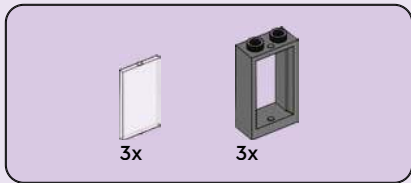

38

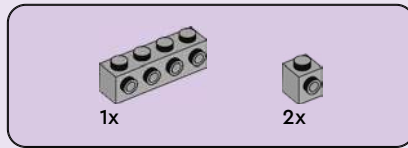
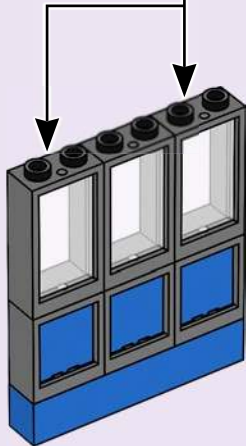
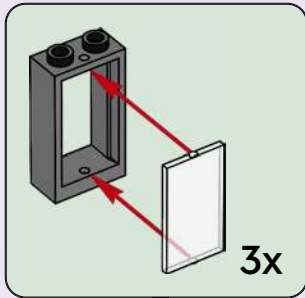

39

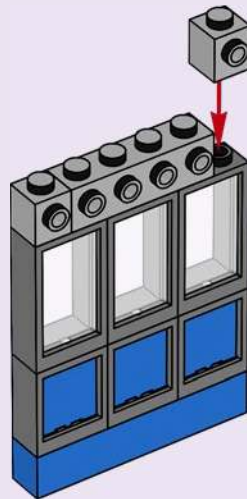

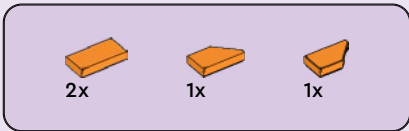

40

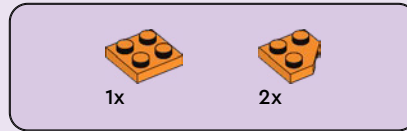
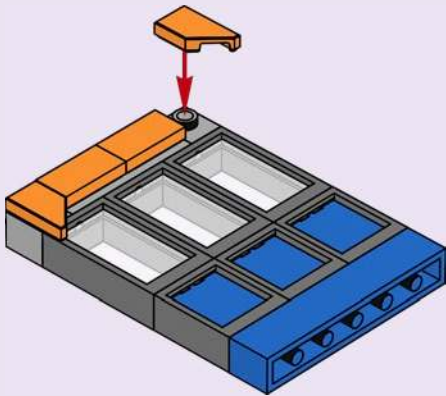

41

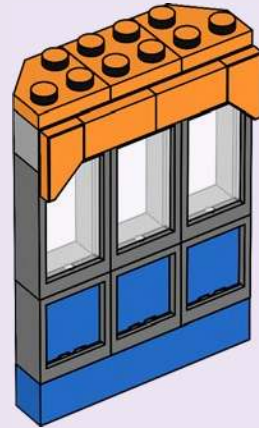
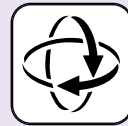



2x



1x

42

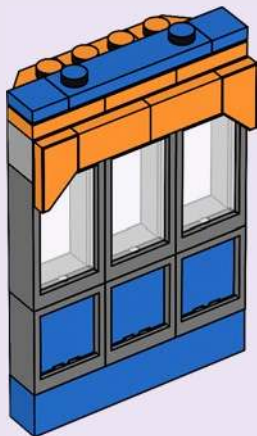

2x

43

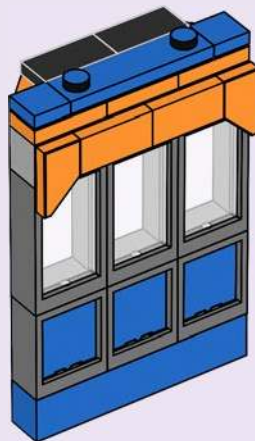

44

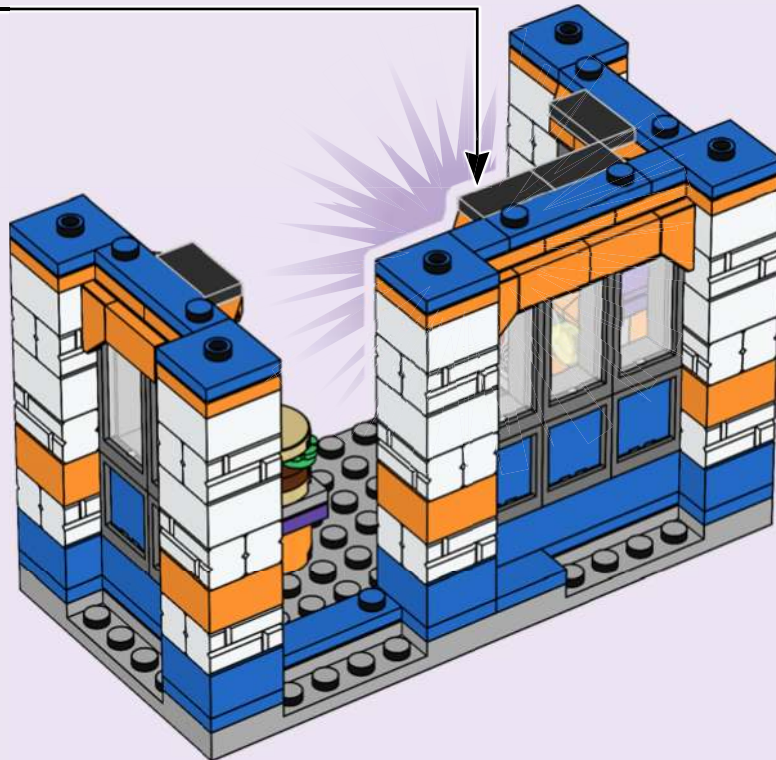

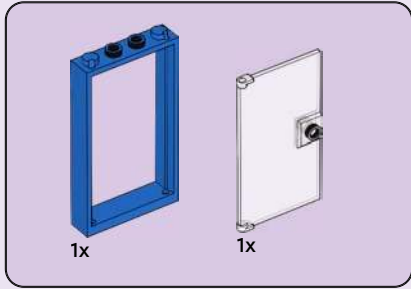
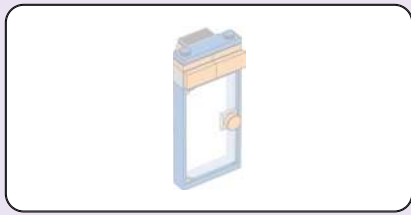

45

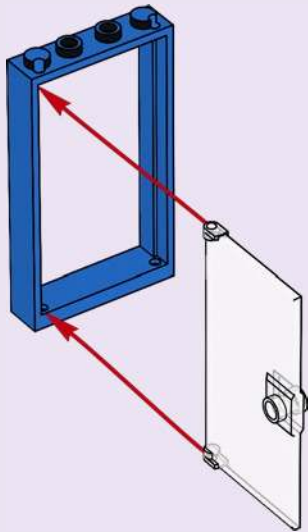

46

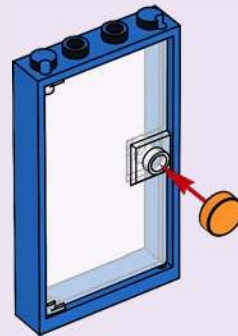



1x

47

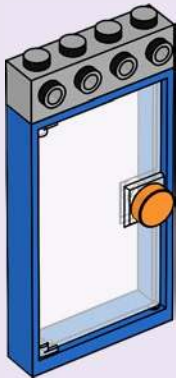

2x

48

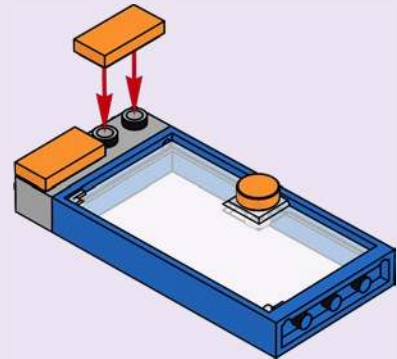
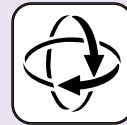

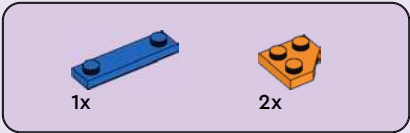

49

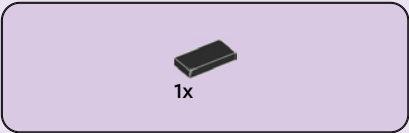
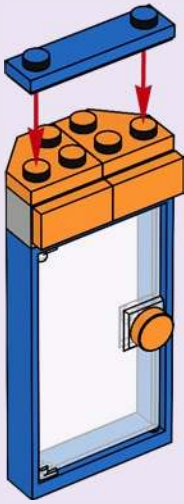

50

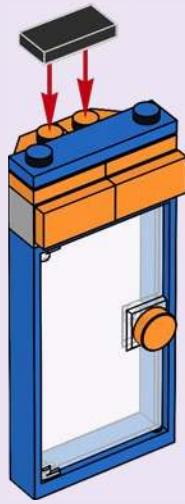

51

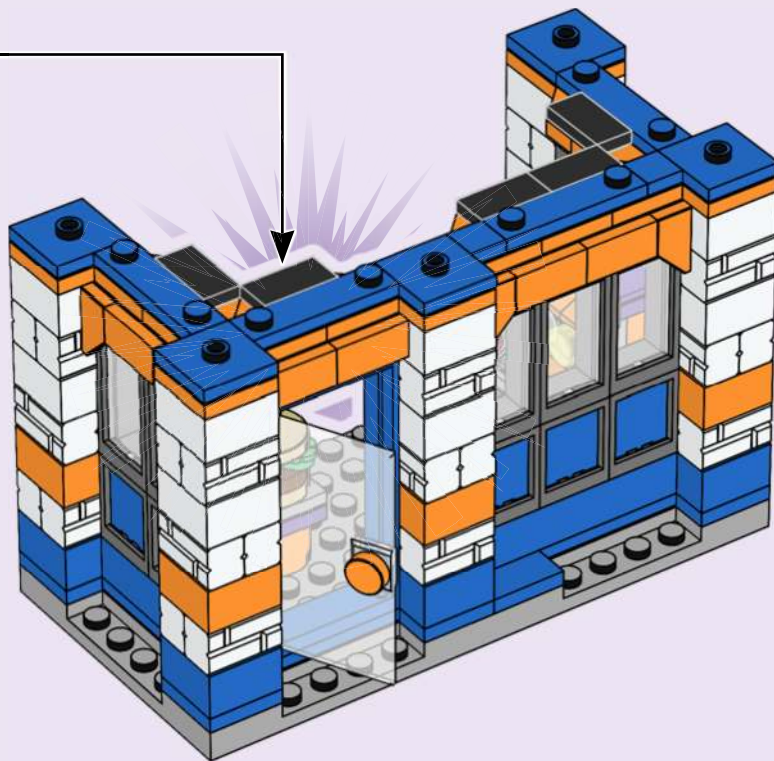

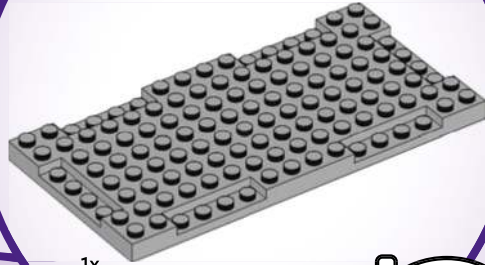

1x

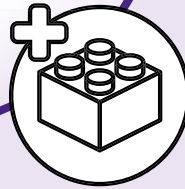

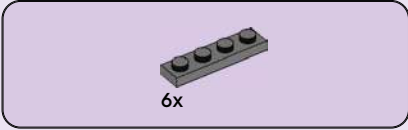
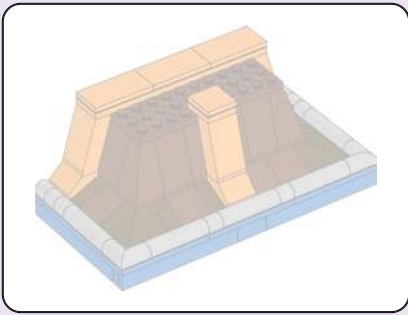

52

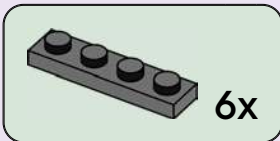
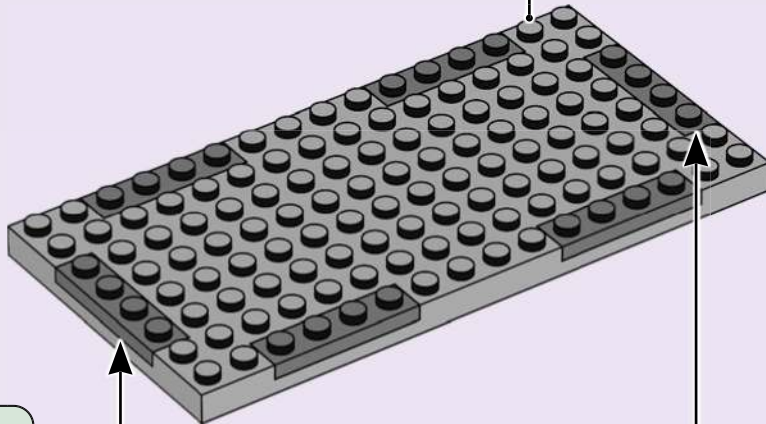
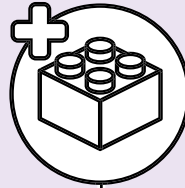



1x



8x

53

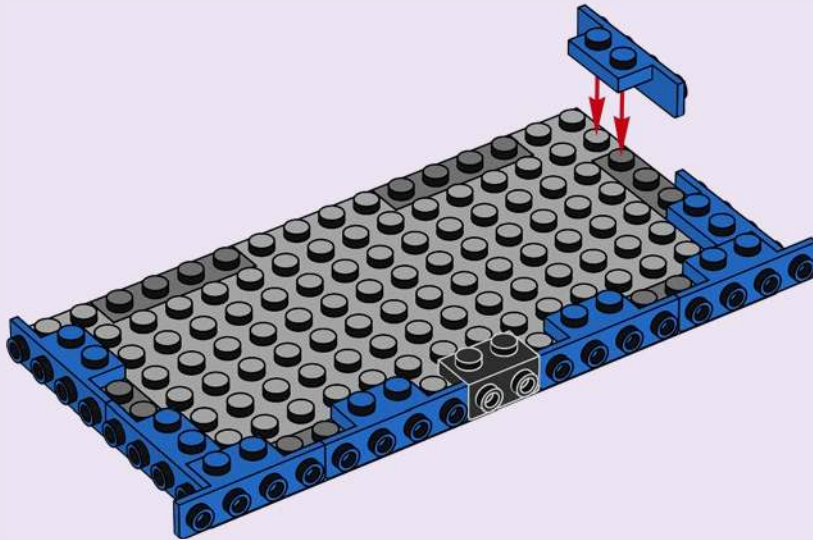



4x



4x

54

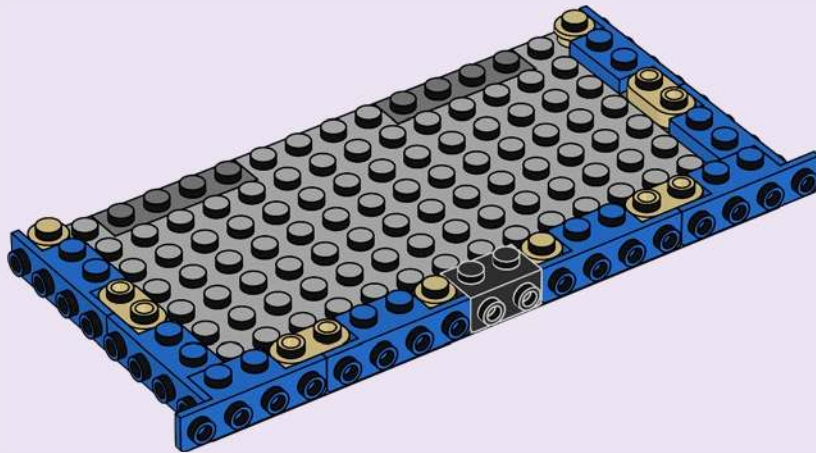

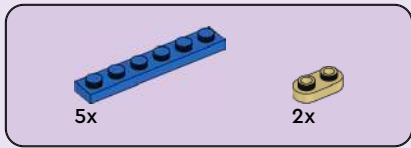

55

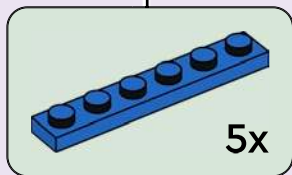
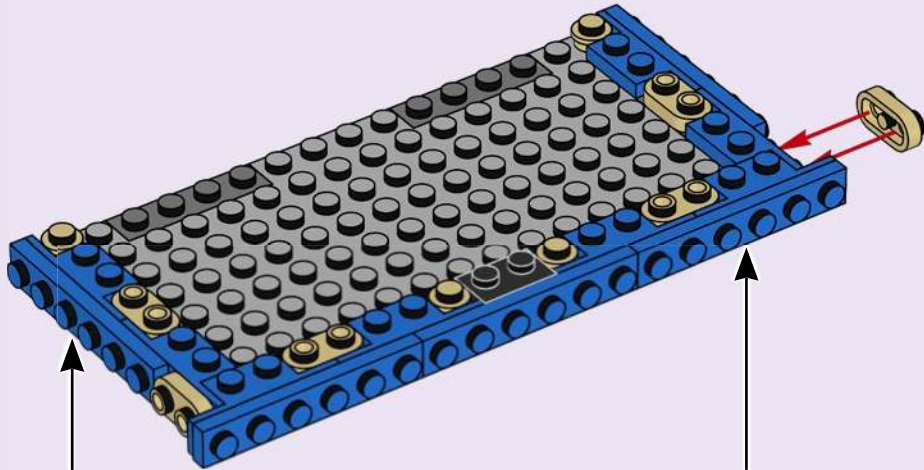

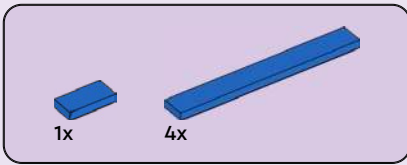

56

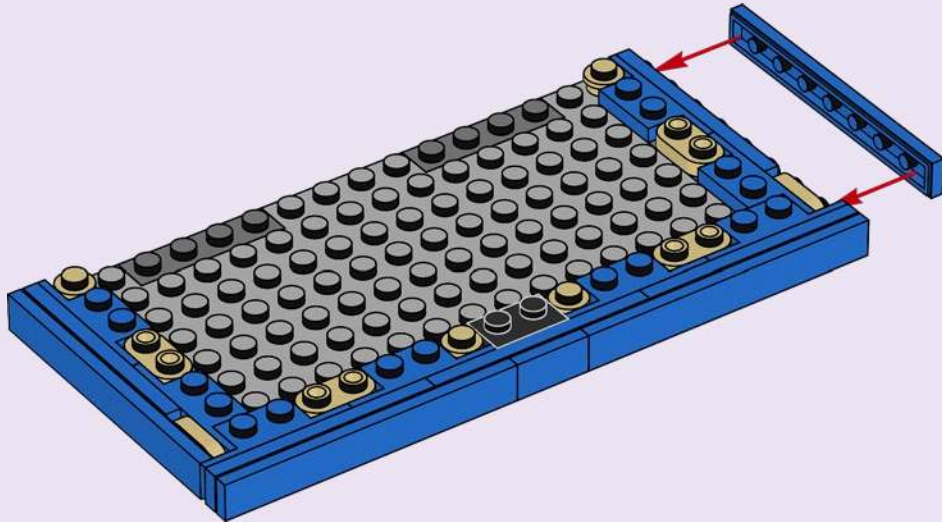



2x

57

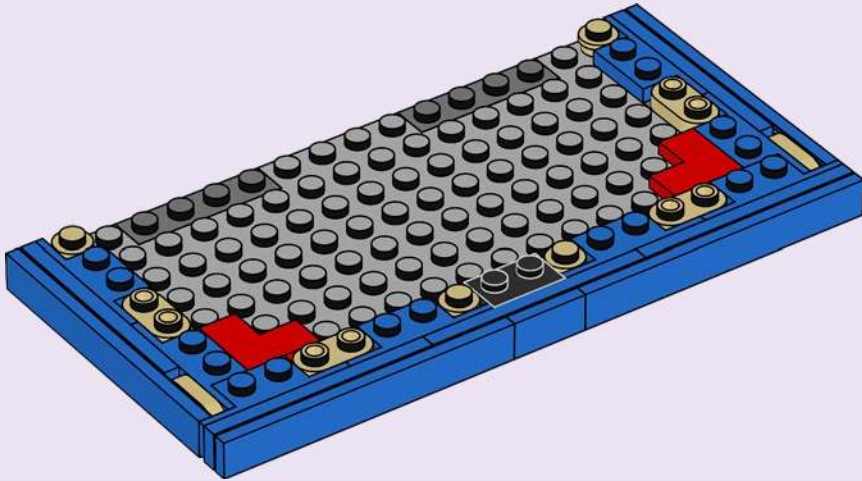

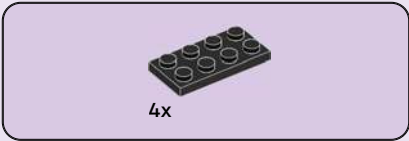

58

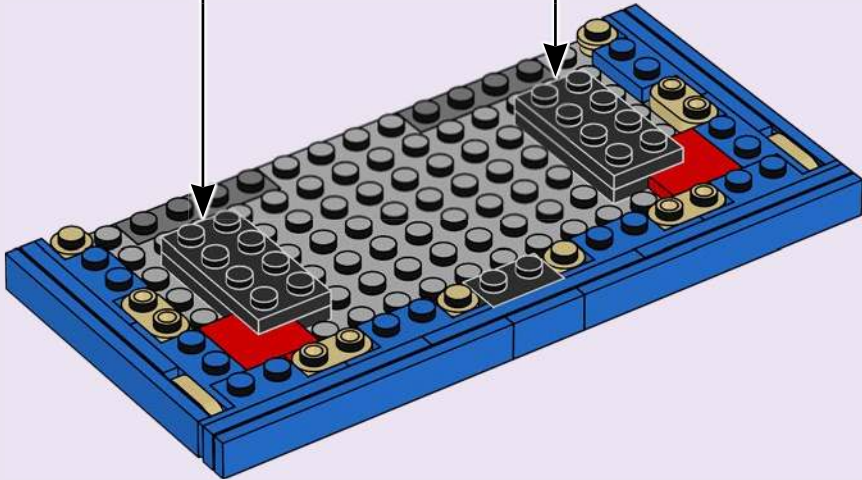
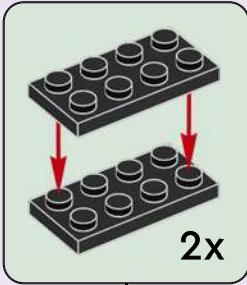



1x

59

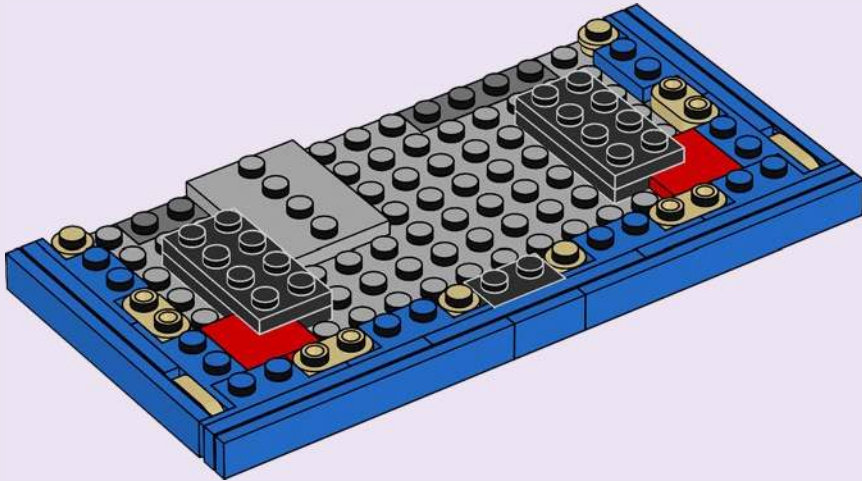



8x

60

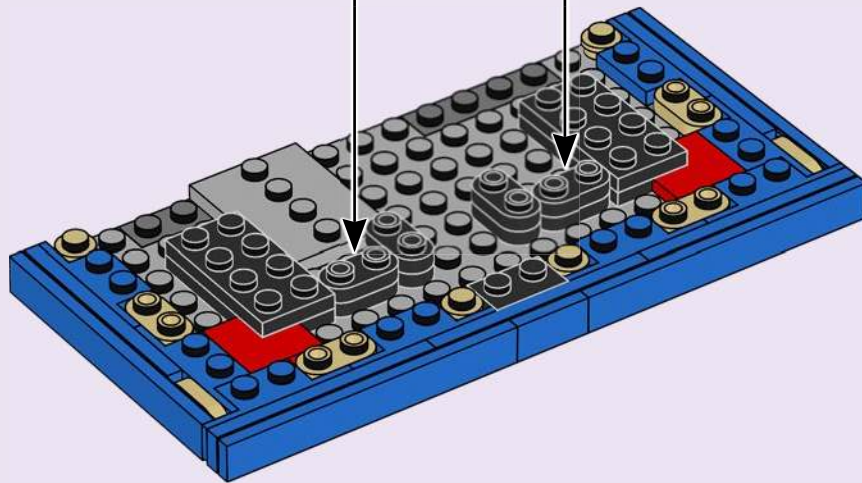
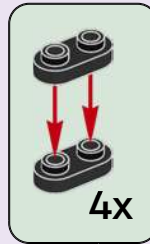



3x

61

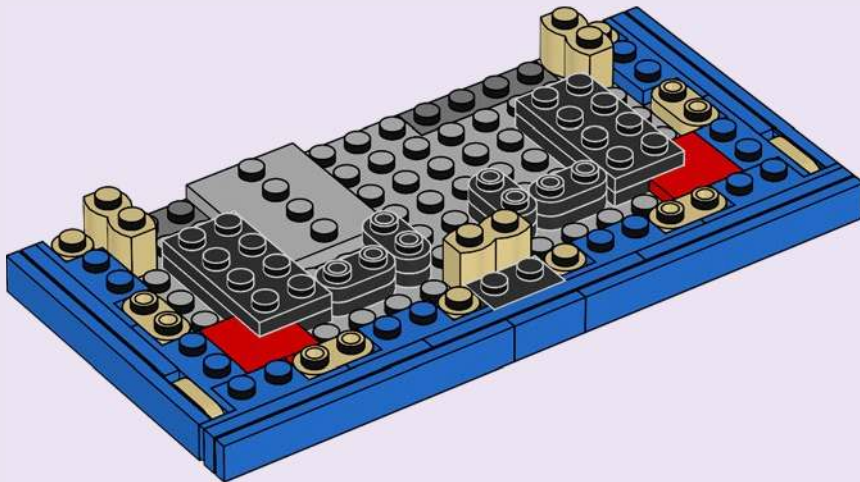



3x

62

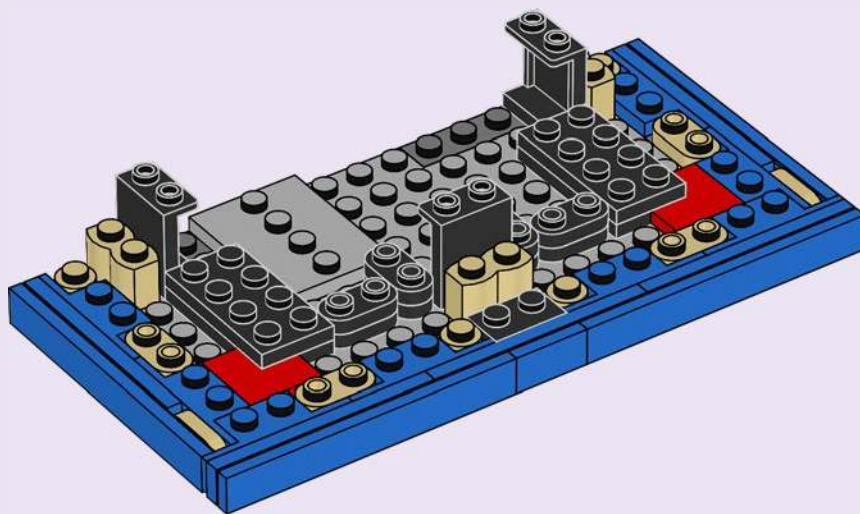

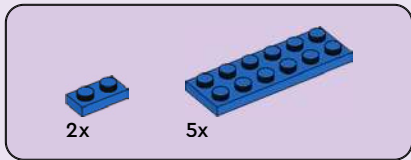

63

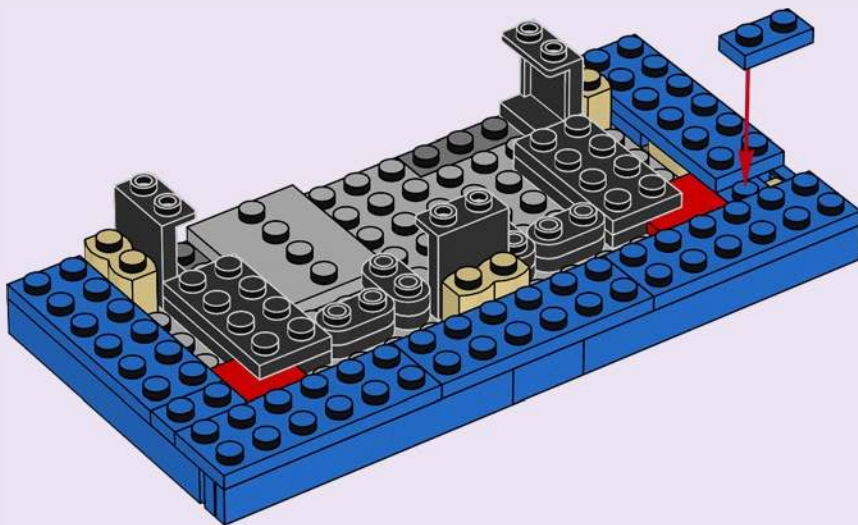



3x

65

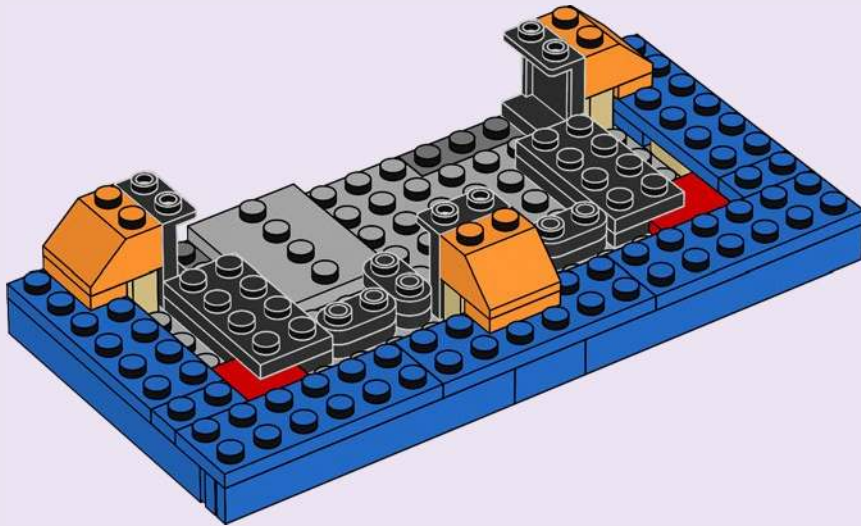

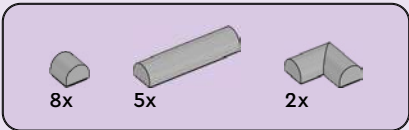

66

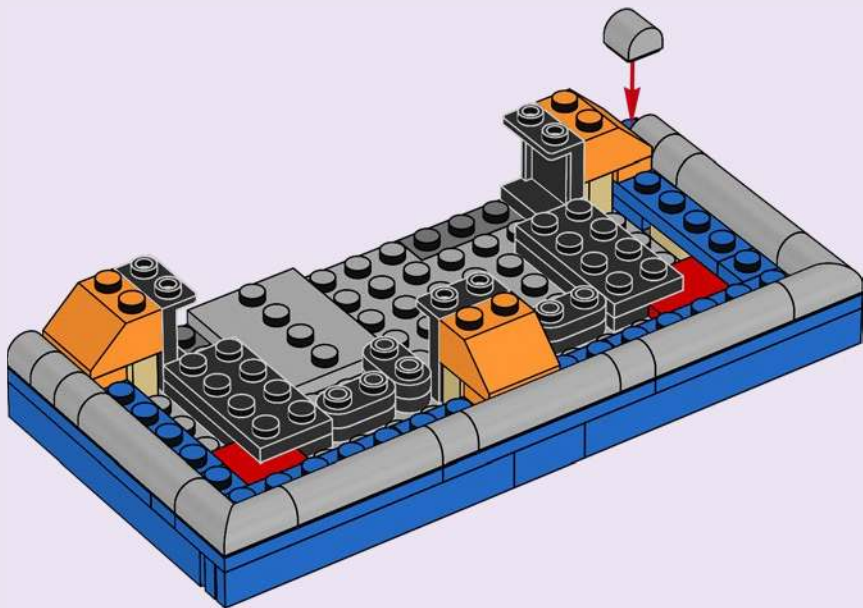

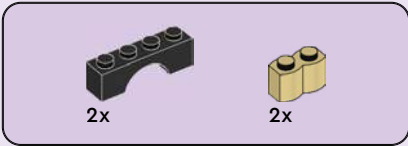

67

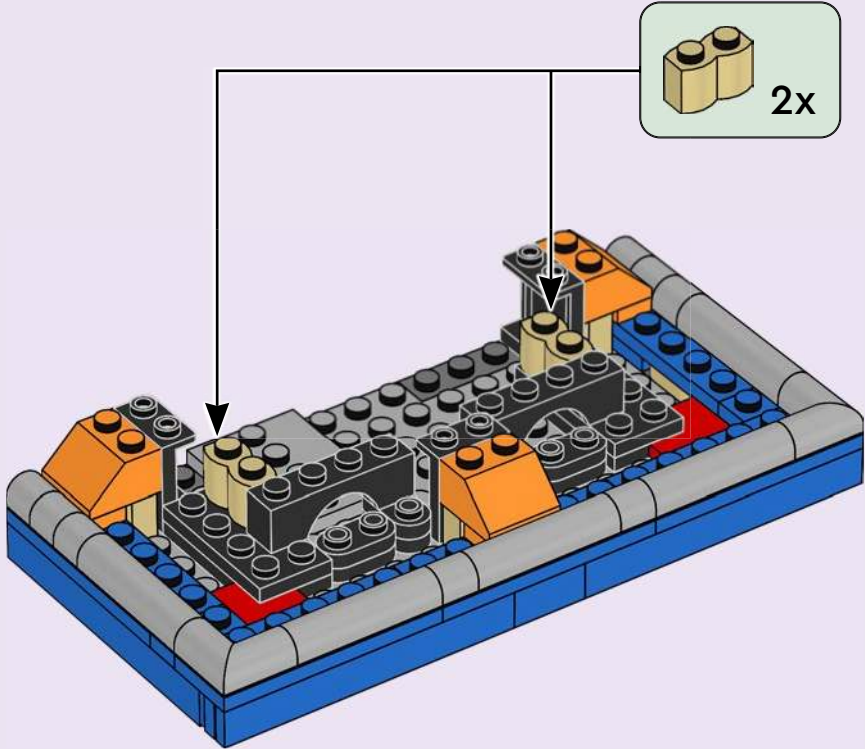
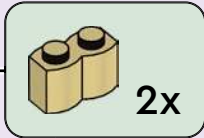

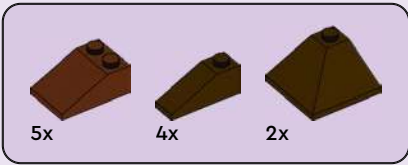

68

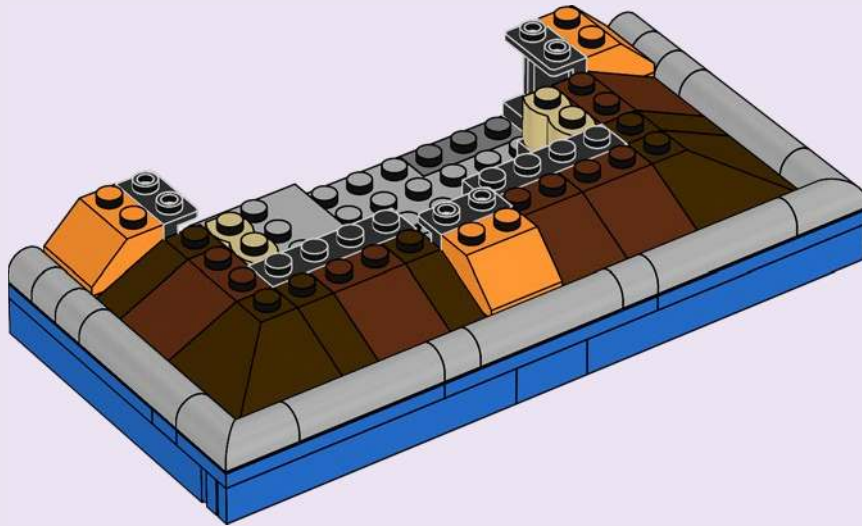

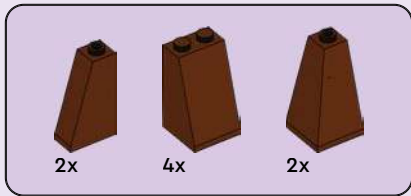

69

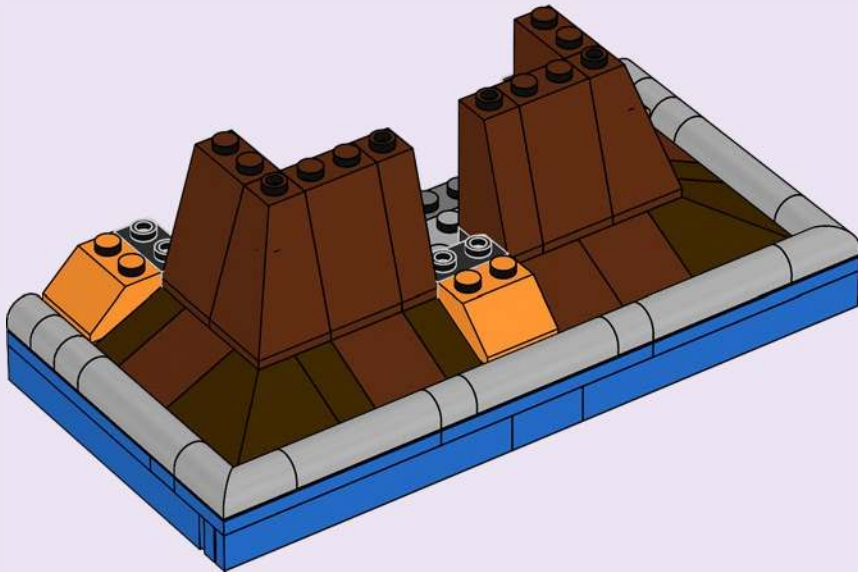

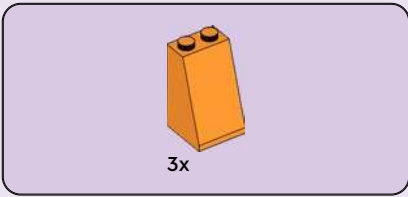

70

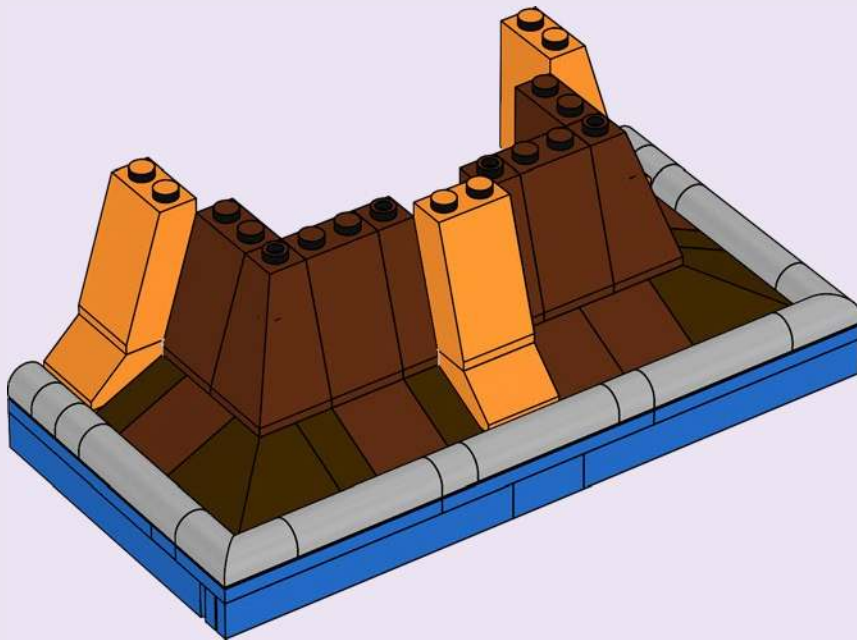



71

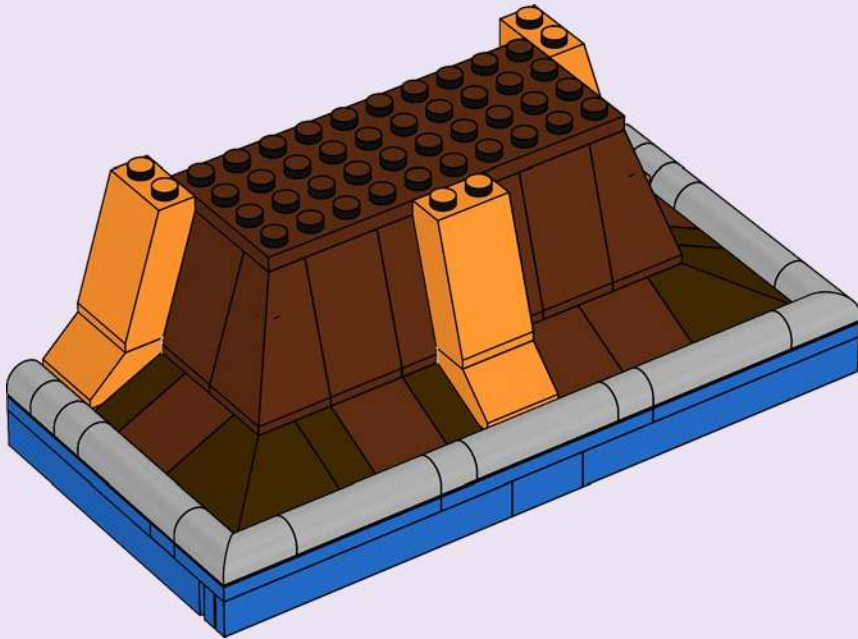

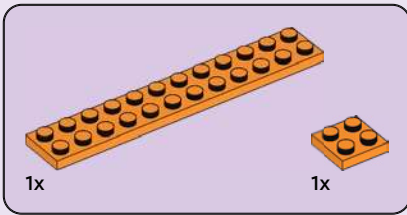

72

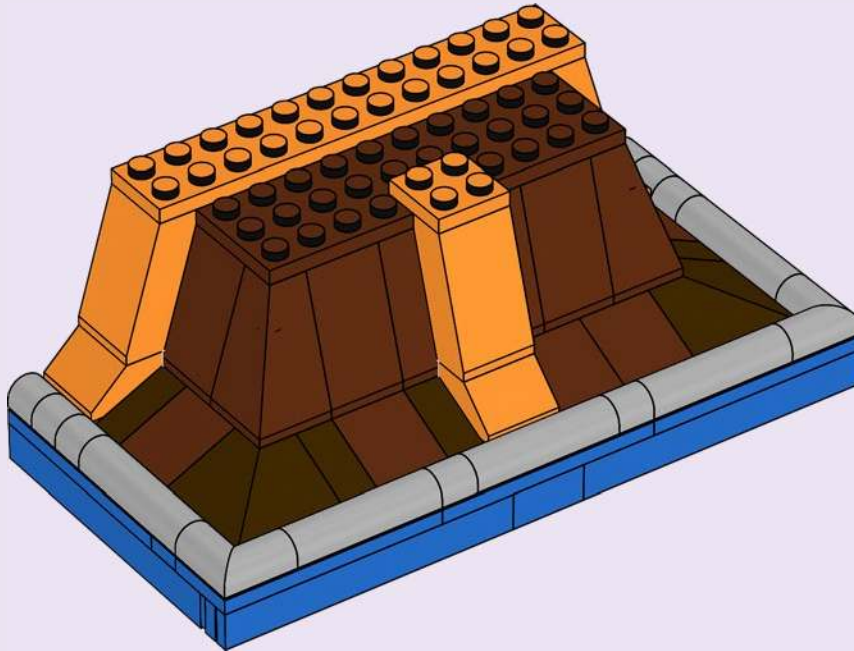

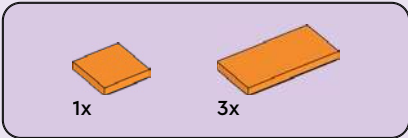

73

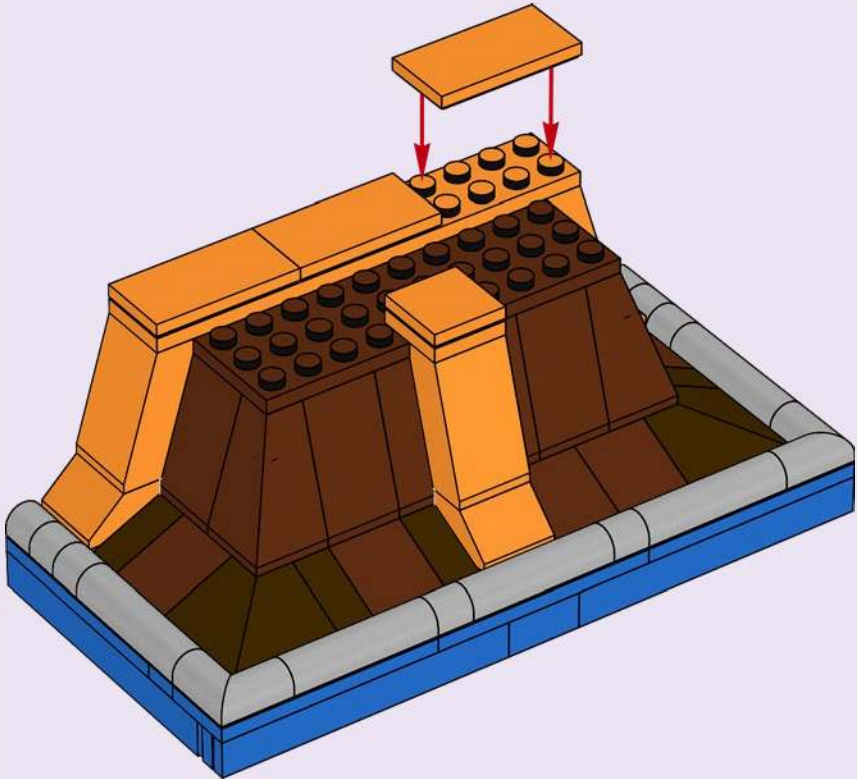

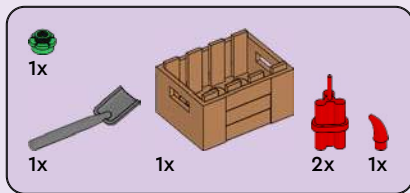

74

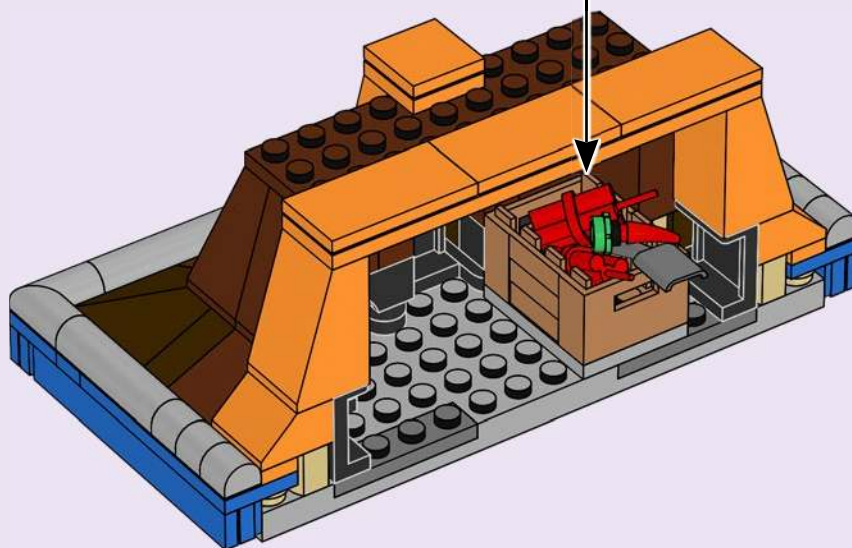
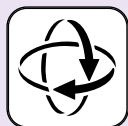
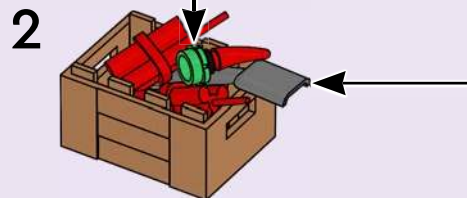
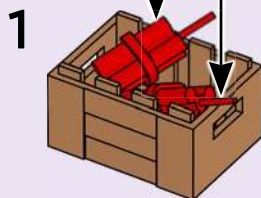
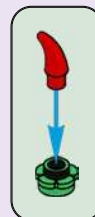
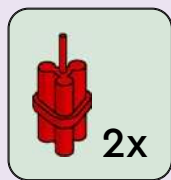



1x

75

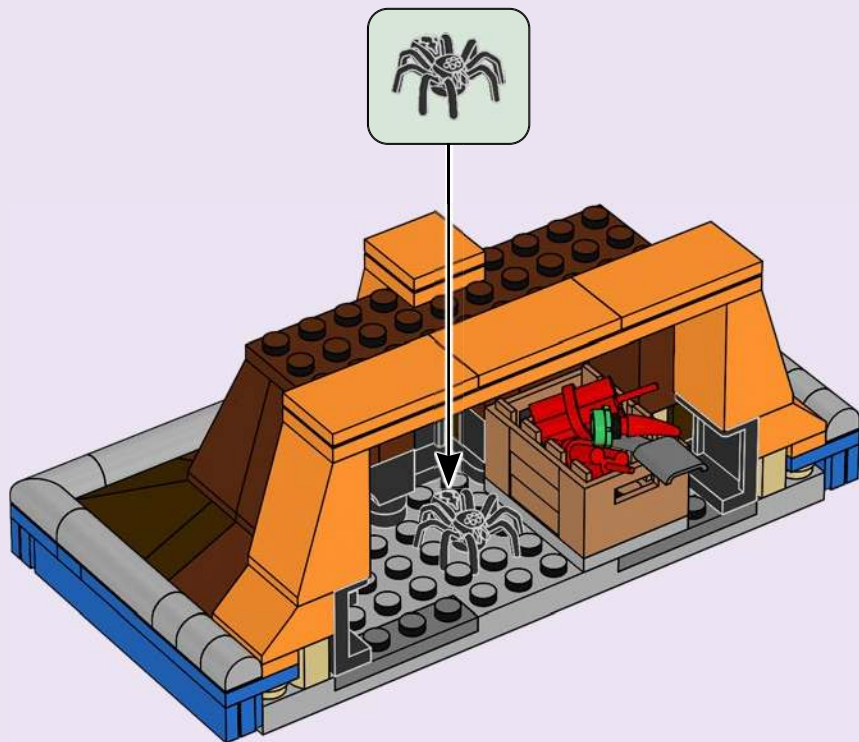

76

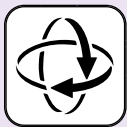

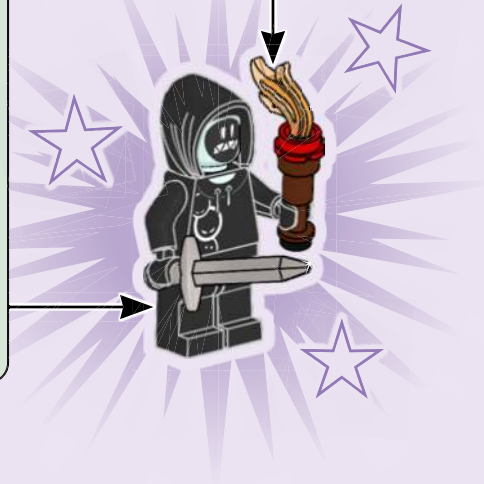
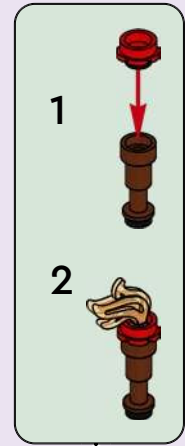
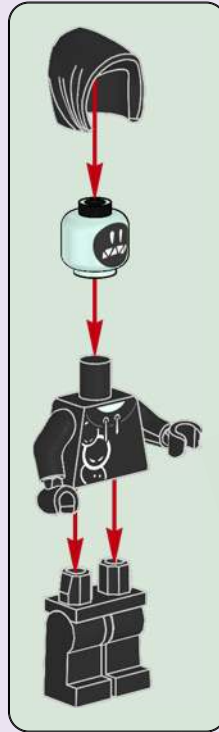

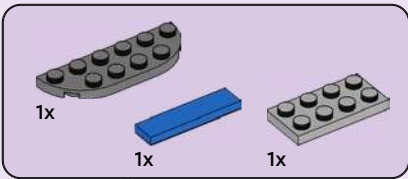

77

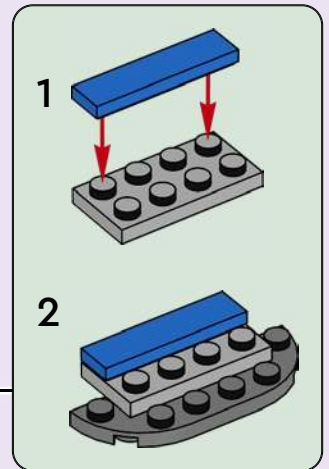
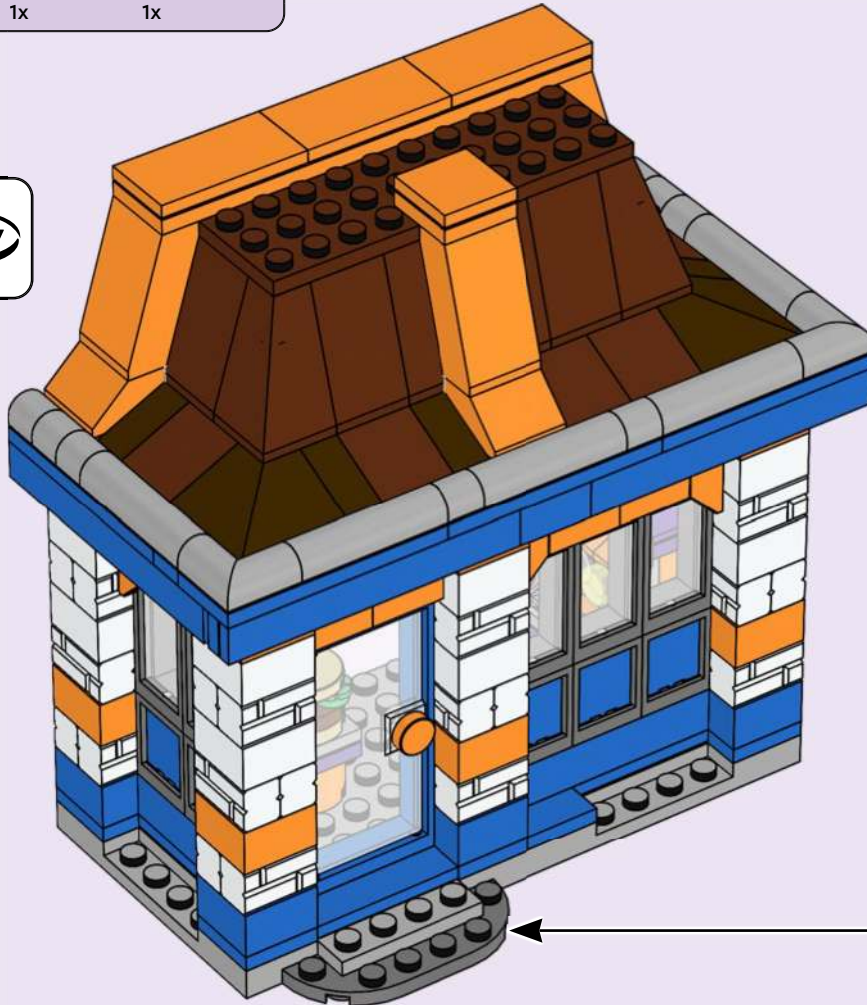

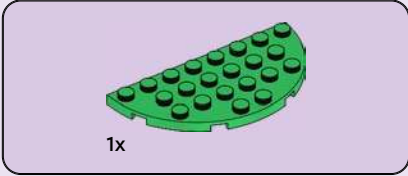
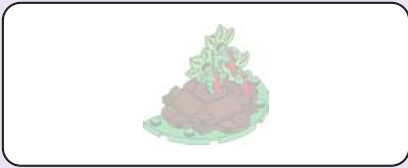

78

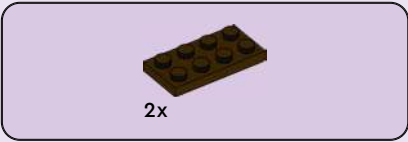
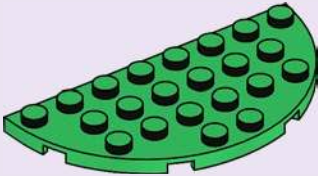

79



3x

3x

80



1x

2x

81



1x

82





3x

83



4x

84



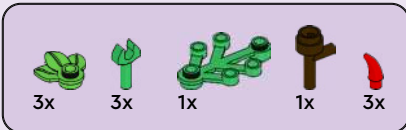

85

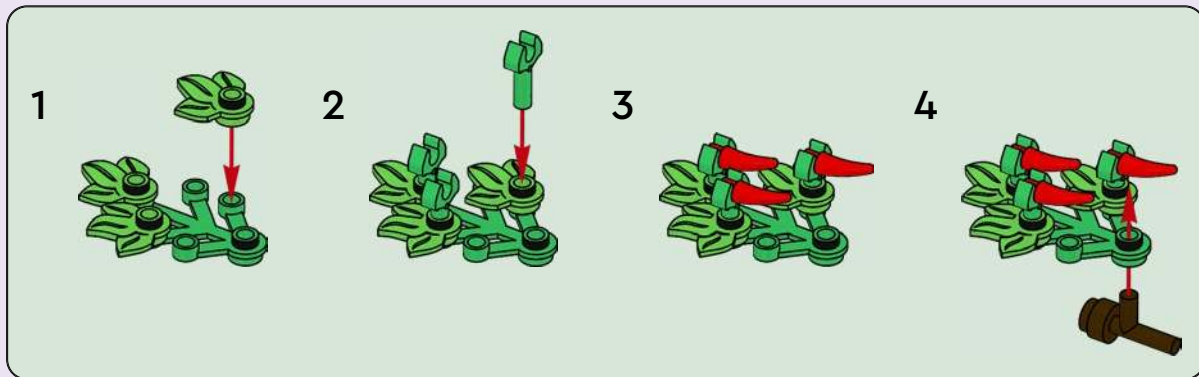

86



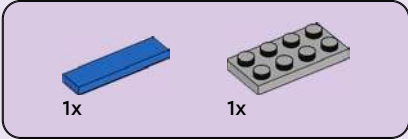
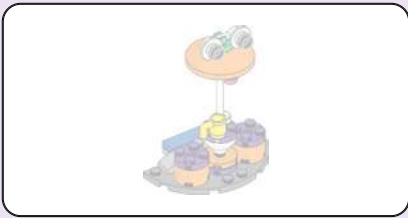

87

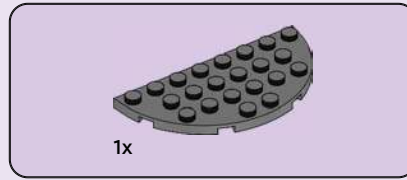
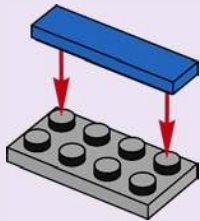

88

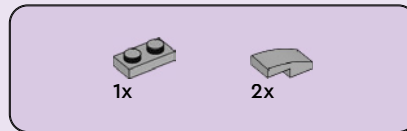
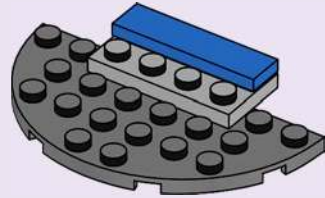

89

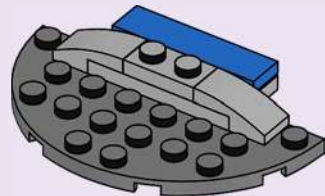



90

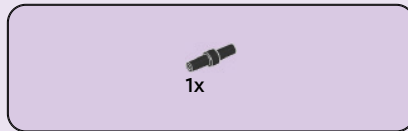
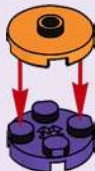

91

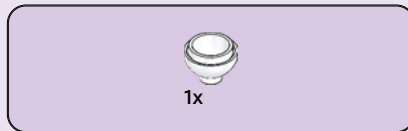

92



2x

93



1x

94



1x

95



1x



1x

96

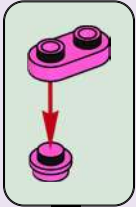

1x



1x

97



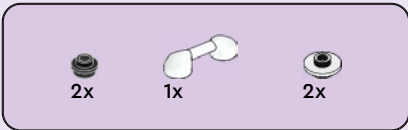

98

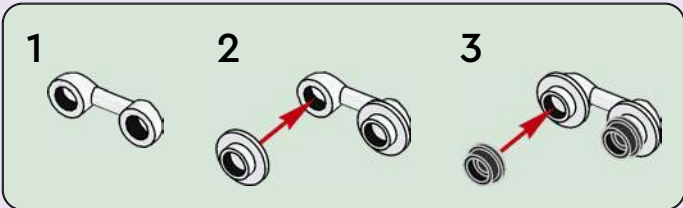

99

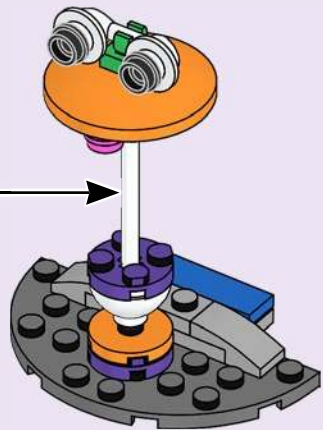

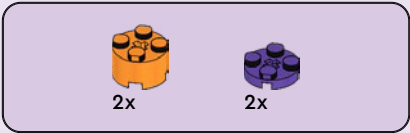

100

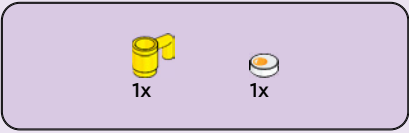
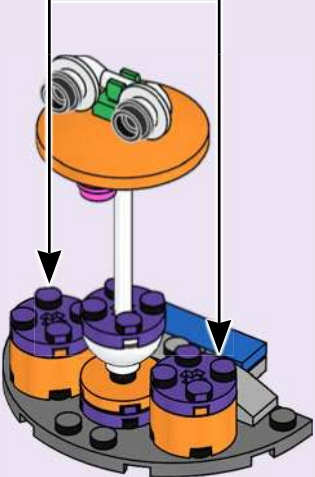
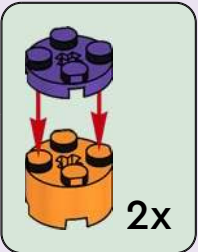

101



102

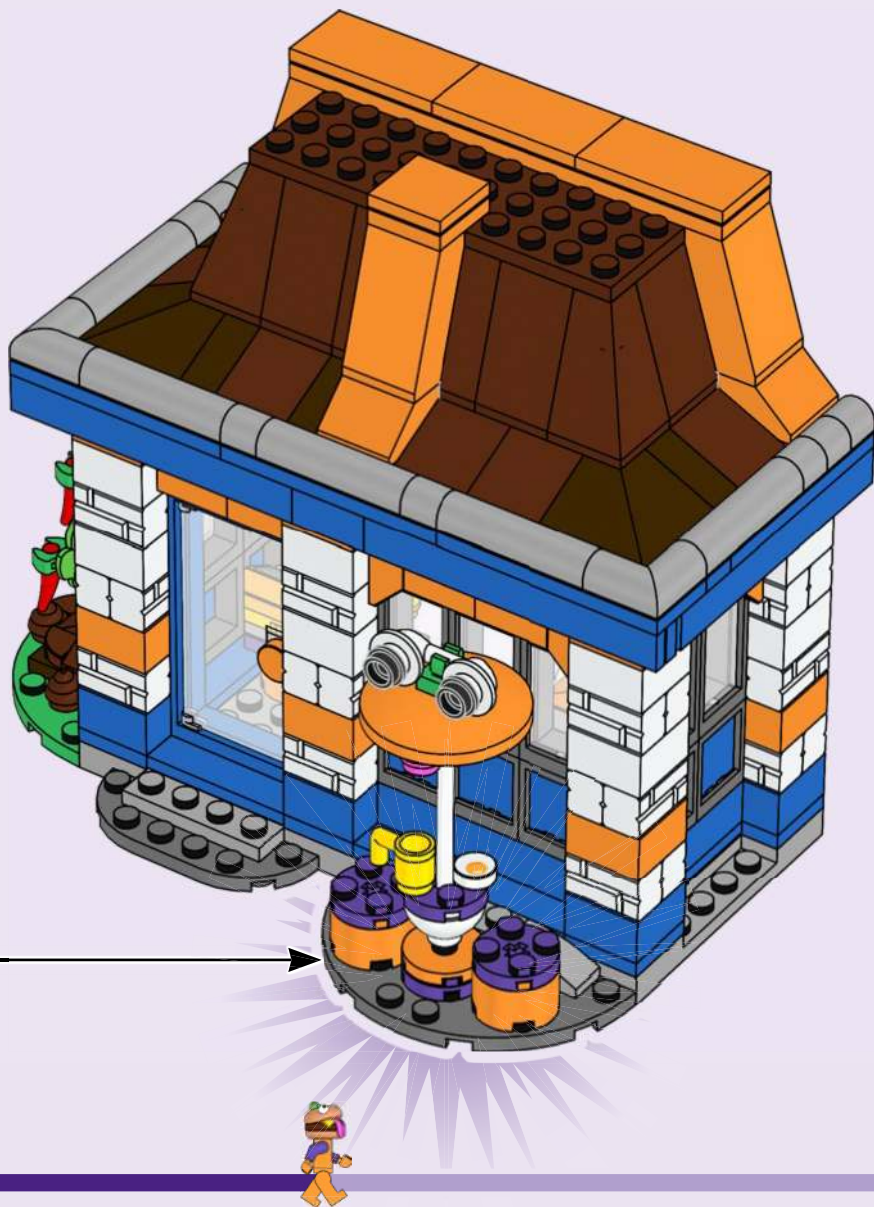

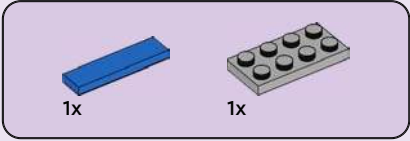

103

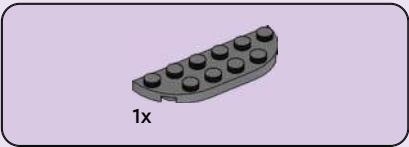
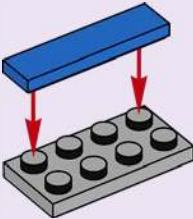

104

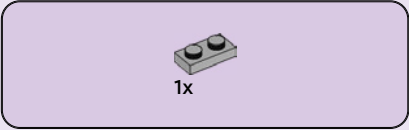
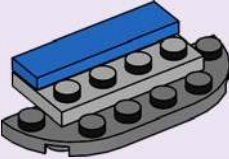

105





2x

106

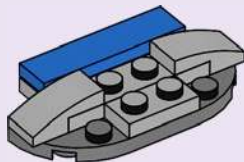

1x

107

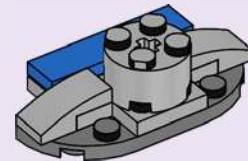

2x

108

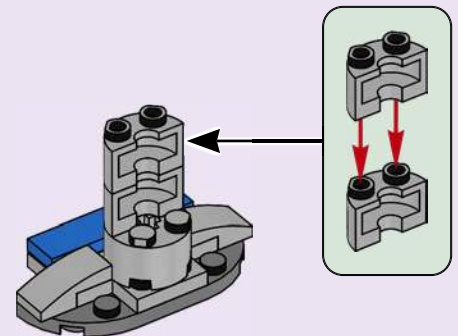



2x

109

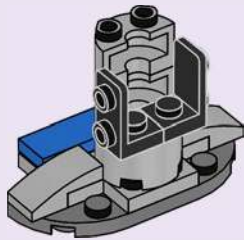

1x



2x

110

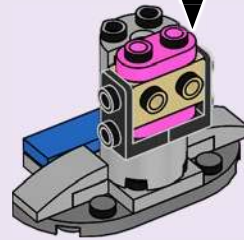
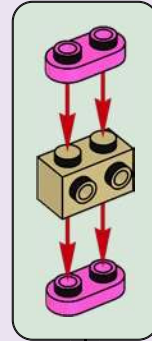



1x



1x

111

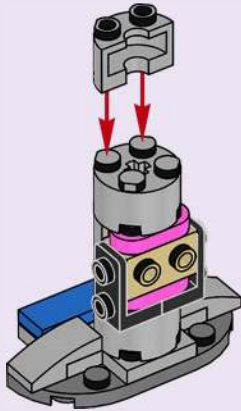

2x

112

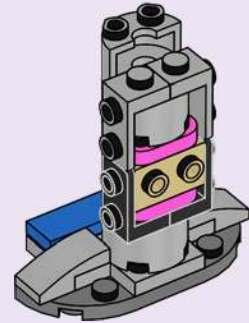

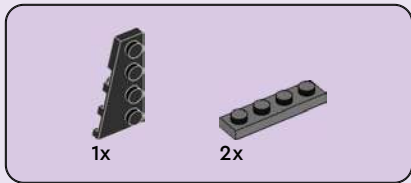

113

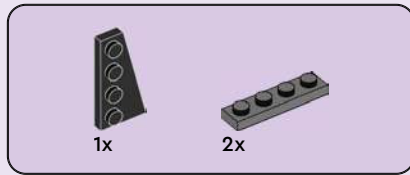
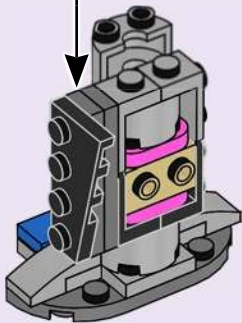
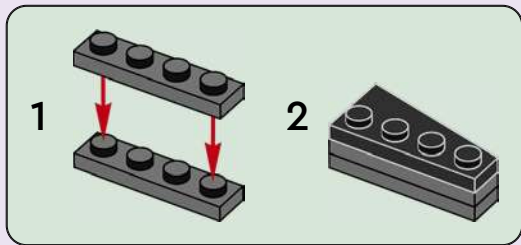

114

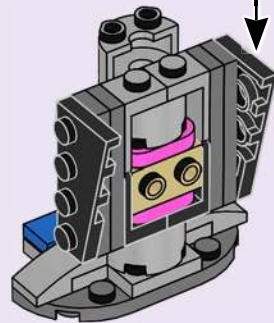
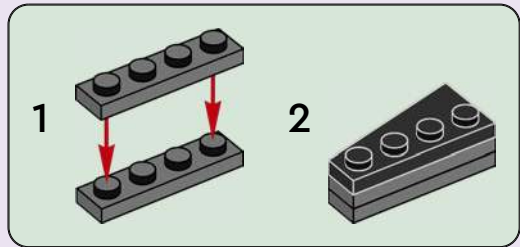

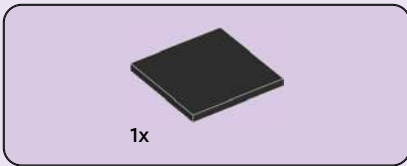

115

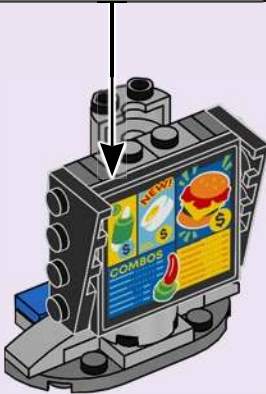
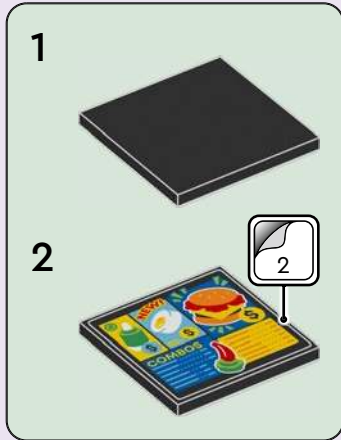

116

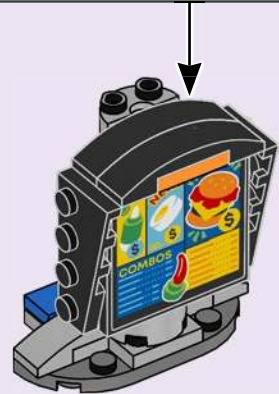
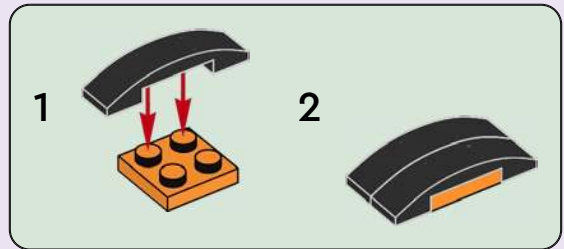

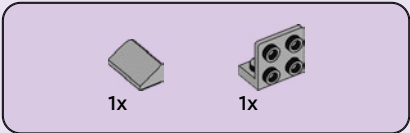

117

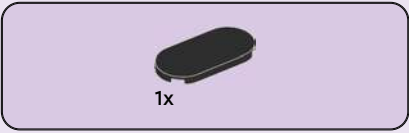
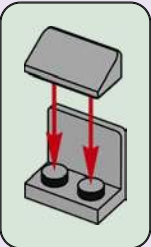

118



119



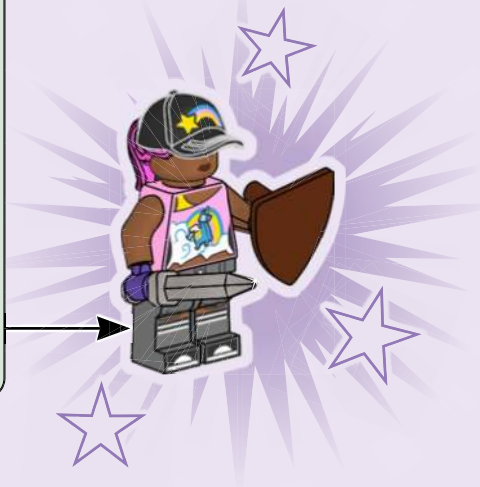
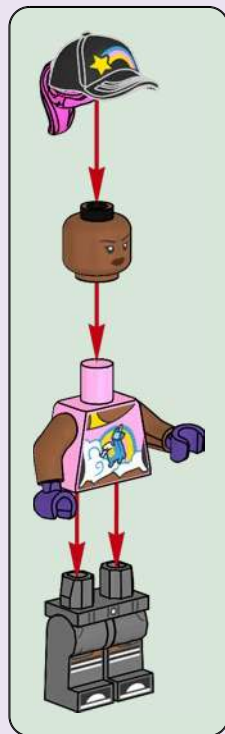



120

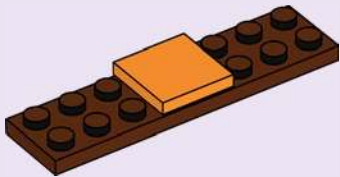

121

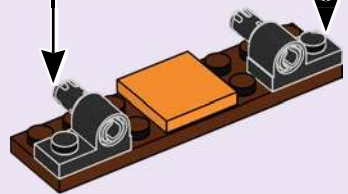
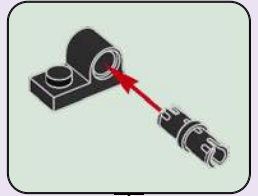
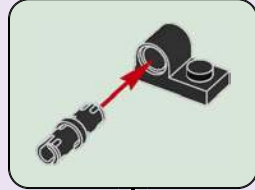

122

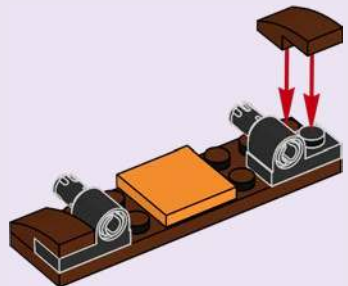

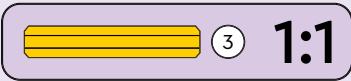
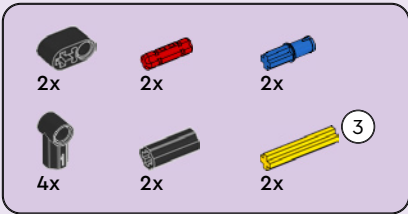

123

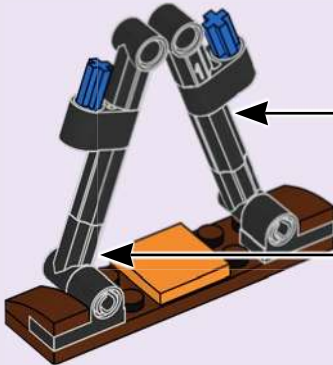
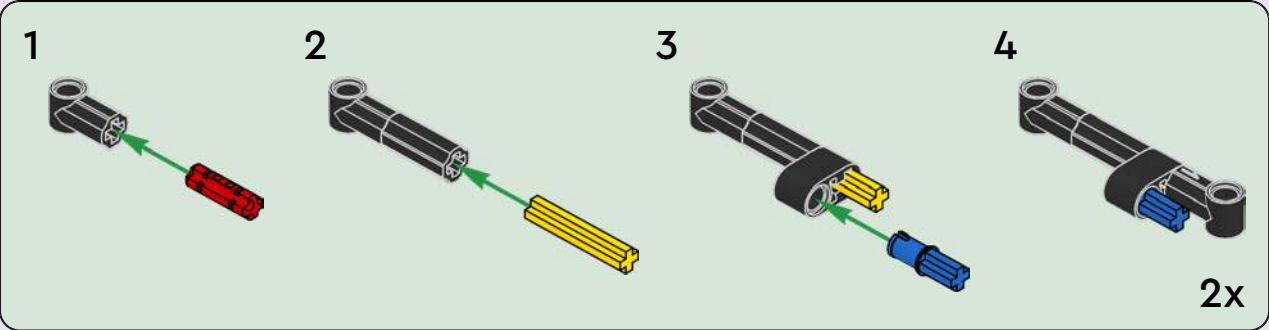

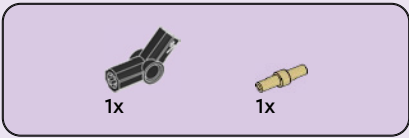

124

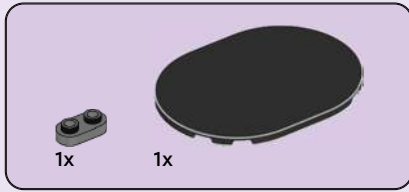
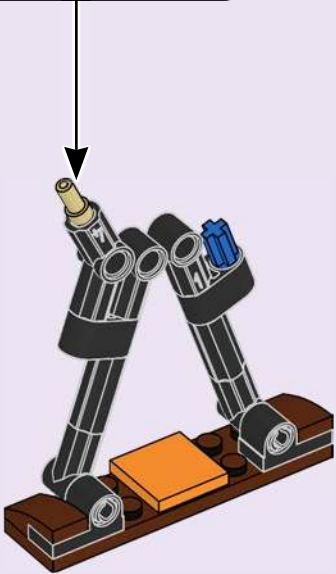
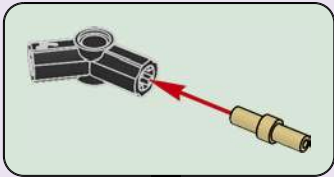

125

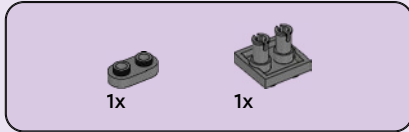
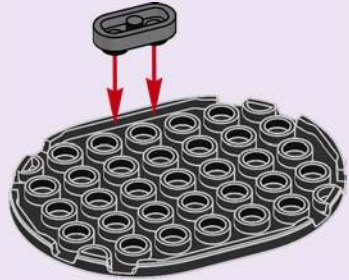

126



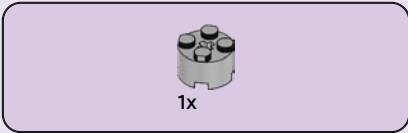

127

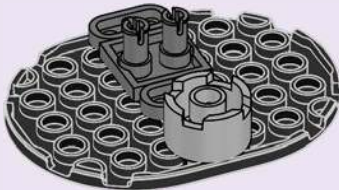

128



129

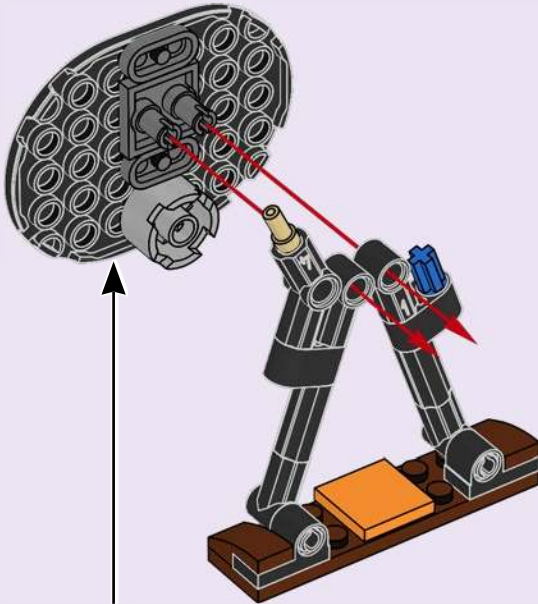

130





131

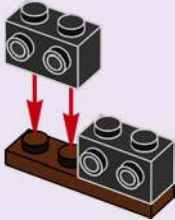

132

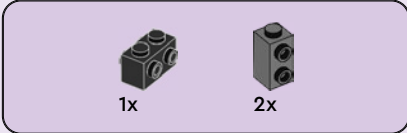
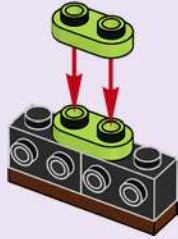

133





2x

134

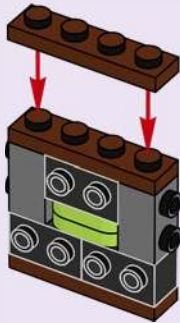

2x



1x

135



2x

136



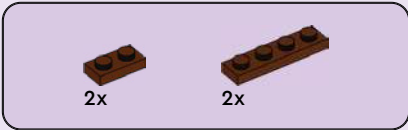

137

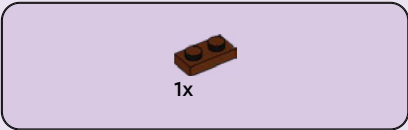
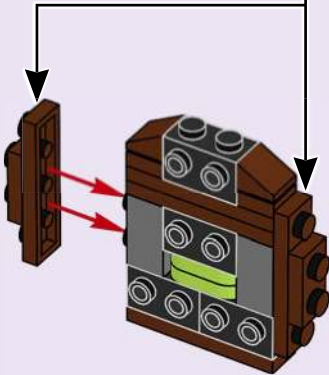
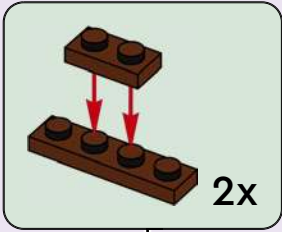

138

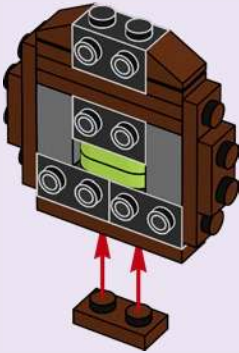

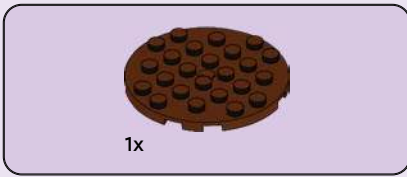

139

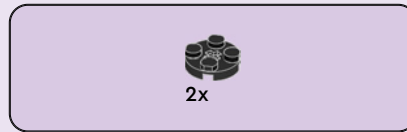
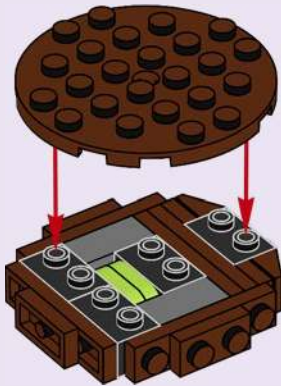

140

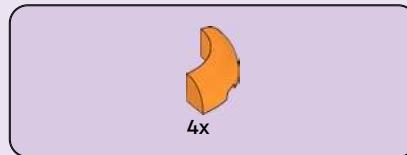
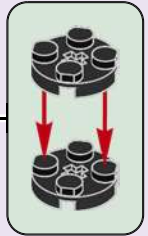
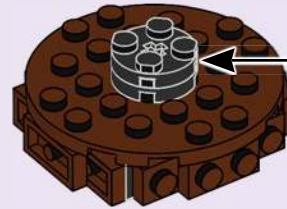

141

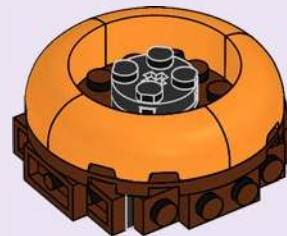

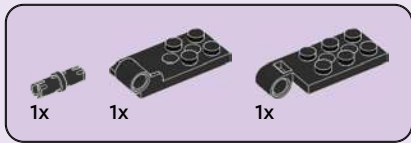

142

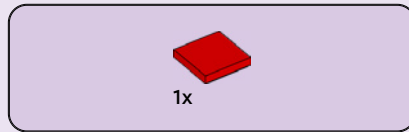
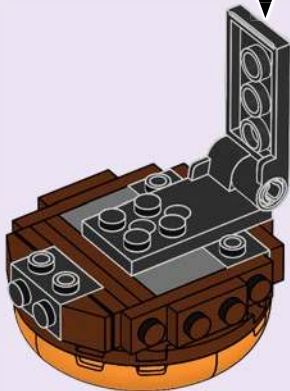
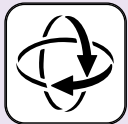
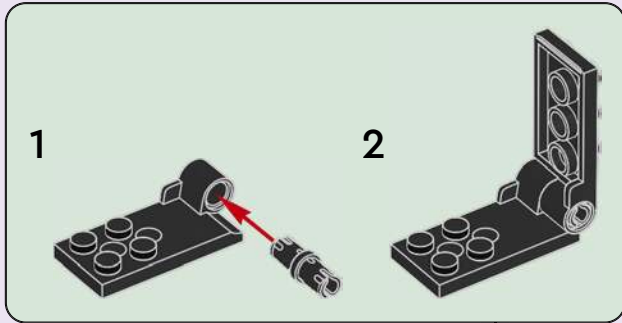

143

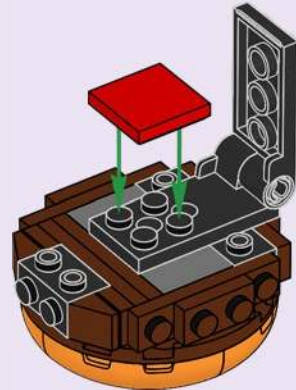

144

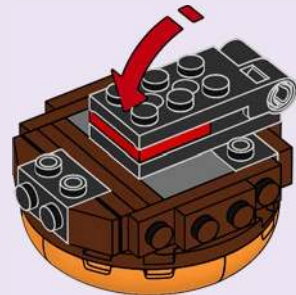

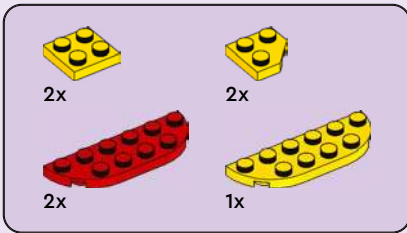

145

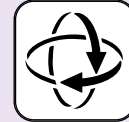

1

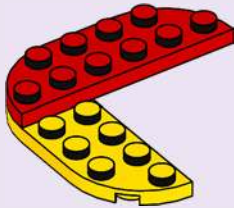

2

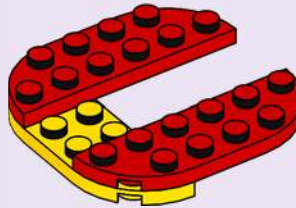

3

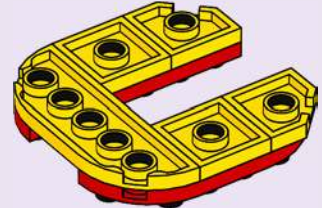

146



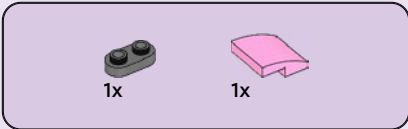

147

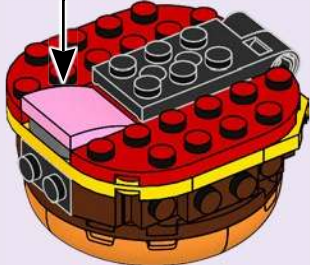
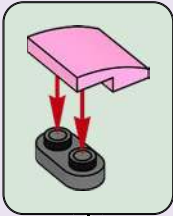

148

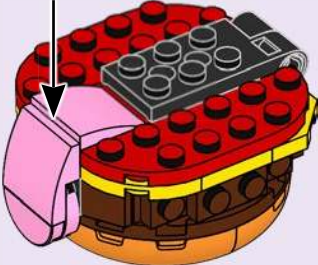
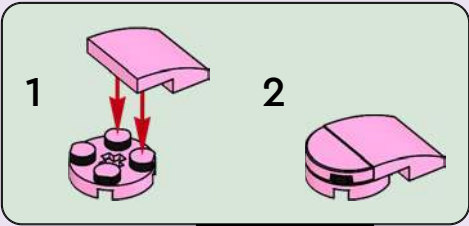

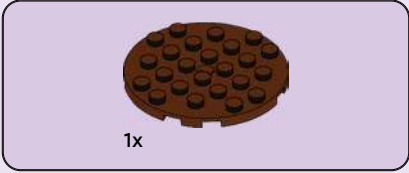

149

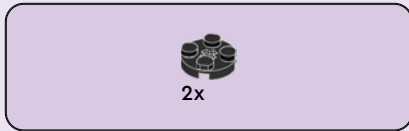

150

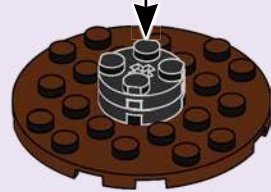
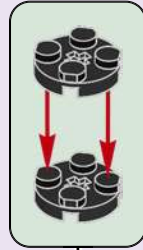

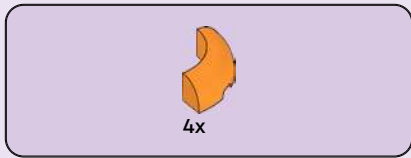

151

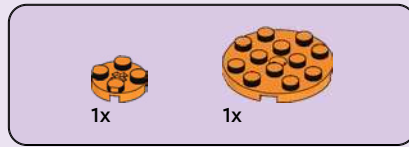
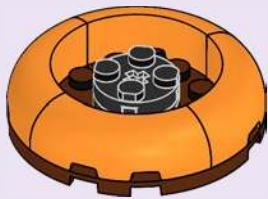

152

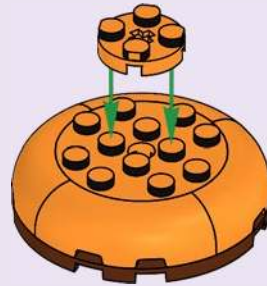



153



154

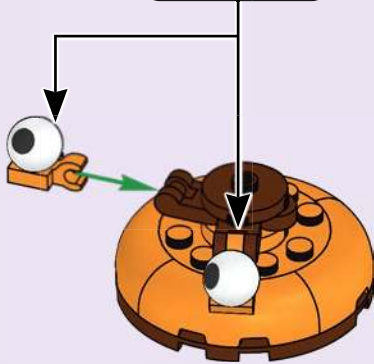
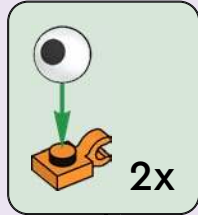



155

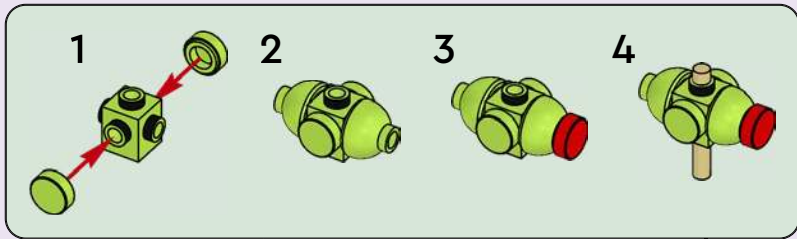

156



157

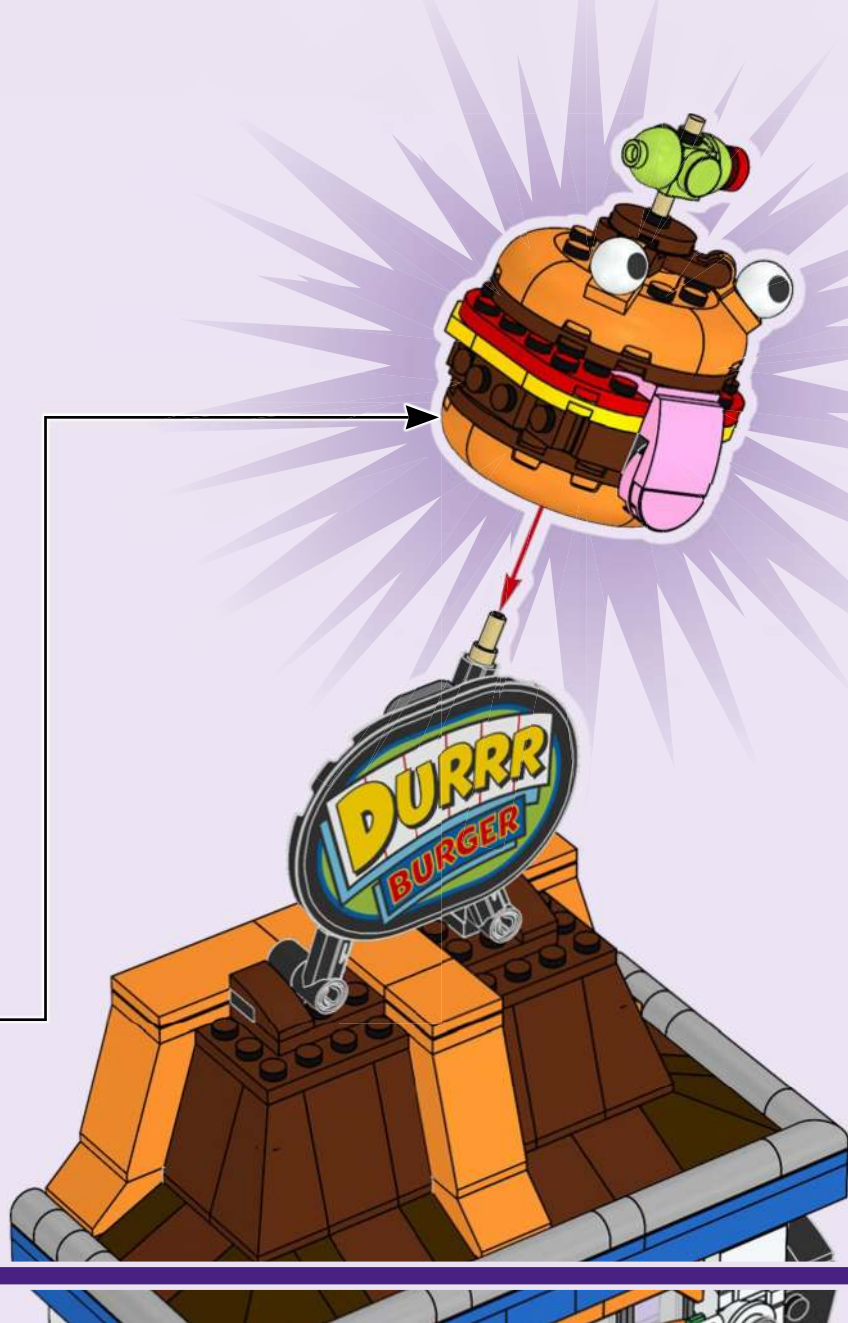





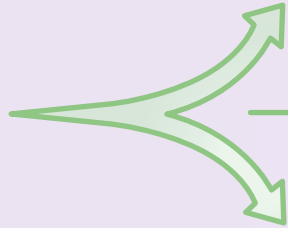

1



2

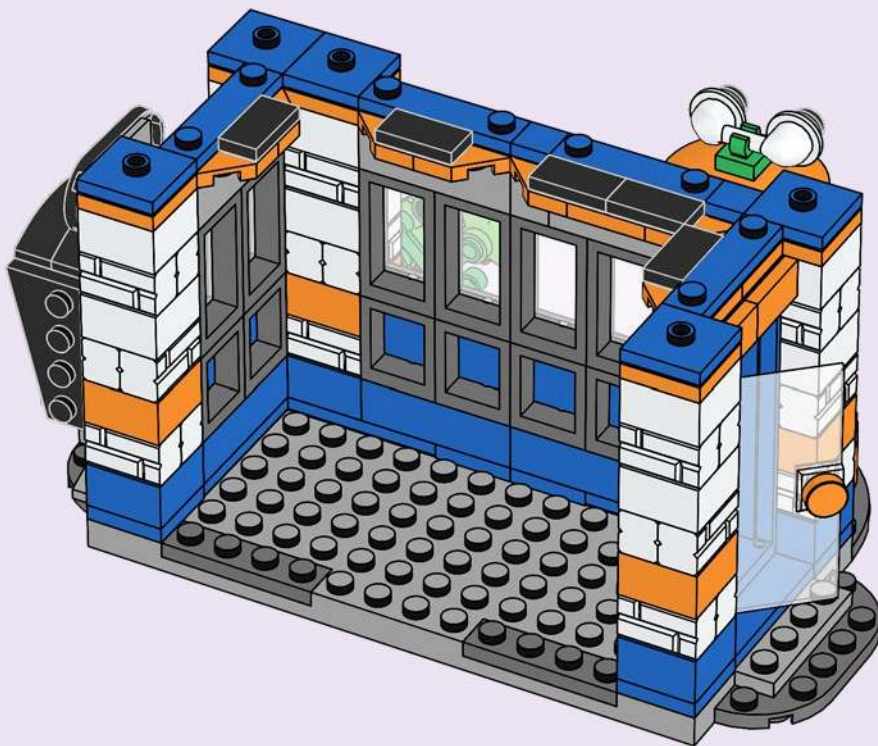

3

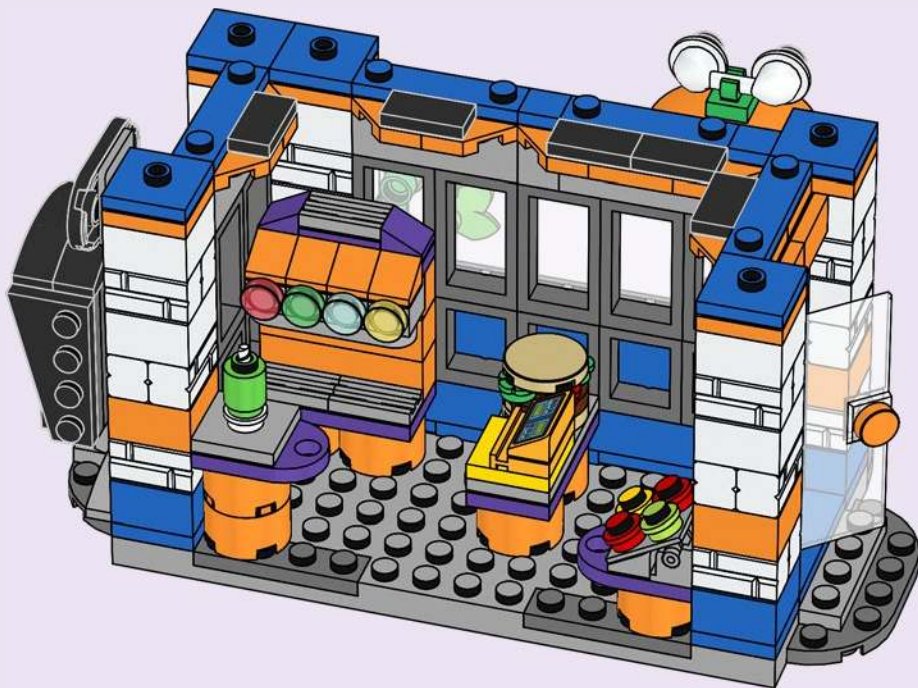



1

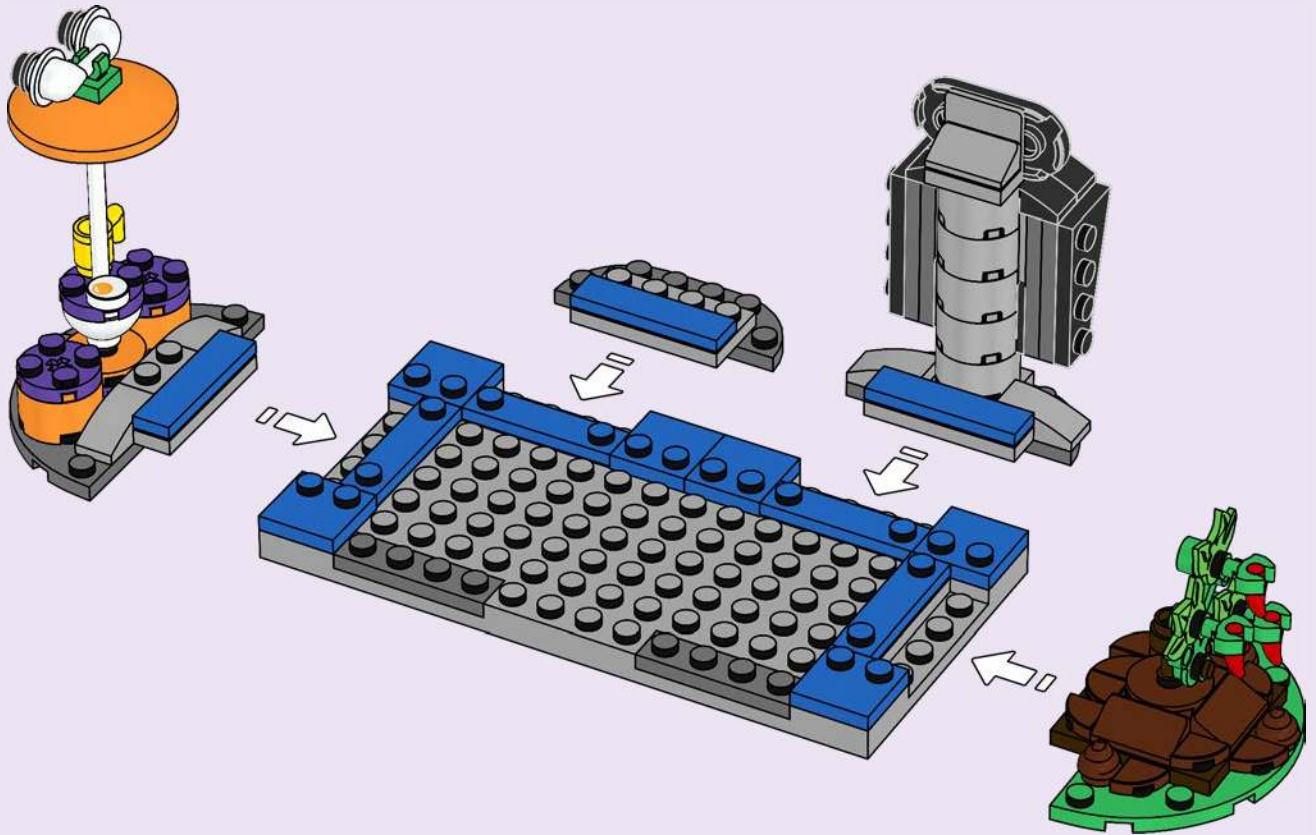

2



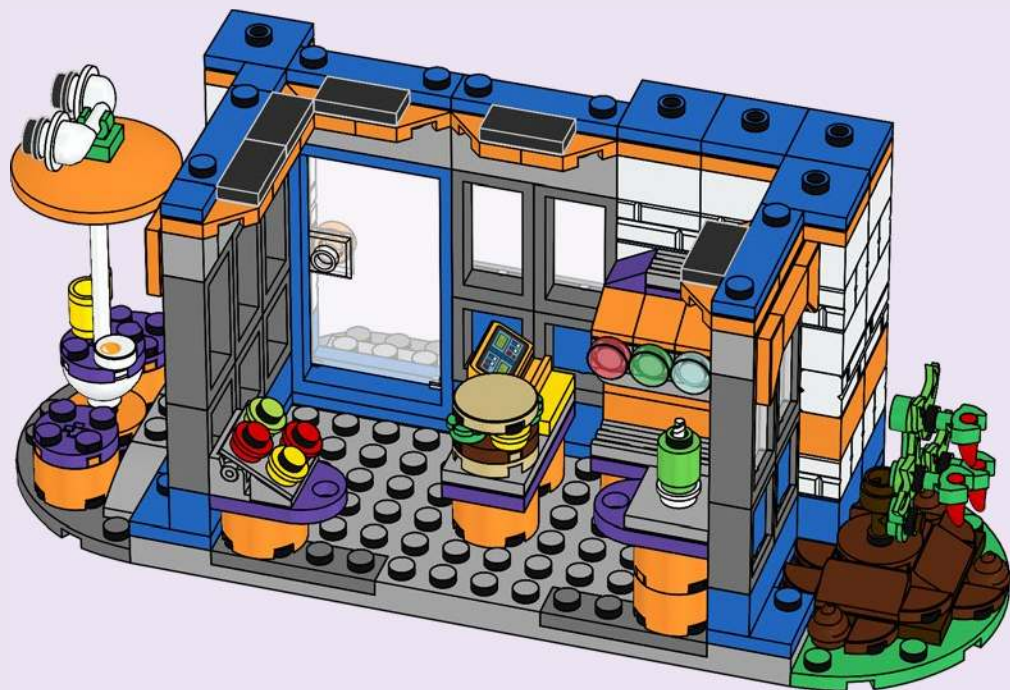





**Rebuild
the
World™**





FORTNITE

77077



77075



77076



1x
6192793



1x
6285620



2x
6551353



2x
6508151



1x
6168642



1x
4651445



2x
6240495



2x
6252200



30x
6152409



1x
6050914



1x
6358288



10x
300301



1x
6359891



1x
6170419



4x
4161734



1x
6447501



6x
6212758

1x
6066344

1x
6024495

5x
4218749

1x
4140562

1x
6443062

4x
6270107

1x
6284574

1x
6206148

3x
614121



1x
6170419



4x
4161734



1x
6447501



6x
6212758



1x
6066344



1x
6024495



5x
4218749



1x
4140562



1x
6443062



4x
6270107



1x
6284574



1x
6206148



3x
614121



2x
6270088



2x
4142865



2x
6078641



1x
306821



2x
6108802



2x
4206330



7x
6555203



2x
4206482



1x
306923



2x
302323



6x
6252060



5x
6126049



5x
300323



8x
6271125



8x
6292291



3x
243123



2x
301023



1x
6262960



5x
366623



1x
300923



5x
379523



4x
416223



2x
614124



1x
389924



2x
6195184



1x
6224666



2x
302224



2x
6130007



1x
6116475



4x
6168646



2x
6335317



4x
6284699



1x
6371584



3x
6279875



2x
6265091



8x
6210270

2x
4512363

5x
306926

1x
6561913

1x
6551323

2x
6114987

1x
6016172

4x
4253815

4x
403226

1x
9339

3x
4593678

1x
4160869

1x
4161332

1x
6234806

1x
6262897

1x
6331483

1x
6559611

2x
4613153

1x
6258904

4x
302026

2x
365926

1x
6256116

1x
6469830

1x
6543003

1x
6514189

1x
6514192

1x
6514193

1x
6514194

1x
6284582

3x
6510144

4x
4504371

4x
4521571

3x
6510130

2x
6347295

1x
6109909

6x
4188771

3x
4177932

8x
6218367

1x
6030521

9x
4141089

1x
6551320

8x
6415898

2x
4542142

8x
4159007

5x
4153825

3x
4118828

3x
6481562

1x
6559590

1x
6555201

1x
6226926

3x
4648853

2x
4118827

1x
6240515

1x
6313826

2x
6284583

2x
6555202

1x
4183133

1x
6174006

2x
6264062

1x
6314353

1x
6024286

1x
6408683

8x
6262085

2x
6403579

1x
6126082

1x
4211881



1x
6456718

5x
6402876

1x
6472550

4x
4211636

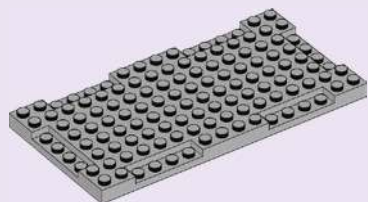
1x
6079461



2x
6417816

2x
4558953

4x
4211476

2x
6362975

4x
6028813

2x
4211398

3x
4211350

3x
6311384

2x
4568637

3x
4211526

1x
4211469

1x
4654580

3x
4211395

3x
6135287

1x
6401707

1x
6494113



3x
6541878

3x
6182261

1x
6268814

1x
6133767

1x
6551334

7x
6252258

1x
6514119

9x
6149677

3x
6438899

2x
4504376

2x
4221744

1x
6310449

1x
6248944

2x
6153863

3x
6102360

2x
6069984

3x
4211150

1x
6353186

3x
6035291

1x
4211159



2x
4270470



2x
6555204



4x
6501163



5x
4216625



5x
4211190



2x
6561681



1x
4211211



1x
4225715



2x
6228923



3x
6221607



1x
6551326



7x
6396397



7x
6468352



1x
6284702



1x
4211007



1x
4211006



12x
4211001



2x
6388294



1x
6141856



1x
6542399



1x
6498749



2x
6230082



1x
6559605



2x
4567509



1x
4655695



4x
6030534



2x
6174596



1x
6167464



2x
6030277



1x
6195315



3x
6271374



1x
6537938



4x
6300222



2x
6226792



2x
6456639



1x
6093532



1x
6078442



1x
6295400



1x
6551321



1x
6551324



1x
6035734



[LEGO.com/service](https://www.LEGO.com/service)

YOU COULD
WIN

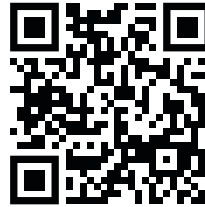

Scan this QR code or go to
LEGO.COM/PRODUCTFEEDBACK and give us
your short feedback about this LEGO® set
for a chance to win a cool LEGO prize.

Terms and Conditions apply*



EN: YOU COULD WIN. Terms and Conditions apply* **DE: Du könntest GEWINNEN.** Es gelten die Teilnahmebedingungen* **FR: Tu pourrais GAGNER.** Des conditions s'appliquent* **IT: Potresti VINCERE tu.** Termini e condizioni sono applicabili* **ES: Puedes GANAR.** Aplican términos y condiciones* **PT: PODERÁ GANHAR.** Aplicam-se Termos e Condições* **ZH: 轻松获奖. 条款和条件适用*** **PL: Szansa na WYGRANĄ.** Obowiązuje regulamin* **CS: Máte šanci VYHRÁT.** Platí všeobecné smluvní podmínky* **SK: Máte šancu VYHRAŤ.** Platia všeobecné zmluvné podmienky* **HU: TE IS NYERHETSZ.** Felhasználási feltételek érvényesek* **UA: ВИ МОЖЕТЕ ВИГРАТИ.** Застосовуються загальні положення та умови* **RO: Ai putea CÂȘTIGA.** Se aplică termeni și condiții* **BG: Можете да СПЕЧЕЛИТЕ.** Има определени правила и условия* **LV: Tu vari LAIMĒT.** Ir spēkā noteikumi un nosacījumi.* **ET: Sul on võimalus VÕITA.** Kehtivad tingimused* **LT: Jūs galite LAIMĖTI.** Taikomos sąlygos*
**LEGO.com/productfeedback-terms*

LEGO and the LEGO logo are trademarks of the LEGO Group. ©2025 The LEGO Group.

© 2025 Epic Games, Inc. All rights reserved. Fortnite and its logo are trademarks of Epic Games, Inc. in the USA (Reg. U.S. Pat. & Tm. Off.) and elsewhere.