

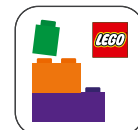

21357



Booklet available in English
Heft in deutscher Sprache erhältlich
Livret disponible en français
Libretto disponibile in italiano
Folleto disponible en español
如需中文版手册



LEGO® Builder

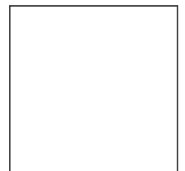



LEGO.com/sustainable-packaging



FR

DONNEZ
OU
RECYCLEZ



ASSOCIATION

OU



MAGASIN

OU



DÉCHÈTERIE

Adresses sur quefairedemesdechets.fr



BUILDER



Apple and the Apple logo are trademarks of Apple Inc., registered in the U.S. and other countries and regions. App Store is a service mark of Apple Inc. Google Play and the Google Play logo are trademarks of Google LLC. Tencent and the Tencent logo are trademarks of Tencent Inc.

LEGO.com/devicecheck



LEGO® Builder

Meet the Fan Designer

Toby Brett (LEGO® Ideas name T0BY1KENOBI20506) is from London, England. His physics studies at the University of Manchester keep him busy, but he always finds time to build:

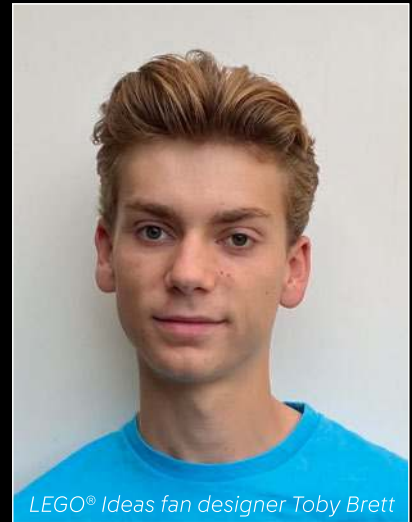

LEGO® Ideas fan designer Toby Brett

Toby's original Luxo Jr. character model



"LEGO building has been a huge part of my life for as long as I can remember. It's more than a hobby for me, it's an outlet for creativity. I love building official sets, but my passion lies in designing MOCs (My Own Creations), both digitally and with real bricks. I've even displayed my creations at LEGO exhibitions, which is always rewarding. One of my favourite projects has been recreating the Luxo Jr. character. This iconic Pixar mascot symbolises my love for their films. It took weeks of research, studying images to make the model

as accurate as possible. The biggest challenge was ensuring the model could stand on its own, especially after I started designing the model digitally. The ball was tricky to recreate smoothly at this scale, but after multiple prototypes, I was happy with the result. When the project reached the 10,000 votes, it was an incredible feeling, and I want to thank everyone who supported it! LEGO Ideas is a fantastic platform where anyone can become a designer with the right idea. I definitely have plans for more. The possibilities are endless!"





Evolving animation by leaps and bounds

Art has frequently challenged technology, just as technology has often inspired and facilitated art. Not least on the big screen. With the rise of 3D graphics and computer science throughout the 1980s and 1990s, visionary animation and special effects artists embraced the opportunity to imbue characters, landscapes and textures with groundbreaking, realistic details. One profound milestone moment in this evolution came in the shape of a playful little desk lamp character created at Pixar Animation Studios for the 1986 short film *Luxo Jr.*



Small lamp – Big personality

First introduced by Pixar in the now legendary 1986 animated short film, the Luxo Jr. character bounced his way into the hearts and imaginations of audiences in the film industry and beyond. Unlike any animated object seen before, the Luxo Jr. character displayed charm and emotion with his expressive movements and mischievous curiosity. Little did he or his creators know that he would not only spark, but also define, a new era in cinematic storytelling and computer-generated imagery. He remains the endearing symbol of the optimism, determination and creative innovation that characterises the pioneering Pixar spirit.



Stories built on curiosity

The Luxo Jr. character and the short film showcased how computer technology could facilitate creative storytelling to connect with audiences on a deep level. Decades and dozens of films later, the Luxo Jr. character still appears in the iconic Pixar logo in the opening credits of each new film. Even the iconic ball features in selected Pixar films as a playful surprise and



reminder of the heart and soul of the Pixar origin story. Both the Luxo Jr. character and his ball play important roles in this LEGO® model, too. You can pose and bounce the lamp to mimic some of his moves from the short film or show him 'jumping' on the ball. And if you look inside the ball, you will find small references to some of the most beloved Pixar characters and stories.



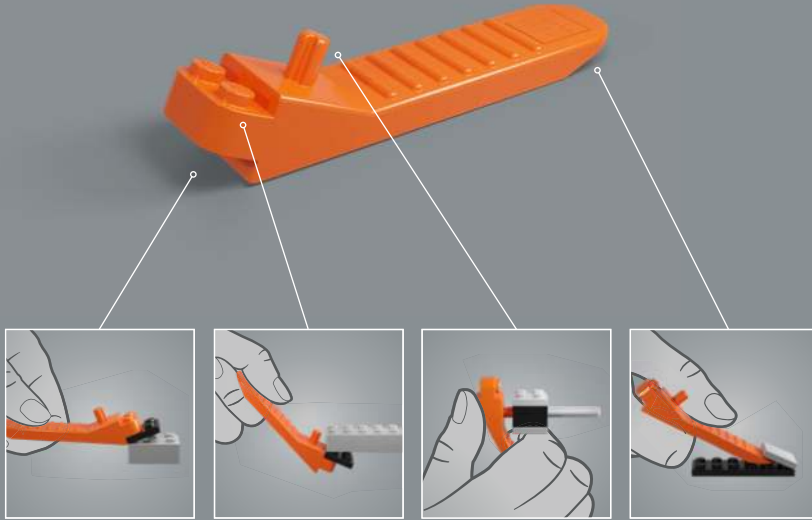



1

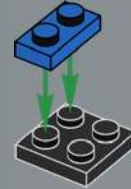

2

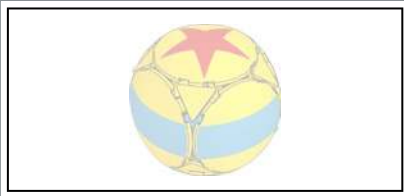
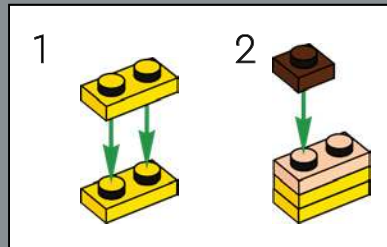

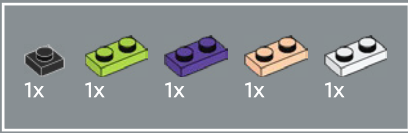

3

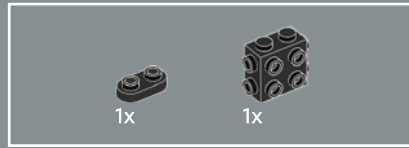
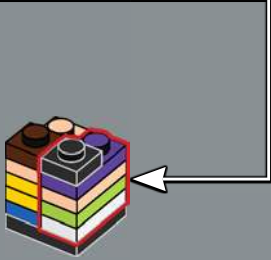
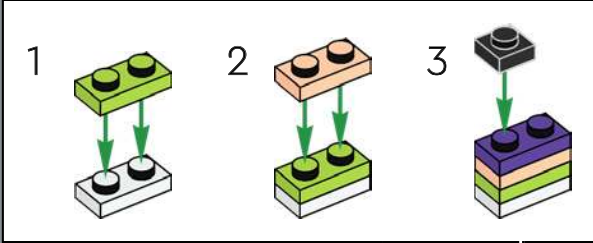

4

This miniature duo is inspired by Woody and Buzz Lightyear from *Toy Story* (1995).

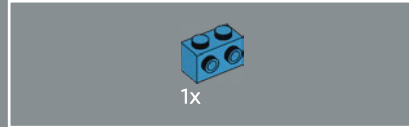

5



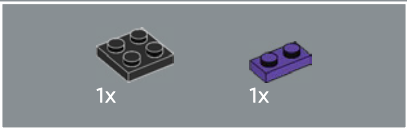

6

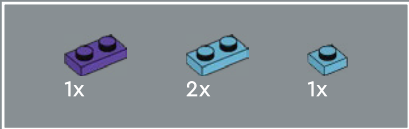
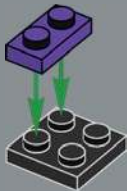

7

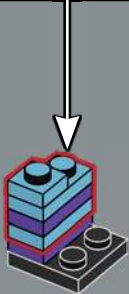
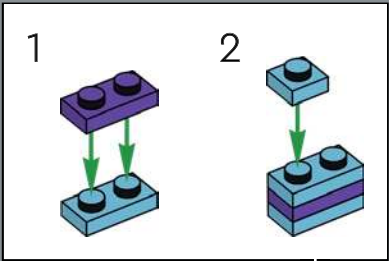



8

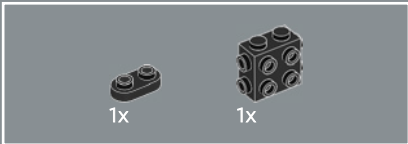
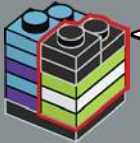
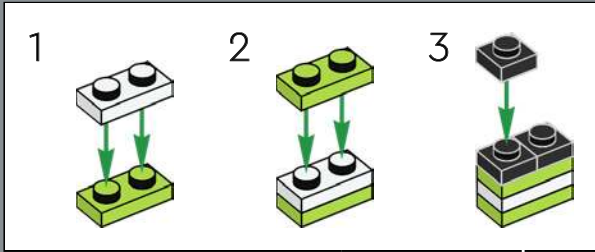

9

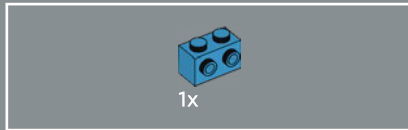

10

Recognise these micro characters? Mike Wazowski and his friend revolutionised *Monsters, Inc.* in 2001.



11

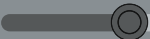
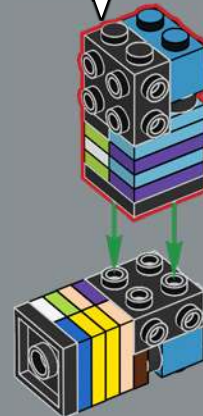

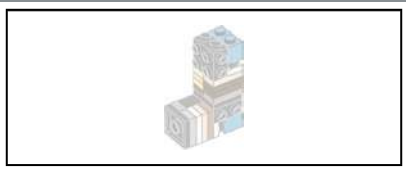

12

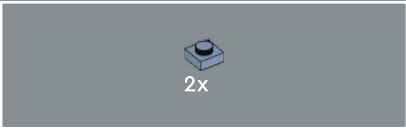
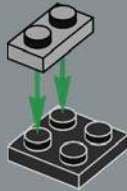

13

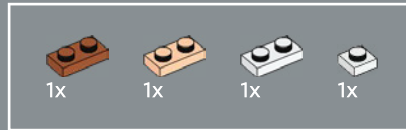
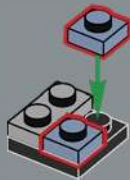

14

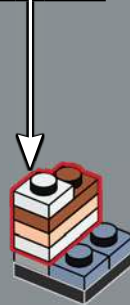
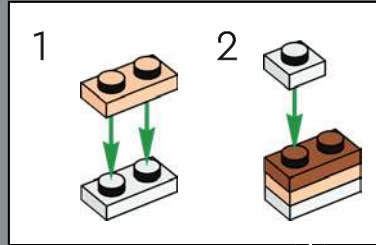

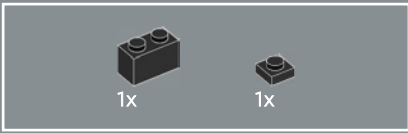

15

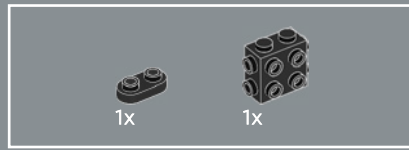
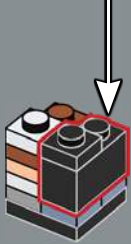
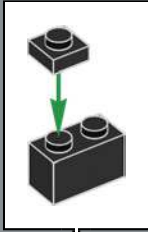

16

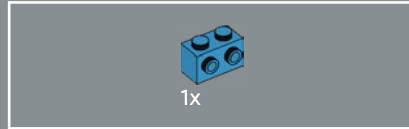

17



A hidden throwback to Alfredo Linguini and Remy cooking up crazy ideas in *Ratatouille* (2007).

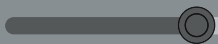

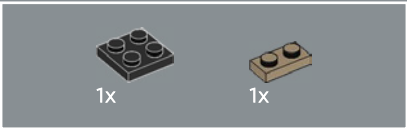

18

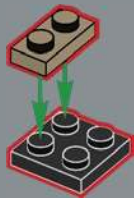

19

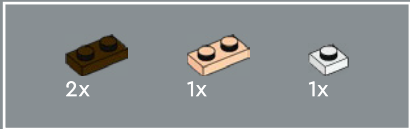
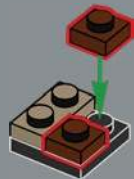

20

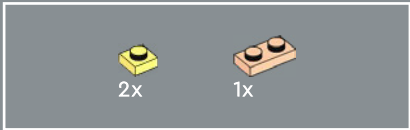
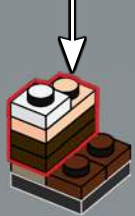
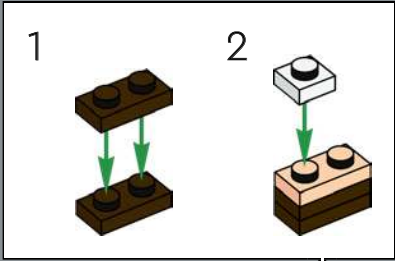

21





1x



2x

22



1x



1x

23



1x

24



These coloured bricks represent miniature tributes to Russel and Carl Fredericksen from *Up* (2009)

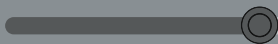

25

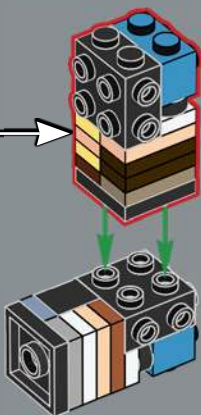

26

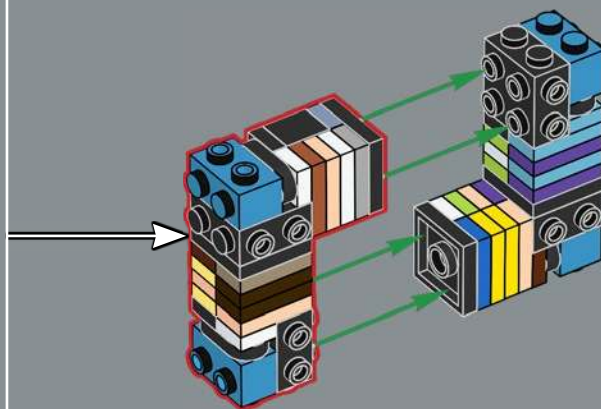

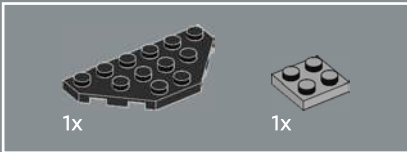

27

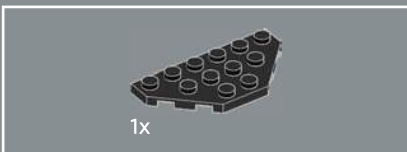
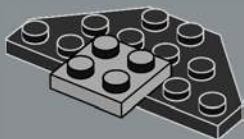

28

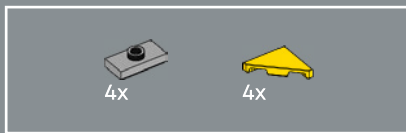
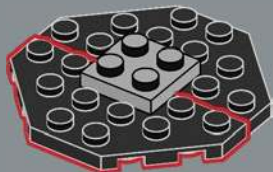

29



30

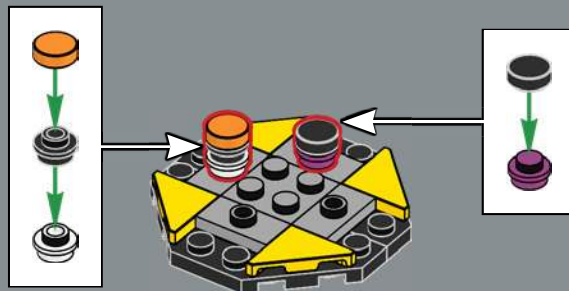



31

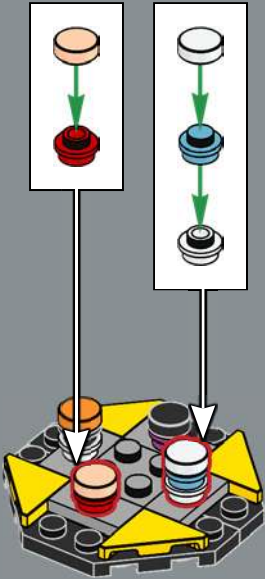

32

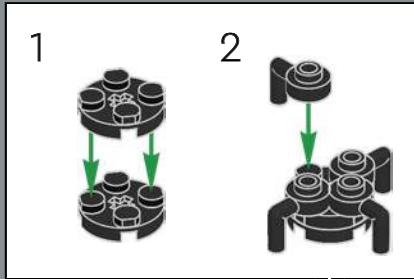



33

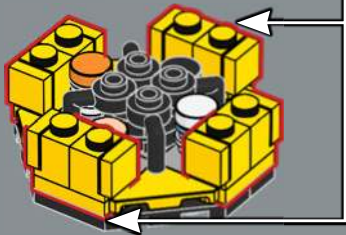
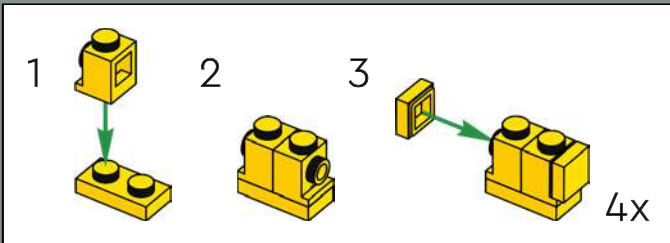

34

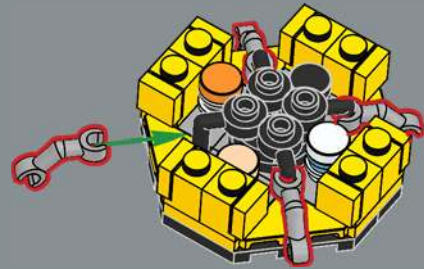

35





36

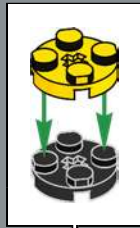
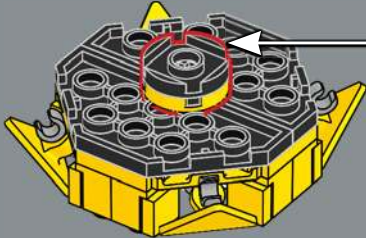

38

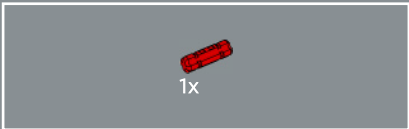

37

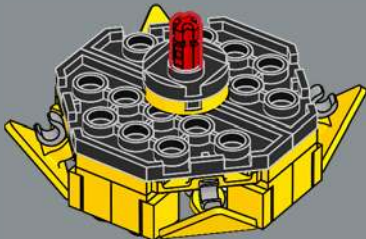

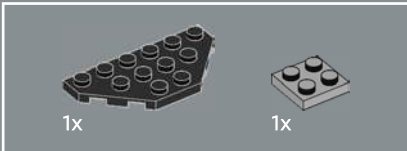

39

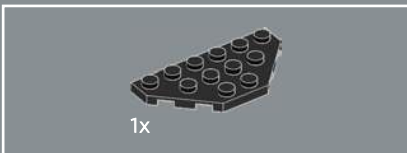
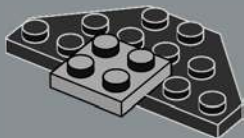

40

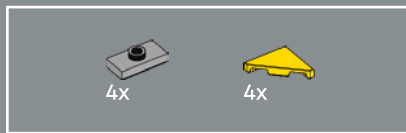
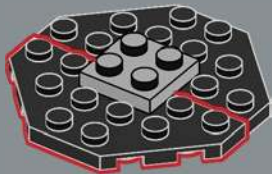

41



42

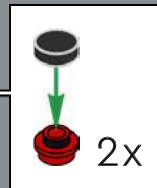
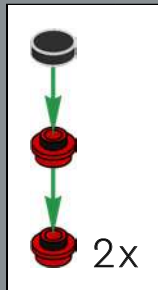



43

A special nod to an extraordinary family of heroes, *The Incredibles* (2004).

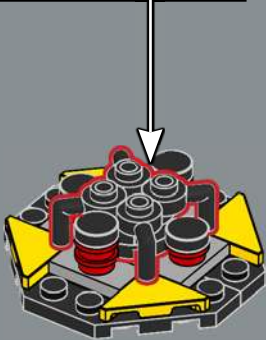
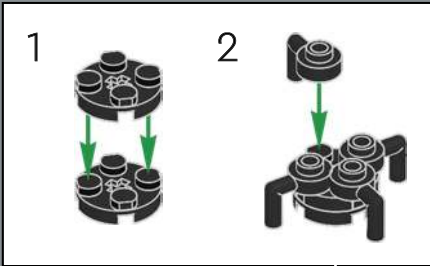

44

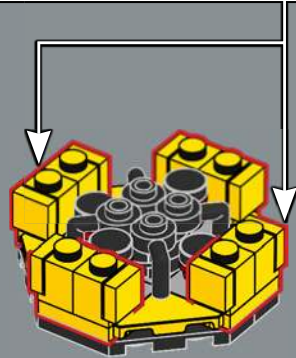
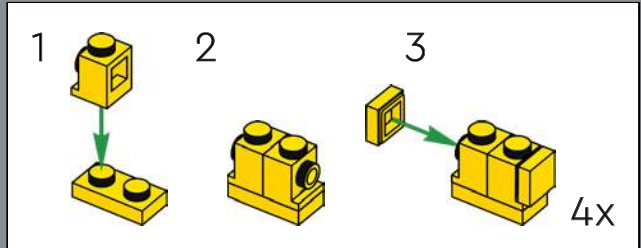



45

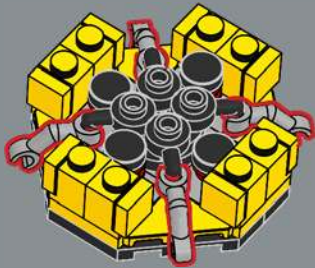

46



47

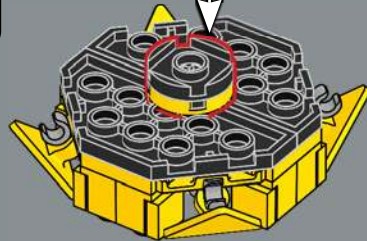

48



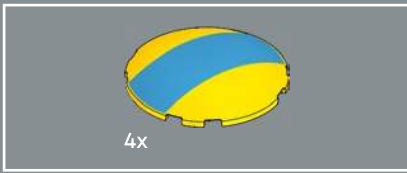

49



50

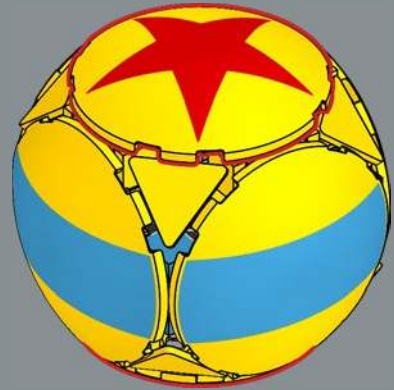

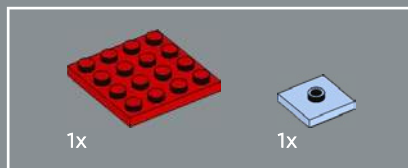

1

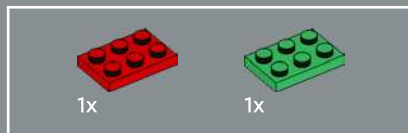
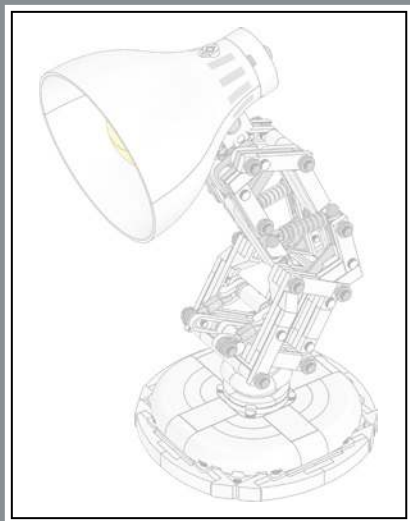

2

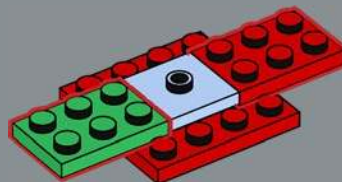



3

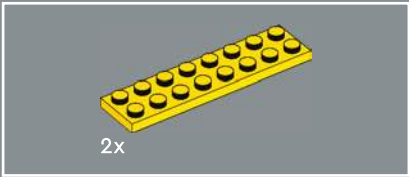
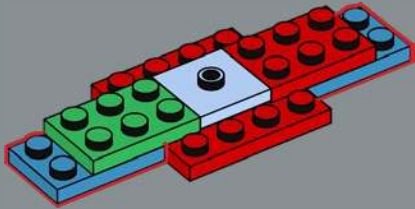

4

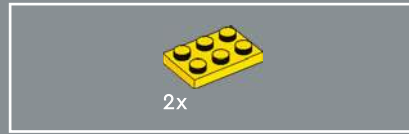
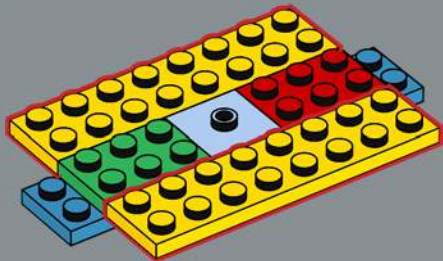

5

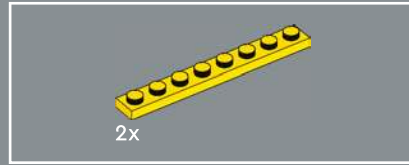
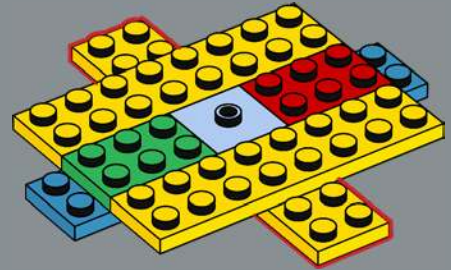

6

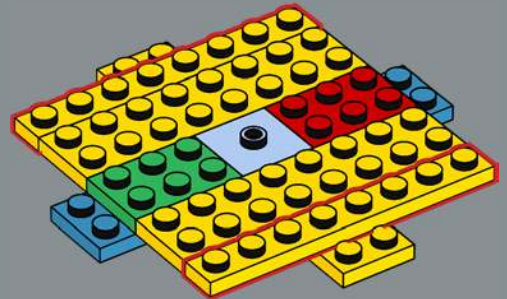

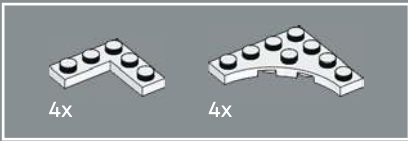

7

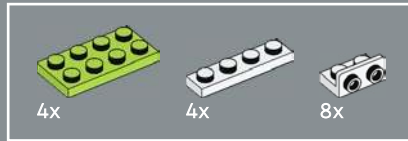
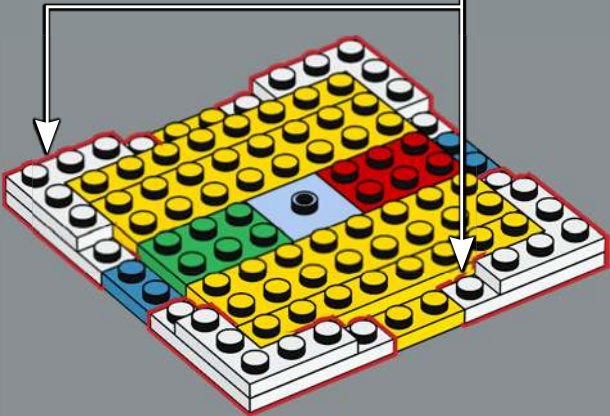
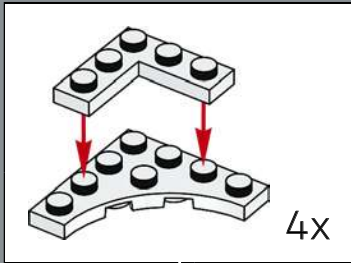

8

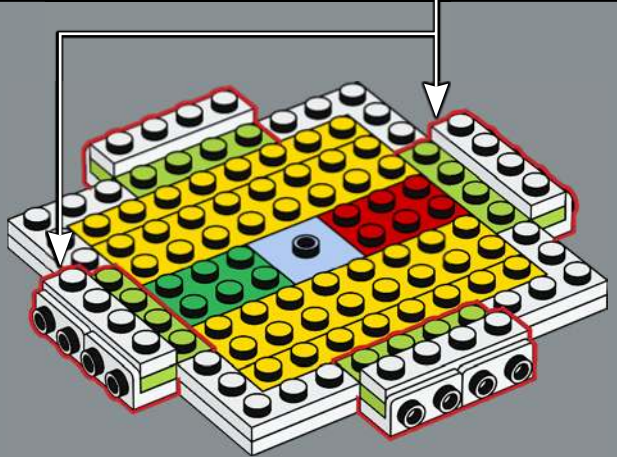
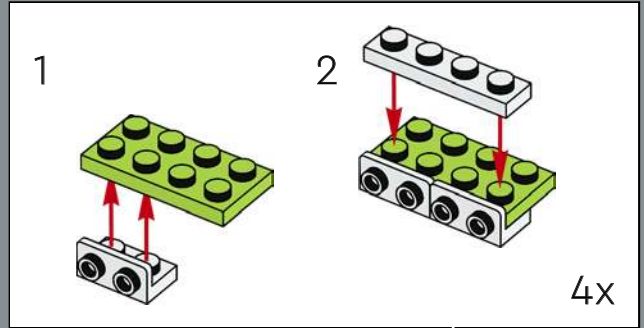

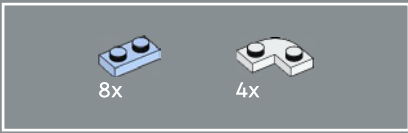

9

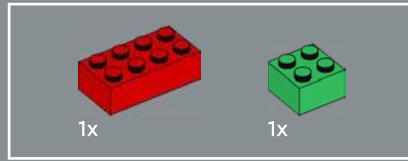
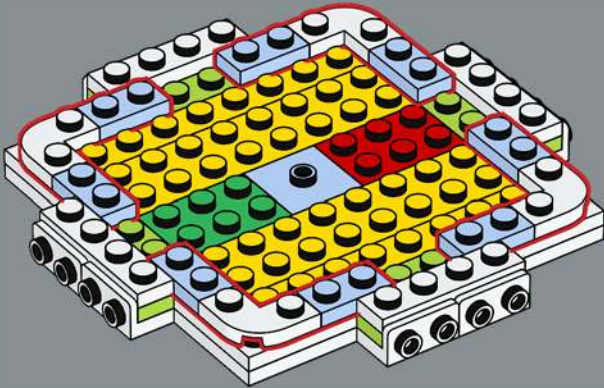

10

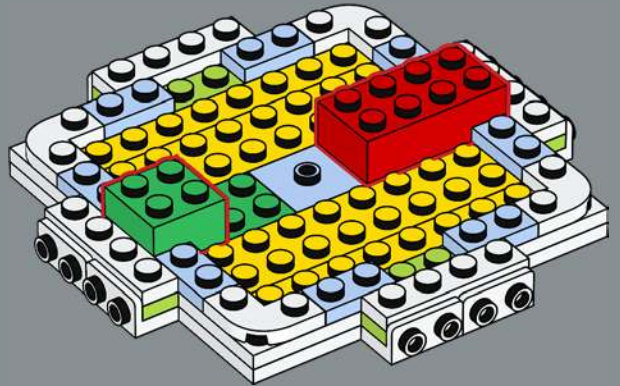

-  1x
-  2x
-  1x
-  1x
-  1x
-  1x

11

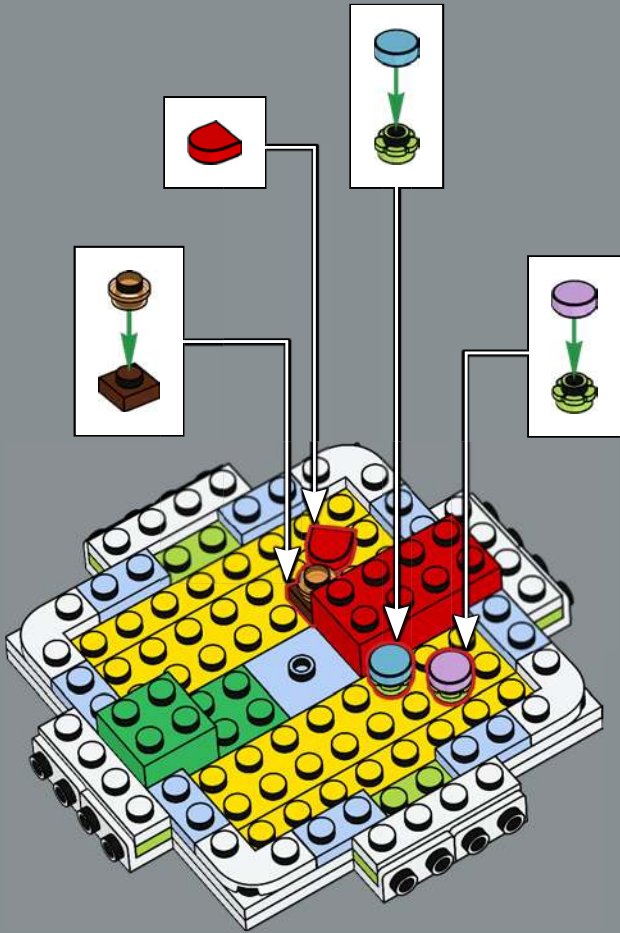

These little bricks stick together like Dory and Marlin from *Finding Nemo* (2003).

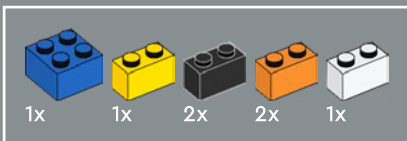

12

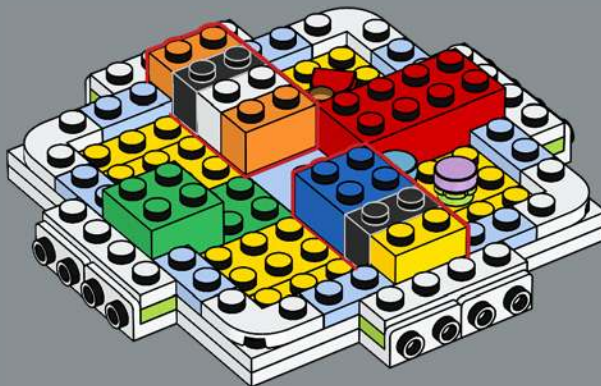



13

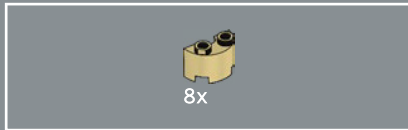
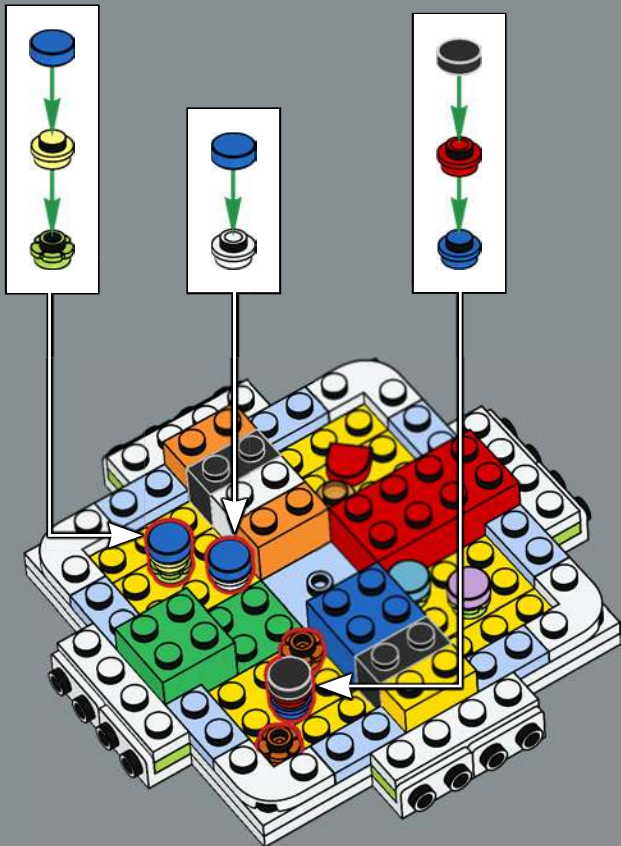

14

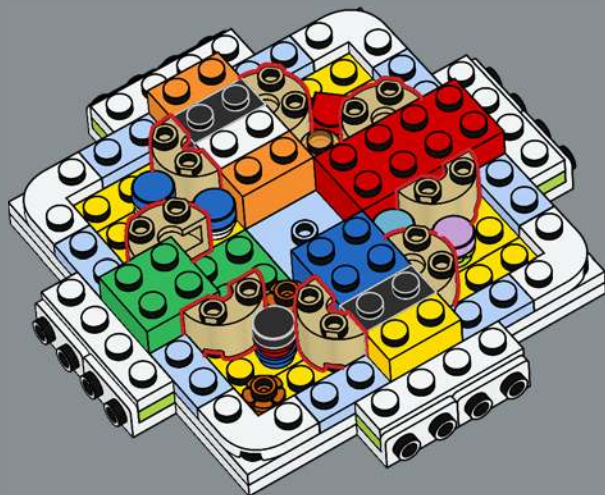

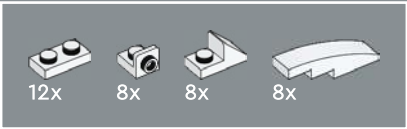
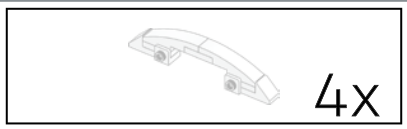

15

1

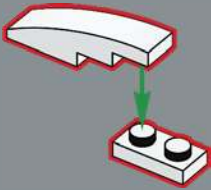

2

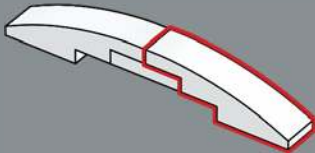

3

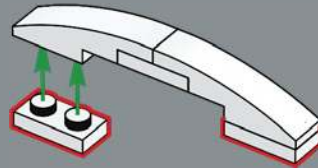

4

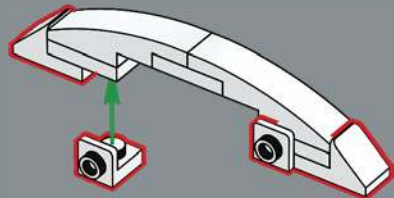

4x

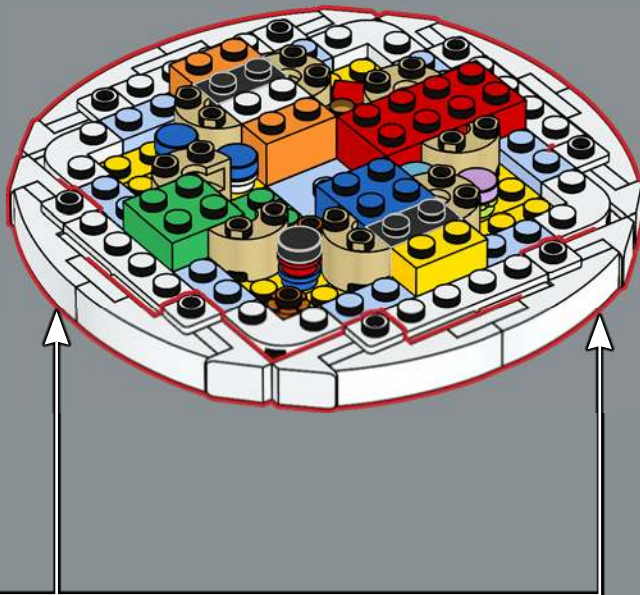

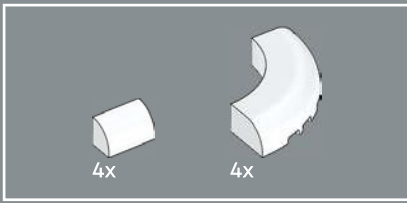

16

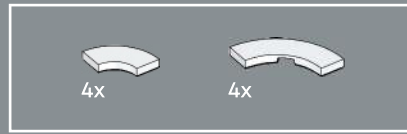
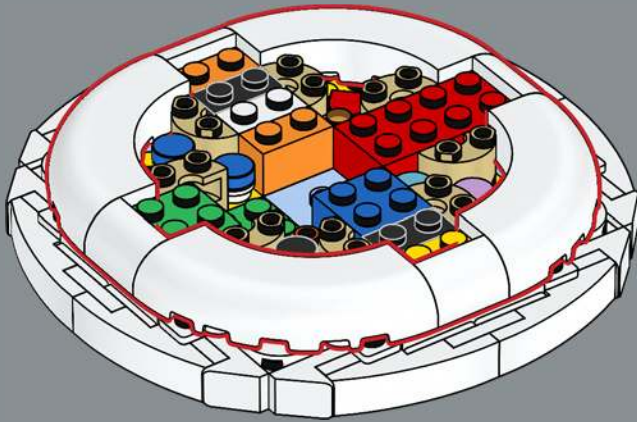

17

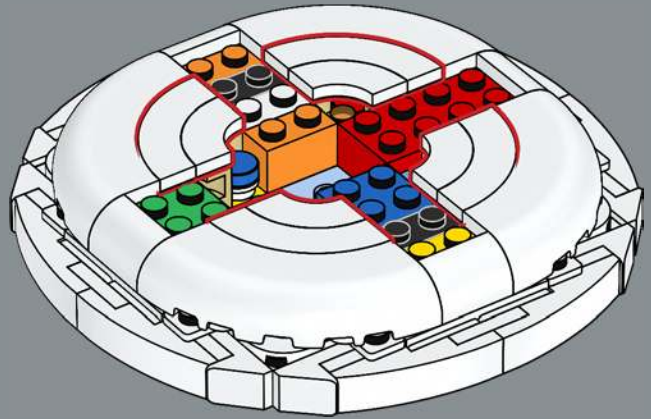

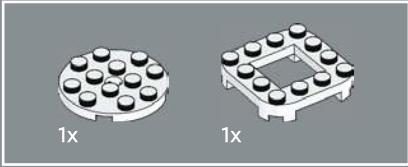

18

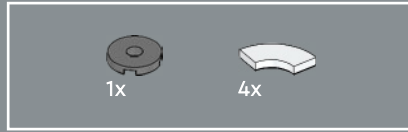
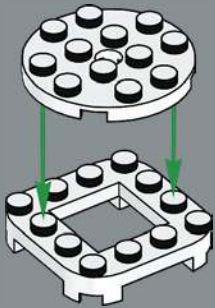

19

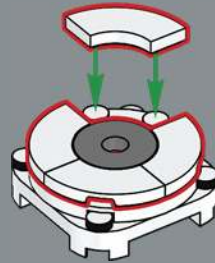

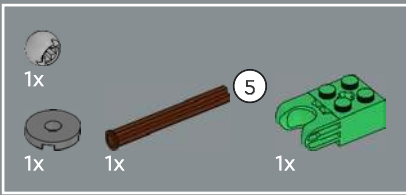

20

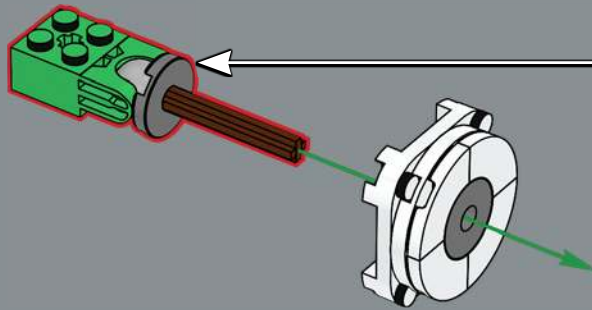
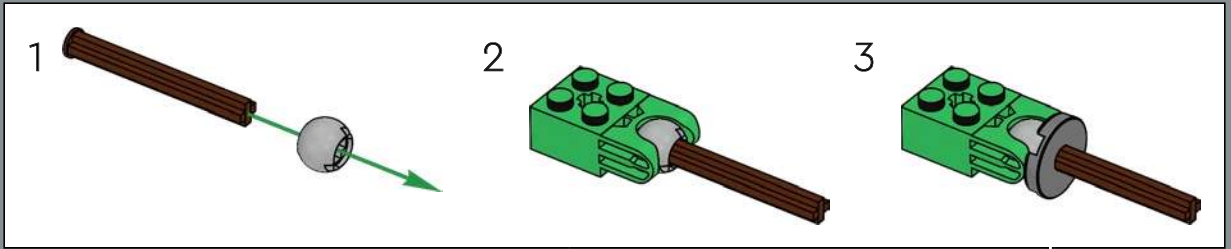



21

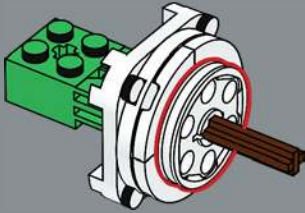

22

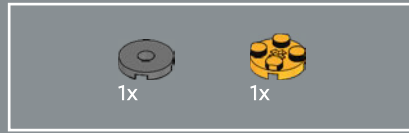
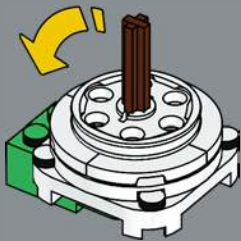

23

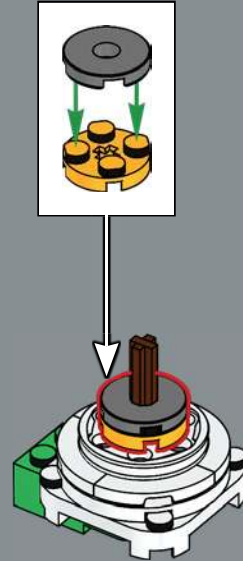

24

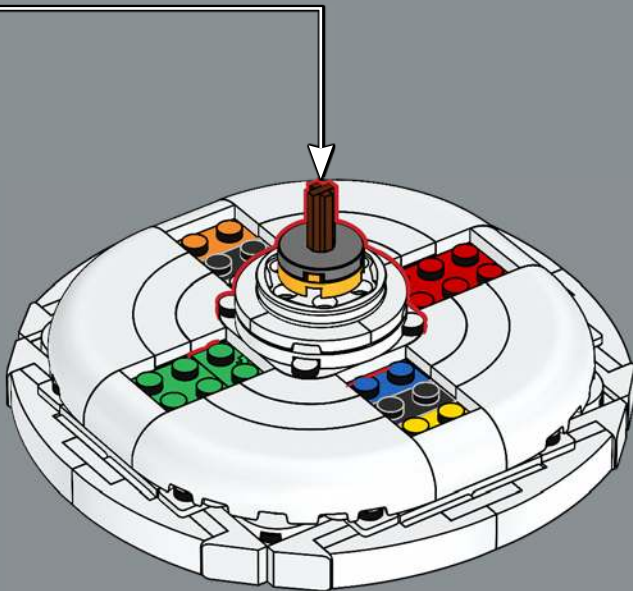

25

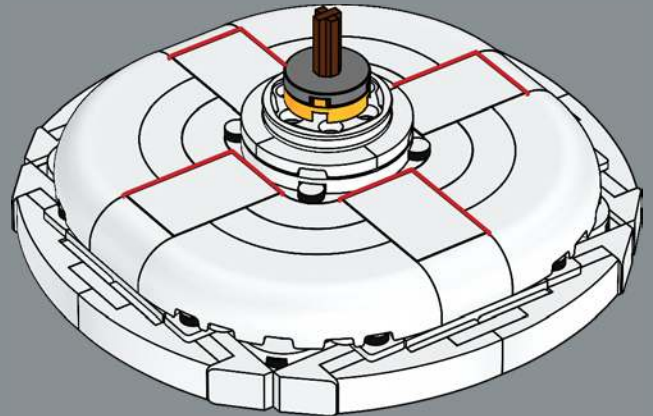

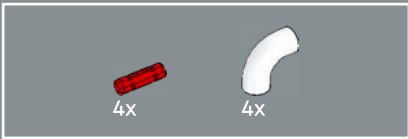

26

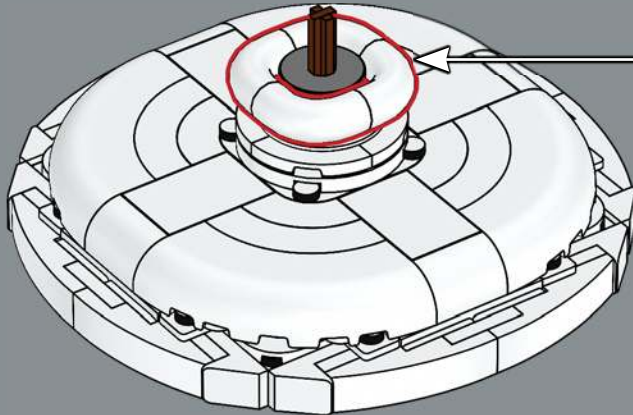
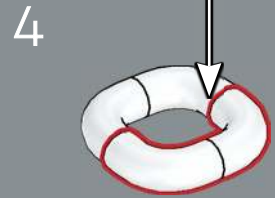
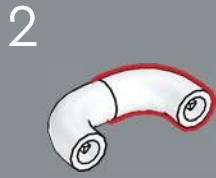
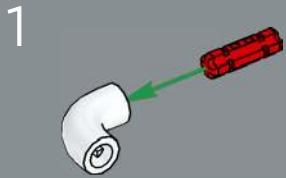
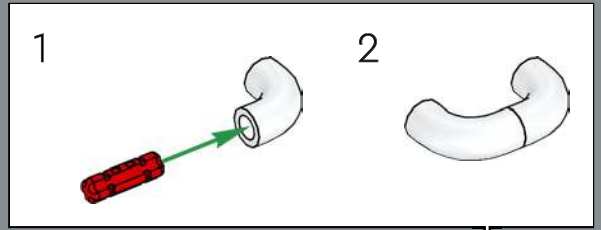

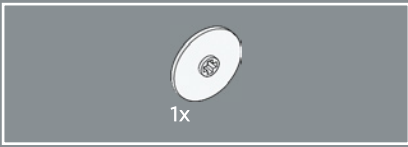

27

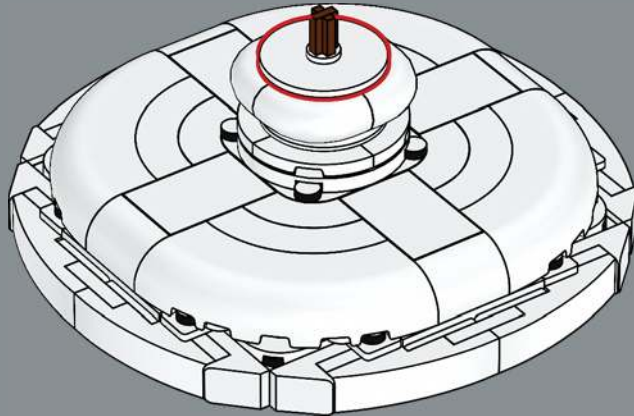

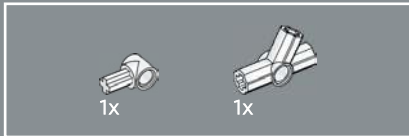

28

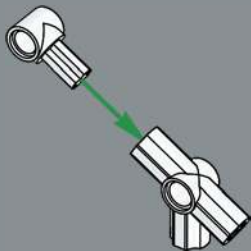

29

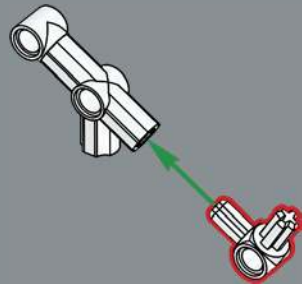

30

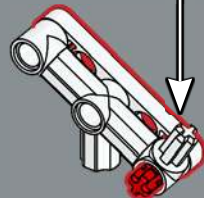
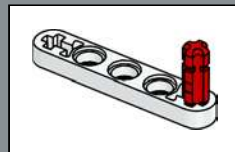



31

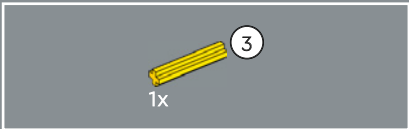
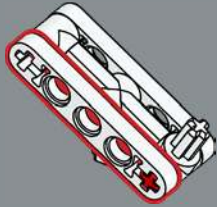

32

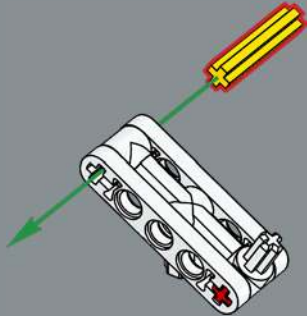

33

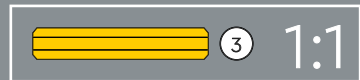
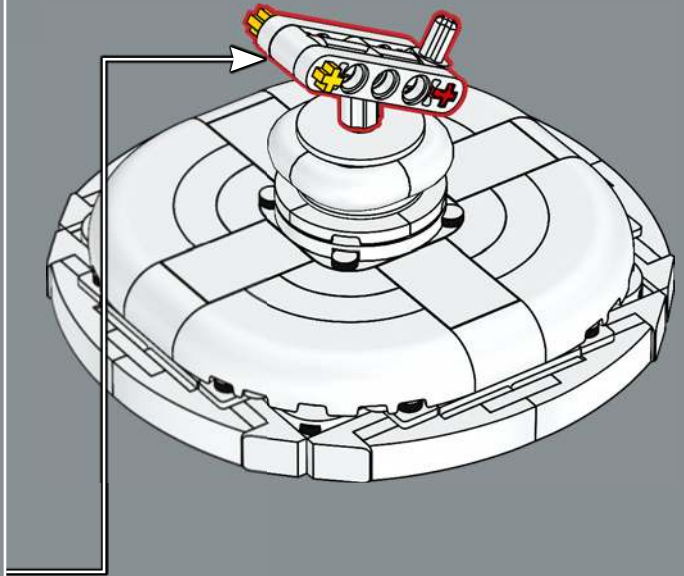

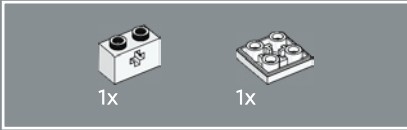
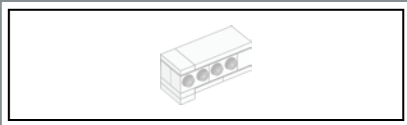

34

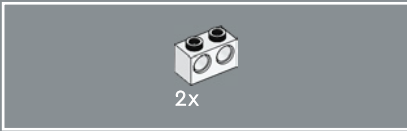
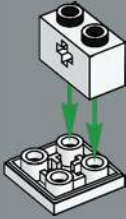

35

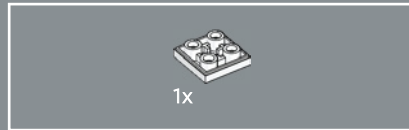
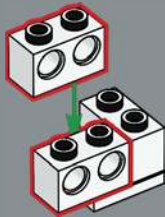

36

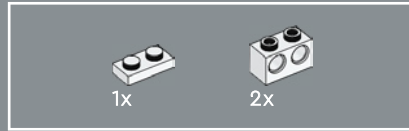

37

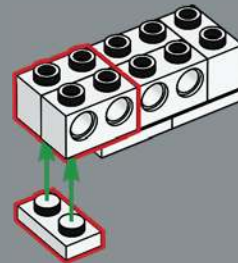

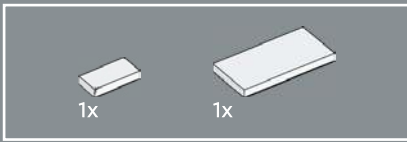

38

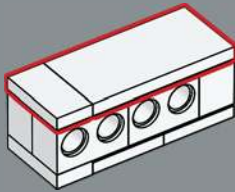

39

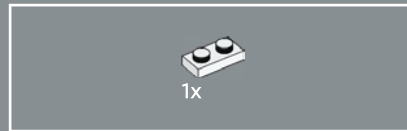
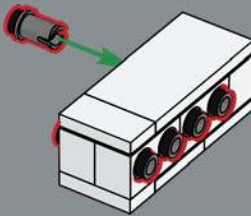

40

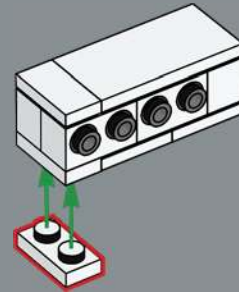

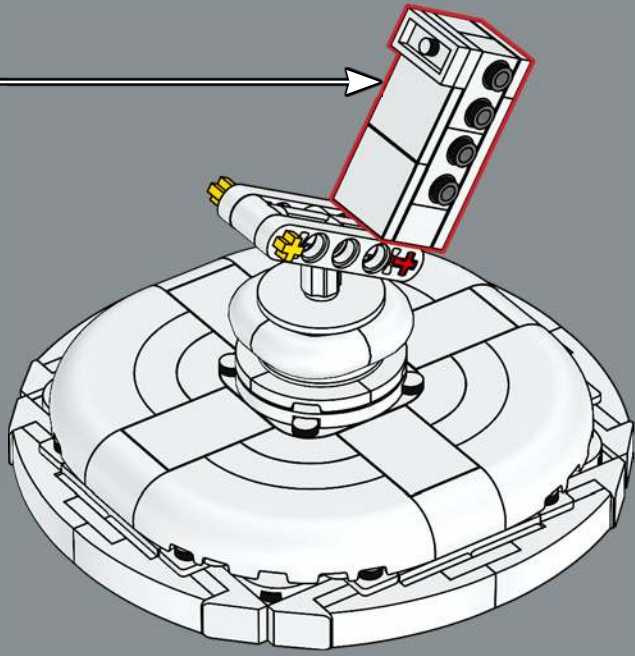

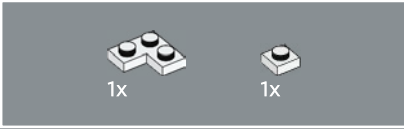
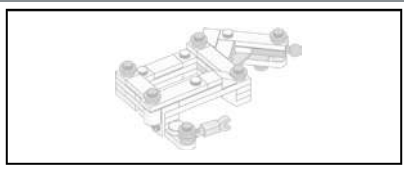

42

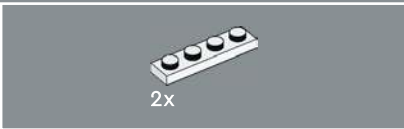
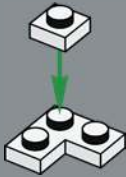

43

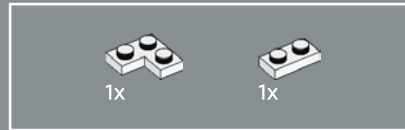

44

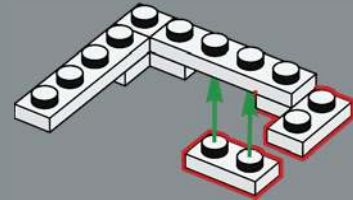



45

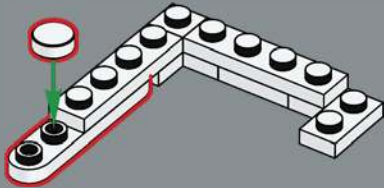

46

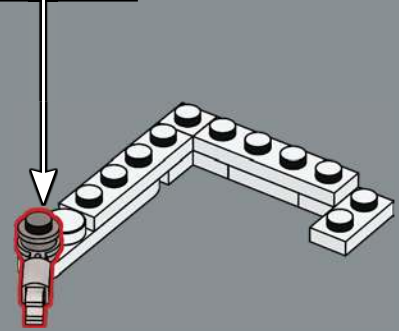
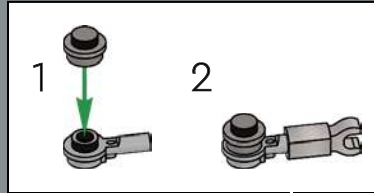

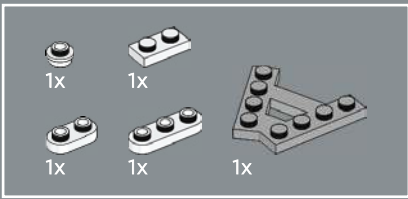

47

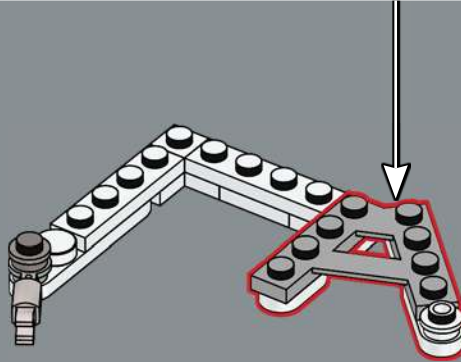
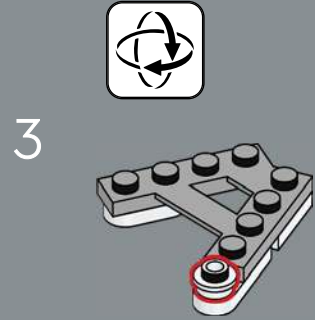
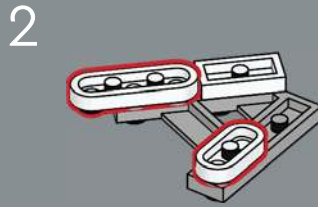
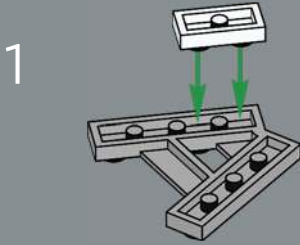

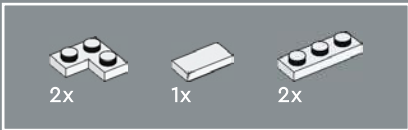

48

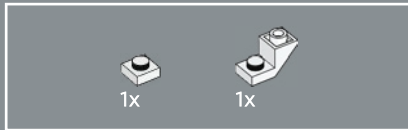
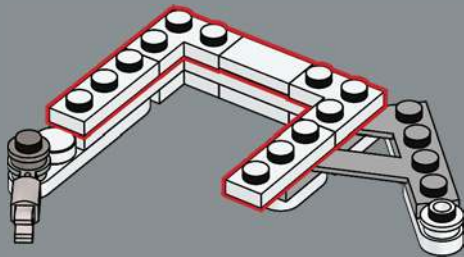

49

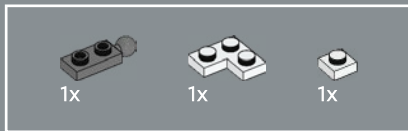
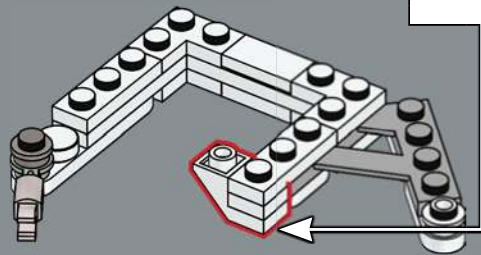

50

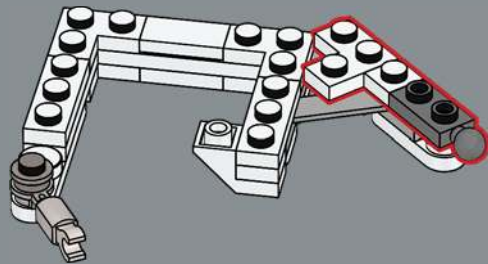

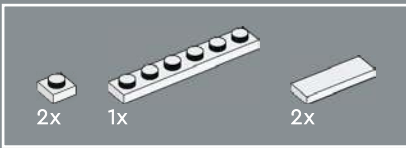

51

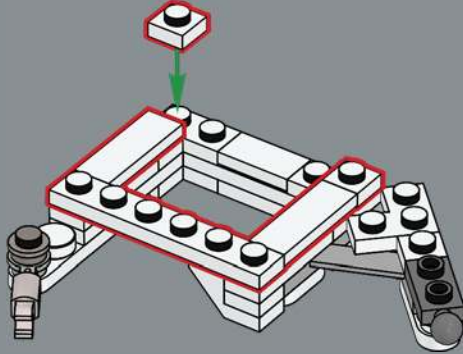

52

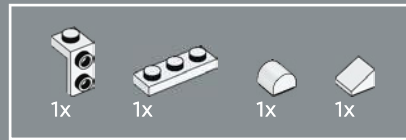
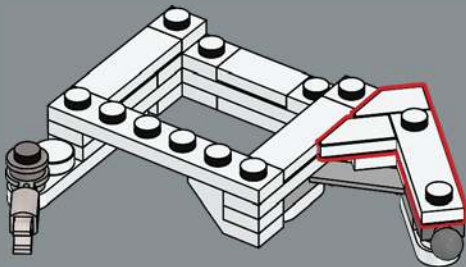

53

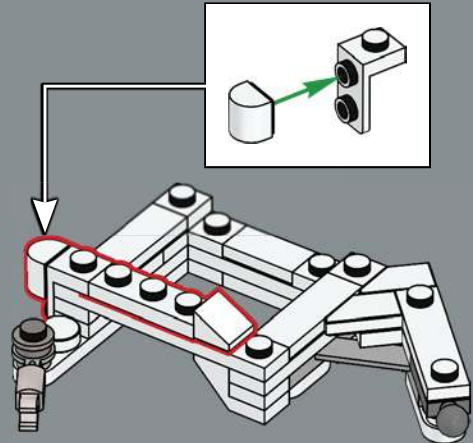



54

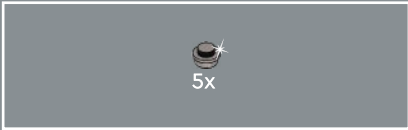
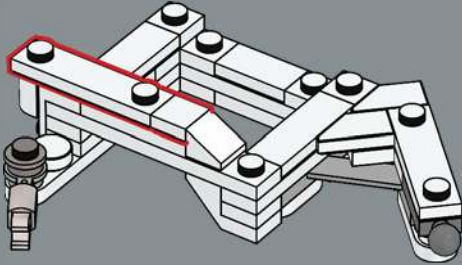

55

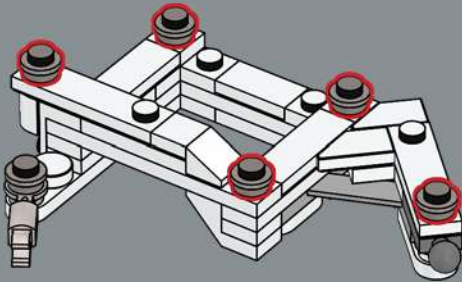

56

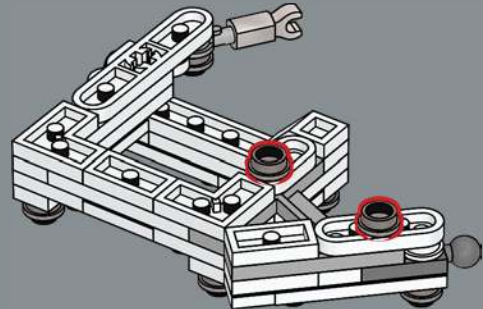

57

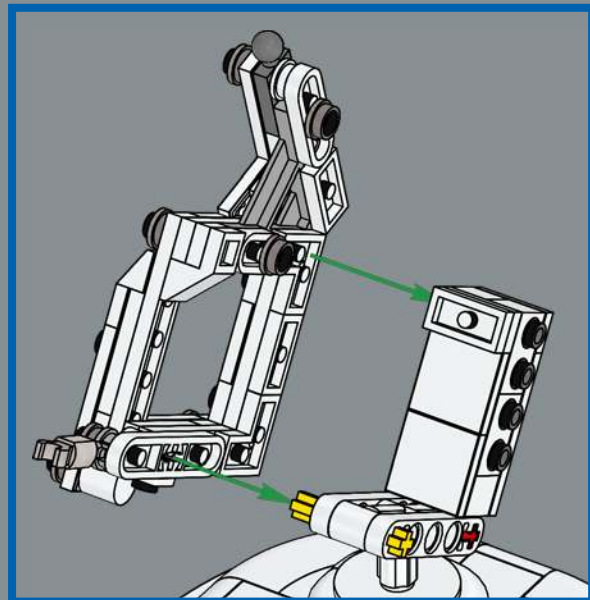
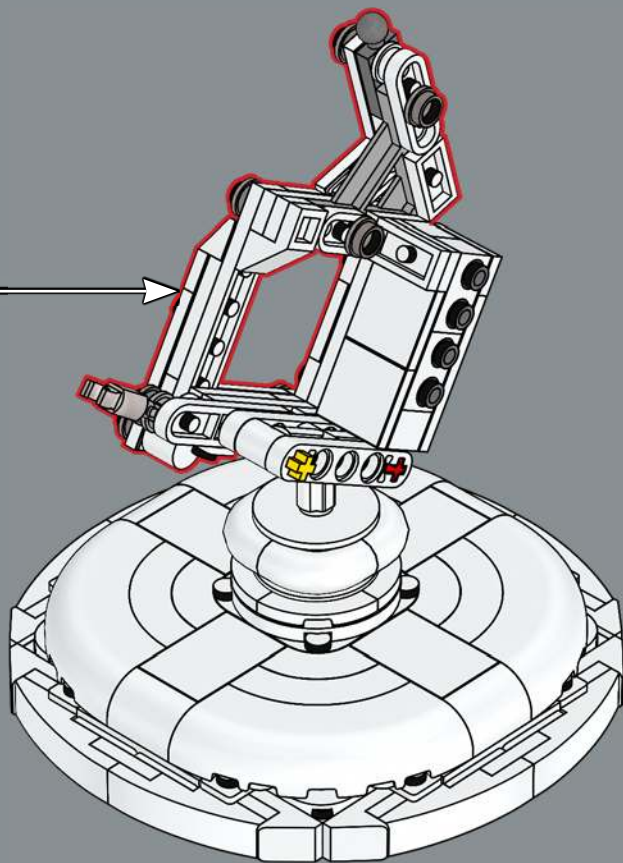

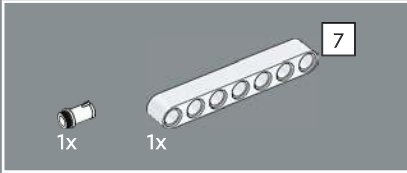
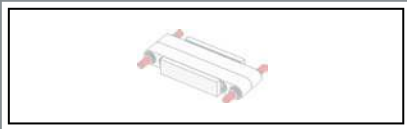

58

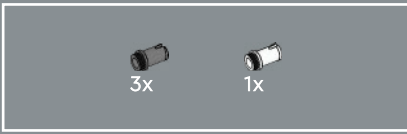
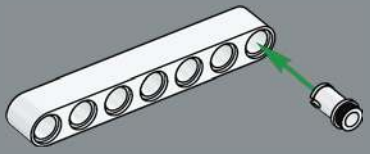

59

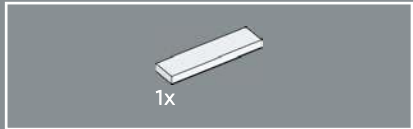
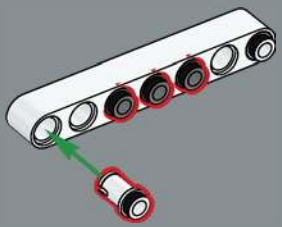

60

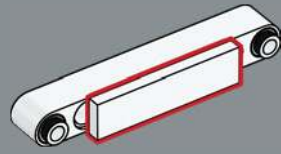

61

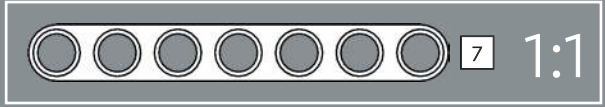
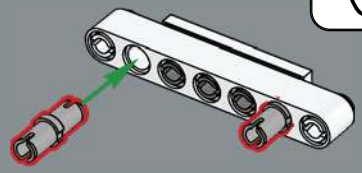

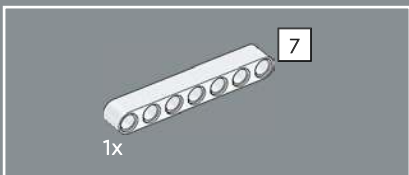

62

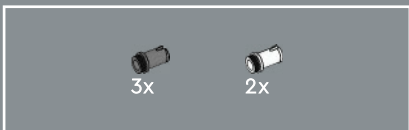
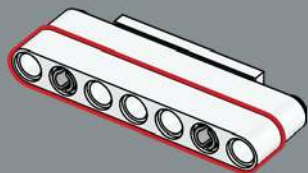

63

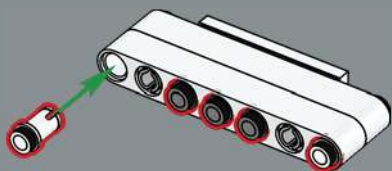

64

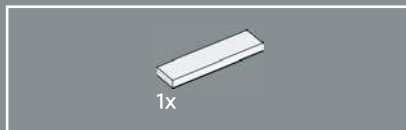
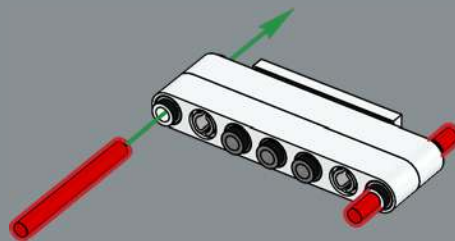

65

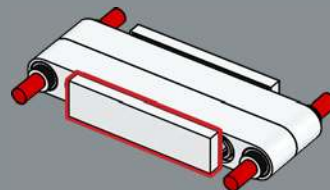

66

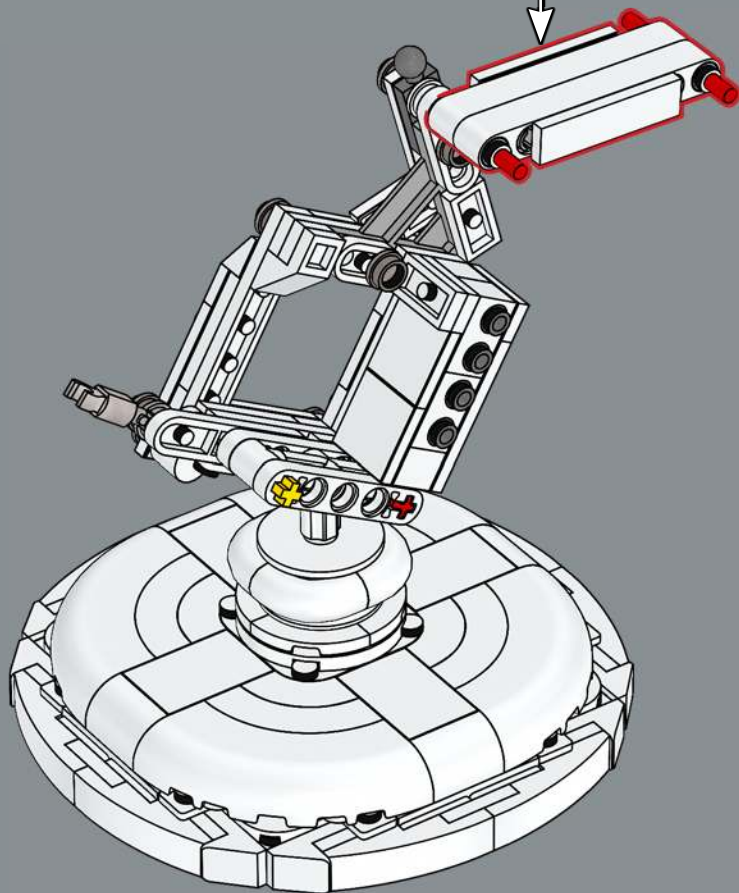

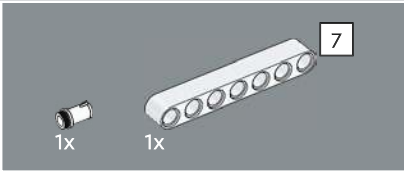
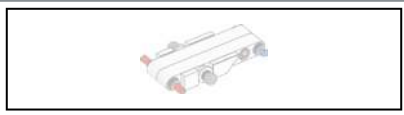

67

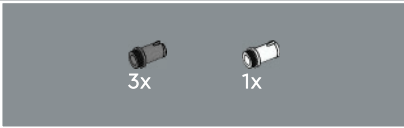
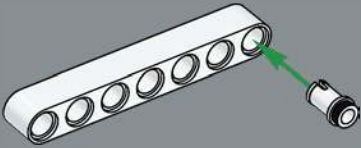

68

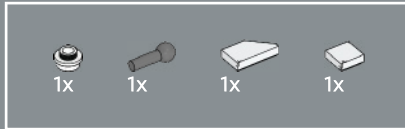
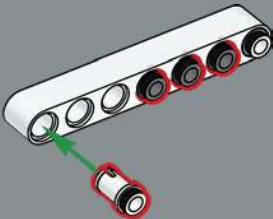

69

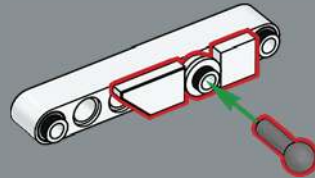

70

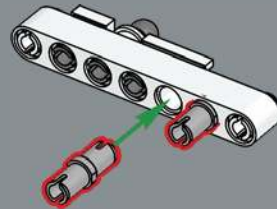

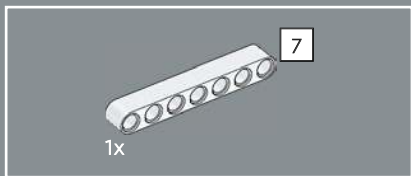

71

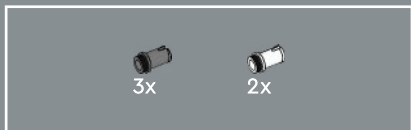
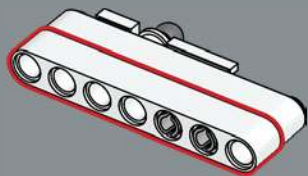

72

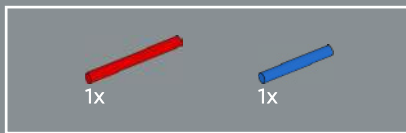
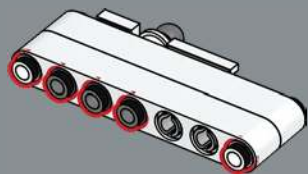

73

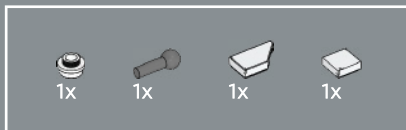
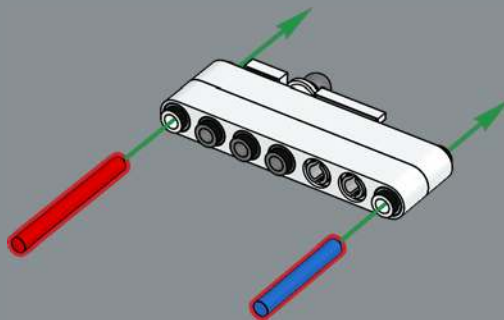

74

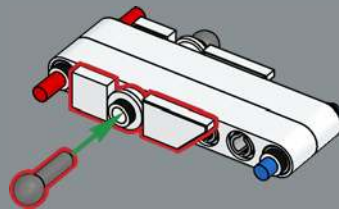

75

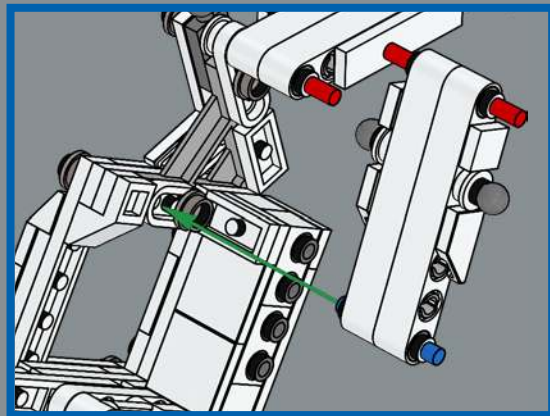
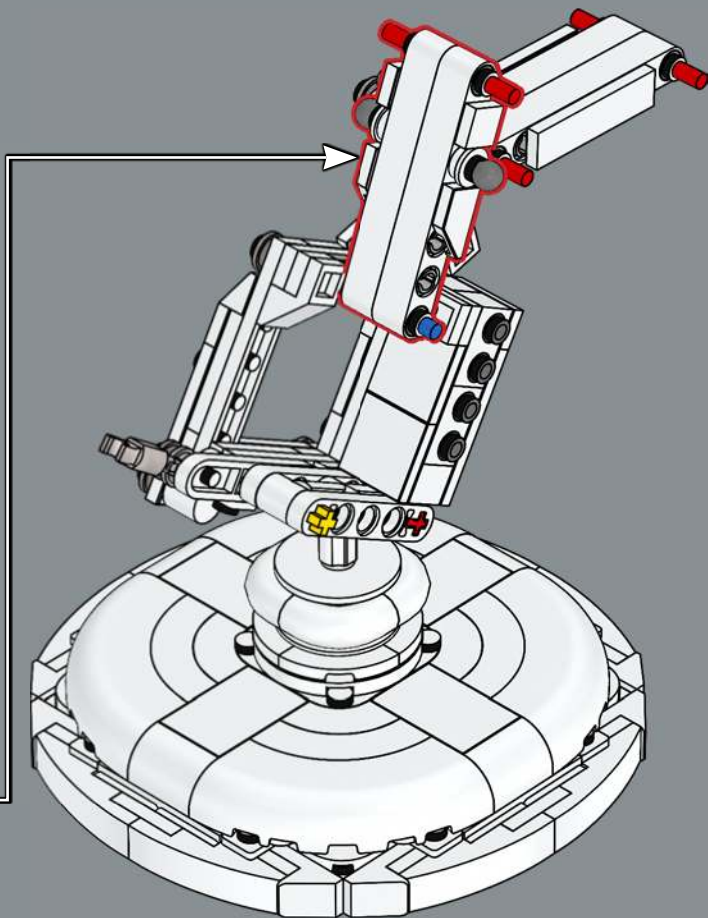

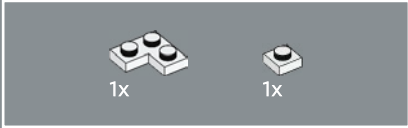
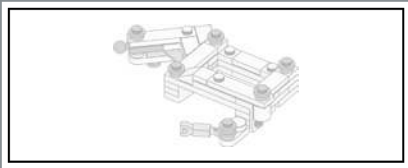

76

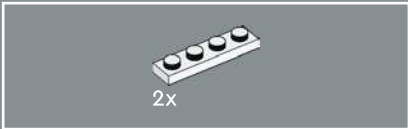
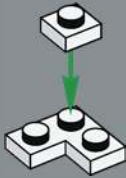

77

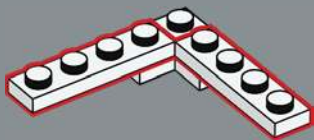

78

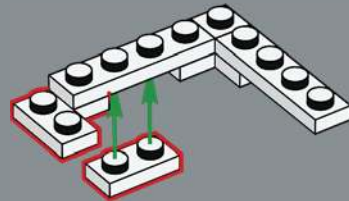



79

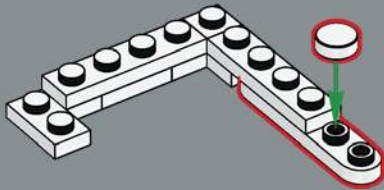

80

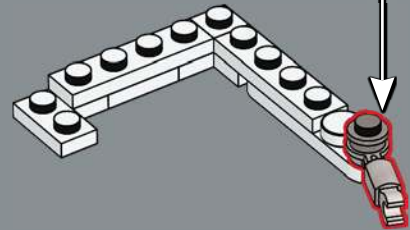
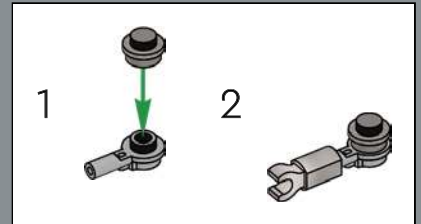

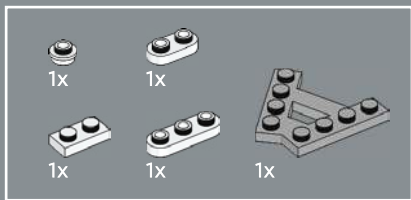

81



1

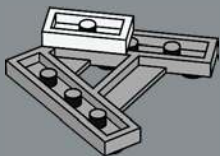

2



3

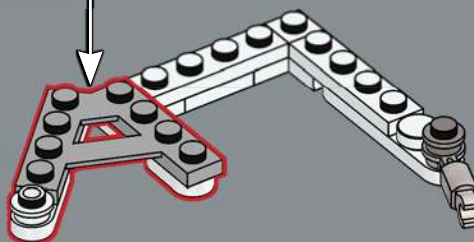
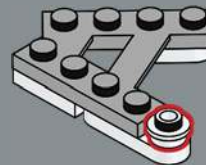

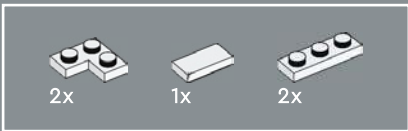

82

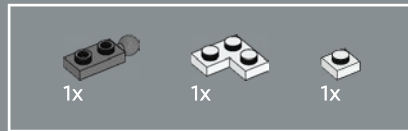
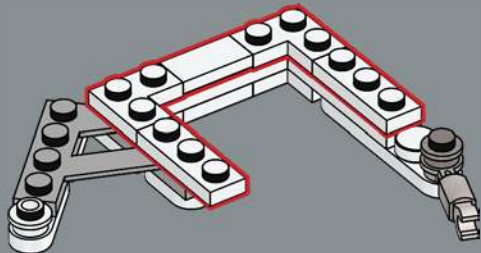

84

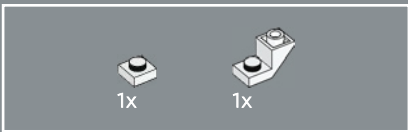
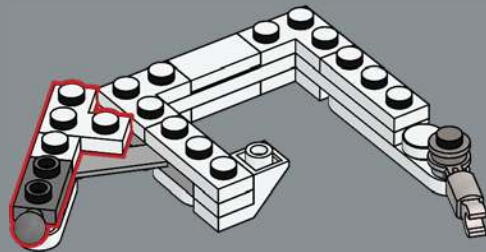

83

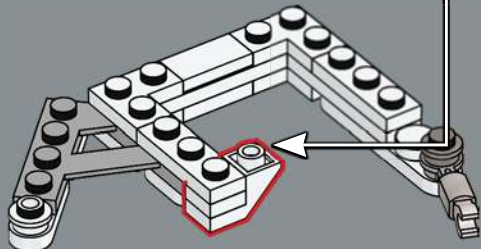
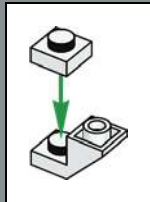

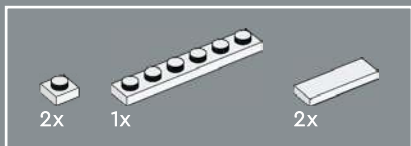

85

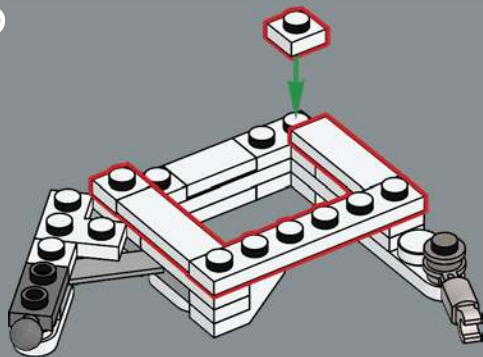

86

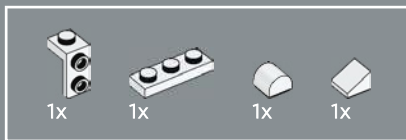
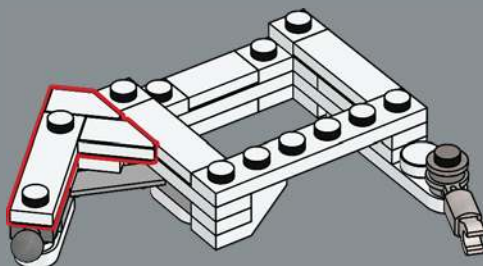

87

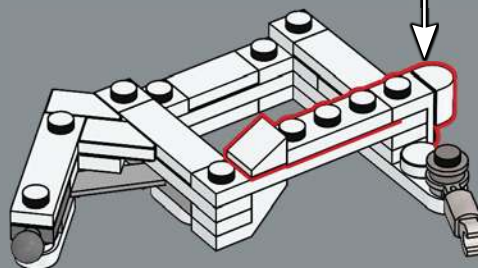
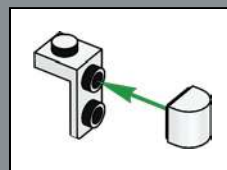



88

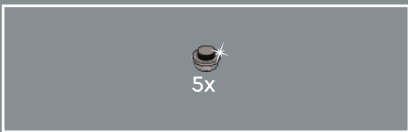
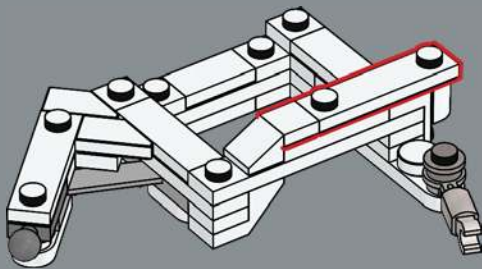

89

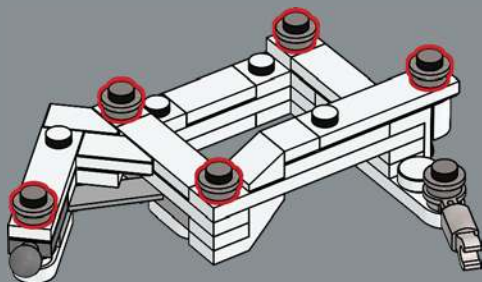

90

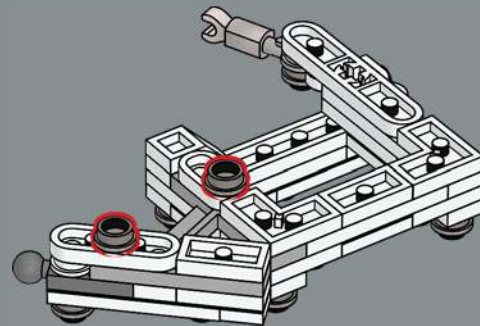

91

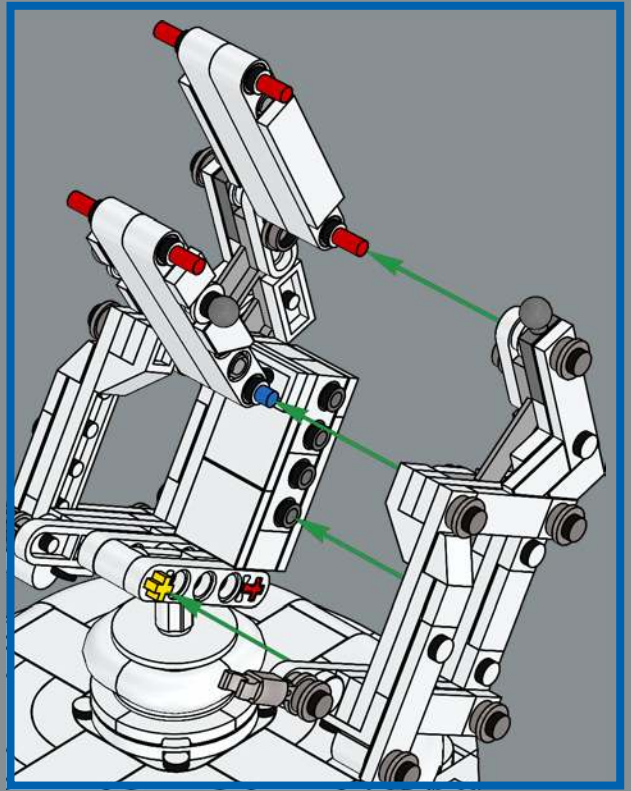
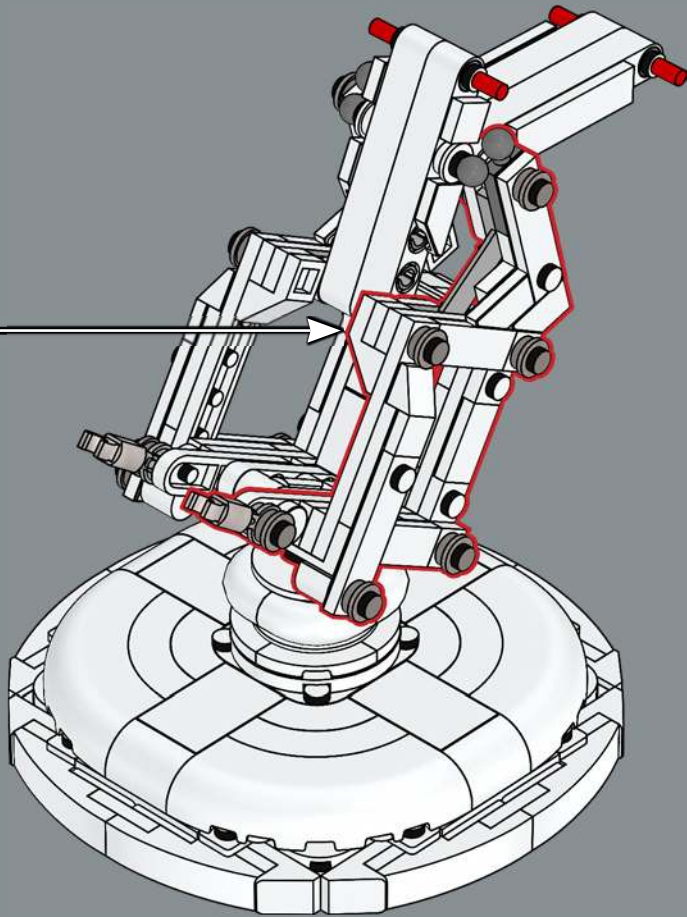

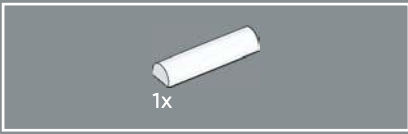

92

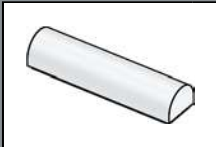
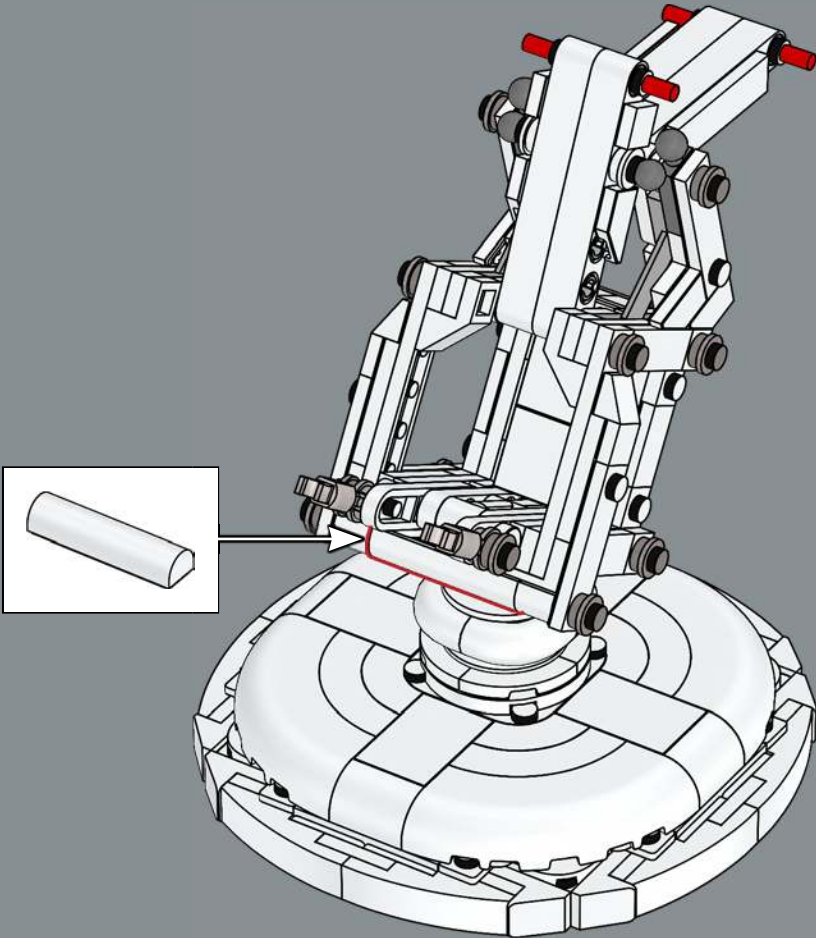

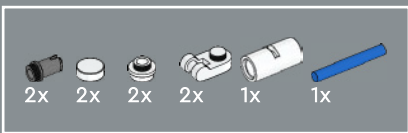

93

1

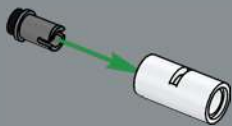

2

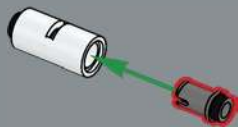

3

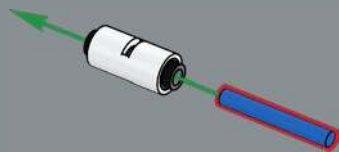

4



5

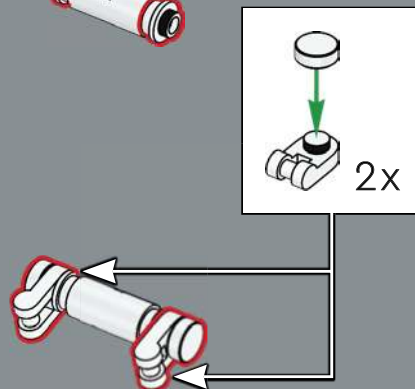

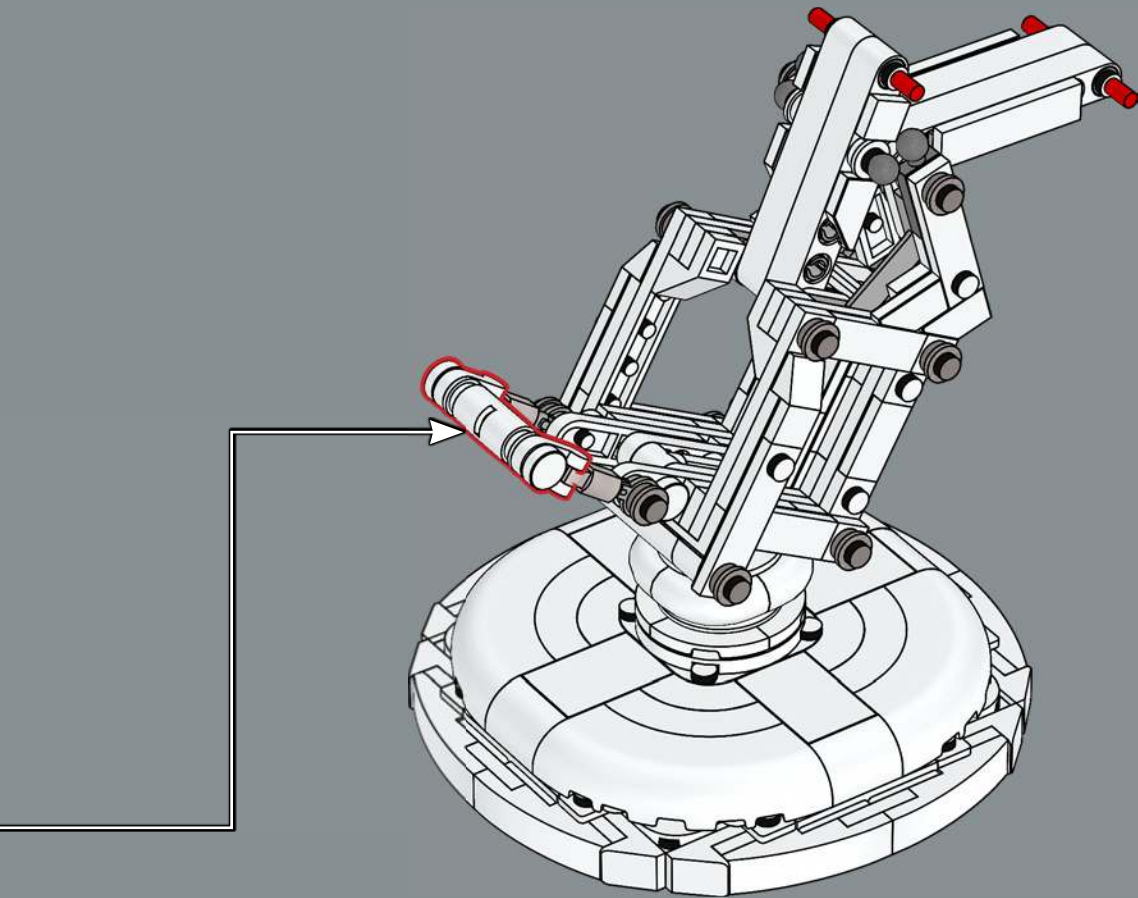

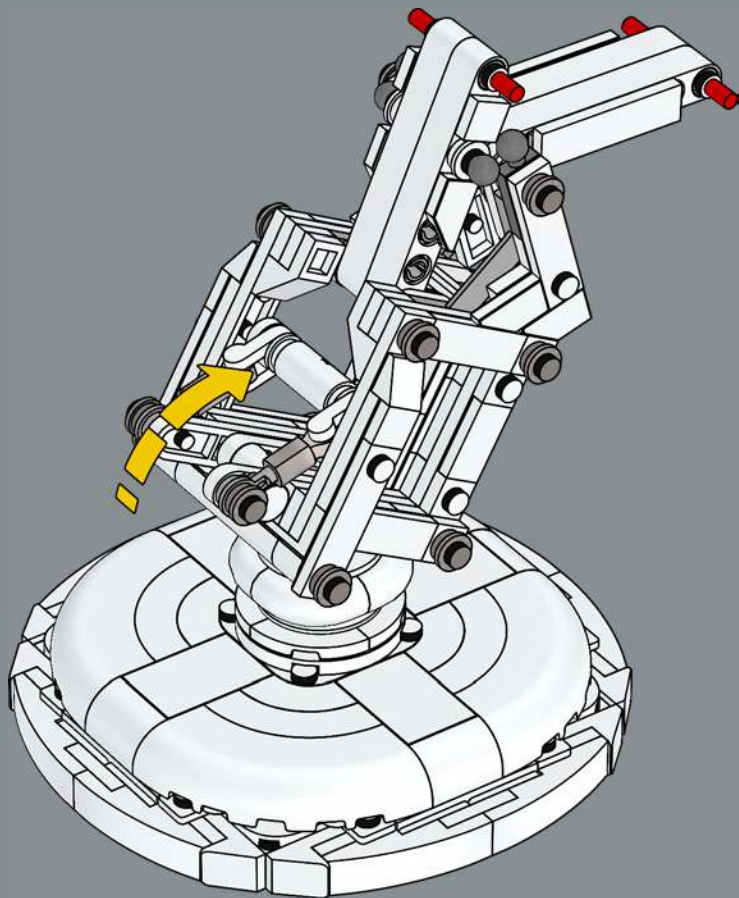

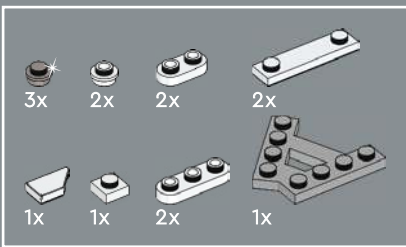

95

1

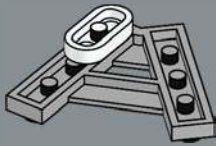

2



3



4

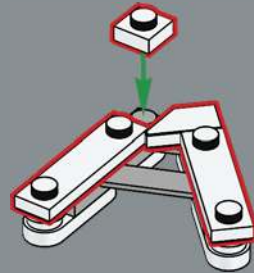

5

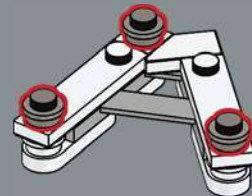

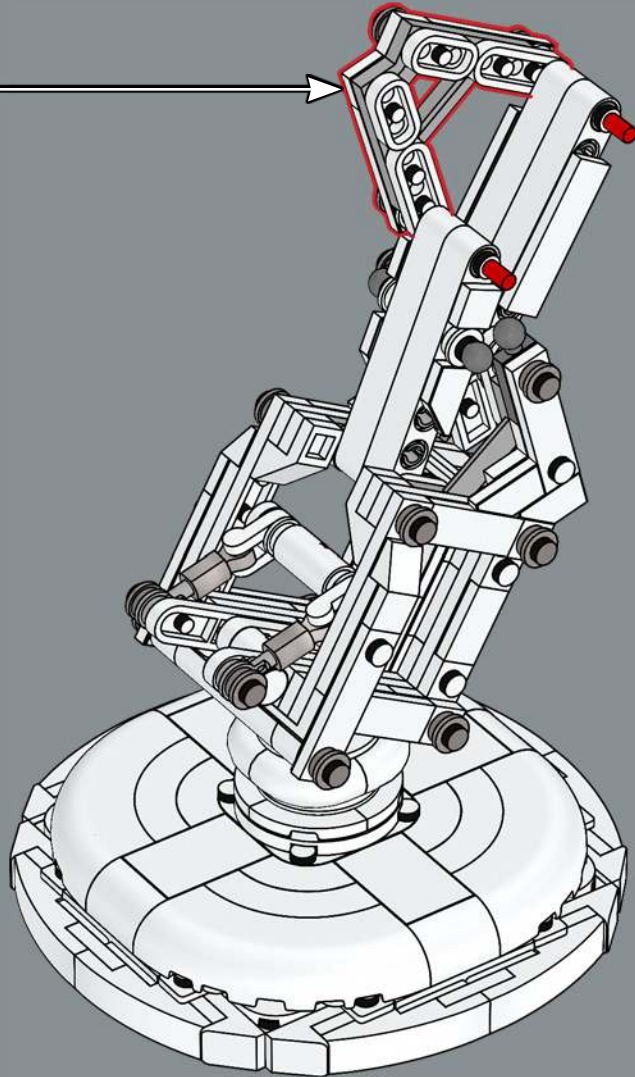

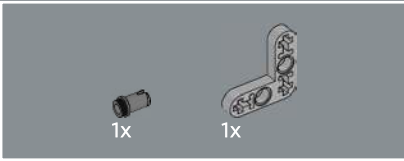
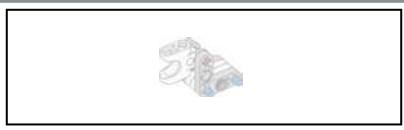

96

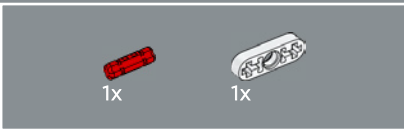
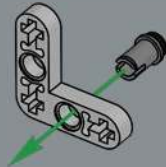

97



98

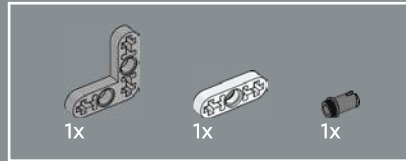
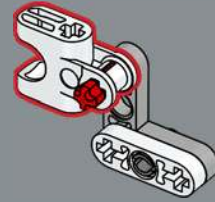

99

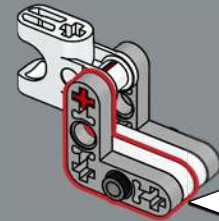
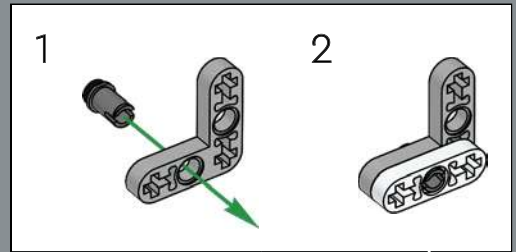

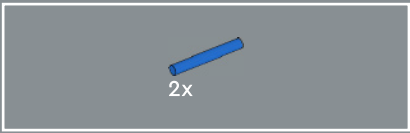

100

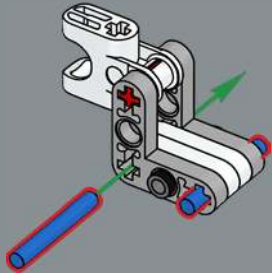

101

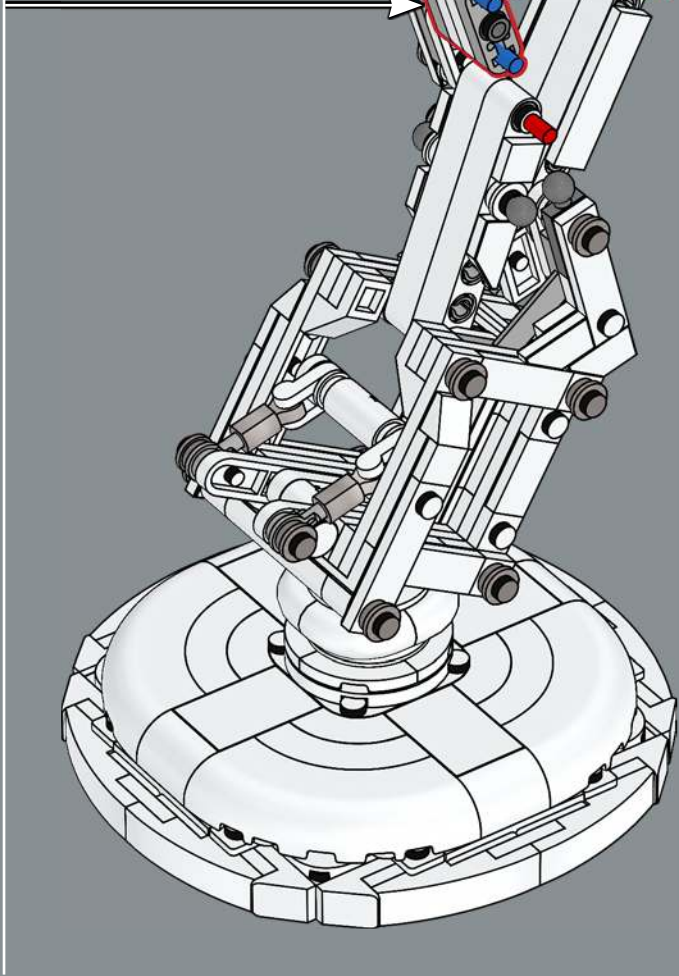

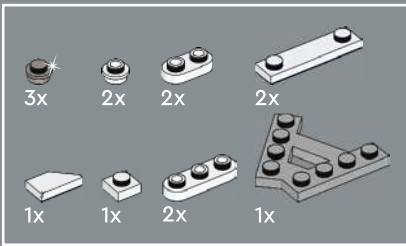

102

1

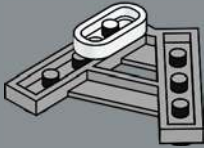

2



3

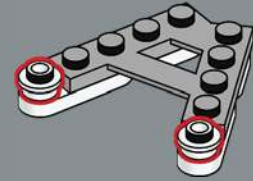

4

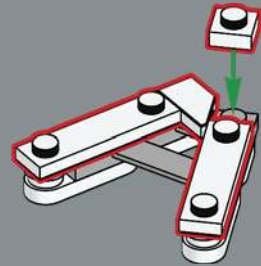

5

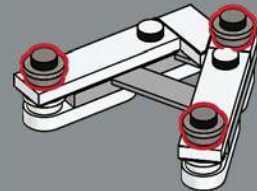

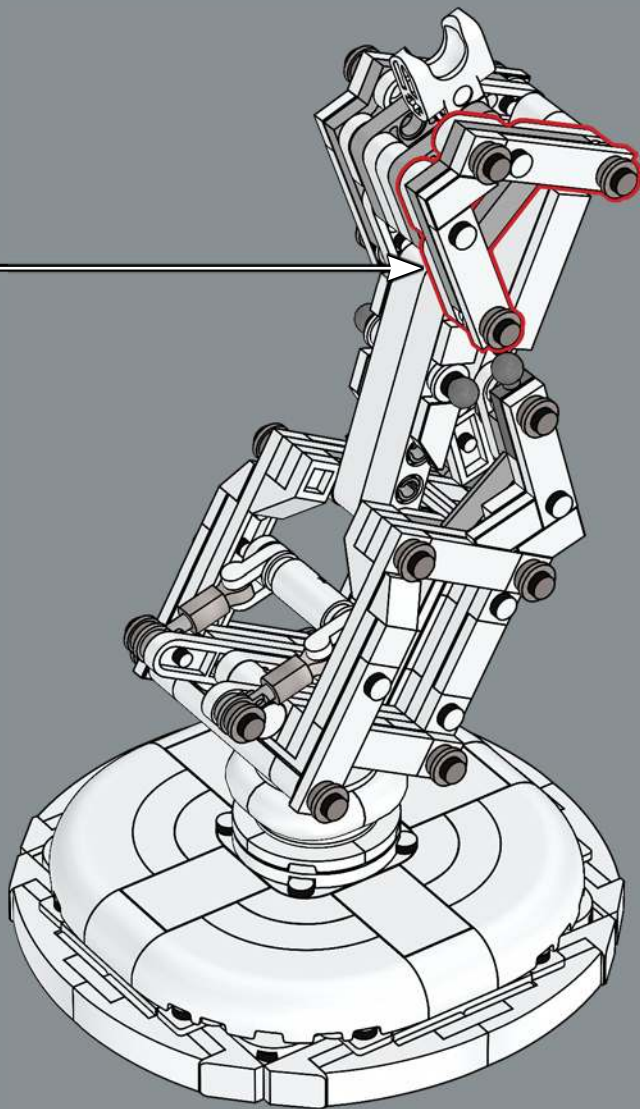

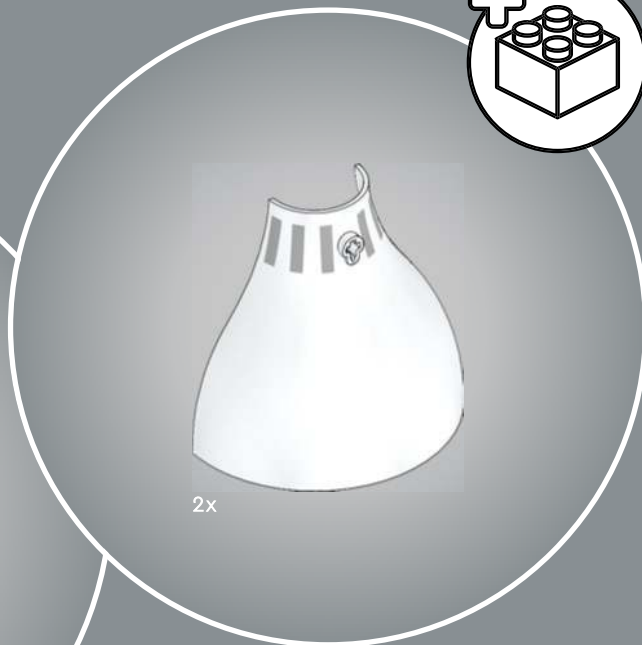
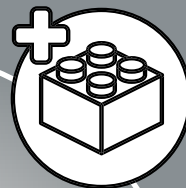

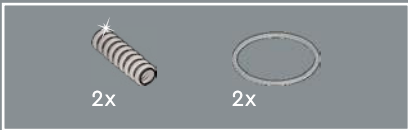

103

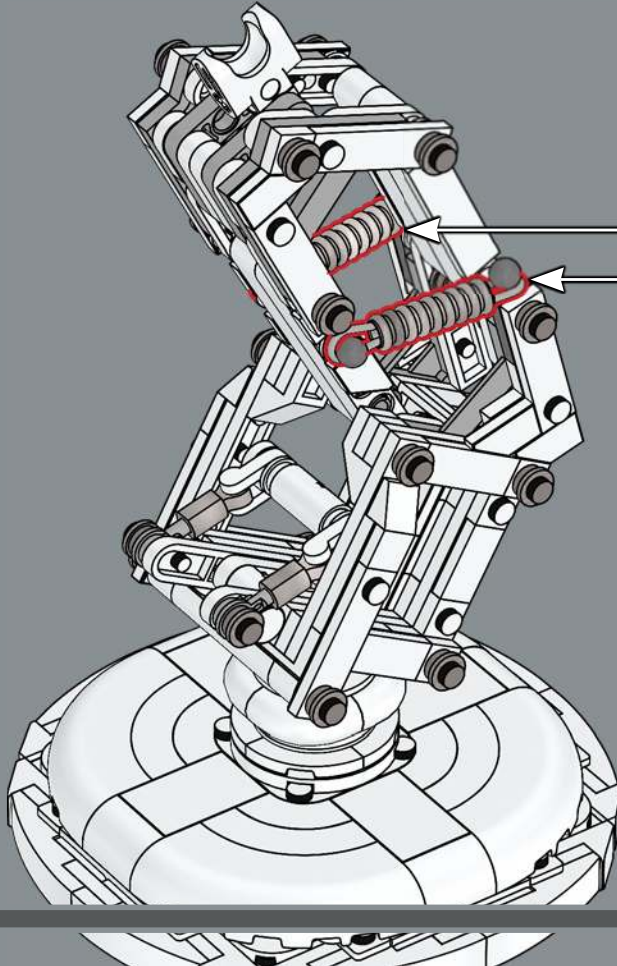
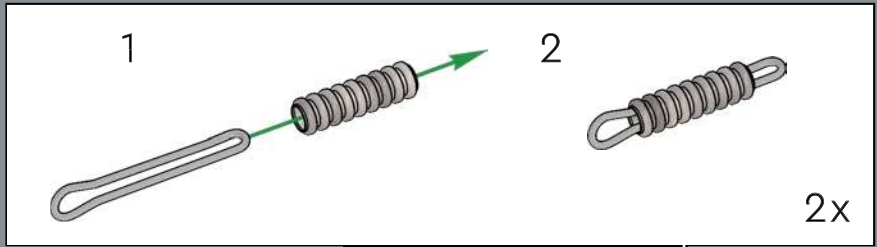



104

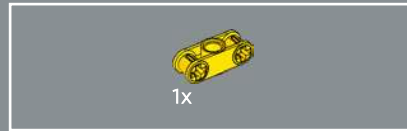
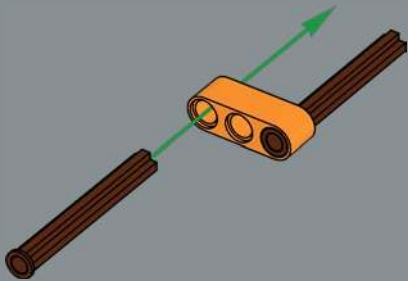

105



106

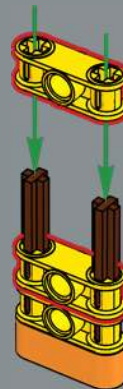



107



108

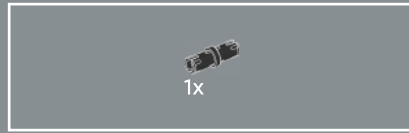

109



110

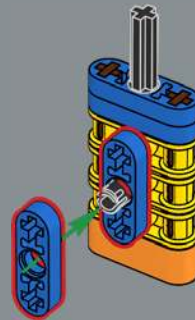

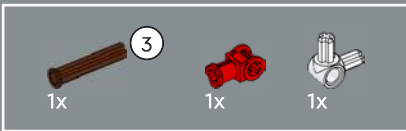

111

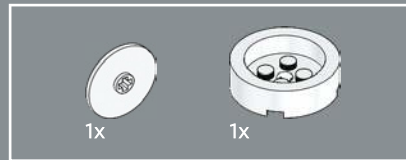
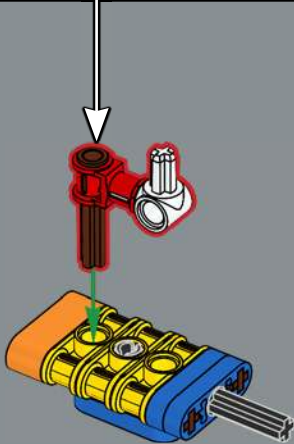
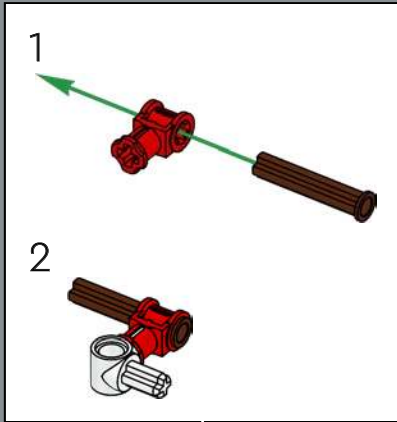

112

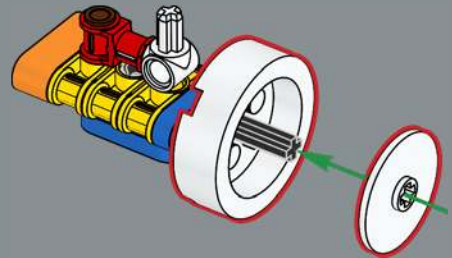

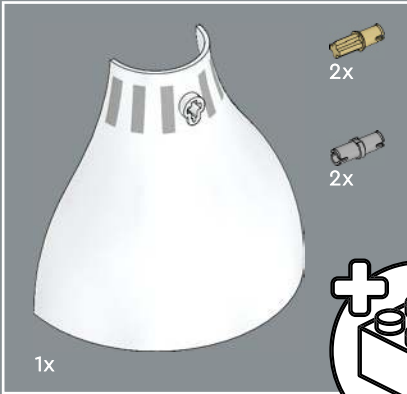

113

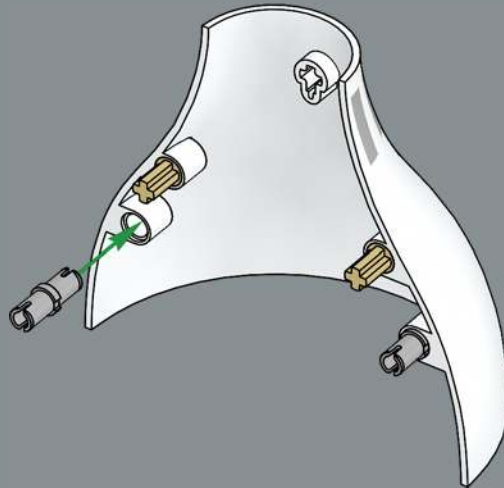

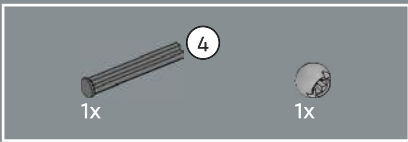

114

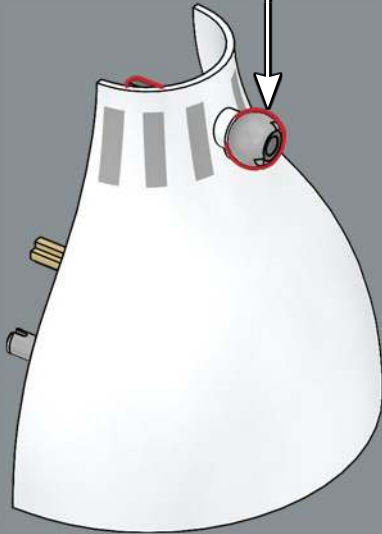
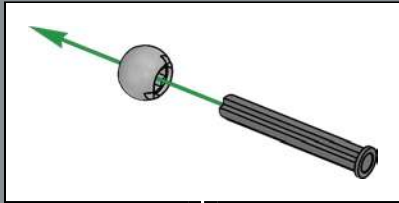

115

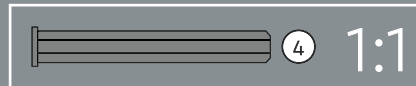
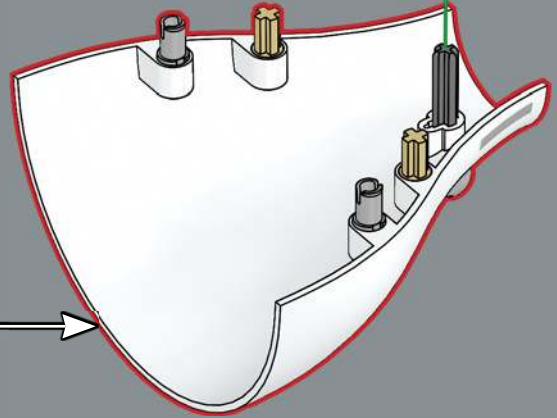
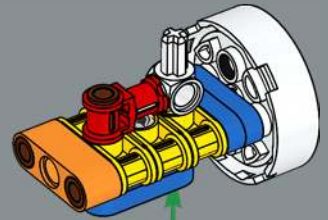

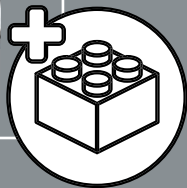
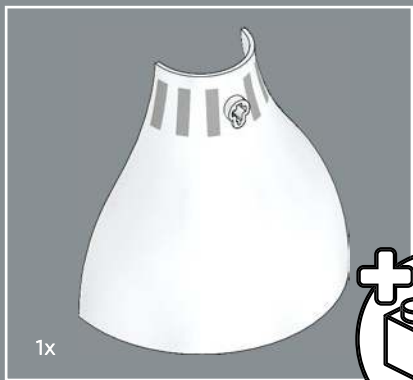

116

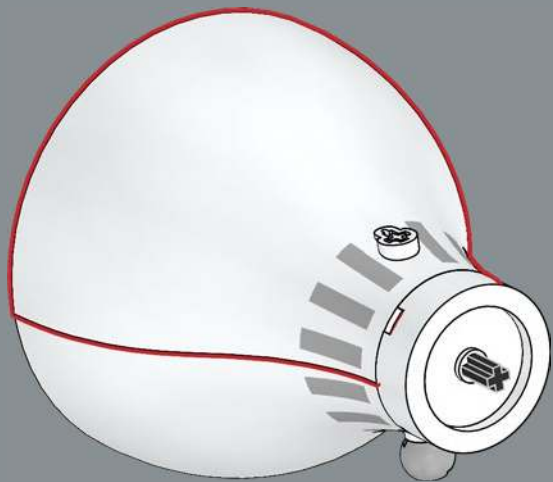

117

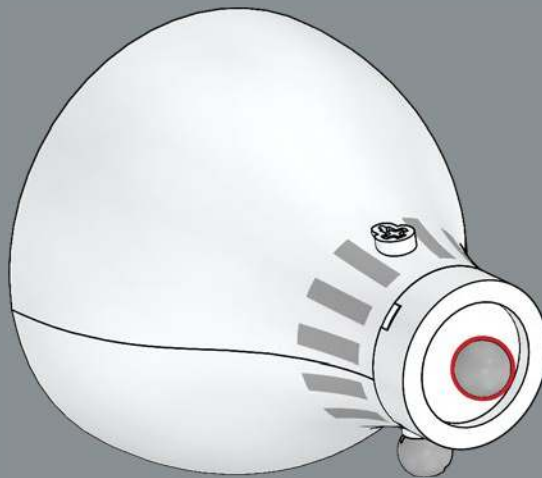

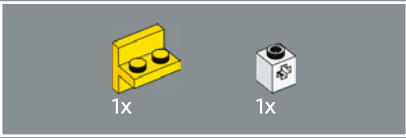
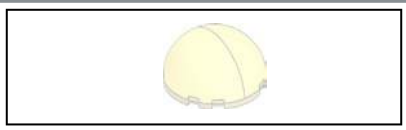

118

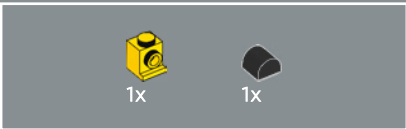
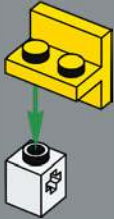

119

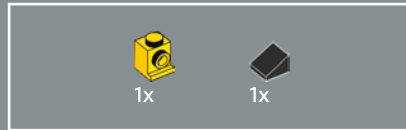
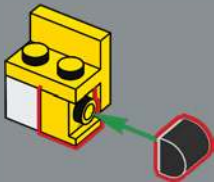

120

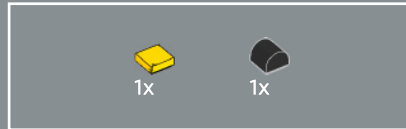

121

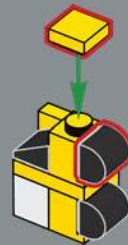



122

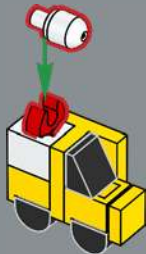

Recognise this truck inside the lampshade? The famous Pizza Planet truck first appeared in *Toy Story* (1995) and has since snuck into almost every subsequent Pixar film!

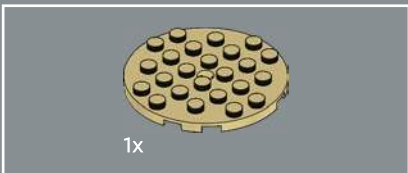

123

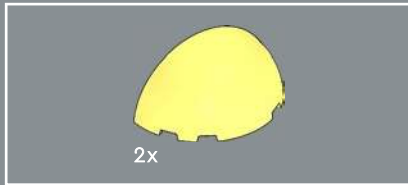

124

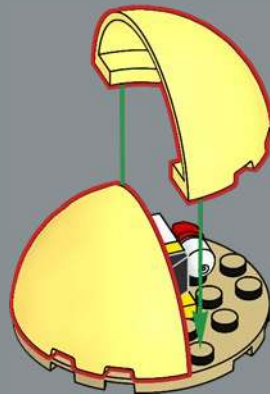

125

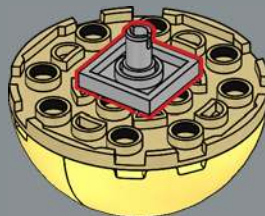

126

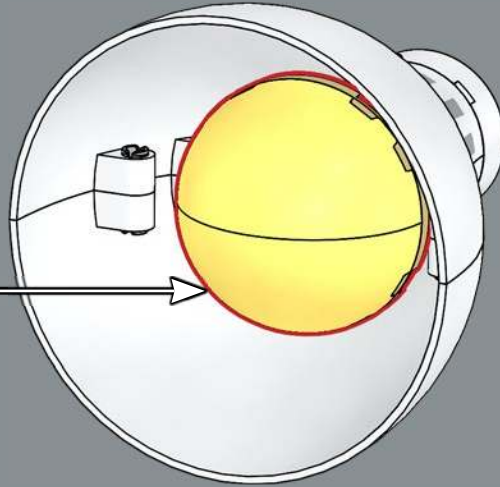

127

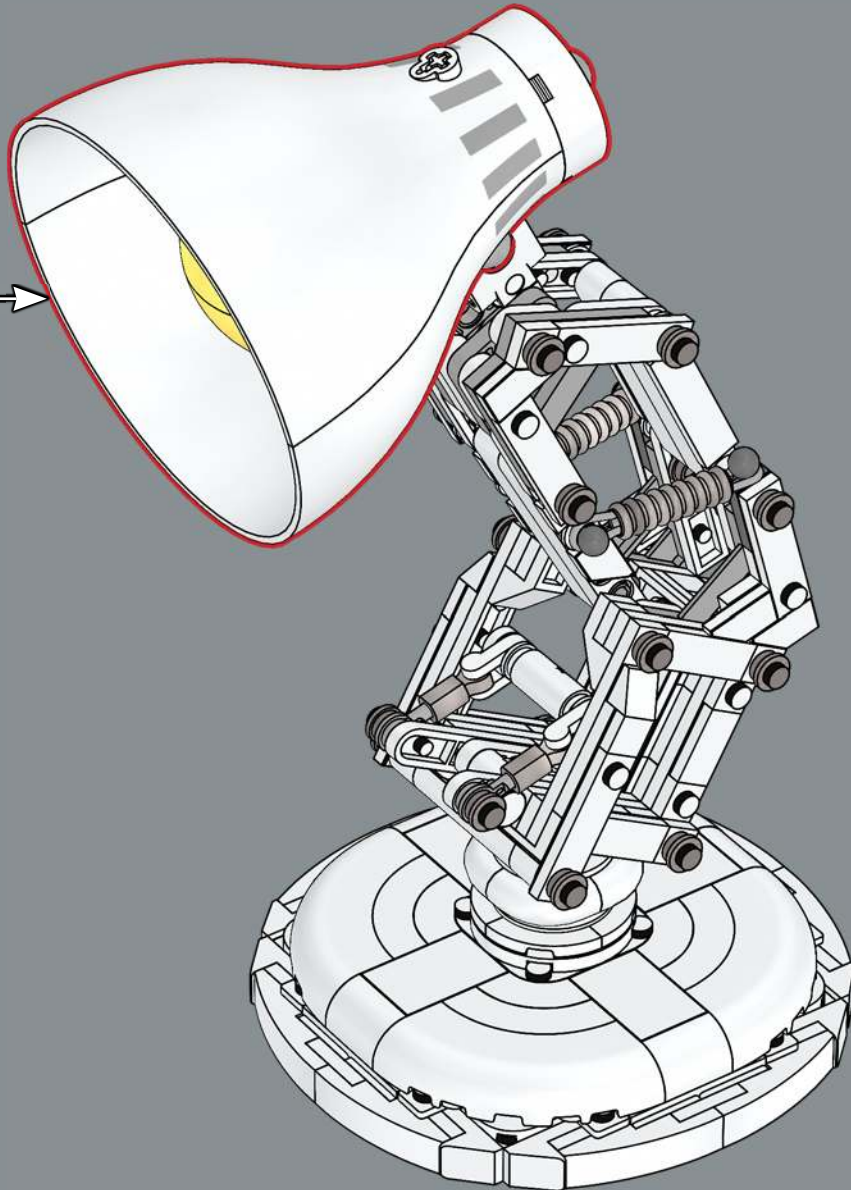

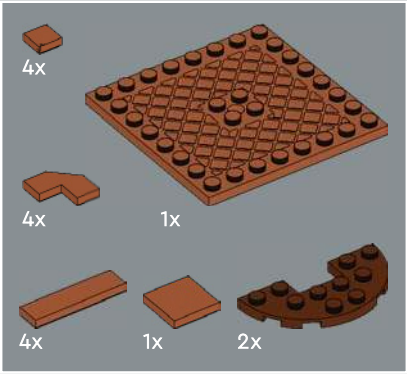
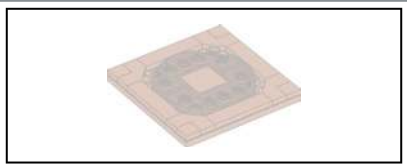

128

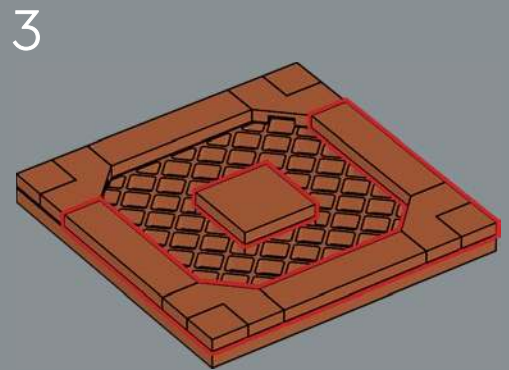
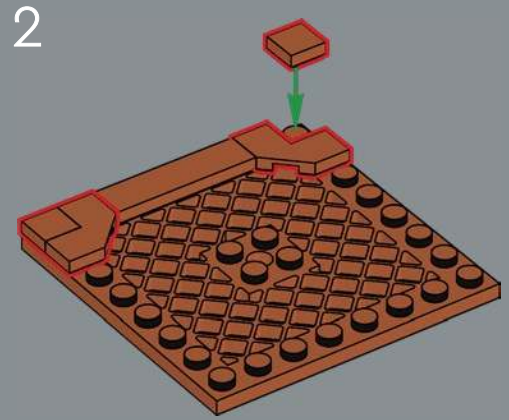
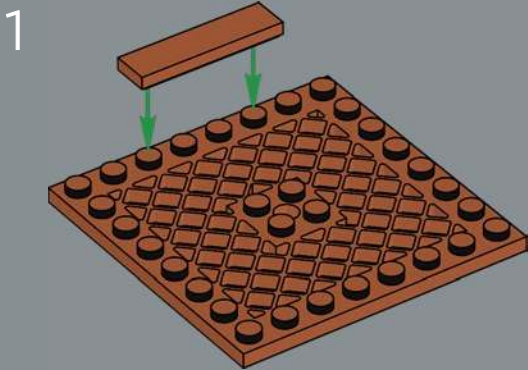

4

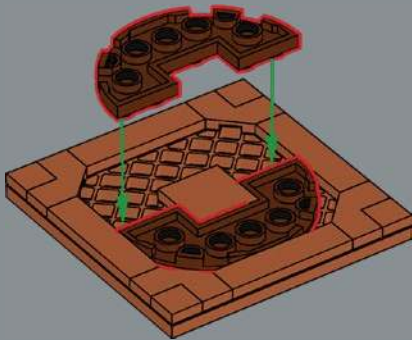

5

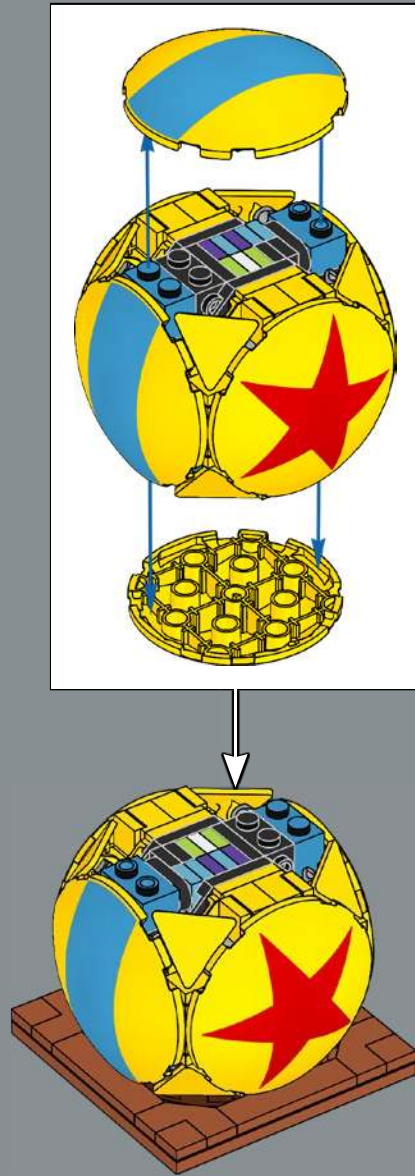

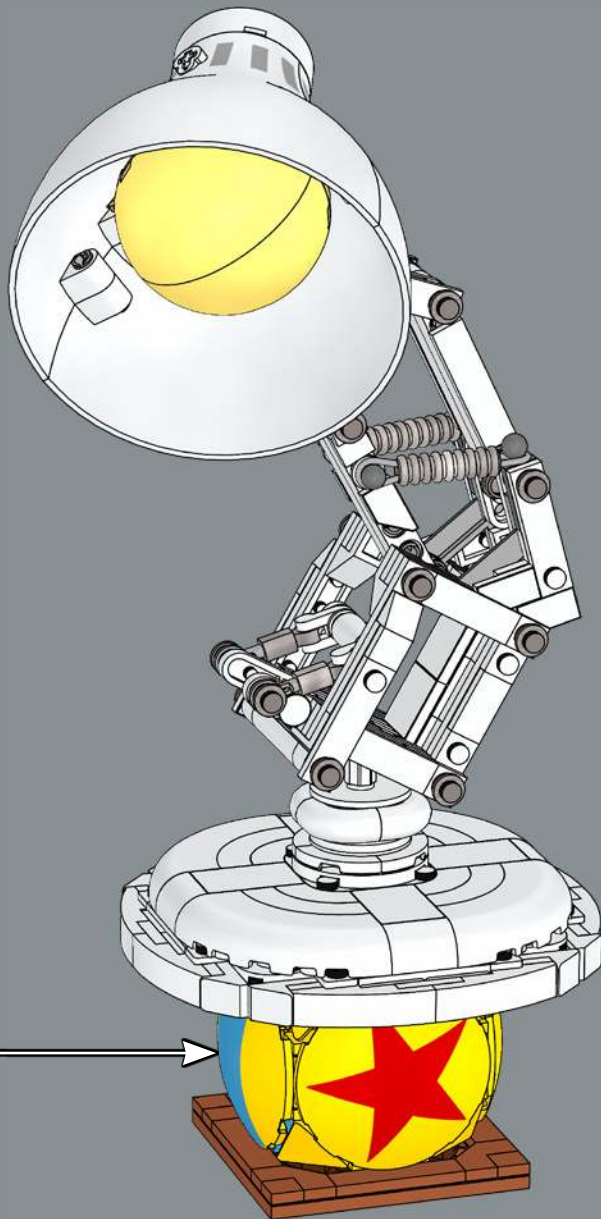



IDEAS

GATHER SUPPORT
HOL DIR UNTERSTÜTZUNG
RECUEILLES DES VOTES
CHIEDI DI ESSERE SUPPORTATO
CONSIGUE APOYOS
OBTÉM APOIO
爭取支持
ZDOBĄDŹ GŁOSY
ZÍSKEJTE PODPORU

ZÍSKAJTE PODPORU
SZEREZZ TÁMOGATÁST!
ЗБЕРІТЬ ПІДТРИМКУ
CERE SPRIJIN
ПОЛУЧЕТЕ ПОДКРЕПА
IEGŪSTI ATBALSTU
KOGU TOETUST
RINK PALAIKYMĄ

SHARE YOUR IDEA
TEILE DEINE IDEE
PARTAGEZ VOTRE IDÉE
CONDIVIDI LA TUA IDEA
COMPARTE TU IDEA
PARTILHA A TUA IDEIA
分享创意
PODZIEL SIĘ POMYSŁEM
SDÍLEJTE SVÉ NÁPADY

ZDIELAJTE SVOJE NÁPADY
OSZD MEG AZ ÖTLETED!
ПОДІЛІТЬСЯ СВОЄЮ ІДЕЄЮ
ÎMPĂRȚĂȘEȘTE IDEEA TA
СПОДЕЛІТЕ ІДЕИТЕ СИ
PARĀDI SAVU IDEJU
JAGA OMA IDEED
PASIDALINK SAVO IDĖJA

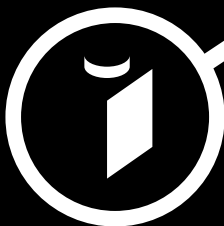

LEGO® REVIEW
LEGO® PRÜFUNG
EXAMEN PAR LEGO®
REVIEW LEGO®
REVISIÓN DE LEGO®
AVALIAÇÃO LEGO®
乐高®审核
OCENA LEGO®
POSOUZENÍ DESIGNÉRY LEGO®

POSÚDENÉ DIZAJNÉRMÍ LEGO®
LEGO® VÉLEMÉNYEZÉS
ОГЛЯД LEGO®
VERIFICARE LEGO®
ПРЕГЛЕД НА LEGO®
LEGO® RECENZIJJA
LEGO® ARVUSTUS
LEGO® APŽVALGA

NEW LEGO® PRODUCT
NEUES LEGO® PRODUKT
NOUVEAU PRODUIT LEGO®
NUOVO PRODOTTO LEGO®
NUEVO PRODUCTO LEGO®
NOVO PRODUTO LEGO®
全新乐高®产品
NOWY PRODUKT LEGO®
NOVÁ STAVEBNICE LEGO®

NOVÁ STAVEBNICA LEGO®
ÚJ LEGO® TERMÉK
НОВИЙ ПРОДУКТ LEGO®
PRODUS LEGO® NOU
НОВ ПРОДУКТ LEGO®
JAUNS LEGO® PRODUKTS
UUS LEGO® TOODE
NAUJAS LEGO® PRODUKTAS

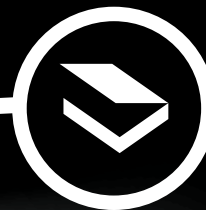

ideas.LEGO.com



8x
6351413



2x
4666579



1x
6093862



8x
6223427



1x
6439048



1x
6258973



7x
4142865



1x
6344178



3x
6296954



1x
302121

96



1x
300121



1x
4243814



2x
6284575



1x
614123



1x
302323



4x
6344176



4x
6345634



1x
300323



2x
302124



18x
407024



17x
307024



8x
6534027



2x
403224



10x
302324



1x
300424



1x
6253273



8x
6329868



1x
6130007



3x
6276974



2x
6560646

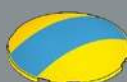

4x
6560647

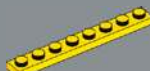

2x
346024

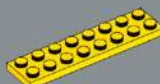

2x
303424



6x
6284070



1x
6168646



3x
300426



4x
6308883



4x
302226



1x
6089119



4x
241926



6x
302426



1x
4504382



2x
6273589



8x
6508269



4x
6210270



6x
403226



1x
6279875



2x
6058221



4x
6523387



2x
6144149

3

1x
6102986

1x
6322819

1x
6097493

2x
6097419

3x
6209692

3x
4164037

4x
4537936

4x
6143431

1x
4570877

4x
6253425

1x
6186423

4x
6074893

1x
6561357

1x
6248970

2x
6257079

1x
4528604

1x
6514059

1x
6385485

2x
6339866

1x
6420614

1x
6322820

22x
6051507

2x
6475523

3x
4655695

1x
6315196

5x
6369188

1x
300328

1x
302128

1x
6462425

1x
6284582

2x
4121739

1x
6102618

1x
6240515

4x
4221744

1x
6135494

3x
6159763

2x
6430291

2x
6551714

1x
6070731

2x
6227897

6x
4211807

8x
6252203

8x
6066097

1x
4211398

2x
6271815

2x
4211397

1x
6276848

2x
6564266

4x
6442144

24x
6395635

2x
6364352

3x
6055313

2x
6123814

1x
6083620

8x
6362254

1x
6540465

1x
6319958

4x
6058014

2x
6551573

3

5

4



1x
6548271



1x
6564917



4x
6550172



4x
6564912



2x
6527804



[LEGO.com/service](https://www.LEGO.com/service)

5x
6564903

8x
6552190

14x
6548262

2x
6550179

4x
6550138

8x
6548290

6x
6550175

2x
6564914

1x
6550164

2x
6548265

2x
6550131

8x
6550153

8x
6548278

21x
6548261

4x
6552172

2x
6550177

1x
6548257

1x
6548286

4x
6564911

3x
6548264

2x
6550131

8x
6550153

8x
6548278

2x
6564906

6x
6550184

1x
6564907

8x
6550162

4x
6564910

2x
6564913

10x
6548254

4x
6548270

6x
6550144

1x
6560445

4x
6564908

8x
6548266

4x
6548294

4x
6550161

8x
6564905

1x
6564915

2x
6548255

4x
6564909

1x
6564904

1x
6564916

1x
6448949

13x
6168642

1x
6345886

2x
6442358

4x
6510140

2x
6507770

4x
6194851

1x
6179606

4x
6510126

2x
6360038

1x
6559579

8x
6249091

2x
6280386

2x
6360069



YOU COULD WIN



YOU COULD WIN

Your feedback will help shape the future development of this product series.

Visit:

DU KÖNNTEST GEWINNEN

Dein Feedback trägt zur Weiterentwicklung dieser Produktreihe bei.

Geh auf:

VOUS POURRIEZ GAGNER

Vos commentaires nous aideront à concevoir les futurs produits de cette gamme.

Visitez :

POTRESTI VINCERE TU

La tua opinione ci aiuterà a migliorare la creazione futura di questa linea di prodotti.

Visita:

PUEDES GANAR

Tu opinión contribuirá al futuro de esta serie de productos.

Visita:

轻松获奖

您的反馈将有助于我们在今后改进本产品系列。

请访问:

LEGO.com/productfeedback

You also have the chance to win a LEGO® set.

Terms and conditions apply.*

Außerdem hast du die Chance, ein LEGO® Set zu gewinnen.

Es gelten die Teilnahmebedingungen.*

Vous pourriez également gagner un ensemble LEGO®.

Des conditions s'appliquent.*

Hai anche la possibilità di vincere un set LEGO®.

Termini e condizioni sono applicabili.*

También tienes la oportunidad de ganar un set LEGO®.

Aplican términos y condiciones.*

您还有机会赢取乐高®套装。

条款和条件适用。*

*LEGO.com/productfeedback-terms



LEGO and the LEGO logo are trademarks of the LEGO Group. ©2025 The LEGO Group.

© Disney/Pixar.

Luxo is a trademark of Glamox AS.