



# Harry Potter

76445



LEGO® Builder



LEGO.com/sustainable-packaging



FR  
**DONNEZ**  
OU  
**RECYCLEZ**



OU



OU



ASSOCIATION

MAGASIN

DÉCHÈTERIE

Adresses sur [quefairedemesdechets.fr](http://quefairedemesdechets.fr)



# BUILDER



Apple and the Apple logo are trademarks of Apple Inc., registered in the U.S. and other countries and regions. App Store is a service mark of Apple Inc. Google Play and the Google Play logo are trademarks of Google LLC. Tencent and the Tencent logo are trademarks of Tencent Inc.



**EN** Ask parents' permission before going online | **DE** Eltern um Erlaubnis bitten, bevor du online gehst | **FR** Demande l'autorisation d'un parent avant d'aller en ligne | **IT** Chiedi il permesso ai tuoi genitori prima di andare online | **ES** Pídeles permiso a tus papás antes de conectarte a Internet | **PT** Peça autorização aos pais antes de acederes online | **ZH** 上网前应先征得父母的同意 | **PL** Poproś rodziców o zgodę, zanim wejdziesz do Internetu | **CS** Než půjdeš na internet, požádej rodiče o svolení | **SK** Skôr než pôjdeš na internet, vypýtaj si povolenie od rodičov | **HU** Kérj szülői engedélyt, mielőtt online csatlakoznál! | **UA** Запитуйте дозволу батьків, перш ніж користуватися інтернетом | **RO** Cere permisiunea părinților înainte de a te conecta online | **BG** Поискайте разрешение от родител, преди да влезете онлайн | **LV** Pirms došanās tiešsaistē palūdz atļauju vecākiem | **ET** Enne Interneti kasutamist küsi vanematelt luba | **LT** Prieš prisijungdami prie interneto, atsiklauskite tėvų



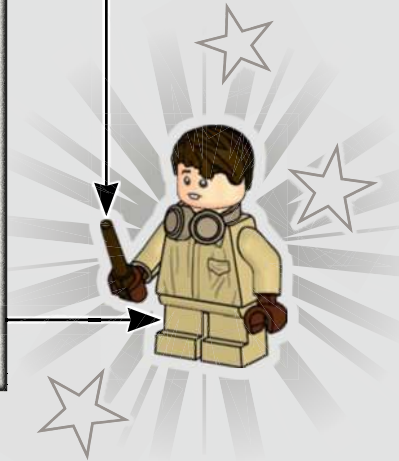
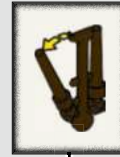
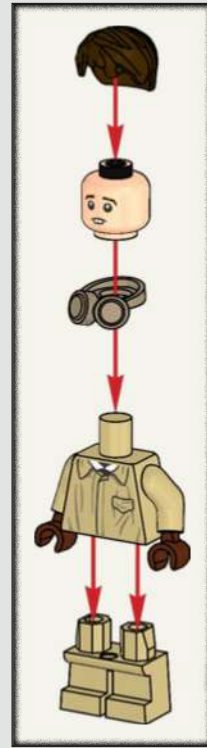
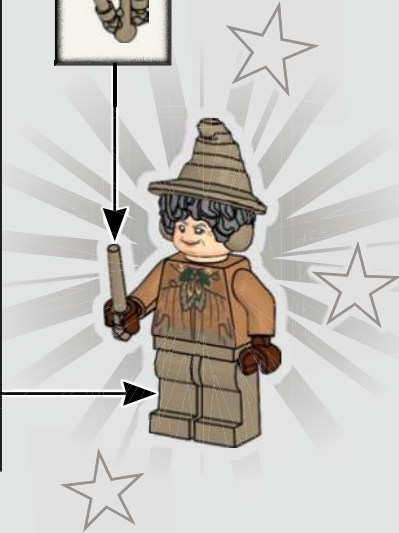
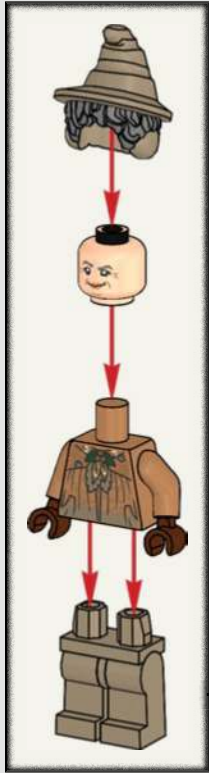

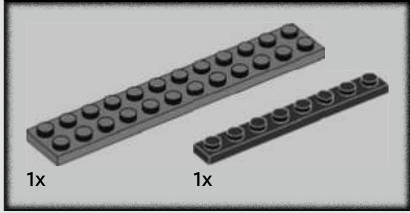
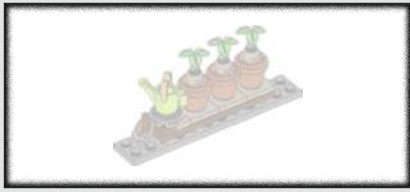

1

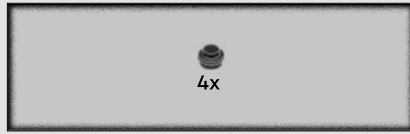
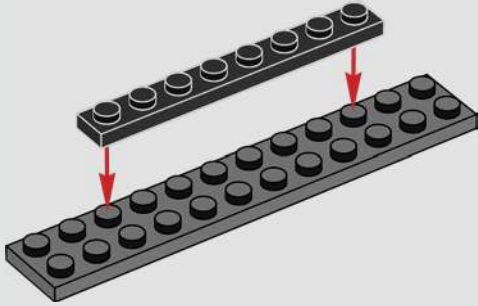

2

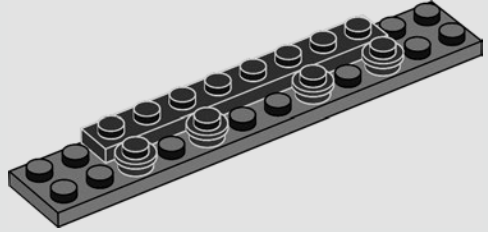

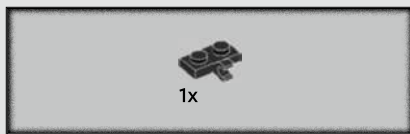

3

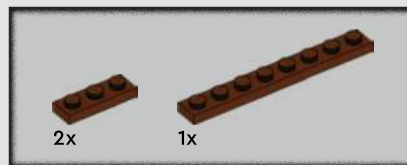
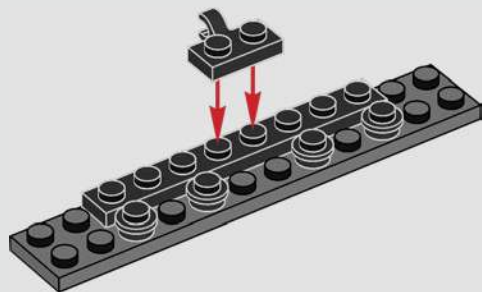

4

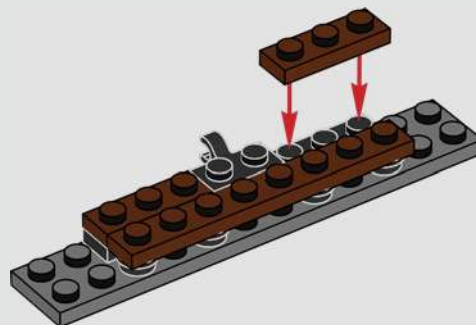

5

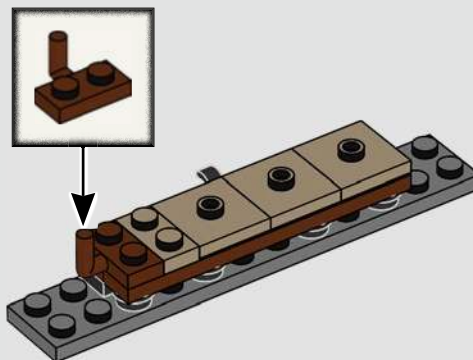



6

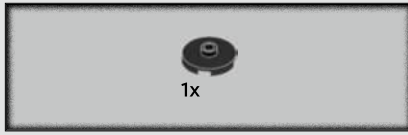
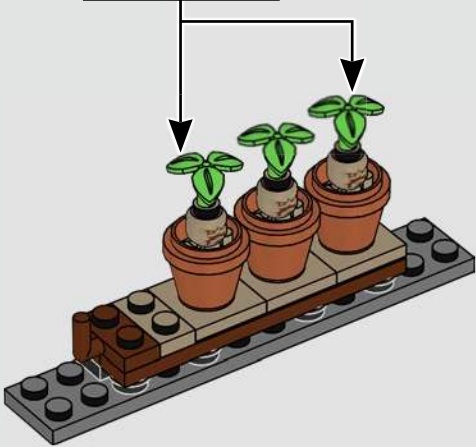
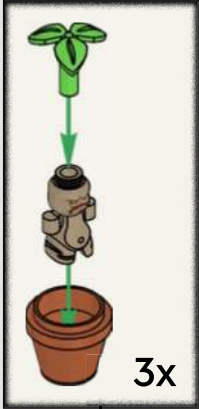

7

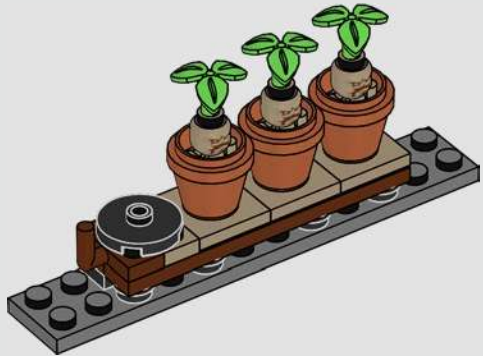



8

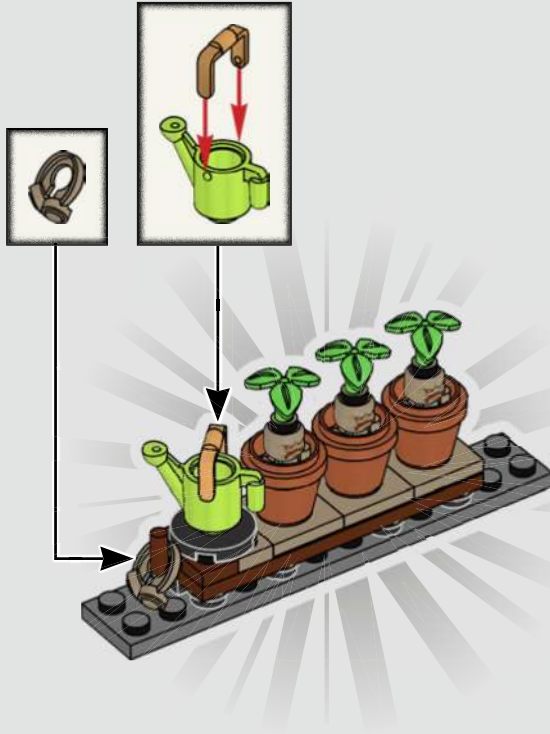

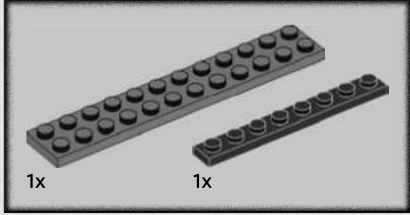
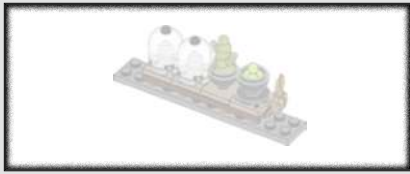

9

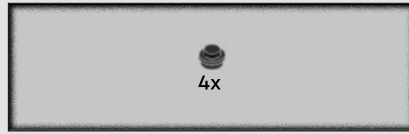
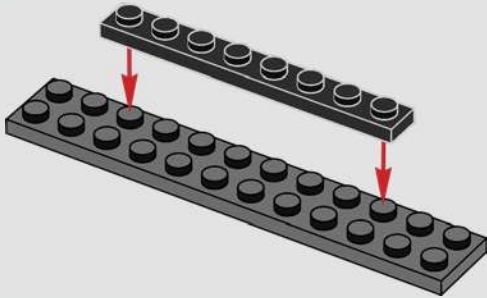

10

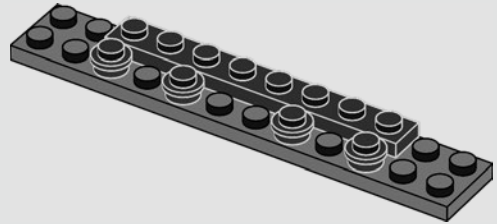

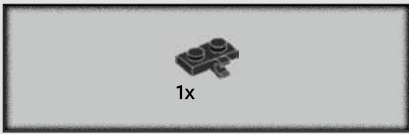

11

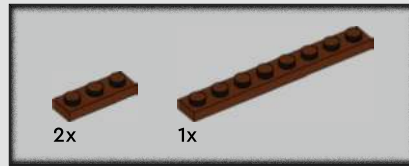
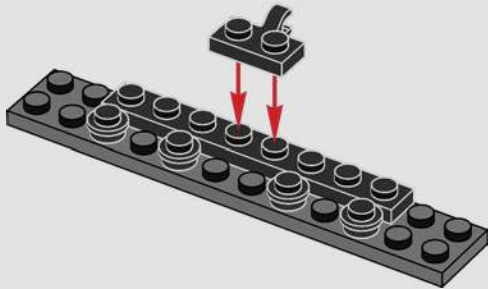

12

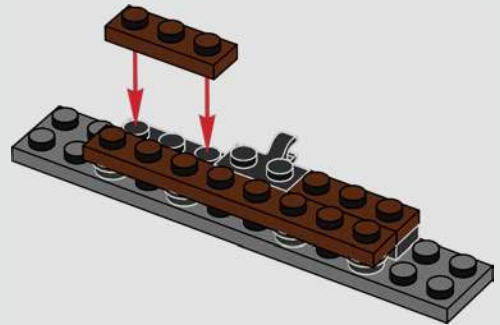

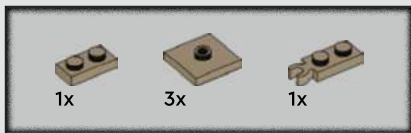

13

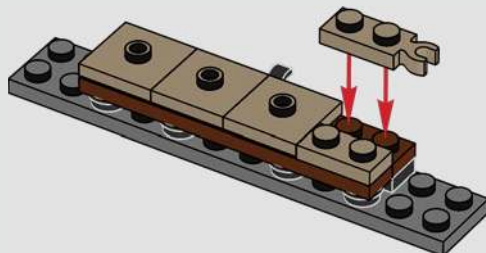

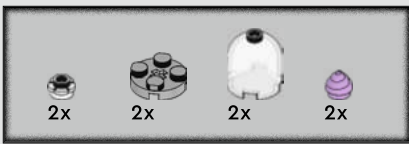

14

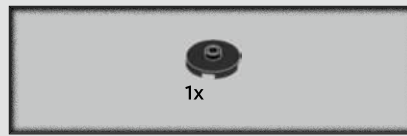
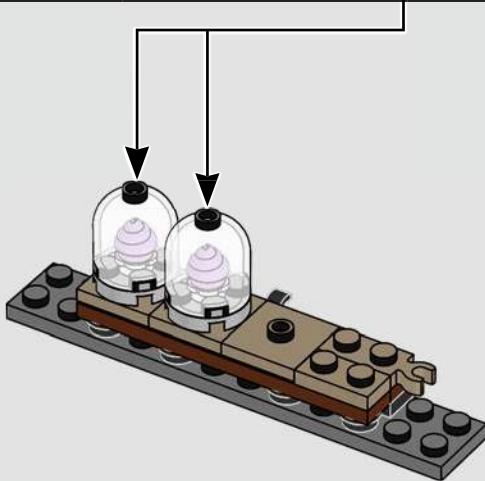
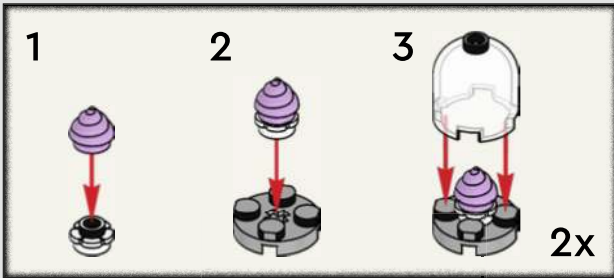

15



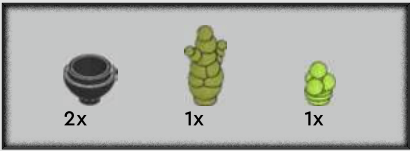

16

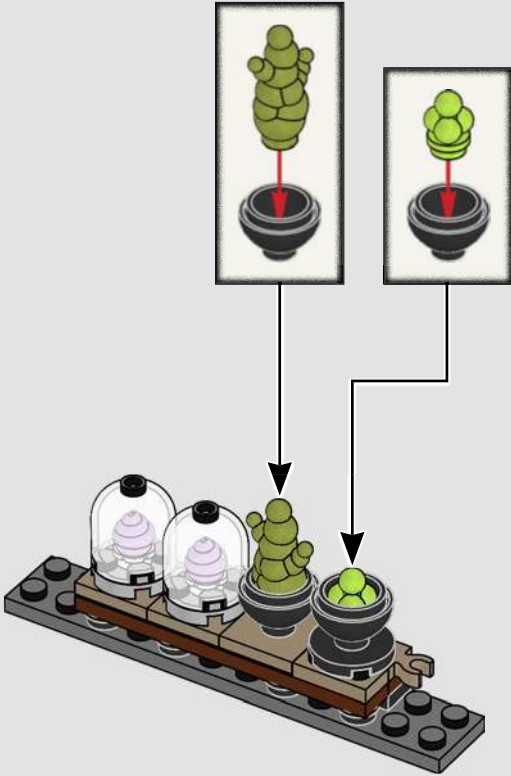

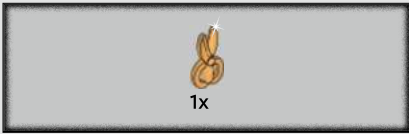

17

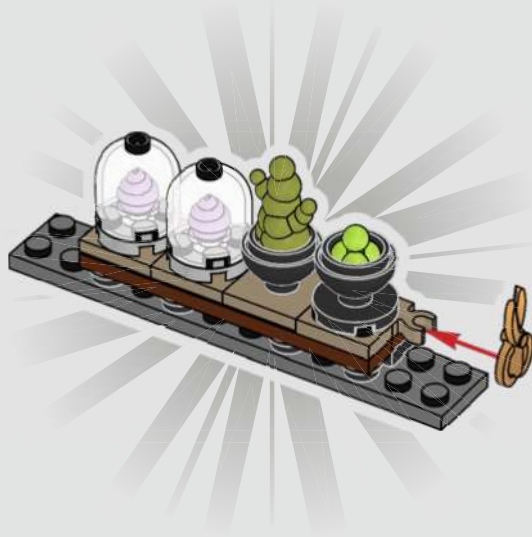



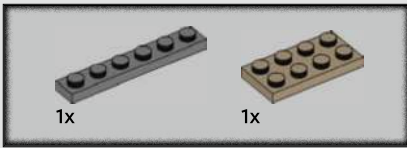

18

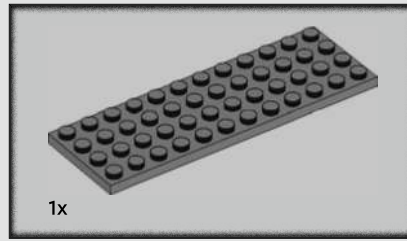
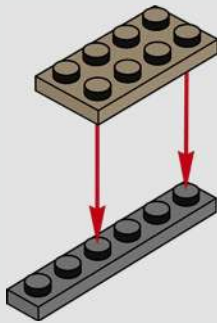

19

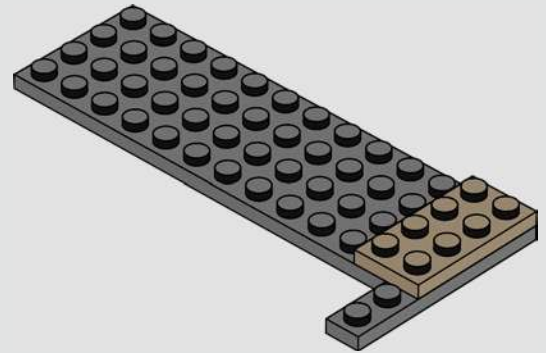

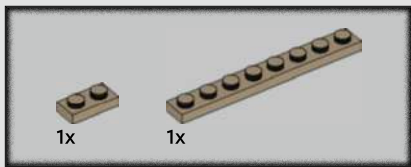

20

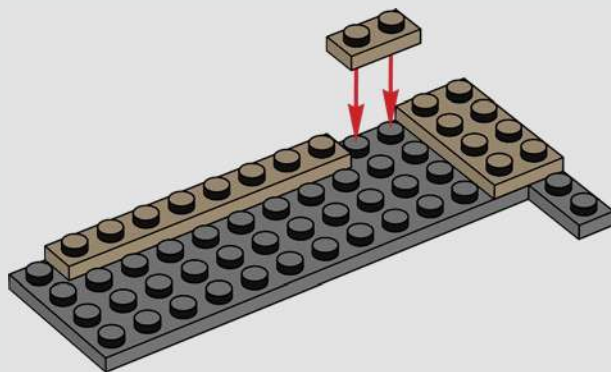

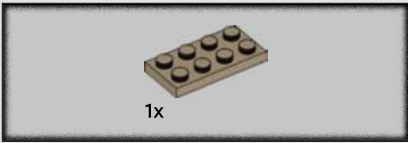

21

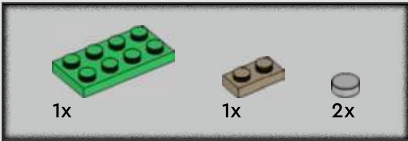
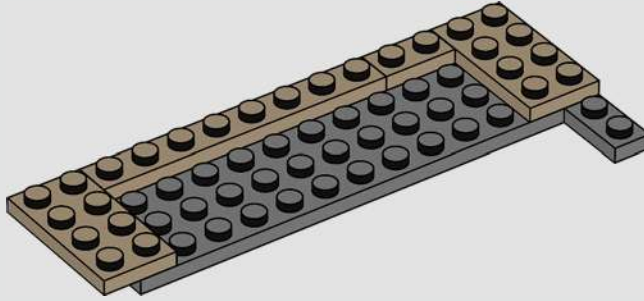

22

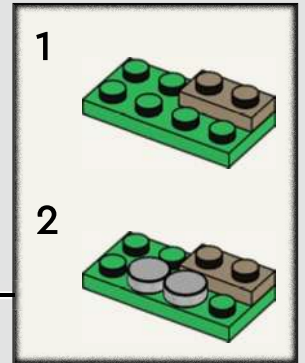
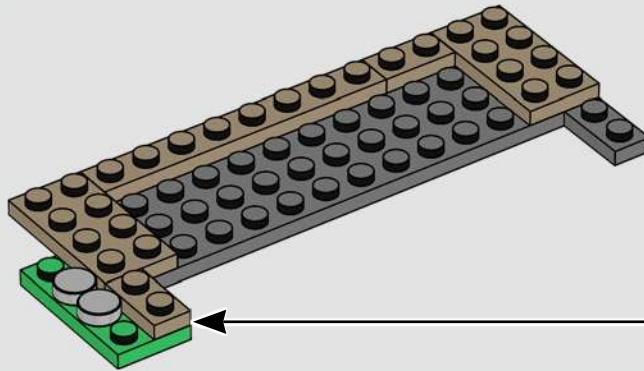

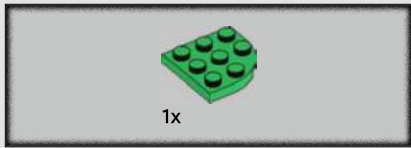

23

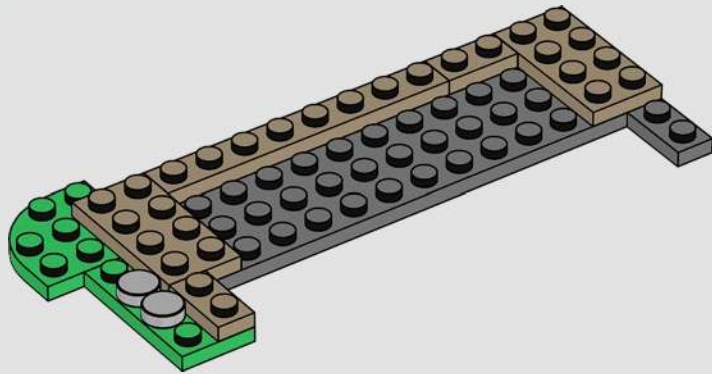



24

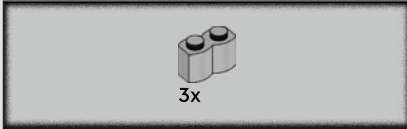
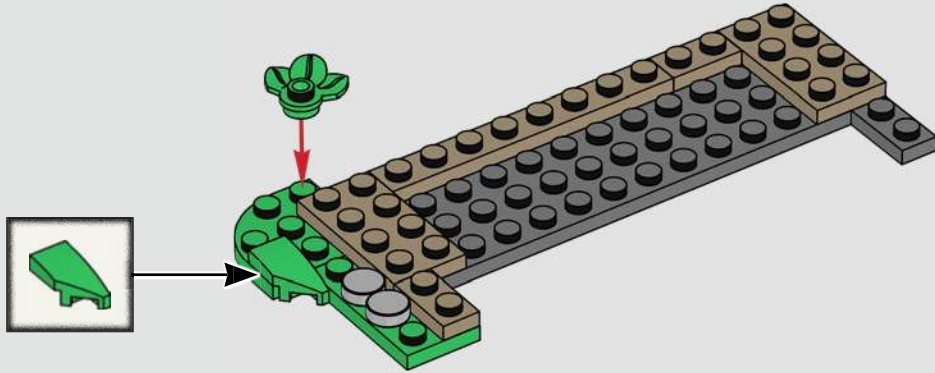

25

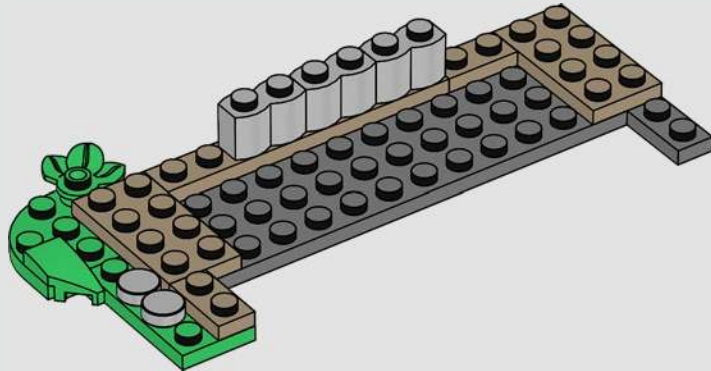

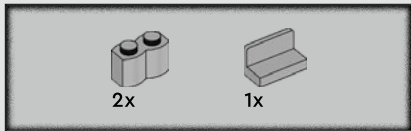

26

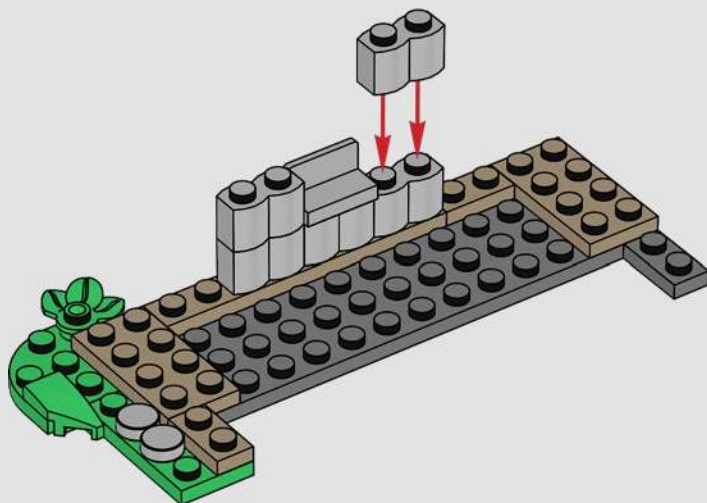



27

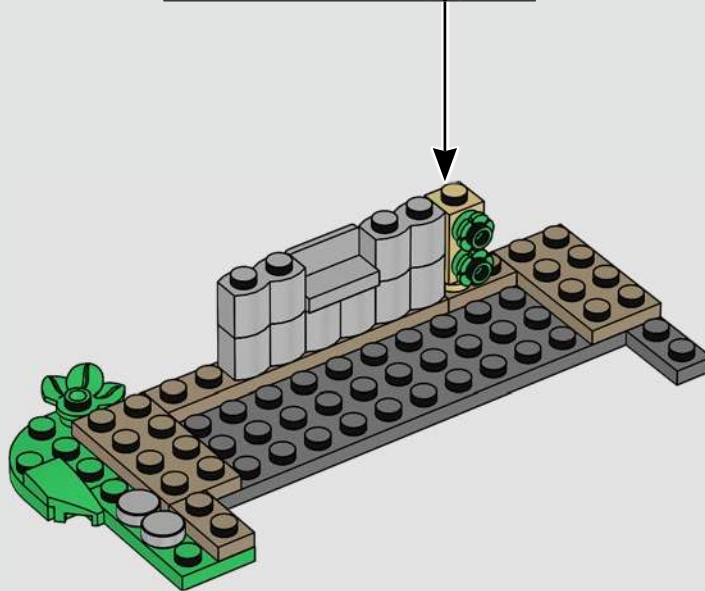
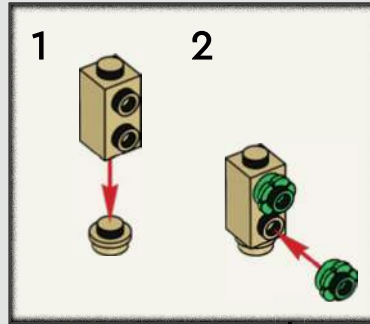

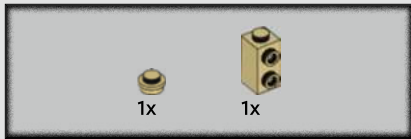

28

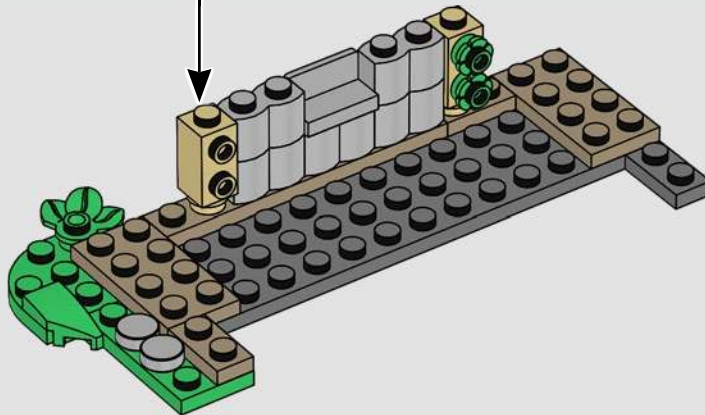
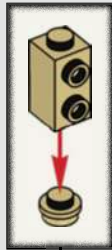



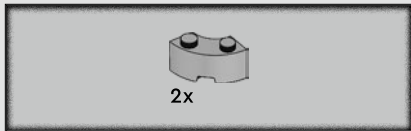

31

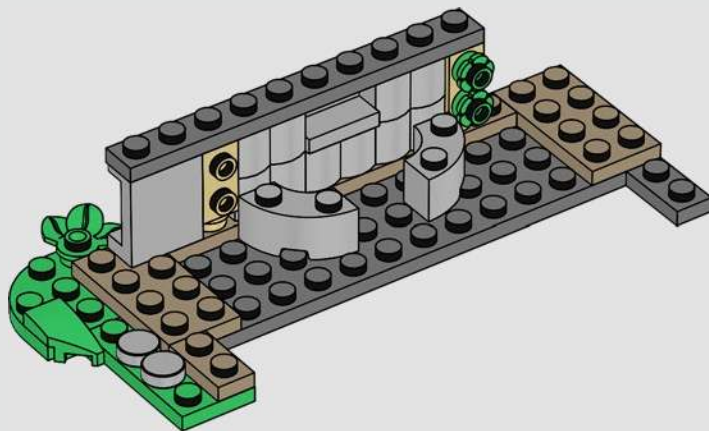

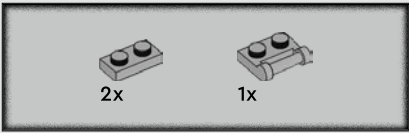

32

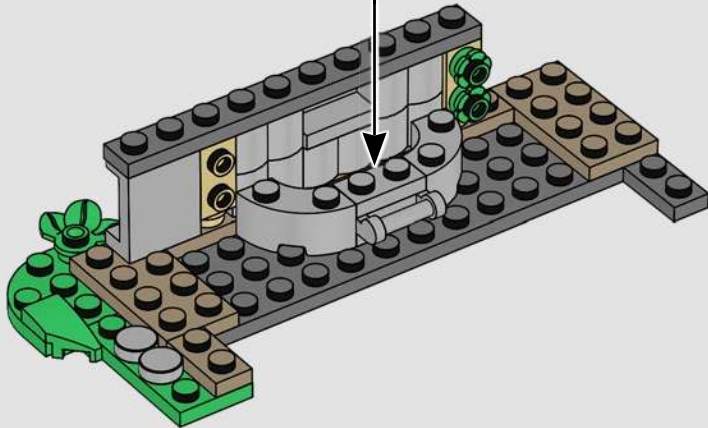
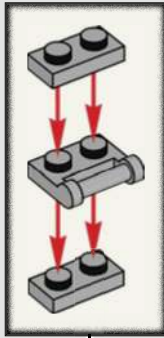

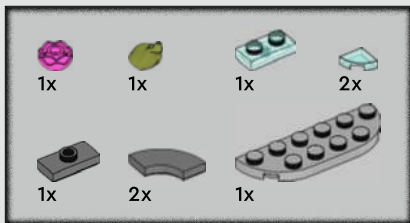

33

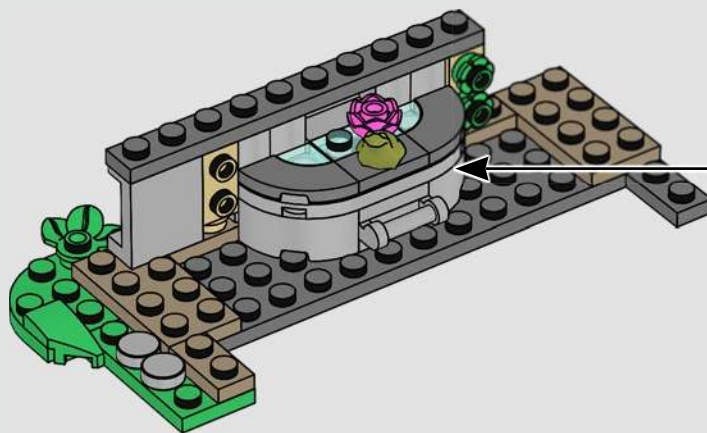
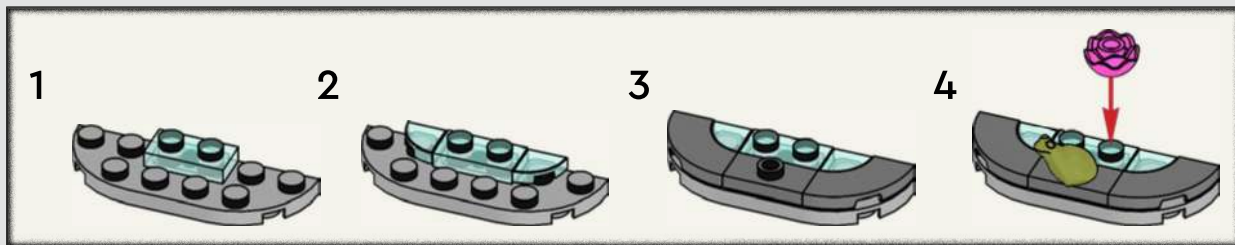

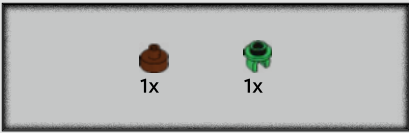

34



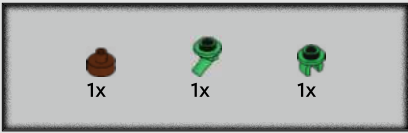

35

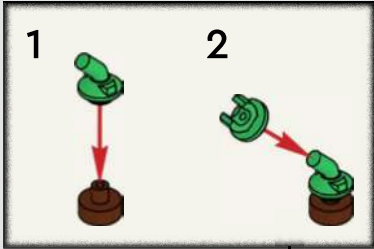



36

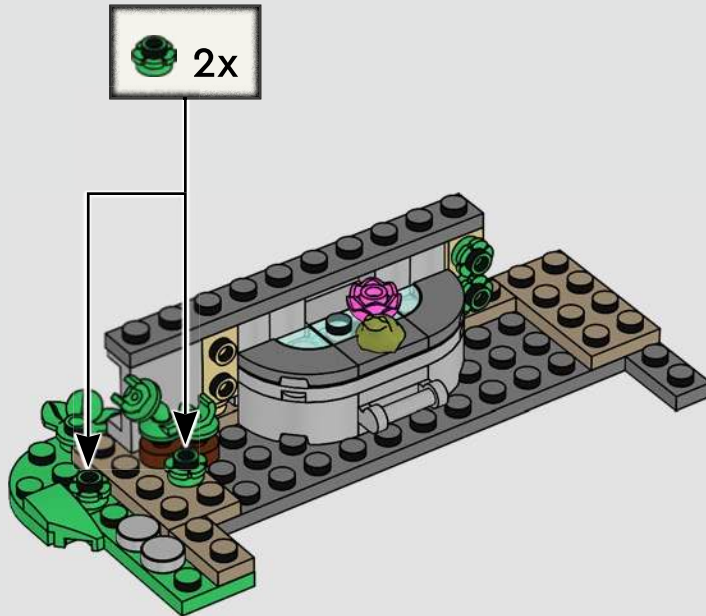

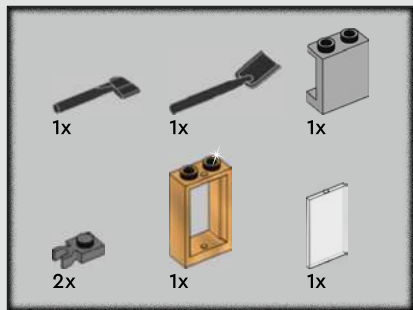

37

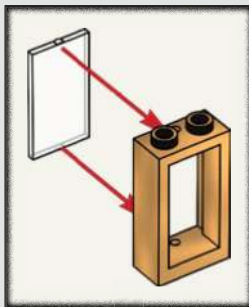

1

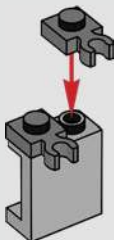

2



3



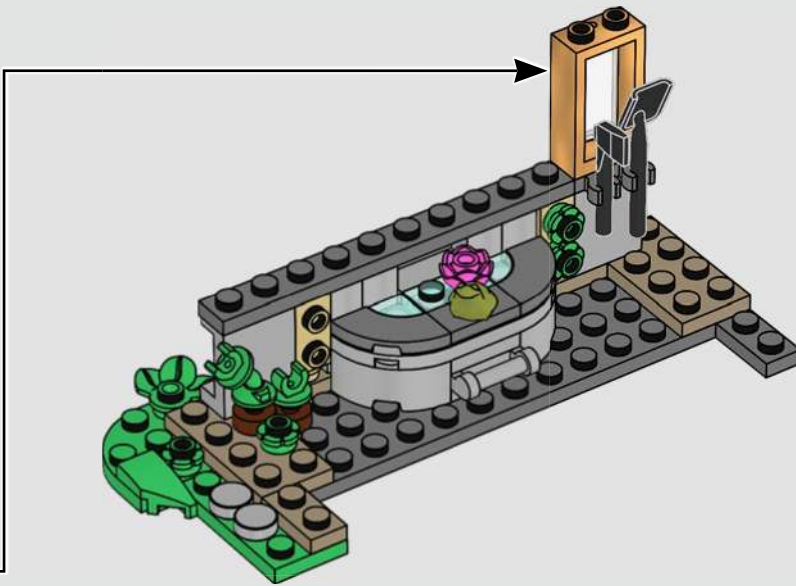

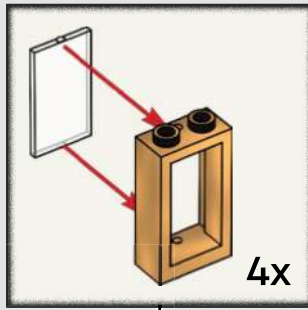
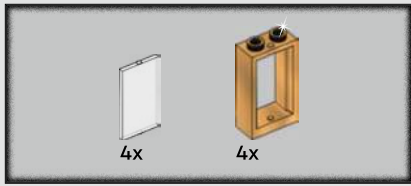

38

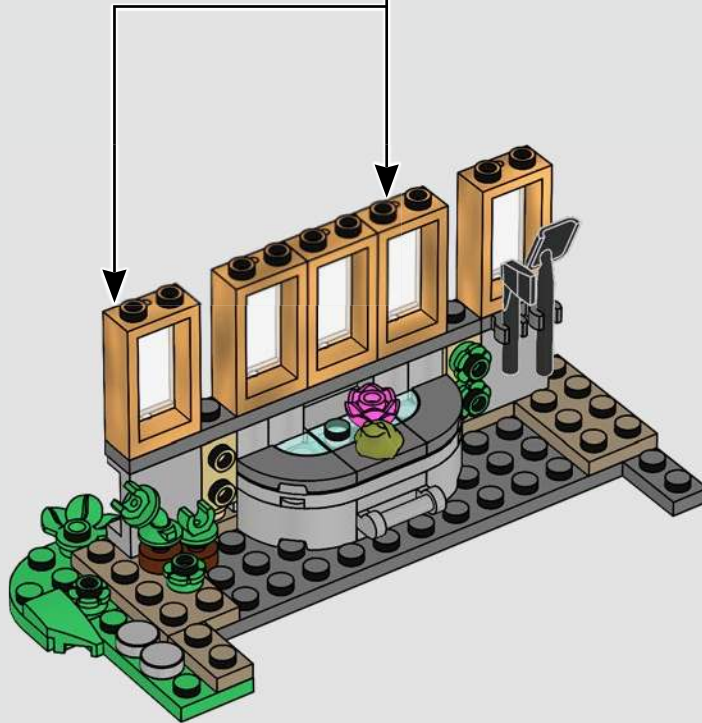

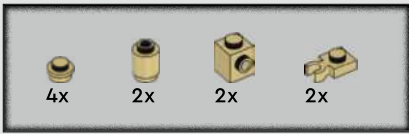

39

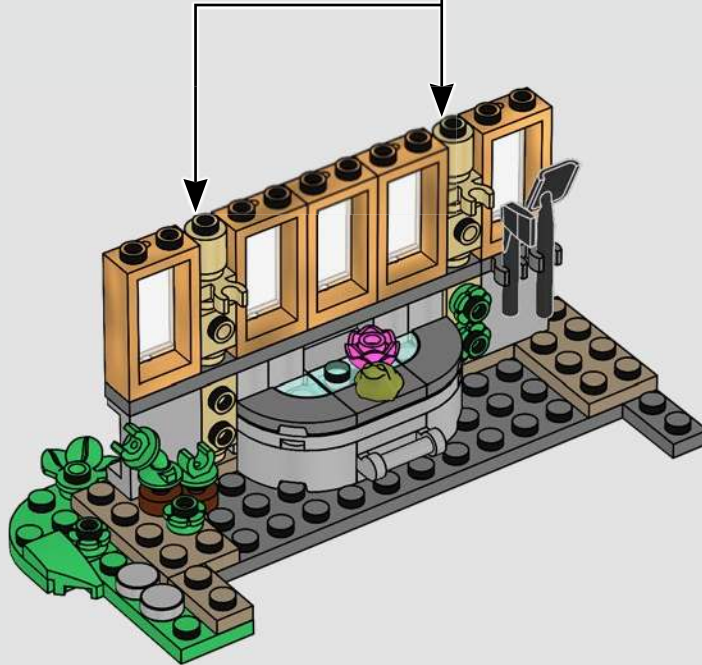
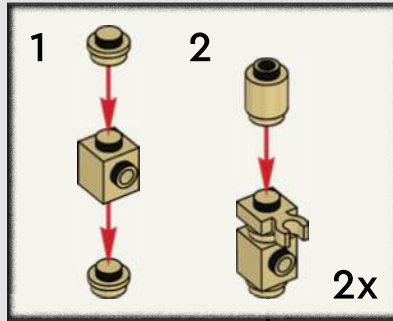

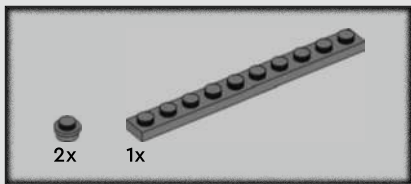

40





41

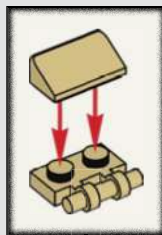

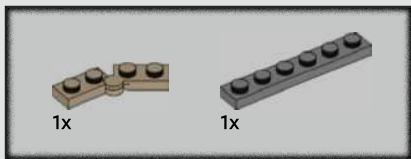

42

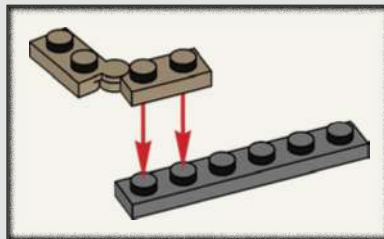

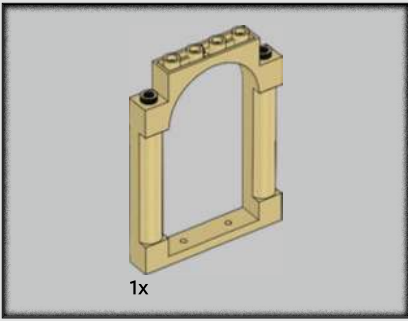

43



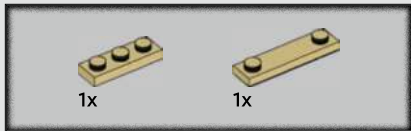

44

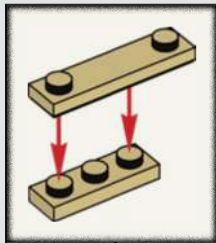



45

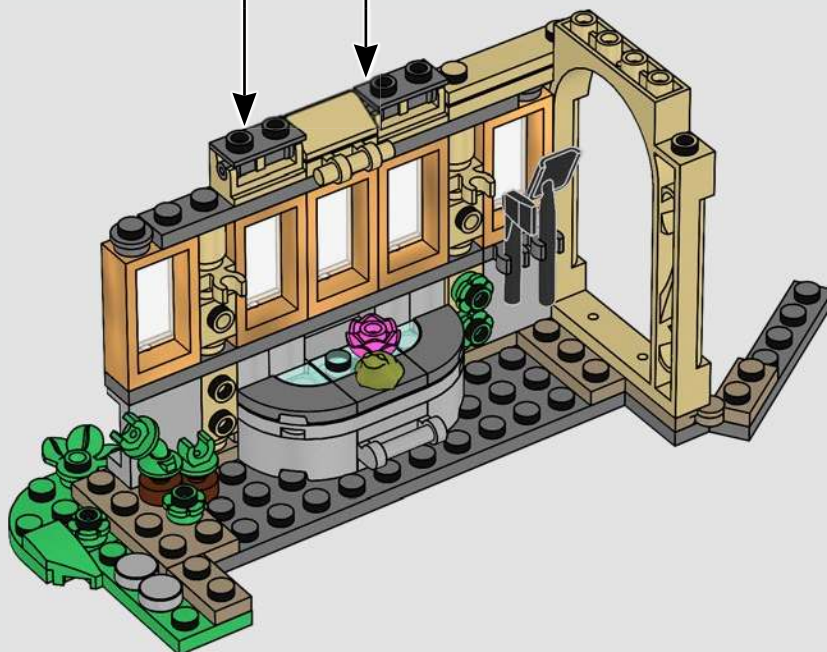
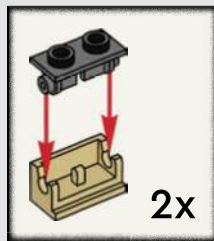

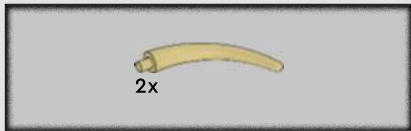

46

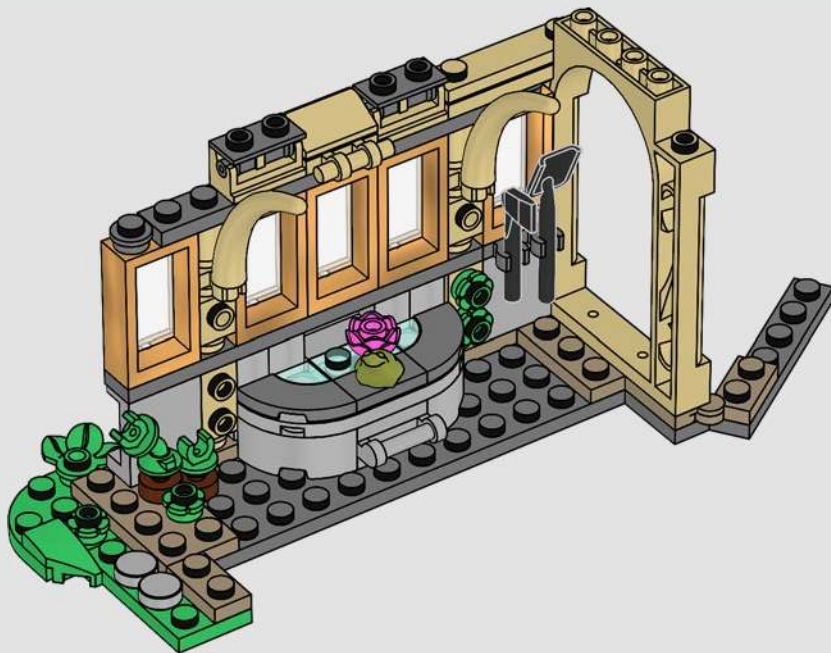



47

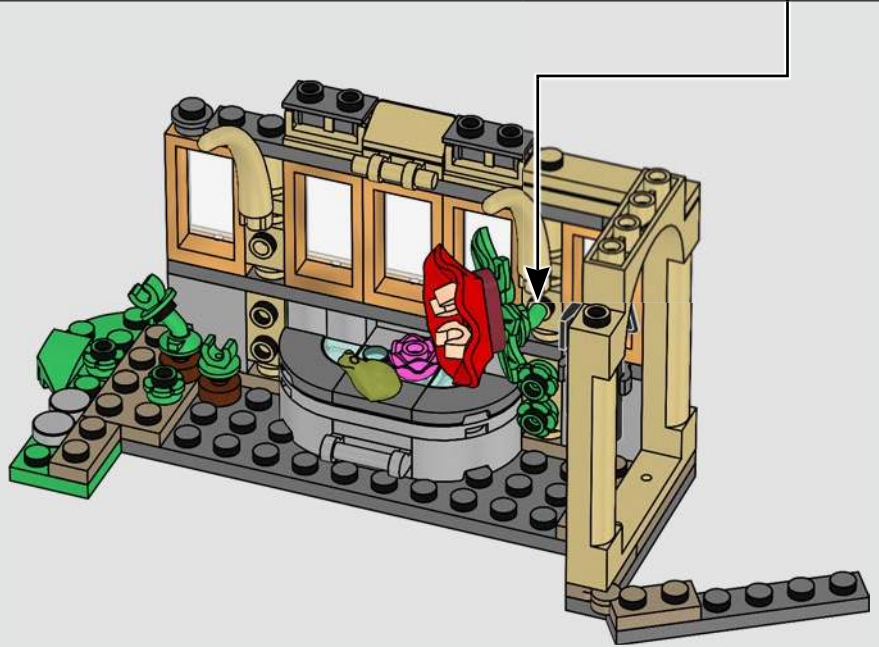
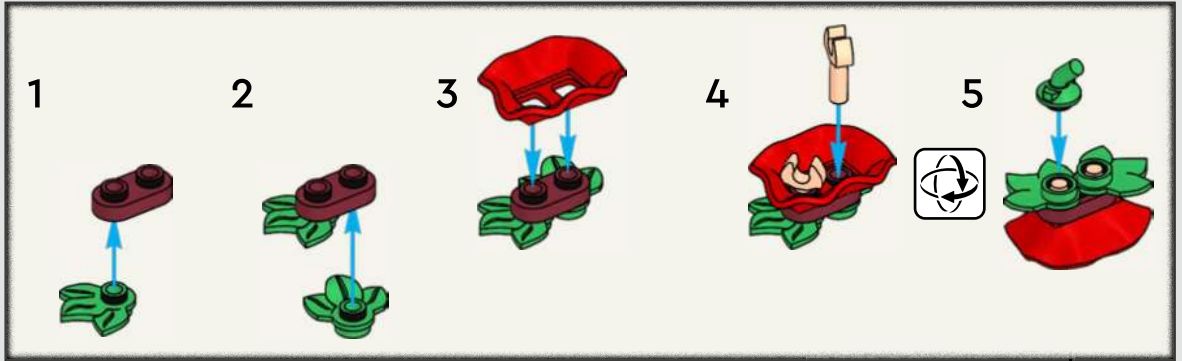

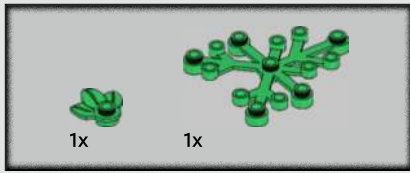

48

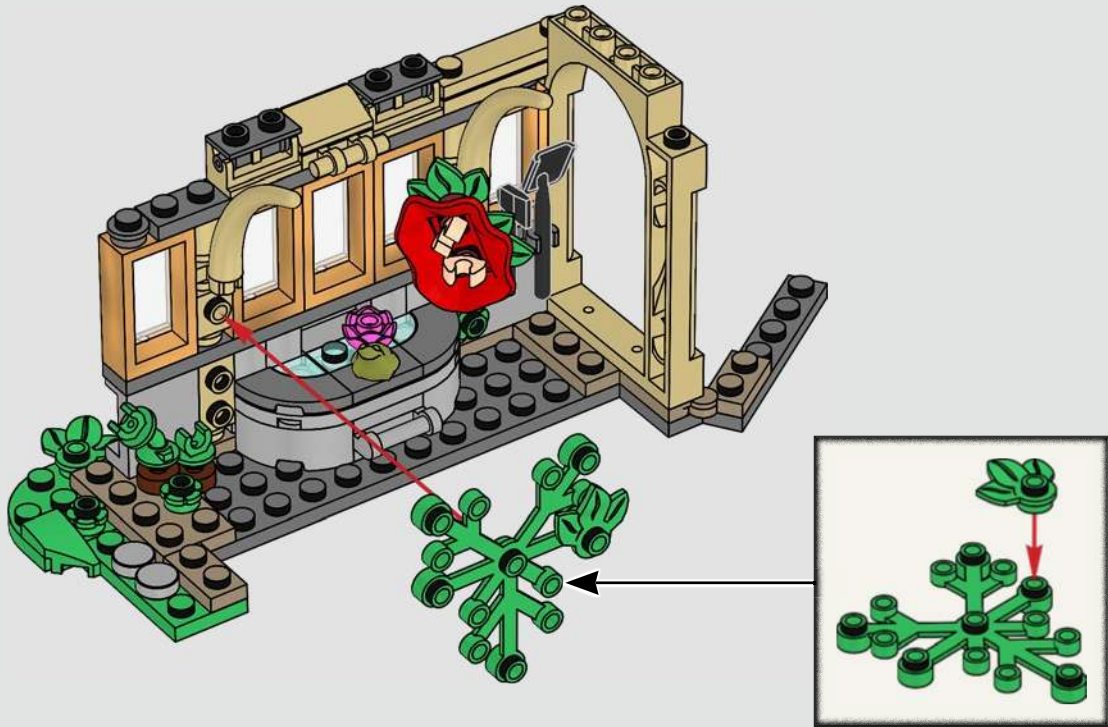



49

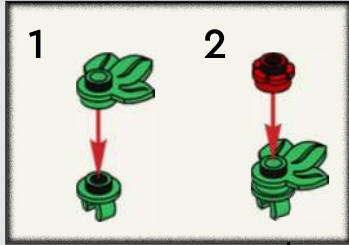



50

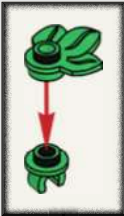

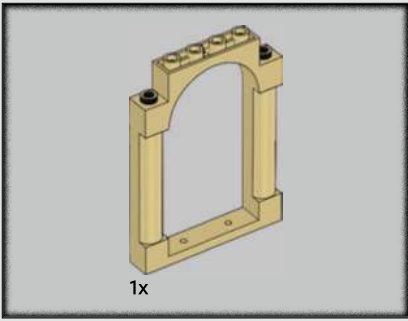

51

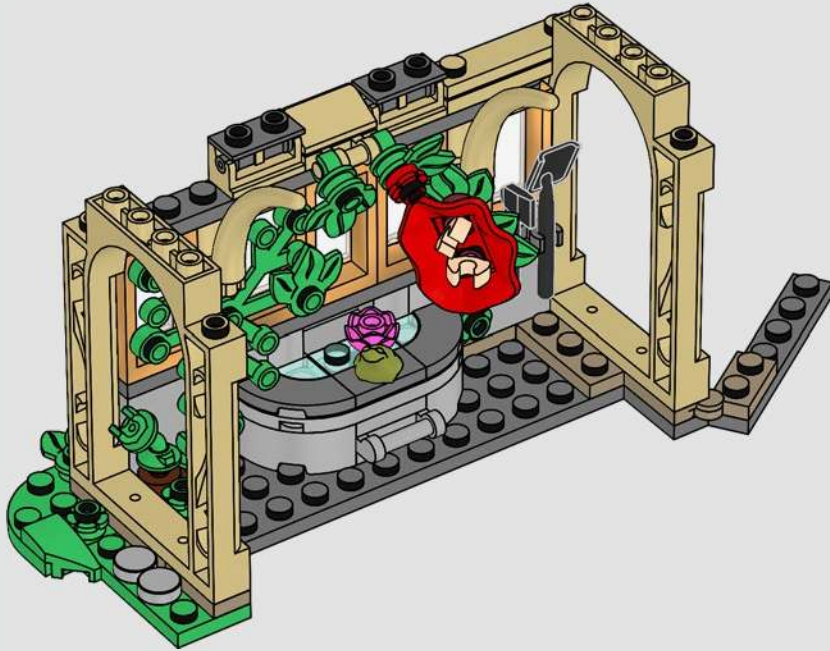

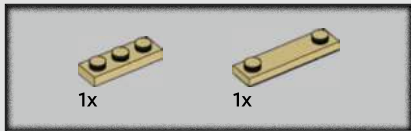

52

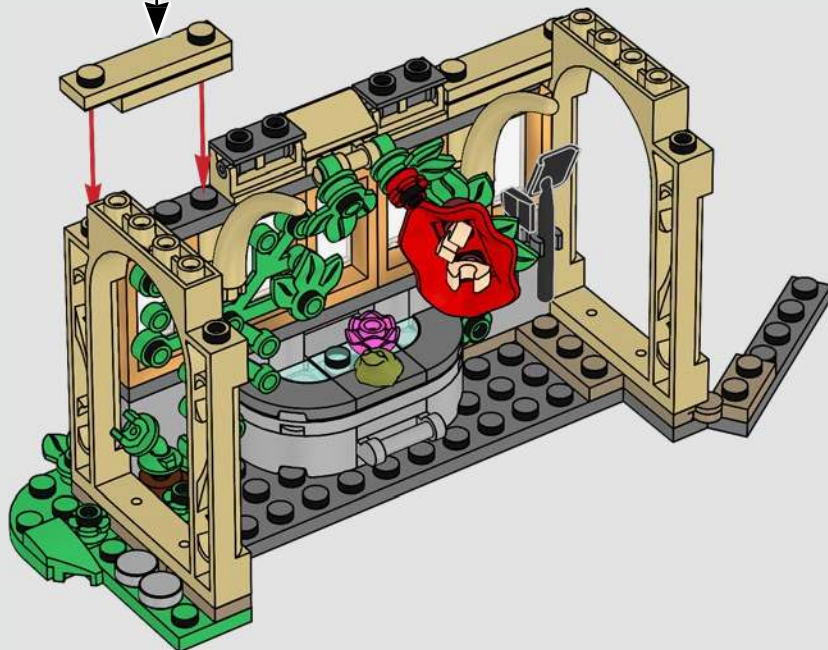
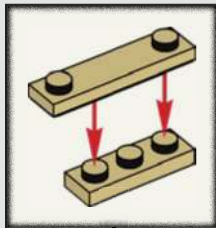



1x



1x

# 53

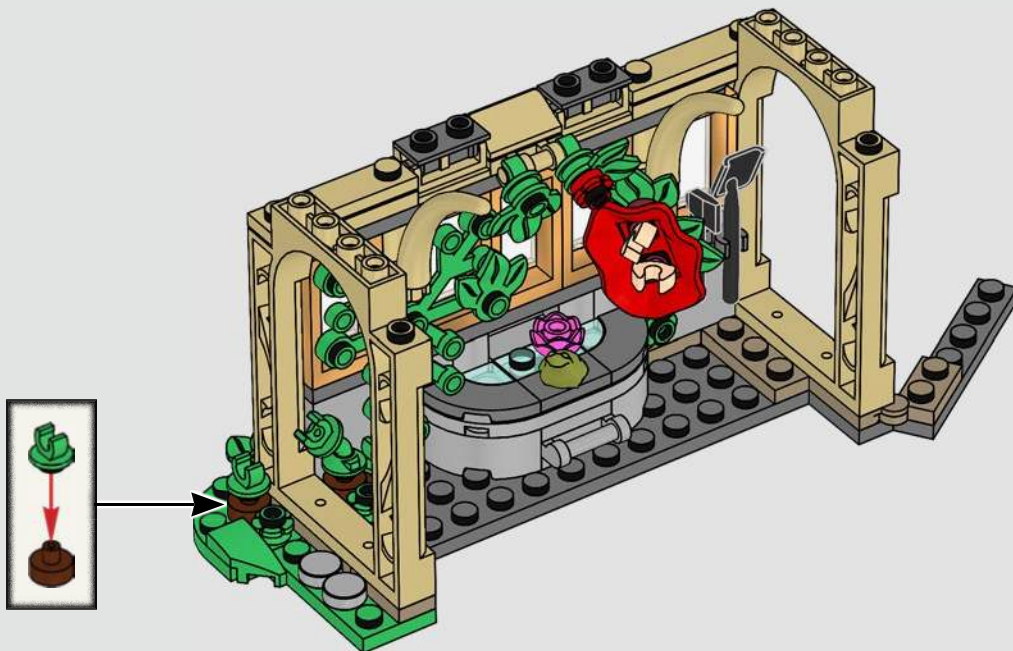



54

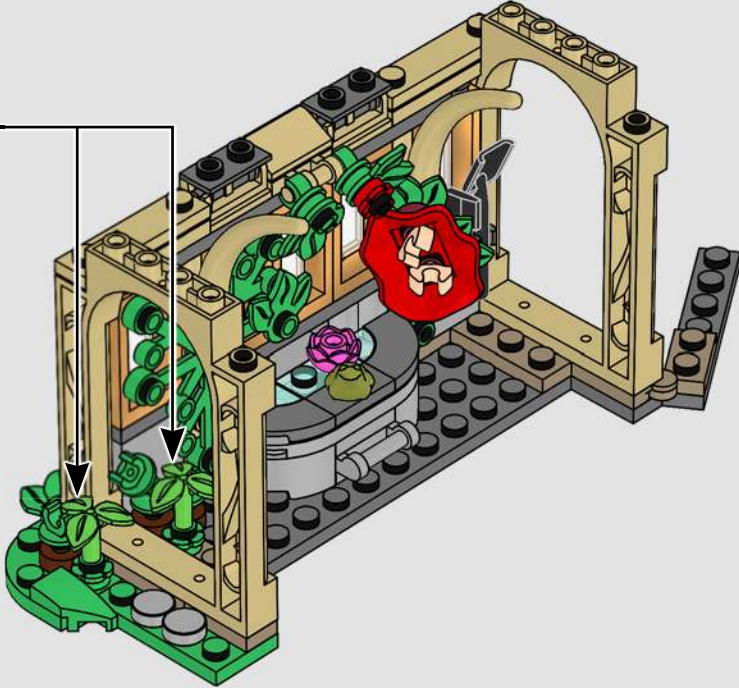



55

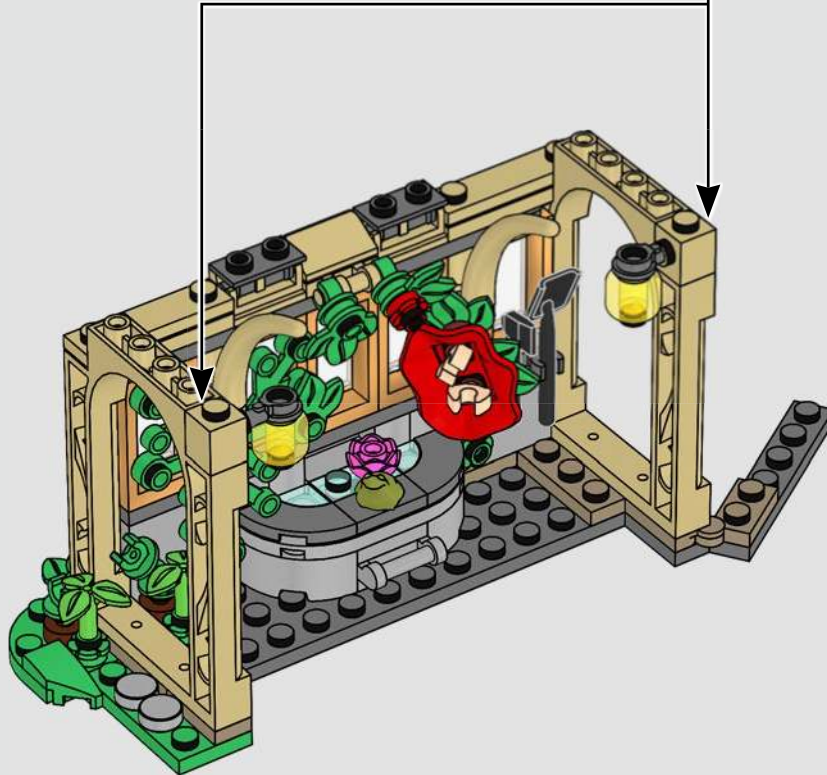
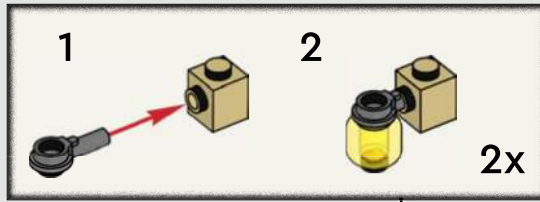



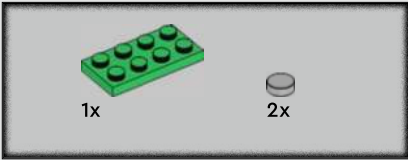
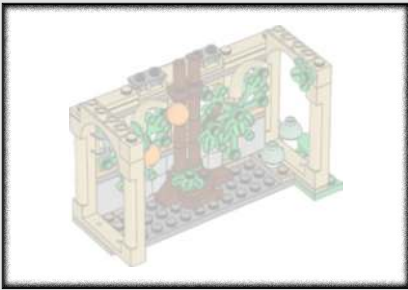

56

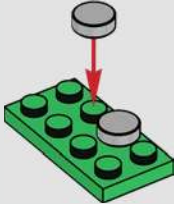

57

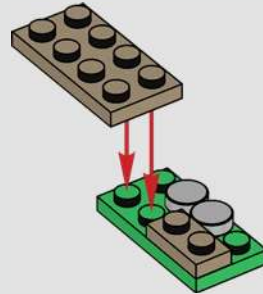

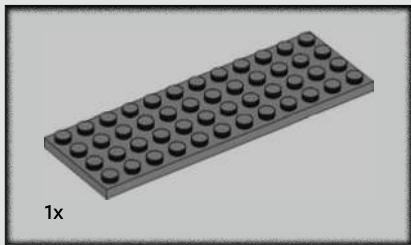

58

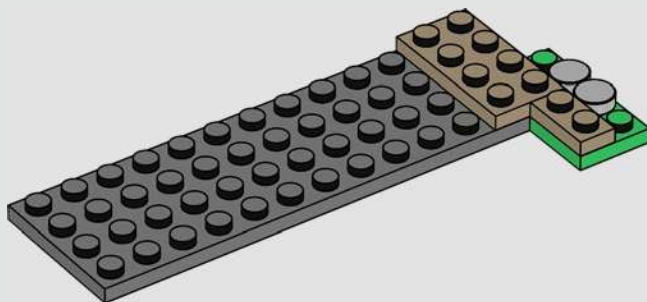

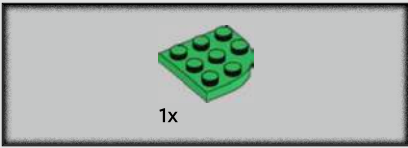

59

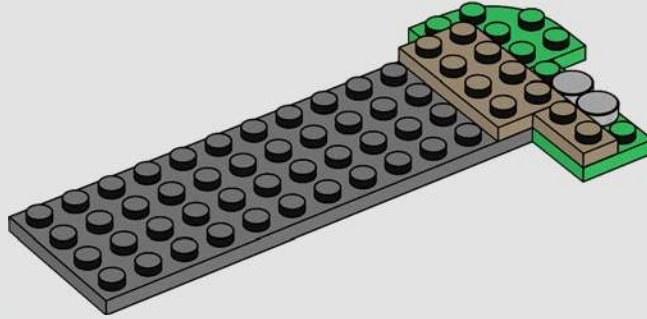

60

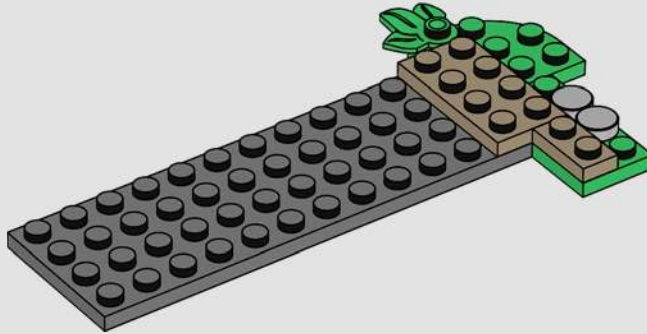

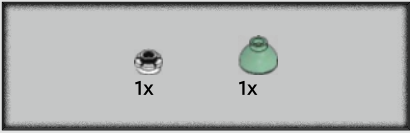

61

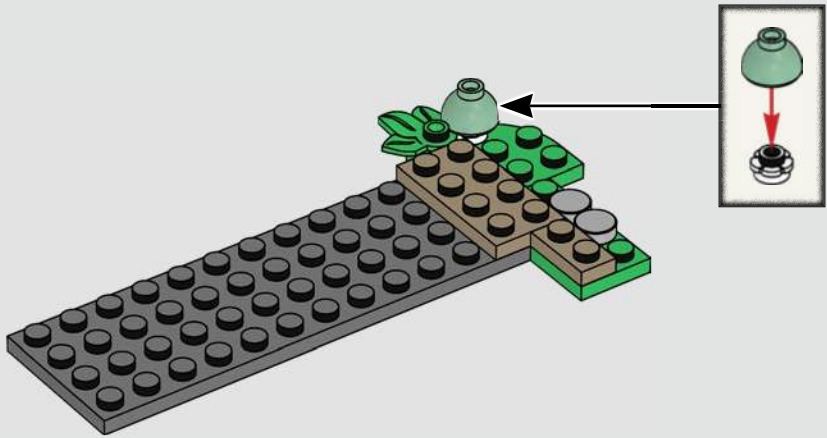





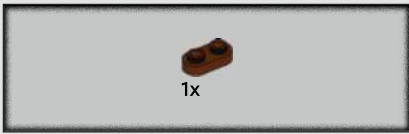

65



66



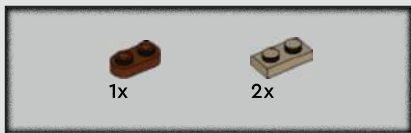

67



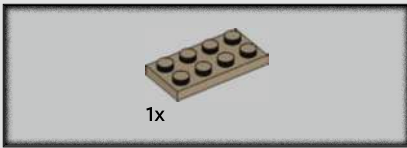

68

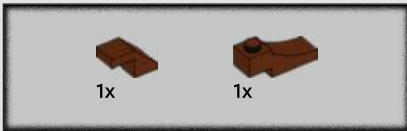
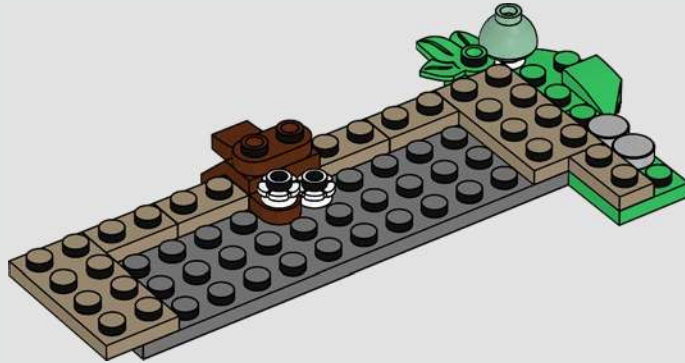

69

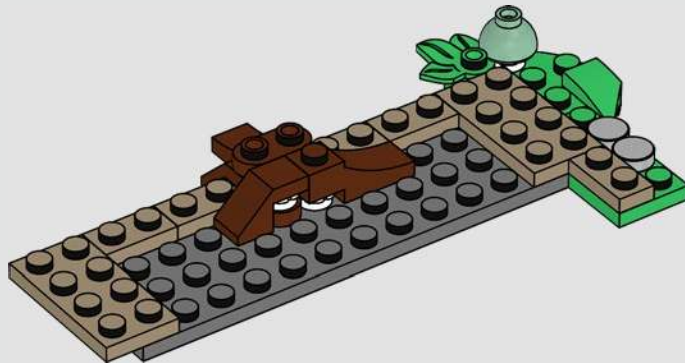



70

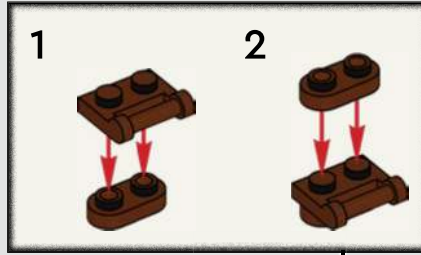

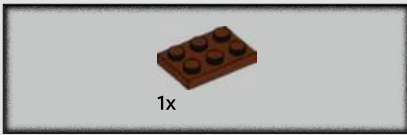

71

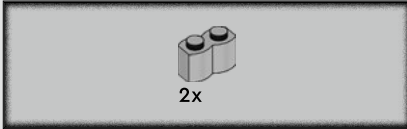
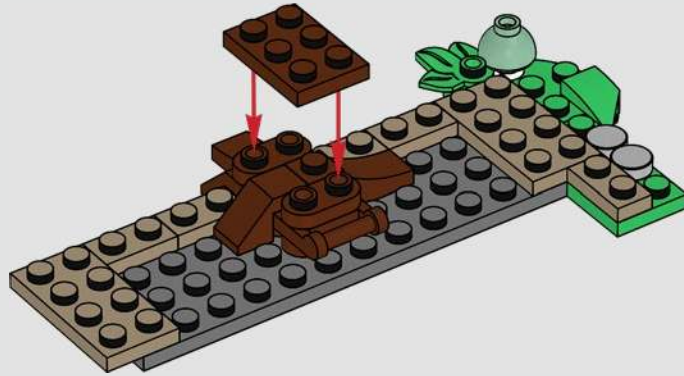

72



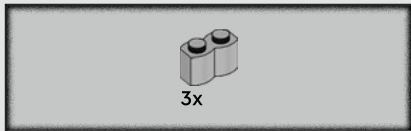

73

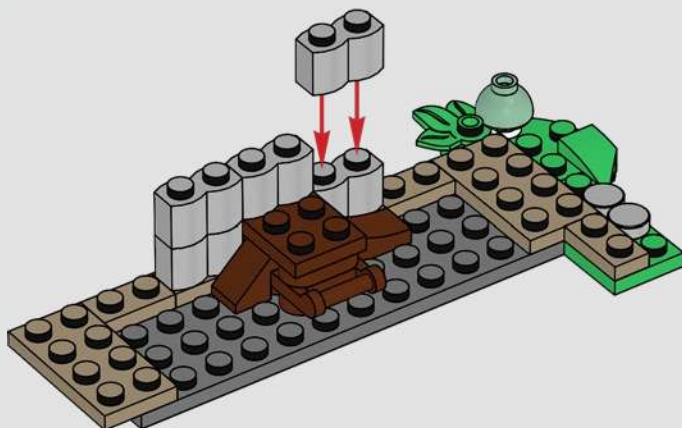

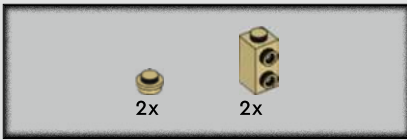

74

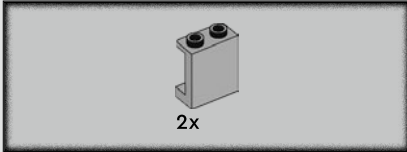
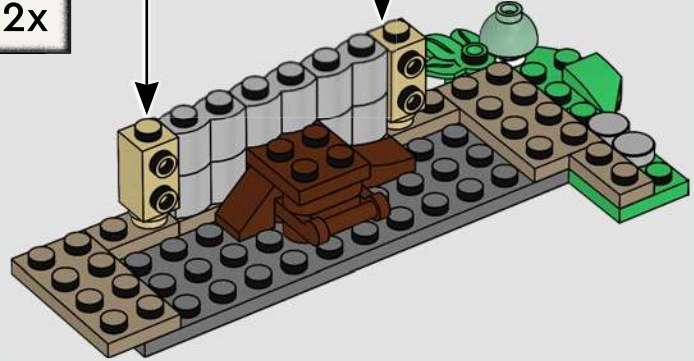
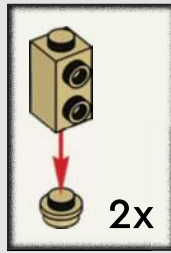

75

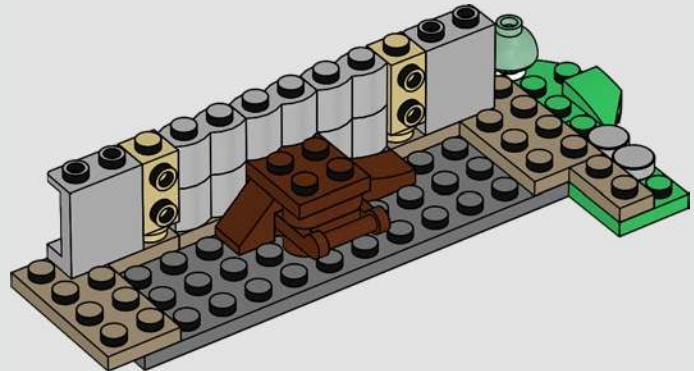

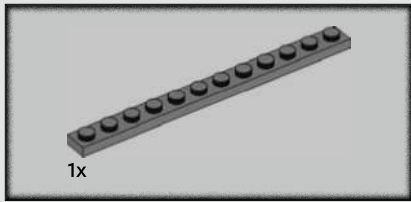

76

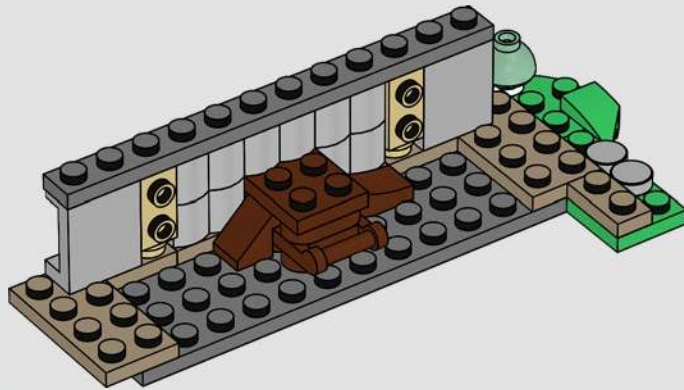

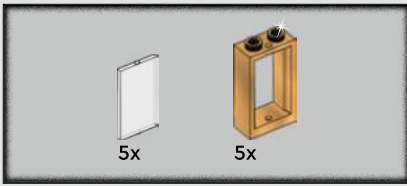

77

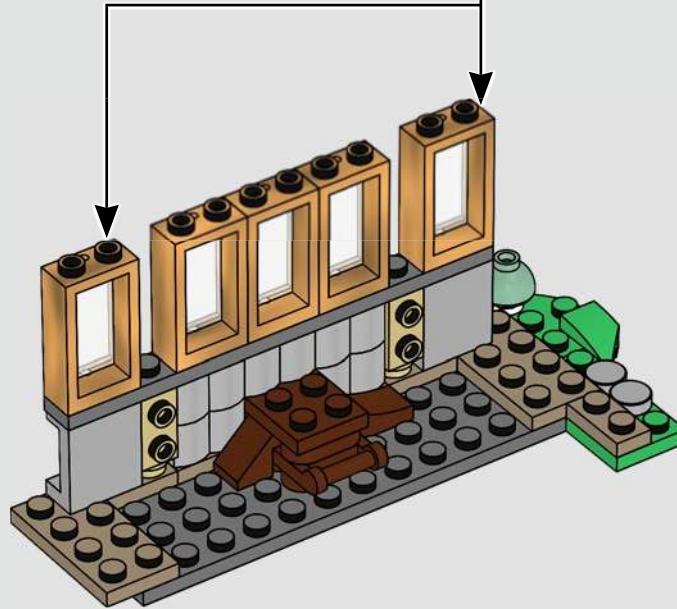
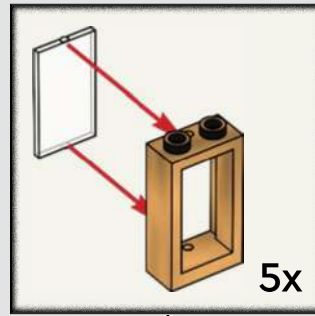



78

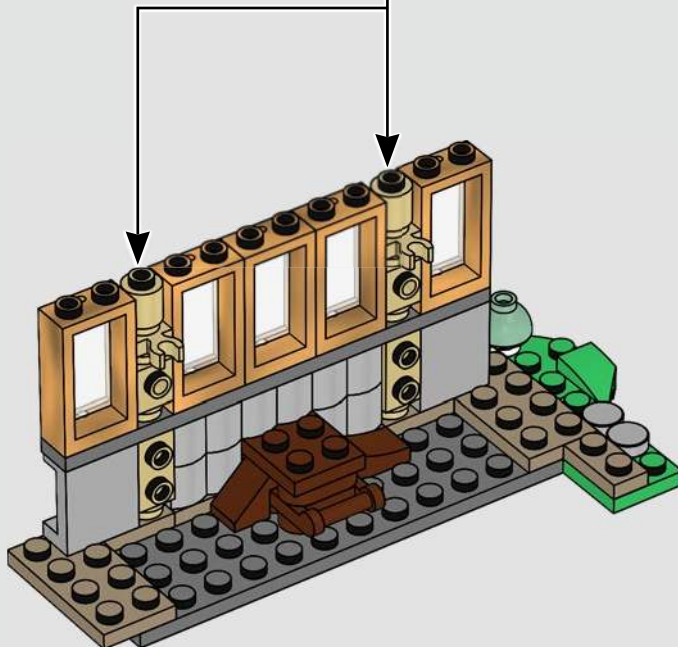
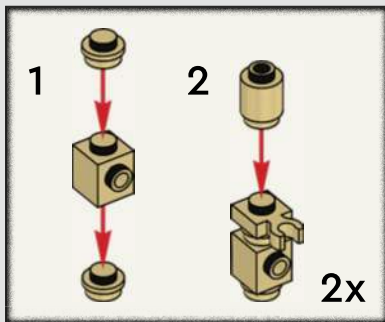

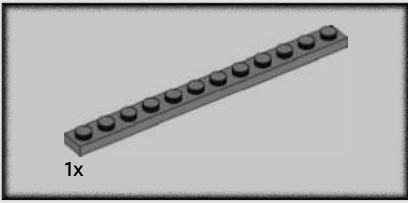

79



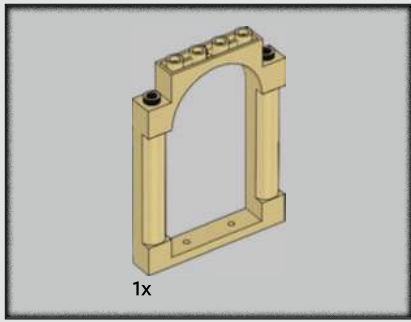

80



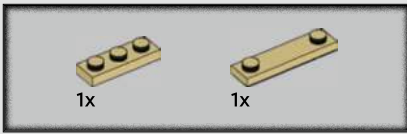

81

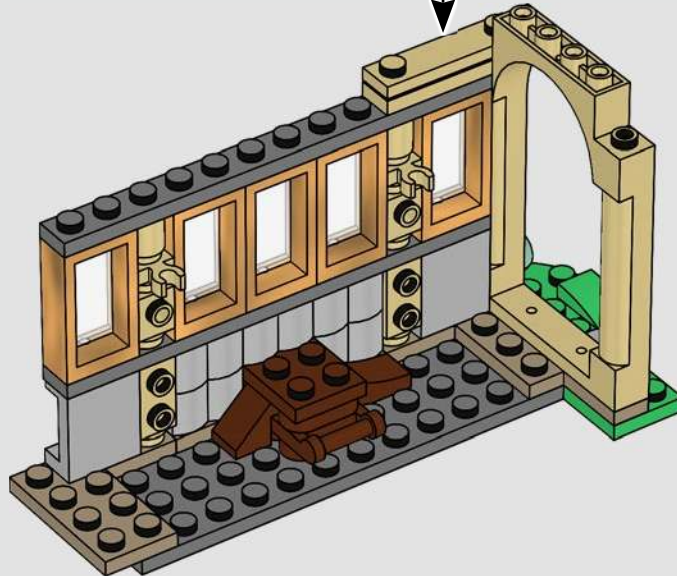
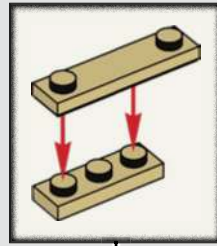



82

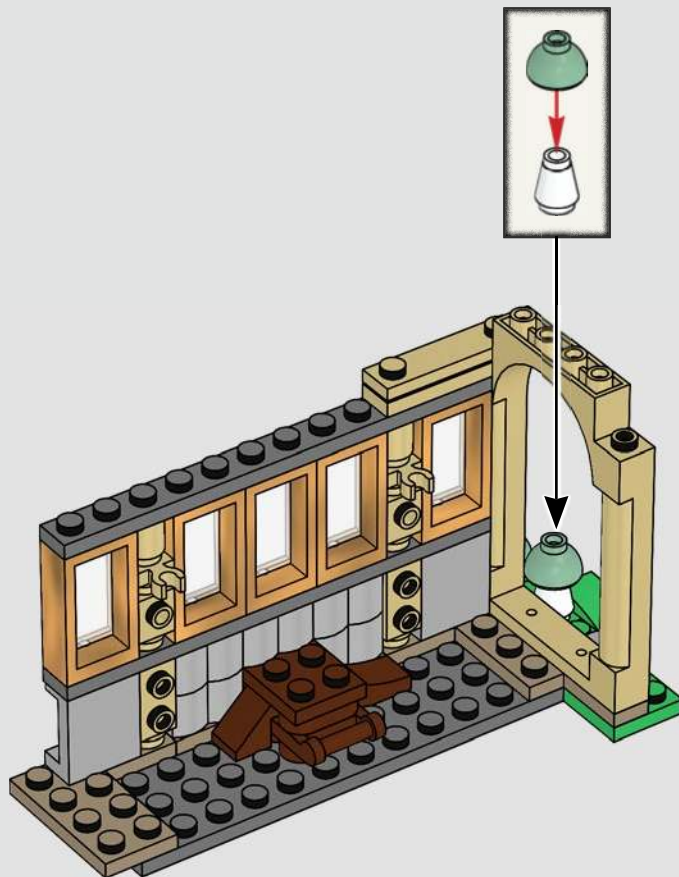

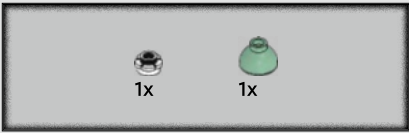

83

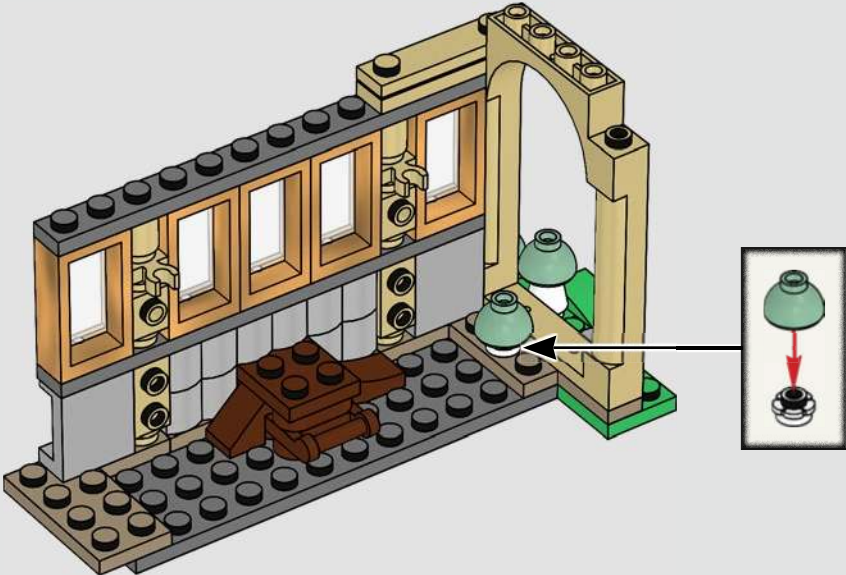



84

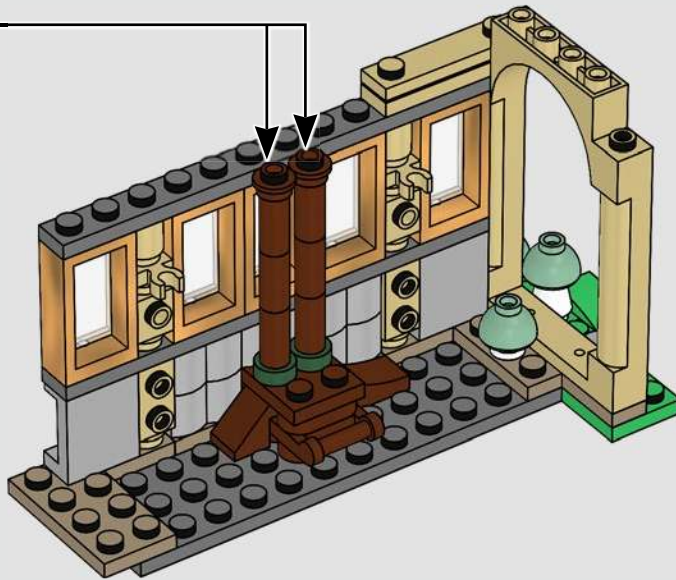
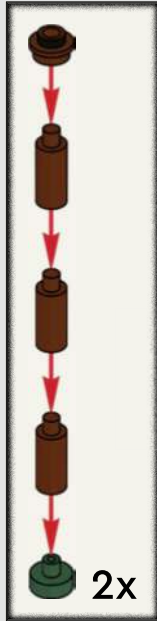



85





86





87

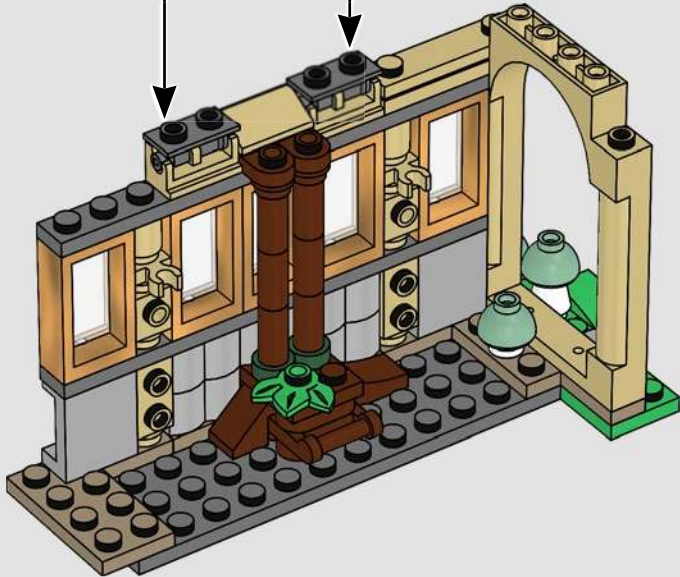
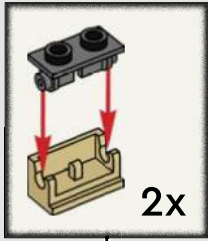



88

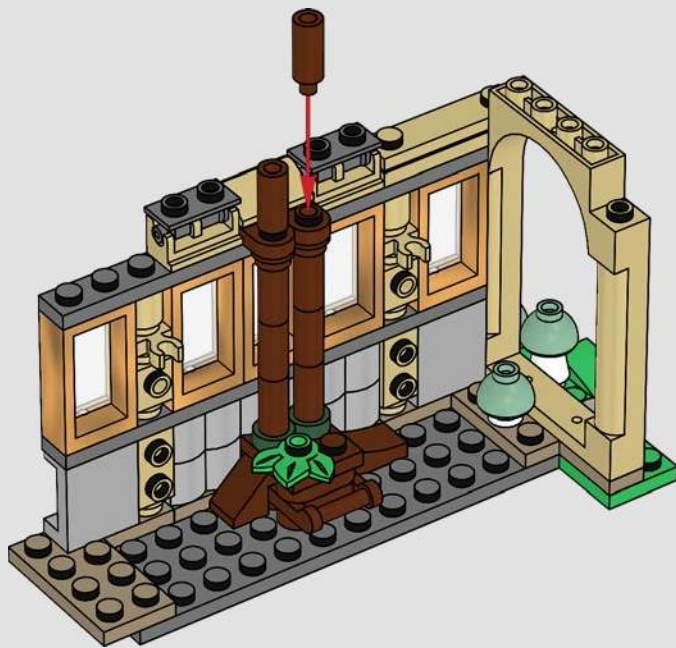

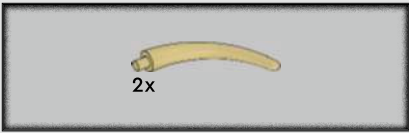

89



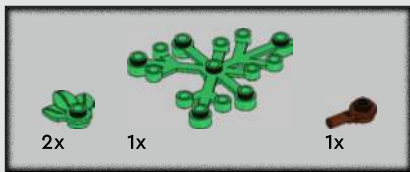

90

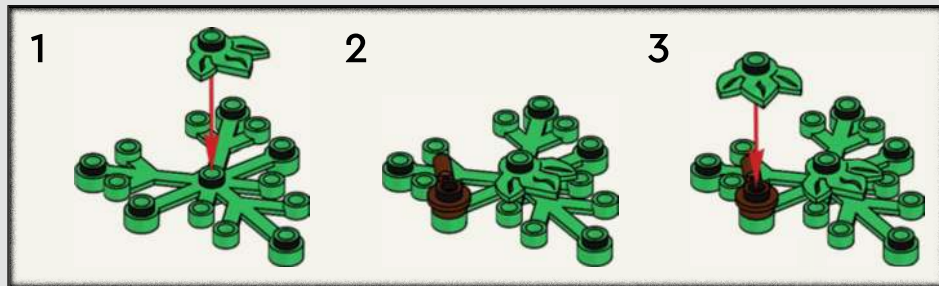

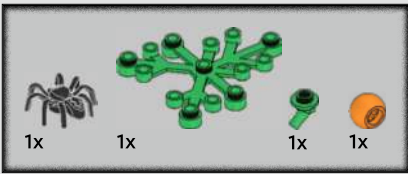

91

1



2

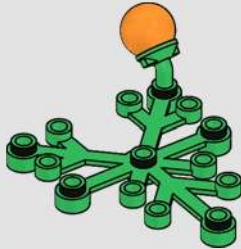

3

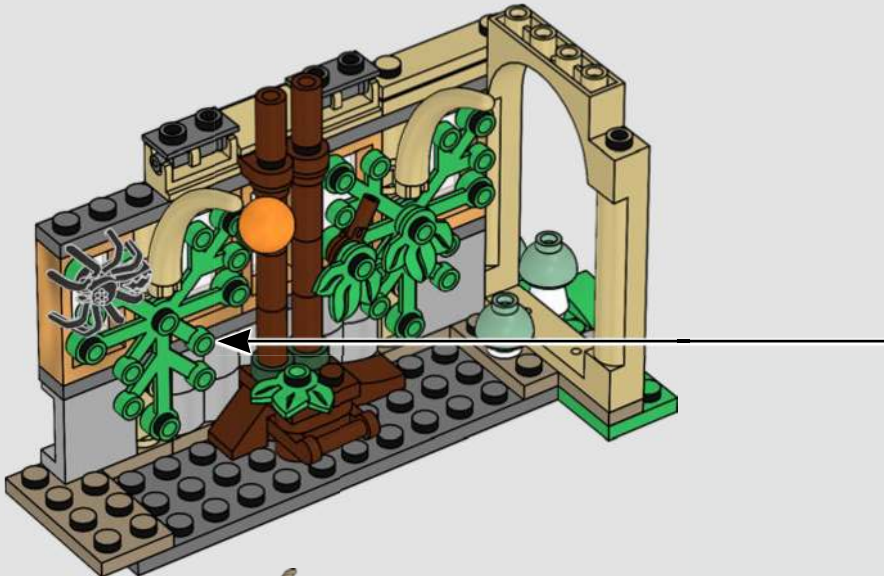

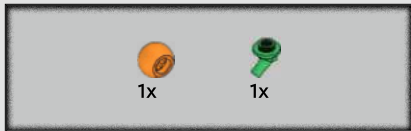

92

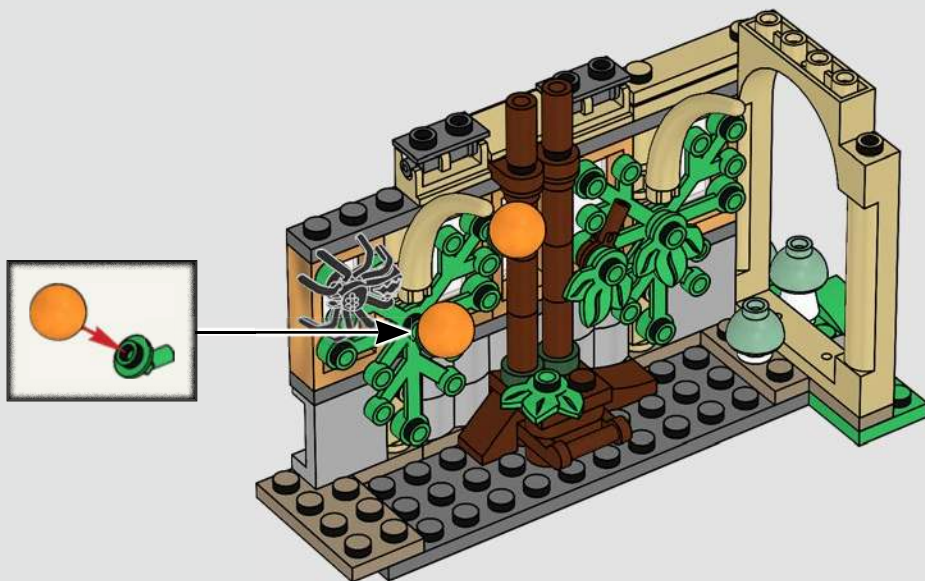

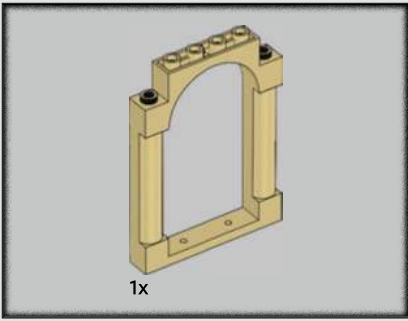

93



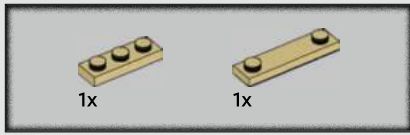

94

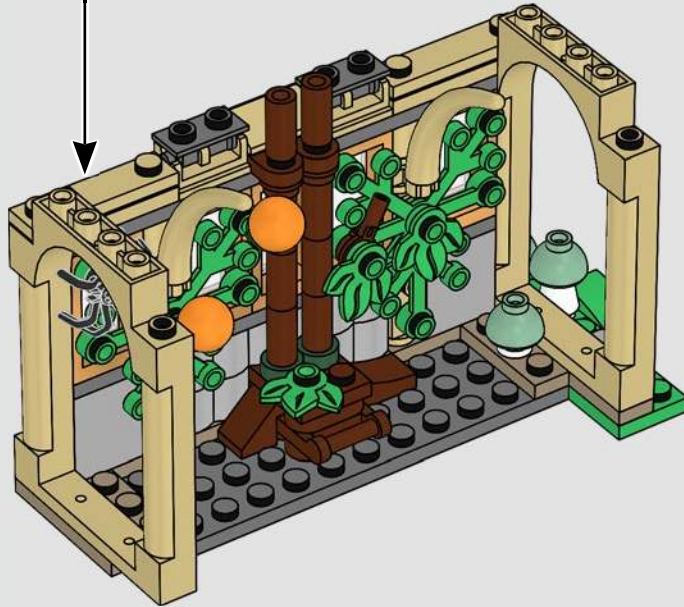
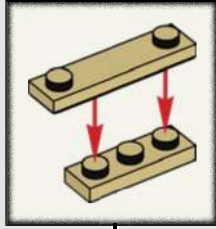



2x



2x

95

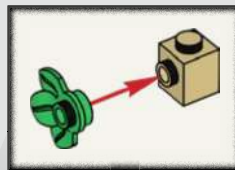
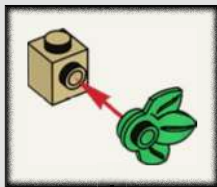

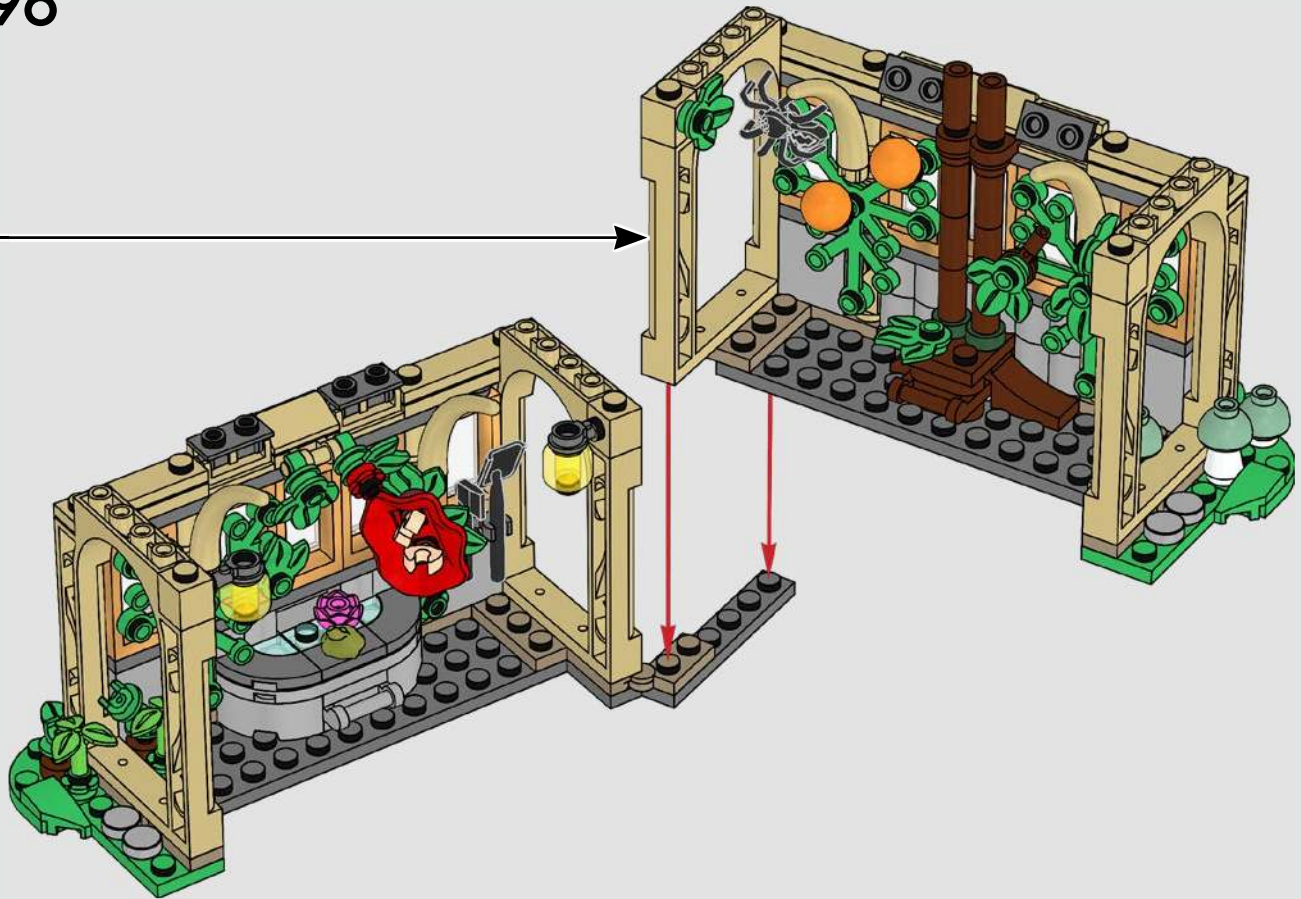

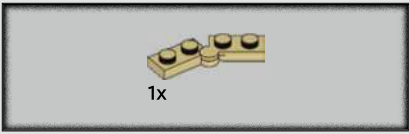

97

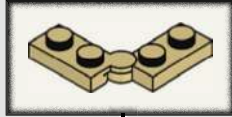



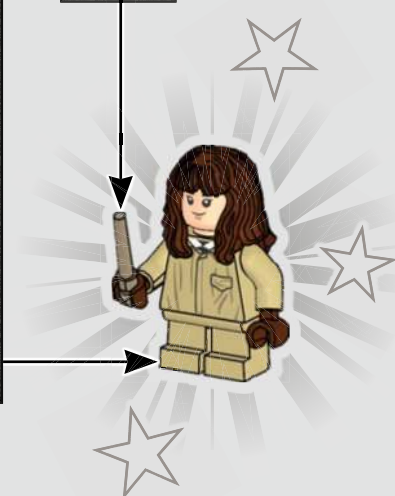
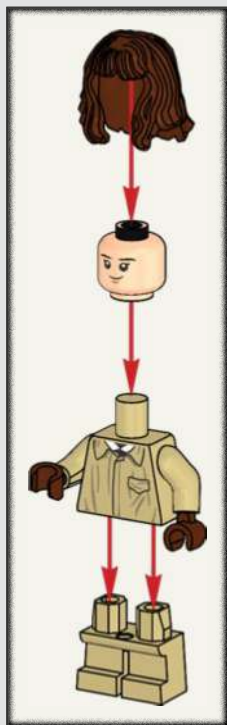



98

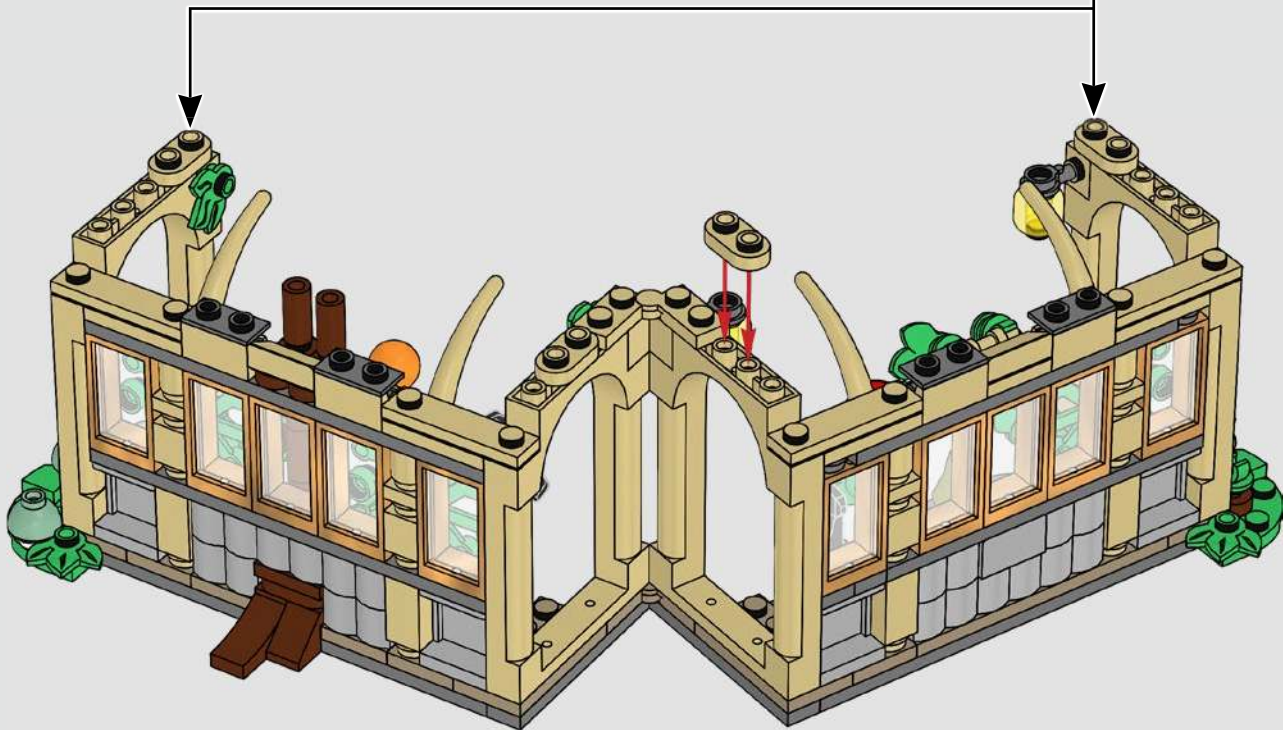



99



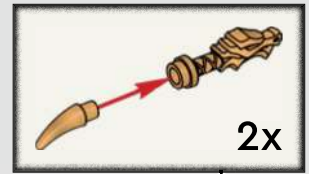

100

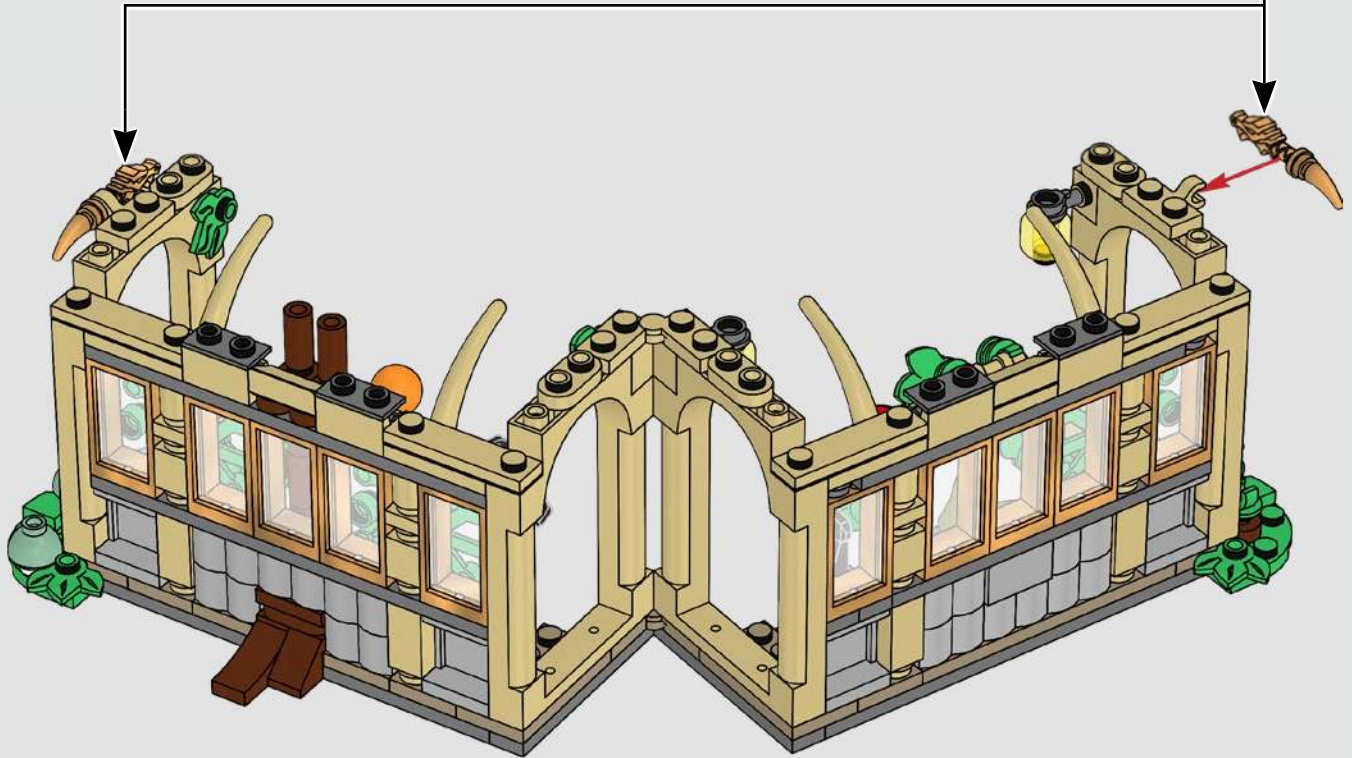

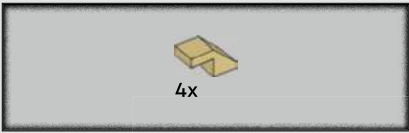

101

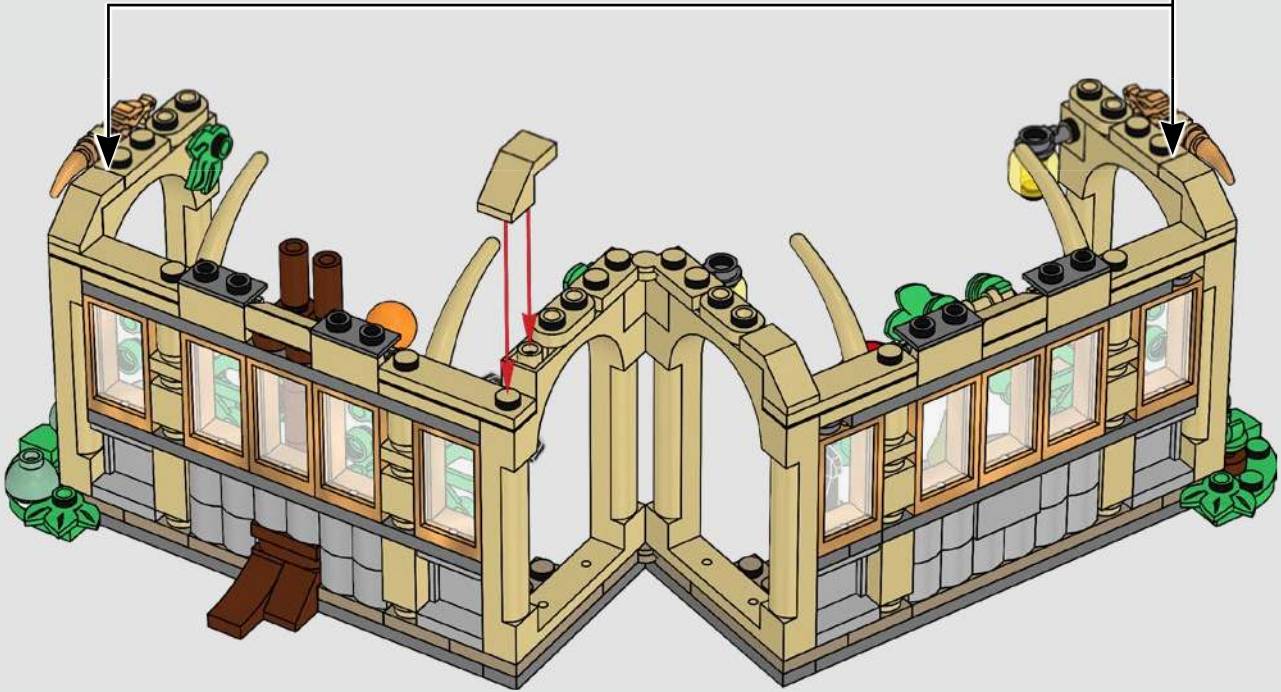

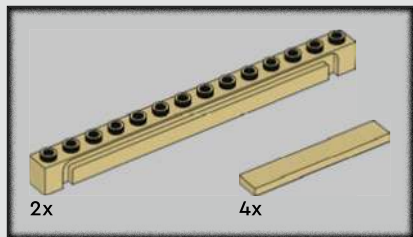

102

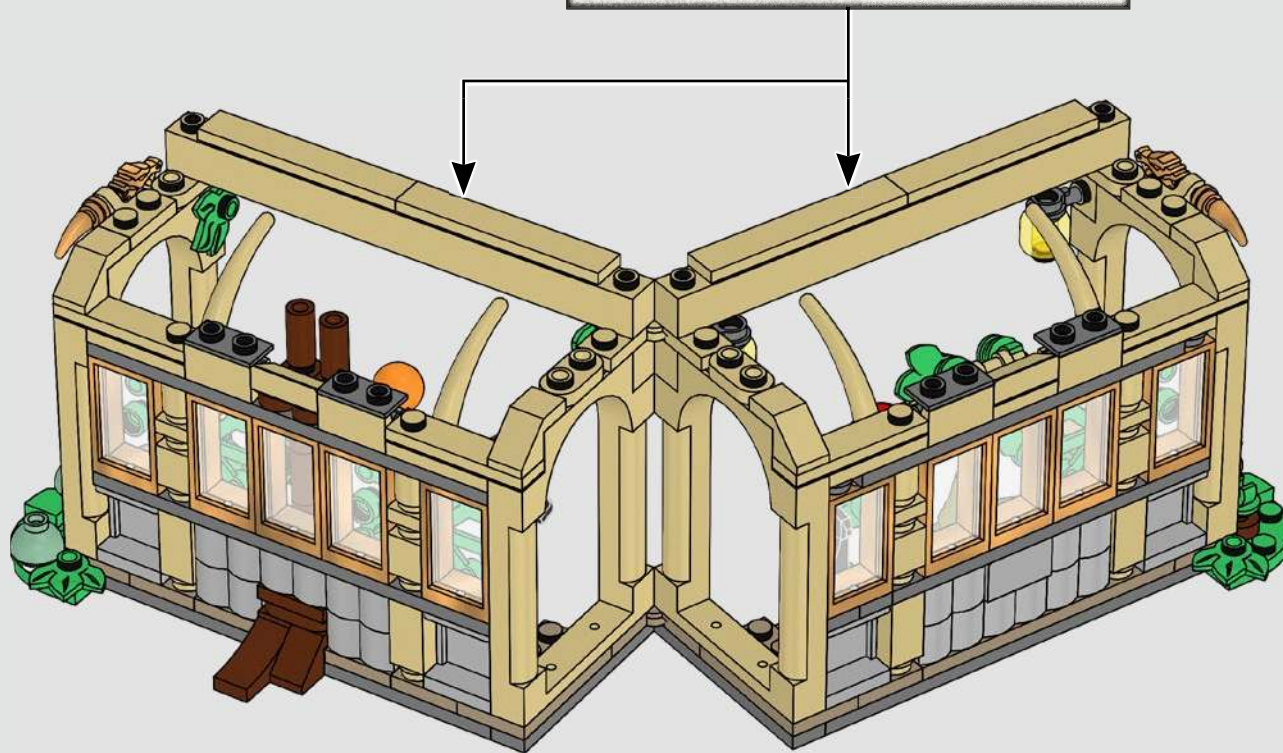
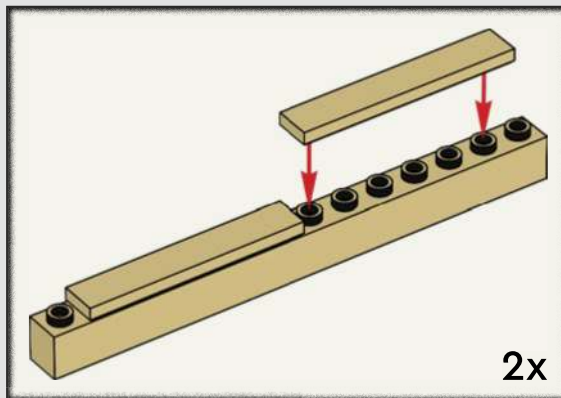

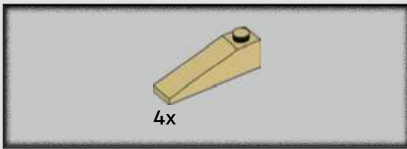

103

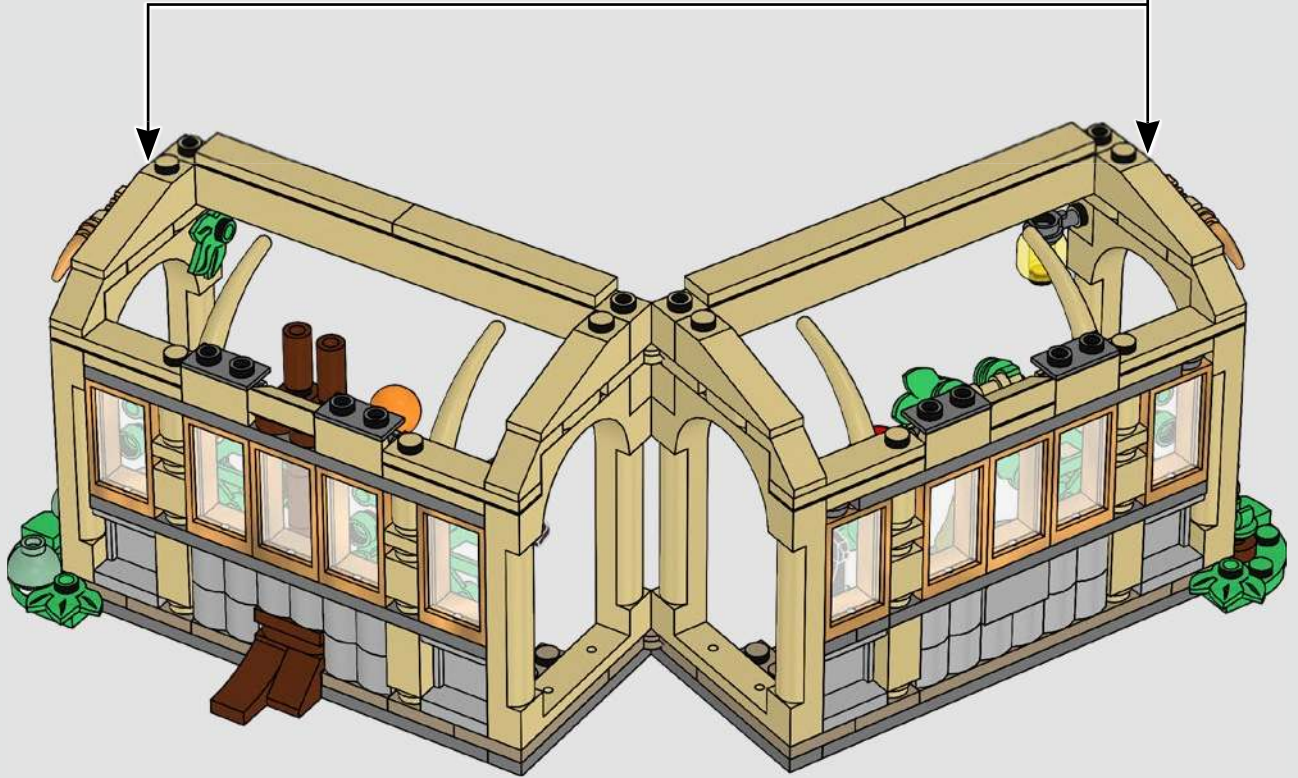
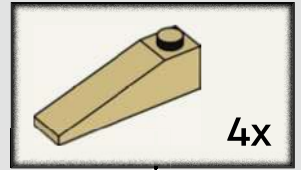

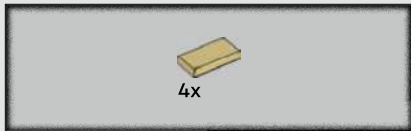

104

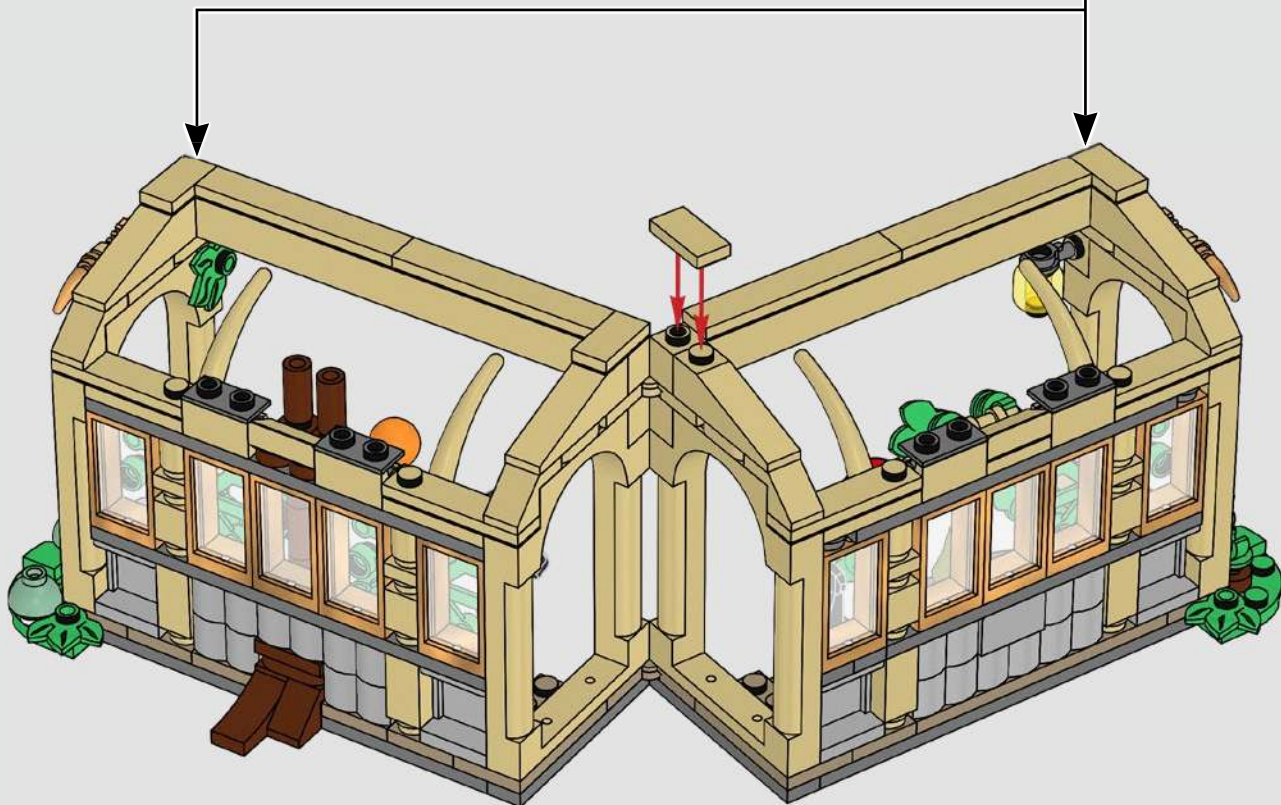

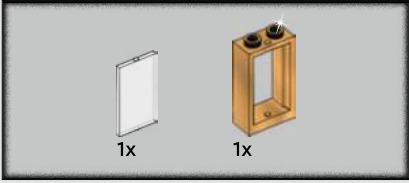

105

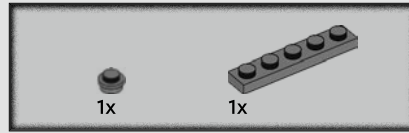
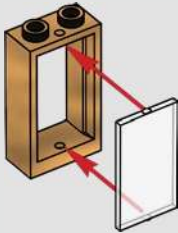

106

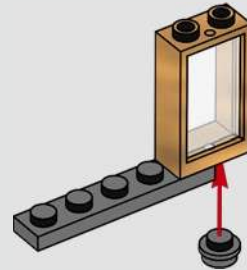

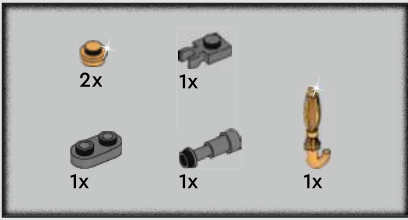

107

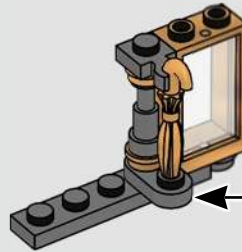
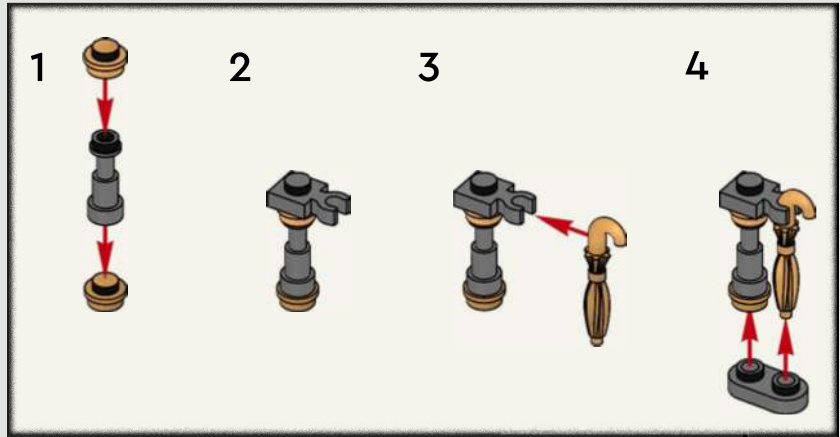

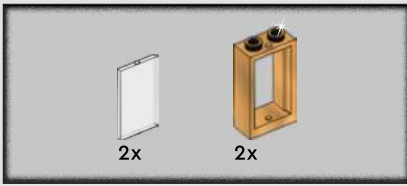

108

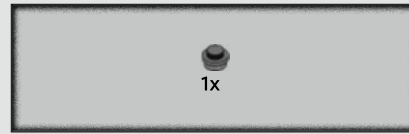
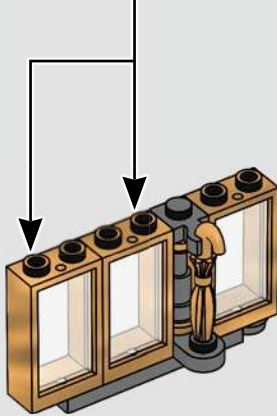
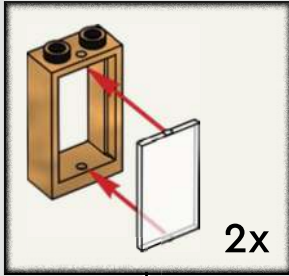

109

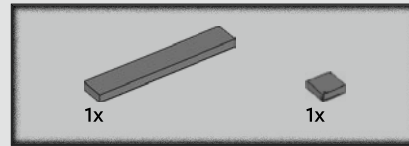
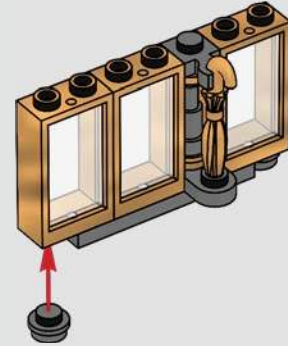

110

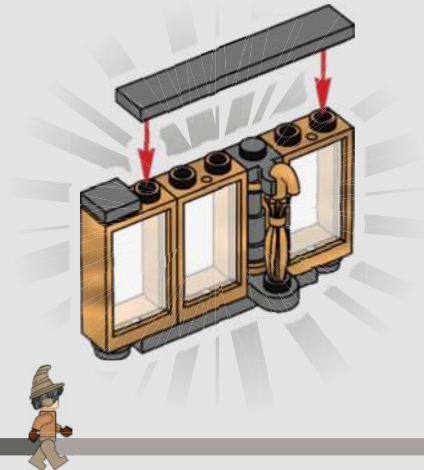

111

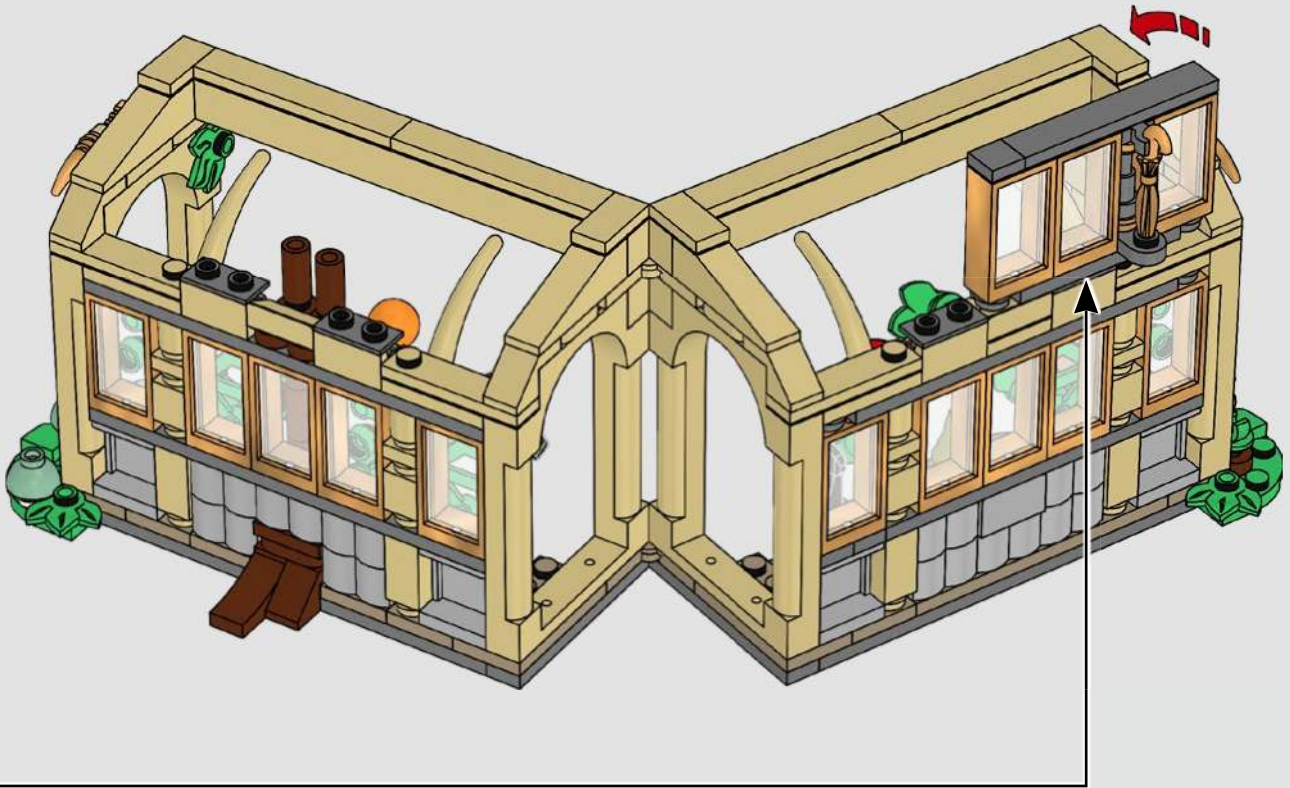

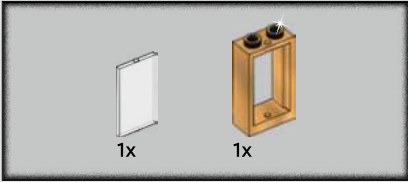
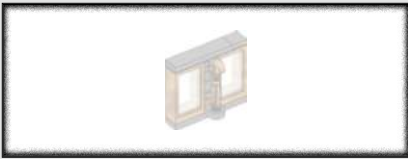

112

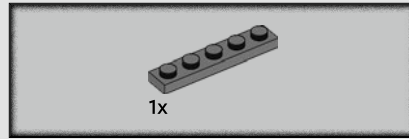
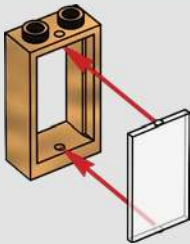

113

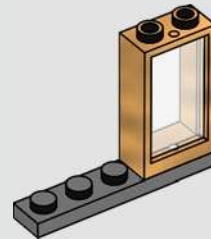

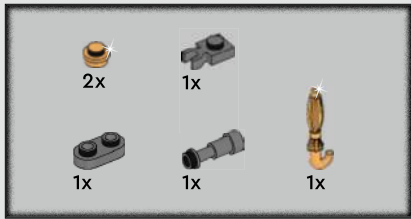

114

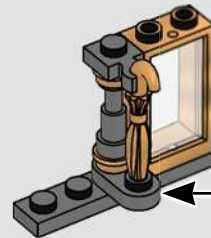
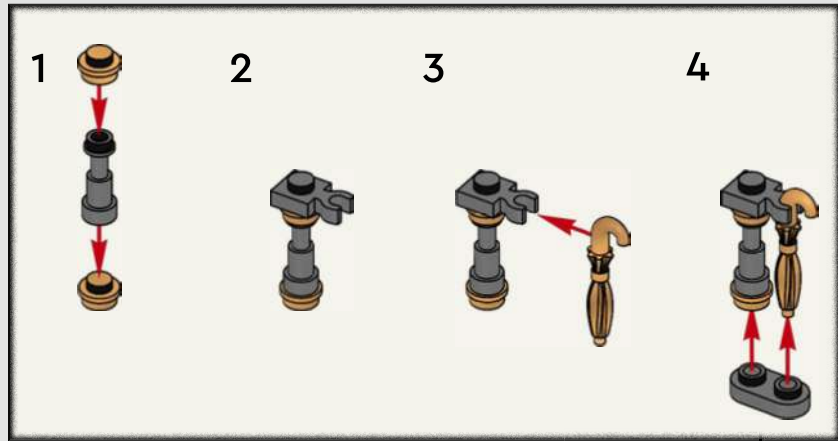

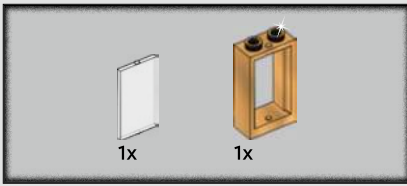

115

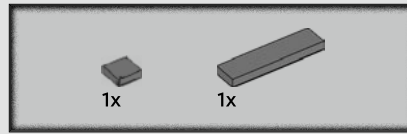
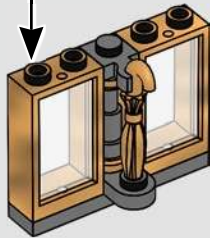
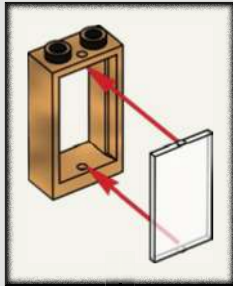

116

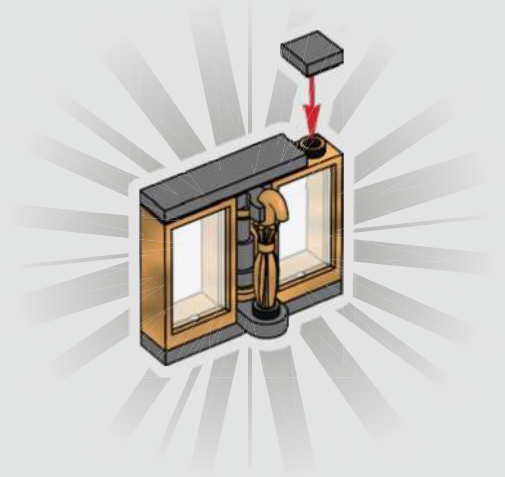

117

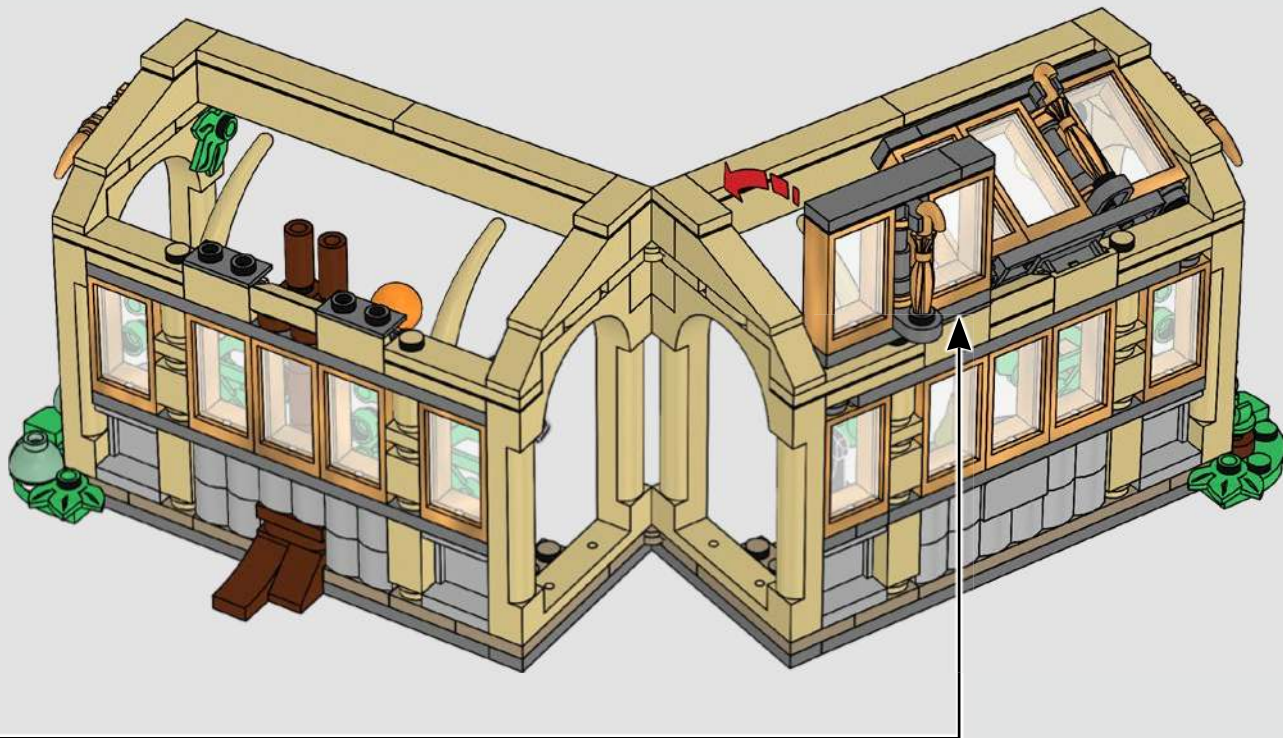

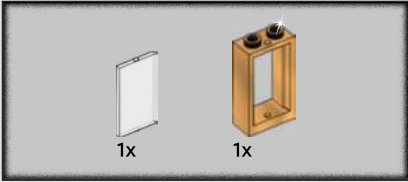

118

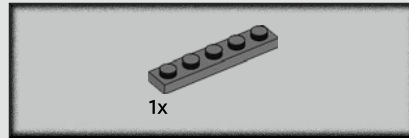
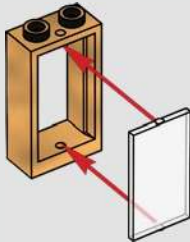

119

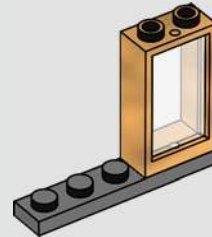

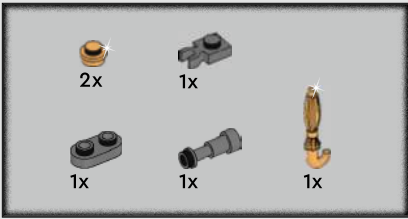

120

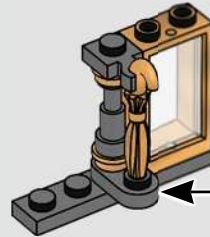
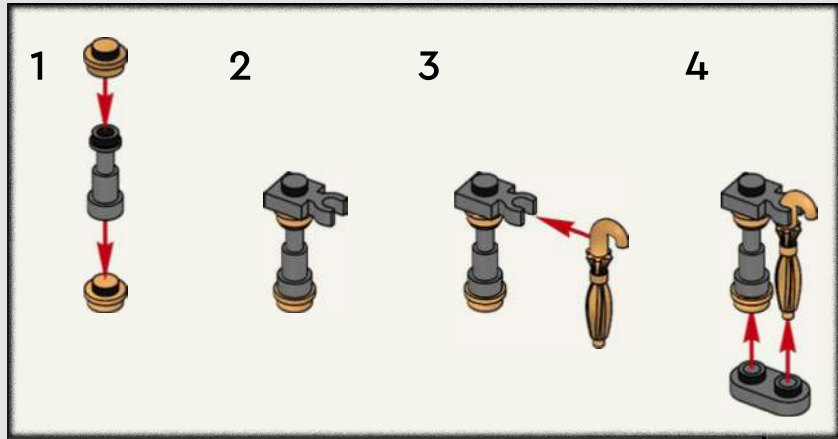

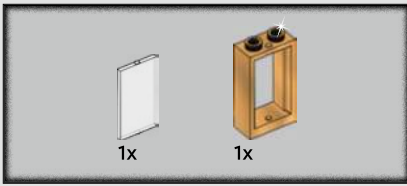

121

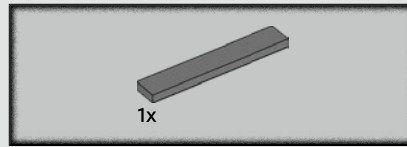
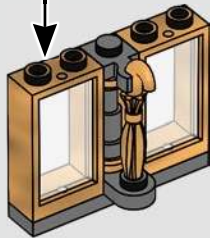
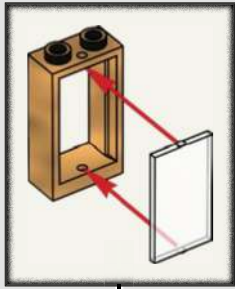

122

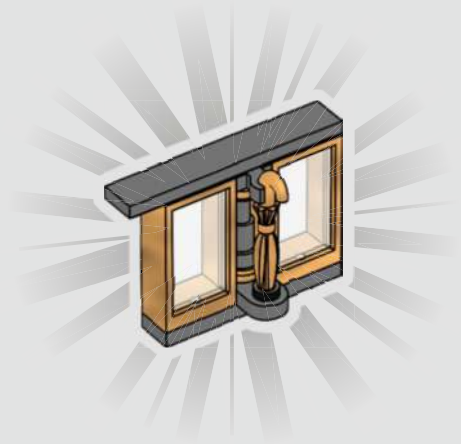

123



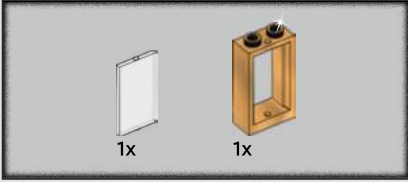

124

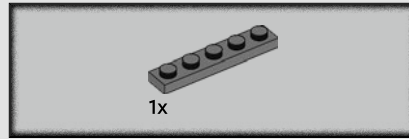
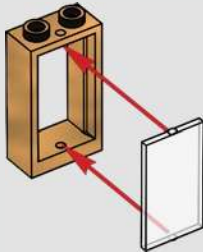

125

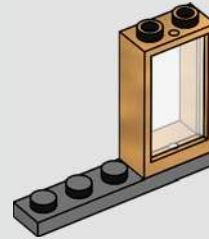

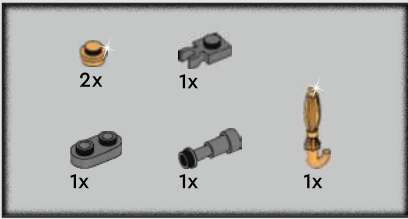

126

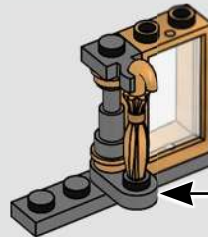
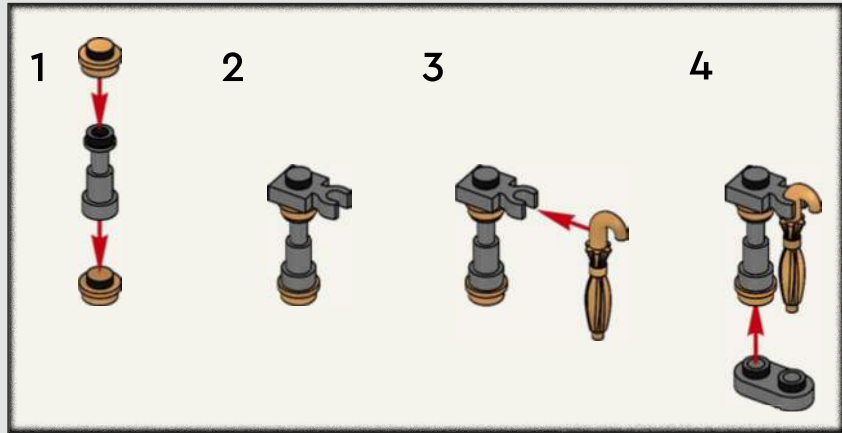

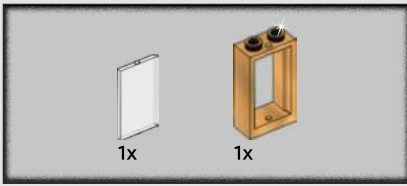

127

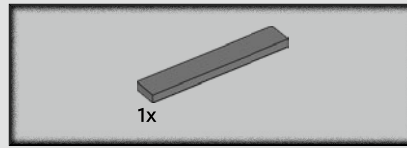
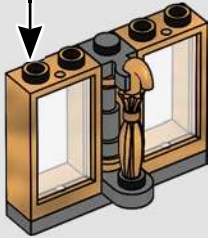
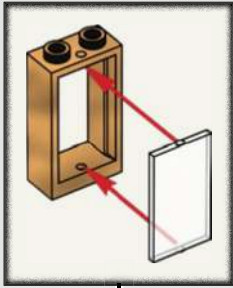

128

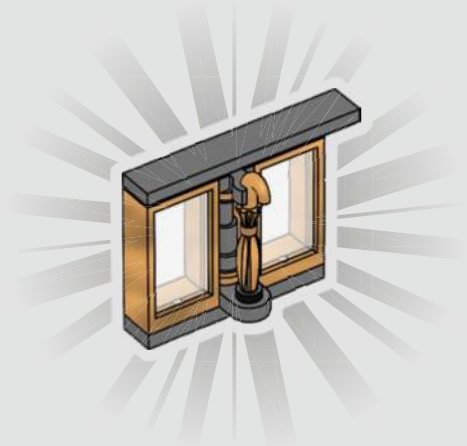

129

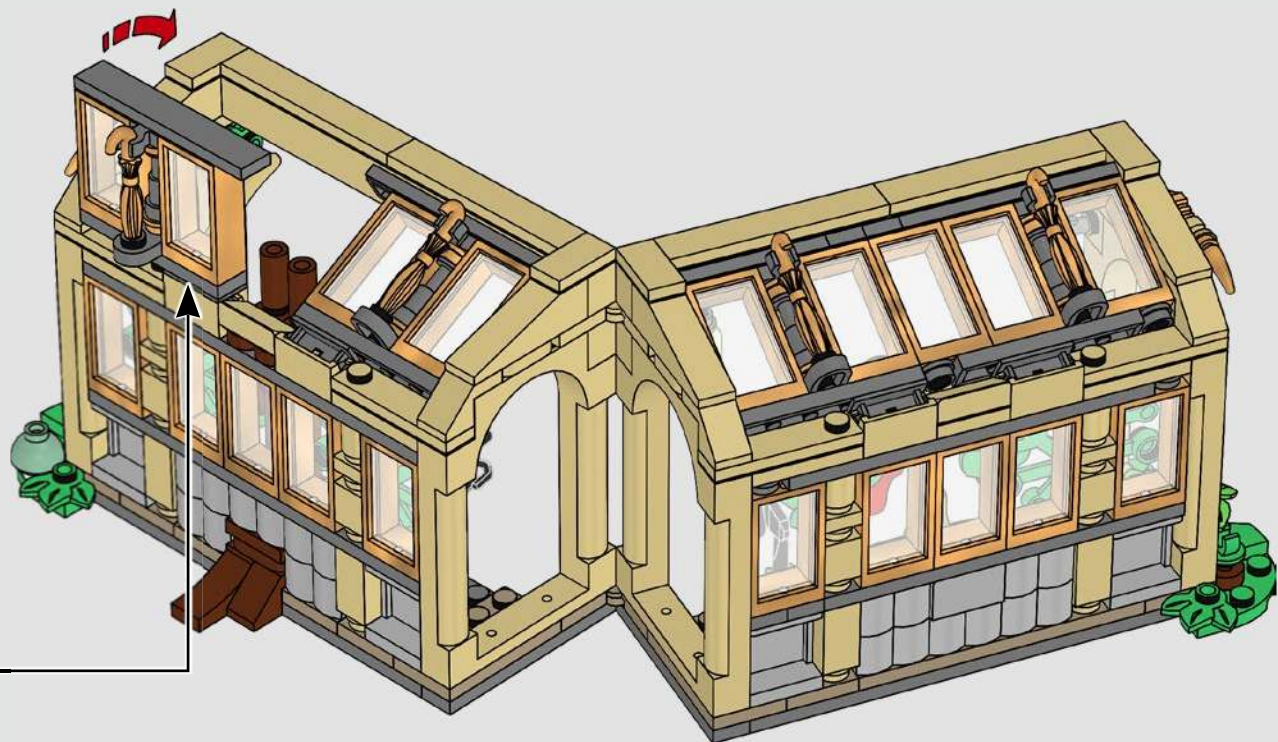



130

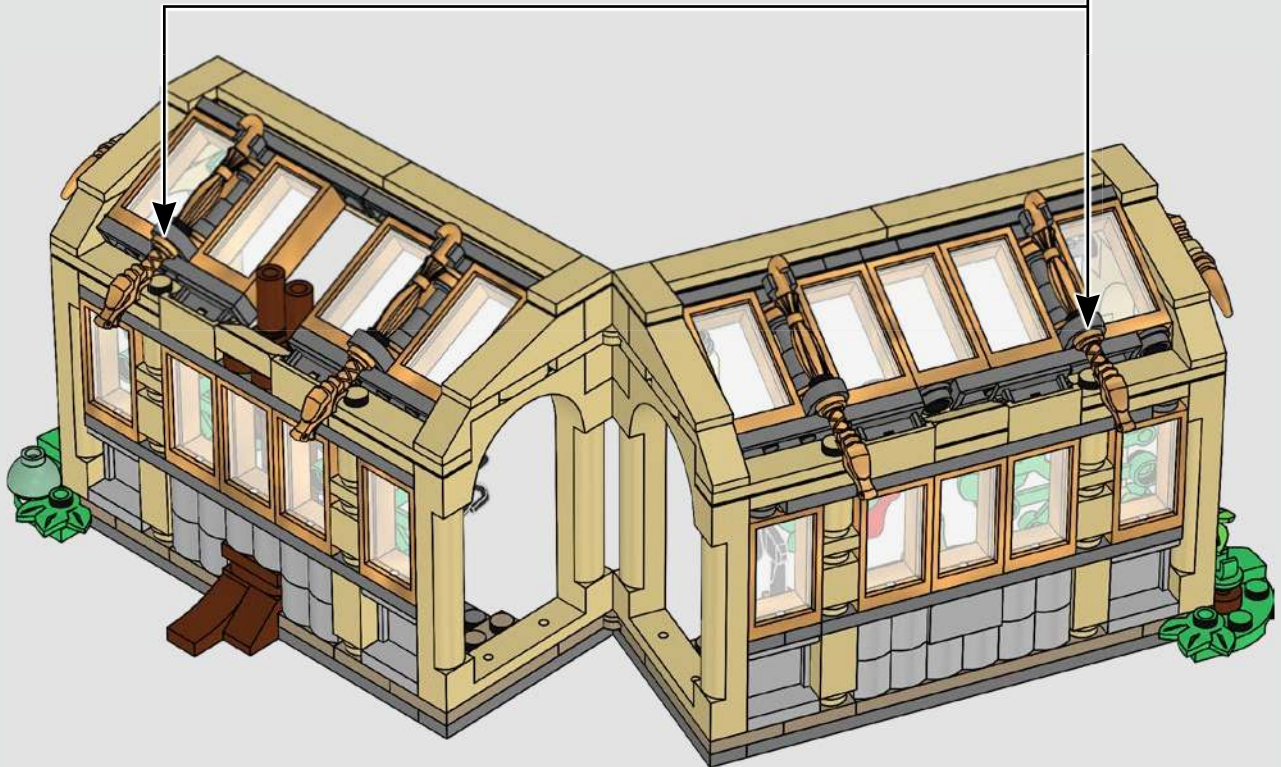



131

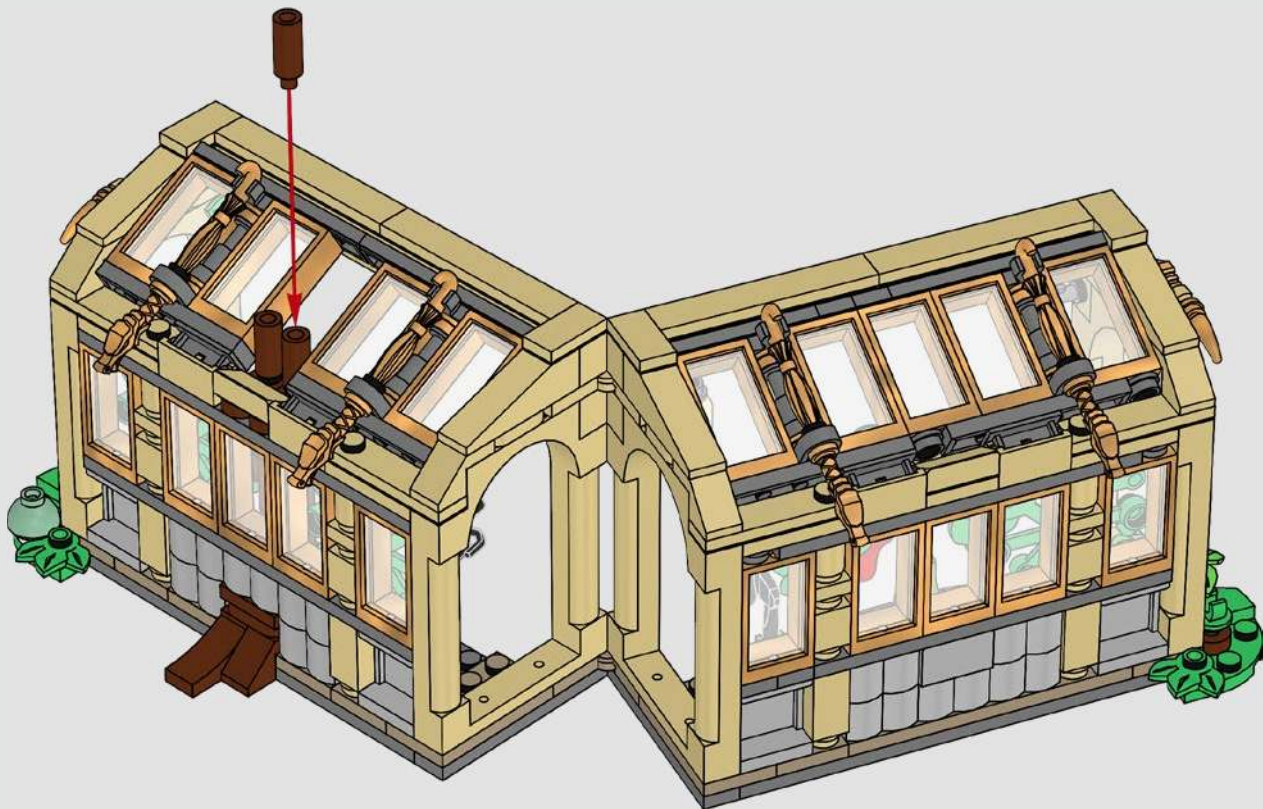

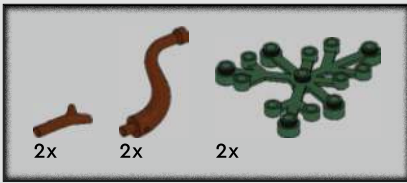

132

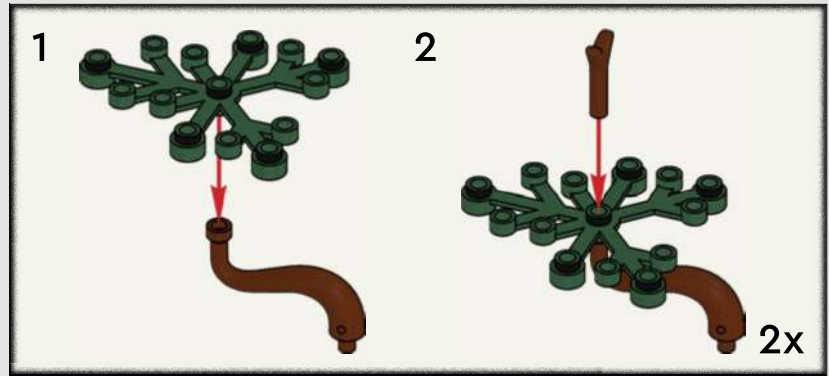







# Harry Potter



76435



76454



76426



# Build the most detailed HOGWARTS™ CASTLE



76447

Baue das detailreichste Schloss Hogwarts™ / Construisez le château de Poudlard le plus détaillé / Costruisci il Castello di Hogwarts™ più dettagliato di sempre / Construye el Castillo de Hogwarts™ más detallado / Construa o mais detalhado Castelo de Hogwarts™ / 拼搭精美的霍格沃茨™城堡 / Zbuduj najbardziej szczegółowy zamek Hogwart™ / Postavte si ten najdetailnejši Bradavický hrad / Postavte si najdetailnejši Rokfortský hrad / Építsd meg a legrészletgazdagabb Roxfort™ kastélyt! / Побудуйте найдетальніший замок Гогвортс / Construieste cel mai detaliat Castel Hogwart™ / Постройте най-детальнату версію на замка Хогвортс / Uzbúvte visdetalizetako Čukčárpas pili / Pane kokku kõige üksikasjalikum Sigarüüka™ loss / Sukonstruokite neraprustai detalią Hogwartso pilį



76445

Each set sold separately and available for different periods of time / Jedes Set ist separat und in unterschiedlichen Zeiträumen erhältlich. / Chaque set est vendu séparément et sera disponible à des périodes différentes. / Ogni set è venduto separatamente ed è disponibile per periodi di tempo diversi. / Cada set se vende por separado y está disponible durante un cierto período de tiempo. / Os sets são vendidos separadamente e estão disponíveis por diferentes períodos de tempo. / 每款套装于不同时间段单独出售。 / Zestawy są sprzedawane osobno i są dostępne w różnym czasie / Každá stavebnice se prodává samostatně a je k dispozici v různých časových obdobích / Každá stavebnice sa predáva samostatne a je k dispozícii v rôznych časových obdobiach / Minden egyes készlet külön-külön és más-más időszokban kapható. / Кожен набір продается окремо і доступний протягом різних періодів часу / Seturile se vând separat și sunt disponibile pentru perioade diferite de timp / Всеки комплект се продава отделно и е наличен за различен период от време. / Kats komplekts tiek pārdots atsevišķi, un to pieejamības periodi atšķiras. / Kõik komplektid on müügil eraldi ja saadaval erinevates ajavahemikes. / Kiekvienas rinkinys parduodamas atskirai ir tik ribotą laiką



# Harry Potter



76442

Baue das detailreichere Schloss Hogwarts™ / Construisez le château de Poudlard le plus détaillé / Costruisci il Castello di Hogwarts™ più dettagliato di sempre / Construye el Castillo de Hogwarts™ más detallado / Construa o mais detalhado Castelo de Hogwarts™ / 拼搭精美的霍格沃茨™城堡 / Zbuduj najbardziej szczegółowy zamek Hogwarts™ / Postavte si ten najdetailnejší Bradavický hrad / Postavte si najdetailnejší Rokfortský hrad / Építsd meg a legészletgazdagabb Roxfort™ kastélyt! / Побудуйте найдетальніший замок Гогвортс / Construieste cel mai detaliat Castel Hogwarts™ / Постройте най-детальнішу версію на замка Хогвортс / Uzbüve visdetalizetäko Cökkärpas pili / Pane kokku kõige üksikasjalikum Sigatüüka™ loss / Sukonstruokite neeparastai detaliä Högwartso pili

Each set sold separately and available for different periods of time / Jedes Set ist separat und in unterschiedlichen Zeiträumen erhältlich. / Chaque set est vendu séparément et sera disponible à des périodes différentes. / Ogni set è venduto separatamente ed è disponibile per periodi di tempo diversi. / Cada set se vende por separado y está disponible durante un cierto período de tiempo. / Os sets são vendidos separadamente e estão disponíveis por diferentes períodos de tempo. / 每款套装于不同时间段单独出售。 / Zestawy są sprzedawane osobno i są dostępne w różnym czasie / Každá stavebnice se prodává samostatně a je k dispozici v různých časových obdobích / Každá stavebnice sa predáva samostatne a je k dispozíci v rôznych časových obdobiach / Minden egyes készlet külön-külön és más-más időszakban kapható. / Кожен набір продається окремо і доступний протягом різних періодів часу / Seturile se vând separat și sunt disponibile pentru perioade diferite de timp / Всекі комплект се продава отделно и е наличен за различен период от време. / Kats komplekts tiek pārdots atsevišķi, un to pieejamības periodi atšķiras. / Kõik komplektid on müügil eraldi ja saadaval erinevates ajavahemikes. / Kiekvienas rinkinys parduodamas atskirai ir tik ribotą laiką



76454

Build the most detailed  
**HOGWARTS™ CASTLE**



























76441



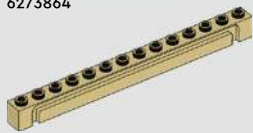

76431

76435

 6x 6206149  
 1x 4518400  
 12x 4161734  
 4x 4117070  
 4x 6232135  
 8x 4579260  
 4x 6212758  
 4x 6352222  
 2x 4624086  
 2x 4507055  
 4x 6174919  
 2x 6313119  
 4x 4114026  
 4x 6388196  
 1x 4140593  
 4x 4121921  
 2x 6550266  
 4x 6257600  
 4x 6058091  
 1x 6416525  
 4x 6529788  
 4x 4157277  
 4x 6273864  
 2x 6349727  
 1x 6206148  
 1x 6511041

 8x 614126  
 2x 6102341  
 2x 6195325  
 2x 6313116  
 1x 6234806  
 1x 383526  
 1x 4189009  
 2x 346026  
 4x 6135287  
 5x 6527025  
 4x 6510190  
 1x 6290602  
 1x 6290601  
 12x 6229130  
 2x 6062166

 2x 302028  
 3x 6266968  
 5x 6235080  
 3x 6519105  
 19x 6252258  
 2x 6286876  
 2x 6514467  
 1x 6514007  
 2x 6513997  
 2x 6307452  
 1x 6061678  
 1x 6361353  
 2x 6270031

 3x 6540475  
 2x 6546482  
 1x 4524098  
 9x 4528604  
 1x 6537493  
 1x 6540811  
 6x 6126075  
 1x 6458397  
 4x 4267874  
 1x 6156492  
 2x 6392975  
 2x 6266967  
 3x 6400309

1x  
6212040  
9x  
6422088  
2x  
6215659  
3x  
6186673  
6x  
6248944  
1x  
6306775  
2x  
6078605  
1x  
6403106  
2x  
6248854  
1x  
6261359  
2x  
6382326  
1x  
6236915  
4x  
4211152  
2x  
6452321  
1x  
4211189

2x  
4216945  
4x  
6284071  
2x  
4211475  
10x  
4550325  
4x  
4593679  
2x  
4211398  
1x  
6146223  
1x  
4244627  
2x  
4567448  
1x  
6105964  
4x  
4210633  
2x  
4210848  
4x  
6221607  
2x  
6388118

6x  
6296892  
4x  
6176400  
1x  
6092572  
4x  
6396412  
2x  
6265306  
1x  
4211053  
4x  
6413109  
3x  
4210651  
2x  
4211056  
2x  
4257526  
2x  
6133611  
2x  
4211067

2x  
4210706  
1x  
6550578  
2x  
6492195  
1x  
6236271  
1x  
6478295  
1x  
6540471  
2x  
6270109  
6x  
6224825  
4x  
6357947  
8x  
4523159  
1x  
6489198  
1x  
6245278  
19x  
6547883

1x  
6270032  
1x  
4535553  
1x  
6551658  
2x  
6492250  
1x  
6472547  
1x  
6539362

 [LEGO.com/service](https://www.LEGO.com/service)



YOU COULD **WIN**

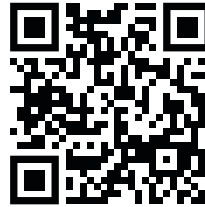

Scan this QR code or go to **LEGO.COM/PRODUCTFEEDBACK** and give us your short feedback about this LEGO® set for a chance to win a cool LEGO prize.

Terms and Conditions apply\*



**EN: YOU COULD WIN.** Terms and Conditions apply\* **DE: Du könntest GEWINNEN.** Es gelten die Teilnahmebedingungen\* **FR: Tu pourrais GAGNER.** Des conditions s'appliquent\* **IT: Potresti VINCERE tu.** Termini e condizioni sono applicabili\* **ES: Puedes GANAR.** Aplican términos y condiciones\* **PT: PODERÁ GANHAR.** Aplicam-se Termos e Condições\* **ZH: 轻松获奖. 条款和条件适用\*** **PL: Szansa na WYGRANĄ.** Obowiązuje regulamin\* **CS: Máte šanci VYHRÁT.** Platí všeobecné smluvní podmínky\* **SK: Máte šancu VYHRAŤ.** Platia všeobecné zmluvné podmienky\* **HU: TE IS NYERHETSZ.** Felhasználási feltételek érvényesek\* **UA: ВИ МОЖЕТЕ ВИГРАТИ.** Застосовуються загальні положення та умови\* **RO: Ai putea CÂȘTIGA.** Se aplică termeni și condiții\* **BG: Можете да СПЕЧЕЛИТЕ.** Има определени правила и условия\* **LV: Tu vari LAIMĒT.** Ir spēkā noteikumi un nosacījumi.\* **ET: Sul on võimalus VÕITA.** Kehtivad tingimused\* **LT: Jūs galite LAIMĖTI.** Taikomos sąlygos\* *\*LEGO.com/productfeedback-terms*

LEGO and the LEGO logo are trademarks of the LEGO Group. ©2025 The LEGO Group.

ALL HARRY POTTER characters and elements © & ™ Warner Bros. Entertainment Inc. Publishing Rights © JKR. (s25)

 6580943