

MANUALE D'USO

IMPASTATRICE

INSTRUCTION MANUAL

STAND MIXER

MANUEL D'UTILISATION

ROBOT PÂTISSIER

BEDIENUNGSHANDBUCH

KÜCHENMASCHINE

GEBRUIKSAANWIJZING

KEUKENMACHINE

MANUAL DE USO

AMASADORA

MANUAL DE UTILIZAÇÃO

BATEDEIRA

BRUKSANVISNING

KÖKSASSISTENT

РУКОВОДСТВО ПО ЭКСПЛУАТАЦИИ

TECTOMEC

BRUGERVEJLEDNING

RØREMASKINE

INSTRUKCJA OBSŁUGI

MIKSER

KÄYTTÖOPAS

YLEISKONE

BRUKSANVISNING

KJØKKENMASKIN

تاميل عتلا ليلد

خلاط عمودي

 smeg

Informazioni importanti per l'utente, Important information for the user, Informations importantes pour l'utilisateur, Wichtige Informationen für den Benutzer, Belangrijke informatie voor de gebruiker, Información importante para el usuario, Informações importantes para o utilizador, Viktig information för användaren, Важная информация для пользователя, Vigtig information til brugeren, Ważne informacje dla użytkownika, Tärkeitä tietoja käyttäjälle, Viktig informasjon for brukere, معلومات هامة للمستخدم



Avvertenze / Recommendations / Avertissements / Hinweise / Waarschuwingen / Advertencias / Advertências / Varningar / Меры предосторожности / Advarsler / Ostrzeżenia / Varoituset / Advarsler / تحذيرات



Descrizione / Description / Description / Beschreibung / Beschrijving / Descripción / Descrição / Beskrivning / Описание / Beskrivelse / Opis / Kuvaus / Beksrivelse / الوصف



Uso / Use / Utilisation / Gebrauch / Gebruik / Uso / Utilização / Användning / Использование / Anvendelse / Użytkowanie / Käyttö / Bruk / الإستعمال



Pulizia e manutenzione / Cleaning and care / Nettoyage et entretien / Reinigung und Wartung / Reiniging en onderhoud / Limpieza y mantenimiento / Limpeza e manutenção / Rengöring och underhåll / Чистка и техническое обслуживание / Rengöring og vedligeholdelse / Czyszczenie i konserwacja / Puhdistus ja hoito / Rengjøring og vedlikehold / التنظيف والصيانة



Avvertenza di sicurezza / Safety instructions / Consignes de sécurité / Sicherheitshinweise / Veiligheidswaarschuwingen / Advertencia de seguridad / Advertências de segurança / Säkerhetsvarning / Предупреждение о безопасности / Sikkerhedsanvisninger / Ostrzeżenie dotyczące bezpieczeństwa / Turvallisuuuteen liittyvät varoituset / Sikkerhetsadvarsler / تحذير للسلامة



Informazione / Information / Information / Information / Informatie / Información / Informação / Information / Информация / Information / Informacja / Tietoa / Informasjon / معلومات



Suggerimento / Advice / Conseil / Empfehlungen / Aanbeveling / Sugerencia / Sugestões / Råd / Рекомендация / Forslag / Porada / Neuvo / Forslag / اقتراحات



Scansiona il QR code per un accesso rapido al portale My Smeg Assistant

Scan the QR code for quick access to the My Smeg Assistant portal

Scannez le code QR pour un accès rapide au portail My SMEG Assistant

Für den schnellen Zugriff auf das Portal My Smeg Assistant scannen Sie einfach den QR-Code

Scan de QR-code voor de Handleiding voor Snelle Installatie en Onderhoud

Escanee el código QR para acceder rápidamente al portal My Smeg Assistant

Leia o Código QR para ter acesso rápido ao portal My Smeg Assistant

Skanna QR-koden för att snabbt öppna portalen My Smeg Assistant

Отсканируйте QR-код для быстрого доступа к portalу My Smeg Assistant

Scan QR-koden for hurtigt at få adgang til portalen My Smeg Assistant

Zeskanuj kod QR, aby uzyskać szybki dostęp do portalu My Smeg Assistant

Skannaa QR-koodi, jonka avulla pääset nopeasti My Smeg Assistant -portaaliin

Skann QR-koden for hurtig tilgang til portalen My Smeg Assistant

امسح رمز الاستجابة السريعة من أجل الوصول سريعاً إلى بوابة My Smeg Assistant

Gentile Cliente, La ringraziamo vivamente per il Suo acquisto. I nostri prodotti sono unici perché uniscono una spiccata ricerca estetica alla progettazione tecnica innovativa. Essi sono coordinati con altri prodotti in gamma e possono costituire elementi d'arredo e di design. Augurandole di apprezzare appieno le funzionalità del Suo elettrodomestico, Le porgiamo i nostri più cordiali saluti.

Dear Customer, Thank you for purchasing one of our appliances. Our products are unique because they combine iconic style with innovative technical solutions. They match perfectly with other products in our range and work equally well as a standalone design objects in your kitchen. We hope you enjoy using your new appliance! Best regards.

Cher client, merci beaucoup pour votre achat. Nos produits sont uniques car ils combinent une forte recherche esthétique avec une conception technique innovante. Ils sont coordonnés avec d'autres produits de la gamme et peuvent constituer des éléments d'ameublement et de design. En espérant que vous pourrez apprécier pleinement votre nouvel appareil électroménager, nous vous adressons nos meilleures salutations.

Sehr geehrter Kunde, wir danken Ihnen herzlichst für den Kauf. Unsere Produkte sind einzigartig, da sich in ihnen eine gewissenhafte Designforschung und eine innovative technische Planung vereinen. Sie sind mit anderen Produkten des Sortiments kombinierbar und stellen ausgefallene Einrichtungs- und Designgegenstände dar. Wir hoffen, dass Sie Ihr neues Haushaltsgerät voll und ganz schätzen werden und verbleiben mit freundlichen Grüßen.

Beste klant, hartelijk dank voor uw aankoop. Onze producten zijn uniek omdat ze esthetiek combineren met innovatief technisch ontwerp. De producten zijn uitstekend te combineren andere producten van het assortiment en kunnen worden gebruikt als meubel- en designelementen. We hopen dat u volop van uw nieuwe huishoudelijke apparaat zult genieten. Met vriendelijke groet

Estimado cliente, le damos las gracias por su compra. Nuestros productos son únicos porque combinan una notable búsqueda estética con un diseño técnico innovador. Se combinan con otros productos de la gama y se pueden utilizar como elementos de decoración y diseño. Le deseamos que pueda apreciar plenamente su nuevo electrodoméstico. Le enviamos nuestros saludos más cordiales.

Prezado cliente, Muito obrigado pela sua compra. Os nossos produtos são únicos porque combinam uma forte busca estética com um desenho técnico inovador. São coordenados com outros produtos da linha e podem constituir elementos de decoração e design. Esperando que possa desfrutar totalmente das funcionalidades do seu eletrodoméstico, enviamos-lhe os nossos melhores cumprimentos.

Bäste kund, vi vill tacka dig för ditt köp. Våra produkter är unika eftersom de kombinerar ett estetiskt nytänkande med innovativ teknik. Våra produkter passar med de andra i samma serie och kan användas som föremål inom heminredningen för att ge en särskild känsla av stil i ditt hem. Vi hoppas att du till fullo kommer att uppskatta funktionerna hos din hushållsmaskin. Med bästa hälsningar.

Уважаемый покупатель! Благодарим Вас за покупку. Наши изделия уникальны, поскольку они сочетают в себе великолепный дизайн и передовые технические решения. Кроме того, они комбинируются с другими изделиями из этой линейки и могут стать стильными элементами интерьера и дизайна. Надеемся, что Вы в полной мере оцените функциональные возможности Вашего бытового прибора. С наилучшими пожеланиями.

Kære Kunde, mange tak for dit køb. Vores produkter er unikke, da de forener æstetisk research og innovativt teknisk design. De passer perfekt sammen med de andre produkter i serien, og kan stå som et enkeltstående møbel af design. Vi håber, at du vil værdsætte din hårde hvidevares funktionalitet, og sender de bedste hilsener.

Szanowny Kliencie, Dziękujemy za Twój zakup. Nasze produkty są wyjątkowe, ponieważ łączą intensywne badania estetyczne z innowacyjnym projektem technicznym. Są one skoordynowane z innymi produktami z asortymentu i mogą stanowić elementy wyposażenia i wystroju. Mamy nadzieję, że będą Państwo mogli w pełni korzystać z funkcjonalności tego urządzenia. Serdecznie pozdrawiamy.

Arvoisa Asiakas, kiitämme sinua hankintasi johdosta. Tuotteemme ovat ainutlaatuisia, koska niissä yhdistyvät esteettisyys ja innovatiivinen tekninen suunnittelu. Ne sopivat yhteen muiden valikoimaan kuuluvien tuotteiden kanssa toimien samalla sisustus- ja design-tuotteina. Toivomme, että voit nauttia täysin siemauksin kodinkoneesi toiminnoista. Sydämellisin terveisin.

Kjære kunde. Vi takker for at dere valgte å kjøpe et av våre produkter. Våre produkter er unike fordi de forener søken etter estetikk med en nyskapende teknisk design. De koordineres med andre produkter i vårt sortiment og kan ha funksjon som både møbel- og designvare. Vi håper du får fullt utbytte av ditt husholdningsapparat, og sender deg våre beste hilsener.

تحتفظ جهة التصنيع بحقها في إجراء أية تغييرات تراها ضرورية لتحسين منتجاتها دون إخطار مسبق. لذا، تعتبر الرسوم التوضيحية والأوصاف الواردة في هذا الدليل غير ملزمة ولكنها إرشادية فقط.

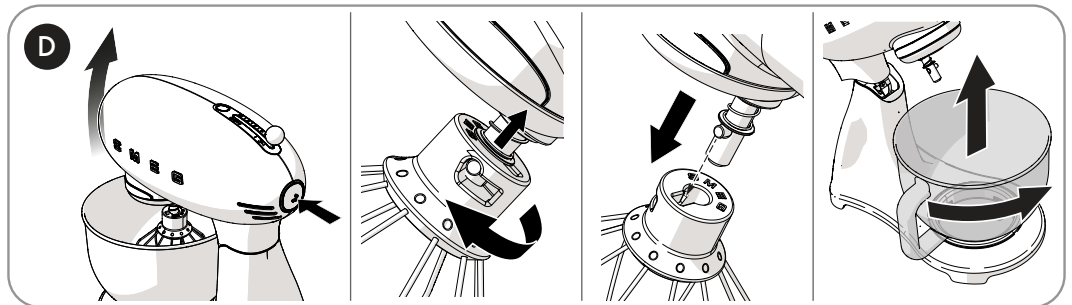
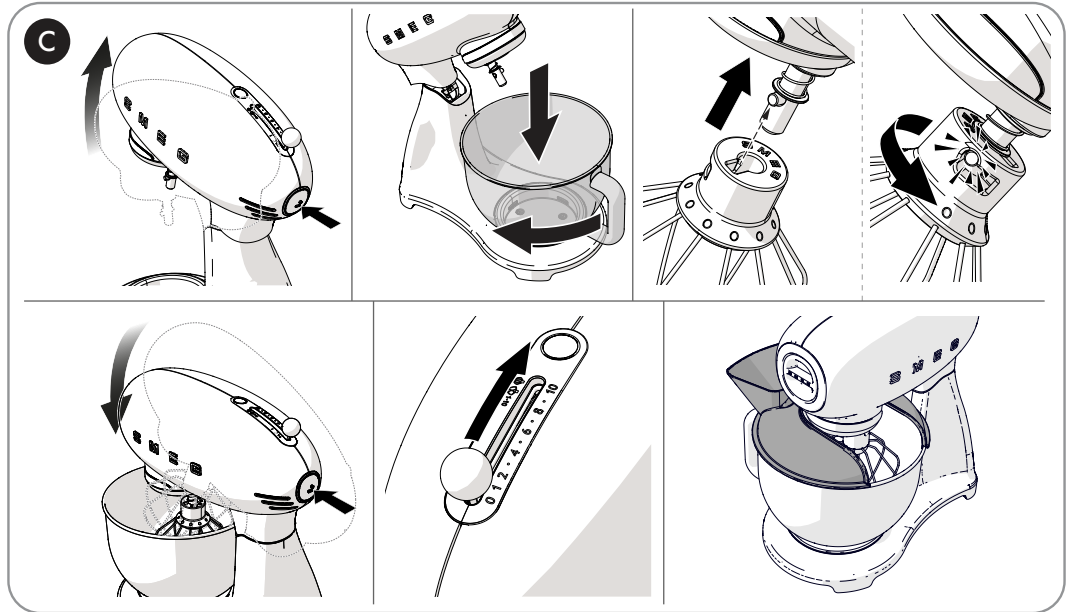
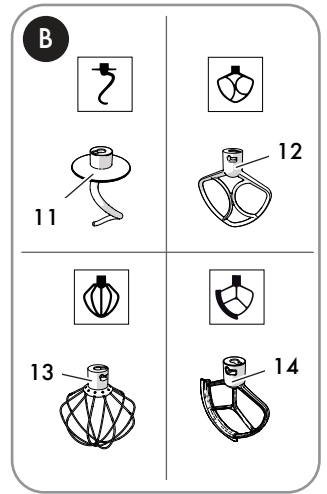
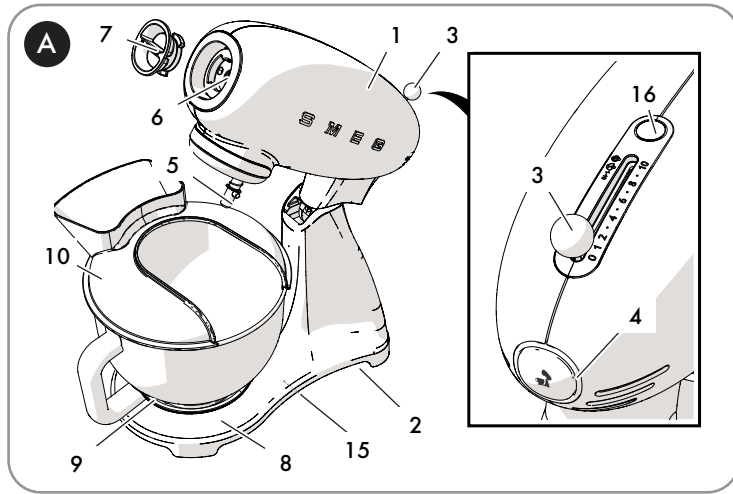



1 Safety

1.1 Essential safety information

Follow all safety instructions in order to use the appliance safely:

- Do not touch the plug with wet hands.
- Make sure that the socket is always accessible so that the plug can be removed whenever necessary.
- Do not immerse the appliance, the power cord or the plug in water or any other liquid.
- Do not use the appliance when the power cord or the plug is damaged or when the appliance has been dropped or is damaged in any manner.
- The cable is short to prevent accidents. Do not use an extension cord.
- Do not pull on the cord to unplug it from the power socket.
- Ensure the cord does not come into contact with sharp edges.

- This appliance is fitted with a ground connection for functional purposes only.
- If the appliance is faulty, do not attempt to repair it. Switch off the appliance, remove the plug from the power socket and contact Technical Support.
- If the supply cord is damaged, it must be replaced by the manufacturer, its service agent or similarly qualified persons in order to avoid a hazard.
- Keep the packaging material (viscose bags) out of the reach of children.
- Do not modify the appliance.
- Never try to put out a fire or flames with water: turn off the appliance, remove the plug from the power socket and smother the flames with a fire blanket or another appropriate cover.
- Do not leave the appliance unattended while it is operating.



Caution

In order to avoid a hazard due to inadvertent resetting of the thermal cut-out, this appliance must not be supplied through an external switching device, such as a timer, or connected to a circuit that is regularly switched on and off by the utility.



Instructions

- Make sure that the bowl is correctly positioned and locked onto its base before starting to use the appliance with its standard accessories.
- Do not release or remove the bowl while the appliance is operating.
- Do not insert, remove or replace the standard accessories with the safety lock disengaged (motor head lowered).
- Do not remove standard accessories while the appliance is in operation.
- Do not touch moving parts while the appliance is in operation. Keep hands, hair, clothing, spatulas and any other objects away from the mixer's standard and optional accessories to avoid personal injury or damage to the machine.
- Do not exceed the bowl's maximum capacity.
- Only use original standard and optional accessories provided by the manufacturer. The use of non-original components, standard and optional accessories could lead to personal injury or damage to the appliance.
- Do not place objects on top of the appliance.
- Do not place the appliance above or near lit hob burners or electric rings, inside an oven or near other heat sources.
- Make sure there are no foreign objects inside the appliance.
- Immerse the whisks into the bowl containing the ingredients before starting the appliance.
- This manual contains instructions for cleaning, maintenance and recommendations from the manufacturer to the customer. Any other interventions should be carried out by an authorised service centre.
- Instructions for cleaning of the appliance can be found in the "4 Cleaning and maintenance" section.
- This appliance shall not be used by children.
- Appliances can be used by persons with reduced physical, sensory or mental capabilities or lack of experience and knowledge if they have been given supervision or instruction concerning use of the appliance in a safe way and if they understand the hazards involved.
- Children must be supervised at all times to make sure they do not play with the appliance.



1.2 Connecting the appliance

Make sure that the voltage and frequency of the power supply correspond to those indicated on the data plate on the bottom of the appliance.

If the plug of the appliance is not compatible with the socket, contact Technical Assistance service for replacement.

- Children must never be allowed to play with this appliance.
- Keep the appliance and its cord out of the reach of children.
- Always unplug the appliance from the power socket if it is to be left unattended and before assembly, disassembly or cleaning.
- Switch off the appliance and unplug it from the mains before changing the accessories or when close to moving parts when in use.
- Off mode power <math><0.5W</math>.

1.3 Intended use

Failure to comply with the safety instructions and failure to read the instruction manual for the food processors can lead to the appliance being used incorrectly and cause personal injury.

- Do not use the appliance for purposes other than those for which it was designed. The mixer is intended exclusively to mix, whip, whisk and knead solid and liquid ingredients to make various preparations. With the addition of optional accessories, it is able to roll out and cut pasta into different shapes.
- The appliance is not designed to operate with external timers or with remote-control systems.
- Use the appliance indoors.
- This appliance is intended for household use and similar applications such as:
 - staff kitchen areas in shops, offices and other working environments;
 - bed and breakfast facilities / farm accommodation;
 - by guests in hotels, motels and other types of residential accommodation.
- Any other use, for example in restaurants, coffee bars and coffee shops is considered improper.

Information on power consumption in off/stand-by mode

Technical data on the appliance's power consumption in off/stand-by mode can be found at www.smeg.com under the page corresponding to the product in question.



Instructions

1.4 Manufacturer liability

The manufacturer declines any liability for personal injury or damage to property caused by:

- Use of the appliance other than the one envisaged
- Not having read the user manual
- Tampering with any part of the appliance
- Use of non-original spare parts
- Failure to comply with the safety instructions



Please keep these instructions carefully. If the appliance is passed on to others, they should also be given this instruction booklet.

These instructions can be downloaded from the Smeg website "www.smeg.com".

1.5 Disposal

Electrical appliances must not be disposed of together with household waste.



Appliances marked with this symbol are subject to European Directive 2012/19/EU.

- All waste electrical and electronic appliances must be disposed of separately from domestic waste and taken to authorised waste disposal facilities. Disposing of the used appliance correctly will help to safeguard the environment and human health. For further information regarding the disposal of used appliances, please contact your local authority waste disposal department or the shop where the appliance was purchased.



2 Appliance description (Fig. A and B)

- 1) Motor head
- 2) Body
- 3) Speed selector
- 4) Head raising/lowering release button
- 5) Lower attachment for standard accessories
- 6) Front attachment hub for optional accessories
- 7) Front hub cover
- 8) Bowl base
- 9) Bowl**
- 10) Pouring shield*
- 11) Dough hook
- 12) Flat beater
- 13) Wire whisk
- 14) Flex edge beater*
- 15) Identification plate

2.1 Identification plate (Fig. A)

The identification plate (15) bears the technical data, serial number and brand name of the appliance. Do not remove the identification plate for any reason.

* Standard only on certain models. Also available as an optional accessory.

** The bowl design and material may be different depending on model of mixer

2.2 Before first use



Caution

Plug into an earthed three-pin socket.

- Do not remove the earth prong.
- Do not use an adapter.
- Do not use an extension cord.
- Failure to follow these instructions could result in death, fire, or electrical shock.

- Unpack the appliance carefully and remove all packaging materials and any labels and stickers.
- Clean the body and head of the appliance with a damp cloth.
- Remove the bowl and standard accessories. Wash and dry them thoroughly (see section "4 Cleaning and maintenance").



Before use, make sure that all the components are intact.



Description

2.3 Description of accessories (Fig. A and B)

Aluminium dough hook (11)

For slowly combining, mixing and kneading leavened dough type mixtures including bread, pasta, pizza, etc.

Aluminium flat beater (12)

For combining, mixing, and starting all mixing procedures.

For preparing cake batters and pastries, biscuits, icing, etc. and for other, thicker batters and mixes

Stainless-steel wire whisk (13)

For beating, mixing, whisking, whipping ingredients such as butter, egg whites, cream etc.

Also ideal for preparing creams, custards, sauces, etc.

Flex edge beater* (14)

Aluminium beater with flexible silicone edge.

Useful for mixing doughs and soft batters. The silicone edge ensures that ingredients are scraped off the sides of the bowl during processing, making them easier to incorporate and ensuring a perfect texture.

Pouring shield* (10)

For protecting against splattering and to facilitate the addition of ingredients when in use. Only suitable for use with the stainless steel bowl*.



The standard and optional accessories intended to come into contact with food are made of materials that comply with the provisions of current legislation.



Caution

The spring lift motor head must always be locked in the horizontal position when lifting and moving the mixer or when inserting the optional accessories in the front section.

* Standard only on certain models. Also available as an optional accessory.



3 Use

3.1 Using the mixer (Fig. A, B and C)

- Place the mixer on a flat, stable and dry surface.
- Press the release button (4) and lift the head (1), guiding it with your hand until it is fully locked.
- Insert the bowl (9) in its base (8). Grasp the bowl by its handle and turn the bowl (9) clockwise until it locks into place.
- Select the accessory required based on the type of mixing to be performed.



Caution

Do not operate the mixer with the accessory without having locked the bowl in position.

- Insert the accessory into the lower attachment (5) and push it upwards. Keep pressing the accessory upwards and turn it anticlockwise until the pin locks fully into place (5).



Ensure that the accessory is correctly locked into place in the attachment.

- Add the ingredients to the bowl.
- Press the button (4) and lower the head (1), guiding it with your hand until it is fully locked.
- Position the pouring shield* (10) on the bowl, if required, with the opening facing outwards.



Using the pouring shield* (10)

- Fit the pouring shield onto the upper rim of the stainless steel bowl* after having inserted the bowl into its base, inserted the accessory into the lower attachment and after having lowered the head into the operating position.
- Fit the pouring shield with the opening facing outwards so that ingredients can be added to the bowl without having to stop the mixer.



Caution

Remove the pouring shield to raise or lower the head with the accessory fixed to the lower attachment.

- Make sure that the speed selector (3) is in the "0" (OFF) position.
- Insert the plug into the power socket.
- Select the required speed (3) to start the appliance and begin mixing the ingredients. See "3.5 Recommended speeds".

* Standard only on certain models. Also available as an optional accessory.



Caution

- For increased safety, each time power is disconnected to the motor, for example by raising the head or unplugging the appliance from the socket, the speed selector first has to be placed in the zero position before the mixer is restarted.
- You should anyway always move the speed selector to the 0 (OFF) position before pressing the button to move the motor head.



Caution

- Do not touch the accessories while the appliance is in operation.
- Do not operate the mixer with the accessory inserted and the bowl empty.



It is possible for the motor head to move slightly when mixing or kneading dense mixtures or large quantities. This should be considered normal and will not compromise the operation or long lifetime of the appliance.

3.2 When finished (Fig. B and D)

- Place the speed selector (3) in the "0" (OFF) position and remove the plug from the power socket.
- Remove the pouring shield (10) from the bowl, if present.
- Press the release button (4) to raise the head (1), guiding it with your hand until it is fully locked.
- Push the accessory slightly upwards and turn it clockwise to release it from the pin. Remove the accessory from the lower attachment (5).
- Remove the bowl (9) from its base by turning it anticlockwise to release it.



3.3 Functions

Safety lock system

The appliance has a safety system which automatically shuts off the appliance when the motor head is raised.

Smooth Start System

When the appliance is started, the speed is gradually increased until the set speed is reached. This prevents damage to the appliance and accessories and ensures that ingredients are not ejected from the bowl.



Planetary movement

The mixer accessories move with a planetary mixing action.

The movement is generated by the accessory rotating around its axis in the opposite direction to the rotary movement of the mixer.

This maximises coverage of the entire bowl so that all ingredients are thoroughly blended with excellent results for all preparations.



Hot appliance

Following prolonged use, the upper part of the motor head may heat up. This is not, however, normally indicative of a malfunction.

3.4 General advice

- Never exceed the maximum speed and capacity indicated in the table in order to prevent damage to the appliance.
- Turn on the appliance at a low speed until all the ingredients are mixed, then increase the speed on the basis of the required operation.
- When adding ingredients, always pour them onto the edge of the bowl and not directly onto the moving accessory.
- Reduce the speed when you add dry or liquid ingredients to stop them splattering. Increase the speed again when they have been mixed.
- Use the pouring shield* on the bowl for liquid mixtures or when adding dry ingredients to avoid getting objects in the vicinity of the stand mixer dirty or being hit by splattered liquids or powder.
- Keep the bowl and accessories clean, and attach them to the appliance only when they are perfectly dry.
- Clean the head and body of the mixer carefully using a damp cloth if they are dirty.

* Standard only on certain models. Also available as an optional accessory.



Use

Tips for whisking egg whites

- For the best results, use egg whites at room temperature.
- Before whisking the egg whites, ensure that the accessory and bowl are not damp or greasy and that they have no trace of yolk on them.
- To prevent splattering, gradually increase the speed up to the recommended speed, then whisk until you achieve the required stiffness.
- The stand mixer allows very rapid whisking of egg whites. Pay close attention to the process to avoid over-whisking the egg whites, which would result in separation.

Tips for whipping cream

- For the best results, use cold whipping or double cream straight out of the fridge.
- To prevent splattering, gradually increase the speed up to the recommended speed, then whip until you achieve the required consistency.
- When whipping a litre of liquid cream, it is advisable to gradually increase the speed to 7-8 for the first minute, or at least until the cream begins to thicken. Then increase the speed to 10 for the remaining time.

Recommendations for kneading

- Make sure that the proportion of liquids in doughs is sufficient (at least 55-60% of the quantity of flour, by weight). Doughs which are too dry and therefore stiff can overload the motor.
- If the appliance is struggling, switch it off, divide the dough into two pieces and knead them separately.

Bread/pizza dough and egg pasta dough

- Start the appliance at speed 1 until the ingredients have been incorporated, then increase to speed 2.
- To mix the ingredients more effectively, it is recommended to add the liquid ingredients to the bowl first and then gradually add the solid ingredients.
- Egg pasta, bread, pizza: only knead using the dough hook. DO NOT use the flex edge beater*.

Prepared cake batters

- For up to 1 kg of batter: start the appliance at a low speed until the ingredients start to come together, then gradually increase the speed up to 7 for the remaining time.
- For up to 2 kg of batter: start the appliance at speed 1 until the ingredients start to come together, then gradually increase the speed up to 3-4 for the remaining time.

Pastry

- Cold ingredients should always be used when making pastry, particularly short pastes, unless the recipe states otherwise.
- When preparing cakes, initially beat butter at room temperature with sugar, then add the eggs and finally the flour.

* Standard only on certain models. Also available as an optional accessory.







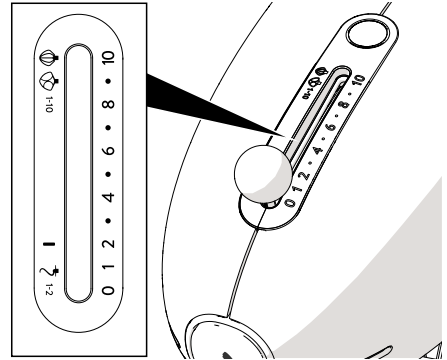

3.5 Recommended speeds



The speed selector (3) indicates the most appropriate accessory to use with the selected speed. The speeds indicated in the table are approximate and can vary depending on the recipe and the interaction of the different ingredients used.



EN





Speed setting	Function	Accessory
LOW 1 - 2	COMBINING AND KNEADING Kneading - preparing leavened doughs (bread, pizza, egg pasta etc.), see "Bread/pizza dough and egg pasta dough".	
LOW 1 - 3	COMBINING Combining ingredients.	  
MEDIUM 4 - 7	MIXING Mixing and beating dense batters. Beating eggs and butter, cake mixes such as fruit cake.	 
HIGH 8 - 10	WHIPPING AND WHISKING Whisking light or dense batters. Whipping cream, egg whites or sauces.	

* Standard only on certain models. Also available as an optional accessory.



Use

Accessories and recommended speeds, maximum capacity for model SMF04

Accessory	Preparation	Speed	Time	Min/max capacity
	Egg whites	8-10	2-3 min	2 - 12 ⁽¹⁾
	Cream	8-10	2-3 min	100 ml/1000 ml
 or 	Prepared cake batters	1-7	3-4 min	2 kg total batter (max. 1 kg flour)
	Pastry	1-7	3-4 min	2.6 kg total batter (max. 1 kg flour)
	Bread/ pizza dough	1-2	4 min	1.9 kg total dough (max. 1.2 kg flour/ min. 55% hydration)
	Egg pasta dough	1-2	5-7 min	500 g total batter (max. 300 g flour/ min. 55% hydration)

⁽¹⁾ Average egg size: 53-63 g

* Standard only on certain models. Also available as an optional accessory.







**The table should be taken as a guideline only.
The speed and capacity depend on the accessory used, the quantity of
mixture in the bowl and the ingredients used.**

Use



Accessories and recommended speeds, maximum capacity for model SMF05/SMF15

Accessory	Preparation	Speed	Time	Min/max capacity
	Egg whites	8-10	2-3 min	2 - 12 ⁽¹⁾
	Cream	8-10	2-3 min	100 ml/1000 ml
 or 	Prepared cake batters	1-7	3-4 min	2 kg total batter (max. 1 kg flour)
	Pastry	1-7	3-4 min	2.8 kg total batter (max. 1 kg flour)
	Bread/ pizza dough	1-2	4 min	2.1 kg total dough (max. 1.3 kg flour/ min. 55% hydration)
	Egg pasta dough	1-2	5-7 min	800 g total batter (max. 500 g flour/ min. 55% hydration)

⁽¹⁾ Average egg size: 53-63 g



The table should be taken as a guideline only. The speed and capacity depend on the accessory used, the quantity of mixture in the bowl and the ingredients used.

EN



Cleaning and maintenance

4 Cleaning and maintenance

This manual contains instructions for cleaning, maintenance and recommendations from the manufacturer to the customer. Any other interventions should be carried out by an authorised service centre.

Before cleaning, ALWAYS remove the plug from the mains and allow the appliance to cool down. Never immerse the motor base (2) in water or other liquids.



Splattered liquids or batters should be removed immediately using a soft, damp, cotton cloth.



Caution

- Do not use steam jets to clean the appliance.
- Do not use cleaning products containing chlorine, ammonia, bleach or alcohol on steel parts or parts with a metallic finish.
- Do not use harsh or abrasive detergents (e.g. powder products or stain removers).
- Do not use rough or abrasive materials or sharp metal scrapers.
- Regularly clean the components and accessories after each use.

- The dough hook, flat beater, flex edge beater*, the pouring shield* and stainless steel bowl* are dishwasher safe.
- The wire whisk can be hand washed with a neutral detergent and a soft sponge.
- The glass bowl* can be washed by hand with warm water and a neutral detergent or in a dishwasher using a low temperature (maximum 50° C) program.
- The ring nut at the base of the bowl can be removed and washed separately by hand using a neutral detergent and a soft sponge.

* Standard only on certain models. Also available as an optional accessory.

What to do if...

Problem	Cause	Solution
The motor does not start.	The motor has overheated.	Disconnect the mixer from the power and leave the motor to cool.
	The plug is not properly inserted in the power socket.	Insert the plug into the power socket. Do not use adaptors or extensions. Check that the house main breaker is on.
	The cable is defective.	Have the cable replaced at an Authorised Service Centre.
	Lack of power.	Check that the house main breaker is on.
The appliance vibrates.	The head has been raised during operation.	The safety lock system has operated. Move the speed selector to 0 (OFF), press and hold down the button on the rear to release the head and lower it.
	The mixer is not resting on a stable surface.	Place the mixer on a flat, stable surface.
	The anti-slip rubber feet are worn.	Have them replaced at an Authorised Service Centre.
	The speed has been set too high or the load is excessive.	Set a lower speed and ensure the bowl has not been overfilled.
	The bowl has not been correctly locked into its base.	Check that the bowl is correctly locked into its base.

What to do if...

	The lower attachment has come loose over time.	Have the mixer checked and adjusted at an Authorised Service Centre.
The accessories hit the sides of the bowl.	The accessory or the bowl is not correctly locked into position.	Move the speed selector to 0, press the button on the rear of the appliance to raise the head and check that the accessory is correctly locked into position in the lower attachment and the bowl is correctly locked into position on the base.
The accessory is struggling to turn inside the bowl.	The dough mixture is too thick and is stopping the accessory from turning.	Add water or other liquid to loosen the dough mixture.
	The bowl is too full.	Remove half the bowl's contents and work it separately.



If the problem has not been resolved or in the event of another type of fault, contact your local technical support centre.

For all models:

Compliance with clause 11 of directive EN IEC 60335 was verified by making the following preparation:

Accessory: Hook

Recipe: 1500g flour +900g water

Speed: 1-10

Operation time: 5 minutes

Il costruttore si riserva di apportare senza preavviso tutte le modifiche che riterrà utili al miglioramento dei propri prodotti. Le illustrazioni e le descrizioni contenute in questo manuale non sono quindi impegnative ed hanno solo valore indicativo.

The manufacturer reserves the right to make any changes deemed necessary for the improvement of its products without prior notice. The illustrations and descriptions contained in this manual are therefore not binding and are merely indicative.

Le fabricant se réserve la faculté d'apporter, sans préavis, toutes les modifications qu'il jugera utiles pour l'amélioration de ses produits. Les illustrations et les descriptions figurant dans ce manuel ne sont pas contraignantes et n'ont qu'une valeur indicative.

Der Hersteller behält sich vor, ohne vorherige Benachrichtigung alle Änderungen vorzunehmen, die er zur Verbesserung seiner Produkte für nützlich erachtet. Die in diesem Handbuch enthaltenen Illustrationen und Beschreibungen sind daher unverbindlich und dienen nur zur Veranschaulichung.

De fabrikant behoudt zich het recht voor zonder waarschuwing alle wijzigingen aan te brengen die hij nodig acht om zijn producten te verbeteren. De afbeeldingen en de beschrijvingen die aanwezig zijn in deze handleiding zijn niet bindend, en hebben enkel een aanduidende waarde.

El fabricante se reserva el derecho a aportar sin aviso previo todas las modificaciones que considere útiles para la mejora de sus propios productos. Las ilustraciones y las descripciones contenidas en este manual no son vinculantes y tienen solo valor indicativo.

O fabricante reserva-se o direito de efetuar, sem aviso prévio, qualquer modificação que vise o melhoramento dos respetivos produtos. As ilustrações e descrições contidas neste manual não são, por isso, vinculativas e possuem apenas valor indicativo.

Tillverkaren förbehåller sig rätten att genomföra alla de ändringar som anses nödvändiga för att förbättra de egna produkterna utan att meddela detta i förväg. De illustrationer och beskrivningar som finns i aktuell manual är därmed inte bindande utan endast indikativa.

Для улучшения выпускаемой продукции изготовитель оставляет за собой право вносить без предварительного предупреждения любые изменения, которые он сочтет целесообразными. Рисунки и описания, содержащиеся в данном руководстве, не являются обязывающими и носят ознакомительный характер.

Fabrikanten forbeholder sig retten til, uden varsel, at udføre alle de ændringer, der vurderes nyttige for at forbedre egne produkter. Tegningerne og beskrivelserne i denne manual er derfor kun vejledende og ikke bindende.

Producent zastrzega sobie prawo do nanoszenia, bez uprzedniego powiadomienia, wszelkich zmian, które uzna za stosowne w celu ulepszenia swoich produktów. Rysunki i opisy zawarte w niniejszej instrukcji nie są zobowiązujące i mają jedynie charakter orientacyjny.

Valmistaja pidättää itsellään oikeuden tehdä ohjeisiin mielestään tarpeellisia muutoksia ilman ennakkoilmoitusta. Tässä oppaassa olevat kuvat ja piirrookset eivät näin ollen ole sitovia, vaan ne annetaan vain viitteellisessä mielessä.

Produsenten forbeholder seg rett til å foreta endringer på sine produkter grunnet tekniske fremskritt, uten forutgående varsel. Illustrasjonene og beskrivelsene i denne bruksanvisningen er derfor ikke bindende og skal kun betraktes som retningsgivende.

عملينا العزيز، شكراً لك على شراء أحد أجهزتنا. تعد منتجاتنا فريدة لأنها تجمع بين الأسلوب المميز والحلول التقنية المبتكرة. وهي تتناسب تمامًا مع المنتجات الأخرى في مجموعتنا وتعمل بنفس القدر كتصميمات قائمة بذاتها في مطبخك. نأمل أن تستمتع باستخدام هذا الجهاز الجديد! وتفضلوا بقبول وافر الاحترام والتقدير.