

URC7145 SIMPLE SET UP GUIDE

ENGLISH

KEY TABLE

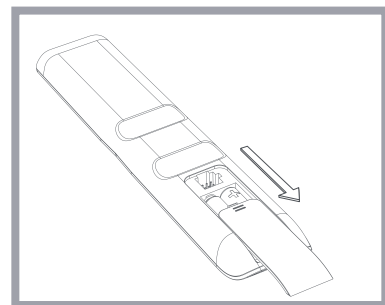
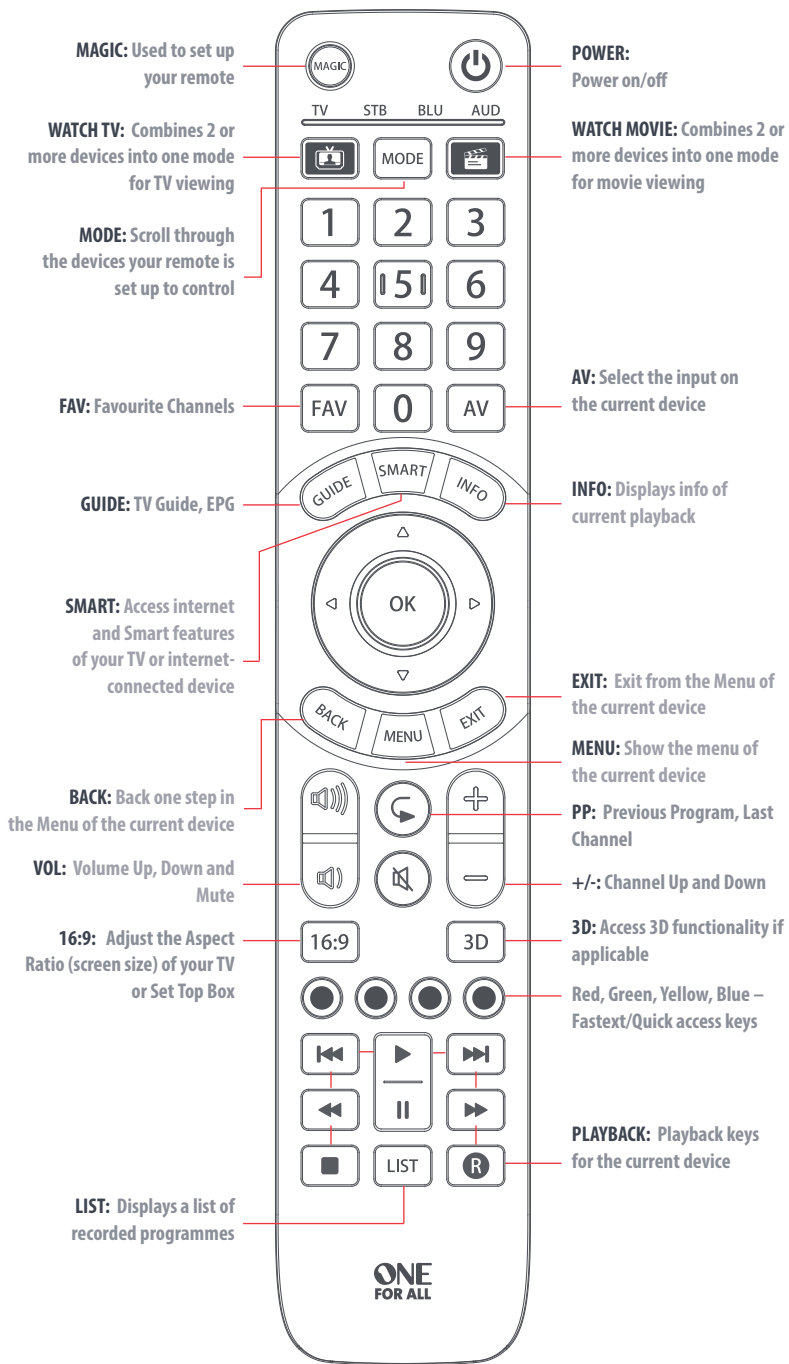

Open the battery door.

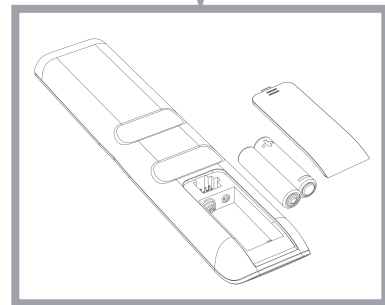

Insert 2 AAA batteries.

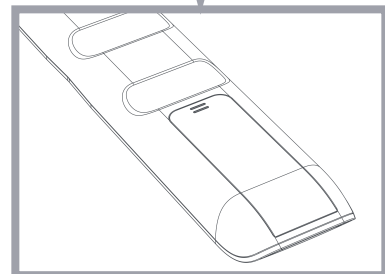

Thank you for purchasing the One For All 4. Now you can control all of your Audio/Video devices with a single remote, while enjoying extra features such as the ability to combine devices in a single Activity Mode, sending multiple commands on a single key press (macros) and being able to customise the remote control to your exact requirements. To get started with your new remote, the first step is to set it up to control all of your Home Cinema devices.

HOW TO SET UP YOUR REMOTE

A – SIMPLESET

SimpleSet is a quick and easy way of setting up the remote to control the most popular brands of each device type with only a few key presses, typically in under a minute per device. The first step is to select which device you are going to set up. The following is a list of Device Modes on the remote control, and the Device types that can be set up on that mode:

TV	STB	BLU	AUD
----	-----	-----	-----

Device Mode

TV

Type of device

TV, HDTV, LED, LCD, Plasma, Projector

STB

Set Top Box, Satellite Receiver, Cable Converter, Freeview, DVB-T, IPTV

BLU

Blu-ray, DVD, DVD Home Cinema

AUD

Audio, AV Receiver, Amplifier, Tuner, Sound Bar

For each Device type, there is a list of the top brands, each with a number assigned to it, for example 6 for a Samsung TV. Locate your device and brand in the list that follows:

TV

- | | |
|--------------------------|-----------------|
| 1 Alba / Bush / Goodmans | 6 Samsung |
| 2 Grundig | 7 Sharp |
| 3 LG | 8 Sony |
| 4 Panasonic | 9 TCL / Thomson |
| 5 Philips | 0 Toshiba |

STB: Sat, Cable, DVB-T

- | | |
|---|--|
| 1 BSkyB / Sky Ireland / Orange | 6 Humax |
| 2 Canal+ / CanalSat / Digital+ | 7 Samsung |
| 3 Dream Multimedia / TechniSat | 8 Sky Italia / SFR / Neuf TV |
| 4 DStv / Multichoice / Foxtel / Sky New Zealand | 9 Sky Deutschland / Österreich / T-Home / Deutsche Telekom |
| 5 Freebox / Tricolor TV / Vu+ | 0 UPC / Cablecom / UPC Direct / Virgin Media |

HOW TO SET UP YOUR REMOTE

A – SIMPLESET

BLU: Blu-ray, DVD

- | | |
|------------------------|-----------|
| 1 Denon, Harman/Kardon | 6 Pioneer |
| 2 JVC | 7 Samsung |
| 3 LG | 8 Sony |
| 4 Panasonic | 9 Toshiba |
| 5 Philips | 0 Yamaha |

AUD: AV Receiver, Amp, Tuner, Sound Bar

- | | |
|------------------------|---------------------|
| 1 Denon | 6 Philips / Marantz |
| 2 Harman/Kardon / JBL | 7 Pioneer |
| 3 LG / JVC | 8 Samsung |
| 4 Onkyo | 9 Sony |
| 5 Panasonic / Technics | 0 Yamaha |

To set up your device

- Turn on your device (not on standby) and point the OFA remote towards it.
 - Hold down MAGIC until the LED under the device blinks twice. The LED under the current device will stay lit.
 - Press the MODE key repeatedly until the LED for the device you want to set up is lit.
 - Hold down the digit for your brand and device as listed above (e.g. 6 for Samsung TV).
 - The remote will send Power every 3 seconds until your device switches off.
 - As soon as your device switches off, release the digit.
 - The LED will blink twice and go out. The remote should now operate your device.
- If you find one or more keys do not work as you expect, start again at step 1 – the remote will start with the next code in the memory.

HOW TO SET UP YOUR REMOTE

B – SET UP BY CODE

If your brand is not listed in section A, you can set up your device by trying codes individually. To do this:







- Turn your device on (not on standby).
 - Locate the brand of your device in the code list (pages 146-157). Codes are listed by Device Type and Brand.
 - Hold down MAGIC until the LED under the device blinks twice. The LED under the current device will stay lit.
 - Press the MODE key repeatedly until the LED for the device you want to set up is lit.
 - Enter the first 4 digit code listed for your brand (e.g. 0556 for a Bennett TV).
 - The LED will blink twice and go out.
 - Now aim the remote towards your device and press the POWER key.
 - If the device turns off, your remote is ready to use. If not, repeat steps 3-7 with the next code in the list.
- Some codes are quite similar. If you find that one or more keys do not operate as you expect, try again from step 3 with the next code in the list.

LEARNING

Your One For All remote control can learn any function from any other working remote control. This can be useful if you are missing one or more functions from your original remote control and would like to add them to the ONE FOR ALL. You can learn onto any key except MAGIC or MODE. You can also learn a complete device if you can't find a code.

To learn, firstly make sure you have all your original remote controls to hand, and that they have working batteries in. To learn functions, the original remote should be approximately 3cm from the OFA remote, pointing towards it as shown below:



-  Hold down MAGIC until the LED under the device blinks twice. The LED under the current device will stay lit.
-  Press the MODE key repeatedly until the LED for the device you want to learn functions on is lit.
-  Press 975 – the LED will blink twice.
-  Press and release the key you want to learn a function onto (for example the 3D key) – The red LED will blink continuously.
-  Press and release the key on the original remote.
- The LED will blink twice to indicate the key has been learned correctly.
- Repeat steps 4 and 5 for each key you want to learn – remember you can learn from multiple remotes, but only one function per key.
-  When you learned all the functions you require, press and hold the MAGIC key until the LED blinks twice and turns off.

HINTS

- If the LEDs shows one long blink at step 6, the function was not learned correctly, please try again from step 4.
- If you find one or more keys don't work properly after set up, you can re-enter the learning mode at any time by repeating the procedure from step 1.

TO DELETE A LEARNED FUNCTION, THE PROCEDURE IS:

- Hold down MAGIC until the LED under the device blinks twice. The LED under the current device will stay lit.
- Using the MODE key, make sure the LED for the device you want to delete functions from is lit.
- Press 976 – the LED will blink twice
- Press the key to delete twice – the LED will blink twice.

Repeat the above procedure for each key you want to delete.

ACTIVITIES

An Activity is a grouping of two or more devices into a single mode based upon what you're doing while using your remote, for example TV and Set Top Box can be combined together into a Watch TV mode. In this mode keys will control only the relevant device, so in this example the Volume keys would control the TV, but the channel keys would control the Set Top Box.

The ONE FOR ALL features 2 Activity Modes; Watch TV and Watch Movie. Each of these modes has a choice of devices to combine. These are:

Watch TV

Combination 1:
Combination 2:
Combination 3:
Combination 4:

TV + STB
TV + STB + AUD
TV + AUD
TV only





Watch Movie

Combination 1:
Combination 2:
Combination 3:
Combination 4:

TV + BLU
TV + BLU + AUD
TV + AUD
TV only



If you set the default devices for any Activity on the remote (for example a TV and STB for Watch TV) that Activity will be set up automatically on the remote. If you would like to change to a different combination, the procedure is as follows:

-  Hold down MAGIC until the LED under the device blinks twice. The LED under the current device will stay lit.
-  Press the Activity key you want to set up (e.g. Watch TV).
-  Press the number of the combination you want to set – e.g. 3 For TV + AUD in Watch TV.
- The LED will blink twice and go out.

To access the Activities, simply press the ACTIVITY key. You can return to controlling by device by using the MODE key.

AV Shift

As the AV key is intended to select the input on your TV and most TVs use a menu to select from a list of inputs, when the AV key is pressed in an Activity, the Menu Up, Down, Left, Right and OK keys temporarily control the TV. If the OK key is pressed, or no key is pressed for ten seconds, these keys will revert to controlling the relevant device for the Activity (e.g. STB in Watch TV Mode).

Power Macro





If you hold down the Power key for 2 seconds in any Activity, the remote will send the Power function for each device contained within that Activity. So for example, holding Power in the default setting for Watch TV will turn both the TV and Set Top Box on or off.

MACROS

PROGRAM A MACRO

You can program any key on your OFA remote (except MAGIC or MODE) to send multiple commands on a single press – a Macro. This can be useful for controlling multiple devices to put them in a certain state – for instance you could put your TV on HDMI 1 and press Play on the Blu-ray player to start watching a movie. A key programmed with a Macro will send the same Macro regardless of the device mode.



To program a macro, the procedure is as follows:

-  Hold down MAGIC until the LED under the device blinks twice. The LED under the current device will stay lit.
-  Press 995 – the LED will blink twice.
- Next select the key you want to program the Macro on.
-  Now use the MODE key to select the device you want the first function of the Macro to come from, for example TV.
-  Next, press the key you want to include in the Macro, for example the AV key.
- Repeat steps 4 (if necessary) and 5 to add more keys to the Macro. You can include up to 15 key presses .
-  To store the Macro, hold down the MAGIC key until the LED blinks twice.

- Remember to press the keys in the same order you would using your original remotes – so if you pressed AV on the TV remote and then Play on the Blu-ray remote to watch a movie, do it in the same order on the One For All remote.
- If the LED shows a long blink when you press a key in steps 4 or 5, you have entered too many keys, please try again.

DELETING A MACRO

If you want to remove a macro from a key, please perform the following:

-  Hold down MAGIC until the LED under the device blinks twice. The LED under the current device will stay lit.
-  Press 995 – the LED will blink twice.
- Press the key the macro is programmed on.
-  Now hold down the MAGIC key until the LED blinks twice – the Macro is deleted.

MACROS

MACROS ON ACTIVITIES

Another handy feature of the ONE FOR ALL is to put Macros on Activities; you could for example program the Watch TV Activity to send a Macro to turn on the TV and Set Top Box when selected. To do this, simply press the desired Activity key (e.g. Watch TV) step 3 of the procedure "Program a Macro".

If you want to delete a Macro from the Activity, select it during step 3 of "Deleting a Macro".

VOLUME LOCK

If you always use one device to control volume, for example your TV or an AV Receiver, you can set up the One For All to always control that device, regardless of which device your remote is controlling. To do this:

- Hold down MAGIC until the LED under the device blinks twice. The LED under the current device will stay lit.
- Press 993 – the LED will blink twice.
- Use the MODE key to select the Device you want to lock the Volume to.
- Press MAGIC once – the LED will blink twice and volume is now locked.

If there is one particular device you would like to exclude from the Volume Lock (and control its own volume), you can do this by the following:

- Hold down MAGIC until the LED under the device blinks twice. The LED under the current device will stay lit.
- Press 993 – the LED will blink twice.
- Use the MODE key to select the Device you remove from Volume Lock.
- Press VOLUME DOWN – the LED will blink twice and device is now removed.

To unlock the volume and set every device back to controlling its own volume, the procedure is:

- Hold down MAGIC until the LED under the TV key blinks twice. The LED under the current mode key will stay lit.
- Press 993 – the LED will blink twice.
- Press VOLUME UP – the LED will blink twice and Volume is now unlocked.

Please note that Volume Lock only applies in Device Mode – Activities are unaffected.

PRODUCT DISPOSAL

(EUROPEAN DIRECTIVE 2002/96/EC)

The crossed out wheeled bin symbol on this product ensures that this product is manufactured using high quality components that can be recycled and reused according to European Directive 2002/96/EC. Please do not dispose this product with your normal household waste but inform yourself about the local separate collection for electrical and electronic products to dispose this product correctly. This will help preventing potential negative effects on the environment and/or human health.

BATTERY DISPOSAL and safety

(EUROPEAN DIRECTIVE 2006/66/EC)

Please do not dispose your batteries with your normal household waste but inform yourself about the local separate collection for empty batteries to dispose them correctly. This will help preventing potential negative effects on the environment and/or human health. Keep batteries away from fire, out of direct sunlight, and away from other sources of heat.

UNIVERSAL ELECTRONICS INC/ONE FOR ALL warrants to the original purchaser that this product will be free from defects in materials and workmanship under normal and correct use for a period of one (1) year from the date of original purchase. This product will be replaced free of charge if it has been proven to be defective within the one (1) year warranty period. This warranty does not cover cartons, carrying cases, batteries, broken or marred cabinets or any other item used in connection with the product. Any further obligation than listed above is excluded. Please notice that we need your purchase receipt so that we may establish your eligibility for service. If you have bought this product for purposes which are not related to your trade, business or profession, please remember that you may have legal rights under your national legislation governing the sale of consumer goods. This guarantee does not affect those rights.

UK
www.oneforall.com

New Zealand
0800 1425569
sales@amber.co.nz
www.amber.co.nz
www.oneforall.com

Ireland
www.oneforall.com

South Africa
0861100551
support@oneforall.co.za
www.connoisseur.co.za
www.oneforall.com

Australia
1 300 888 298
ofa.support@ambertech.com.au
www.ambertech.com.au
www.oneforall.com