



REAL GEAR FOR REAL GAMERS

COUGAR Gaming case



PANZER MAX-G

THE ULTIMATE COMPUTER CASE

Assembly Drawing

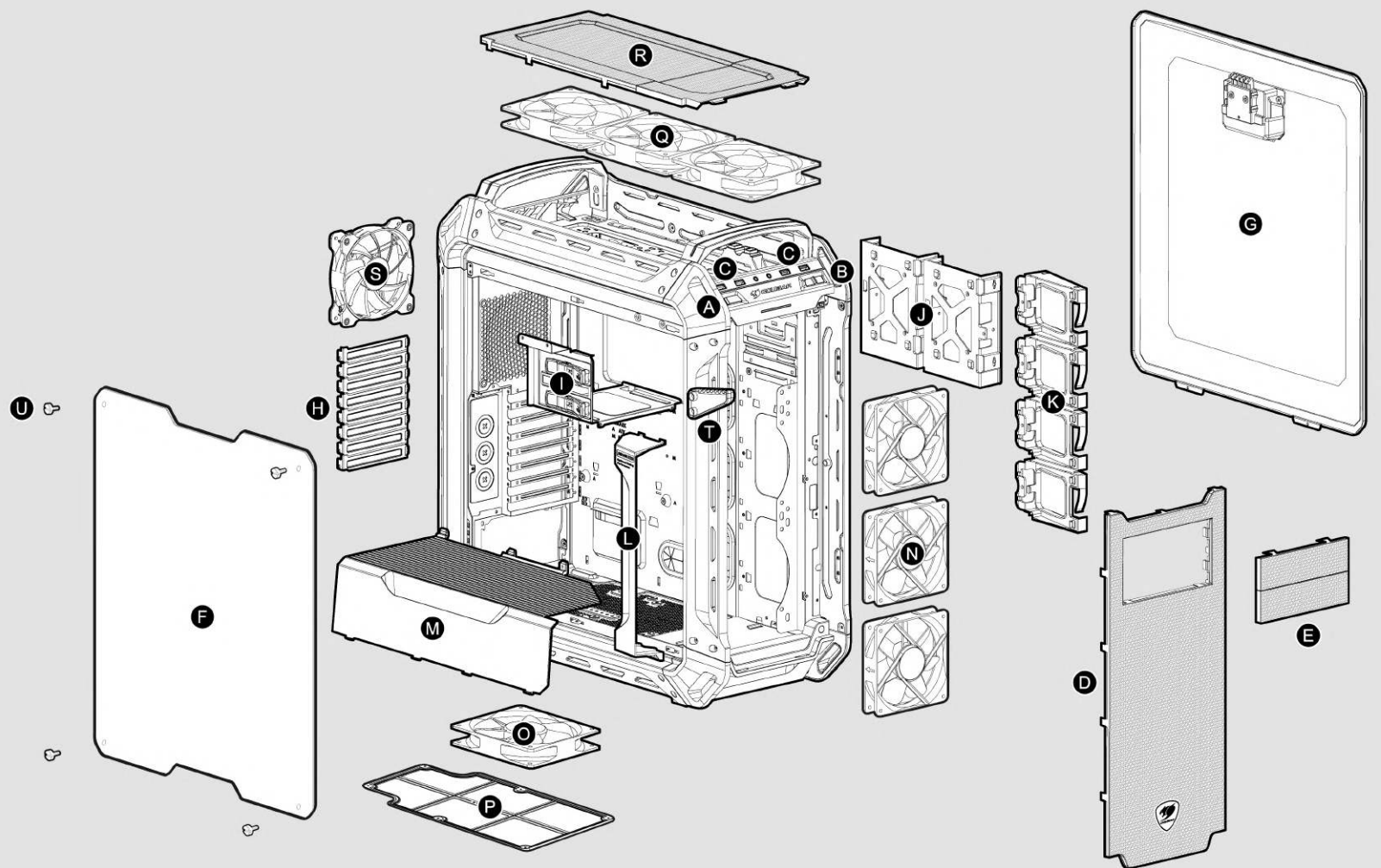

Accessory Kit

1			Power Supply Screws	X 4
2			MBD/HDD screws	X 16
3			SSD screws	X 20
4			ODD screws	X 8
5			Short fan screws	X 16
6			Headphone hook screws	X 2
7			Shockproof rubber washers for top fans	X 4
8			Cable Ties	X 4
9			Water cooling orifices	X 3
10			Headphone hook	X 1
11			Fan connection splitter	X 2
12			Stand-off	X 2

- A** Power button / Reset button
- B** Fan controller
- C** USB 3.0 / USB 2.0 / HD audio ports
- D** Removable front panel
- E** Removable 5.25" cover
- F** Tempered glass left panel
- G** Right side cover

- H** Vented slot cover
- I** 5.25" device bays (tool-less)
- J** 3.5" HDD trays (compatible with 2.5" HDD/SSD)
- K** 2.5" HDD trays
- L** Air Guide
- M** Power supply cover
- N** 3 x 140/120mm fans for front panel (optional, purchased separately)

- O** 1 x 140/120mm fan for bottom panel (optional, purchased separately)
- P** Air filter on bottom cover to prevent dust from entering the power supply
- Q** 2 x 140mm / 3 x 120mm fans for top panel (optional, purchased separately)
- R** Top panel
- S** 1 x 120mm fan for rear panel (pre-installed)
- T** Headphone hook
- U** Thumb screws

Removing the left tempered glass panel

Removing the right side panel

1 Removing the front cover and installing/removing 5.25" devices

2 Removing a water cooler (top)

3 Removing a water cooler (front)

4 Installing an internal 3.5" HDD

5 Installing an internal 2.5" device

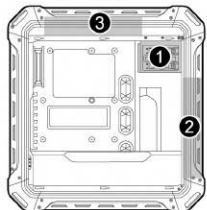
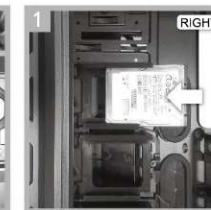
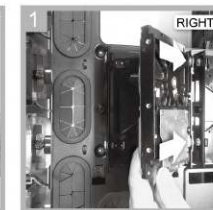
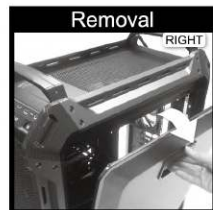

LEFT SIDE



RIGHT SIDE

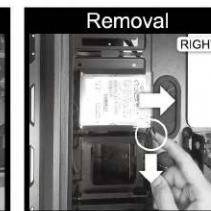
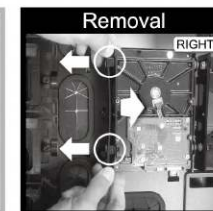
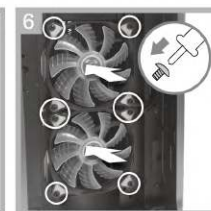
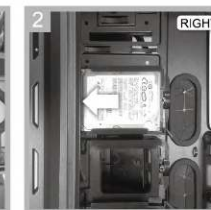
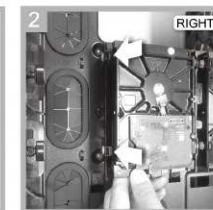
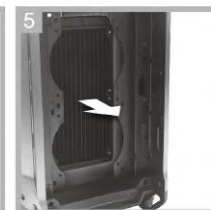
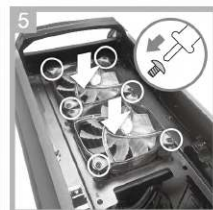
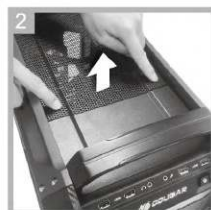
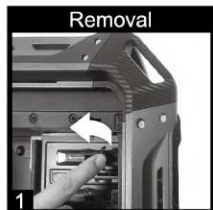

1 Removing the 2.5" device tray

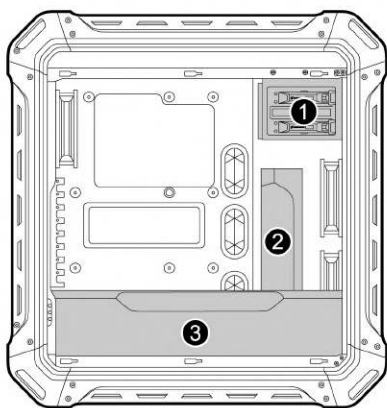
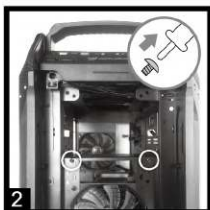
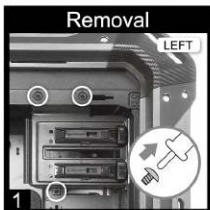

LEFT SIDE

2 Removing the Air Guide

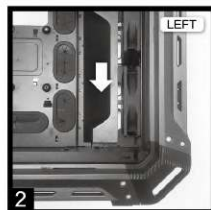
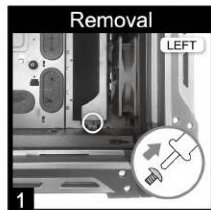

3 Installing/removing the power supply cover

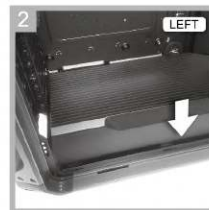
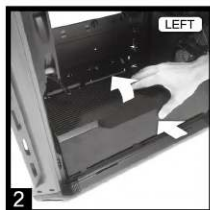
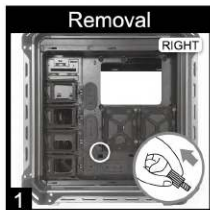

Removing the headphone hook

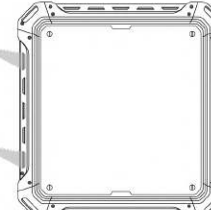
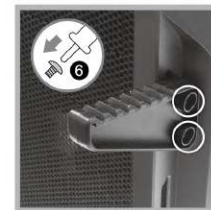

Through the use of splitters (2 included, 3 maximum), up to 8 fans can be connected

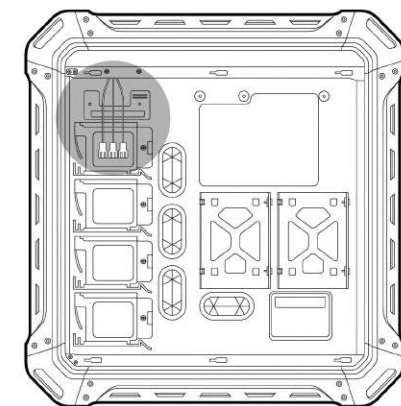

RIGHT SIDE

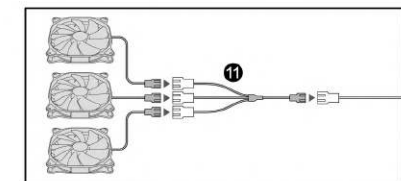

Fan cable max current loading is 1A