



**LEGO**

Booklet available in English on  
Livret disponible en français sur  
Folleto disponible en español en

[LEGO.com/service/buildinginstructions](https://www.LEGO.com/service/buildinginstructions)

## FLOWER BOUQUET

● We hope this set of LEGO® flowers will offer you a relaxing and rewarding building experience, and provide you with a bright, joyful and distinctive display piece.

## LE BOUQUET DE FLEURS

● Nous espérons que cet ensemble de fleurs LEGO® vous apportera une expérience de construction relaxante et enrichissante, et vous procurera une superbe décoration réjouissante et unique.

## RAMO DE FLORES

● Esperamos que este set de flores LEGO® te proporcione una experiencia de construcción relajante y gratificante que dé lugar a una pieza de exhibición llamativa, alegre y singular.

## ROSE/ROSA (Rosa)

● With hundreds of species and thousands of variations, the rose is the most famous of flowers. The name stems from the Latin *rosa*, and they are cultivated around the world for their colorful beauty and fragrance. There are over 60 LEGO® elements in our version of the rose and the outer petals can be adjusted depending on how much you want them to bloom.

● Avec des centaines d'espèces et des milliers de variations, la rose est la plus célèbre des fleurs. Son nom provient du latin *rosa*, et elle est cultivée dans le monde entier pour sa beauté colorée et son parfum. Notre version de la rose compte plus de 60 éléments LEGO® et les pétales extérieurs peuvent être ajustés en fonction de la floraison souhaitée.

● La rosa, de la que existen cientos de especies y miles de variedades, es la más famosa de las flores. Su nombre deriva del latín *rosa* y se cultiva en todo el mundo por su vistosa belleza y su exquisita fragancia. Nuestra versión de la rosa se compone de más de 60 elementos LEGO® y los pétalos exteriores se pueden ajustar en función del grado de floración deseado.



## SNAPDRAGON/GUEULE-DE-LOUP/BOCA DE DRAGÓN

(*Antirrhinum*)

● Native to rocky areas of Europe, the US and North Africa, the Snapdragon's memorable name stems from its alleged resemblance to the head of a dragon, especially when the open 'mouth' is squeezed closed. Sturdy LEGO® Technic™ elements hold this LEGO flower's heavy head steady, while the blossoms are reproduced in 3 different hues.

● Endémique des régions rocheuses de l'Europe, des États-Unis et de l'Afrique du Nord, la gueule-de-loup doit son nom à sa ressemblance à une gueule lorsqu'on pince les côtés de la fleur. De robustes éléments LEGO® Technic™ maintiennent la lourde grappe de fleurs LEGO, qui sont reproduites en 3 teintes différentes.

● Nativa de las regiones rocosas de Europa, EE. UU. y el norte de África, la boca de dragón debe su inolvidable nombre a su supuesta semejanza con la cabeza de un dragón (en especial, cuando la "boca" está cerrada y se abre presionándola). Varios elementos LEGO® Technic™ de gran resistencia mantienen estable la pesada cabeza de esta flor LEGO, rematada con flores reproducidas en 3 tonos diferentes.



## LAVENDER/LAVANDE/LAVANDA (*Lavandula*)

- Cultivated widely as an ornamental plant, Lavender is also used as a culinary herb and for the extraction of essential oils. Our interpretation of this flower is created from 117 LEGO® elements and includes a sand green stem, reddish-brown stalks, golden leaves and lavender-colored flowers.
- Largement cultivée comme plante ornementale, la lavande est également utilisée comme herbe culinaire et pour l'extraction des huiles essentielles. Notre interprétation de cette fleur est créée à partir de 117 éléments LEGO® et comprend une tige vert terreux, des pédoncules brun rougeâtre, des feuilles dorées et des fleurs couleur lavande.
- Generalmente cultivada como planta ornamental, la lavanda se usa también como hierba culinaria y para la extracción de aceites esenciales. Nuestra interpretación de esta flor está creada a partir de 117 elementos LEGO® e incluye un tallo verde arena, pedúnculos café rojizo, hojas doradas y flores lavanda.



## ASTER (*Asteraceae*)

● Named from the ancient Greek word for star, there are around 180 species of this popular flower in the same family. They bloom in late summer and early autumn and their bright colors make them particularly attractive to pollinators such as birds, bees and butterflies. There are 67 elements in this LEGO® Aster, almost all of them closely clustered together in the spectacular bloom.

● Nommée d'après le mot en grec ancien signifiant « étoile », cette populaire famille de fleurs compte environ 180 espèces. Elles fleurissent à la fin de l'été et au début de l'automne, et leurs couleurs vives les rendent particulièrement attrayantes pour les pollinisateurs tels que les oiseaux, les abeilles et les papillons. Cet aster LEGO® comporte 67 éléments qui sont presque tous agglutinés dans la spectaculaire fleur.

● Llamada así por la palabra del griego antiguo que significa *estrella*, existen alrededor de 180 especies de esta popular flor en la misma familia. Florece a finales de verano y principios de otoño, y sus brillantes colores la hacen particularmente atractiva para los polinizadores (pájaros, abejas y mariposas). El aster LEGO® consta de 67 elementos, casi todos estrechamente agrupados para representar su espectacular florecimiento.

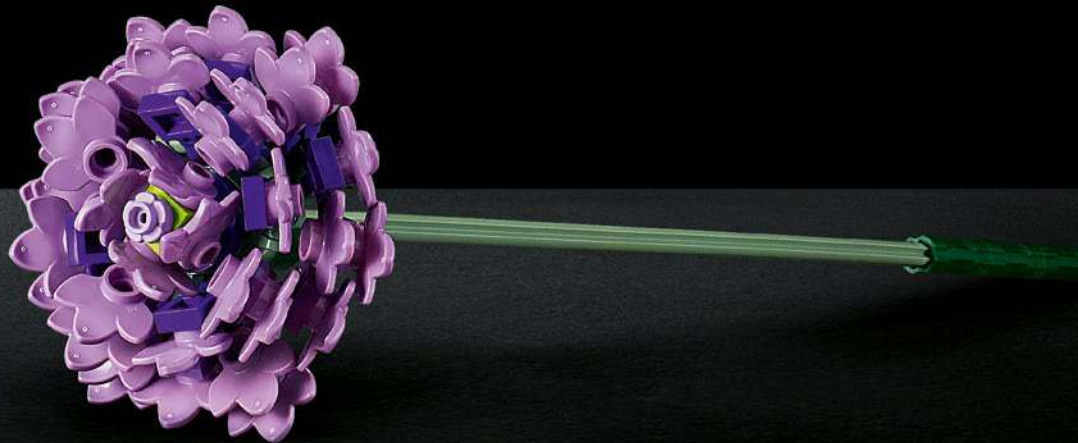

## COMMON DAISY/MARGUERITE COMMUNE/ MARGARITA COMÚN

*(Bellis perennis)*

● The most common of all the European species of daisy, this perennial flower blooms from early to mid-summer and enjoys a long flowering season. The LEGO® version of the daisy includes 3 blooms plus a small shoot that still has to flower.

● La plus commune de toutes les espèces européennes de marguerite, cette fleur vivace fleurit du début au milieu de l'été et jouit d'une longue saison de floraison. La version LEGO® de la marguerite comprend 3 fleurs, plus une petite pousse qui n'a pas encore fleuri.

● Esta flor perenne, la más común de todas las especies europeas de margarita, florece entre principios y mediados de verano y goza de una larga temporada de floración. La versión LEGO® de la margarita incluye 3 flores y un pequeño brote que todavía no ha florecido.

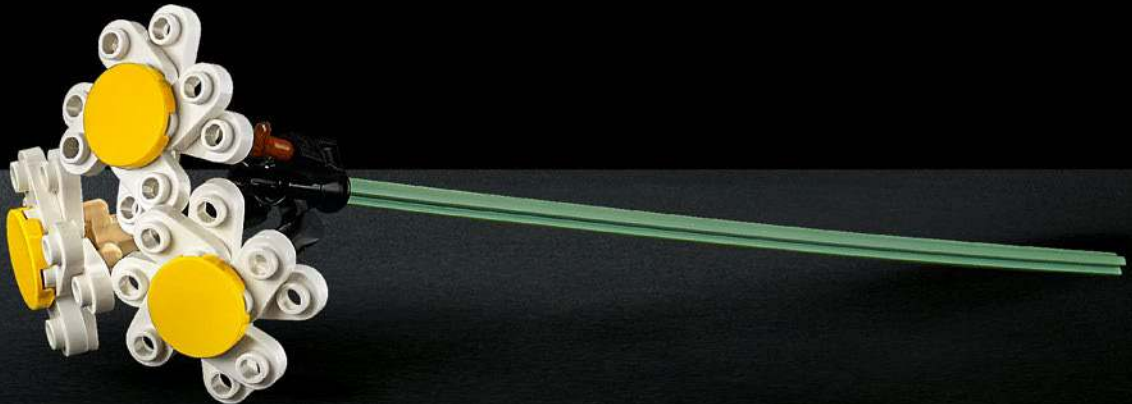

## CALIFORNIA POPPY/PAVOT DE CALIFORNIE/ AMAPOLA DE CALIFORNIA

*(Eschscholzia californica)*

- Native to California and Mexico, this poppy flowers throughout the summer months in vibrant shades of orange, red and yellow. It's the official state flower of California and is often used to garnish local traditional food recipes. 34 elements are used to create the LEGO® version of the delicate poppy and the upper petals can be adjusted to be more open or closed.
- Endémique de la Californie et du Mexique, ce pavot fleurit tout au long des mois estivaux en nuances éclatantes d'orange, de rouge et de jaune. Il est la fleur officielle de la Californie, et est souvent utilisé comme garniture dans les plats traditionnels locaux. La version LEGO® du délicat pavot comporte 34 éléments, et les pétales supérieurs peuvent être ajustés pour que la fleur soit plus ouverte ou fermée.
- Nativa de California y México, esta amapola florece durante los meses de verano en vibrantes tonos de naranja, rojo y amarillo. Es la flor oficial del estado de California y se usa con frecuencia para decorar los platillos tradicionales de la región. 34 son los elementos que se usan para crear la versión LEGO® de la delicada amapola y sus pétalos superiores se pueden ajustar para que queden más o menos abiertos.





LEGO® Designer Anderson Grubb  
Le concepteur LEGO® Anderson Grubb  
Anderson Grubb, diseñador de LEGO®

## FROM THE DESIGNERS

● Designing the Flower Bouquet set took LEGO® Designer Anderson Grubb back to childhood visits to his grandmother's bright, blossom-filled garden in Glenville, West Virginia, USA. He spent hours determining what flowers would best translate into LEGO shapes, and just as long again working on the color palette before bringing the final bouquet together.

Astrid Sundorf Christensen also builds LEGO flowers and many of her creations are on show in the company's reception halls and offices in Billund, Denmark. Astrid and Anderson worked together on the overall arrangement and especially on the Aster flower. Because of her flower creations, Astrid got involved in this project as part of an internal LEGO program that helps employees get back on track after a physical or psychological setback.

LEGO ATE (*Arbejde til Erhvervsafklaring* or work-based capability assessment) was set up 29 years ago to create a framework around employees with particular needs. They carry out smaller LEGO building tasks for the company and it was here that Astrid first started creating LEGO flowers. Her experience working with Anderson on the Flower Bouquet set has further strengthened her desire to work with LEGO product development in the future.

## UN MOT SUR LES CONCEPTEURS

● La conception de l'ensemble Bouquet de fleurs a rappelé au concepteur LEGO® Anderson Grubb son enfance et ses visites au superbe jardin fleuri de sa grand-mère à Glenville, en Virginie-Occidentale, aux États-Unis. Il a passé des heures à déterminer quelles fleurs se traduiraient le mieux en formes LEGO, et tout aussi longtemps à travailler sur la palette de couleurs avant de réaliser le bouquet final.

Astrid Sundorf Christensen construit elle aussi des fleurs LEGO, et plusieurs de ses créations sont exposées dans les salles de réception et les bureaux de l'entreprise à Billund, au Danemark. Astrid et Anderson ont travaillé ensemble sur la composition du bouquet, et tout particulièrement sur l'aster. En raison de ses créations florales, Astrid s'est impliquée dans ce projet dans le cadre d'un programme interne de LEGO qui aide les employés à se remettre sur pied après une blessure physique ou psychologique.

Le programme LEGO ATE (*Arbejde til Erhvervsafklaring*, qui signifie « évaluation des capacités professionnelles ») a été mis en place il y a 29 ans pour encadrer les employés ayant des besoins particuliers. Ils effectuent de plus petites tâches de construction LEGO pour l'entreprise, et c'est dans ce cadre qu'Astrid a commencé à créer des fleurs LEGO. Son expérience de travail avec Anderson sur l'ensemble Bouquet de fleurs a renforcé son désir de travailler au développement de produits LEGO à l'avenir.



Astrid Sundorf Christensen

## ACERCA DE LOS DISEÑADORES

● El desarrollo del set Ramo de Flores llevó al diseñador de LEGO® Anderson Grubb de regreso a las visitas de su infancia al luminoso y florido jardín de su abuela, en Glenville, Virginia Occidental (EE. UU.). Pasó muchas horas tratando de determinar qué flores darían mejor resultado una vez traducidas al formato LEGO, y otras tantas trabajando en la paleta de colores antes de llegar a la versión definitiva del ramo.

Astrid Sundorf Christensen también construye flores LEGO y muchas de sus creaciones decoran los vestíbulos y oficinas de la sede de la compañía, en Billund (Dinamarca). Astrid y Anderson trabajaron juntos en el arreglo general y, especialmente, en el aster. Su habilidad para crear flores llevó a Astrid a formar parte de este proyecto como resultado de un programa interno de LEGO cuyo objetivo es ayudar a los empleados a recuperarse luego de un trastorno físico o psicológico.

El programa de asignación de trabajo con base en la evaluación de la capacidad LEGO ATE (*Arbejde til Erhvervsafklaring*, en danés) se instauró hace 29 años con el fin de crear un marco de actuación en torno a los empleados con necesidades particulares. Quienes participan en el programa llevan a cabo pequeñas tareas de construcción con piezas LEGO para la empresa y fue ahí donde Astrid creó sus primeras flores LEGO. Su experiencia trabajando con Anderson en el set Ramo de Flores ha fortalecido su deseo de involucrarse en el desarrollo de productos LEGO de cara al futuro.



## PLANTS FROM PLANTS/DES PLANTES FABRIQUÉES AVEC DES PLANTES/PLANTAS CON PLANTAS

● The LEGO Group is working to build a more sustainable future for children. Currently more than 80 LEGO® elements including trees, leaves and bushes are made from a plant-based plastic, produced using sustainably sourced sugarcane, Plants from Plants! These elements represent the first steps of a bigger mission to make LEGO bricks from sustainable sources by 2030.

● Le Groupe LEGO s'emploie à bâtir un avenir plus durable pour les enfants. À l'heure actuelle, plus de 80 éléments LEGO®, dont des arbres, des feuilles et des buissons, sont fabriqués à partir de plastique végétal fait à base de canne à sucre de sources durables ; des plantes fabriquées avec des plantes ! Ces éléments constituent la première étape d'une mission bien plus considérable visant à fabriquer des briques LEGO issues de sources durables d'ici 2030.

● The LEGO Group está trabajando en la construcción de un futuro más sustentable para los niños. En la actualidad, más de 80 elementos LEGO® (como árboles, hojas y arbustos) se fabrican a partir de plástico de origen vegetal producido con caña de azúcar procedente de fuentes sustentables, lo que da nombre a nuestra iniciativa: Plantas con Plantas. Estos elementos representan los primeros pasos de una misión de mayor envergadura cuyo objetivo es que los bricks LEGO se fabriquen a partir de fuentes sustentables antes de 2030.



● Plants from Plants elements in this set:

● Les éléments fabriqués avec des plantes dans cet ensemble :

● Elementos pertenecientes a la iniciativa Plantas con Plantas que contiene este set:



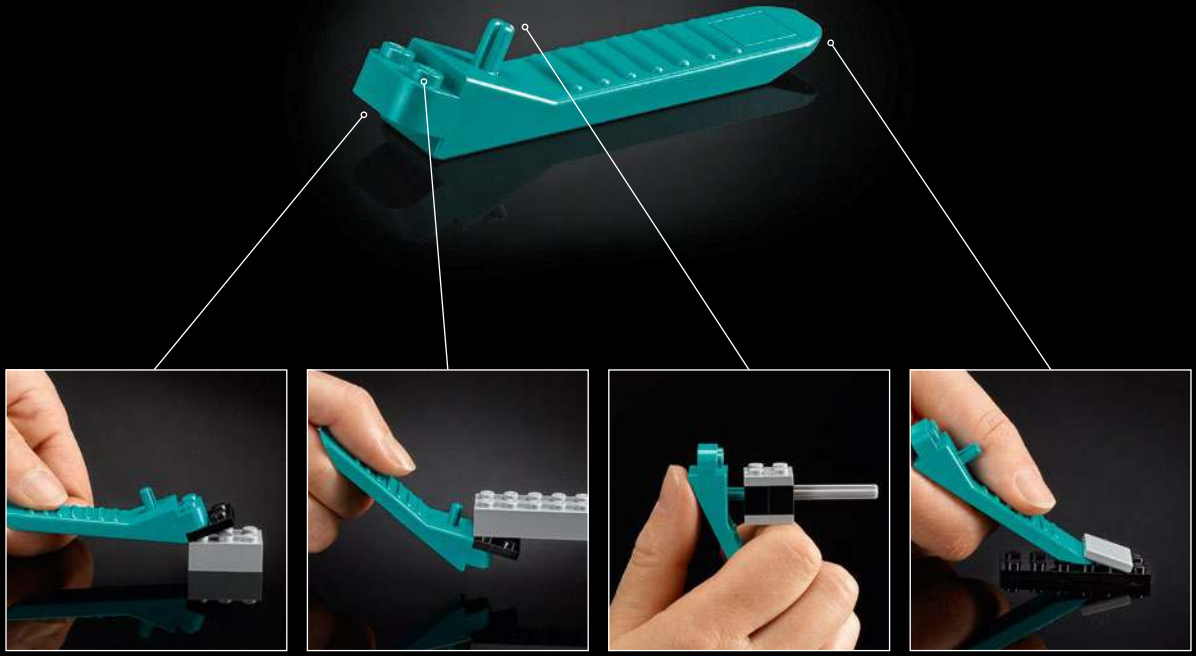

[LEGO.com/brickseparator](https://LEGO.com/brickseparator)



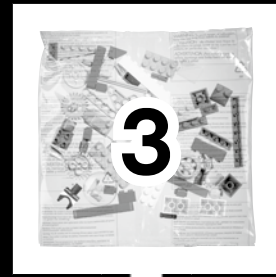

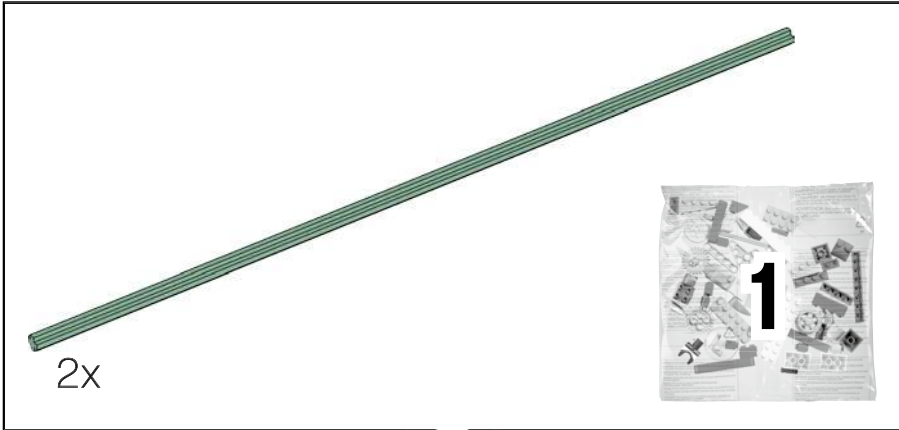

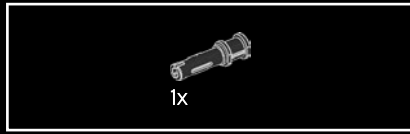

1

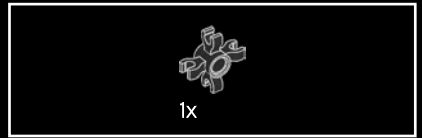

2





3



4



- The small brown leaf element is more commonly used in other LEGO® sets as a carrot top.
- Le petit élément de feuille brune est plus couramment utilisé dans d'autres ensembles LEGO® comme tige de carotte.
- El pequeño elemento café que representa el brote se suele usar en otros sets LEGO® como tallo de una zanahoria.

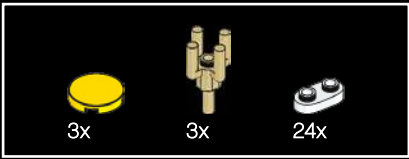

5

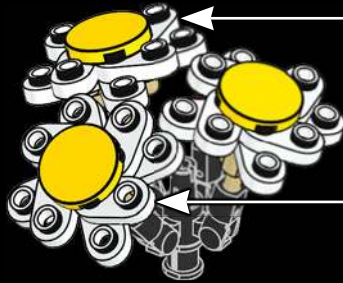
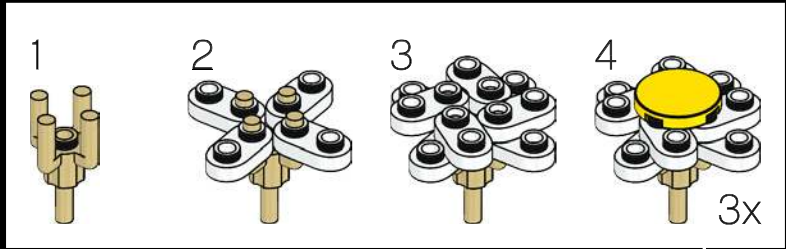

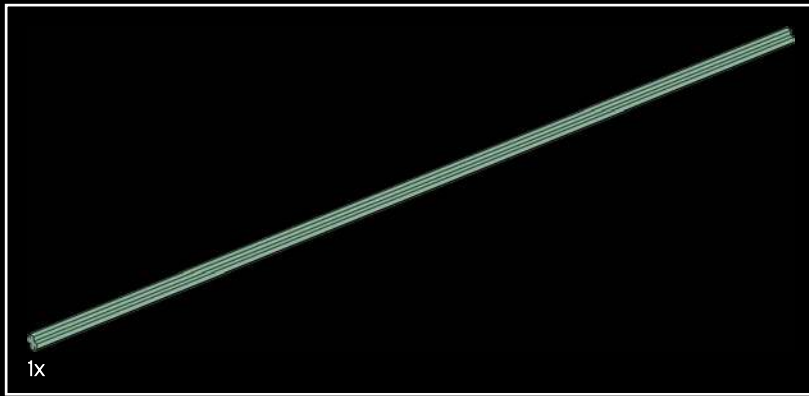

6

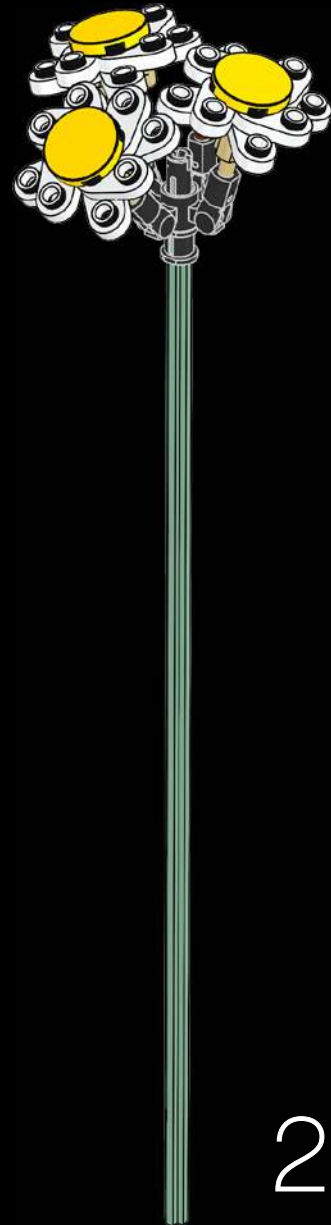

2x

- The stem is made from a 32-module LEGO® Technic™ axle piece.
- La tige est faite d'une pièce d'essieu LEGO® Technic™ de 32 modules.
- El tallo está creado a partir de un eje LEGO® Technic™ de 32 módulos.

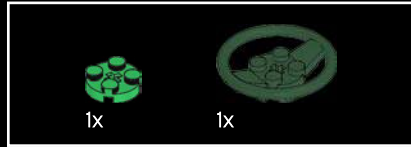
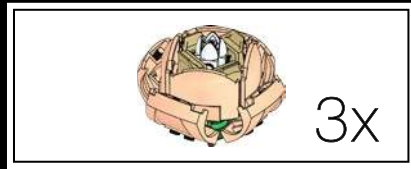

1

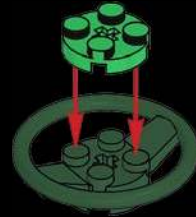

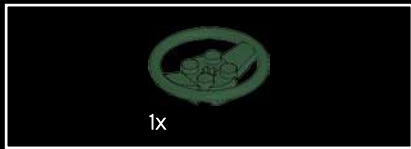

2



3

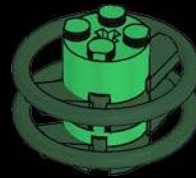



4

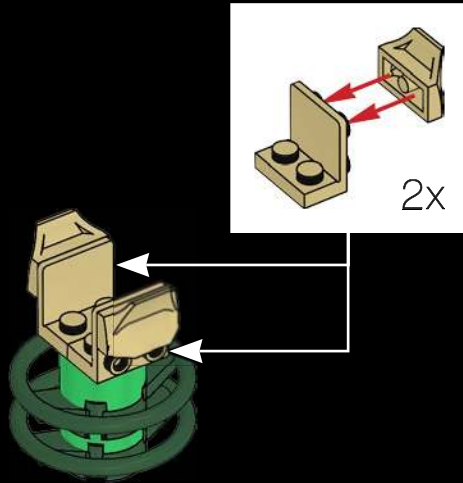

5

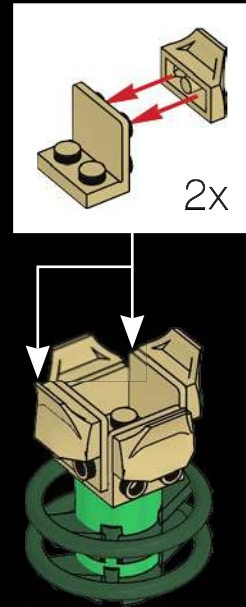

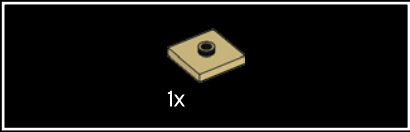

6

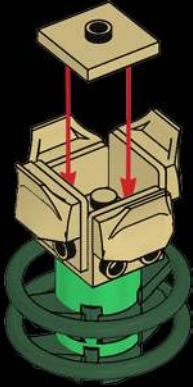

7

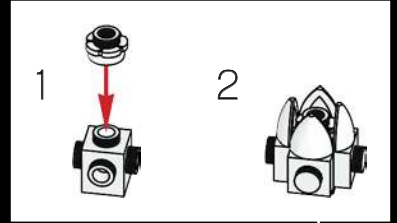

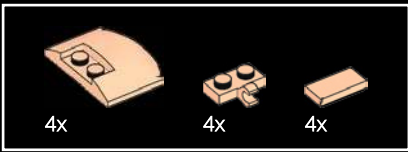

8

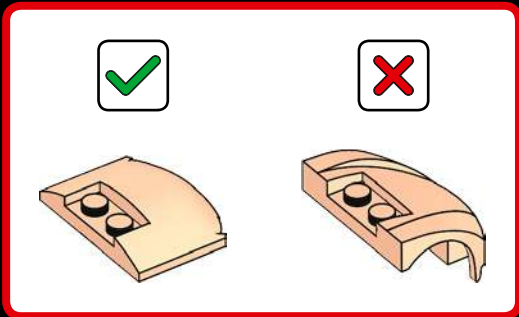
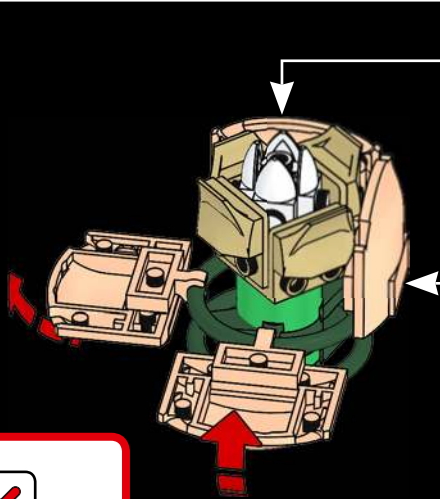
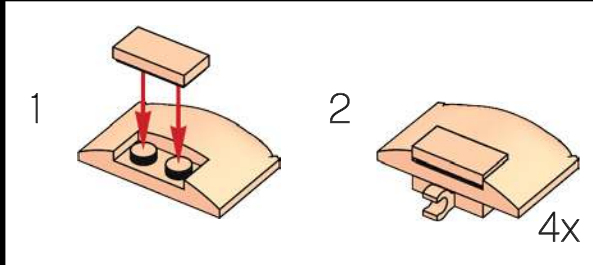



9

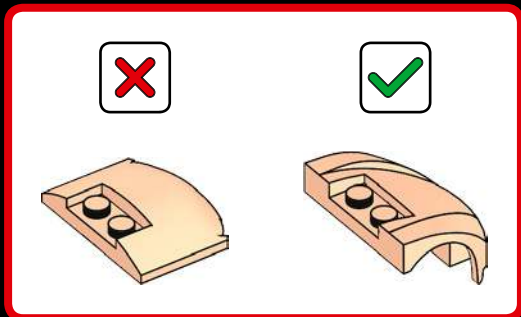
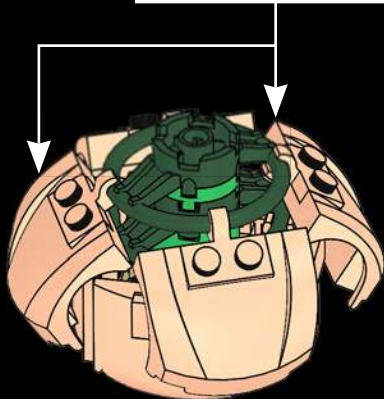
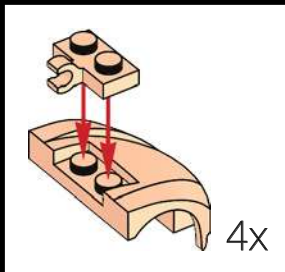

● The outer petal elements are more commonly used as engine hoods and car roofs in other LEGO® models.

● Les éléments des pétales extérieurs sont plus couramment utilisés comme capots et toits de voiture dans d'autres modèles LEGO®.

● Los elementos que representan los pétalos exteriores se usan con frecuencia como cubiertas de motor y techos de auto en otros modelos LEGO®.



10

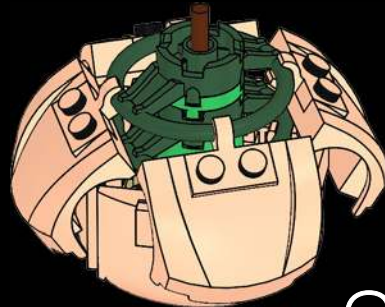

3x

● The Light Nougat tone is an existing but not widely used color in the LEGO® palette.

● Le ton Nougat clair est une couleur existante, mais peu utilisée dans la palette LEGO®.

● El tono turrón claro es un color de la paleta LEGO® que, aunque existe, se usa con poca frecuencia.



1



2



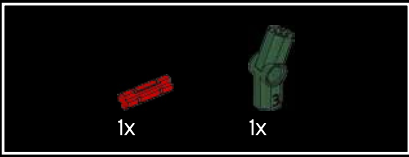

3



4





5

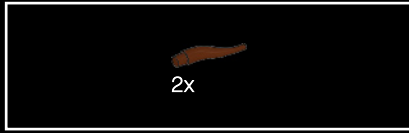
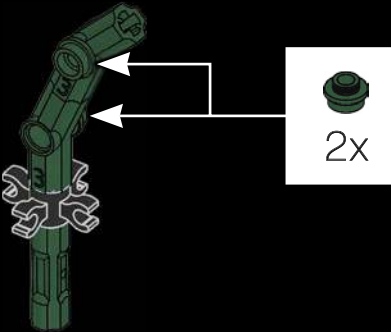

6

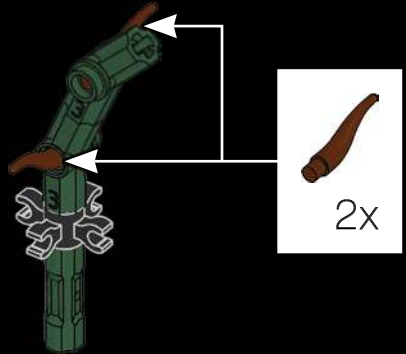



7

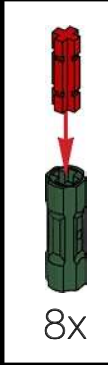

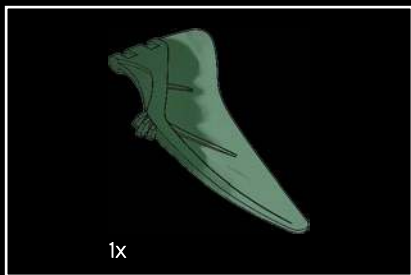

8

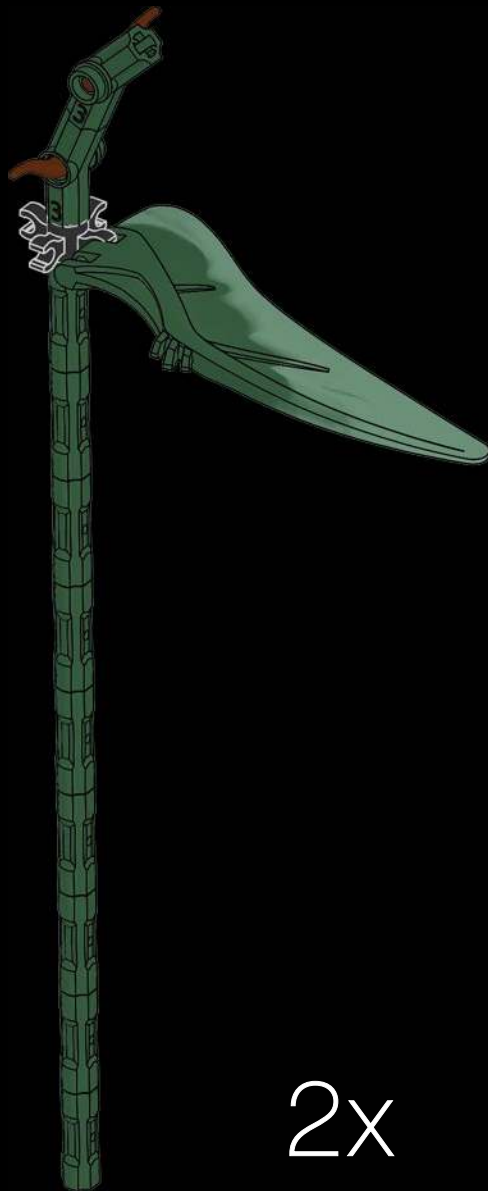

2x

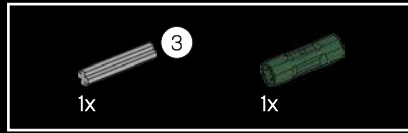

1

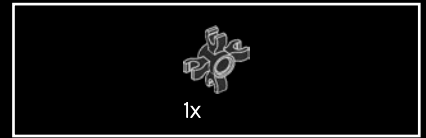

2



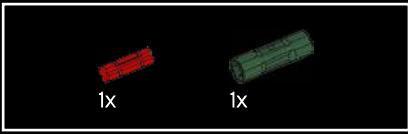

3

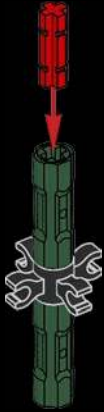

4





5

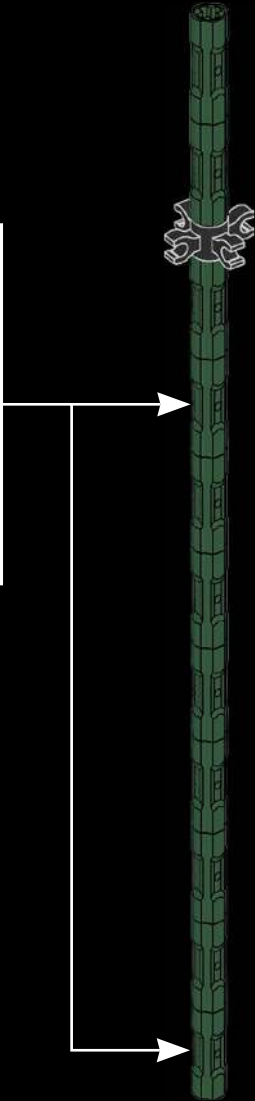
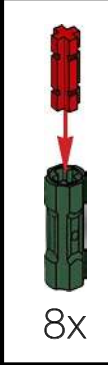

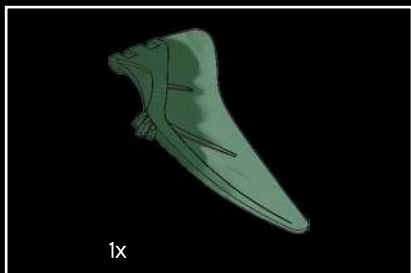

6



● Using traditional LEGO® C-snap elements allows the petals to move.

● L'utilisation d'éléments connecteurs de type C traditionnels LEGO® permet aux pétales de se mouvoir.

● Los pétalos se pueden mover gracias al uso de fijaciones articuladas LEGO® tradicionales.

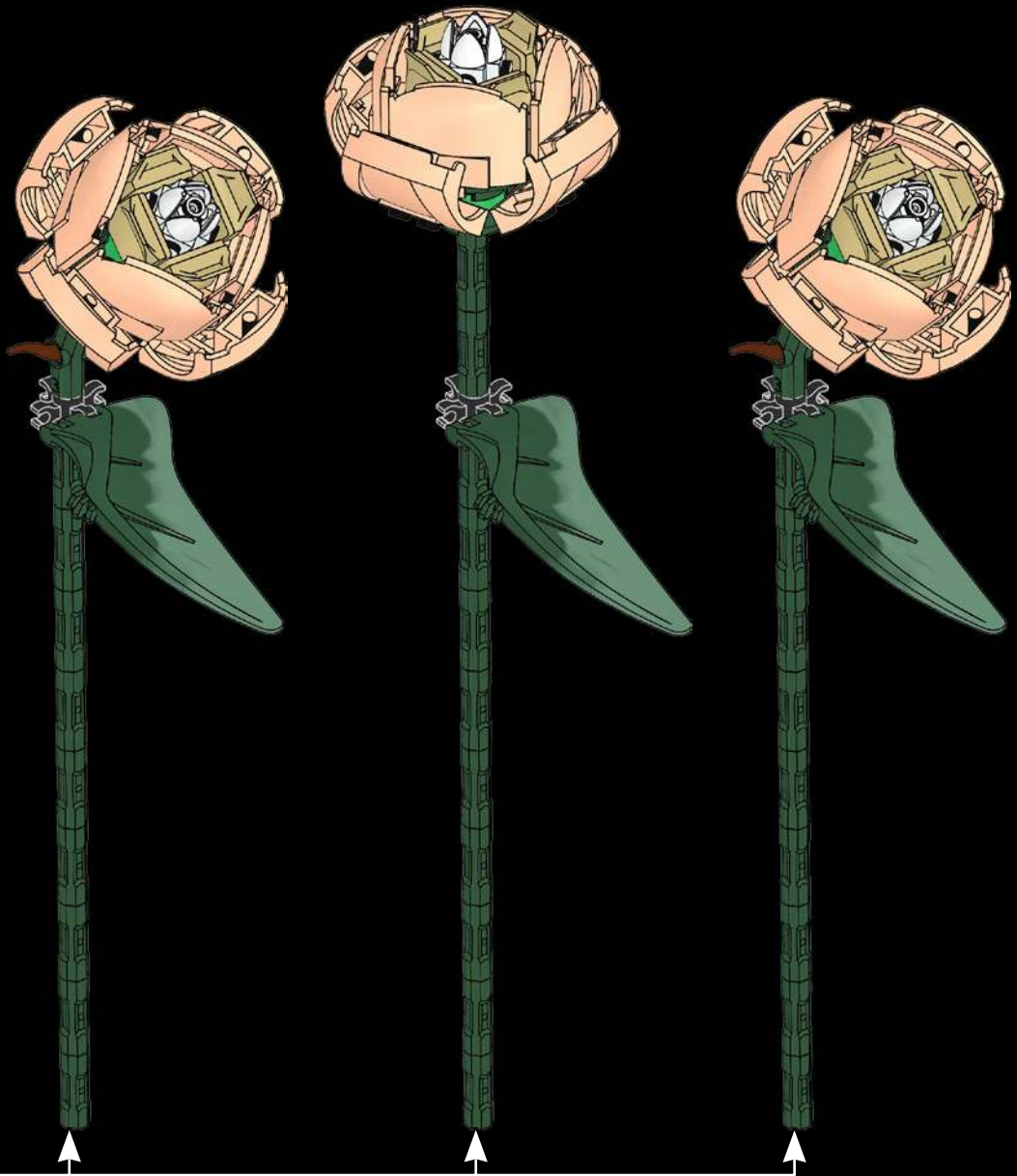

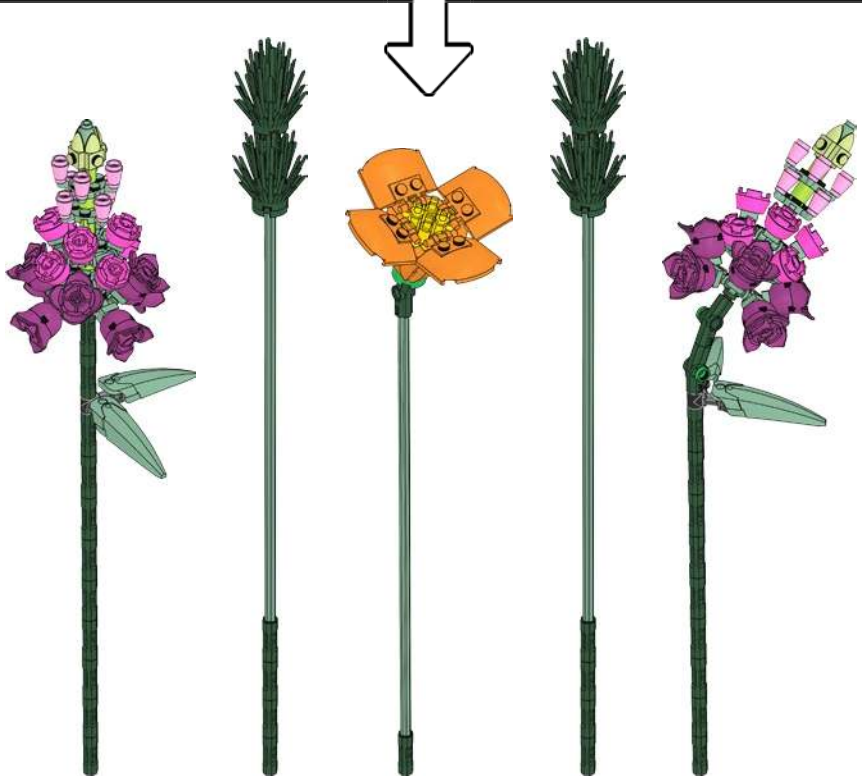
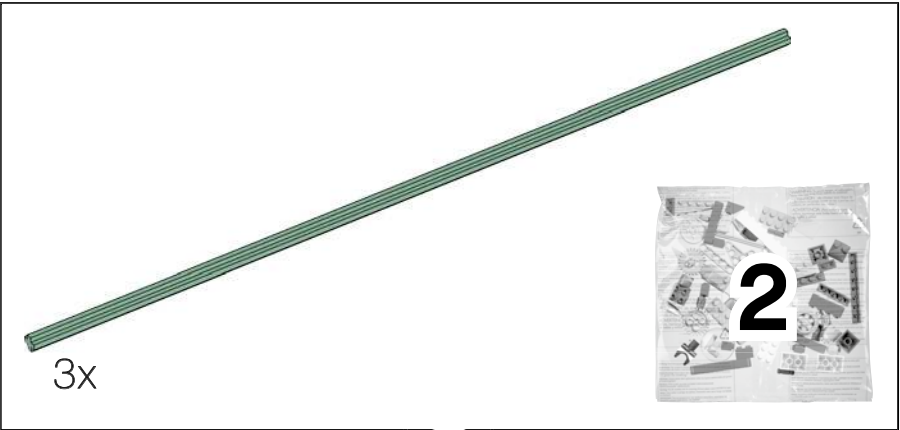

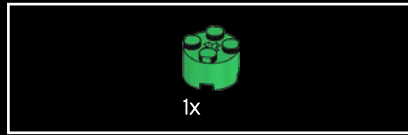
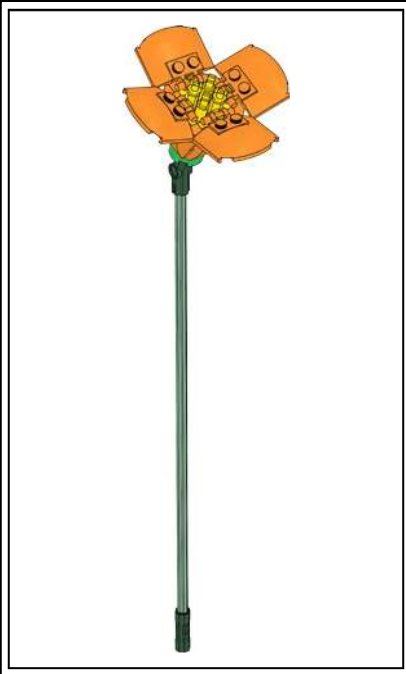

1

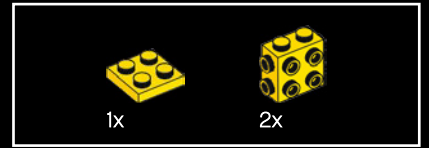

2

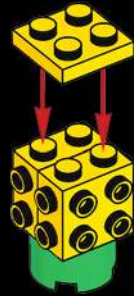



3



4

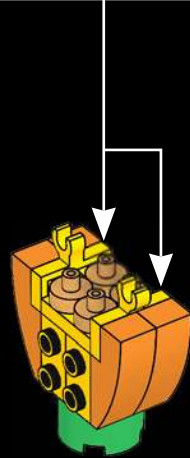
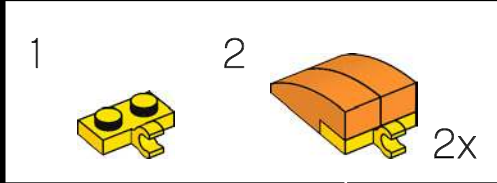

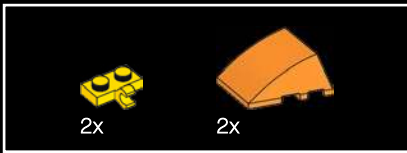

5

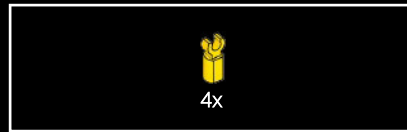
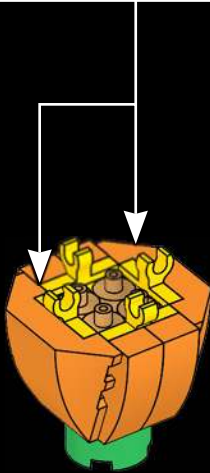
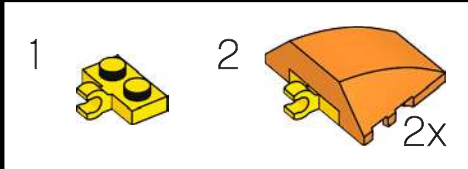

6

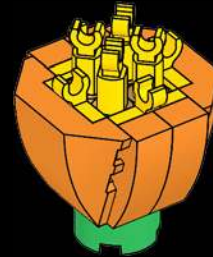

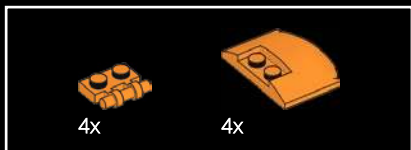

7

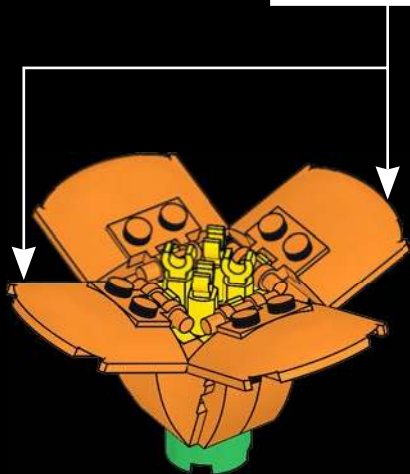
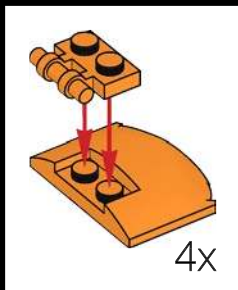

8

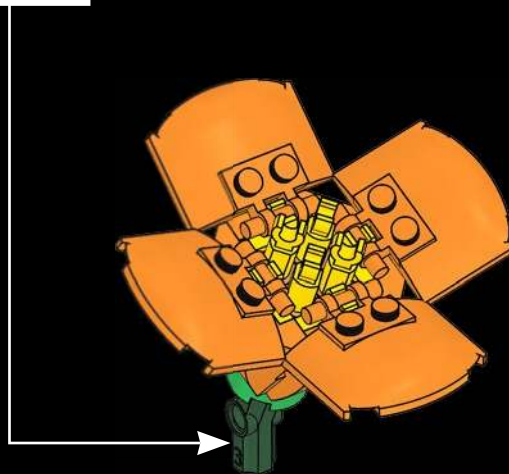

● The petal elements are usually used in LEGO® cars and airplanes. It's the first time they are available in this bright orange color.

● Les éléments des pétales sont généralement utilisés dans les voitures et les avions LEGO®. C'est la première fois qu'ils sont disponibles dans ce ton orange vif.

● Los elementos que representan los pétalos se suelen usar en autos y aviones LEGO®. Es la primera vez que se fabrican en este color naranja tan llamativo.

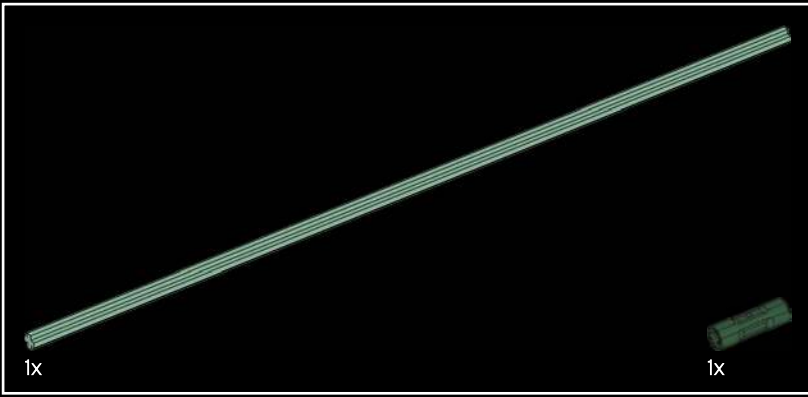

9





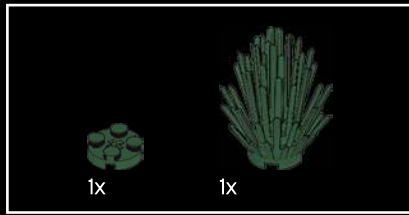
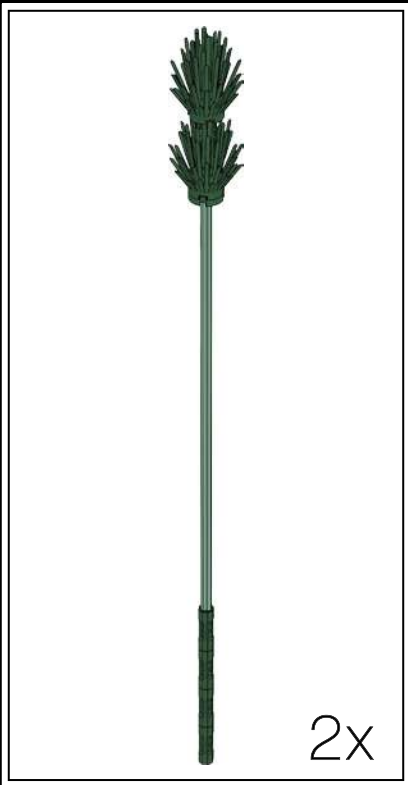

1

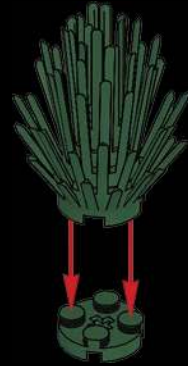

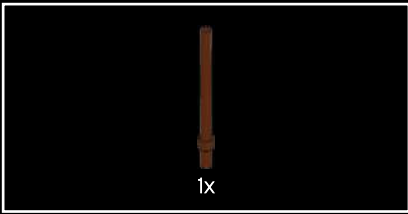

2

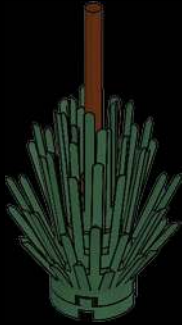

3

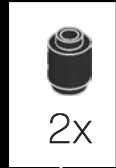
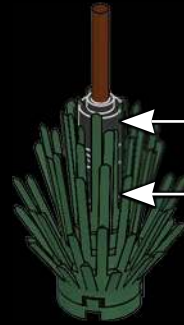

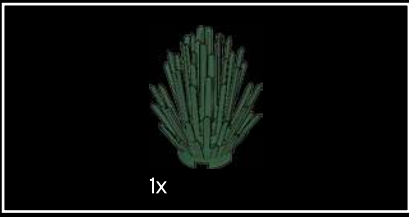

4

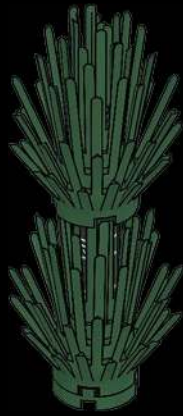

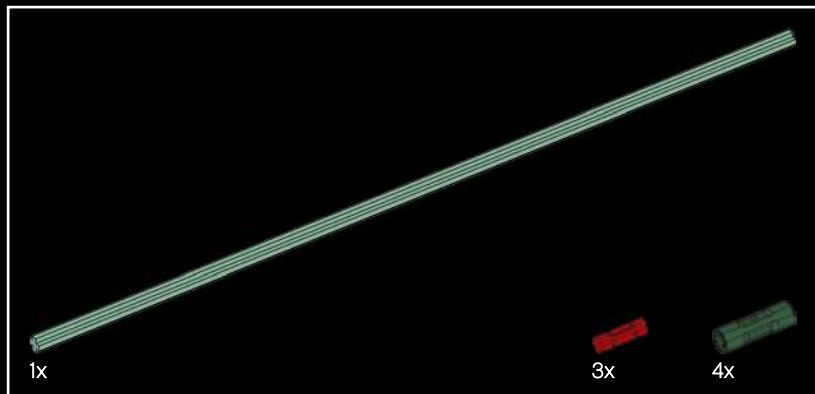

5

1



2



3x

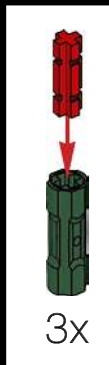

3



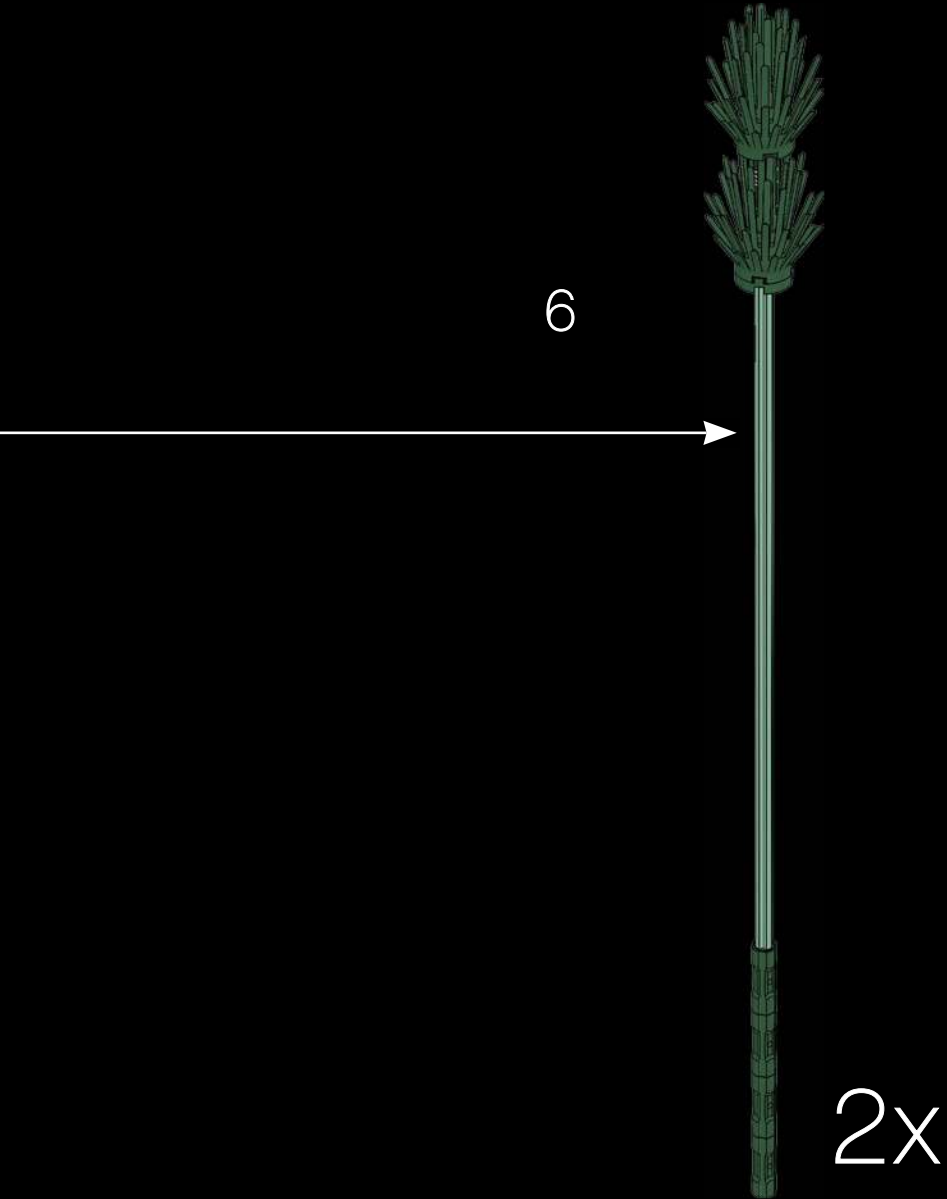

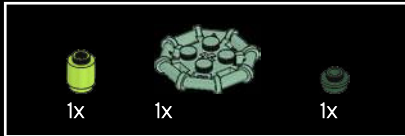
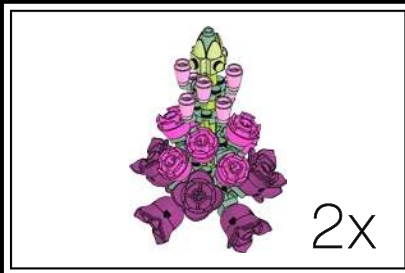

1



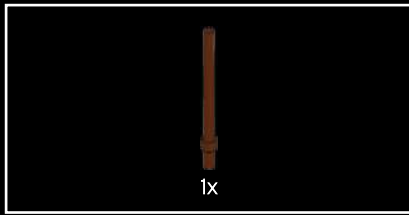

2

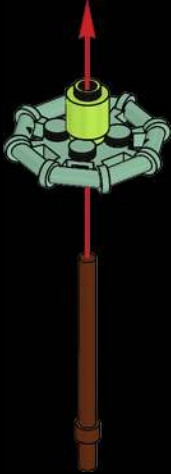

3



4



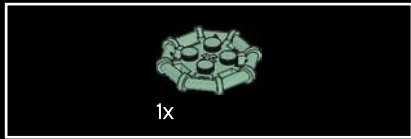

5

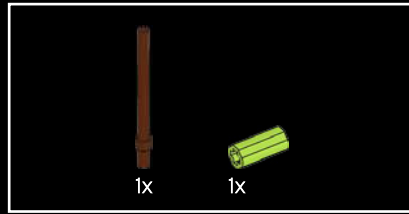

6

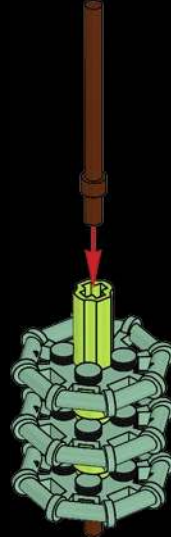

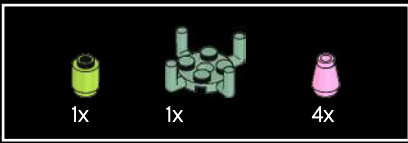

7

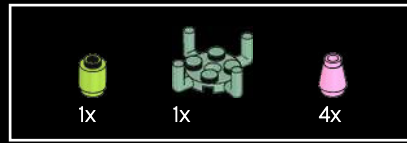
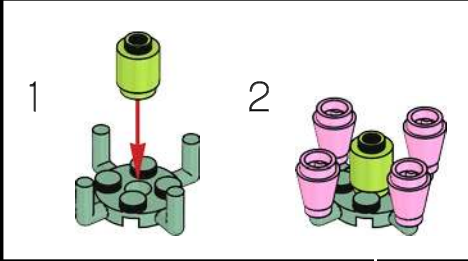

8

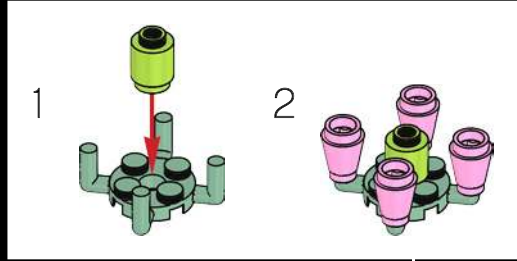



9

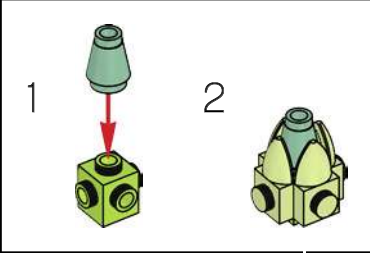

10

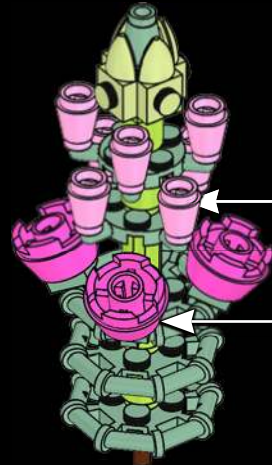
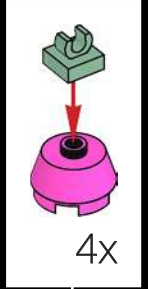

- The bright purple blossoms in the middle are more commonly seen as the heads of droids and robots in LEGO® Star Wars™ sets.
- Les fleurs mauve vif au milieu sont plus souvent utilisées comme têtes de droïdes et de robots dans les ensembles LEGO® Star Wars™.
- Las flores púrpura intenso de la sección central se usan con frecuencia como cabezas de droïdes y robots en sets LEGO® Star Wars™.



11

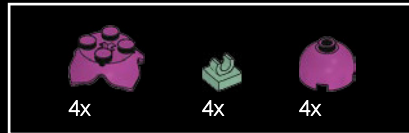
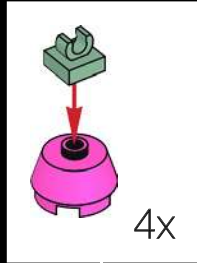

12

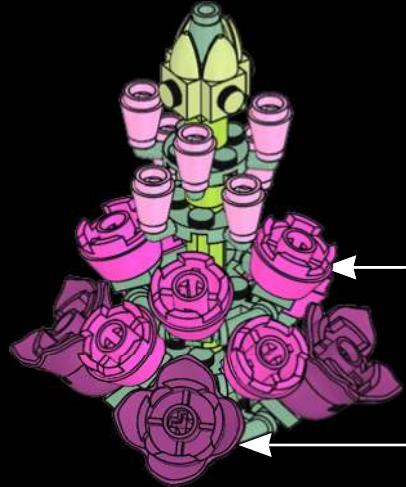
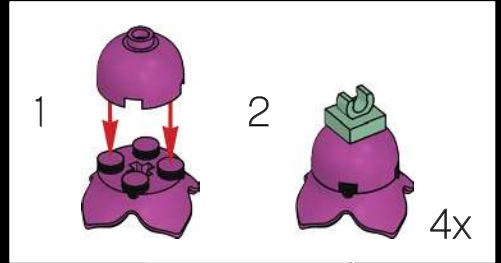

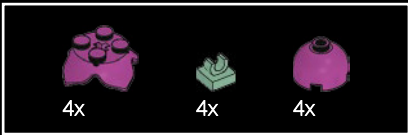

13

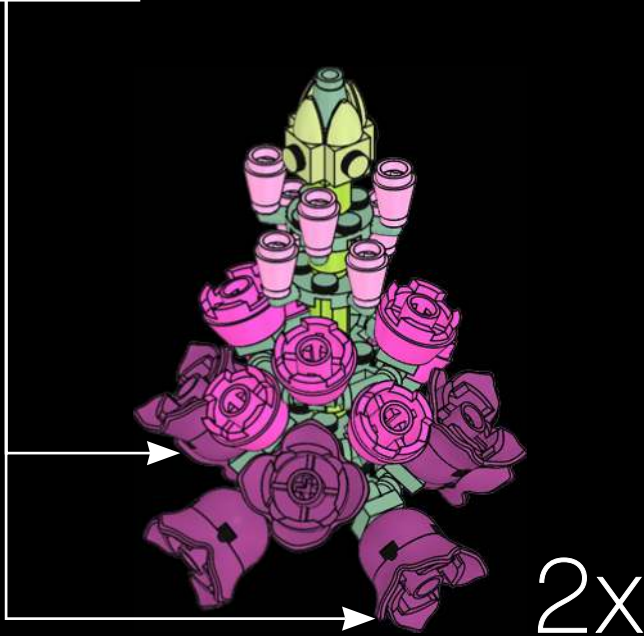
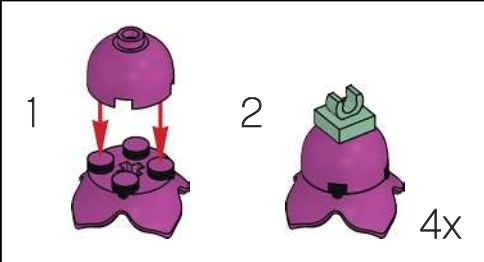

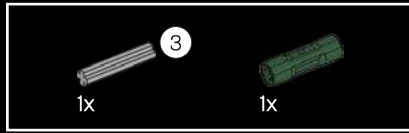
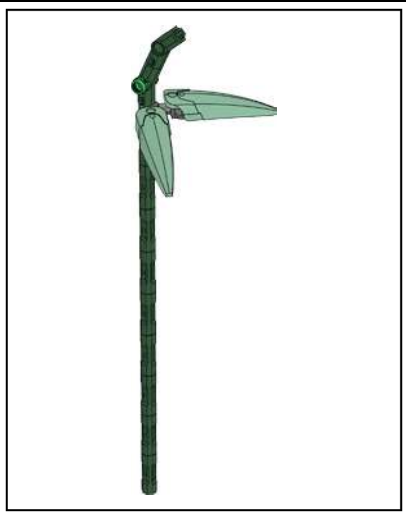

1

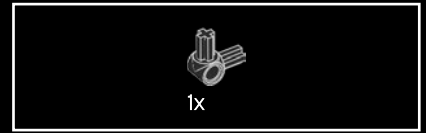

2



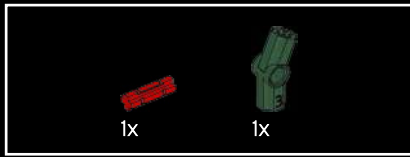

3

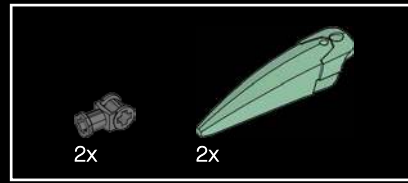

4

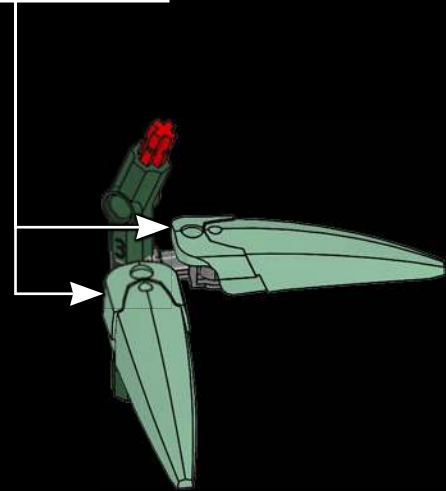
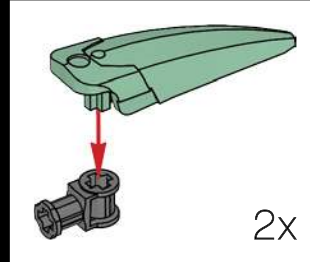

- The leaves on this flower originated as LEGO® 'claw' elements in 2014.
- Les feuilles de cette fleur proviennent des éléments LEGO® de « griffes » sortis en 2014.
- Las hojas de esta flor son elementos LEGO® que representan garras y empezaron a fabricarse en 2014.





7

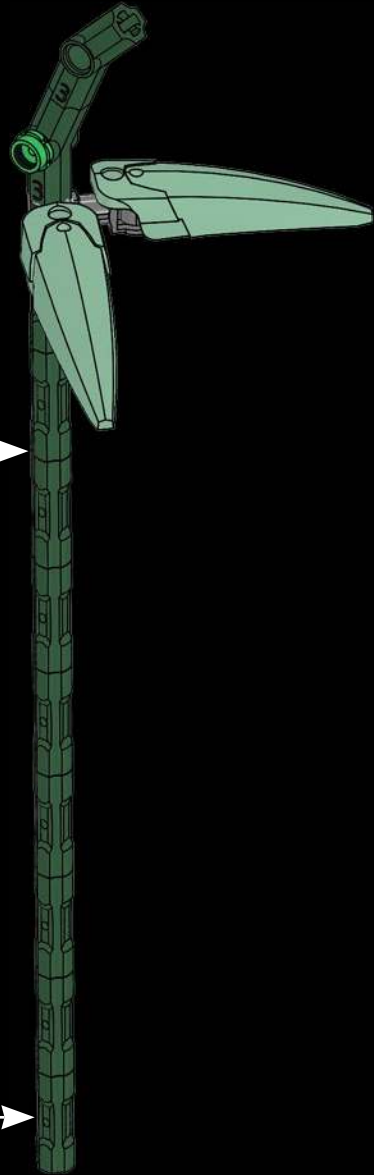
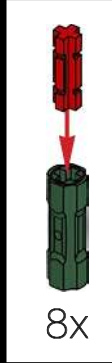

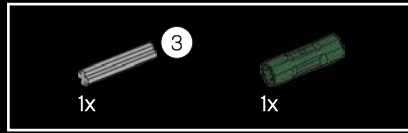
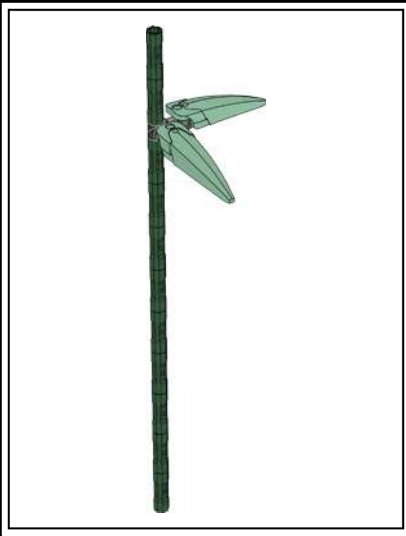

1

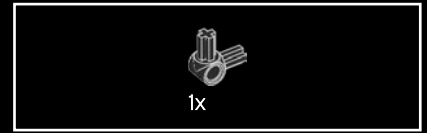

2





3



4

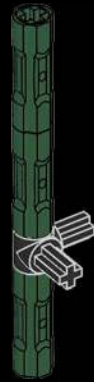

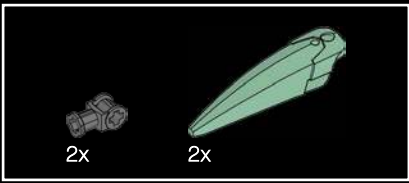

5

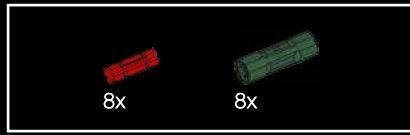
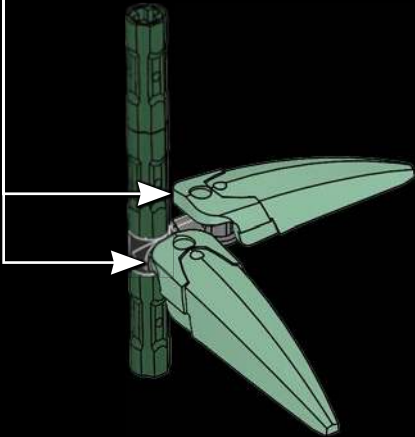
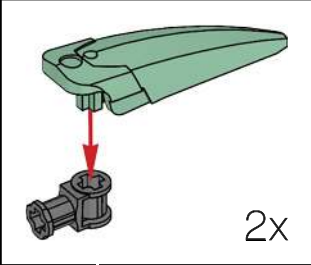

6

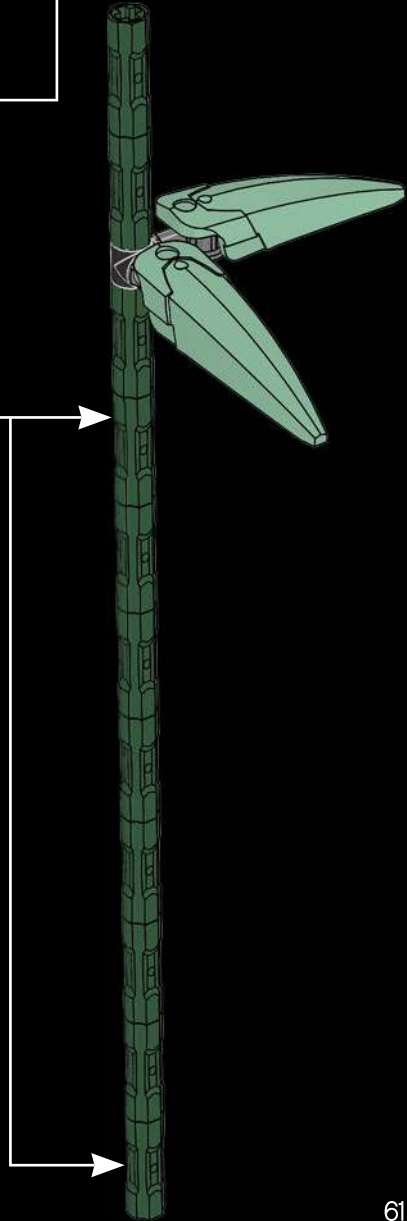
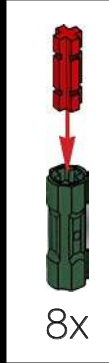



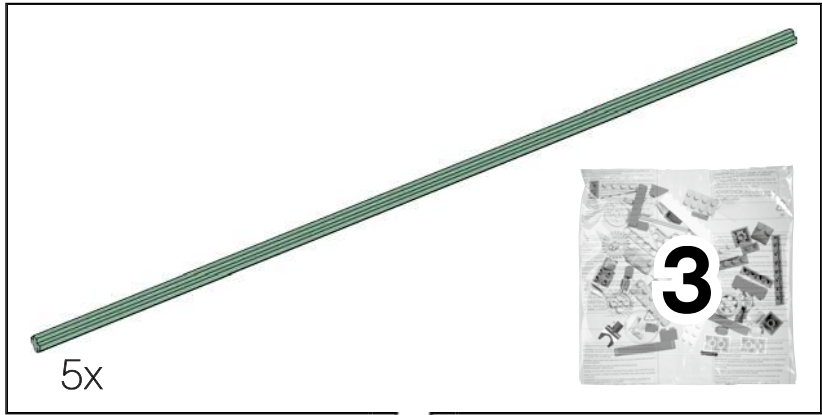

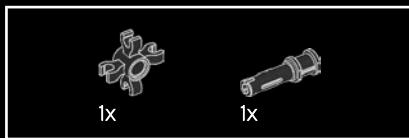

1



2

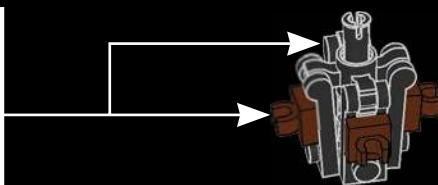
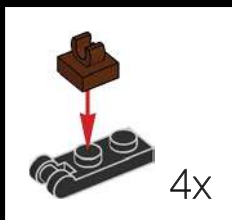

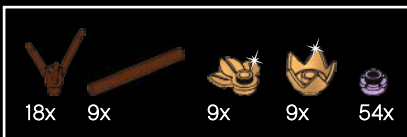

3

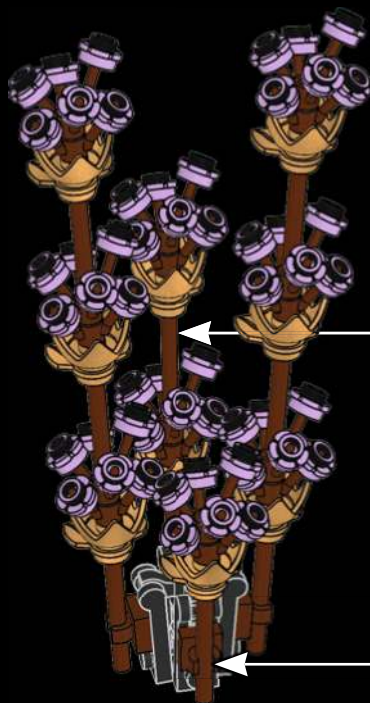

● The golden 5-pointed element, used as a leaf here, first appeared as Queen Watevra Wa'Nabi's crown in THE LEGO® MOVIE 2™ sets.

● L'élément doré à 5 pointes, utilisé ici comme feuille, est apparu pour la première fois en tant que couronne de la reine Jpeuzette Skejai'envie dans les ensembles du FILM LEGO® 2.

● El elemento dorado con 5 puntas que aquí representa un grupo de hojas apareció por primera vez como corona de la Reina SoyLoQue QuieraSer en los sets LA GRAN AVENTURA LEGO® 2.

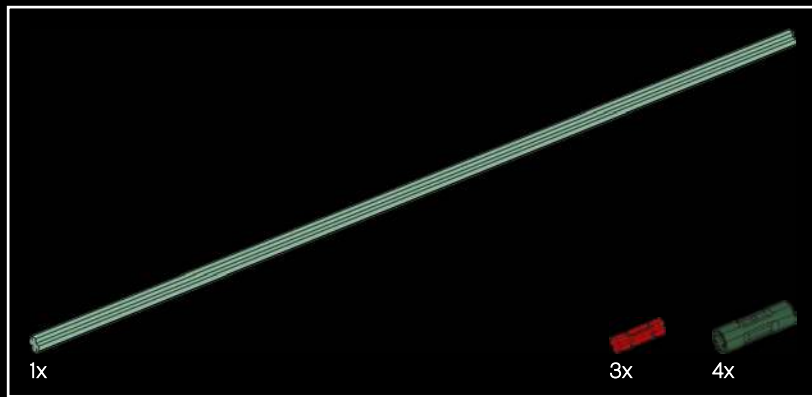

4

1



2



3



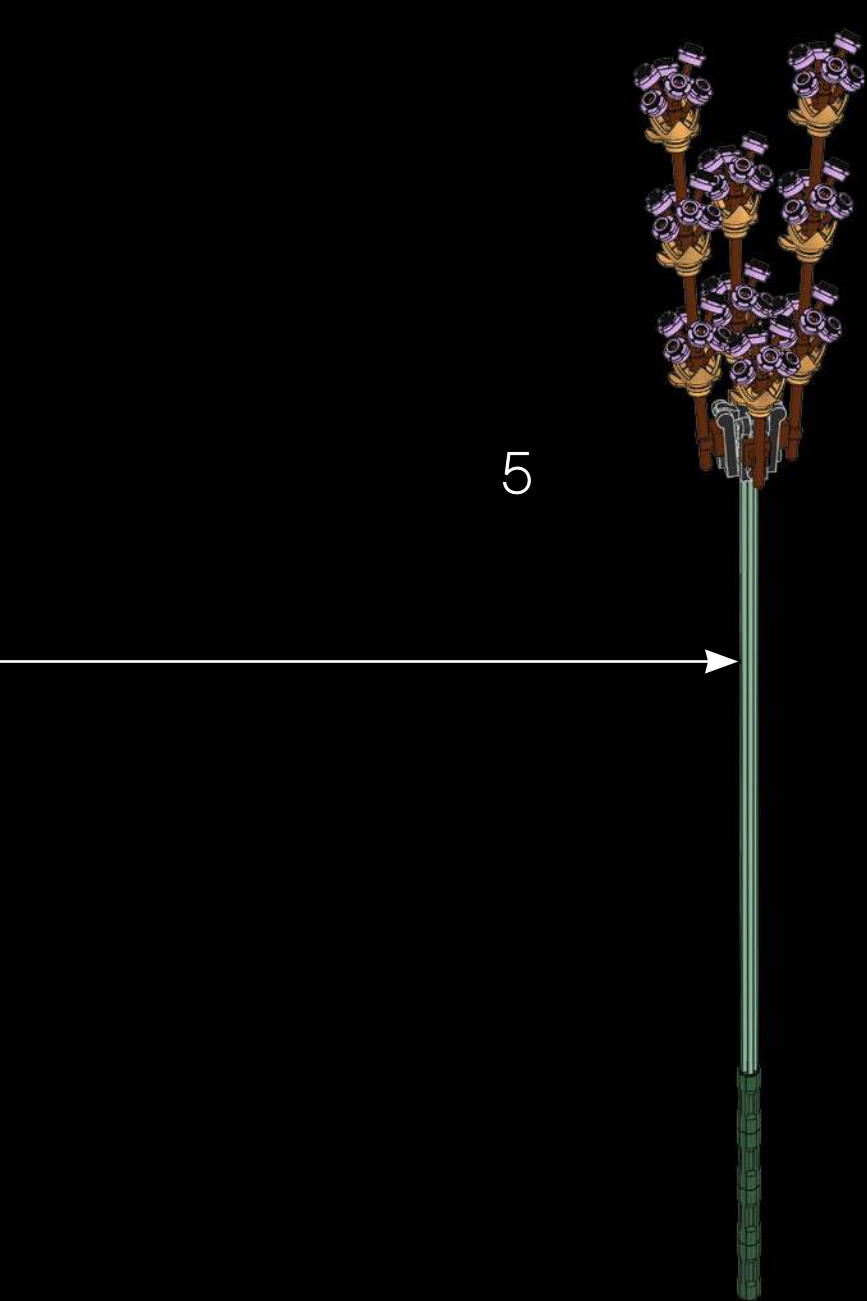

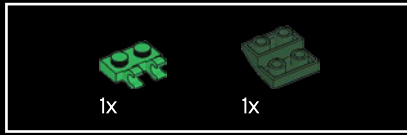
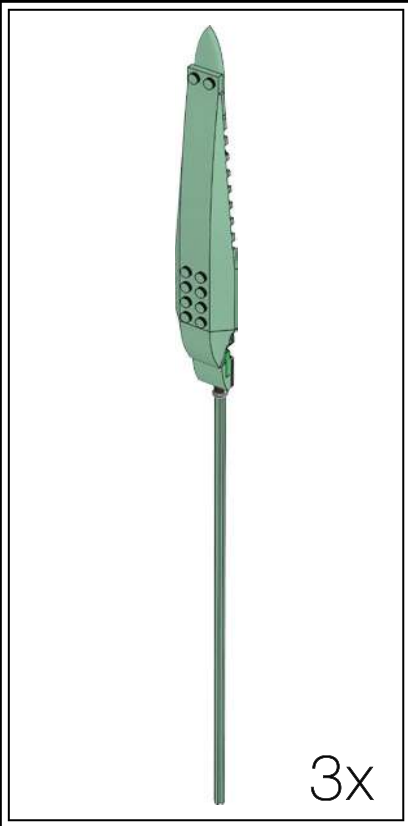

1

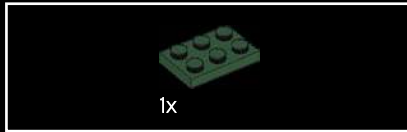
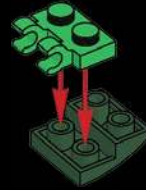

2



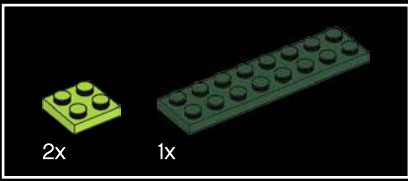

3

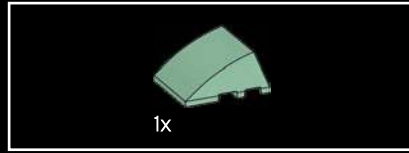
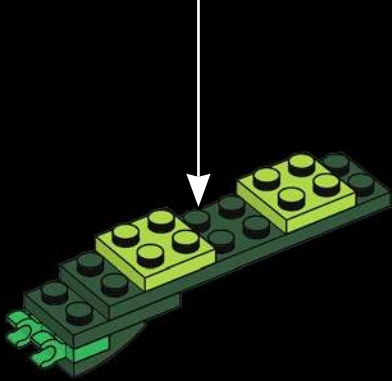
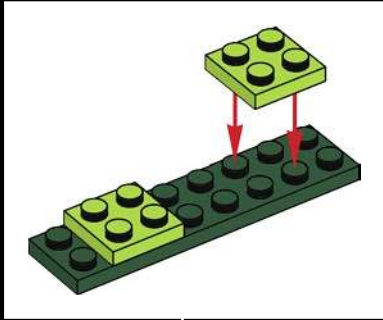

4

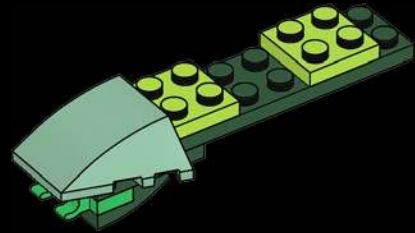

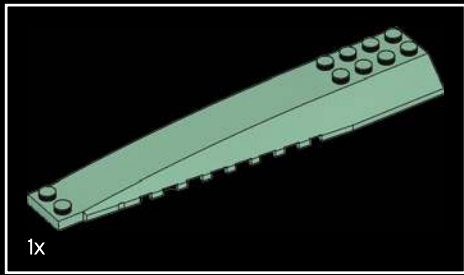

5

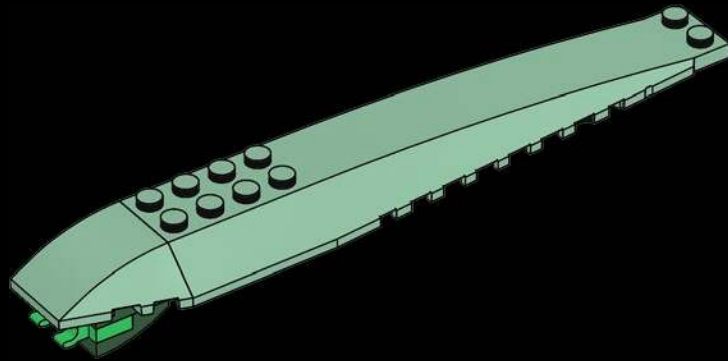

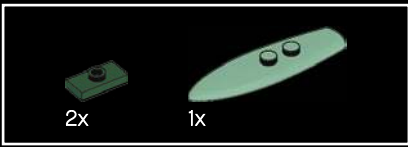

6

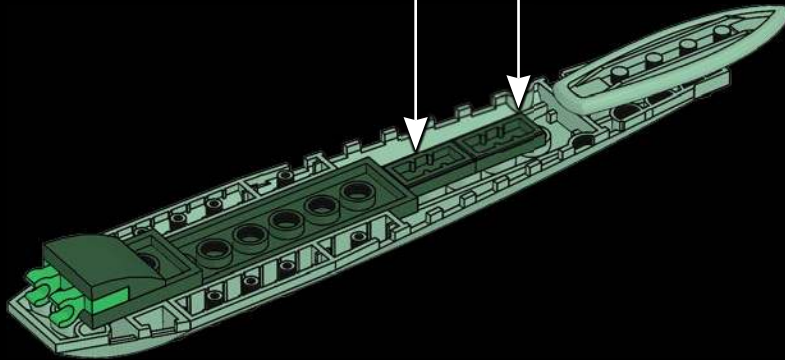
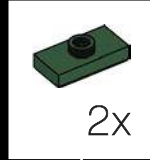

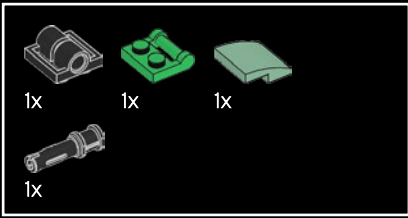

7

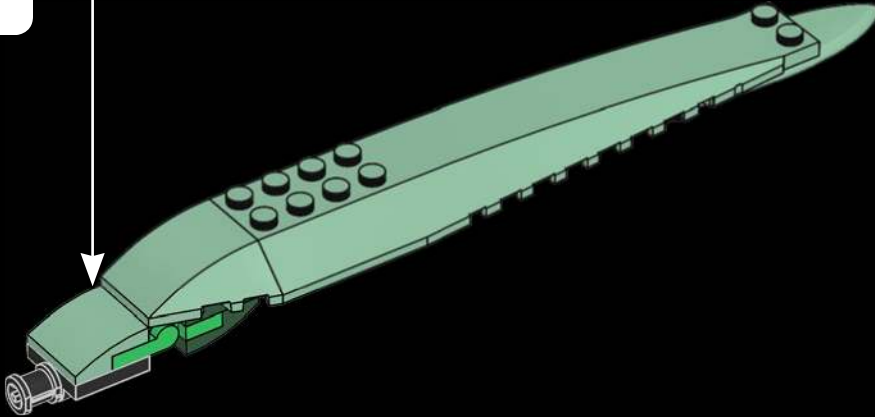
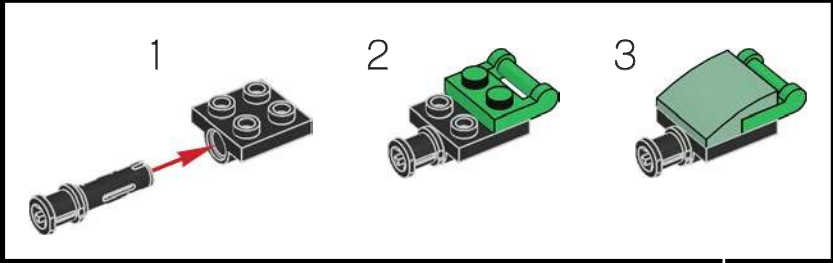

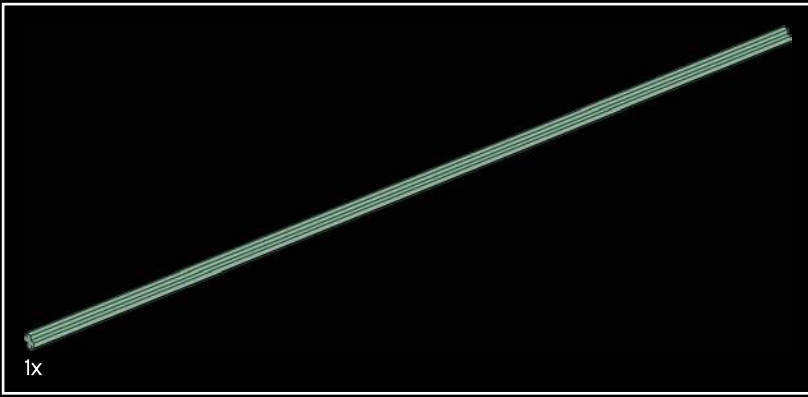

8



3x

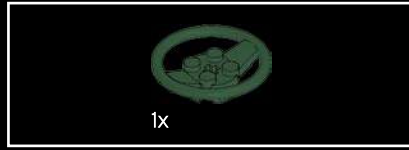

1



2

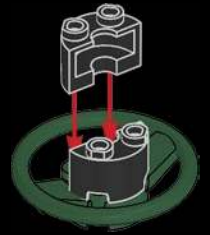



3



4





5



6

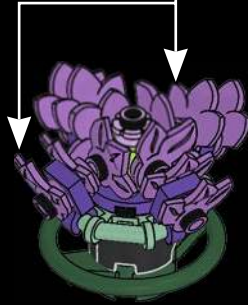
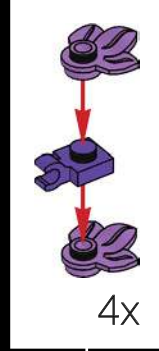



7

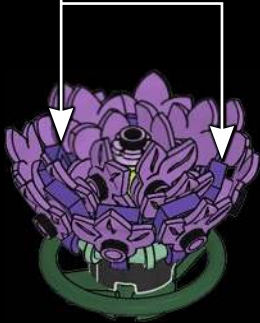
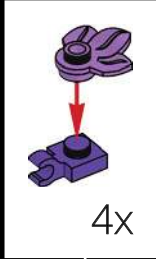

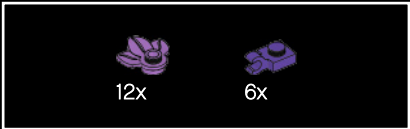

8

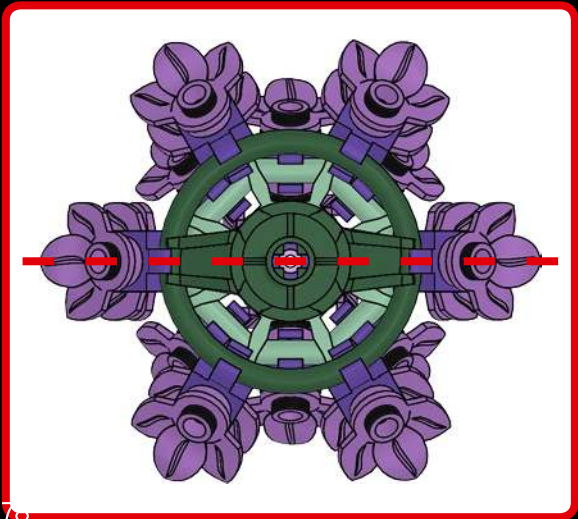
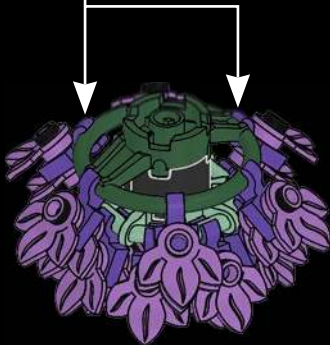
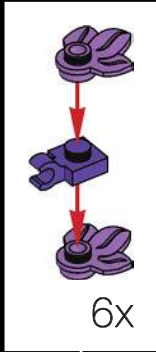



9

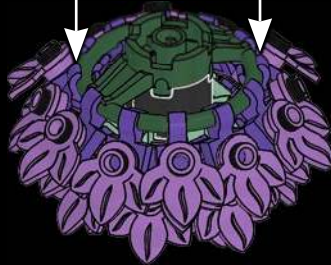

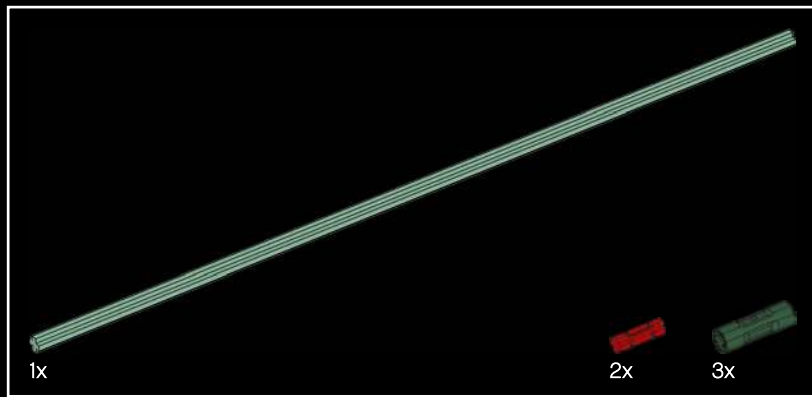

10

1



2



3



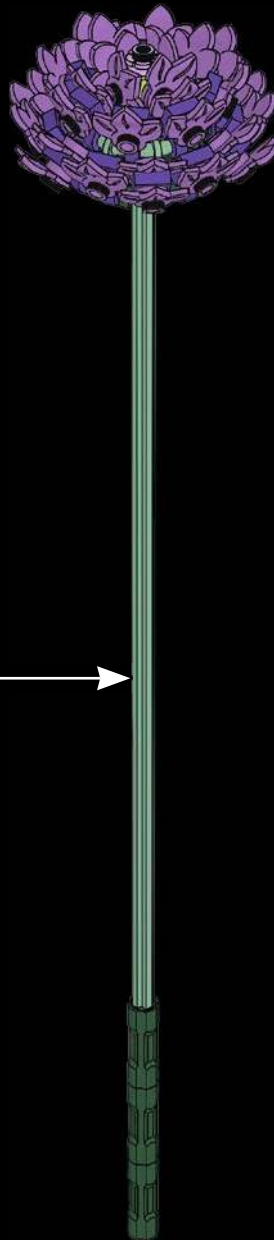

● It's the first time the 32-module LEGO® Technic™ axle piece has been produced in this Sand Green color.

● C'est la première fois que la pièce d'essieu LEGO® Technic™ de 32 modules est produite dans cette couleur vert terreux.

● Es la primera vez que el eje LEGO® Technic™ de 32 módulos se fabrica en color verde arena.





# FEEDBACK AND WIN

## FEEDBACK AND WIN

Your feedback will help shape the future development of this product series.

Please visit:

## FEEDBACK UND GEWINNEN

Dein Feedback trägt zur Weiterentwicklung dieser Produktreihe bei.

Geh auf:

## COMMENTEZ ET GAGNEZ

Vos commentaires nous aideront à concevoir les futurs produits de cette gamme.

Rendez-vous sur :

## COMENTA Y GANA

Tu opinión nos ayudará a dar forma al desarrollo de esta serie de productos en el futuro.

Visita:

## 反馈有奖

您的反馈将有助于我们在今后改进本系列产品。

请访问：

[LEGO.com/productfeedback](https://www.lego.com/productfeedback)

By completing, you will automatically enter a drawing to win a LEGO® set.

Terms & Conditions apply.

Durch Ausfüllen nimmst du automatisch an der Verlosung eines LEGO® Preises teil.

Es gelten die Teilnahmebedingungen.

En envoyant vos commentaires, vous serez automatiquement inscrit(e) à un tirage au sort qui vous permettra de remporter un prix LEGO®.

Offre soumise à conditions.

Al contestar, participarás automáticamente en el sorteo y podrás ganar un set LEGO®.

Sujeto a Términos y Condiciones.

完成我们的反馈调查，即可自动进入抽奖环节，赢取乐高® 套装。

适用《条款和条件》。

