

Operating instructions

Chest freezer

EN

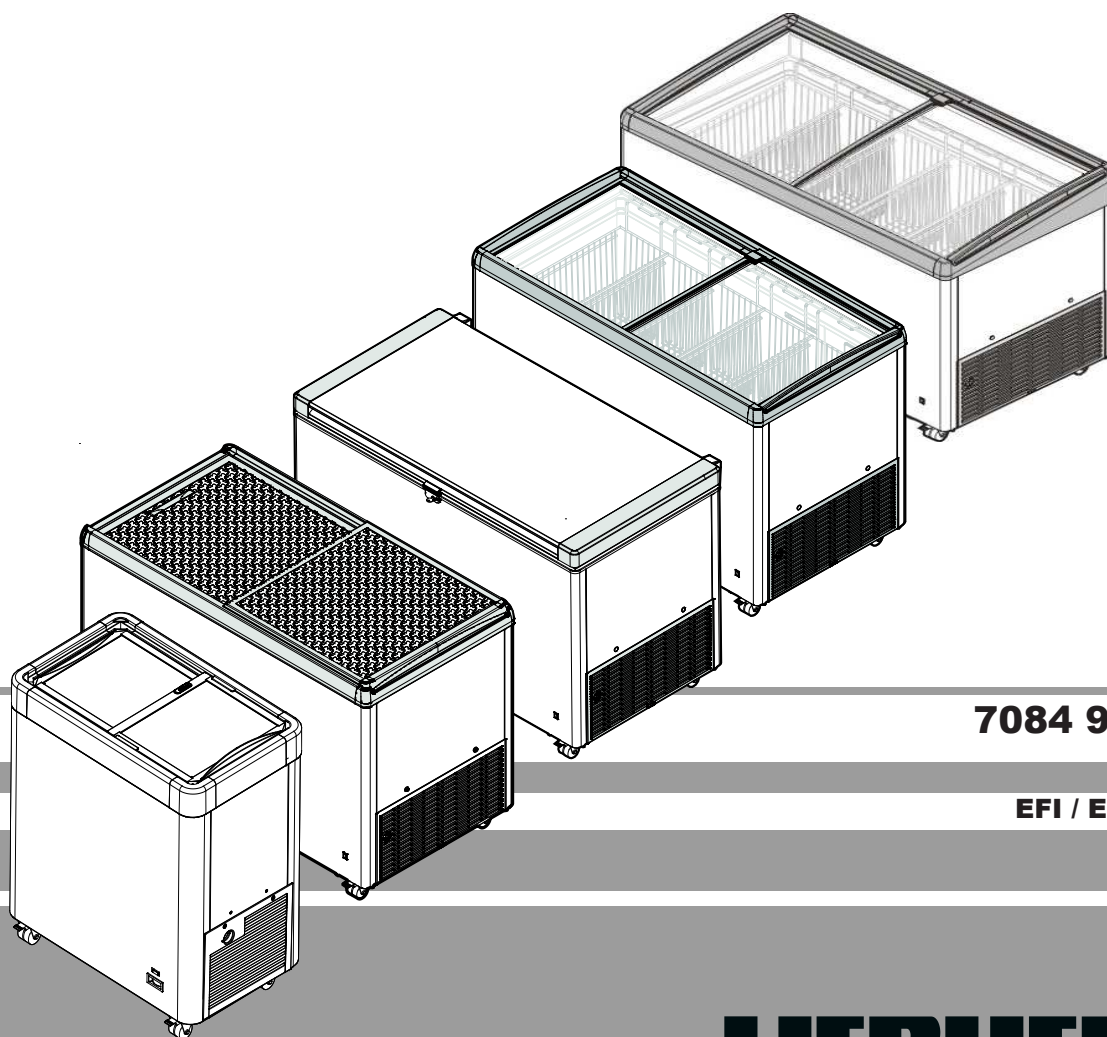

7084 921-01

EFI / EFE / EFL

LIEBHERR

Contents of these operating instructions

These operating instructions contain the important information required to operate and control the appliance.

The operating instructions contain the following sections:

- Description of the appliance
- Commissioning
- Operation
- Shutting down the appliance
- Malfunctions / Troubleshooting
- Defrosting
- Cleaning
- Technical Data
- Storing the appliance after shutting down
- Disposal
- Declaration of conformity

Read the operating instructions in full and do not use the product until you have understood the operating instructions.

Structure of the operating instructions

Warnings

Warnings have the following structure:

 SIGNAL WORD!	Source of the danger. Consequences of non-compliance.
	▶ Action to take to prevent the danger.

Priority of warnings

The warnings differ depending on the type of danger as follows:

 DANGER!	Identifies a situation involving direct danger which, if not obviated, may result in death or severe bodily injury.
--	---

 WARNING!	Identifies a dangerous situation which, if not obviated, may result in death or severe bodily injury.
---	---

 CAUTION!	Identifies a dangerous situation which, if not obviated, may result in minor or medium bodily injury.
---	---

NOTICE	identifies a dangerous situation which, if not removed, may result in damage to property.
---------------	---

	Identifies dangerous flammable substances.
---	--

Hints, notes and recommendations

- ① Provides the user with hints, notes or recommendations for using the product efficiently

Other symbols

Instructions to take action require the user to complete an action or a procedure. Always complete the instructions individually and in the sequence shown.

Structure of the instructions:

- ➡ Instruction for an action.

Details of results if required.

Other applicable documents

Also refer to the additional documents supplied (e.g. delivery documents) and relevant standards and laws to ensure that you use the appliance safely and correctly.

Archiving

Keep the operating instructions, including the other documents supplied, at hand near the appliance.

Intended use

This appliance may be used for displaying packed food, for retail sale. Commercial use means for example their use in restaurants, canteens, hospitals and in commercial establishments such as bakeries, butchers, supermarkets, etc.

Foreseeable misuse:

Do not use the appliance for the following applications:

- Storage and cooling of :
 - Chemically unstable, combustible or corrosive substances.
 - Medicines, blood plasma, laboratory preparations or similar substances and products based on Directive 2007/47/EC on medical devices.
- Use in hazardous areas.
- Use outdoors or in damp and splashing water areas.

Improper use of the appliance leads to damage or spoilage of the stored goods.

The cabinet is intended to store and to display pre-frozen and pre-packed ice-cream as well as packed foodstuff. Access by the customer is achieved by opening a non-transparent or transparent lid from the top.

Do not store explosive substances in the device, such as aerosol containers with flammable propellant gas.

Safety instructions

Dangers for the user

- Keep the operating instructions at hand near the appliance.
- Pass the operating instructions on to any subsequent owner.
- To prevent injury and damage to property, the appliance should only be installed by two people.
- After unpacking it, check the appliance for signs of damage.
- Contact the supplier if it is damaged. Do not connect the appliance to the mains power supply.
- Avoid prolonged skin contact with cold surfaces (e.g. chilled/frozen products). If necessary, take safety precautions (e.g. gloves).
- Do not use the appliance in potentially explosive atmospheres.
- Do not allow any naked flames or other ignition sources to enter the appliance.
- Do not use electric heaters or steam cleaners, naked flames or defrost sprays to defrost the appliance.
- Do not remove ice with sharp objects.
- **WARNING:** Do not damage the refrigerant circuit.
- If the cooling circuit is damaged, ventilate the room well and keep ignition sources away from the appliance.
- Do not eat ice cream, particularly ice lollies or ice cubes, immediately after taking them from the appliance as there is a risk of "burning" because of the very cold temperatures.
- **WARNING:** The appliance contains flammable materials and should be handled, serviced and disposed properly.
- **WARNING:** Do not use mechanical devices or other means to accelerate the defrosting processes, other than those recommended by the manufacturer.



Incorrect handling of flammable refrigerants

- Ensure that the refrigerant circuit pipes will not be damaged.
- Do not allow naked flames or ignition sources to enter the appliance.
- Do not use electrical devices inside the appliance (e.g. ice cream makers, etc.).

If refrigerant escapes:

- Keep naked flames and ignition sources away from the leak area.
- Ventilate the room well.
- Notify the customer service department.

Incorrect installation and repair work

- Only carry out repair and other work on the appliance when the mains plug has visibly been disconnected.
- All repairs and work on the appliance may only be carried out by customer service personnel or other trained personnel.

- **WARNING:** If the supply cord is damaged, it must be replaced by the manufacturer, its service agent or similarly qualified persons in order to avoid a hazard.
- Only install, connect and dispose of the appliance as described in these operating instructions.

Non-intended use

- **WARNING:** Keep clear of obstruction all ventilation openings in the appliance enclosure or in the structure for building-in.
- When disconnecting the appliance from the mains, pull on the plug, not on the cable.
- In the event of a fault, pull out the plug or switch off the fuse.
- Ensure that food which has been stored for too long is not consumed. Dispose of food which has been stored for too long properly.
- **WARNING:** Do not store explosive substances such as aerosol cans with flammable propellant in this appliance.
- Check that spray cans do not contain flammable propellants before storing them in the appliance. Flammable propellants are listed in the contents or indicated by a flame symbol printed on the container.
- Do not use the interior LED light to light the room. The interior LED light is only designed to illuminate the interior of the appliance.
- **WARNING:** Do not use electrical appliances inside the food storage compartments of the appliance, unless they are of the type recommended by the manufacturer.
- If you have a lockable appliance, do not keep the key near the appliance or within reach of children.
- This appliance can be used by children aged from 8 years and above and persons with reduced physical, sensory or mental capabilities or lack of experience and knowledge if they have been given supervision or instruction concerning use of the appliance in a safe way and understand the hazards involved.
- Children shall not play with the appliance.
- Cleaning and user maintenance shall not be made by children without supervision.



Incorrect storage of flammable substances.

- Do not store explosive substances or spray cans with flammable propellants (propane, butane, pentane, etc.) in the appliance. There is a danger that any leaking gases may be ignited by electrical components.
- Check that spray cans do not contain flammable propellants before storing them in the appliance. Flammable propellants are listed in the contents or indicated by a flame symbol printed on the container.
- Alcoholic drinks or other vessels containing alcohol should be sealed tightly for storage.

Description of the appliance

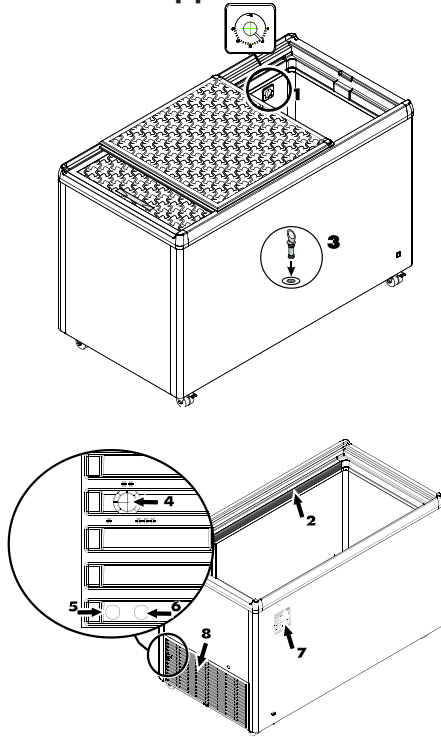

1. Temperature display
2. Interior light (depending on model and options)
3. Defrost water drain
4. Temperature control
5. Interior light ON switch...(Optional)
6. Interior light OFF switch...(Optional)
7. Type/Data plate
8. Compressor compartment ventilation grille

Appliance dimensions

Model	A	B	C	D
EFE 1102 / 1152	825	751	461	-
EFE 1502 / 1552	825	625	660	-
EFE 1500	825	625	660	-
EFE 2200	825	835	660	-
EFE 2202 / 2252	825	835	660	-
EFE 3002 / 3052	825	1045	660	-
EFE 3000	825	1045	660	-
EFE 3802 / 3852	825	1255	660	-
EFE 3800	825	1255	660	-
EFE 4600	825	1465	660	-
EFE 4602 / 4652	825	1465	660	-
EFE 5100	825	1675	660	-
EFE 5102 / 5152	825	1675	660	-
EFE 6002 / 6052	825	1885	660	-
EFI 1403 / 1453	825	625	660	751
EFI 2103 / 2153	825	835	660	751
EFI 2803 / 2853	825	1045	660	751
EFI 3503 / 3553	825	1255	660	751
EFI 4403 / 4453	825	1465	660	751
EFI 4803 / 4853	825	1681	660	751
EFI 5603 / 5653	825	1885	660	751

Appliance dimensions

Model	A	B	C	D
EFL 1505	825	625	660	-
EFL 3005	825	1045	660	-
EFL 3805	825	1255	660	-
EFL 4605	825	1465	660	-
EFL 6005	825	1885	660	-

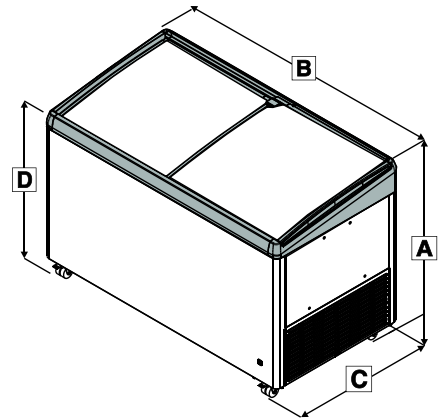

Accessories

① A cylinder lock is available to protect the appliance from unauthorised access.

To install the cylinder lock:

- ➡ On versions with a lock hole cover: slide the lock hole cover until the opening for the cylinder lock is exposed.
- ➡ Insert the cylinder lock into the exposed opening.
- ➡ Turn the key.
- ➡ Remove the key.

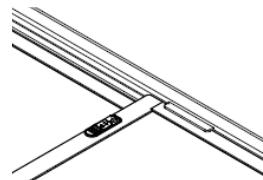

Lock for EFL

The lock is equipped with a safety mechanism.

Locking the appliance:

1. Press the button and keep it depressed.
2. Turn the key 90°.

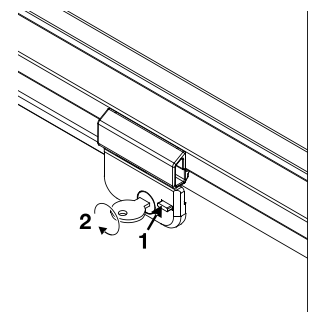

Baskets

Baskets are available as accessories.

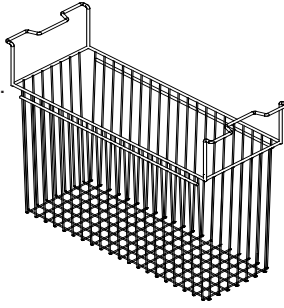

NOTICE	Excessive load! Damage to property.
---------------	---

Model	Basket	Max load
EFE 11	195 mm	12 kg
EFE	210 mm	28 kg
	270 mm	31 kg
EFI	210 mm	28 kg
	270 mm	25 kg
EFL	210 mm	47 kg
	270 mm	54 kg

Commissioning

Unpacking

! DANGER!	Packaging material and film. Danger of asphyxiation.
	▶ Do not allow children to play with the packaging material.

- Please take packaging to an official collection point.
- Clean the interior of the appliance before switching it on for the first time, see "Cleaning".

Installing the appliance

! DANGER!	Unsuitable ratio of refrigerant to installation room volume. Risk of explosion.
	▶ Ensure that the room which you install your appliance has a volume of 1 m ³ per 8 g of R600a/R290 refrigerant used in the appliance as set out in standard EN 378.

Requirements for the place of installation:

- Check that the volume of the installation room is large enough relative to the appliance's refrigerant capacity.
- ① The refrigerant capacity is shown on the type plate.
- No direct sunlight.
- No heat sources such as a stove or heater in the vicinity.
- The floor is horizontal and flat.

① The ventilation clearance between the edge of the chest and the floor is used to supply the refrigeration unit with cooling air.

➤ Ensure that the ventilation clearance between the underside of the chest and floor is not blocked.

➤ Ensure the distance between the ventilation grille and wall is at least 50 mm.

➤ Ensure that the area between the ventilation grille and wall is not obstructed.

➤ Ensure that the ventilation grille is clear of dirt and foreign bodies.

① The appliance dissipates air through its exterior skin.

➤ Do not place objects right next to the exterior skin of the appliance.

➤ Ensure that the distance between the exterior skin of the appliance and neighbouring items is at least 20 mm.

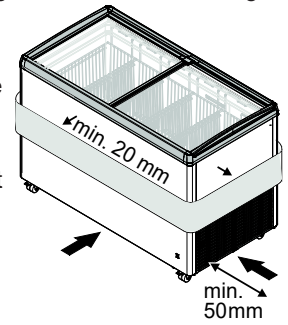

Electrical connection

! DANGER!	Incorrect voltage supply. Damage to property or personal injury.
	▶ Ensure that the voltage supply complies with the specifications in the section entitled "Technical data".

➤ Ensure that the socket is not covered by the appliance and is easily accessible.

➤ Power supply (AC) and voltage at the operating point must comply with the details on the type plate. The type plate is located on the rear of the appliance.

➤ Only connect the appliance to a socket protected by a fuse which has been earthed in accordance with the appropriate regulations.

➤ The socket must be fused with a 10 A fuse or higher, it must be away from the rear of the appliance and must be easily accessible.

➤ Do not connect the appliance using extension cables or extension sockets.

Connect the appliance with a properly earthed fused plug and socket only.

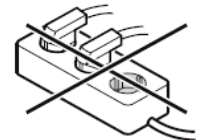

Switching the appliance on and off

It is recommended that you clean the appliance before switching it on for the first time (see "Cleaning").

To switch the appliance on:

Connect the appliance to the mains - the appliance is switched on.

The green ON lamp (arrow) comes on. (optional features by executions)

Set the required temperature, see "setting the temperature"

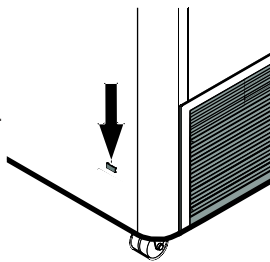

To switch the appliance off:

Pull out the mains plug or remove/unscrew the fuse.

Operation

NOTICE	Incorrect room temperature. Damage to property and reduced cooling capacity.
	▶ Ensure that the room temperature corresponds to the climate rating of the appliance, see "Technical data".

Operation

Switching the interior light on and off (optional features by executions)

! WARNING!	High light intensity. Eye injury.
	▶ Do not remove the light cover. ▶ Do not look into the light through optical lenses.

① The light intensity of the interior LED light corresponds to laser class 1/1M.

① The switch for the interior light is located behind the compressor compartment ventilation grille.

➡ Press the switch through the left opening to switch the interior light on.

➡ Press the switch through the right opening to switch the interior light off.

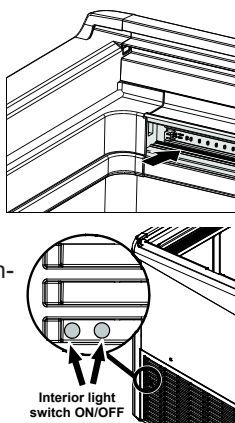

Maximum filling height

The stacking mark in the interior of the appliance indicates the maximum filling height.

➡ Do not fill the appliance with frozen items beyond the stacking mark



Setting the temperature

The temperature can be infinitely adjusted using the control knob. There are markings near the control knob. The appliance will achieve its lowest temperature when set to 3 (***) .

➡ To set the temperature, turn the control knob to required setting (* to ***) using a flat-blade screwdriver.

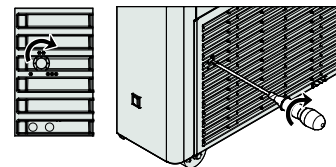
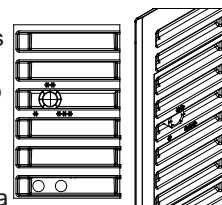

Temperature display

The thermometer shows the warmest temperature of the frozen volume at the maximum filling height.

It is adjusted and designed so that only temperatures below 0°C are accurately displayed.

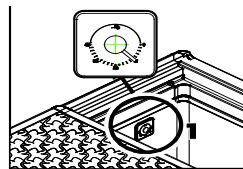

Internal type

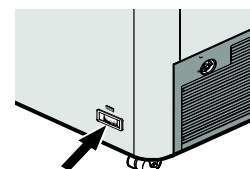

External type

Shutting down the appliance

Switching the appliance off

➡ Pull out the mains plug or turn the temperature control knob anti-clockwise until it locks in the Off position.

① If it is switched off using the temperature control knob, the appliance is not disconnected from the mains supply.

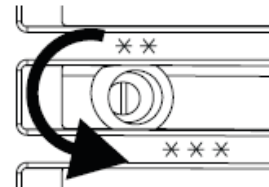

Before shutting down the appliance for a lengthy period

➡ Switch off the appliance.

➡ Pull out the plug or switch off the fuse.

➡ Clean the appliance.

➡ Ensure that the appliance is dry inside and outside.

① **There must be no moisture in the interior container.**

① If the chest lid is closed when the appliance remains shut down for a lengthy period, odours will form inside it.

➡ Open the chest lid and secure it to prevent it being closed.

➡ Ensure that the ambient conditions for storage comply with the specifications in the section entitled "Storing the appliance after shutting down".

Malfunctions/Troubleshooting

- ① Contact your nearest customer service department if the appliance suffers faults which you cannot rectify.
- ① To ensure that your query can be dealt with quickly, make a note of the type designation 1, service number 2 and serial number 3 on the type plate and quote them when you contact the customer service department. The position of the type plate is shown in the section entitled “Description of the appliance”.

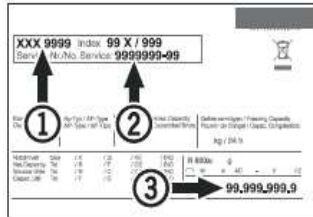

Malfunction	Possible cause	Remedy
Appliance does not cool down.	The temperature control knob is in the Off position.	Set the temperature control knob to a cooling position.
	The mains plug has been disconnected.	Connect the appliance to the mains.
	The power supply has been interrupted.	Check the power supply. Check the fuses in the power supply.
The temperature is not low enough.	Incorrect temperature set.	Set the correct temperature.
	The thermometer display is incorrect.	Check the temperature with an additional thermometer.
	Ventilation is inadequate.	Ensure that there is adequate ventilation.
The appliance is located too close to a heat source.		Remove the heat source. Choose a suitable place of installation.

Defrosting

After a long period of operation, a layer of frost or ice can build up on the walls of the freezer compartment.

The layer of frost or ice will form more quickly if the appliance is opened frequently. A thick layer of ice increase energy consumption. You should therefore defrost the freezer regularly.

CAUTION!	High light intensity. Eye injury.
	<ul style="list-style-type: none"> ▶ Do not use electric heaters or steam cleaners, naked flames or defrosting sprays. ▶ Do not remove ice with sharp objects. (Risk of damage to the interior walls)

Defrosting

- ➡ Switch off the appliance.
- ➡ Pull out the plug or switch off the fuse.
- ➡ Wrap the frozen goods in paper or blankets and store in a cool place.
- ① Mop up defrost water with a sponge or cloth in appliances without a drain opening.
- ➡ Place a suitable vessel under the drain opening to collect defrost water.
- ➡ Remove the defrost water plug from the drain opening.
- ➡ Leave the lid open while defrosting.
- ➡ Mop up the remaining defrost water with a cloth after defrosting.
- ➡ Clean the appliance, see “Cleaning”.

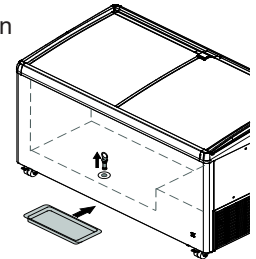

Cleaning

⚠ DANGER! Risk of electric shock if an incorrect cleaning method is used.
 Danger of death.
 ▶ Pull out the mains plug before starting the cleaning work.

⚠ CAUTION! Hot steam. Injuries and damage to property.
 ▶ Do not use steam/high-pressure cleaning equipment.

NOTICE Unsuitable cleaning products. Damage to the appliance.
 ▶ Do not use concentrated cleaning products without diluting them.
 ▶ Only use soft cloths and an all-purpose cleaner with neutral pH value.
 ▶ Only use food-compatible cleaning and care products on the inside of the appliance.

- ① Clean the appliance every 6 months.

- ➡ Remove all the frozen items.
- ➡ Place a suitable vessel under the drain opening.
- ➡ Remove the defrost water plug from the drain opening.
- ➡ Ensure that no water flows into the ventilation grille or electrical components during cleaning.
- ➡ Clean the interior container, outer walls and equipment parts of the appliance using suitable cloths and a mixture of lukewarm water and all-purpose cleaner.
- ➡ Dry the appliance with a suitable cloth.

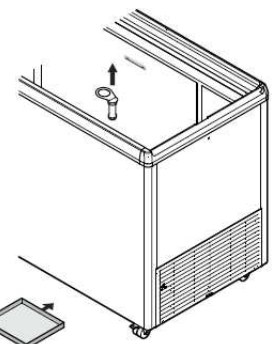

- ① **There must be no moisture in the interior container.**
- ① Dust deposits on the ventilation grille cause increased power consumption.
- ➡ Remove dust deposits from the ventilation grille.

Technical data

Voltage supply

① The precise values for the correct voltage supply are shown on the type plate.

Specification	Value
Type of current	Alternating current
Fuse trip current	Between 10 and 16 A

Noise emissions from the appliance

The noise level while the appliance is operating is below 70 dB(A) (relative noise level 1 pW).

Climate rating

The climate class [X] specifies the ambient conditions in which the appliance can be operated safely.



The climate class [Y] and temperature class [Z] define the maximum outline conditions in which the appliances will operate perfectly.

Class (X)	Min. temperature & relative humidity	Max temperature & relative humidity
3	25 °C	60 %
4	30 °C	55 %
5	40 °C	40 %
7	35 °C	75 %

The minimum room temperature at the place of installation is 10°C.

[Y] Climate class	Minimum temperature and relative humidity	Maximum temperature and relative humidity
A	+16°C, 80%	30°C, 55%
B	+16°C, 80%	35°C, 75%
C	+16°C, 80%	40°C, 40%

Recommended temperature setting:

[Z] Temperature class	Temperature setting [°C]
C1	-18.0
C2	-7.0

Storing the appliance after shutting down

NOTICE	Unsuitable room temperature during storage. Damage to property.
	▶ Ensure that the room temperature is between -10 °C and +50 °C.

- ➡ Ensure that the appliance is dry inside and outside.
- ① **There must be no moisture in the interior container.**
- ➡ Ensure that the room temperature is between -10 °C and +50 °C.

Disposal

NOTICE	Escaping refrigerant and oil. Damage to the environment.
	▶ Ensure that the refrigerant circuit is not damaged during the disposal process.

- ① The appliance contains recyclable materials and flammable materials.
- ➡ Disconnect the appliance from the power supply.
- ➡ Cut through the mains power cable to render the appliance unusable.
- ➡ Do not simply dispose of the appliance properly with unsorted household refuse.
- ➡ Ensure that the appliance is disposed of in a professional and appropriate way, in accordance with the current local regulations and laws.

Declaration of Conformity

The appliance complies with the relevant safety regulations and EU Directives 2014/30/EU and 2006/42/EC.

Additional information

- Food will remain fresh for longer if stored at the correct temperature. This can prevent having to discard food needlessly.
- If the condenser coil is not cleaned every year, it will significantly reduce the appliance's efficiency.
- The period during which spare parts, necessary for the repair of the refrigerating appliance with a direct sales function, are available is 10 years.
- The minimum duration of the guarantee of the refrigerating appliance with a direct sales function offered by the manufacturer, importer or authorised representative is 2 years.
- EPREL database:
As from 1 March 2021, information about energy labelling and ecodesign requirements will be available in the European product database (EPREL). You can access the product database using the following link: <https://eprel.ec.europa.eu/>. You will be asked to enter the model identifier. You will find the model identifier on the type plate.

Liebherr Appliances Kluang Sdn Bhd

No.7 Jln Firma 2 , Kaw.Perind.Kluang II, KM7, Jln Mersing, 86007 Kluang, Johor, West Malaysia.
www.liebherr.com.my