

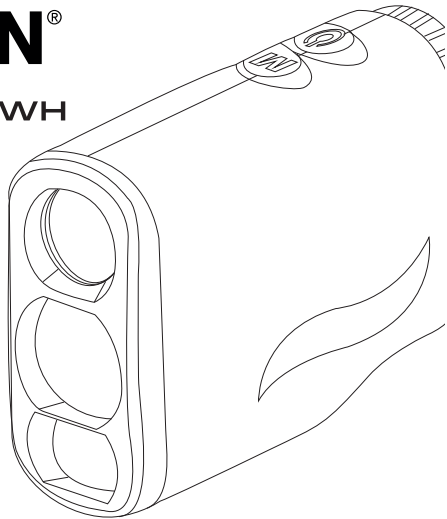

RangeFinder 1000WH

Laser-Entfernungsmesser

Bedienungsanleitung
Deutsch





- 21 mm Objektivdurchmesser
- 6-fache Vergrößerung
- 7,2° Sichtwinkel
- 16 mm Pupillenabstand
- Genauigkeit +/-1 m
- Maximale Reichweite: 1000 m
- Kürzeste Entfernung: 4 m
- Geschwindigkeitsbereich: 0 - 300 km/h

- 3 V Batterie (CR2)

- Spritzwassergeschützt

- Abmessungen: L: 97 mm (ohne Okular) / 106 mm (mit Okular)
B: 35 mm
H: 73 mm (vorne) / 68 mm (hinten)

- Gewicht: 152 g (inkl. Batterie)

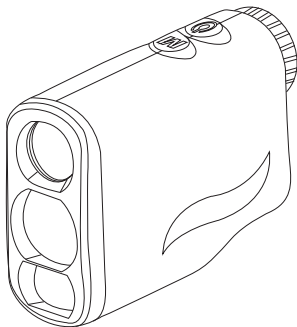

1. Startbildschirm

Drücken Sie  zum Einschalten.
Standardmodus ist „Entfernungsmessung“.

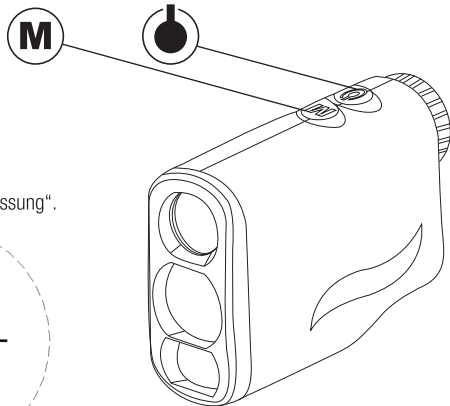
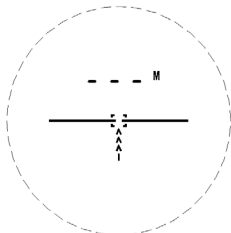

2. Einheitenumwandlung/Modusauswahl

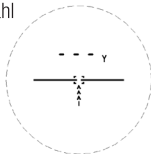

Halten Sie **M** zum Umschalten der Einheit zwischen M (Meter) und Y (Yard) gedrückt.

Drücken Sie **M** zum Umschalten zwischen den Betriebsmodi Entfernungsmessung, Flaggenstock halten, Golf-Entfernungskorrektur, Nebel, Horizontale Entfernungsmessung, Vertikale Höhenmessung und Geschwindigkeit.

Im Geschwindigkeitsmodus muss die Einheit des Messwertes separat konvertiert werden.

3. Alarm „Batterie schwach“



Wenn die Batteriespannung zu niedrig ist, wird das entsprechende Symbol zur Erinnerung angezeigt.

Batterie austauschen:

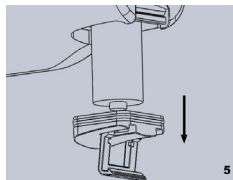
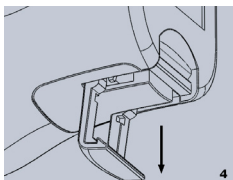
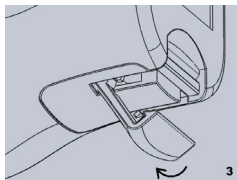
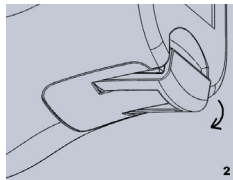
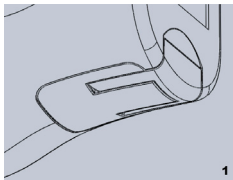

4.1 Entfernungsmessungs-Modus Funktionsprinzip:

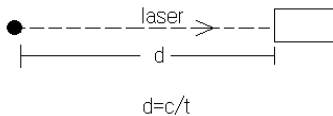
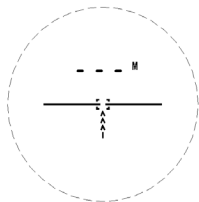

Drücken Sie , um die Entfernungsmessung zu starten.

Entfernungsmessungs-Bildschirm:

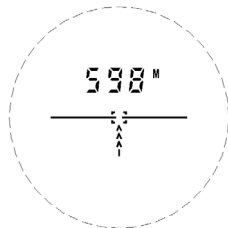

4.2 Scanmodus

Funktionsprinzip:

Im Scanmodus misst der Laser kontinuierlich und jede gemessene Entfernung wird nacheinander angezeigt.

Im Entfernungsmessungsmodus halten Sie  zur Aktivierung des Scanmodus gedrückt.

Der Modus wird automatisch nach 20 aufeinanderfolgenden Entfernungsmessungen verlassen.

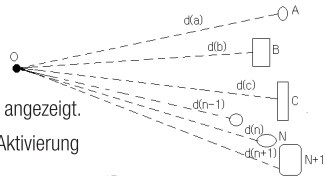

4.3 Flaggenstock-Modus:

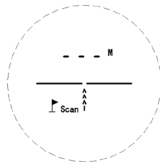

Funktionsprinzip:

Im Flaggenstock-Scanmodus kann Punkt D von einer Reihe von Punkten im Hintergrund abgeschirmt gemessen werden.

Nur die Entfernung d_1 wird gehalten, um die Entfernung zum Flaggenstock automatisch zu erhalten.

Die anderen Ziele werden hinter dem Flaggenstock abgeschirmt.

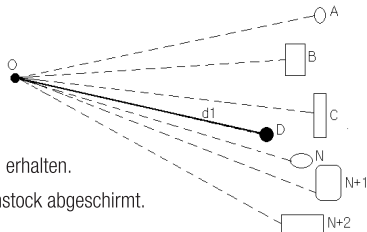

Bildschirm Flaggenstock-Modus:

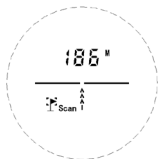

Wenn der Flaggenstock-Scanmodus angezeigt wird, halten Sie  zum Start der Flaggenstock-Scanfunktion gedrückt, das Flaggensymbol blinkt.

Richten Sie den Zielpunkt zunächst auf die zu messende Flagge und bewegen Sie diesen rechts/links, bis das Flaggensymbol nicht mehr blinkt. Die Entfernung ist nun aufgezeichnet.

4.4 Golf-Entfernungskorrektur-Modus:

Funktionsprinzip:

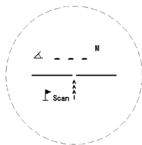

In der gemessenen Entfernung AB wird der Gefällewert in die Gleichung des Golfballfluges eingebracht.

Das Gefälle ist positiv: weite Abschläge.

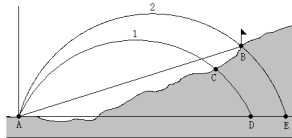

- 1: Nicht korrigierte Flugbahn
- 2: Tatsächliche Entfernung der Flugbahn / Punkt B ist die Position der Flagge

Das Gefälle ist negativ, die Entfernung für den Abschlag ist kürzer.

- 1: Tatsächliche Entfernung der Flugbahn
 - 2: Nicht korrigierte Flugbahn
- Punkt B ist die Position der Flagge

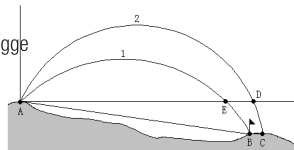

Drücken Sie , um die Flaggenstock-Entfernungsmessung zu starten. Nach der Entfernungsmessung des Flaggenstocks und des Gefälles kann die Flugbahn berechnet werden. Entfernung und Gefälle werden angezeigt.

Das berechnete Ergebnis wird angezeigt:

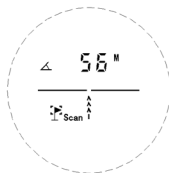

Der Gefällewert wird angezeigt:

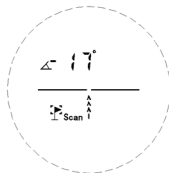

4.5 Nebelmodus

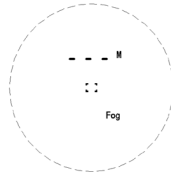

Funktionsprinzip:

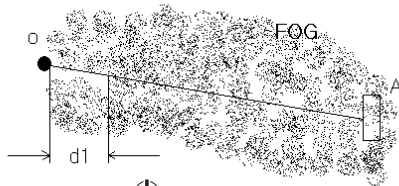

Der Nebelbildschirm wird angezeigt; drücken Sie  zur Entfernungsmessung.
Der Nebelmodus verarbeitet die Störung, die durch den Nebel verursacht wird.

Nebelbildschirm:



4.6 Horizontaler Entfernungsmessungsmodus:

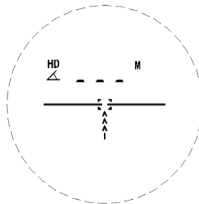

Funktionsprinzip:

Entfernung messen: AC oder AB
 Horizontale Entfernung: AD

Drücken Sie  , um die Entfernung- und Gefällemessung zu starten. Nach dem Erhalt der Messergebnisse werden die horizontale Entfernung und das Gefälle angezeigt.

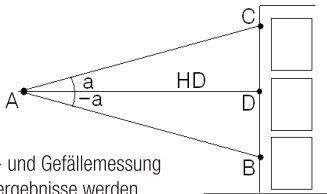

Horizontale Entfernung:

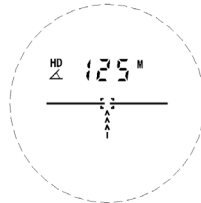

Gefälle:

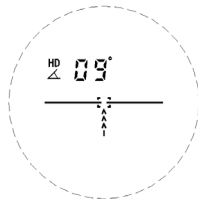

4.7 Vertikaler Höhenmessungsmodus:

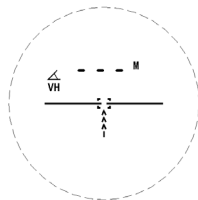

Funktionsprinzip:

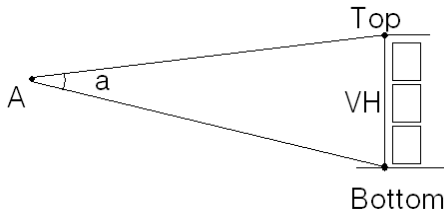

Mit der gemessenen Entfernung zwischen zwei Punkten (oben und unten) in vertikaler Richtung und dem Winkel (a) zwischen den beiden Punkten wird die vertikale Höhe VH berechnet.

Wenn Sie mit dem untersten Punkt des zu messenden Objekts ausgerichtet haben, halten Sie  gedrückt.

Im Bildschirm wird „Scan“ und „Bottom“ angezeigt und die Entfernung zum untersten Punkt des Objekts wird gestartet.

Nach der Entfernungsmessung unten wird „Scan“ und „Top“ angezeigt, Jetzt wird die Entfernung nach oben „Top“ gemessen und die Höhe wird angezeigt.

Unten gefunden:

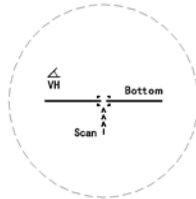

Oben und Höhe gefunden:

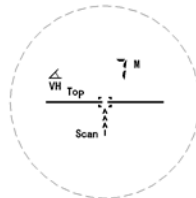

4.8 Geschwindigkeitsmodus:

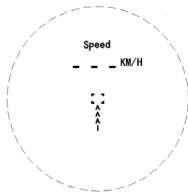

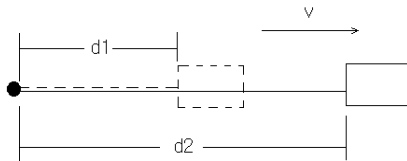

Funktionsprinzip:

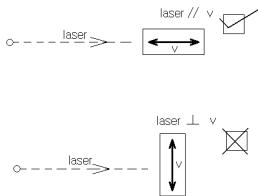

$$v = (d_2 - d_1) / t$$

Methode



Im Geschwindigkeitsmodus halten Sie **M** zum Umschalten zwischen km/h und mph gedrückt.
Drücken Sie , um die Geschwindigkeitsmessung zu starten.

Einheit Kilometer: Kilometer / Stunde

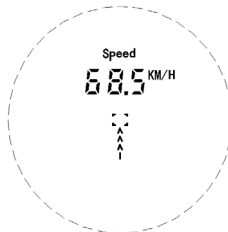

Einheit Meilen: Meilen / Stunde

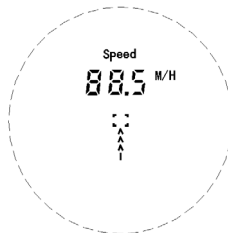

Funktionen benutzerdefiniert aktivieren/deaktivieren:

1. Vergewissern Sie sich, dass das Gerät ausgeschaltet ist.
2. Halten Sie erst **M** und dann  gedrückt, um das Gerät einzuschalten;
im Display wird „FUN“ angezeigt.



3. Drücken Sie mehrmals **M**, bis der Ein-/Ausstatus für die 1. Funktion angezeigt wird:

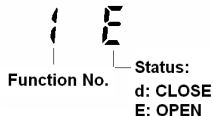



1 E

Function No. Status:
d: CLOSE
E: OPEN

Funktionsnummern:

- 1) Flaggenstock halten
- 2) Golf-Entfernungskorrektur
- 3) Nebel
- 5) Horizontale Entfernungsmessung
- 6) Vertikale Höhenmessung
- 8) Geschwindigkeit

4. Lassen Sie die Tasten los ( musste gedrückt gehalten werden).
5. Drücken Sie  zum Umschalten der Funktion: (d = AUS, E = EIN).
6. Drücken Sie **M** zur Auswahl der nächsten Funktion.
7. Halten Sie  zum Verlassen der Funktion und zum Ausschalten gedrückt.

Artikel-Nr. 20176

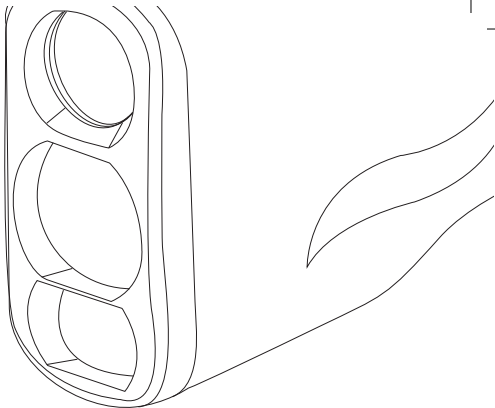

BRAUN Photo Technik GmbH
Merkurstraße 8
72184 Eutingen/Germany
www.braun-phototechnik.de

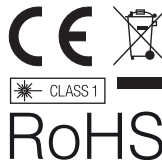



RangeFinder 1000WH

Laser Rangefinder

User's Manual
English

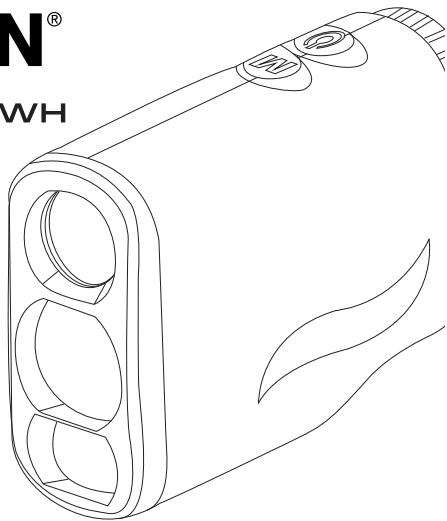



- 21 mm Objective Lens
- 6x Magnification Power
- 7,2° View Angle
- 16 mm Pupil Distance
- Precision to +/-1 m
- Maximum Range: 1000 m
- Closest distance: 4 m
- Speed range: 0 - 300 km/h

- 3 V Battery (CR2)

- Splash proof

- Size: L: 97 mm (without eyepiece) / 106 mm (with eyepiece)
W: 35 mm
H: 73 mm (front) / 68 mm (rear)

- Weight: 152 g (including battery)

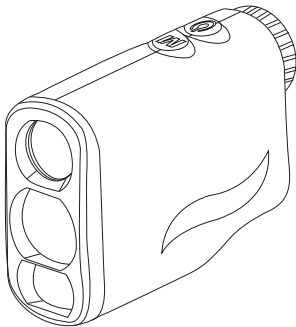

1. The boot screen

Press  to boot.

Boot default mode is "ranging".

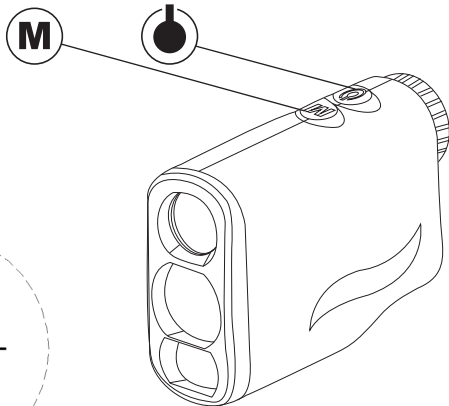
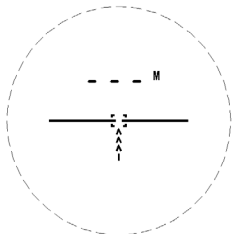

2. Unit conversion

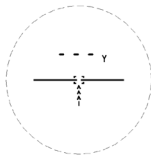

Long press **M** button to switch the unit of distance, M and Y.

Ranging, Flagpole lock, Golf distance correction, Fog, Horizontal distance measurement, Vertical height measurement and Speed modes, you can long press **M** button to switch M/Y unit, the unit switches will be used in seven modes unified.

In the „speed“ mode, the unit of the measured value needs to be converted separately.

3. Low voltage alarm



When the product's battery voltage is too low, the low battery icon is shown to remind to replace the battery.

Battery Replacement:

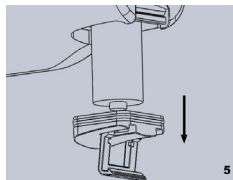
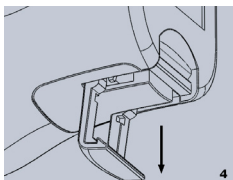
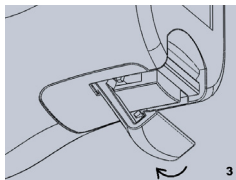
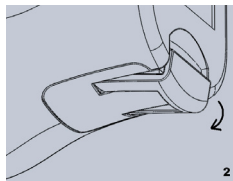
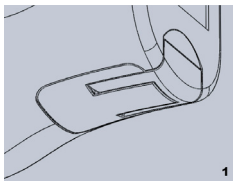

4.1 Ranging mode

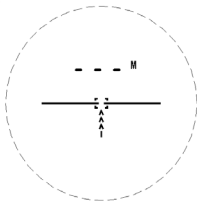

Ranging screen:

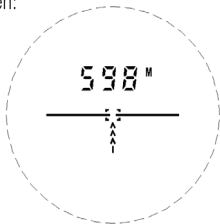

Principle:

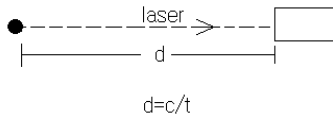
Press  key to start ranging.

4.2 Scan mode

Principle:

In scan mode, the laser will measure continuously.
Each measured distance will be displayed one by one.

In Ranging mode, press and hold  key to activate the Scan mode.

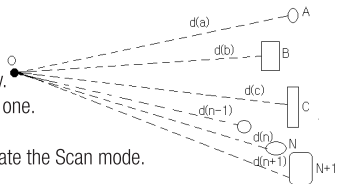

Automatically exit after 20 consecutive ranging.

4.2 Flagpole Lock mode

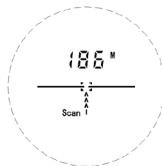
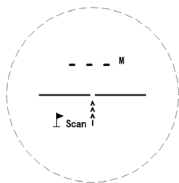

Principle:

In Flagpole Scan mode, point D may be isolated from a number of points in the background to measure only the distance $d1$.

Other objects around the flagpole will be ignored.

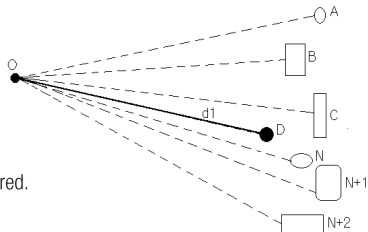

Flagpole Lock Screen:

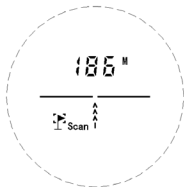

When the flagpole Scan mode screen appears, press and hold  key to start the the flagpole scan function, the flag symbol in the screen box around the icon flashes.

First aim at target flagpole, then move the aiming point left/right around the target until the icon stops flashing. The measurement is now complete.

4.3 Golf Distance Correction mode:

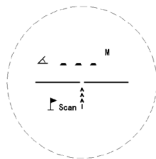

Principle: The measured distance values AB, the slope value is substituted into the equation in golf ball flight. Calculate the recommended distance.

Positive Slope = Long distance shots

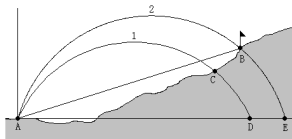

- 1: Uncorrected parabola batting
- 2: The actual distance the ball parabola Point B is the pole position

Negative Slope = Short distance shots

- 1: The actual distance the ball parabola
 - 2: Uncorrected parabola batting
- Point B is the pole position

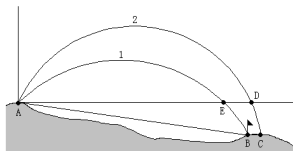

Press  key to start scanning flagpole ranging. After the flagpole's distance and slope is measured, the trajectory can be calculated.

The calculated result is displayed:

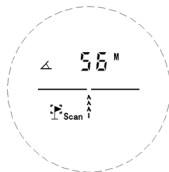

Slope value is displayed:

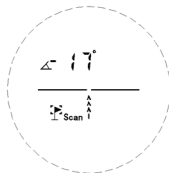

4.4 Fog Mode

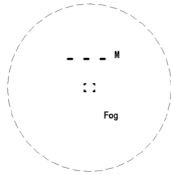

Principle:

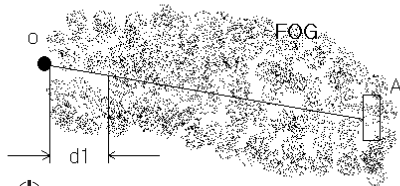

Fog mode screen appears, press  key ranging.

Fog mode can handle the interference caused by fog.

Fog screen:



4.5 Horizontal Distance Measurement mode:

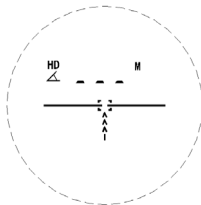

Principle:

Measure distance: AC or AB

Horizontal distance: AD

Press  key to start measuring the distance and slope.

After obtaining measurements, calculates and displays the horizontal distance and measuring slope.

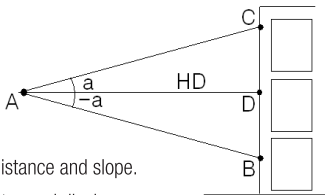

Horizontal distance:

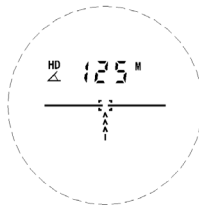

Slope:

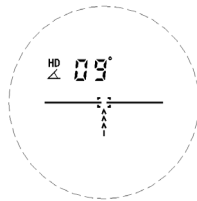

4.6 Vertical Height Measurement:

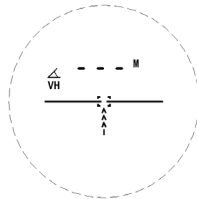

Principle:

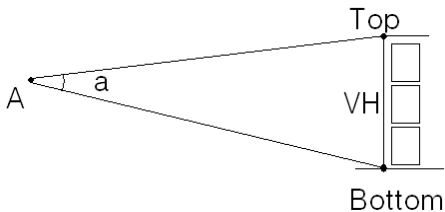

Measuring distance between two points (Bottom and Top) in the vertical direction, and the angle (a) between the two points, to calculate the vertical height between the two VH.

The aiming point is aligned at the bottom of the measured object, hold down the  key.

The screen displays „Scan / Bottom“ and starts measuring the distance to the object at the bottom.

After the bottom distance is measured, „Scan / Top“ will be displayed.

Now, „Top“ distance will be measured and the height will be displayed.

Found at the bottom:

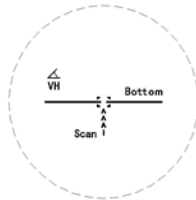

Found at the top and vertical height:

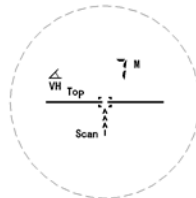

4.7 Speed mode:

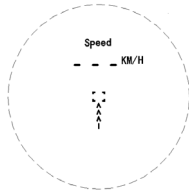

Principle:

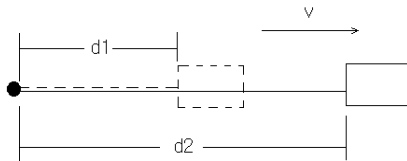

$$v = (d2 - d1) / t$$

Method:

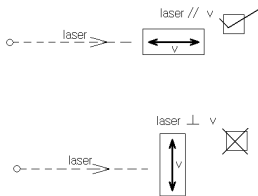

In speed mode, long press **M** button to switch KM / H and M / H.

Press  key to start the speed measurement.

Kilometers Unit screen: Kilometers / hour

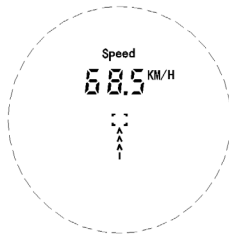

Miles unit screen: miles / hour

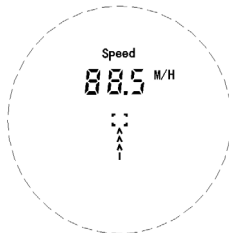

User-defined activation/deactivation of functions:

1. Make sure the machine is turned off.
2. Hold down the **M** button, then hold the  button, the device turns on, the display shows the word „FUN“.



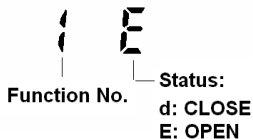

3. Press **M** key several times until the display shows the 1st function ON/OFF status:



1 E

Function No. Status:
d: CLOSE
E: OPEN

Function number:

- 1) Flagpole Lock
 - 2) Golf Distance Correction
 - 3) Fog
 - 5) Horizontal Distance Measurement
 - 6) Vertical Height Measurement
 - 8) Speed
-
4. Release all buttons (before this you must ensure that the  key has been pressed and hold).
 5. Press  key to switch function: (d = CLOSE, E = OPEN).
 6. Press **M** key to select the next function.
 7. After completion, hold the  key until device shuts down to save settings and exit menu.

Item no. 20176

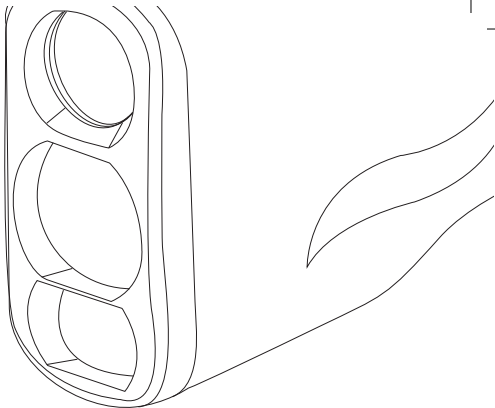

BRAUN Photo Technik GmbH
Mercurstraße 8
72184 Eutingen/Germany
www.braun-phototechnik.de

